

# Electronic Design

FOR ENGINEERS AND ENGINEERING MANAGERS

VOL. 22 NO.

1

JAN. 4, 1974

**Magnetics: easier to use** and a wider choice than ever before. Ferrites now have guaranteed performance specs, work more efficiently and operate at higher

frequencies and temperatures. Rare-earth "super" magnets—such as samarium-cobalt—are closing in on the old standby, Alnico. Check the magnetic field pg. 64.



**TOP TEN CONTEST!**  
Important You Enter  
See Page 230

# Technology Marketing Inc. asked us to prove our network capability.

## Now it's your turn.

Respected computer systems developers like Technology Marketing Incorporated are making good use of Dale's thick film network capabilities. The network above is used to set threshold voltage and provide termination for two sense windings in a P.C. layout compatible with 7500 Series memory sense amplifiers. It has been used effectively in high volume production memory and computer systems developed by Technology Marketing Inc. Standard or Special, Dale can provide the resistance function you need...in the quantities and at the price you require. Make us prove it.

### Models immediately available for these and many other standard functions:

- MOS/ROM pull-up/pull-down
- Open collector pull-up
- "Wired OR" pull-up
- Power driver pull-up
- High speed parallel pull-up
- TTL unused gate pull-up
- TTL input pull-down
- Digital pulse squaring
- Line termination
- Long line impedance balancing
- LED current limiting
- ECL output pull-down resistors
- TTL input

**Power Rating:** 1/8 watt max./resistor; 2 watts/package (single in-line); 1-1/2 watts/package (DIP).

**Resistance Range:** 10 ohms to 1 Meg., depending on tolerance.

**Tolerance:** 1%, 2%, 5%, 10%, 20%.

**T.C.:**  $\pm 200$  ppm/ $^{\circ}$  C.

**Packaging:** Flame retardant epoxy coating or sandwich-type ceramic construction.

Double width and discrete networks also available in standard or special designs.

*For complete information, call your Dale representative or phone 402-371-0080.*



DALE ELECTRONICS, INC., 1300 28th Avenue, Columbus, Nebraska 68601  
A subsidiary of The Lionel Corporation • In Canada: Dale Electronics Canada Ltd.

INFORMATION RETRIEVAL NUMBER 246

# SURPRISE!

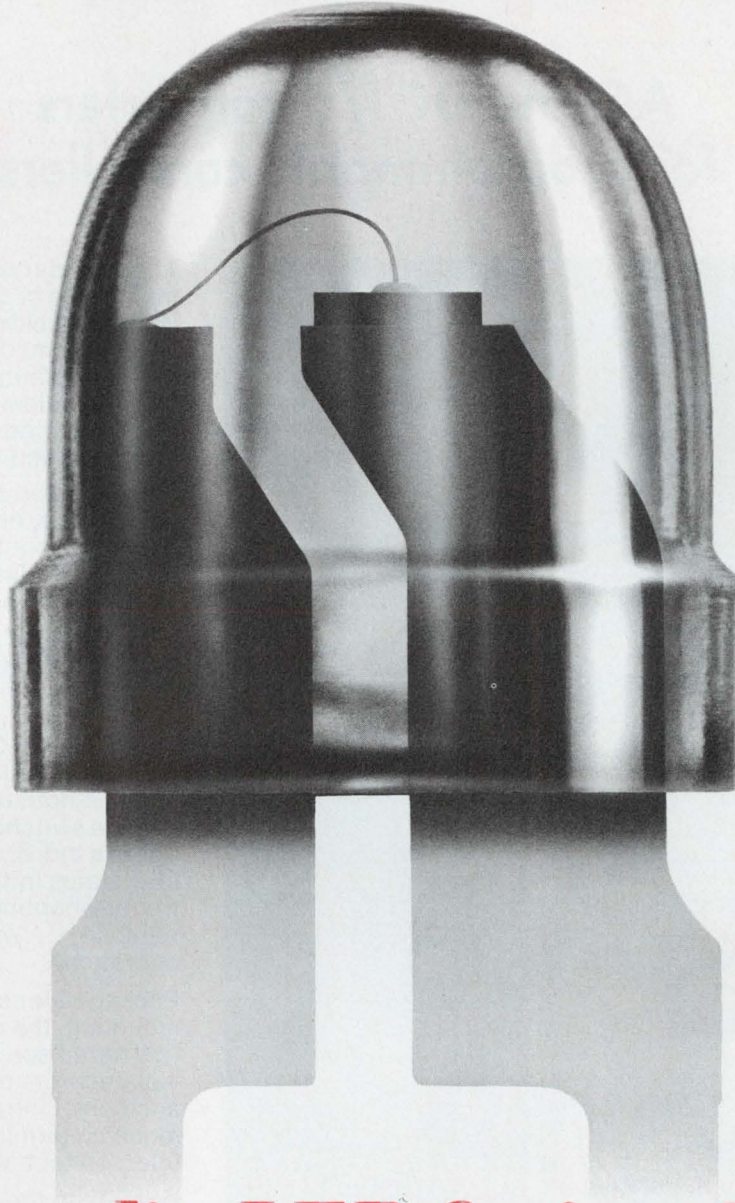

## A quality LED for just 9¢\*.

Now you can get HP quality in an LED lamp for only 9¢\*  
That's your price when you order one million. If you only need  
one thousand, the price is a low 17¢\*. And HP is ready to  
deliver that kind of volume to meet your schedule.

This T-1 size lamp features a new low profile lens for  
high density application in calculators, cameras, computers, appliances  
and automobiles. The 5082-4487 and 5082-4488 both  
have a clear lens and a 0.8 mcd at 20 mA typical light output.  
Get the full story from your nearby HP distributor  
or, write Hewlett-Packard directly.

01333

\*US Domestic only.

HEWLETT  PACKARD

Sales, service and support in 172 centers in 65 countries.  
Palo Alto, California 94304. Offices in principal cities throughout the U. S.

INFORMATION RETRIEVAL NUMBER 2

# Teledyne in solid control

## AC and DC I/O converters for programmable controllers

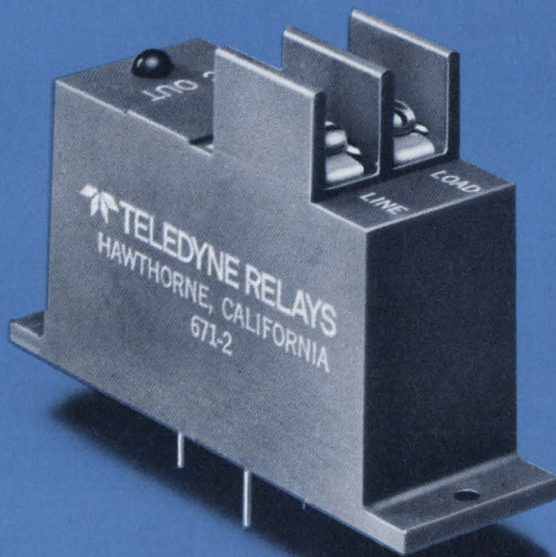

The boundary of the minicomputer mainframe or CPU world — of sensitive IC logic families — and the process control or machine tool world of motors, solenoids, lamps, and electro-mechanical switches is a tough place, demanding devices for fast quiet switching and load sensing — reliably.

Teledyne, the world's leader in solid state relays, offers the 671 series AC or DC input and output converter modules — state of the art in circuitry and packaging.

**ALL SOLID STATE**, the 671's are optically isolated between logic and AC or DC power; high noise immunity prevents misfiring in industrial atmospheres. Output converters have high surge ratings for inductive loads; an AC output unit is available with zero voltage switching to minimize RFI. There's more: easy multiplex operation, LED status indicators for simple troubleshooting, and solid state reliability . . . *minimum* life of 10<sup>8</sup> operations.

Packaged for side-by-side panel mounting, the power terminals (barriered screws) are physically isolated from the logic pins to prevent accidental intrusions; side-by-side units mean no terminal strips and interconnect wiring.

If you're in the mainframe business and want to offer process control, or if you're in the processing world and want computer control, write or call about the 671 series; our application engineers will put you in solid control.

 **TELEDYNE RELAYS**

3155 West El Segundo Boulevard Hawthorne, California 90250  
Telephone (213) 973-4545

INFORMATION RETRIEVAL NUMBER 3

ELECTRONIC DESIGN 1, January 4, 1974

# Electronic Design

VOL. 22 NO.

**1**

FOR ENGINEERS AND ENGINEERING MANAGERS

JAN. 4, 1974

---

## NEWS

- 35 **News Scope**
- 44 **The industry outlook for 1974** in instruments, semiconductors, computers and consumer electronics.
- 64 **Better components and materials** are widening magnetic applications—  
An Electronic Design special report.
- 76 **Flat-panel television** promises have returned once again, but this time they could be for real.
- 85 **Washington Report**
- 

## TECHNOLOGY

- 100 **Improve CRT-display systems with NMOS.** Compared to a PMOS approach, NMOS memories allow greater and more efficient storage, and hence, a large variety of characters.
- 112 **Unify two-port calculations** with a single analysis technique—the indefinite matrix. With this approach, you can handle any circuit, piece by piece.
- 120 **Transform the biquad into a biquartic** and reap bonuses. Biquartic filters allow easy low-pass-to-bandpass transformations with few calculations.
- 130 **Slash power converter design time** and get optimum performance, too. Here are component specification tables and a step-by-step technique.
- 138 **Look out! All electrolytic capacitors** are not alike. Internal construction determines unwanted inductance that limits high-frequency performance.
- 144 **Watch out for problems** in switching-mode power equipment. Filters added to prevent EMI can cause your system to oscillate.
- 148 **Forecasting is an engineering job, too,** says corporate head. Physics, a feel for customer needs and attention to detail all help turn designs into products.
- 154 **Ideas for Design:** Less than 1.5% distortion over 1000:1 range provided by swept-frequency oscillator . . . Diode-resistor network adds user-selected readout capability to scope display system . . . Simple reconnection reduces rise time of CMOS delay circuit . . . Program selects standard resistor values for calculated values when tolerance is given.
- 162 **International Technology**
- 

## PRODUCTS

- 167 **Modules & Subassemblies:** Low-cost data converters provide 0.01% linearity.
- 178 **ICs & Semiconductors:** Low-cost, 10-MHz FET op amp provides higher stability.
- 184 **Instrumentation:** 5-kW pulse generator costs just \$1990.
- |                     |                           |
|---------------------|---------------------------|
| 172 Power Sources   | 201 Packaging & Materials |
| 192 Data Processing | 204 Microwaves & Lasers   |
- 

## Departments

- |  |                                |
|--|--------------------------------|
| 97 <b>Editorial:</b> The troublemakers |                                |
| 7 Across the Desk                      | 223 Bulletin Board             |
| 212 Application Notes                  | 226 Advertisers' Index         |
| 212 Evaluation Samples                 | 228 Product Index              |
| 215 Design Aids                        | 230 Information Retrieval Card |
| 216 New Literature                     |                                |

**Cover:** Designed and photographed by Art Director Bill Kelly

---

ELECTRONIC DESIGN is published biweekly by Hayden Publishing Company, Inc., 50 Essex St., Rochelle Park, N. J. 07662. James S. Mulholland, Jr., President. Printed at Brown Printing Co., Inc., Waseca, Minn. Controlled circulation postage paid at Waseca, Minn., and New York, N. Y., postage pending Rochelle Park, N. J. Copyright © 1973, Hayden Publishing Company, Inc. 84,392 copies this issue.



# Component Orders Up? Shipments Down?

HP's new LCR meter helps you get your orders out fast. If you're testing diodes, capacitors—or trimming IC capacitors or resistors—you need fast, precise, automatic LCR and loss measurements. You need the most *reliable* LCR meter you can get—one with solid state circuits and LED display. Now you can have it for only \$4500\*—less than you've had to pay for this kind of capability. When you plug our new Model 4271A 1 MHz Digital LCR Meter into your system you get fast-reading digital measurements, 10,000 an hour or more. You get four-pair measurement and offset adjustments that eliminate most fixture problems. And you get an instrument that's compatible with many HP programmable calculators and computers.

But the 4271A's accuracy and versatility make it just as great an asset to your design lab as to your pro-

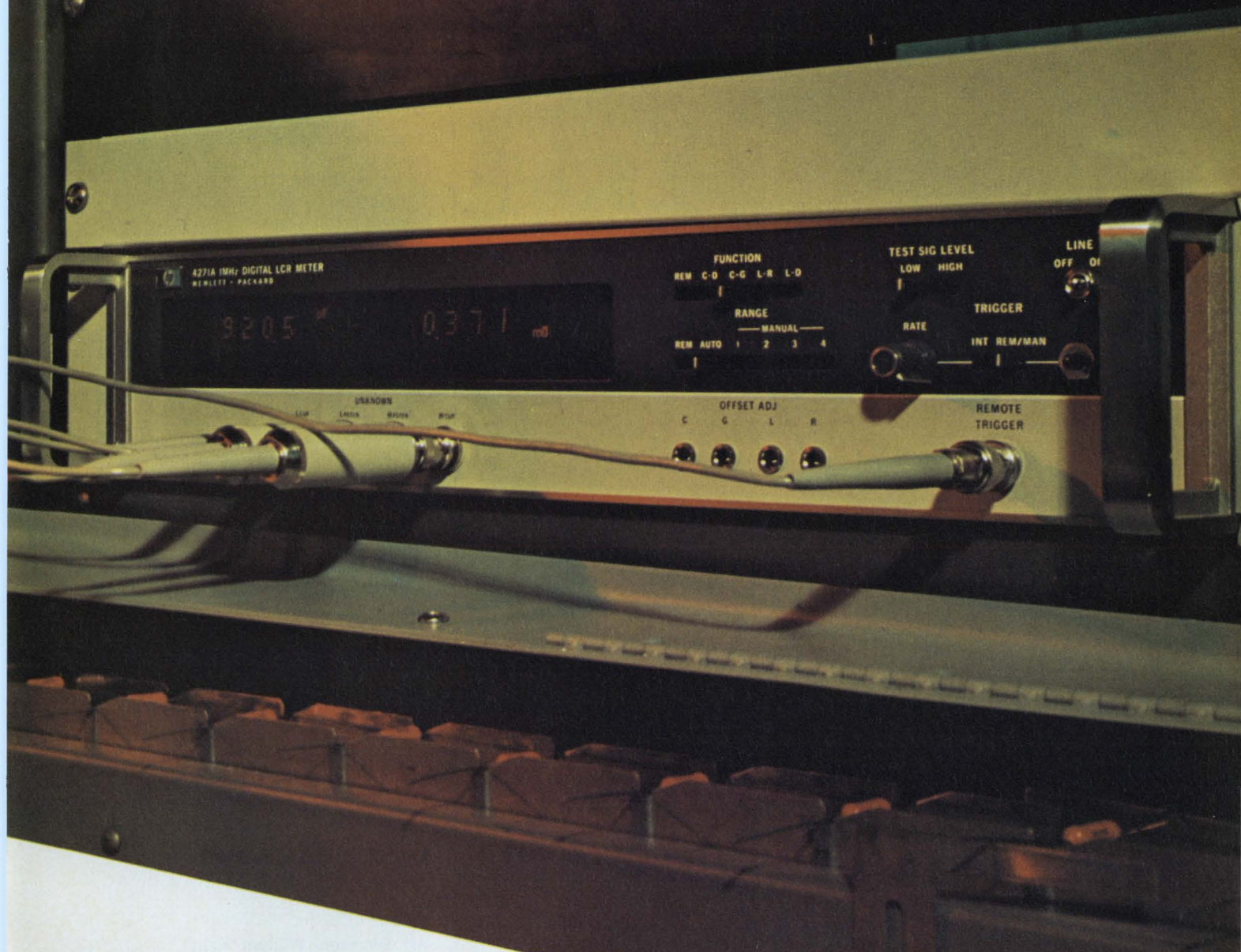

duction line. It's a snap to measure capacitance from 10.000 pF to 19.000 nF, and to measure inductance from 1000.0 nH to 1900.0 $\mu$ H. You'll also find that you can greatly simplify varicap diode testing and other kinds of micro-circuit design measurements with the 4271A and its optional DC Bias Controller. This lets you vary DC bias from 00.0V to 39.9V in 0.1V increments.

Remember that this new addition comes to you at a new low price, \$4500\*. Inexpensive options are also available: Program Code for Calculator/Computer Interface or BCD Output, DC Bias Controller —and DC Power Supply. And they're all backed by HP's time-tested reputation for reliability and service.

For more information contact your local HP field engineer.

\*Domestic USA prices only.

### The Useables— new standards in component testing.



Universal Bridge, High Resistance Meter, LCR Meter, Analog Comparator  
Universal Bridge, Milliohmeter, Q Meter, Automatic Capacitance Bridge, High-Capacitance Meter



Sales, service and support in 172 centers in 65 countries.  
Palo Alto, California 94303. Offices in principal cities throughout the U.S.

093/53 A

# When You Buy a Power Supply, Why Not Get the Best?

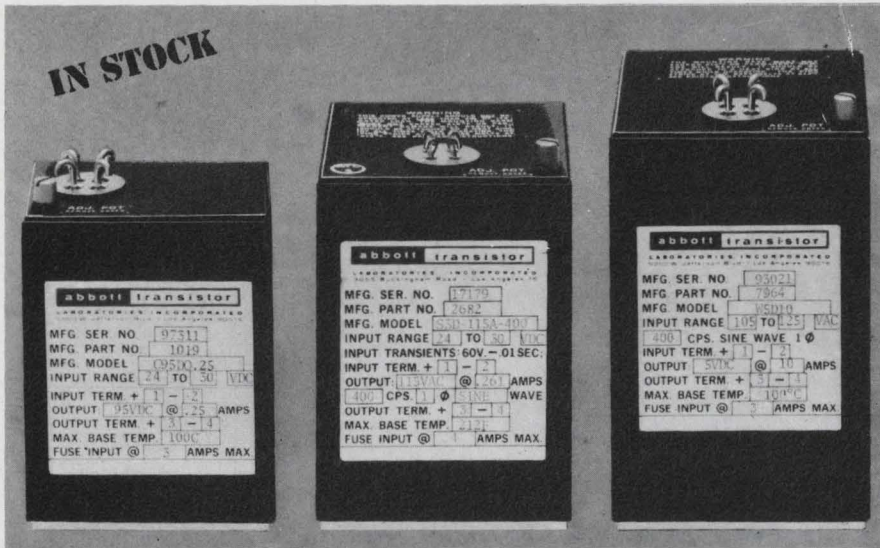

**28 VDC to DC**  
(55,463 Hrs.)  
Model C95D

**28 VDC to 400 A**  
(61,387 Hrs.)  
Model S3D

**400 A to DC**  
(56,148 Hrs.)  
Model W5D

## Abbott's New Hi-Performance Modules

are designed to operate in the stringent environment required by aerospace systems — (per MIL-E-5400K or MIL-E-5272C) and MIL-STD-461 for electromagnetic interference.

**RELIABILITY** — MTBF (mean time between failures) as calculated in the MIL-HDBK-217 handbook can be expected in excess of 50,000 hours at 100°C for all of these power modules. The hours listed under the photos above are the MTBF figures for each of the models shown. Additional information on typical MTBF's for our other models can be obtained by phoning or writing to us at the address below.

**QUALITY CONTROL** — High reliability can only be obtained through high quality control. Only the highest quality components are used in the construction of the Abbott power module. Each unit is tested no less than **41 times** as it passes through our factory during fabrication — tests which include the scru-

tinizing of the power module and all of its component parts by our experienced inspectors.

**NEW CATALOG**—Useful data is contained in the new Abbott Catalog. It includes a discussion of thermal considerations using heat sinks and air convection, a description of optional features, a discussion of environmental testing, electromagnetic interference and operating hints.

**WIDE RANGE OF OUTPUTS** — The Abbott line of power modules includes output voltages from 5.0 volts DC to 3,650 volts DC with output currents from 2 milliamperes to 20 amperes. Over 3000 models are listed **with prices** in the new Abbott Catalog with various inputs:

- 60A to DC, Regulated
- 400A to DC, Regulated
- 28 VDC to DC, Regulated
- 28 VDC to 400A, 1 $\phi$  or 3 $\phi$
- 24 VDC to 60A, 1 $\phi$

Please see pages 581-593 of your 1973-74 EEM (ELECTRONIC ENGINEERS MASTER Catalog) for complete information on Abbott Modules.

Send for our new 68 page FREE catalog.

**abbott transistor**

**LABORATORIES, INCORPORATED**  
5200 W. Jefferson Blvd./Los Angeles 90016 1224 Anderson Ave./Fort Lee, N.J. 07024  
(213) 936-8185 Cable ABTLABS (201) 224-6900

INFORMATION RETRIEVAL NUMBER 5

**Vice President, Publisher**  
Peter Coley

### Editors

Editorial Offices  
50 Essex St.  
Rochelle Park, N.J. 07662  
(201) 843-0550  
TWX: 710-990 5071  
Cable: Haydenpubs Rochellepark

**Editor-in-Chief** George Rostky

### Managing Editors:

Ralph Dobriner  
Michael Elphick

### Associate Editors:

Dave Bursky  
Jules H. Gilder  
Morris Grossman  
Seymour T. Levine  
John F. Mason  
Stanley Runyon  
Edward A. Torrero  
Richard L. Turmail

### Contributing Editors:

Peter N. Budzilovich  
Steven A. Erenburg

### Editorial Field Offices

#### East

Jim McDermott, Eastern Editor  
P.O. Box 272  
Easthampton, Mass. 01027  
(413) 527-3632

#### West

David N. Kaye, Senior Western Editor  
2930 West Imperial Highway  
Inglewood, Calif. 90303  
(213) 757-0183  
Northe K. Osbrink, Western Editor  
112 Coloma St.  
Santa Cruz, Calif. 95060  
(408) 426-3211

#### Washington

Heather M. David, Bureau Chief  
2506 Eye St., N.W.  
Washington, D.C. 20037  
(202) 338-3470

### Editorial Production

Marjorie A. Duffy

### Art

Art Director, William Kelly  
Richard Luce  
Anthony J. Fischetto

### Production

Manager, Dollie S. Viebig  
Helen De Polo  
Anne Molfetas  
Christopher G. Hill

### Circulation

Manager, Nancy L. Merritt

### Information Retrieval

Peggy Long

### Promotion

Manager, Jeffrey A. Weiner  
Karen Kerrigan



# across the desk

## Who invented radar? Well, it seems that—

I see that the battle over the invention of radar still goes on (see "Achtung: A Touch of Teutonic Pride, ED No. 15, July 19, 1973, p. 8 and "German Firsts? Yes, But How About These," ED No. 22, Oct. 25, 1973, p. 7). If one assumes that invention is the first step in an essentially continuous investigation of a concept directed toward a specific need, then I submit that the 1922 experiments of Taylor and Young at the U.S. Naval Research Laboratory constitute the beginning of radar.

Although engaged in communications experiments, they detected the interference from cars and ships, recognized the implications of this interference and recommended additional work in pursuit of military objectives. The interference phenomenon identified by Taylor and Young was exploited by Appleton and Barnett in England (1924-5) and Breit and Tuve in the United States (1925) for ionospheric sounding. The military utility was again recognized in 1930 by Hyland of the Naval Research Laboratory when, in some direction-finding experiments, he detected the presence of aircraft.

Work on radar at the Naval Research Laboratory continued thereafter in spite of the Depression-induced budget cuts. Serious (funded) radar work began in 1934, which was about the same time it began elsewhere. It was at this time that the "giants" of radar—Page, Watson-Watt, et al—came to the fore.

No mention was made by any of your correspondents of Hulsmeyer, who was granted a patent on radar in 1904. Unfortunately Hulsmeyer was born 30 years too soon—prior to the time that a need for radar had been established.

However, if invention is defined by letters patent, then Hans J. Wilhelmy (see letter in ED 15, July 19, 1973, p. 8) is correct as to country but in error by 32 years.

This represents my personal opinion and should not be construed as an official Naval Research Laboratory response.

*R. D. Tompkins*

*Target Characteristics Branch  
Radar Div.*

Naval Research Laboratory  
Washington, D.C. 20375

## From the Watergate . . .

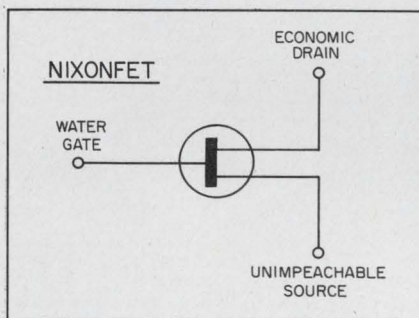

Our research staff recently uncovered a new semiconductor device the NIXONFET. We thought you might find it interesting and have drawn a schematic of the device below.

P.S. It works in a fully depleted mode.

*Ray N. Lubow*

*Senior Member of Technical Staff  
Calculator Products Group*

Litronix  
19000 Homestead Rd.  
Vallico Park  
Cupertino, Calif. 95014

## The pros and cons of full ad disclosure

Your editorial "Let's Have More Disclosure" (ED No. 21, Oct. 11, 1973, p. 61) was of interest. Our company—like nearly any other

*(continued on page 13)*

Electronic Design welcomes the opinions of its readers on the issues raised in the magazine's editorial columns. Address letters to Managing Editor, Electronic Design, 50 Essex St. Rochelle Park, N.J. 07662. Try to keep letters under 200 words. Letters must be signed. Names will be withheld on request.

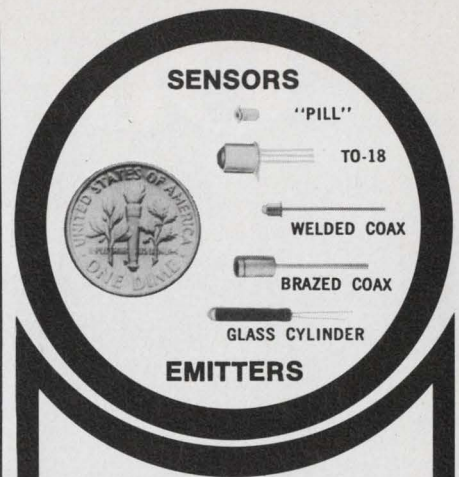

## OPTRON OPTOELECTRONIC COMPONENTS

STANDARD DISCRETE PACKAGES  
IMMEDIATE DELIVERY  
COMPETITIVE PRICING

OPTRON'S competitively priced broad line of standard optoelectronic components range from solid state gallium arsenide emitters to silicon photodiodes, phototransistors, and photodarlingtons. They are immediately available in microminiature "pill," TO-18, welded or brazed coax, and glass cylinder packages.

OPTRON silicon photodetectors are compatible with either tungsten light sources or infrared LED's. The solution-grown epitaxial gallium arsenide LED's offer high efficiency and compatibility with the silicon photodetectors.

All OPTRON discrete components are available in other packages in moderate scale line quantities using standard chips. In addition, these units may be purchased as either standard or custom chips, monolithic arrays, printed circuit board assemblies, or molded assemblies.

Detailed technical information on discrete components and other OPTRON optoelectronic products . . . chips, assemblies and PC board arrays . . . is available from your nearest OPTRON sales representative or the factory direct.



### NEW CONDENSED CATALOG

contains technical data on these and other OPTRON products. Request your copy today!



**OPTRON, INC.**

1201 Tappan Circle  
Carrollton, Texas 75006  
214/242-6571

# Our new low-profile Our new low price

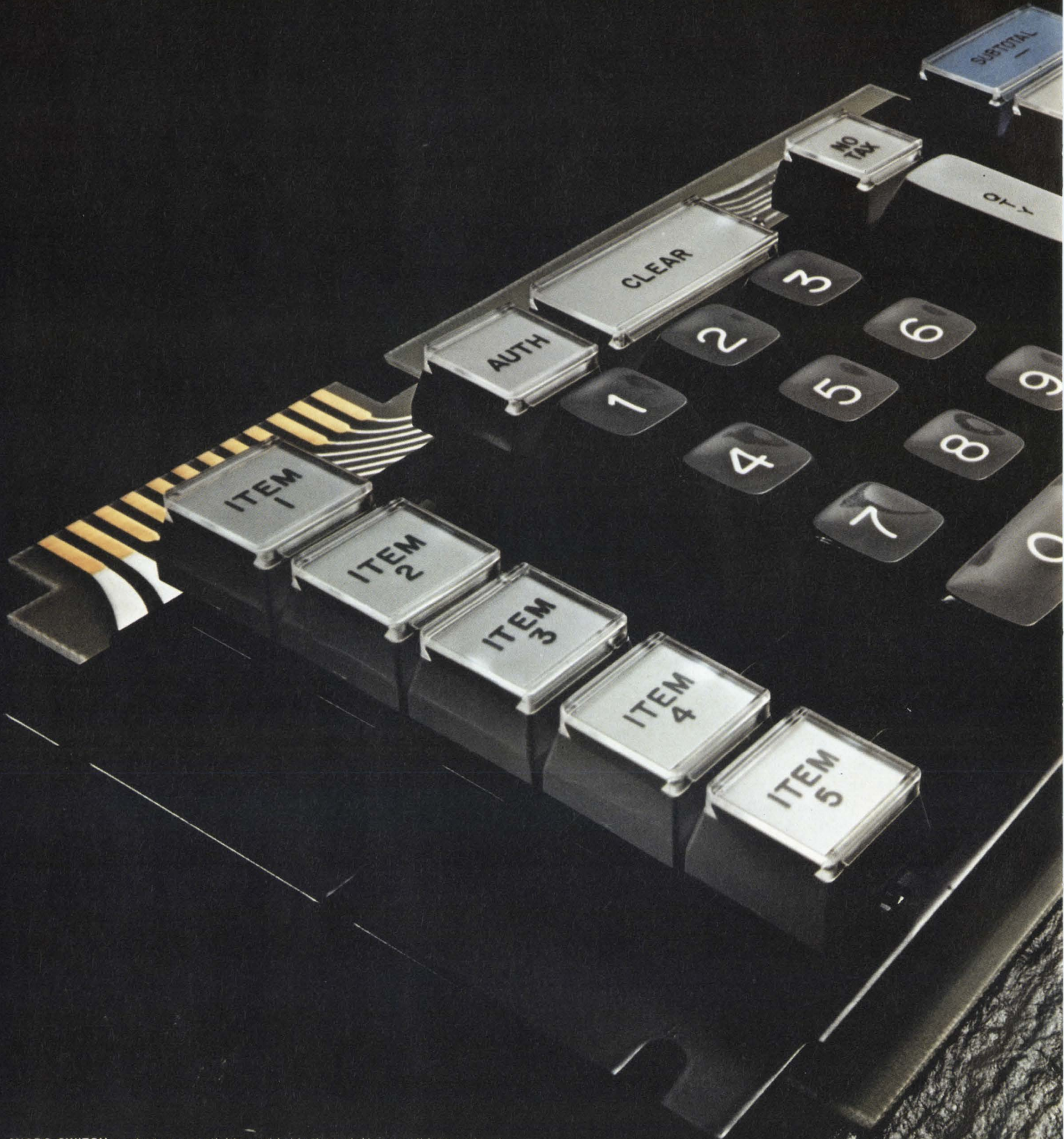

# keyboard is solid-state. is mechanical.

We've expanded your keyboard options dramatically with our new SD low-profile keyboard.

It makes MICRO SWITCH solid-state prices (based on 1975 delivery) competitive with less reliable mechanical-contact keyboards.

So price is no barrier. No matter what your need. Be it word processing, point-of-sale or other data entry applications.

We've coupled our unique Hall effect switch with an advanced "flip chip" ceramic mounting technique to further increase the reliability of our solid-state keyboards.

And our new low-profile design is ideal for modern compact terminal needs.

Picture a MICRO SWITCH keyboard in your system design. We're ready to talk prototypes now, with production in late 1974. Contact a MICRO SWITCH Branch Office for complete information.

It's the change you've really been looking for.

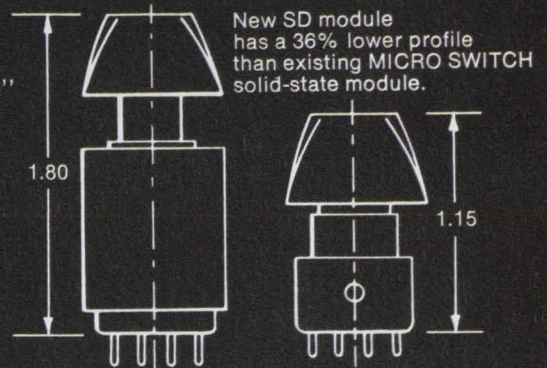

**MICRO SWITCH**

FREEPORT, ILLINOIS 61032

A DIVISION OF HONEYWELL

INFORMATION RETRIEVAL NUMBER 235

# A sample batch of the year's top numbers.

## ECL 10K: Now easy as ABC



The big three basics come first at Signetics.

**NEW ECL 10K0 FUNCTIONS:**

10100	Quad 2-input gate. Most useful 10K function. Most reasonably priced.
10101/10102	Quad differential line drivers/receivers. ECL-1K replacement. Six high-performance devices sharing and receiving, below the cost of any other similar devices.
10103	Multiplexer. 8-to-1 input/output. 2.5ns high-speed data paths.
10104/10105	8-to-1 input. 1. Large fan-out multiplexer, operating at 3.5ns.
10210	Parity. 9-to-1 input expandable parity circuit.
10212	Storage. Quad D-type latch with gated outputs.
10213	Memory. 1024-bit. Estimated 100ns. 3000 operations. Customer lead time 10W, 10M.

**Compatibility:** Pin-for-pin identical with Motorola MC10K. 10K00 with reduced expected temperature coefficients and ruggedness. 10K10 to 10K20. Two-in-depth production process assures low failure rate and reliability. You can get Signetics ECL 10K in dual in-line packages with full height pins or in the industry's most compact surface-mount package. Surface-mount packages are completely compatible with standard system layouts.

**PRICE:** ECL 10K starts at just \$1.00 in quantity.

To introduce our new ECL 10K products we are offering an Evaluation Kit at no extra cost. To get your first-hand experience with Signetics optimized ECL 10K.



## Boost memory speed and capacity to new heights.



**PROMs to 15ns, ROMs to 4096 bits.**

We hear you talking, you want to design a more powerful machine. You need faster access times, more memory and more lines of memory in less space. With programming that lets your customer's customers program and test systems, you can get kind of machine power you want to be able to do in less space and time. You want to be able to do it in less space and time. You want to be able to do it in less space and time.

**Now you get it. From Signetics.**

In PROMs, where large production runs and fast access times from a single lead-in. Signetics gives you a wide range of PROMs and ROMs, and gives you even higher performance and more capacity than ever before. In ROMs, you get the kind of machine power you want to be able to do in less space and time. You want to be able to do it in less space and time. You want to be able to do it in less space and time.

Part	Capacity	Access Time
10101	256	15 ns
10102	256	15 ns
10103	256	15 ns
10104	256	15 ns
10105	256	15 ns

**Signetics**

Name \_\_\_\_\_  
Address \_\_\_\_\_  
City \_\_\_\_\_ State \_\_\_\_\_ Zip \_\_\_\_\_

Phone \_\_\_\_\_



## 556: A real IC two-timer.



**The timer of 1001 uses.**

Men, did you inundate us with applications for the 556 single timer? You used it for every possible function from light switches to audio generators to RF outputs. And then, you often used a second 556 to control the function you generated with the first one.

**We got the message: put two of these timers on one chip. Here it is — the 556 dual timer. Two 556s on a chip, twice the product at less than twice the cost: 100 pins at \$1.25. Here's that for responsiveness!**

Think of what you can do. Each timer on the 556 chip is independent, and needs only the appropriate values of R and C for function as a time delay.

**Our timer has four of 556s. Here are a few:**

- Two of the 556s as a square wave generator.
- Two of the 556s as a monostable multivibrator.
- Two of the 556s as a 555 timer substitute.

oscillator, pulse detector, power monitor, or what have you. Any kind of output you can dream up from one side, and the control from the other side. Go wild — it can be anything from a toy to a household appliance to a communications breakdown. Run free or latch with external triggering. You've got a time span from microseconds to an hour, and



## UHF demanded 1 GHz FETs. Signetics D-MOS does it.



**FETs? From Signetics?**

Surprise! Signetics goes discrete. With the first FETs ever produced for frequencies above 400 MHz. And everything we've poured into optimized ICs for years — especially, state-of-the-art research, user-oriented problem solving techniques, and the best of the D-MOS channel transfer mode. Four of them to start. Proceeding, user-designed performance that doesn't just meet the needs of most, but that of the most demanding, TV tuners, and hundreds of similar applications.

**1 GHz.** Available now through your distributor in TO-18 metal packages, with four leads. Call for immediate delivery. Or turn in for the news behind the news. By asking for complete data sheets, including test procedures, and a full complement of application data. Public notice. Be one of the first 100 to get your first-hand experience with this D-MOS FET of your choice. For more info call:



## Economy: First Class



**MONETICS LINEAR. First with phase locked loop!**

Signetics' new Linear ICs, the first with phase locked loop (PLL) control, give you the best of both worlds. They give you the same excellent performance and reliability that you expect from our ICs, but with the added benefits of PLL control. This gives you the same excellent performance and reliability that you expect from our ICs, but with the added benefits of PLL control. This gives you the same excellent performance and reliability that you expect from our ICs, but with the added benefits of PLL control.



## FREE

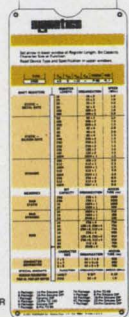

**FREE MOS Selector Slickchart**

Pick up a FREE MOS Selector Slickchart and give yourself the broadest MOS line in the industry. On one side, you choose a function (say, an SR ROM), set the pointer, and read off all the major specs. The reverse side, a cross-reference guide, instantly converts any of 114 "Brand X" devices to the Signetics part number. Makes ordering our MOSs as easy as getting and using them.

From Signetics you get everything you want, with no less sky, Super. So the adjectival. Send. Get. Quick.



Integrated Circuits

**SIGNETICS CORPORATION**



"Where advanced technology is just part of the service."

Main Office and Manufacturing Plant:

811 E. Arques,  
Sunnyvale, Cal. 94086  
(408) 739-7700

**AUTHORIZED DISTRIBUTORS**

**ARIZONA**

Phoenix: Hamilton/Avnet Electronics  
2615 S. 21st Street . . . (602) 275-7851

Phoenix: Kierulff Electronics  
2633 East Buckeye Road (602) 273-7331

*Put more into your lines, tie into your neighborhood distributor.*

**CALIFORNIA**

Culver City: Hamilton Electro Sales  
10912 W. Washington . . (213) 870-7171

El Monte: G. S. Marshall  
9674 Telstar Avenue . . . (213) 686-0141

Los Angeles: Wesco Electronics  
5650 Jillson Street . . . (213) 685-9525

Mountain View: Hamilton/Avnet Electronics  
340 E. Middlefield Road . (415) 961-7000

Palo Alto: Wesco Electronics  
3973 E. Bayshore Road . (415) 968-3475

San Diego: Hamilton/Avnet Electronics  
8917 Complex Dr. . . . (714) 279-2421

San Diego: Cramer Electronics  
8975 Complex Dr. . . . (714) 565-1881

San Diego: Kierulff Electronics  
8797 Balboa Avenue . . . (714) 278-2112

Sunnyvale: Cramer Electronics  
720 Palomar . . . . . (408) 739-3011



A telephone call to your distributor is one of today's best bargains.



**CANADA**

Downsview, Ontario: Cescio Electronics  
24 Martin Ross Ave. . . . (416) 661-0220

Downsview, Ontario: Cramer Electronics  
920 Alness Ave. Unit 9. . (416) 661-9222

Montreal, Quebec: Cescio Electronics  
4050 Jean Talon West . . (514) 735-6393

Montreal, Quebec: Hamilton/Avnet  
935 Montee des Liesses. (514) 735-6393

Ottawa, Ontario: Hamilton/Avnet Electronics  
880 Lady Ellen Place . . . (613) 725-3071

Ottawa, Ontario: Cescio Electronics  
1300 Carling Avenue . . . (613) 729-5118

**COLORADO**

Denver: Hamilton/Avnet Electronics  
5921 N. Broadway . . . . (303) 534-1212

Denver: Cramer Electronics  
5465 E. Evans Place at Hudson . . . . . (303) 758-2100

Integrated Circuits — Distributors (Cont'd)

**CONNECTICUT**

Hamden: Arrow Electronics  
295 Treadwell Street . . . (203) 248-3801

Georgetown: Hamilton/Avnet Electronics  
643 Danbury Road . . . . (203) 762-0361

North Haven: Cramer Electronics  
35 Dodge Avenue . . . . . (203) 239-5641

**FLORIDA**

Hollywood: Hamilton/Avnet Electronics  
4020 N. 29th Ave. . . . . (305) 925-5401

Hollywood: Schweber Electronics  
2830 N. 28th Terrace . . (305) 927-0511

Orlando: Hammond Electronics  
911 W. Central Blvd. . . . (305) 241-6601

Signetics takes a back seat to no one in ECL 10K. Call us on it.

**GEORGIA**

Atlanta: Schweber Electronics  
4126 Pleasantdale Road, Suite 14 . . . . . (404) 449-9170

Norcross: Hamilton/Avnet Electronics  
6700 Interstate 85 Access Road, Suite 2B . . . . . (404) 448-0800

SCHOTTKY ON THE DOUBLE.  
Promote the telephone, call your distributor.

**ILLINOIS**

Elk Grove: Schweber Electronics  
1380 Jarvis Ave. . . . . (312) 593-2740

Elmhurst: Semiconductor Specialists  
195 Spangler Ave., Elmhurst Industrial Park . . . . . (312) 279-1000

Schiller Park: Hamilton/Avnet Electronics  
3901 N. 25th Ave. . . . . (312) 678-6310

**INDIANA**

Indianapolis: Semiconductor Specialists  
P.O. Box 41630, Weir Cook Airport . . . . . (317) 243-8271

Dip into 0.15% AQL, with Signetics SUPR DIP digital circuits.

**KANSAS**

Lenexa: Hamilton/Avnet Electronics  
37 Lenexa Industrial Center . . . . . (913) 888-8900

**MARYLAND**

Hanover: Hamilton/Avnet Electronics  
7255 Standard Drive . . . (301) 796-5000

Rockville: Pioneer Washington Electronics  
1037 Taft Street . . . . . (301) 424-3300

Rockville: Schweber Electronics  
5640 Fisher Lane . . . . . (301) 881-2970

Here's a direct line to the shelves of your Comparator Supermarket.

**MASSACHUSETTS**

Burlington: Hamilton/Avnet Electronics  
185 Cambridge St. . . . . (617) 273-2120

Needham Heights: Kierulff Electronics  
14 Charles Street . . . . (617) 449-3600

Newton: Cramer Electronics  
85 Wells Avenue . . . . . (617) 969-7700

Waltham: Schweber Electronics  
213 Third Avenue . . . . . (617) 890-8484

Integrated Circuits — Distributors (Cont'd)

**MICHIGAN**

Livonia: Hamilton/Avnet Electronics  
12870 Farmington Rd. . . (313) 522-4700

Detroit: Semiconductor Specialists  
25127 W. Six Mile Rd. . . (313) 255-0300

**MINNESOTA**

Minneapolis: Semiconductor Specialists  
8030 Cedar Ave., South . (612) 854-8841

Edina: Hamilton/Avnet Electronics  
7683 Washington Avenue, South . . . . . (612) 941-3801

**MISSOURI**

Hazelwood: Hamilton/Avnet Electronics  
392 Brookes Lane . . . . (314) 731-1144

**NEW YORK**

Buffalo: Summit Distributors  
916 Main Street . . . . . (716) 884-3450

Farmingdale, L. I.: Arrow Electronics  
900 Broad Hollow Road . (516) 694-6800

Rochester: Schweber Electronics  
999 Buffalo Road . . . . (716) 328-4180

Syracuse: Hamilton/Avnet Electronics  
6500 Joy Road . . . . . (315) 437-2642

Westbury: Schweber Electronics  
Jericho Turnpike . . . . . (516) 334-7474

Westbury: Hamilton/Avnet Electronics  
70 State Street . . . . . (516) 333-5800

JAN/Hi-Rel ICs.

Use? Buy? Specify?

Your distributor qualifies.

**NEW MEXICO**

Albuquerque: Cramer Electronics  
137 Vermont, N.E. . . . . (505) 265-5767

**NORTH CAROLINA**

Greensboro: Hammond Electronics  
2923 Pacific Avenue . . . (919) 275-6391

**NORTHERN NEW JERSEY**

Cedar Grove: Hamilton/Avnet Electronics  
218 Little Falls Road . . (201) 239-0800

Saddlebrook: Arrow Electronics  
285 Midland Avenue . . . (201) 256-7331

No-Hitch Schottky Comparators. So easy to shop by telephone.



**SOUTHERN NEW JERSEY AND PENNSYLVANIA**

Moorestown: Arrow/Angus Electronics  
Pleasant Valley Road . . (609) 235-1900

Mt. Laurel, N.J.: Hamilton/Avnet Electronics  
113 Gaither Dr., East Gate Industrial Park . . . . . (609) 234-2133

Cherry Hill, N.J.: Milgray-Delaware Valley  
1165 Markkress Rd. . . . (609) 424-1300

INSTANT 883.

Consult this page for instant 883 and JAN IC's

Integrated Circuits — Distributors (Cont'd)

**CENTRAL NEW JERSEY AND PENNSYLVANIA**

Somerset, N.J.: Schweber Electronics  
43 Belmont Drive . . . . . (201) 469-6008

**OHIO**

Beechwood: Schweber Electronics  
23880 Commerce Park Road . . . . . (216) 464-2970

Cleveland: Arrow Electronics  
23945 Mercantile Rd. . . (216) 464-2000

Cleveland: Pioneer Standard Electronics  
4800 E. 131st Street . . . (216) 587-3600

Dayton: Hamilton/Avnet Electronics  
118 Park Road W. . . . . (513) 433-0610

Kettering: Arrow Electronics  
3100 Plainfield Rd. . . . . (513) 253-9176



OPTIMIZED PROMs and ROMs:



call for optimized service.



**TEXAS**

Dallas: Hamilton/Avnet Electronics  
4445 Sigma Road . . . . . (214) 661-8661

Dallas: Cramer Electronics  
2970 Blystone Ave. . . . . (214) 350-1355

Houston: Component Specialties  
7315 Ashcroft, Suite 113 . . . . . (713) 771-7237

Houston: Hamilton/Avnet Electronics  
1216 West Clay Street . . (713) 526-4661

☆☆☆ 555: ☆☆☆

The timer of 1001 uses. Promote the telephone shopping habit.

☆☆☆ 555: ☆☆☆

**UTAH**

Salt Lake City: Alta Electronics  
2280 S. Main St. . . . . (801) 486-7227

Salt Lake City: Hamilton/Avnet Electronics  
647 W. Billinis Rd. . . . . (801) 262-8451

One-stop shopping: call your distributor for total TTL needs.

**WASHINGTON**

Bellevue: Hamilton/Avnet Electronics  
13407 Northrup Way . . . (206) 746-8750

Seattle: Cramer Electronics  
5602 6th Ave., South . . . (216) 762-5722

Your distributor brings the world to your door . . . with Bipolar ROMs and RAMs.

**Dow Corning silicones  
protect this Time Computer\*  
against a 2,500-g impact.**

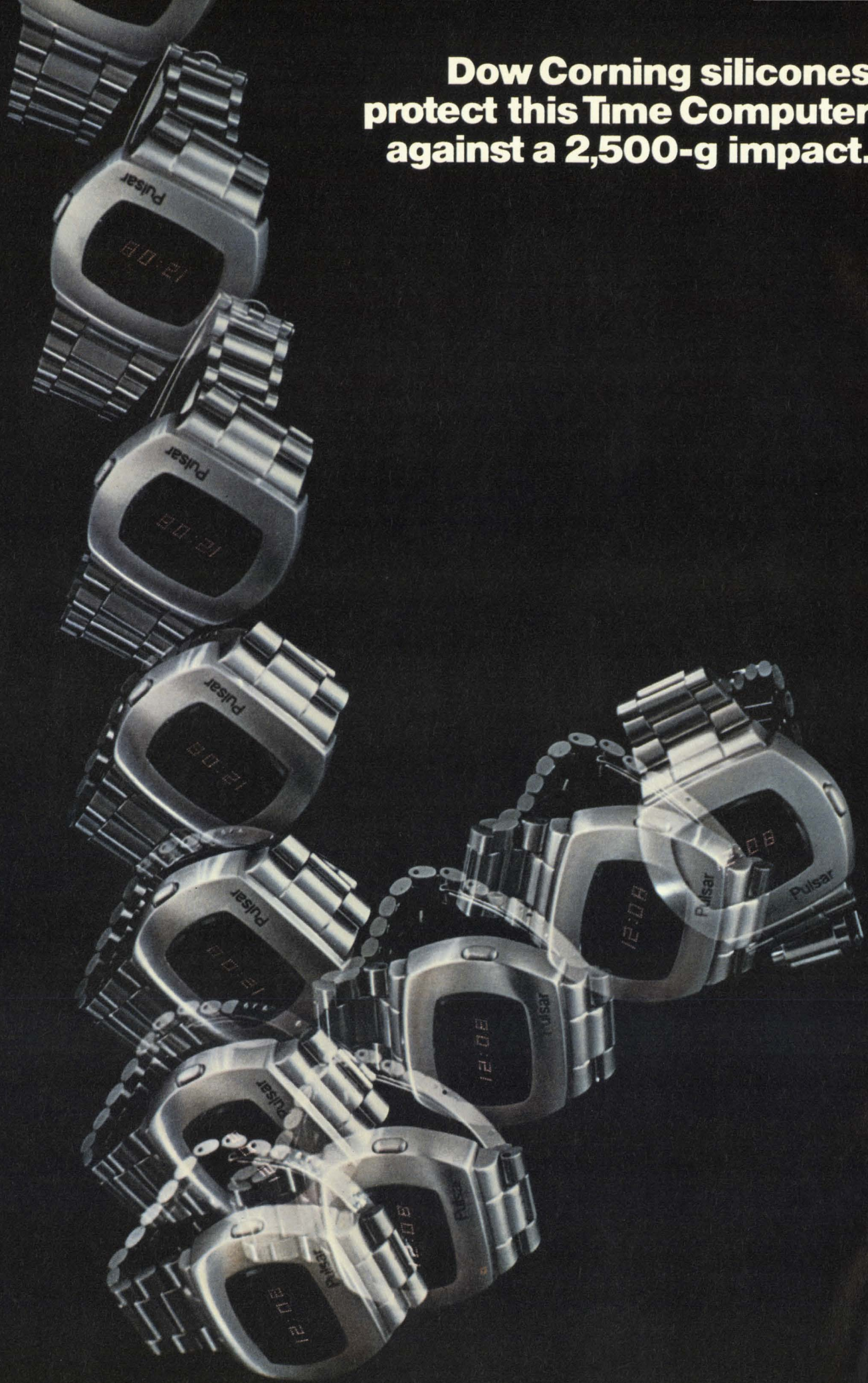

# They also protect against heat, moisture and thermal shock.

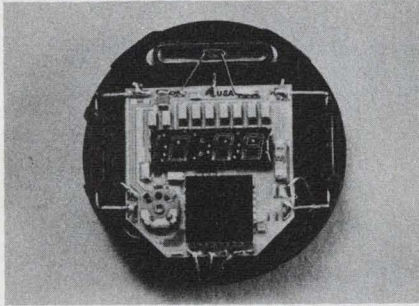

This Pulsar computer circuit uses Dow Corning silicones for shock protection, for positioning individual components, and as a moisture barrier. They all help Pulsar maintain an accuracy of  $\pm 5$  seconds per month. A major production advantage with silicones: only one hour primary cure is required before further assembly work. Yet if a circuit element is improperly placed or doesn't test out, the clear sealant can easily be cut away and the individual component replaced without complete rework. Circle No. 121.

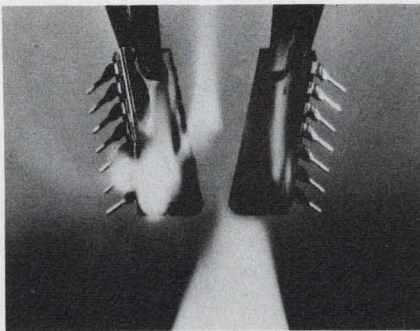

ICs, MOS, CMOS, and other devices made with flame resistant silicone molding compounds provide in many applications the reliability of hermetics at about  $\frac{1}{3}$  the cost. These compounds are superior in moisture resistance, thermal life and electronic stability over other plastics. Their heat resistant and shock protective qualities make them especially valuable in the unusually harsh environments of automotive applications. And molding cycle times are as short as 30 seconds. Circle No. 122.

*Pulsar units withstand 2,500 g's, symbolized by this strobe illuminated scene. Courtesy Time Computer, Inc., subsidiary HMW Industries, Inc.*

\*Trademark of HMW Industries, Inc.

For cooling high-density, high-performance modules, silicone fluids thin out very little, and silicone heat-sink compounds won't melt. This results in more effective heat dissipation, required in high-voltage power supplies operating over a wide temperature range. Circle 123.

Silicone rubber insulated wire and cable, used in nuclear power-plant instrumentation and controls, provide reliable service in applications to 260 C without gumming or



melting. And they continue to function even after a fire because of their nonconducting ash. Circle No. 124.

These electronic-quality silicone products are representative of a complete line of silicones that have inherent properties making them ideal protectors for almost every circuit/system.

Send today for "Silicones for Electronic Design," a 24-page brochure full of special applications for improving electronic circuits. Dow Corning Corporation, Department A-3202, Midland, Michigan 48640. Or call your nearest Dow Corning distributor.

**Silicones; simply the best way to protect electronic circuits.**

## DOW CORNING

DOW CORNING

## ACROSS THE DESK

(continued from page 7)

electronics company—relies on advertising to spread the "good word" about our products. Because our products are unique, are considered by some to be expensive and are generally bought by engineering people, we find it necessary to handle our advertising in this perspective.

I agree with the last paragraph of your editorial, in which you say that "victory" should "go to the vendor with the fullest and most honest disclosure." On the other hand, there are several factors that limit the ability of a company to supply the user with total information. These include:

- The size of a one-third page ad, say, when compared with a brochure of several pages.

- The fact that the user must take into consideration variations in design and the adverse effects they may have on the operation of the device—for example, temperature, cleaning agents, applied power or shock.

So I hope you won't be surprised if not everybody attempts to turn out advertisements that contain 100% of the known information on products. You have probably seen cases where certain ads should be cleaned up extensively—and I hope you keep pushing for this.

J. R. Bush

Applications Engineer

Victoreen Instrument Div.

10101 Woodland Ave.

Cleveland, Ohio 44104

## Correction

In the Nov. 8 issue of ELECTRONIC DESIGN the title of Walter Jung's winning Idea for Design was given incorrectly. The correct title is "Transistor and Two Resistors Reduce Noise and Widen Bandwidth of 101/748 Op Amps." The idea was published in the July 5 issue.

## A loud 'Right on!' for peril-free design

Your editorial "Let's Not Become Another Auto Industry" (ED No. 22, Oct. 25, 1973, p. 51) is

(continued on page 16)

# Available! RCA UHF Power Amplifier Modules... in production quantities.

RCA Solid State invites you to meet its broad family of UHF Power Amplifier Modules. This complete line covers the 395 MHz to 512 MHz band with three different power levels of 10, 13, and 15 watts.

Consider the economical and technical advantages of IC power modules. They're ready for instant use... designed, developed, pre-tuned and tested... ready to plug them into your system.

## RCA UHF Power Amplifier

Modules incorporate a reliable thin-film technology. And they are designed to meet stringent reliability specs. All modules feature 50-ohm input and output impedance, infinite load-VSWR

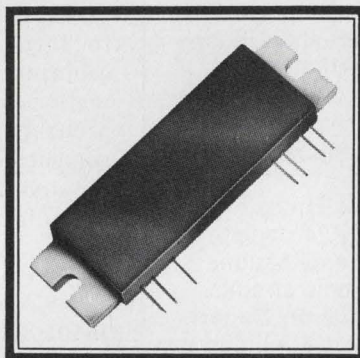

and compact size for high density packaging. Take a look

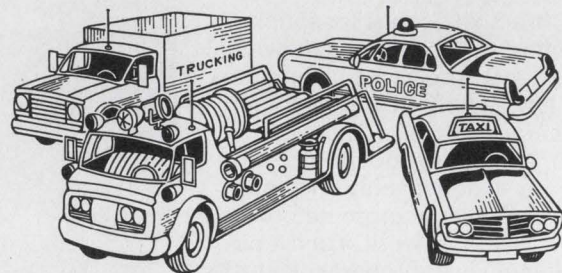

at the variety of modules available to you.

And best of all they are available now... in volume production quantities — at very attractive prices.

So if you have a need for high performance, broad bandwidth UHF Power Modules, come to RCA Solid State — the home of the RF Performance Expanders.

Want more information? Write: RCA Solid State, Section 57A-4 Box 3200, Somerville, N.J. 08876. Or phone: (201) 722-3200.

CHARACTERISTICS	R44M10	R44M13	R44M15	R47M10	R47M13	R47M15	R51M10	R51M12
Frequency Range (MHz)	395-440	395-440	395-440	440-470	440-470	440-470	470-512	470-512
Power Output, Min. (W)	10	13	15	10	13	15	10	12
Supply Voltage, Nom.	12.5	12.5	12.5	12.5	12.5	12.5	12.5	12.5
Power Gain, Min. (dB)	20	20	20	20	20	20	20	20
Overall Efficiency, Min. (%)	35	35	35	35	35	35	35	35

## RCA Solid State family of UHF Power Modules

**RCA Solid State**  
products that make products pay off



# Silicone Protectors

Silicone encapsulating, insulating, sealing, coating and dielectric materials are stocked by Dow Corning distributors at the following **warehouse locations**:

Electrical / electronic materials  
from

## DOW CORNING

DOW CORNING

A-4210

### ALABAMA

#### Birmingham

Electrical Insulation  
Suppliers, Inc.  
205 252-9046

#### Mobile

Brownell Electro, Inc.  
205 479-5405

### ARIZONA

#### Phoenix

Essex International, Inc.—  
I.W.I. Div.  
602 258-4589

#### Scottsdale

E. V. Roberts & Associates,  
Div. EVRA, Inc.  
602 945-2513

### CALIFORNIA

#### Berkeley

C. D. LaMoree Co.  
415 841-0601

#### Culver City

E. V. Roberts & Associates,  
Div. EVRA, Inc.  
213 870-9561

#### Los Angeles

Brownell Electro, Inc.  
213 532-1150

#### Louisville

C. D. LaMoree Co.  
213 225-5666

Essex International, Inc.—  
I.W.I. Div.  
213 264-7000

#### Mountain View

K. R. Anderson Company, Inc.  
415 961-6007

#### San Diego

A. E. Yale Enterprises  
714 296-6148

#### San Francisco

Essex International, Inc.—  
I.W.I. Div.  
415 626-5351

#### Santa Clara

Brownell Electro, Inc.  
408 244-8452

### COLORADO

#### Denver

Waco Electronics, Inc.  
303 371-4370

### FLORIDA

#### Orlando

Brownell Electro, Inc.  
305 843-6770

Electrical Insulation  
Suppliers, Inc.  
305 855-7100

#### Tampa

Essex International, Inc.—  
I.W.I. Div.  
813 245-6821

### GEORGIA

#### Atlanta

Electrical Insulation  
Suppliers, Inc.  
404 355-1651

Essex International, Inc.—  
I.W.I. Div.  
404 691-8520

#### Chamblee

Prehler Electrical Insulation  
404 451-4266

### ILLINOIS

#### Chicago

Essex International, Inc.—  
I.W.I. Div.  
312 254-8787

Prehler Electrical Insulation  
312 384-6100

#### Mt. Prospect

Magnuson Electronics, Inc.  
312 956-0700

### INDIANA

#### Fort Wayne

Essex International, Inc.—  
I.W.I. Div.  
219 742-7441

#### Hammond

Electric Supply Corp.  
219 932-8840;  
312 374-6000 (Chicago)

### IOWA

#### Marion

Enesco Distributing Corporation  
319 377-6313; 800 325-3232

### KANSAS

#### Overland Park

Enesco Distributing Corporation  
913 381-7557; 800 325-3232

### KENTUCKY

#### Louisville

E & H Electric Supply  
502 587-0991

### LOUISIANA

#### Baton Rouge

Essex International, Inc.—  
I.W.I. Div.  
504 927-2686

#### New Orleans

Williamson Distributing Corp.  
504 486-5584

#### Shreveport

Williamson Distributing Corp.  
318 424-6638

### MARYLAND

#### Baltimore

Essex International, Inc.—  
I.W.I. Div.  
301 644-0140

#### Baltimore/Washington

Pyttronic Industries, Inc.  
301 792-7000; 301 953-3000

### MASSACHUSETTS

#### Cambridge

Brownell Electro, Inc.  
617 864-7500

#### Newton

Cramer Electronic, Inc.  
617 969-7700

#### Peabody

Essex International, Inc.—  
I.W.I. Div.  
617 531-7100

### MICHIGAN

#### Detroit

Essex International, Inc.—  
I.W.I. Div.  
313 925-6000

#### Farmington

Sheridan Sales Co.  
313 477-3800

#### Madison Heights

McNaughton-McKay Electric  
313 399-7500

### MINNESOTA

#### St. Paul

Prehler Electrical Insulation  
612 776-1541; 612 776-1542

### MISSOURI

#### No. Kansas City

Essex International, Inc.—  
I.W.I. Div.  
816 842-1613

#### St. Louis

Enesco Distributing Corp.  
314 567-3935;  
TWX 910 764-0856

Essex International, Inc.—  
I.W.I. Div.  
314 371-2616

### NEW JERSEY

#### Livingston

Robert McKeown Co.  
201 992-0700;  
212 267-9264 (NYC);  
516 248-2525 (L.I.)

#### Moonachie

Essex International, Inc.—  
I.W.I. Div.  
201 641-4400;  
212 695-7840 (NYC)

#### North Bergen

EISCO Plus, Inc.  
201 864-2376; 800 631-0830

### NEW MEXICO

#### Albuquerque

Waco Electronics, Inc.  
505 268-2409

### NEW YORK

#### Buffalo

Summit Distributors, Inc.  
716 884-3450

#### New York City

Brownell Electro, Inc.  
212 691-7900

#### Rochester

Summit Electronics of  
Rochester, Inc.  
716 334-8110

### NORTH CAROLINA

#### Charlotte

Brownell Electro, Inc.  
704 399-9791

Electrical Insulation  
Suppliers, Inc.  
704 394-4341

Essex International, Inc.—  
I.W.I. Div.  
704 394-1315

### OHIO

#### Cincinnati

Cramer/Tri States, Inc.  
513 771-6441

Electrical Insulation  
Suppliers, Inc.  
513 771-4073

Essex International, Inc.—  
I.W.I. Div.  
513 771-6500

Sheridan Sales Co.  
513 761-5432

#### Cleveland

Essex International, Inc.—  
I.W.I. Div.  
216 781-2310

Prehler Electrical Insulation  
216 267-2650

### Columbus

McGraw-Edison Co.  
National Electric Coil Division  
614 488-1151

### OKLAHOMA

#### Oklahoma City

Essex International, Inc.—  
I.W.I. Div.  
405 236-5411

### OREGON

#### Portland

Essex International, Inc.—  
I.W.I. Div.  
503 665-0138

C. E. Riggs, Inc.  
503 226-3286

### PENNSYLVANIA

#### Philadelphia

Brownell Electro, Inc.  
215 632-3030

Essex International, Inc.—  
I.W.I. Div.  
215 236-7100

Prehler Electrical Insulation  
215 725-5914; 215 725-5913

Pyttronic Industries, Inc.  
215 643-2850; 215 242-6700

#### Pittsburgh

Essex International, Inc.—  
I.W.I. Div.  
412 242-5560

### TENNESSEE

#### Memphis

Brownell Electro, Inc.  
901 332-9254

Electrical Insulation  
Suppliers, Inc.  
901 947-4176

### TEXAS

#### Dallas

Essex International, Inc.—  
I.W.I. Div.  
214 339-8346

Specialized Products Company  
214 358-4663

Williamson Distributing Corp.  
214 741-5831

#### Houston

Essex International, Inc.—  
I.W.I. Div.  
713 869-3667

Williamson Distributing Corp.  
713 672-1715

### UTAH

#### Salt Lake City

Standard Supply Co.  
801 355-2971

### WASHINGTON

#### Seattle

Atlas Packing & Rubber Co.  
206 623-4697

Essex International, Inc.—  
I.W.I. Div.  
206 763-8650

C. E. Riggs, Inc.  
206 623-5707

### WISCONSIN

#### Milwaukee

Essex International, Inc.—  
I.W.I. Div.  
414 475-6188

Higher component density...

Lower insertion costs...with

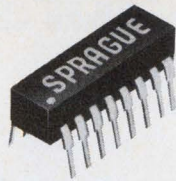

# MULTI-COMP<sup>®</sup> DIP MONOLYTHIC<sup>®</sup> CERAMIC CAPACITORS

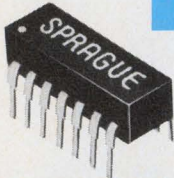

**STANDARDIZED DESIGN\* FOR BETTER AVAILABILITY, BETTER PRICES**

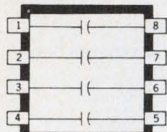

**TYPE 939C**  
(4 capacitor sections)

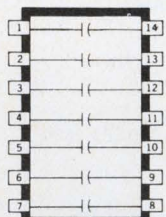

**TYPE 934C**  
(7 capacitor sections)

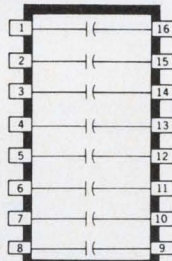

**TYPE 936C**  
(8 capacitor sections)

Compatible with ICs and other standard DIP devices. Especially useful for noise bypassing and signal coupling in high-frequency signal or data processing systems. Molded package provides mechanical protection and reliability under severe environmental conditions. Monolithic<sup>®</sup> construction . . . alternate layers of ceramic dielectric material and metallic electrodes are fired into an almost indestructible homogeneous block. Standard ratings, 18 pF to 0.1 μF @ 100 WVDC. Temperature range, -55C to +70C.

\*Other circuit configurations (including internally-paralleled capacitor sections, commoned capacitor leads, and various ratings within single package) are available on special order.

## Sprague puts more passive component families into dual in-line packages than any other manufacturer:

- TANTALUM CAPACITORS
- CERAMIC CAPACITORS
- TANTALUM-CERAMIC NETWORKS
- RESISTOR-CAPACITOR NETWORKS
- PULSE TRANSFORMERS
- TOROIDAL INDUCTORS
- HYBRID CIRCUITS
- TAPPED DELAY LINES
- SPECIAL COMPONENT COMBINATIONS
- THICK-FILM RESISTOR NETWORKS
- THIN-FILM RESISTOR NETWORKS
- ION-IMPLANTED RESISTOR NETWORKS

For more information on Sprague DIP components, write or call Ed Geissler, Manager, Specialty Components Marketing, Sprague Electric Co., 347 Marshall St., North Adams, Mass. 01247. Tel. 413/664-4411.



THE BROAD-LINE PRODUCER OF ELECTRONIC PARTS

INFORMATION RETRIEVAL NUMBER 11

ACROSS THE DESK  
(continued from page 13)

right on. Each of us must take responsibility for what we do.

You did miss one possibility—that trade magazines should point out the dangers of certain design choices. One example will suffice. The article "Focus on High Temperature Materials" (ED No. 22, Oct. 25, 1973, p. 54) could have pointed out that dust from broken beryllium-oxide washers is 1000 times more dangerous than arsenic.

*Kirtland H. Olson, P.E*

The Harvard Group  
Bolton Rd.  
Harvard, Mass. 01451

## Correction

I enjoyed reading the Idea for Design "Programmable Current Generator has Linear Response and Ignores Power Variations" (ED No. 21, Oct. 11, 1973, p. 120). It's an excellent circuit, but there are two mathematical errors. The first expression should read:

$$I_o = \frac{V_{in} \cdot R_2}{R_1 \cdot R_3} \text{ instead of } \frac{V_{in}/R_1}{R_2 \cdot R_3},$$

and the first term of the third expression should read:

$$\alpha_1 \alpha_2 \frac{V_{in} \cdot R_2}{R_1 \cdot R_3} \text{ instead of}$$

$$\alpha_1 \alpha_2 \frac{V_{in} \cdot R_2}{R_2 \cdot R_3}.$$

*Joseph Gaon*

JMR Electronics Corp.  
1424 Blondell Ave.  
Bronx, N. Y. 10461

## The author replies

Joseph Gaon is right. The three equations should read:

$$I_o = \frac{V_{in} R_2}{R_1 \cdot R_3}$$

$$\frac{R_1 R_3 \left[ V_{cc} - 2 - V_{in(max)} \frac{R_2}{R_1} \right]}{R_2 \cdot V_{in(max)}} \geq R_L$$

$$I_o = \alpha_1 \alpha_2 \frac{V_{in} R_2}{R_1 \cdot R_3} +$$

$$\alpha_2 \frac{R_2}{R_3} I_{CBO(Q1)} + I_{CBO(Q2)}$$

*V. Ramamoorthy*

Indian Scientific Satellite Project  
A 3-6, Peenya Industrial Estate  
Bangalore 560022, India

# 1937-1973



# The Danameter.

## \$195.



### 1 Year Battery Life.

In a digital instrument, you'd expect to fool with a battery regularly, recharging it or replacing it.

Not with The Danameter. The battery will last you at least one year. And even if you find a way to wear it out, you're only talking about 69¢.

### Liquid Crystal Readout.

The specifications on the Danameter show at a glance that this is a more accurate instrument than the one it's designed to replace.



Yet there is another type of inaccuracy The Danameter solves—in an even more dramatic way.

These are the errors that occur every day in reading an analog voltmeter. Scales are hard to separate. Increments of measurement are greatly restricted. Precise readings are difficult to make.

When you measure with The Danameter, you interpret nothing. All you are shown is a number that is precisely the information you require.

It's accurate to a degree that you never imagined possible in an instrument at this price.

Once you have selected the proper function position, The Danameter instantly interprets, selects, and converts your information. It shows in a large liquid crystal display that adjusts to all light conditions. Even direct sunlight.



### Automatic Polarity.

In measuring voltage, you're accustomed to swapping leads to get a reading.

The Danameter instantly determines polarity, and then displays it as either positive or negative. All in a fraction of a second, with no help from you.

### Almost indestructible.

The Danameter has only one function selector. It's recessed behind the molded edges of its cyclac case. You can drop it on concrete. You can kick it down the hall.

When you pick it up, it'll be working perfectly.

It's the first true portable instrument of its kind. For \$195.



# 1974.

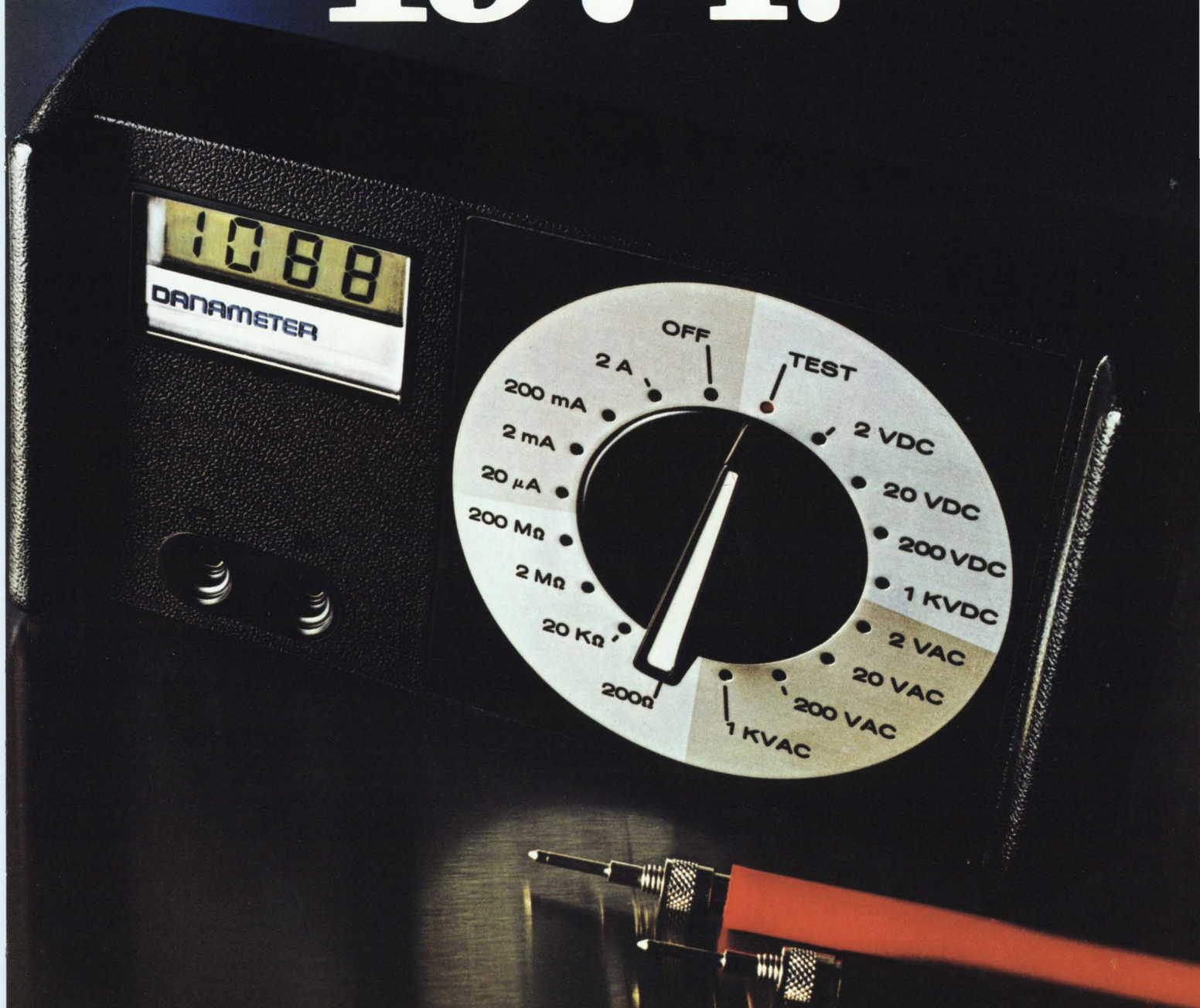

Actual size.

## Model 2000 Danameter Specifications

Warranty: 1 year.

Measurement Functions: (4) DC volts, DC current, AC volts and ohms.

Typical Specifications:	
DC Volts	
Ranges	2V, 20V, 200V, and 1KV
Resolution	1mV
Overload protection	1000V DC or peak AC, any range
Accuracy	±(.5% Rdg. + .05% Range)
Polarity	Automatic
Input Resistance	10 Megohms
Normal mode rejection	50 dB min. at or near 60 Hz

AC Volts	
Ranges	2V, 20V, 200V, and 1KV
Resolution	1mV
Overload protection	1000V peak AC, 250V DC, any range
Accuracy	±(1.5% Rdg. + .15% Range) to 5 KHz
Input Resistance	2 Megohms

DC Current	
Ranges	20 $\mu$ a, 2 mA, 200 mA and 2A
Resolution	.01 $\mu$ a
Accuracy	±(1.5% Rdg. + .1% Range)
Overload protection	250V DC or RMS

OHMS	
Ranges	200 $\Omega$ , 20K $\Omega$ , 2M $\Omega$ and 200M $\Omega$
Resolution	.1 ohm
Accuracy	±(2% Rdg. + .15% Range)
Maximum current through unknown	1 mA
Overload	250V DC or RMS

General	
Battery	One 9V dry battery
Est. battery life	1 year at normal usage
Test leads	Included
Size	4"H x 7 $\frac{1}{4}$ "W x 2 $\frac{1}{4}$ "D
Weight	1 lb.
Overload	Fully protected on all ranges

Price	
Model 2000 Danameter	\$195.00

Accessories	
Part No.	
2040	R.F. Probe (to 200MHz)
2030	H.V. Probe (to 30Kv)
2020	Carrying Case
2060	Extra Test Leads

**Contact your nearest Dana representative.  
Ask him to show you The Danameter.**

Alabama, Huntsville — (205) 534-9771  
 Arizona, Phoenix — (602) 957-9110  
 California, Los Angeles area — (213) 772-7320  
 California, Sunnyvale — (408) 245-3700  
 California, La Jolla — (714) 459-3351  
 Colorado, Denver — (303) 771-0140  
 Connecticut, Hamden — (203) 281-0810  
 Florida, Orlando — (305) 894-4401  
 Illinois, Chicago — (312) 539-4838  
 Indiana, Indianapolis — (317) 253-1681  
 Kansas, Shawnee Mission — (913) 722-1030  
 Maryland, Wheaton — (301) 942-9420  
 Massachusetts, Wakefield — (617) 246-1590  
 Michigan, Farmington — (313) 477-7700  
 Michigan, Kalamazoo — (616) 349-9666  
 Minnesota, Minneapolis — (612) 537-4501  
 Missouri, St. Louis — (314) 567-3636  
 New Jersey, Fort Lee — (201) 224-6911  
 New Mexico, Albuquerque — (505) 255-2330  
 New York, Rochester — (716) 328-2230  
 New York, Vestal — (607) 785-9947  
 New York, Metro New York Area — (516) 487-4949  
 New York, Syracuse — (315) 437-6666  
 North Carolina, Burlington — (919) 227-3630  
 Ohio, Dayton — (513) 278-5873  
 Ohio, Cleveland — (216) 333-5650  
 Ohio, Worthington — (614) 888-4466  
 Oklahoma, Norman — (405) 364-8320  
 Pennsylvania, Pittsburgh — (412) 824-3760  
 Pennsylvania, Blue Bell — (215) 542-1490  
 Texas, Houston — (713) 686-9627  
 Texas, Dallas — (214) 358-4643  
 Texas, San Antonio — (512) 828-0937  
 Utah, Salt Lake City — (801) 272-3861  
 Washington, Seattle — (206) 763-2755  
 Wisconsin, Brookfield — (414) 786-1940

### Canada:

B.C., Vancouver — (604) 732-7317  
 Manitoba, Winnipeg — (204) 475-1732  
 Nova Scotia, Halifax — (902) 455-0670  
 Ontario, Downsview — (416) 638-9218  
 Ontario, Ottawa — (613) 728-4624  
 Quebec, Montreal — (514) 735-4565

### Europe:

B	— Brussels	02-33 96 00
CH	— Mutschellen	05754655
D	— Darmstadt	06151-26661
DK	— Naerum	01-804200
F	— Paris	027 5686
GB	— Luton	582-24236
I	— Milan	02- 4982451
N	— Oslo	02-674590
NL	— Baarn	02154-6110
S	— Solna	820410
SF	— Tapiola	90-460 844



**Dana Laboratories, Inc.,** 2401 Campus Drive, Irvine, California 92664, U.S.A.  
 Telephone (714) 833-1234, Teletype 910-595-1136, Telex 678-341

Other countries: Contact DANALAB INT'L Headquarters 119/121 Rue Anatole France, 1030 Brussels, Tel.: 02-41 45 50/Tlx: 23662

# Most of your design problems can be solved by an unknown.



Put down your pencil. Give the pocket calculator to your kids. Stop waiting in line at the EDP department.

If you've got problems, we've got a solution. The very first and only programmable hand-held micro computer in the world. The CompuCorp Micro Scientist. The professional's machine.

It thinks the way you think. It does stress analyses. Works design problems. Breezes through drafting calculations. Solves systems headaches. Plucks the best engineering solution out of a dozen possibilities.

The Scientist allows you to have two different 80-step programs in memory at the same time. Which means repetitive calculations are a snap. And you can take it wherever you go because it's battery operable.

The CompuCorp Scientist is the first hand-held machine with 13-digit accuracy and a big, bright 10-digit display. And it's the first one with an algebraic keyboard and nested parentheses.

It's also the first one with built-in polar to rectangular; rectangular to polar; trig functions;  $\log_{10}$ ;  $\log_e$ ;  $10^x$  and  $e^x$ . It also handles different forms of angle entry.

You can do register arithmetic in and out of ten storage registers. And you can set the decimal point anywhere you want it and change it whenever you want to.

Get all the facts on CompuCorp Micro Computers. We may be an unknown to you, but we're already solving tough problems for thousands of design engineers around the world.

See your local CompuCorp dealer. Or write Computer Design Corporation, 12401 Olympic Boulevard, Los Angeles, California 90064.



**CompuCorp®**  
**The Unknown Factor in 63 countries.**

INFORMATION RETRIEVAL NUMBER 12





# We make components for guys who can't stand failures.

There's no such thing as a little failure to some guys. Either your system will perform as you designed it, or it won't. Either the right answer comes out or it doesn't. Anything less is too much to bear.

At Corning we make our components as if all your customers were just that demanding. We build an extra measure of performance into everything we make. Because, like you and the guys who use your equipment, we can't stand failures either.

## Some examples:

We make components you can depend on, like our metal film resistors—both standard and flame-proofs. Components like our glass, ceramic and glass/ceramic capacitors. Like our solid tantalum capacitors—hermetic and non-hermetic, polar and non-polar, miniature and microminiature. And like our discrete component networks—available with custom combinations of discrete microminiature resistors, capacitor chips and diodes in a dual in-line package.

## Metal films in particular:

Take our metal film resistors,

for example. They've demonstrated the extremely low failure rate of 0.00013% per 1000 hours, based on approximately one billion unit test hours. This quality is why Corning resistors have been used in high reliability programs such as Minute-man, Safeguard, Mercury, Gemini, Apollo, Mariner and Poseidon, and in virtually every other military program requiring resistors. They're qualified to the new Established Reliability specs, too.

## 100,000 hours without failure:

The following will demonstrate what we mean when we say that our metal film resistors have proven stability: In 1956, Remington Rand Univac Division of Sperry Rand Corporation began testing 1500 Corning N20, 1/2 watt, 1% resistors in a 40°C ambient under various power stressing conditions. Resistance deviations resulting from this program were minimal and unsurpassed in the industry. To confirm the stability characteristics demonstrated in the Remington Rand Univac Test, Corning remounted 600 of the original resistors in a 25°C ambient early in 1962, accu-

mulating more than 100,000 total test hours to date. Not a single unit has exceeded a 2%  $\Delta R$  from initial resistance at time zero!

## Flame proof, too:

Our metal film resistors are available in flame-proof grades, too. Their unique coating precludes flaming. And they're constructed to open under overload—rather than shorting-out as many resistors do—to protect other more expensive parts of your system.

For complete details on our metal film resistors and all of Corning's other extra reliability components, write for our new "General Design Guide" to: Corning Glass Works, Electronic Products Division, Corning, New York 14830.

And for information on availabilities, call your local authorized Corning distributor or D.I.A.L. EEM: (800) 645-9200, toll free. Or in New York state, call collect: (516) 294-0990.

**CORNING**  
ELECTRONICS



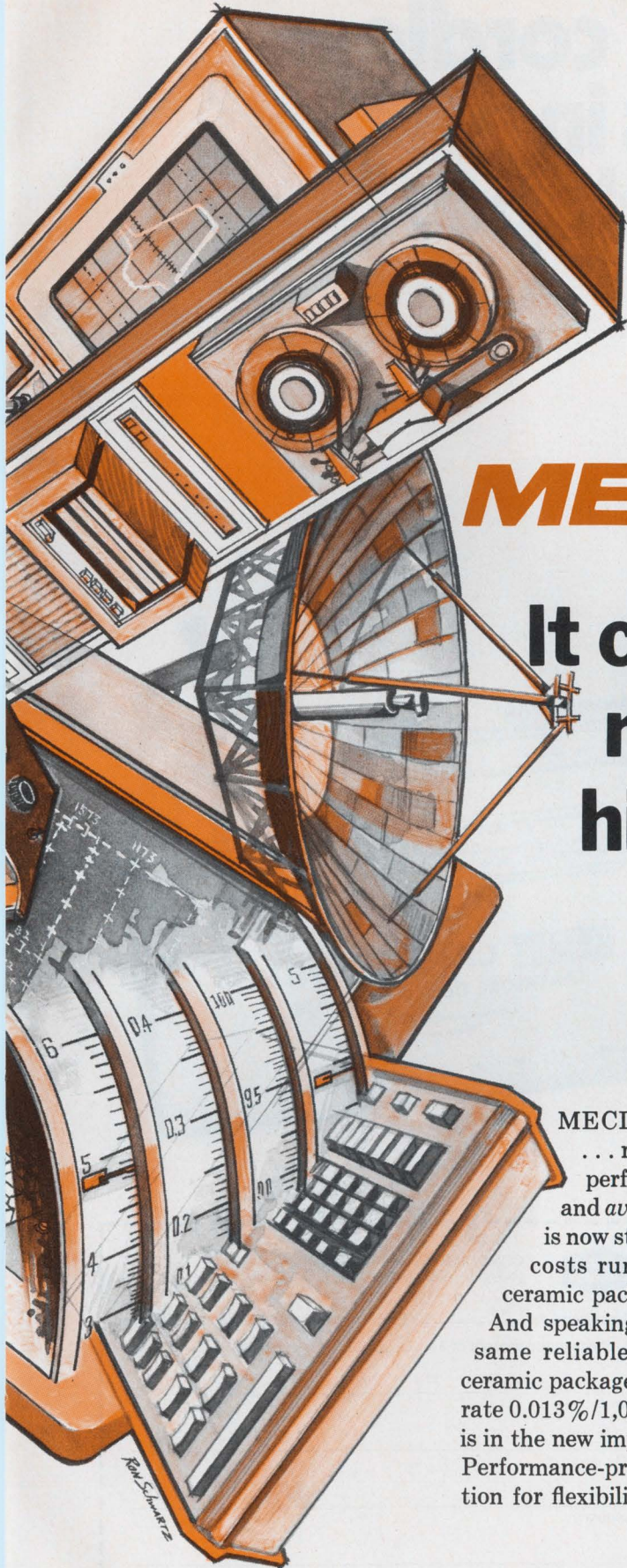

**Run your  
next design  
through plastic**

**MECL 10,000...**

**It could be the most  
reliable, low-cost,  
high-performance  
design you have  
ever achieved!**

MECL 10,000 in plastic . . . reliable . . . low-cost performance-proven . . . and *available*. Plastic 10K is now stocked in depth and costs run 15% lower than ceramic package prices!

And speaking of reliability, the same reliable chip used in the ceramic package (estimated failure rate 0.013%/1,000 hours @ 125°C) is in the new improved plastic case. Performance-proven with a reputation for flexibility, system savings,

and ease of use; MECL 10,000 offers the designer more logic performance for the dollar.

**Get the facts!**

Send for MECL Design File No. 5. It includes latest reliability figures, applications information, and a compilation of devices for your consideration. Write to Motorola Semiconductor Products Inc., P.O. Box 20912, Phoenix, Arizona 85036.

**An evaluation will prove what you can achieve!**



**MOTOROLA MECL**

*... new logic capabilities for the 70's!*

# The new KEMET<sup>®</sup> cordless calculator comes in a plain white envelope.

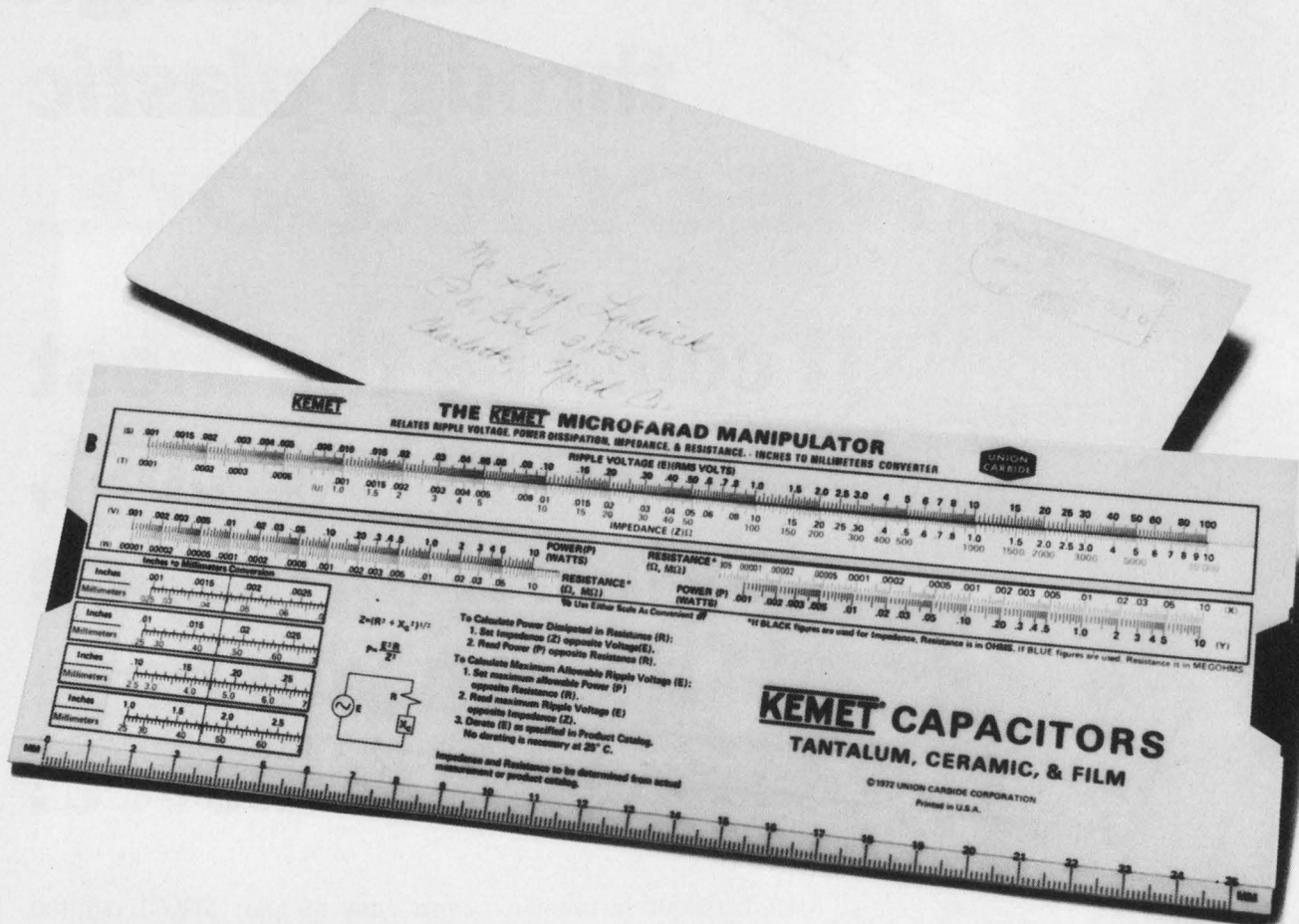

## It's our little secret. But now it can be sold.

Amaze your colleagues!  
End the drudgery of mundane, manual manipulations. In seconds, you can use the speedy KEMET Microfarad Manipulator to simplify capacitor calculations. On one side, the KEMET calculator relates capacitance, reactance, resistance, frequency and dissipation factor. On the other, it relates ripple voltage, power dissipation, impedance and resistance. All this for just a buck!  
(And just to be sure you're getting your money's worth, we even included a sliding Centigrade/Fahrenheit converter (-100°C. to +400°C.), an inch/millimeter converter (.001 to 10 inches), and mm/cm/inch rulers!)  
The supply is limited. Get yours today—ask your local KEMET distributor, or send coupon now!



COMPONENTS DEPARTMENT  
P.O. Box 5928, Greenville, S.C. 29606

Please send me \_\_\_\_\_ KEMET calculators @ \$1 each, postpaid.  
My check in the amount of \$ \_\_\_\_\_ \* is enclosed.

\_\_\_\_\_  
Name

\_\_\_\_\_  
Title

\_\_\_\_\_  
Company

\_\_\_\_\_  
Address

\_\_\_\_\_  
City

\_\_\_\_\_  
State

\_\_\_\_\_  
Zip

Allow three weeks for delivery.  
\*South Carolina residents add 4% sales tax.

# Maddox Speaks.

## DAC's make the difference in displays.

Some really *clear, sharp* pictures are being generated for demanding computer CRT Display jobs like Air Traffic Control, Avionic Heads-Up, and others.

To get sharp, clean output on high speed X-Y deflection displays you have to start with good spot definition and intensity and then drive it with a clean deflection signal. And that's where high-speed display DAC's come in.

### Here's how.

Display DAC's convert digital position commands to analog voltage levels which will position the spot on the CRT face. New commands are usually clocked in at a steady update rate. The spot is positioned to the start of a line or character and then moved by progressive commands to draw the line.

If the DAC's behave, all is well, but often lines wiggle, and show intensity variations.

### Who's the culprit?

*Glitch*, (transient *spike* or bump in the DAC output) and *differential non-linearity*, (a wrong size step in a series of steps).

Display DAC's are "de-glitched" to achieve very low output glitch values, and are designed to have damn good differential linearity.

### How to define spec limits?

First, determine maximum allowable glitch voltage as measured through a test filter which simulates your deflection circuit's passband. The test filter is the key. You can even lump together the effects of glitch and differential non-linearity. Then, ramping the DAC and comparing its band-limited output to an

ideal ramp, you can check the errors. And after limits are set for intensity variation and wiggle, you can graphically arrive at ramp error limits for the DAC's.

### Among other things.

You can also have an inherent lack of line fidelity due to the staircase-like DAC output. Smaller steps through greater DAC resolution will help. But beware, for the limits of maximum available update rate and minimum picture refresh rate set a resolution limit for line drawing. We can show you some filter techniques that can improve ramp fidelity by 10 to 1 or more, solving this staircase problem.

Settling is really important, too, and long settling tails must be absent so that line starting points will land where you planned.

Things like large-signal settling time, slew rate, zero offset, large scale linearity, and scale factor can normally be obtained much better than available deflection circuits, so use care; don't over-specify the DAC's. Save yourself some money.

### Talk to the experts.

There are a lot more parameters to be considered in specifying high-speed display DAC's, so if you are into this, or going to be, probably the best approach is to consult us. After all, we have standard products such as our 12 or 13 bit DAC's (Models 4014 and 4017), and a lot of display knowledge and real experience. We've built and shipped more high-speed display DAC's than anybody else in the world.

Give us a call, toll-free at (800) 225-7883, in Massachusetts, call collect (617) 329-1600, or write us, Dedham, Massachusetts 02026.

 **TELEDYNE  
PHILBRICK**

INFORMATION RETRIEVAL NUMBER 16

Ed Maddox, Sr. Engineer



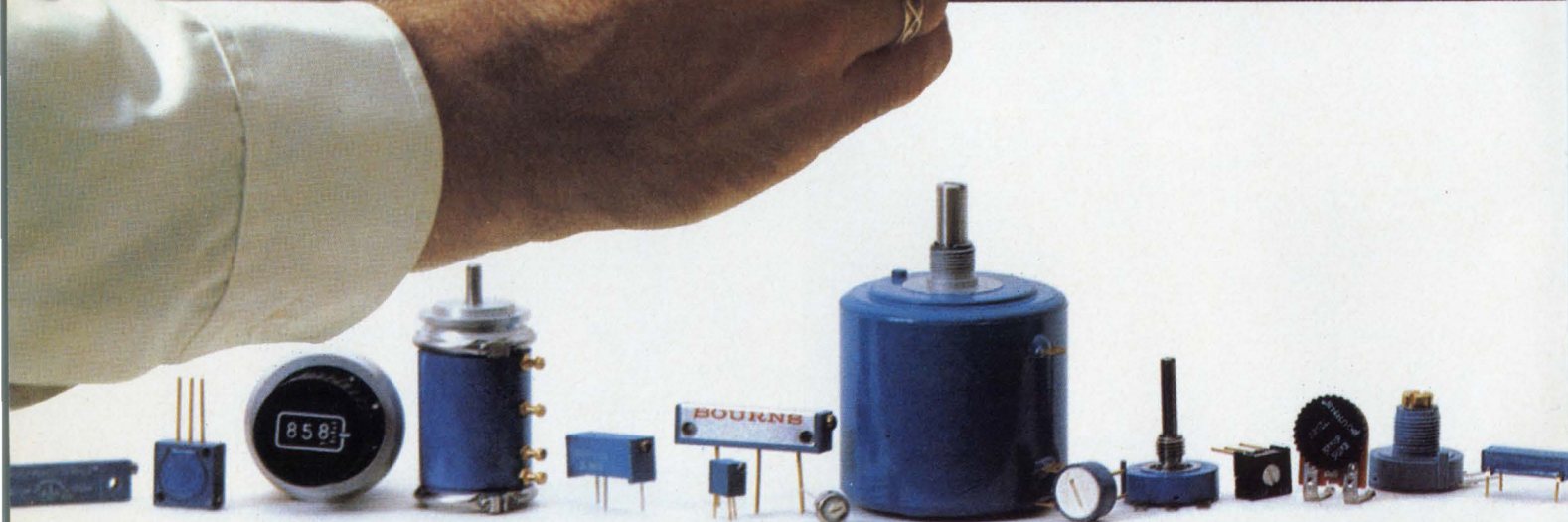

# Who has the broadest line of Potentiometers?

It stands to reason that we wouldn't ask the headline question unless we were certain of the answer.

And we are. Unquestionably, the answer is **BOURNS**

Compare catalogs if you like. You'll find over 12,000 model/terminal/resistance combinations offered in our **TRIMMER POTENTIOMETER** section. Single-turn and multi-turn . . . round, square and rectangular — BOURNS has them all, in wirewound or cermet models.

No need to look elsewhere for a complete line of **PRECISION POTENTIOMETERS**. Check the precision section of the Bourns catalog. Over 20 different standard bushing mount models are displayed, including the unique **KNOBPOT®** integral dial/potentiometer family. If you have servo-mount requirements, or need "something special" . . . our fully staffed custom design and manufacturing organization is at your service. Promptly.

More? You bet.

Bourns popular "SPACE SAVER" line of cermet **CONTROLS** are finding wide acceptance in cost-conscious consumer and industrial applications. You can expect to see exciting developments in this line.

Our cermet and composition open frame **VARIABLE RESISTORS** are super for budget PC board applications. They're priced as low as 10¢ in production quantities. They're from Bourns, so you can count on cost-effective quality and service . . . even at such low prices.

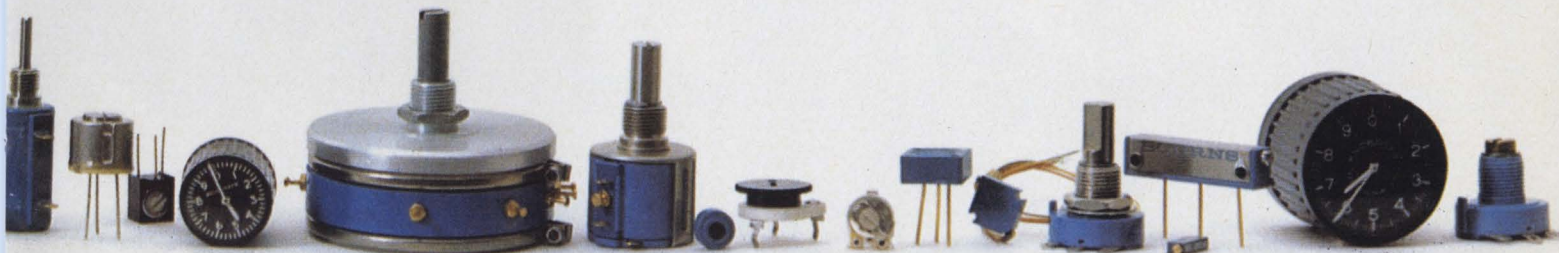

*When you think of variable resistive components . . . look no farther than your Bourns Master Catalog. It's your supermarket of quality, cost-effective resistive components.*



TRIMPOT PRODUCTS DIVISION • 1200 COLUMBIA AVE., RIVERSIDE, CALIF. 92507

In the look-alike world  
of variable resistors,  
Allen-Bradley's MOD POT<sup>™</sup>  
stands squarely alone

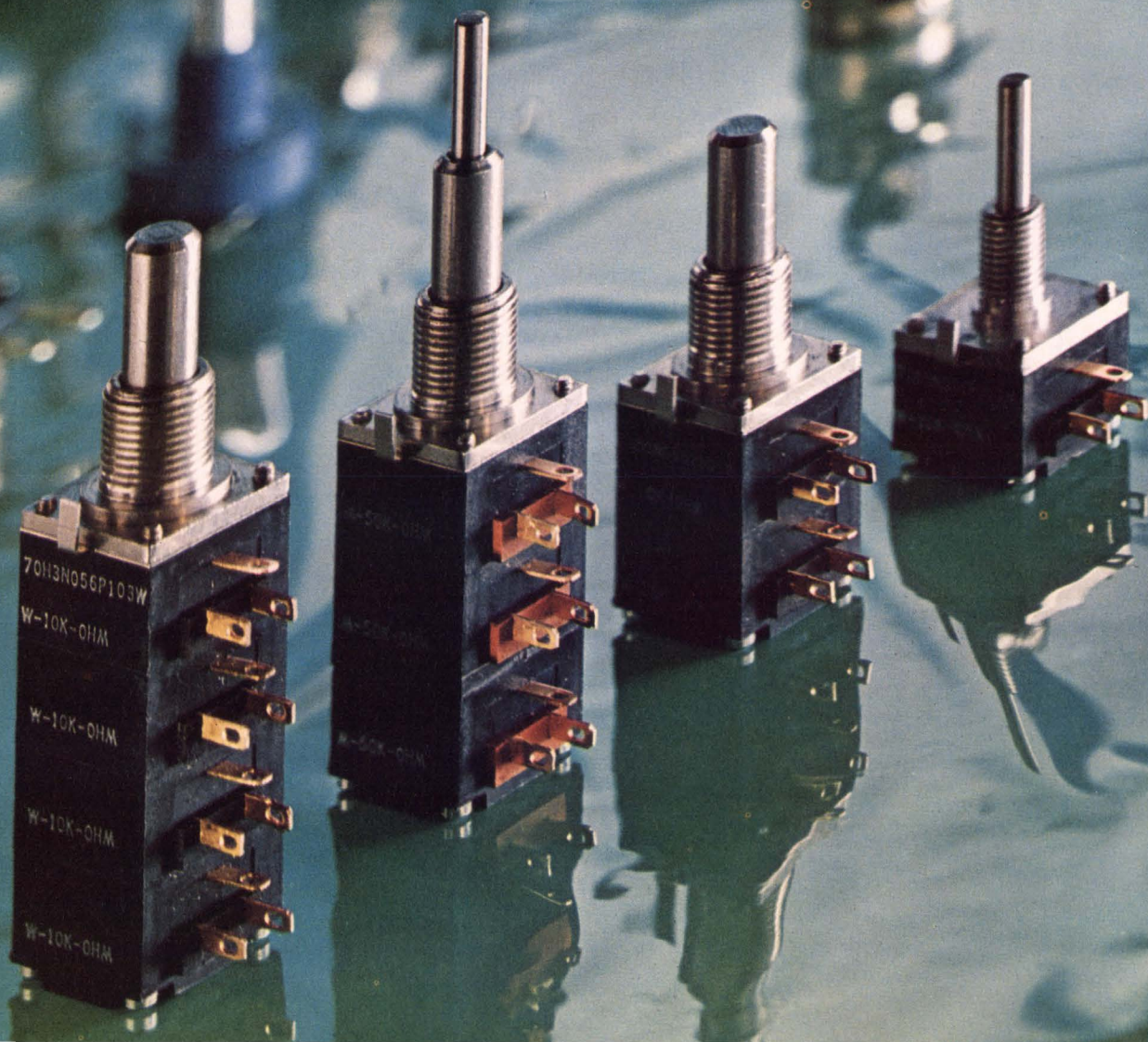



# MOD POT: the most versatile 5/8" square potentiometer available today.

One family of modular potentiometer elements that can be combined in millions of ways to form single, dual, triple or quadruple section controls. MOD POT offers hot-molded composition or cermet resistance elements. Single or concentric shafts. Vernier

drives. Switch modules. Solder lug or PC board pin terminals. And the modules are standard.

**Let your design creativity soar.** The best part about MOD POT is the freedom you gain. Feel free to combine functions in an individual control without paying the whopping "specials" premium. Lick your panel space problems. And, you don't have to wait for "custom made" delivery.

**Availability as close as your Allen-Bradley distributor.** We've factory trained eight distributors to assemble MOD POT combinations. Order as many as you need. Ones... twos...

or in quantity. Our eight distributors' MOD POT ACTION CENTERS are trained, equipped and stocked to move fast when called. Traditional quality. Unique MOD POT versatility. Off-the-shelf delivery speed.

**Brief specs.** Linear carbon composition elements from 50 ohms to 10 megs, non-linear tapers from 250 ohms to 10 megs and cermet elements from 100 ohms to 1 meg. Ample selection of standard shaft lengths and diameters with plain, slotted or flatted endings. Several standard bushings in plain or shaft-lock styles. Push-pull, momentary or rotary switches.



## MOD POT ACTION CENTERS

### CALIFORNIA

Los Angeles  
Kierulff Electronics, Inc.  
Mountain View  
Elmar Electronics, Inc.

### ILLINOIS

Chicago  
Newark Electronics Corp.

### MASSACHUSETTS

Newton  
Cramer Electronics, Inc.

### NEW YORK

Westbury  
Schweber Electronics

### PENNSYLVANIA

Philadelphia  
Almo Electronics Corp.

### TEXAS

Dallas  
Solid State Electronics Co. of Texas  
Houston  
Harrison Equipment Co. Inc.

### UNITED KINGDOM

Jarrow  
Allen-Bradley Electronics, Ltd.



# ALLEN-BRADLEY

Milwaukee, Wisconsin 53204

**Send  
for your  
FREE parts kit  
today!**

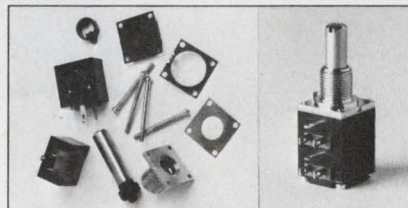

Test your mechanical skill and discover MOD POT versatility. See if you can assemble a complete dual-section MOD POT. Instructions (in case you get stuck) and technical literature will be enclosed. Offer is limited.

**Mail coupon to:**

Allen-Bradley, Electronics Division  
Milwaukee, WI 53204  
Attn: Larry Beverung

**Or:**

Allen-Bradley Electronics, Limited  
Jarrow, Co. Durham  
England NE32 3EN  
Attn: John Corner

**I'll take the MOD POT challenge. Send a free parts kit to:**

Name: \_\_\_\_\_

Title: \_\_\_\_\_

Company: \_\_\_\_\_

Street: \_\_\_\_\_

City: \_\_\_\_\_

State or Country: \_\_\_\_\_ Zip \_\_\_\_\_

# Here's A Great Way To Make Waves- And Save Money.

With One

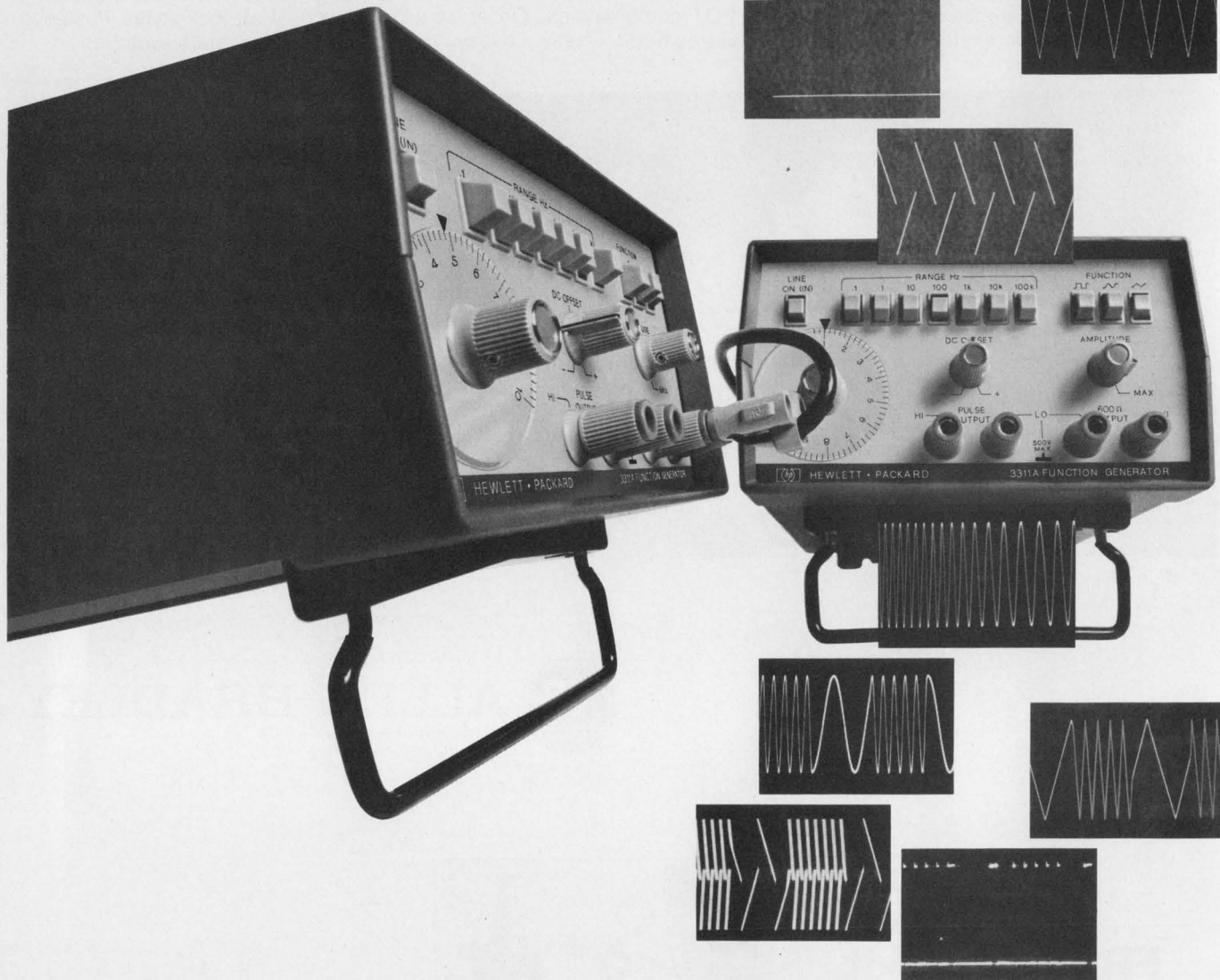

Sine Waves. Square waves. Triangular waves. You get them all — from 0.1Hz to 1MHz — with our new 3311A Function Generator. It gives you both dc offset and external sweep capabilities, and even lets you sum the square- and triangular-wave outputs. But there's another reason why the 3311A is making such a splash — it sells for only \$249.\*

Use the separate pulse output to provide current sinking for up to

20 TTL loads. It has a 15% duty cycle, and 25nsec rise time. That's a lot of versatility for \$249.\*

At that price you can afford to put two 3311A's together and do even more...Then you can sweep the outputs. Or frequency shift key the sine- or triangular-wave outputs or even their sum. You'll get full 10V p-p over the 3311A's frequency range. And dc offset is continuously variable from -5 to +5V into 600 ohms. Applying an exter-

nal 0 to 10V dc will give a 10 to 1 shift in frequency.

\*Domestic USA prices only.

**For New Standards  
In Signal Sources,  
Think HP.**

HEWLETT  PACKARD

Sales, Service and support in 172 centers in 65 countries. Palo Alto, California 94303. Offices in principal cities throughout the U.S.

INFORMATION RETRIEVAL NUMBER 19

ELECTRONIC DESIGN 1, January 4, 1974

# ELDEC has custom low voltage power supplies for the designer who knows what he needs but can't find it.

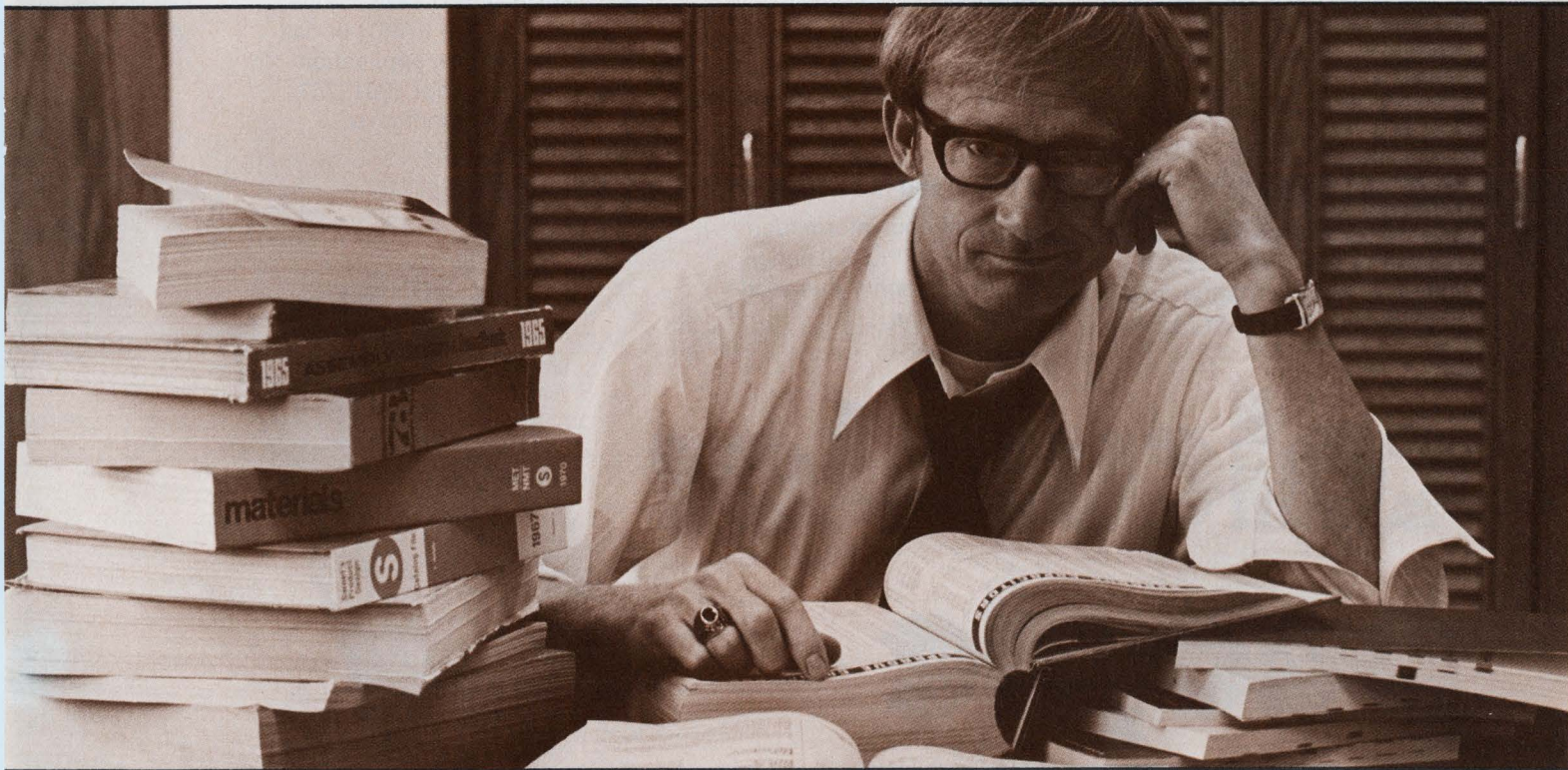

When you need a multi-output power supply that has to meet stringent size and weight criteria, and has to perform reliably day in and day out, turn to ELDEC, not your catalog sources.

Chances are you won't find an off-the-shelf model to do the job. ELDEC specializes in custom designed low voltage power supplies. Has for over 10 years. And they're reliable. ELDEC low voltage power supplies have been delivering top performance in tactical military aircraft under tough conditions for years.

Our state-of-the-art, high technology is available to tackle your most demanding power supply problems. ELDEC takes pride in supplying the smallest size, lowest weight power supplies available. You spec it, we'll design, build, and deliver it. When you need it.

ELDEC power supplies use advanced switching regulator and modular packaging techniques to achieve superior power output to volume density ratios. A supply doesn't go out the door unless it meets EMI specifications.

ELDEC delivers. No gap between promises and prototype. Plenty of back-up and documentation. A prestigious customer list. Get all the facts.

Call or write me, Kevin Hall, Marketing Manager,  
ELDEC Corporation, 16700 - 13th Ave. W.,  
Lynnwood, Washington 98036,  
phone (206) 743-1313.



*Formerly Electro Development Corporation*

# it's easy to see...

Thanks to large, sharp, clear characters, and uniform brightness, the PANAPLEX™ II panel display is the first choice of calculator users. The soft, orange-red neon glow is easy on the eyes, yet bright enough to be viewed comfortably in brightly lit offices.

Manufacturers find that calculators using PANAPLEX II panel displays sell better; and at the same time, PANAPLEX II

panels offer low cost drive circuitry and low-power consumption.

Most significant, the uniquely simple single envelope construction of PANAPLEX II panel displays offers premium reliability at the best price per digit . . . now and in the future!

For additional information about PANAPLEX II panels and how to solve your read-out problems,

write to Burroughs Corporation, Electronic Components Division, P.O. Box 1226, Plainfield, New Jersey 07061; or call our special sales/application assistance number, (201) 757-3400. Our representative will show you why . . .



# calculator people prefer

# PANAPLEX™ II

PANEL DISPLAYS



ACTUAL SIZE

BR09250M



Burroughs



## Industrial systems makers gear for a prosperous '74

Despite all the unknowns that lie in wait for industry in 1974—energy-related shortages, high prices, fears of a recession—manufacturers of industrial electronic equipment remain optimistic.

For one thing, they see little chance for any sudden braking of capital spending in the nation. Outlays for expanded plants and equipment by the 1000 largest manufacturers in the U.S. reached \$11-billion in the third quarter of 1973, according to The Conference Board, a nonprofit research organization. This was a rise of 56% over the third quarter of the year before, and economists say the momentum it touched off cannot realistically be halted abruptly.

For another thing, some electronic manufacturers are planning to capitalize on causes like the energy shortage. Honeywell's chairman, James H. Binger, for example says: "We hope to be part of the solution [to the energy problem] rather than part of the problem."

Honeywell expects to increase production of the following: automatic heating-control systems that are said to "conserve more fuel than traditional thermostats do"; computer-controlled automation systems for large buildings; and precise ship-positioning equipment that can permit offshore oil and mining operations to go beyond the Continental Shelf in water depths of more than 1500 feet.

Computerized numerical control (CNC), which caught on so well in 1973, is expected to do even better in '74, according to L. O. Rexrode, marketing services manager of the Allen Bradley Systems Div. in Highland Heights, Ohio.

"People have learned how to use CNC and, also, the cost is down—mainly due to the lower cost of minicomputers," Rexrode says.

Hard-wired controls for small

machines—two-axis lathes and three-axis mills—are expected to hold their own. "The price is right," Rexrode says, "although the customer wants more and more capability for the same money." Allen Bradley, is, therefore, adding memory to hard-wired control.

The result is that simple hard-wired controls are becoming more sophisticated and the more complex CNC is getting cheaper. "Maybe one day they'll meet," Rexrode says. Meanwhile each has a good market.

Computerized manufacturing—the ultimate, an automatic factory—is also expected to gain more ground this year. Allen Bradley is having success in promoting computerization in small and medium-sized shops on a piecemeal basis. "Without shutting down an entire plant, we recommend computerizing one operation and letting the customer get used to that before going on," Rexrode says.

Programmable controllers caught on two years ago and are still going strong. Competition is keen, however, and to keep prices down, Rexrode notes, "we've had to structure a product line with a wide range of capabilities."

"This way we can give a customer exactly what he wants and no more," he observed. "It's the 'more' that he doesn't need that runs the cost up."

Lasers will continue to crop up in new areas. They are already established as handy and accurate measuring sticks in the construction and other industries. They have made their debut in point-of-sale systems. And this year a laser prototype will probably be built to control nuclear fusion for energy. Less dramatic, though no less profitable, a laser prototype may also be built this year for a home video recorder playback device.

Westinghouse expects the energy crisis to boost sales in uninter-

rupted power supplies as real-time backups for systems that can't afford interruption, such as computers. "A UPS won't save energy, but it will even out the highs and lows in brownout conditions," says Robert A. Morgan, marketing manager for the company's industrial Systems Div. in Buffalo, N.Y.

The microprocessor, or computer-on-a-chip, should continue to make inroads into many industrial applications this year. The companies building them—mainly semiconductor houses in the memory MOS end of the business—will seek to create more markets for the devices—speeds should approach those of conventional minicomputers.

Last year microprocessors were capable of approximately one-fifth the speed of minicomputers. By the end of this year, according to one expert in the field, "you'll be able to buy, in small quantities, microprocessors with speeds directly equivalent to the best iron minicomputers on the market."

### Electronics for cars? It's only the beginning

It's generally agreed that the automobile is a veritable new world for the electronics industry to explore and move into. That high-pitched buzz on the seat belt is just the beginning.

Future jobs for electronics will be described at the IEEE Solid-State Circuits Council conference, to be held in Philadelphia Feb. 13 to 15. The session is called "Automotive Electronics Revisited," and it will be moderated by Will Steffe, manager of design and development of the analog products group of Fairchild Semiconductor in Mountain View, Calif.

Steffe foresees work on car-warning systems that give advance notice of failure and on devices that interact directly with the engine. Besides the work already done on electronic fuel injection, he says, parallel work will continue on the carburetor to improve its performance. This will involve electronic pressure sensors and air flow sensors for data to be digested by a minicomputer or a microprocessor—probably the latter, Steffe believes.

An electronic ignition system in thick-film hybrid form will be described by F. F. Jaumot Jr. of the General Motors Delco Electronics Div., Kokomo, Ind. This system or its forerunner will go into General Motors' future cars.

As for spark-advance systems—will electronic techniques be as cost effective as the mechanical approach now used? The answer to this is still not clear.

What's going to happen to the compulsory seat belt? "It will certainly stay for another year or so," Steffe says. "And whether the air bag takes over then or not is anybody's guess. Legislation, of course, enters into that."

Fuel-injection systems have moved on from discrete components to ICs, Steffe says. The system uses approximately eight IC chips, assembled in hybrid form.

A number of components have become fairly standard in the automotive line, Steffe says. They include tachometer circuits to sense the speed of a car and put it into electrical inputs, modifiers, computing oscillators and a special family of operational amplifiers and comparators.

## Laser-reader sorts baggage for airline

Airline baggage is sorted by a laser-reader system as the baggage moves along a conveyor belt at Eastern Airlines' new terminal at Miami International Airport.

The system, designed by Bendix Recognition Systems, Farmington, Mich., was developed to reduce the number of lost or misrouted bags and to lower baggage-handling costs. Industry sources estimate that close to two million pieces of air luggage annually in the United States do not reach their proper destination.

The key element of the laser-reading is a 5-3/4-inch, adhesive-backed label that contains a circular 10-bit code. A principal problem—how to get enough information on a label small enough to be practical—was solved by designing the label as a split bull's-eye, with five white and black rings containing the 10-bit code, according to Ronald M. Centner, product director at Bendix.

The label is produced on a specially developed Bendix printer by an attendant at each of 26 baggage check-in points at the Miami terminal. The flight number and destination are entered on a printed keyboard, and the coded label is produced in five seconds. A conventional baggage-handling strip label is produced in the same operation.

The coded label is pressed onto one side of the baggage, which is turned on its slide on the conveyor belt. The baggage tag is read as the baggage passes under the laser scanner/reader, which is mounted over the conveyor belt. The scanner makes 480 laser-beam scans per second across the width of the belt. At a maximum belt speed of 300 feet per minute, the label is scanned six to eight times. The system logic requires that the data from three successive line scans be identical for the reading to be valid.

The tag information is fed to a computer, which verifies the flight number and destination of the baggage. The baggage is then routed, by a timing system, to a conveyor spur line leading to the proper baggage-loading area.

The laser reader has a depth of field that permits it to read labels that are plus or minus a foot from a reference reading distance of 30 inches, thus providing for a wide range of baggage thickness. In addition the reader is optically designed to identify labels that may be misaligned by as much as plus or minus 20 degrees from the plane of the conveyor belt.

## Ceramic disc memory undergoing tests

A prototype of a ceramic disc memory is being tested at St. Florian Co. in Phoenix, Ariz. Such a memory is said to operate over a wider temperature range and to be more rugged and moisture-resistant than conventional disc memories.

The new memory uses a free-floating, self-aligning, machined ceramic disc that rides on air bearings. The disc is mounted between a pair of fixed ceramic head frames. In operation the disc is suspended by the air bearings. When landing, the disc contacts the head frames. The heads never

touch the recording surface, which is protected by 10-to-20-microinch ridges on the edge of the disc.

St. Florian's president, Harold R. Klievoneit, says: "We have subjected our prototype to 400-g shock in an iron oxide and dust environment with no apparent harm to the memory."

The ceramic disc was made possible by a new machine developed by the company called a radio surface finisher. This machine permits the disc and head frame to be machined to a flatness of 20 to 30 microinches.

## Amorphous memories ordered by Burroughs

In a move that may signal the long-awaited acceptance of amorphous memories by computer manufacturers, the Burroughs Corp., Detroit, has awarded a \$304,000 contract to Energy Conversion Devices for the development of faster and denser amorphous memories.

Current amorphous devices have a speed of about 500 ns and a density of 1000 bits per chip. It is apparent from Energy Conversion Devices' RM 256 memory, however, that the read speed could be increased to 40 ns. In addition the company has demonstrated—at last year's NEREM Conference in Boston—that it is possible to fabricate an amorphous memory with a density as high as 4096 bits per chip.

Burroughs is not commenting on what size chip is under development, but the prospects are that it will probably be a 2048 or 4096-bit device.

## A power-supply boom linked to computers

A doubling of power-supply sales to the data-processing industry—to a billion dollars by 1980—is forecast by Dr. John Salzer of Darling & Alsobrook in Los Angeles.

In a study called "Power Supply: A Technology, Systems Design and Market Assessment," the market-researcher predicts that small-computer manufacturers will be among the fastest-growing power-supply users.

# The first interactive graphic calculator.

## Just \$7500.

### It's the 31/10 system.

A powerful calculator, graphic terminal and software combination. The first ever to place math-power, graphics and alphanumeric display at your fingertips!

**The 31/10 is personal.** Fast. And highly interactive. It lets you explore ideas and concepts on the spot. Plot single variable functions, specify X-Y coordinates and a lot more. Corrections and plot changes are immediate. From data entry to display, your ideas are quickly brought to light. That's responsive!

**Plug in our software packages.** They put the 31/10 to work. No heavy programming experience

needed. So you can deal in your concepts and not the mechanics of programming. And get graphic and alphanumeric output from natural math input.

**There's more to our 31/10.** Such as add-on memories for long programs. The optional silent thermal printer for listing and keeping track.

Peripherals like our hard copy unit to put in hand what's on the screen.

The costs are low, the results are priceless.

Get the facts about the 31/10 and the Tektronix reliability and worldwide service behind it. See your Tektronix sales engineer for a demonstration or write:

Dwain Quandt,  
IDD Calculators, Tektronix, Inc.,  
P. O. Box 500,  
Beaverton, Oregon 97005.

**Our programmable calculators. Natural. Powerful. Significantly less expensive.**



**TEKTRONIX®**

INFORMATION RETRIEVAL NUMBER 22



# New **TY-RAP**<sup>®</sup> Tool completes one million ties every month

Triggered 70,000 times each day without a misfire!

As you read this message, the production model of this pneumatic hand tool, TR-225, is continuing its life cycle test... 1,000,000 cycles per month without a falter.

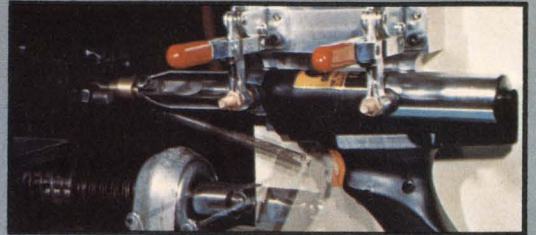

This 20 ounce tool ties wire bundles from 1/16" to 4" diameter with just about every regular and "Slim Line" type TY-RAP<sup>®</sup> cable tie... 16 sizes in all. It reduces operator fatigue... and is particularly well suited for close-up work, break-out points and tying in confined places in equipment.

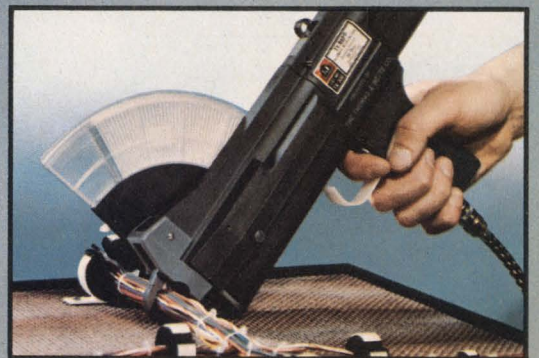
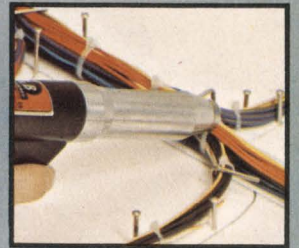

Our other new production tool, the high speed TR-300, automatically positions a TY-RAP tie around bundle, cinches to a preset tension, locks tie securely and trims evenly... all in 8/10 of a second... and on bundle diameters ranging from 1/32" to 5/8".

Write for new catalog. The Thomas & Betts Co., Elizabeth, New Jersey 07207, (201) 354-4321. In Canada, Thomas & Betts Ltd., P.W.

**Sold Only Through Authorized T&B Distributors**



## **THOMAS & BETTS**

Division of Thomas & Betts Corporation



# Tooling Technology Offers Systems Approach to Production Wiring

With over 14 years of experience plus the world's largest team of wire tying and harnessing specialists T&B has developed a systems approach to wiring that makes harnessing a cost-controlled proposition.

Part of the "systems" approach is the new TR-225 tool which reduces operator fatigue through the use of pneumatic operation. Of particular note is the rugged construction, providing reliable performance in a production environment . . . (the tool has been cycled 1,000,000 times per month without a falter). It is light weight and human engineered for both men and women operators. The tool accommodates the majority of TY-RAP® tie sizes . . . 16 in all . . . with bundle ranges from 1/16" to 4". A further convenience for the operator is that the long narrow nose gets into confined areas easily. If your production volume is such that it does not require the exclusive use of the TR-225 perhaps the new WT-193 hand tool would supplement your operation.

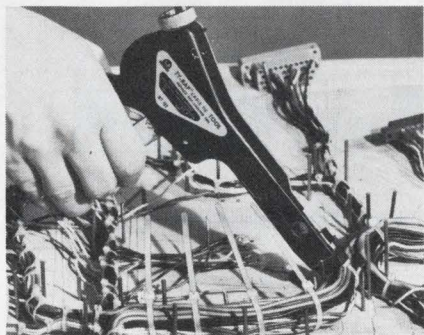

This tool accommodates the same bundle range as the TR-225. With a similar narrow nose and long barrel, it is well suited for close-up work, breakout points and in tough to reach places. This particular design gives the operator the convenience of a long tying stroke with one squeeze of the trigger . . . the tie is cinched to a preset tension and trimmed flush with the head. The speed of tying is good for smaller volume tying as compared to the pneumatic TR-225.

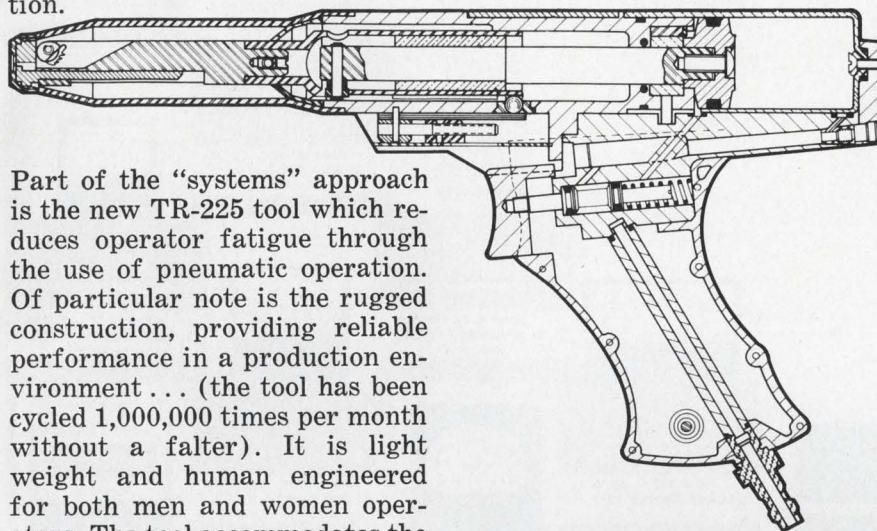

If an evaluation of your tying requirements reveals a high volume of tying bundles in 1/16" to 5/8" diameter, consideration of our new automatic production tool (TR-300) would be wise.



Used in conjunction with our complete series of harnessing aids (routing clamps, corner posts, breakout springs) wires are routed with few nails to facilitate both fabrication and tying.

With good harness board preparation, the TR-300 can offer 4-5 times quicker installation than hand tying. This tool slides a TY-RAP tie under and around the bundle, cinches it to a preset tension, locks it and trims it flush with the head . . . all in 8/10 of a second.

Our harnessing specialists will review your tying operation and recommend appropriate tooling.

INFORMATION RETRIEVAL NUMBER 23

Another TY-RAP product which facilitates harness fabrication is the new harness board. Set-up costs just about disappear when you adapt this board into your present operation. It is a fully reusable modular board that can be enlarged by snapping the interlocking panels together. Metal screening covers the self-healing polyethylene foam center. Both sides can be used. The harnessing aids are installed easily since standard nails are pushed into the board by hand. Cat. No. HBF-02-03.

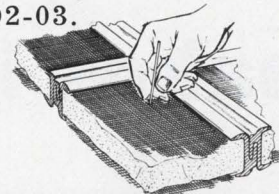

One of the most important considerations in using plastic ties is the reliability of the tie's locking device. Only TY-RAP self-locking ties have a patented, non-magnetic, stainless steel,

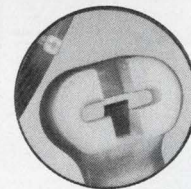

locking wedge embedded in the cable tie head. You get a grip of steel every time with TY-RAP self-locking ties.

The TY-RAP system was developed by T&B to answer all types of production wiring and harness fabricating needs whether large volume or small. Your production rates, system flow and total installed costs are major concerns of ours. In our evaluations of harness fabricating techniques used across the country, operator performance, fatigue factors and process convenience appeared as major considerations in the cost structure of harnessing. Our harnessing specialists are equipped to study these costs as well as all pertinent factors involved in your wiring and harnessing operations. Write or call us today.

The Thomas & Betts Co., Elizabeth, New Jersey 07207, (201) 354-4321. In Canada, Thomas & Betts Ltd., P.Q.

529

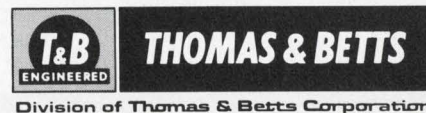

# if it's a meter or meter relay,

Stock or Special...

# Simpson

# makes it.

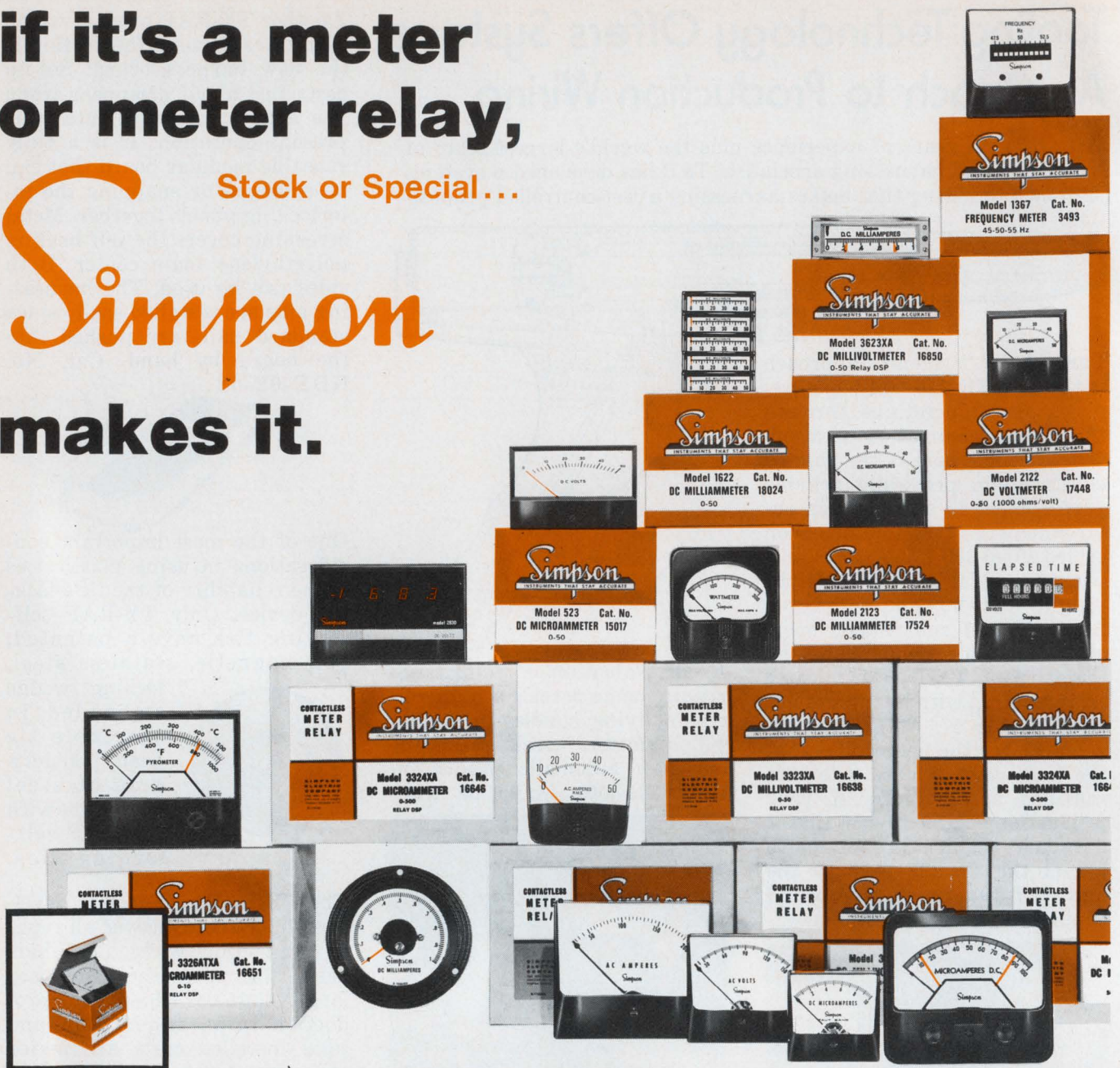

## Stock:

Simpson distributors nationwide stock over 1,500 types, ranges, styles and sizes of panel meters, relays and controllers. They're all listed in Catalog 4200. Write for your free copy.

## Special:

Need a special or unusual meter? Let Simpson help you custom design it. Send us your specs and we'll send you a quote. But check our catalog first—that "special" may be a standard Simpson stock item.

Get off-the-shelf delivery from your local electronics distributor.



### SIMPSON ELECTRIC COMPANY

853 Dundee Avenue, Elgin, Illinois 60120  
(312) 695-1121 • Cable: SIMELCO • Telex: 72-2416

IN CANADA: Bach-Simpson, Ltd., London, Ontario

IN ENGLAND: Bach-Simpson (U.K.) Limited, Wadebridge, Cornwall

IN INDIA: Ruttonsha-Simpson Private, Ltd., Vikhroli, Bombay

KATY INDUSTRIES



ELECTRICAL EQUIPMENT GROUP

# Who's afraid of Augat?

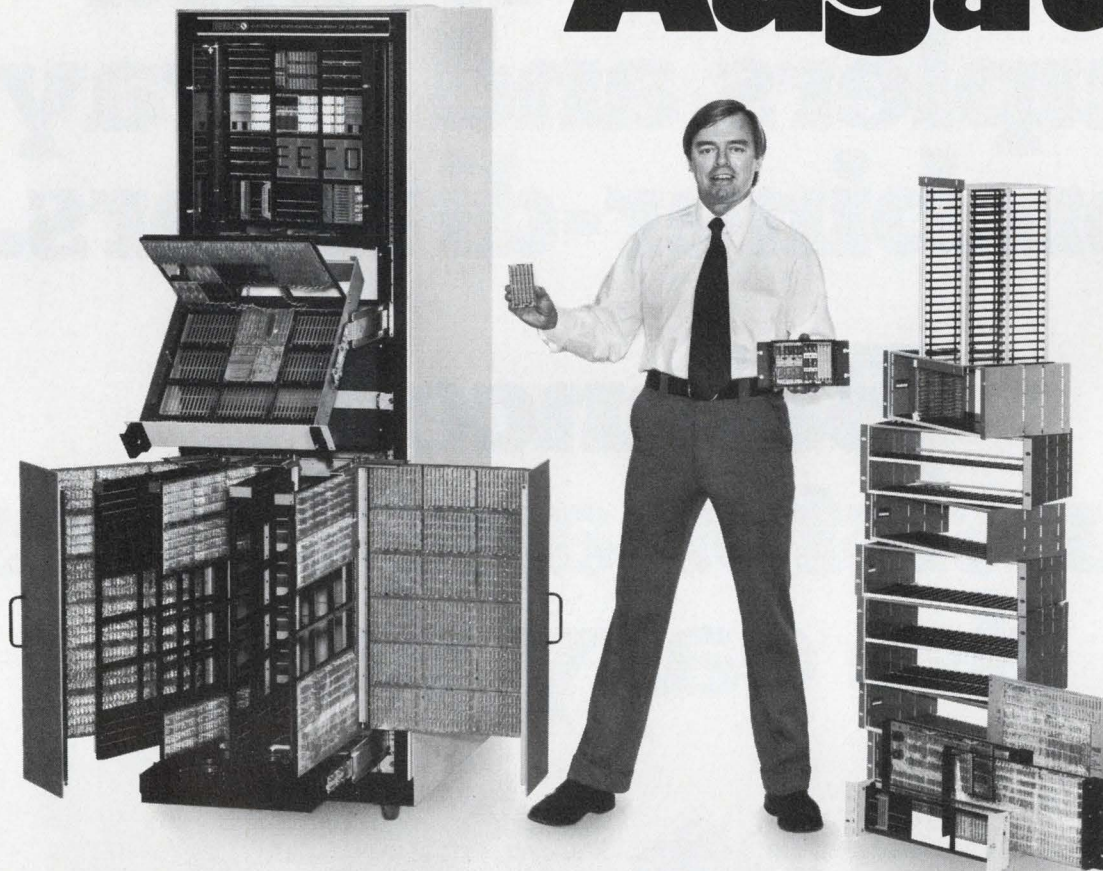

What's Augat got that we don't? Size? Momentum? Identity? As far as we can tell, that's it.

Because we've got socket boards with better packaging density. Better plug-in hardware. More versatility. Faster delivery. And lower price. Not to mention our own wiring service.

And we've got more card file, frame and drawer options and combinations than anybody else in the industry.

We're not afraid of Augat. So you don't have to be afraid of us.

Try us. We'll see you through.

## EECO

1441 East Chestnut Avenue  
Santa Ana, California 92701  
Phone 714/835-6000  
Also from G. S. Marshall Company nationwide.

FREE SOCKET BOARD AND PACKAGING  
HARDWARE CATALOG!  
We'll send it to you if you'll send us the  
information below.

Name \_\_\_\_\_

Position \_\_\_\_\_

Company \_\_\_\_\_

Address \_\_\_\_\_

# Anaren's ultra-miniature 3 dB 90° hybrid couplers and 4-way combiner-dividers.

## Balanced transistor amplifiers, the easy way.

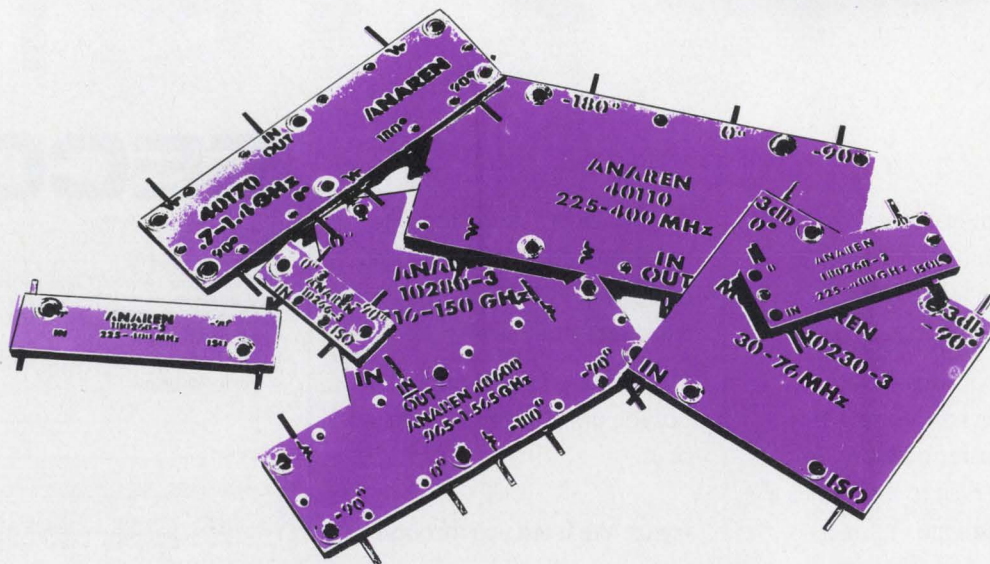

Take two of our ultra-miniature 3 dB 90° hybrid couplers. And two RF power transistors (with their low, complex input impedances.) Put them together and you've got an octave bandwidth high power amplifier module. With good input and output match. And good phase and amplitude characteristics.

Four transistors? Combine them with two of our ultra-miniature 4-way combiner-dividers. Or combine two two-transistor amplifier modules with two more couplers.

Or for an eight-transistor amplifier, combine four two-transistor amplifier modules with two 4-way combiner-dividers.

**30 MHz to 4.2 GHz, we've got what you need.**

We make more than 40 ultra-miniature 3 dB 90° hybrid couplers in octave and wider bandwidths. And 10 ultra-miniature 4-way combiner-dividers.

They're stripline, of course. In aluminum cases less than an eighth-of-an-inch thick. With solder tabs for easy installation in your microstrip circuit.

And with the specs you'd expect from Anaren.

**Especially 225-400 MHz.**

We make more than a dozen 225-400 MHz ultra-miniature 3 dB 90° hybrid couplers.

Electrically, they're pretty much the same. Typical specifications are: isolation, 25 dB; insertion loss, less than 0.25 dB; VSWR, 1.1; phase balance,  $\pm 1.5^\circ$ ; amplitude balance,  $\pm 0.5$  dB.

But mechanically, you've got quite a choice. With more than a dozen different configurations to choose from, we've probably got a layout to match your layout.

And we've got a 225-400 MHz ultra-miniature 4-way combiner-divider, too.

**Call (315) 476-7901.**

For complete electrical and mechanical specifications, application information and technical notes on our ultra-miniature 3 dB 90° hybrid couplers and 4-way combiner-dividers, contact your Anaren technical representative.

Or call Applications Engineering at Anaren Microwave, Inc., 185 Ainsley Drive, Syracuse, New York 13205.

We know what you need.

# Anaren

INFORMATION RETRIEVAL NUMBER 27

## HOW 1974 IS SHAPING UP

# With new car, TV and power applications, semiconductor makers see no end to boom

**Jules H. Gilder**  
Associate Editor

Despite the energy crisis—or perhaps even because of it—the semiconductor industry is looking for another boom year.

Fears that the energy shortage would result in a drop in semiconductor sales are being countered by predictions of new markets and the speeding of plans to use semiconductors in new applications. Some of these include:

- Earlier implementation of electronic fuel injection in automobiles.
- An increase in television sales and consequently production.
- The use of microprocessors to control power distribution.
- Increased use of CMOS.

### Automotive market looks rosy

An ELECTRONIC DESIGN survey of semiconductor manufacturers supplying automotive electronic components reveals considerable activity in this area in the last few weeks.

"A lot of projects are coming off the back burner," notes Gene Carter, director of marketing for National Semiconductor's Microcircuits Div., Santa Clara, Calif. One of these projects, he continues, is electronic fuel injection. The reason for the accelerated interest in electronic fuel injection is that it would make the gas guzzlers—big cars that are more profitable for the auto manufacturers—more competitive with compacts. The efficiency of the engine would be increased, and the big cars would get more miles to the gallon.

Electronic fuel injection was originally scheduled to be introduced in the 1977 model year. Now

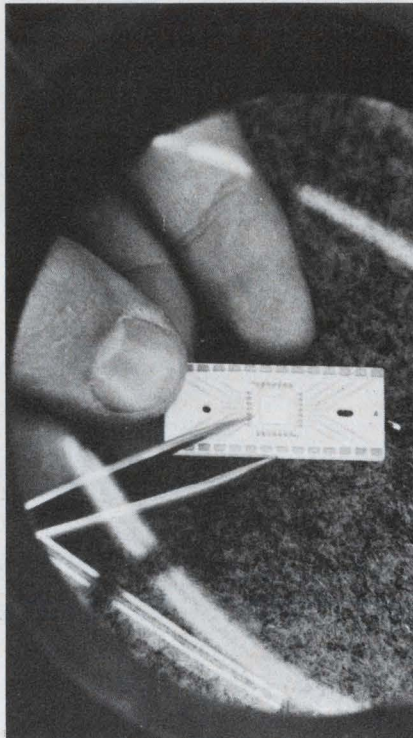

**A silicon-on-sapphire, n-channel integrated circuit is the heart of a minicomputer from General Automation, called the LSI-12/16.**

efforts are under way to introduce it in 1976 or maybe even 1975. Carter admits, however, that 1975 introduction is a slim prospect.

David West, marketing manager for Mostek in Carrollton, Tex., also sees good growth for automotive electronics this year. If people do switch to smaller cars, he notes, they will have more money to spend on accessories, most of which require electronics. Also, with people more fuel conscious, there could be a big market for electronic miles-per-gallon indicators, West says.

Carter also notes that a direct result of the fuel shortage could be an increase in the demand for

color TVs. If people can't drive on Sundays, he continues, they'll be watching more television. And if they watch more television, there will be a greater demand for the new solid-state color sets, he maintains. Television manufacturers such as RCA and Zenith agree.

### Microprocessors are promising

Another area that Carter feels will benefit from the energy shortage is the microprocessor. "There has been talk recently of putting microprocessors on power poles, where the local transformers are located, to control the distribution of power to residential areas," Carter says. Such an application would open a tremendous new market for microprocessors.

Richard Konrad, director of standard product marketing for American Microsystems, Inc., Santa Clara, Calif., also sees a big future for microprocessors this year. With them and other complex LSI functions, it is now possible to attack the TTL-MSI market, he says.

Explaining further, Konrad notes that it is now possible to build a family of about 15 LSI devices—including the processor, RAMs, ROMs, pROMs, registers, FIFOs and UARTs—that can attack the core of the \$350-million TTL market. "With such a family of devices, you can cover all the digital functions you see in any system," he says.

This trend will definitely set in this year, Konrad continues, and if second-source talks that American Microsystems is holding are successful, it will happen early in the year.

The old bipolar-MOS battle,

which has been raging in the memory area, appears headed for the microprocessor area as well. According to Gene Selvin, director of marketing for Raytheon Semiconductor, Mountain View, Calif., high-speed, low-power microprocessors will make their debut in mid-year. Raytheon, reports Selvin, is using its V-ATE isolation process to produce 16 and 32-bit bipolar microprocessors that have access times as low as 200 ns. Other manufacturers said to have a bipolar effort going are Signetics and Monolithic Memories.

### A shot in the arm for CMOS

Most semiconductor manufacturers questioned by ELECTRONIC DESIGN said that the nation's power problems would hasten the conversion of many designs to CMOS. James Dykes, vice president of Harris Semiconductor, Melbourne, Fla., says it will be a strong year for CMOS. He sees it taking over a significant portion of the MOS market, with sales going as high as \$30-million.

As for technological develop-

ments in CMOS this year, Robert Dotty, vice president of product development for Rockwell International, Anaheim, Calif., says that in the next three or four months a 1-k CMOS/SOS RAM with an access time of about 50  $\mu$ s will appear. This device, Dotty reports, will compete, not with MOS devices but with bipolar devices, because of its high speed. In addition it has a simpler process and higher yield than bipolar, and it consumes substantially less power.

Another CMOS development this year will be the completion of a single-chip electronic watch circuit, according to American Microsystems. Konrad says the new chip is being built with a silicon gate process and will replace the two-chip sets now being used. It is intended for applications that require liquid-crystal displays.

### Refinements in production due

In memories this year the emphasis appears to be centering on overcoming production problems. Rockwell's Dotty notes that many manufacturers have had problems

with n-channel, silicon-gate technology—they have been plagued by n-channel leakage. But this problem should be overcome this year, he says, as manufacturers learn to exercise stricter control of the surface between the oxide and the silicon.

West at Mostek also sees this year as one for emphasis on production, and he notes that the 4-k RAM will become widely available.

Harris' Dykes sees an improvement in the availability of bipolar 1-k RAMs and 4-k ROMs.

In charge-coupled devices, Dykes sees the availability of 8-k and 16-k disc replacement memories by the end of the year.

Rockwell's Dotty sees 4-k MNOS electrically alterable ROMs becoming available by the middle of the year.

In the more exotic bubble technology, Dotty looks for the first products to appear, but only by the middle of 1975. These, he says, will be mass-storage devices that would replace head-per-track disc systems. They will feature faster access time and will be competitively priced, he says. ■■

## Smarter, handier and smaller instruments will appear as unexplored markets open up

**Stanley Runyon**  
Associate Editor

Despite shortages in components and materials, despite the energy crisis and despite concern over the economy in 1974, instrument makers are going full-steam ahead with new-product planning. You can expect to see these major trends in new hardware in the months ahead:

- Smart instruments—those that hook-up to or use buried ROMs, minicomputers, microprocessors or calculators—will become more prolific and more intelligent.

- Synergistic instruments—machines that combine more than one function in one package—will be in the limelight more and more, and they will begin to move into the low-priced range.

- Shrinking instruments—smaller in cost, size, weight and power

consumption—will get smaller.

- Dedicated machines—those designed specifically to do just one task—will continue to take jobs away from the general-purpose instrument.

- All types of instruments will continue to mushroom into the still virginal consumer and commercial markets—the transportation industry, for example.

- Automatic test equipment and communications equipment will be two of the strongest growth areas for instruments this year.

### Smarter and smarter

Only a ripple in the ocean of test equipment last year, the smart instrument seems destined to be the tidal wave of the future. And no wonder.

By building in a memory, mini-

computer or microprocessor, or by providing for external connection to a computer or calculator, manufacturers can turn out intelligent test equipment that not only makes measurements but also chews up the measured information, analyzes and manipulates it, and makes necessary decisions.

Says William Walker, vice president of engineering at Tektronix, Inc., Beaverton, Ore. "It's almost foreordained that microprocessors, which are getting enormously powerful, are going to be built in whenever you have a dedicated job—such as fast Fourier transforms—or where you want to make fast or frequent measurements."

Walker says that we'll see more instruments like Tektronix' recently introduced digital processing oscilloscope and the company's

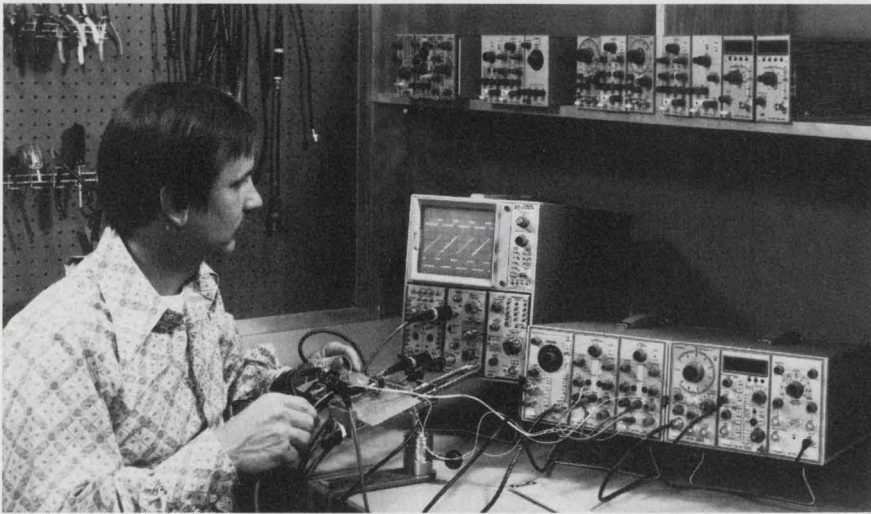

A leading example of synergistic instrumentation is the Tektronix TM 500—a modular system of counters, DVMs, signal sources and other instruments that share a common enclosure, power supply and other circuit elements.

transient digitizer—a smart machine that grabs a 10-ns event, digitizes it and then spits out an analysis of the transient's components.

Two others who look for significant growth in smart instruments this year are Hal McAleer, vice president of engineering at General Radio, Bolton, Conn., and Jerry Froland, vice president of John Fluke Manufacturing Co., Seattle, Wash.

Froland says to watch for instruments that receive data and then make a decision for the operator, while McAleer ties smart equipment to an increased use of the turnkey approach to measurements: Just hit the button and walk away.

For example, says McAleer, component testers are becoming smarter and more nearly turnkeys—the tester not only makes the basic measurement but decides to what category the component belongs, outputs signals to energize automatic sorting systems and prints out results.

In general, McAleer sees a three-tiered trend in new instrument design: instruments that initially solve problems with a purely software approach but eventually are redesigned to do the same job with hardware or—because of microprocessors—firmware.

"We haven't begun to tap the power of software yet," McAleer asserts, "and because the magic of software opens up the entire world of mathematics, we can solve

Fourier transforms and microwave equations, and can do all kinds of signal analysis and data compression. "We're going to see a lot more of that."

Al Oliverio, Hewlett-Packard's marketing manager for the Electronic Products Group in Palo Alto, Calif., reports that HP is also working on smart instruments—ones that are easier to use. He sees electronic counters joining the trend.

A growing part of HP's R&D, Oliverio says, involves instruments that can talk to one another and to computers or desk-top calculators.

### Shaky marriages?

Unlike Walker and McAleer—who see a trend toward multiple, or combined, instruments within one panel—Oliverio tends to discount this as an idea in which it's easy to end up with a solution for which there's no problem.

But such instruments as Systron-Donner's Versatester—a combination digital multimeter, signal source and power supply—are popping out of development labs in increasing numbers.

And, says Ed Niebuhr, marketing manager for Systron-Donner's Instrument Group, Concord, Calif., "We have several other thoughts in mind in the general area of multiple, low-cost instruments."

One thing that practically all instrument makers agree on is that the stirrings felt last year in new,

low-cost instruments will become strong and insistent this year. Price drops can generally be traced to the increased use of both custom and standard MSI/LSI chips, which also let a designer drastically slash instrument size.

### More for less

Perhaps more significant, a designer using MSI/LSI can pack more functions into a given space and still keep the cost reasonable.

Thus you can expect to see more miniature instruments, like the hand-held DMM unveiled by HP last year. At the same time look for test equipment to give more measuring power per dollar than ever. And look also for narrow-minded test equipment. More than ever, manufacturers are zeroing in on their customer's specific needs and coming up with special-purpose, narrow-use products. Examples of such instruments, given by McAleer, are noise-exposure meters used by the Federal Office of Safety and Health Administration, engine testers and modem testers.

Systron-Donner's Niebuhr says there's a sizable demand for special-purpose test sets for field use. Systron will be devoting more energy to determining customer requirements in these areas.

Automatic test equipment is expected to be a hot growth area this year for practically all instrument makers. Look for new and improved network analyzers, board testers, logic and analog analyzers.

What other new instruments will appear?

- From Tektronix, new, miniature 5, 8 or 10-MHz scopes to fill holes in the company's TM 500 modular instrument systems.

- From Systron-Donner, new developments in microwave counters and frequency synthesizers, and also in spectrum analyzers and wideband sweepers.

- From General Radio, automatic test equipment and network analyzers, as well as higher frequencies in the company's synthesizer line.

- From Hewlett-Packard—with the company spending 10% of its shipment dollars on R&D—new products across the entire measuring line. Watch especially for new counters, calculators and digital logic analyzers. ■■



# MONO-KAP™

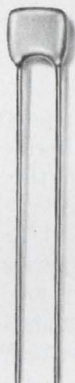

**RADIAL LEADED  
MONOLITHIC CAPACITOR**

Underneath its epoxy coating, it's got a chip for a heart — a USCC/Centralab ceramic chip capacitor, 100% monolithic construction. Solid reliability for business machines, computer and communications use; rugged enough to meet mil-spec requirements yet priced for commercial applications.

Capacitance from 4.7 pF to 10 Mfd, working voltages 50 to 200 VDC and a variety of dielectric characteristics.

Best of all — AVAILABLE. USCC has recently improved chip capacitor deliveries . . . now radial leaded

Mono-Kaps are available in as little as 12 weeks for non-stock items.

Remember. USCC/Centralab or your local Centralab industrial distributor.

We deliver.



**USCC/Centralab**

Electronics Division ■ Globe-Union, Inc.



2151 North Lincoln Street ■ Burbank, California 91504  
(213) 843-4222 ■ TWX: 910-498-2222

INFORMATION RETRIEVAL NUMBER 28

# Minis and mini peripherals will lean more on LSI, and software will be easier to use

David N. Kaye  
Senior Western Editor

Large-scale integrated circuits made great inroads in minicomputers and minicomputer peripheral devices last year. In 1974 this trend is expected to accelerate.

Following the lead of Computer Automation, Irvine, Calif., which introduced the Naked Mini/LSI last year, General Automation of Anaheim, Calif., has stepped in with the LSI-12/16. This is the first minicomputer central-processing unit to be implemented with an n-channel, silicon-on-sapphire LSI circuit. The LSI-12/16 is a replacement for the older SPC-12, a process-control mini. The LSI-12/16 has an 8-bit word length, a 2.64- $\mu$ s instruction cycle time and sells, in large quantities, for about \$1000 with 4 k of semiconductor memory.

Andrew Knowles, a vice president of Digital Equipment Corp. in Maynard, Mass., looks for much tighter package densities and much more use of LSI in this year's mini collection. He does, though, add this word of caution: "With the energy crisis, integrated-circuit manufacturers may be squeezed a bit by shortages of petrochemicals. This will lead them to emphasize standard high-volume products and to shy away from custom LSI products."

The lower yields of custom circuitry cause more material wastage than when high-yield standard products are used, Knowles explains.

Many in the minicomputer industry expect that the major strides will be in the development of easy-to-use software for minis already on the market. Particular emphasis will be on more efficient compilers and operating systems. Knowles, among others, notes that disc operating systems will become better and much more widely used.

Major new-product developments in the minicomputer industry are being made either on the low end



Disc-operating systems, such as this one with a Hewlett-Packard 2100 minicomputer, are expected to be used more in 1974.

of the price and performance spectrum or on the high end. Not much is happening in the middle. Low-end developments are oriented toward using LSI to build a compact, medium-performance computer for a very low price. On the high end, the emphasis is on memory-management techniques. High-end users are calling for ever greater memory capacity. With techniques such as memory mapping and virtual memory, memory capacities on the order of 256 k words are being achieved.

## Rise of floppy discs seen

"IBM has put its blessing on flexible discs," says Robert Koontz, engineering manager for magnetic products at Perdec Corp., Chatsworth, Calif. "They will be cost-competitive with tape cassettes and cartridges with better performance. I believe that they are going to be a major force in mini peripherals in 1974."

Many manufacturers are now starting to produce a variety of floppy, or flexible, discs. The me-

dium that most have chosen is the IBM Diskette, a thin disc about the size of a 45-rpm phonograph record. The magnetic head rides in contact with the surface of the disc. Typical capacity of a floppy disc is 1 to 2 Mb. Prices of the drives are under \$1000.

Everett Turner, systems marketing manager at Iomec in Santa Clara, Calif., sees a major advance in cartridge disc drives for minis. "Many manufacturers will finally be able to deliver the long promised, 200-track-per-inch top and front loading drives," he says. These drives usually contain a fixed disc as well as the replaceable cartridge, and they offer a capacity of 96 Mb.

Koontz at Perdec also looks to drives with multiple fixed discs and possibly a greater bit density than the present drives on the market.

In half-inch magnetic-tape drives, Koontz notes that IBM instigated a move to a bit density of 6250 bpi from the present 1600. He feels that most manufacturers will introduce 6250-bpi drives in 1974.

Digital cassette drives are expected to continue to carve out a notch in the program-loading and paper-tape replacement markets. These drives should become more reliable and lower in cost.

Paper-tape drives meanwhile continue to move away from capstan drives and toward stepper-motor drives for lower cost, while maintaining high performance.

Printers are being designed with more and more LSI. As the costs of the electronic content continue to come down, the price of minicomputer printers should continue to come down. Serial and line printers at less than \$4000, with speeds of up to 300 lpm, will be delivered in 1974 in large quantities.

"Because of the paper shortage," says Irving L. Weisman, vice president of product development

# Up here, a five-year warranty isn't much of a comfort.

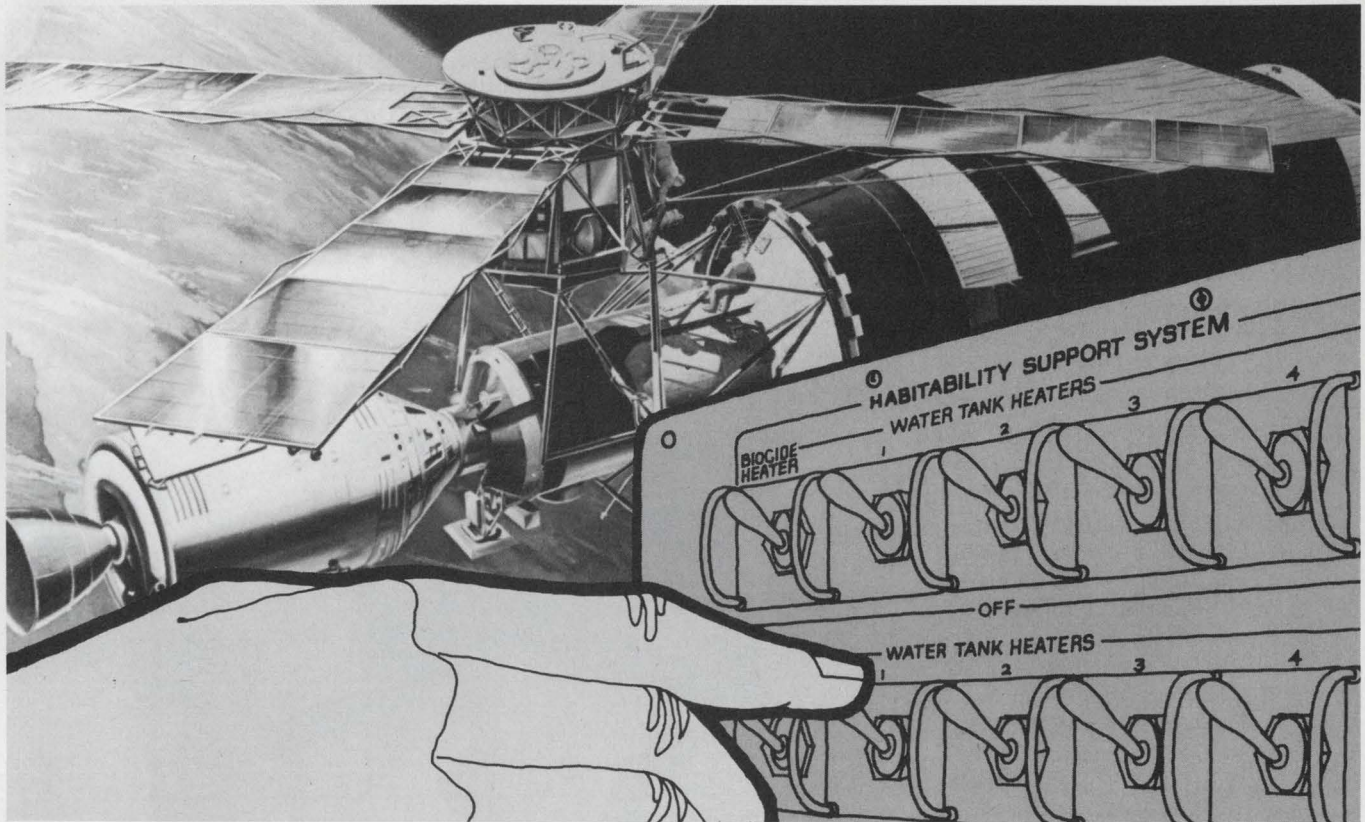

## Or is it?

We're happy to say that the several hundred Heinemann circuit breakers aboard Skylab have done what they were meant to do: protect valuable circuits.

With all of Skylab's electrical problems, it's been crucial that our circuit breakers function consistently to their exact specifications. And they have.

Of course, every Heinemann subminiature circuit breaker aboard Skylab is protected by our traditional five year warranty. But if one should fail, would the astronauts be able to send it back to New Jersey for a free replacement? Would they *care* about a free replacement?

Such questions point up an interesting fact. Though free replacement is important, it's the length of the warranty that indicates how well a product will stand up to unpredictable hardships of actual use. (If our breakers went around developing bad habits after a month, a year,

or a couple of years in service, would we be able to cover every single one with a musclebound five-year warranty? The only such warranty in the business?)

Our warranty, then, does more than protect you against an unexplainable quirk after a few years' use. It suggests how extremely unlikely such occurrences are. And that reliability is precisely why Heinemann was asked to supply every breaker on Skylab.

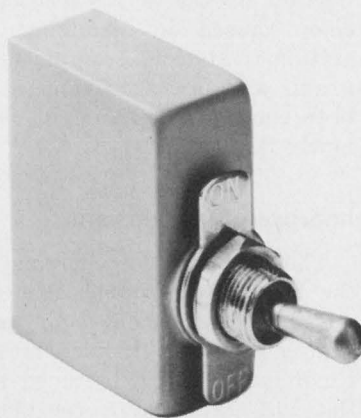

Heinemann Series HE and SM subminiature hydraulic-magnetic circuit breakers have been aerospace-qualified since the first Gemini flight back in 1963. That's a record we're justifiably proud of. But most of our subminiature breakers are sold to other fields which, like aerospace, require extreme ruggedness and durability, environmental resistance, compactness and lightweight, and versatility through a full spectrum of time delays and special-function internal circuits.

These ingeniously compact little breakers are offered in one-, two-, and three-pole models in current ratings from 0.050 to 35 amp. Full technical particulars, including a complete listing of Mil-C-39019 and other compliances, are included in our new Bulletin HE-3504, yours for the asking. Heinemann Electric Company, Trenton, N.J. 08602.



## HEINEMANN

for Data Products Corp., Woodland Hills, Calif., "the printer industry may move from the standard format of 10 characters per inch to either 15 or even 20 cpi. In addition we may go from the standard vertical format of 6 or 8 lines per inch to 10 or more lines per inch, with a compact font."

Intelligent terminals will be used much more widely this year than heretofore, according to Knowles of Digital Equipment. "It is a terminal world," he notes.

A terminal accessory that manufacturers are aiming to push is a hard-copy device, either built into the terminal or standing

alone, for copying the information on the CRT.

Many in the industry expect a surge of sales for minicomputer-based data-communications systems. These will be in the form of data concentrators and of such things as dual-computer, front-end processors. ■■

## Consumer electronics heading for a year of improvements, paced by monolithic ICs

**Jim McDermott**  
Eastern Editor

Monolithic integrated circuits—once used solely in computers—are invading consumer electronics in increasing numbers. This trend is evident in several areas:

- In color TV receivers sophisticated ICs are squeezing out conventional circuit designs and giving better performance.

- For discrete four-channel sound systems—the largest IC ever designed for consumer applications, with over 500 devices on it—has been developed for CD-4 sound demodulation.

- In electronic calculators, discrete LED display-segment driver transistors are being incorporated into the calculator chip.

For color television, 1974 will be a year of gradual improvement rather than dramatic steps forward, according to industry spokesmen.

"The use of new, complex ICs will simplify TV set circuitry," says Dan Schuster, vice president of engineering for Sylvania Entertainment Products, Batavia, N.Y.

As an example, Schuster points to Sylvania's new IC countdown circuit, which eliminates the vertical hold control.

"This IC is typical of what is being developed," Schuster says. "You can do things with these monolithic circuits that were never dreamed of using tubes or discrete transistors. We obtain the vertical sync by counting down from the horizontal pulses. In addition we have a horizontal-drive chip that allows us to relegate the horizontal hold to a factory adjustment—not

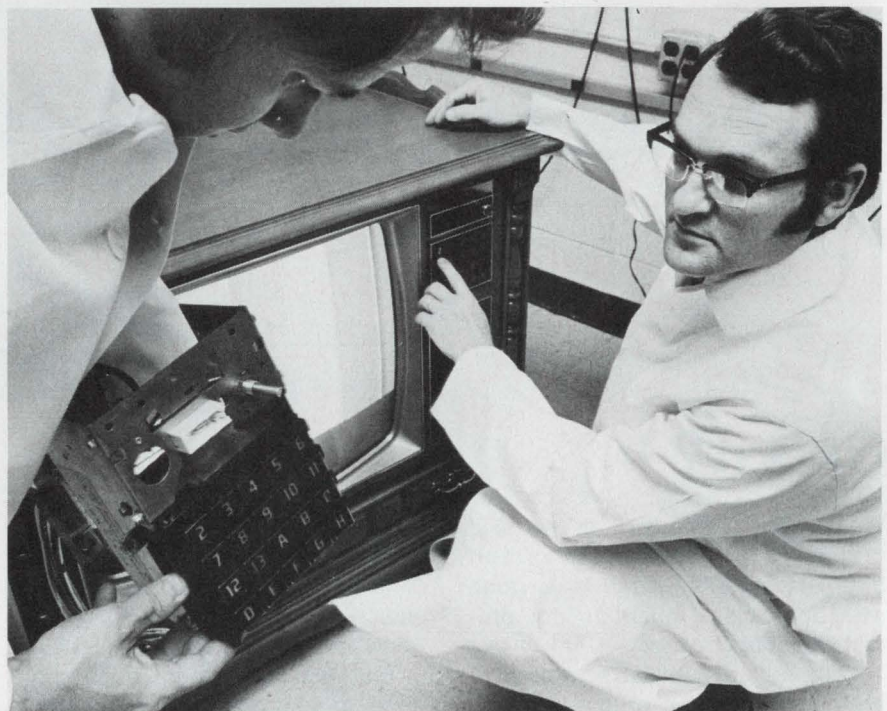

**ICs and discrete solid-state components are taking over in color television sets like this GTE Sylvania receiver. Here, engineers check the varactor tuning.**

a service adjustment.

"Similar ICs simplify the color portion of the set. Variations in color caused by changing from station to station, program to program, or camera to camera have been minimized through use of newly developed ICs."

### Improved timer designs

The problem of complying with the Federal Communications Commission requirements for parity tuning—the uhf channels must ultimately be as easily tuned in as the vhf—will exert considerable pressure on tuner design within

the industry, according to Rolf Czerlinsky, product manager of color TV at General Electric's TV Receiver Dept., Portsmouth, Va.

"Dual types of systems will be developing," Czerlinsky predicts. "For the deluxe, high-end receivers, there will probably be elaborate digital readout systems, using some form of window-type displays.

"For the lower-end sets, the electromechanical systems, with a direct dial reading, will be produced. In any case, the majority of sets will allow the user to tune every uhf channel as well as every vhf channel."

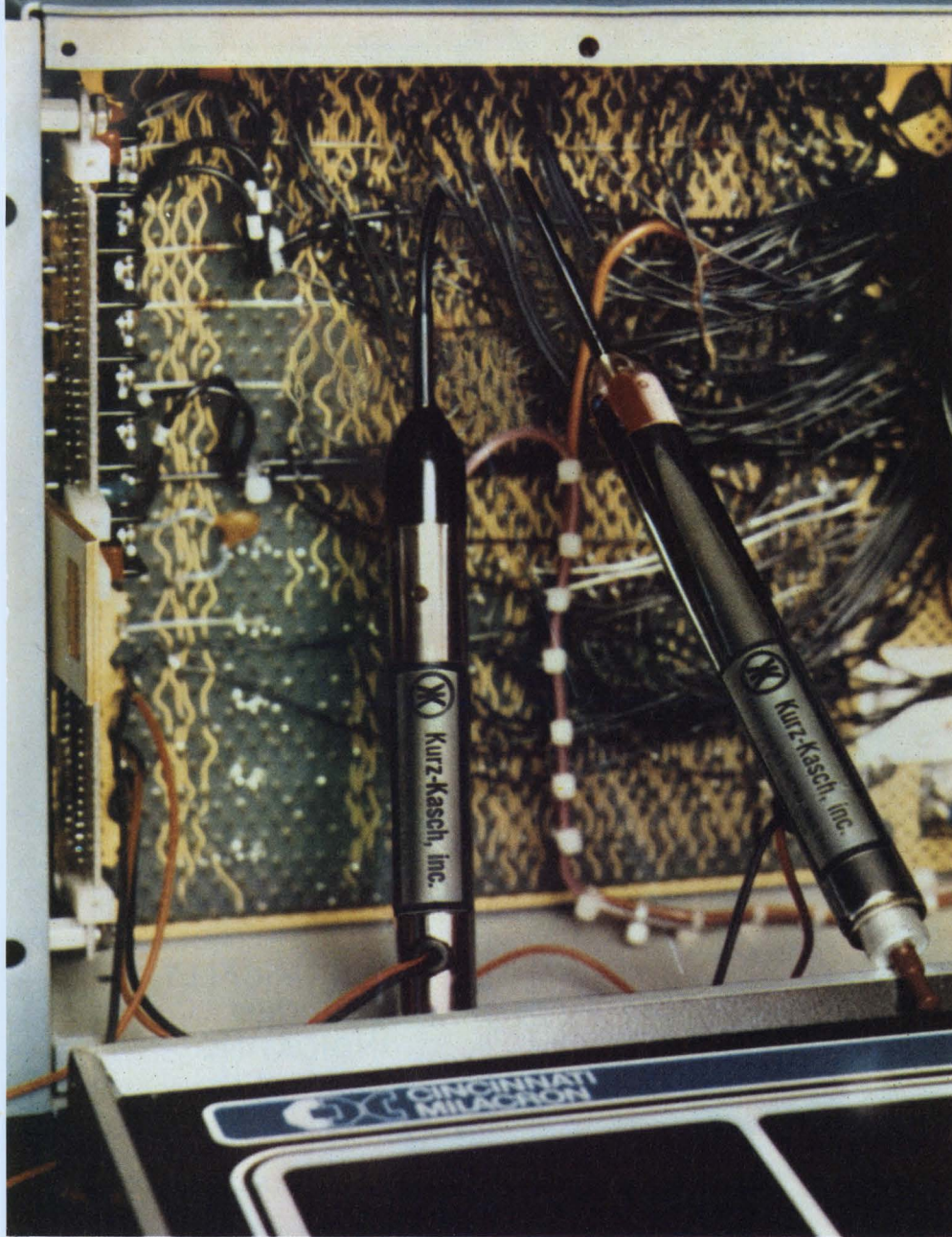

# New digital test system... FOR systems, cards or circuits... from Kurz-Kasch

Using the new Hi-Lo pulser  
with the Kurz-Kasch logic probe  
speeds troubleshooting.

The all new Kurz-Kasch Hi-Lo pulser Model HL-582 is an in-circuit stimulator used to exercise IC's and cards. The HL-582 will pull an existing **LO** state to a **HI** state, and an existing **HI** state to a **LO** state in DTL and TTL logic circuits. By noting the change in output (or lack of change) with a Kurz-Kasch logic probe you can immediately identify troublesome logic circuits.

The basic concept of controlling the input and monitoring the output allows a wide range of use. You can check gates, counters, flip-flops, shift registers, etc. The system is ideal for field service, production checking, inspection and laboratory troubleshooting. The two pen-sized units are extremely convenient to use. The Kurz-Kasch system allows hands-free testing on the backplane, mother board or plug-in boards. Clips and adaptors are available for most commonly occurring test situations in computers, N/C and process controls, business machines and all other digital technology.

## Specifications

### Logic Probe LP-520

**Voltage:** All logic voltage from 4.75 VDC to Vc compatible with DTL, TTL and similar families.

**Logic Voltage Level Response:** 0-0.8 VDC = logic "0" (readout white at tip).  
0.8-2.4 VDC = No Readout.  
2.4 - Vc = logic "1" (readout red at tip).

No readout in case of missing pin or unconnected wire.

**Pulse Detection Response:** High speed pulse trains, or single cycle pulse of 50 nanoseconds duration or greater = (Blue readout at tip).

**Input Impedance:** Greater than 35 K ohms for logic "1" level.

PRICE: \$69.95

### Pulser HL-582

**Pulse Voltage:** High level 3.0 VDC min.  
Low level 0.6 VDC max.

**Pulse Width:** 1  $\mu$  Sec nominal in both 1-shot and continuous modes (5Hz).

**Power:** Derived from circuit/system under test.

Power leads are over voltage and reverse voltage protected.

**Tip:** Protected to  $\pm 35$  volts.

PRICE: \$89.00

Send for complete details and specifications. For a 15 day FREE TRIAL pulser and/or logic probe, contact Tom Barth, General Manager, Kurz-Kasch Electronics, 2876 Culver Avenue, Dayton, Ohio 45429. Telephone: (513) 296-0330.



**Kurz-Kasch, Inc.**

ELECTRONICS DIVISION

2876 Culver Avenue

Dayton, Ohio 45429

Telephone 513/296-0330

Despite the fact that some sound-entertainment industry manufacturers don't believe that true four-channel discrete sound will appear on records this year, developers of this system will be delivering four-channel IC chips to manufacturers.

The largest linear IC that's ever been designed for the consumer electronics industry has been developed by Signetics for Quadracast Systems, Inc., San Mateo, Calif.

"This new chip contains a complete four-channel CD-4 system sound demodulator," says Lou Darren, Quadracast's president. "Within the chip are two complete systems, one for the right pickup channels and one for the left ones. Also included are input preamplifiers and output buffer amplifiers. The chip will be marketed in the U.S. this year through Matsushita Co. of American [Panasonic]."

JVC America, Maspeth, N.Y., originator of the CD-4 discrete recording and playback system, has also developed less complex CD-4 demodulator chips that will be marketed in February or March, according to Victor Goh, president of the JVC Cutting Center in Los Angeles.

Two of these chips are needed for each of the left and right demodulator channels, Goh notes. The preamplifiers and buffer amplifiers are not included on these chips because many of the hi-fi manufacturers prefer to design their own amplifiers, Goh explains. Use of the JVC chips gives them this option.

Licenses of the JVC America CD-4 system include RCA Consumer Electronics, Fisher Radio, Harman-Kardon, Sylvania, and Super-scope, says Goh.

Richard Lewis, product manager for General Electric's Audio Systems and Components Dept. in Syracuse, N.Y., is one who doesn't believe that '74 is the big year for four-channel sound.

"I think that four-channel will eventually become the predominant mode, but the timing will be longer than some in the industry anticipate," he says. "The SQ-type matrix systems are prominent in hardware today, because recordings are available. But the CD-4 system is better in terms of performance

and separation."

However, what may be a key factor that can drastically slow the development of both systems is the critical availability of the vinyls used to make the high-quality records. Lewis points out that these plastics are petroleum-based.

#### Calculator chip sets needed

Demands for smaller, pocket-sized calculators with features found previously in the desk-top units and with continuing price drops, will challenge the chip designer's expertise, according to Dr. E. A. Sack, group general manager for microelectronics at General Instrument, Hicksville, N.Y.

"The chip manufacturer will be making an extremely cost-effective chip set," says Sack. "I say chip set because it isn't important to make just a cheap chip, but the calculator chip has to lead to a cheap system.

"A good example of such a chip set is our CZL 55. It has multiplexed outputs that require only a single digit driver with each LED in the display. It is therefore half a dollar less costly than the system that requires two digit drivers. It's very popular for the \$29 to \$39 low-end calculator line.

"The \$59 to \$99 market is still there, but this requires more on the chip—a percent capability and a single memory. For the \$99 to \$199.95 machines, it will a new-features race. One may stress reciprocals and square roots, the other exponents.

"This will wind up with ultimate emphasis on whatever someone is willing to call an electronic slide rule. These machines may not be as complex as the HP-35, but they'll be machines the college engineering student can afford."

In electronic watches continued improvements in LED material efficiencies will double digit brightness in 1974 for watches like the Pulsar, says John Bergey, president of Time Computer, Lancaster, Pa.

For electronic watches using liquid-crystal displays, Cal-Tex Semiconductor, Inc., Santa Clara, Calif., producer of watch chips and complete watch modules, notes that the modules will be smaller but display more information. ■■

**HERE IS  
YOUR COPY  
OF THE**

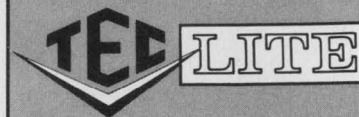

**FULL-LINE  
PRODUCT  
BROCHURE**

*If your copy is missing,  
circle number below on  
Information Retrieval Card*

**TEC-LITE OFFERS  
YOU A COMPLETE  
MAN-MACHINE  
INTERFACE LINE OF  
HIGHLY RELIABLE,  
ECONOMICALLY  
PRICED  
INDICATING  
DEVICES**

- READOUTS
- SWITCHES & INDICATORS
- DISPLAY SYSTEMS
- ANNUNCIATORS

For more detailed information on prices and application assistance, contact your TEC-REP or write directly to:

**TEC, INCORPORATED  
2800 NORTH ORACLE ROAD  
TUCSON, ARIZONA USA 85704  
(602) 297-1111  
TWX 910-952-1377**

**IN EUROPE, CONTACT:**

**TEC, INCORPORATED  
25 PIPER ROAD  
KINGSTON UPON THAMES  
SURREY, UNITED KINGDOM**



# The small economy size function generator,

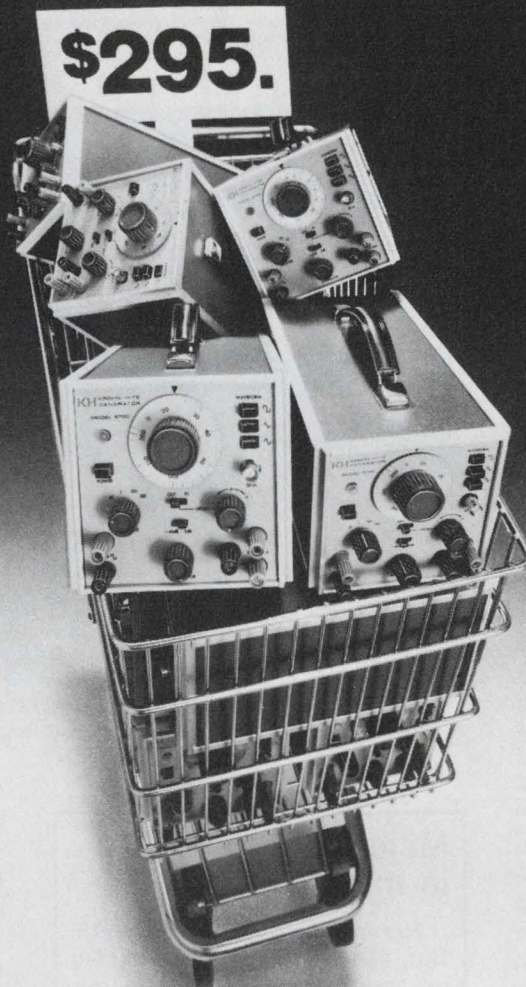

## Sine, square and triangle waveforms from 0.002Hz to 2MHz at a price you can handle.

If you're in the market for a low-cost, versatile function generator, we've got the unit for you. Model 5700 is the little big man of our 5000 series, with multifunctions, balanced output and a general versatility unmatched at the price. It features a 1000:1 tuning dial, covering the whole audio spectrum on one frequency range. The 50 ohm single ended output and 600 ohm balanced output are controlled by a common attenuator. An auxiliary

square wave output enables synchronization, gating and blanking. Model 5700 is the ideal choice for a broad range of electronic applications from research to calibration. With this performance at a bargain price why shop around?

For fast action, call (617) 491-3211, TWX 710 320 6583, or contact your local KH representative listed below.

**KH KROHN-HITE**  
CORPORATION  
580 Massachusetts Avenue, Cambridge, Massachusetts 02139

SALES OFFICES: ALA., Huntsville (205) 534-9771; ARIZ., Scottsdale (602) 947-7841; CAL., Santa Clara (408) 243-2891, Inglewood (213) 674-6850; COLO., Denver (303) 934-5505; CONN., Glastonbury (203) 633-0777; FLA., Orlando (305) 894-4401; HAWAII, Honolulu (808) 941-1574; ILL., Des Plaines (312) 298-3600; IND., Indianapolis (317) 244-2456; MASS., Lexington (617) 861-8620; MICH., Detroit (313) 526-8800; MINN., Minneapolis (612) 884-4336; MO., St. Louis (314) 423-1234; N.C., Burlington (919) 227-3639; N.J., Haddonfield (609) 795-1700; N.M., Albuquerque (505) 299-7658; N.Y., E. Syracuse (315) 437-6666, Rochester (716) 328-2230, Vestal (607) 785-9947, Elmont (516) 488-2100; OHIO, Cleveland (216) 261-5440, Dayton (513) 426-5551; PA., Pittsburgh (412) 371-9449; TEX., Houston (713) 621-0040, Richardson (214) 231-2573; VA., Alexandria (703) 354-1222; WASH., Seattle (206) 624-9020; CANADA, Montreal, Quebec (514) 636-0525, Toronto, Ontario (416) 444-9111, Stittsville, Ontario (613) 836-4411, Vancouver, British Columbia (604) 688-2619.

# Better components and materials widening magnetic applications

Magnetic components and materials have always had their place in the electronic designer's bag of tricks, but with recent improvements in materials and processes, they have moved into a more promising position. The following trends are apparent:

- Ferrites are rapidly gaining in popularity, particularly in power-supply applications. Until recently, designers would not even consider using ferrite transformers in power supplies, because they are not suited for low-frequency operation. Now, with the move toward high-frequency switching power supplies, ferrites are being used extensively to reduce size and weight, as well as cost.

- In permanent magnets, rare-earth cobalt types are taking over many applications formerly delegated to Alnico devices. The characteristics of these new "super" magnets allow for reduction in size, operation at higher temperatures and increased resistance to demagnetization.

- Advances in magnetic materials have also yielded improvements in magnetic recording tapes. Standard gamma ferric oxide tapes are giving way to higher energy chromium dioxide and, more recently, cobalt doped tapes. Because of the higher coercivity of these tapes, recording at improved frequency response and lower noise are possible. On the horizon are even higher-energy metallic tapes.

## Ferrites are challenging metals

Metal laminations have traditionally been used in power supply transformers because they have a greater saturation and permeabil-

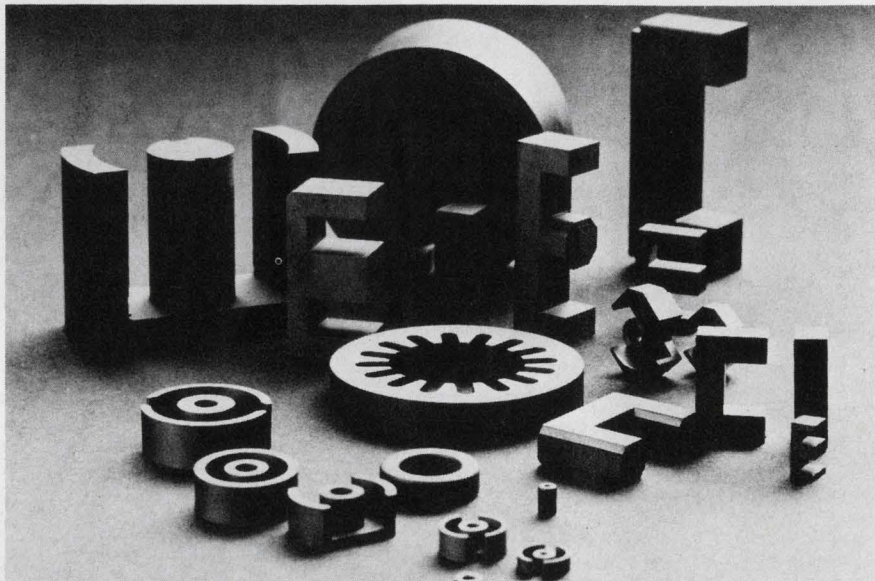

Ferrites come in a variety of different shapes and sizes. They are rapidly replacing transformers in higher frequency applications.

## Major terms in magnetics

*Permeability* is the magnetic flux density  $B$  in gauss divided by the magnetic field strength  $H$  in oersteds. It is a measure of how much better a given material is than air as a path for magnetic lines of force. The permeability of air is assumed to be 1.

*Energy product* is the product of the magnetic flux density  $B$  in gauss times the magnetic field strength  $H$  in oersteds. It is used as an index of magnet quality. The larger the maximum energy product, the smaller the required magnet for a given job.

*Coercivity* is the magnetizing force needed to magnetize a saturated tape. It is designated by  $H_c$  and is measured in oersteds. The higher the coercivity, the greater the frequency response of the tape.

ity at 60 Hz than ferrites do. But with the switch to high-frequency power supplies, ferrites have become more attractive.

The reason, notes Peter Hill, manager of engineering at Indiana General, Keasbey, N.J., is that the operating frequencies of these supplies is generally somewhere between 10 and 25 kHz. At these frequencies, he continues, it is practically impossible to make use of the high saturation of metal alloys, because they would have to be rolled so thin—only a few mils—that cost and handling difficulty become prohibitive.

In addition the high saturation of metals suffers at these frequencies because of incomplete flux penetration (skin effect), which lowers the average flux density.

Ferrites, on the other hand, do not have to be laminated, says Hill. They have a high resistivity, which keeps the eddy currents small. The resistivity of some ferrites, in fact, is so high that they are practically



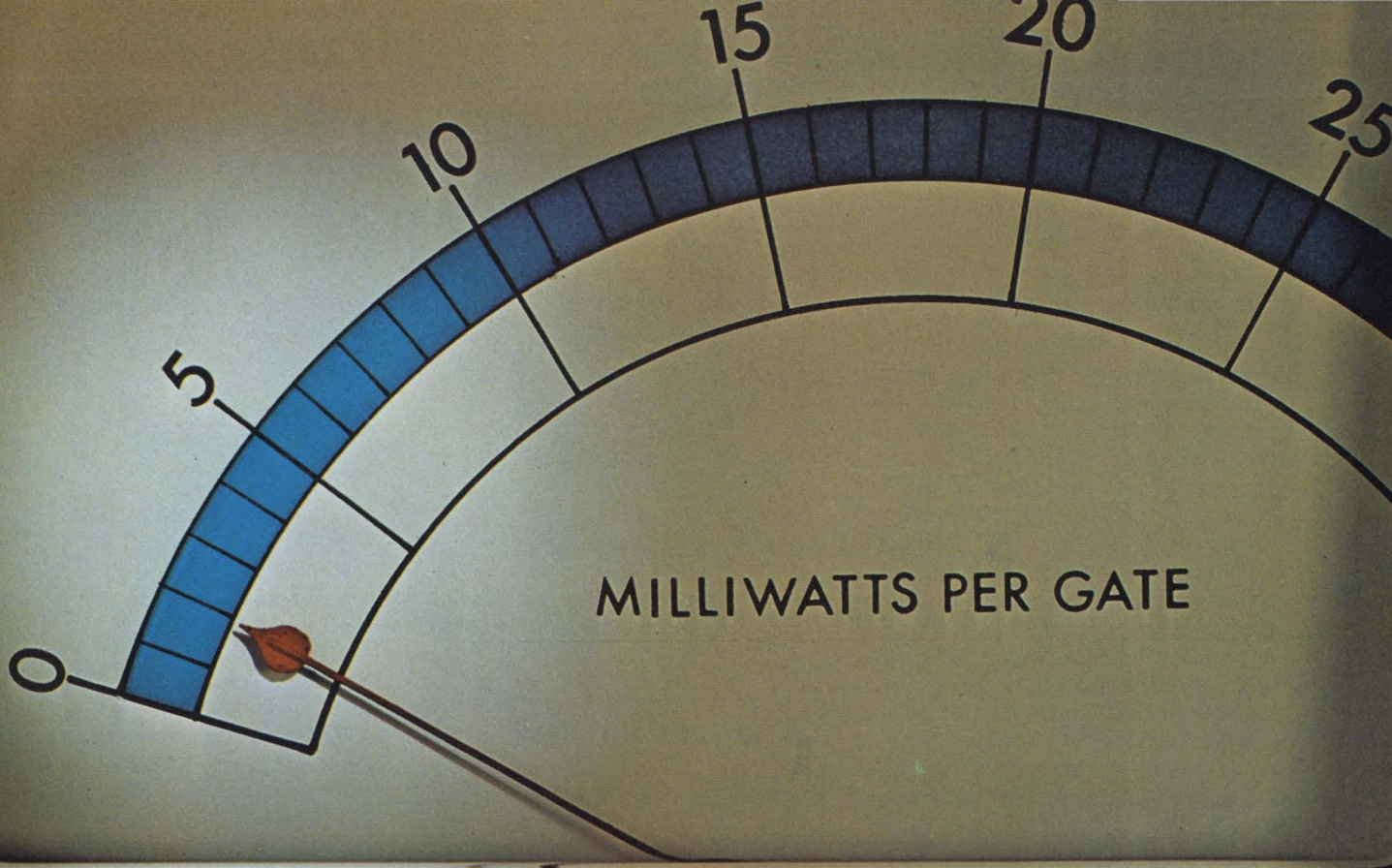

**SCHOTTKY**

# Every milliwatt counts.

## Low-power Schottky lets you design at 2mW per gate without sacrificing speed.

Today's new TTL system designer must look carefully at any option that cuts power consumption.

And low-power Schottky is getting a long look. Here's why.

Low-power Schottky offers more than just 2 milliwatts power dissipation per gate. You also get TTL speed—10 nanoseconds. This reduces your power requirement as much as 80% when compared with standard TTL logic. Low-power Schottky also offers high stability over a broad temperature range.

Compatibility is complete, pin-for-pin to 54/74 TTL.

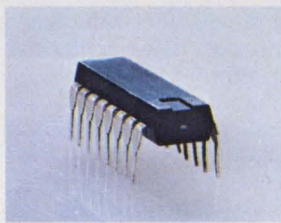

And there's a broad choice of 60 functions—35 SSI and 25 MSI: Decoders/demultiplexers. Data selectors/multiplexers. Shift registers. Arithmetic elements. Dual flip-flops. Latches. Counters. NAND/NOR/AND/OR gates, inverters and buffers. An even larger assortment will be ready later this year.

Availability is excellent—right off the shelf.

For prices and information on the wide selection of 60 low-power Schottky functions, contact your nearest Texas Instruments sales office or your local authorized TI distributor.

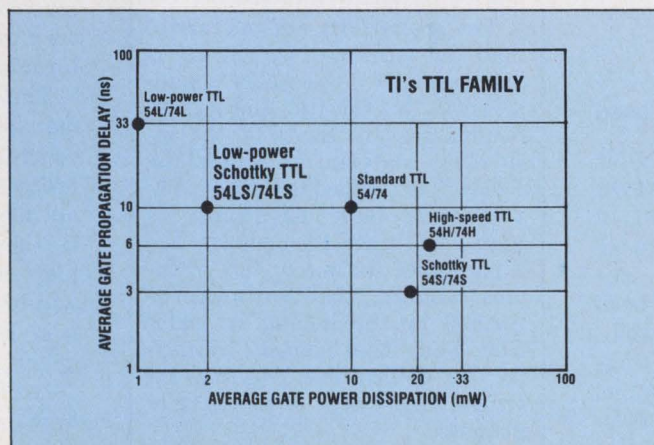

**TEXAS INSTRUMENTS**  
INCORPORATED

insulators, he continues.

The assembly of ferrite transformers is easier, too. Instead of manual interleaving of laminations, it is necessary only to place two core halves together.

### The ubiquitous ferrite?

Because of their application to switching power supplies, many engineers feel that ferrites will become almost as ubiquitous as the transistor. According to Jan van der Poel, manager of application engineering for Ferroxcube Corp., Saugerties, N.Y., ferrites will find broad application in telecommunications, calculators, electronic watches, cameras, minicomputers, automobiles and just about any other application where dc voltage or the conversion of it to another level is necessary.

"It's one of those rare applications where there are no trade-offs," he explains. "Everything goes for you. When used in high-frequency supplies, the size of the core, volume of the supply, cost of components, amount of copper and the weight all come down. There is no compromise."

Another reason that ferrites are becoming popular is that they are easier to use. Indiana General's Hill notes that there is an industry trend toward rating ferrites according to applications. Ferrites are being treated more like components than materials. Instead of specifying a device in terms of magnetic materials and characteristics, Hill says, the industry is moving toward the specification of ferrites in terms of performance. Cores can meet materials specs and still not perform properly in a circuit, he notes. In addition to "application rating" its ferrites, Indiana General guarantees performance characteristics.

### Materials and processing improved

New developments in materials and processing are largely responsible for the renewed interest in and the success of ferrites, notes van der Poel at Ferroxcube. Although improvements have been evolutionary rather than revolutionary, they have been quite significant, he goes on. For example, core losses have been reduced five-fold, from a loss factor of  $5 \times 10^{-6}$

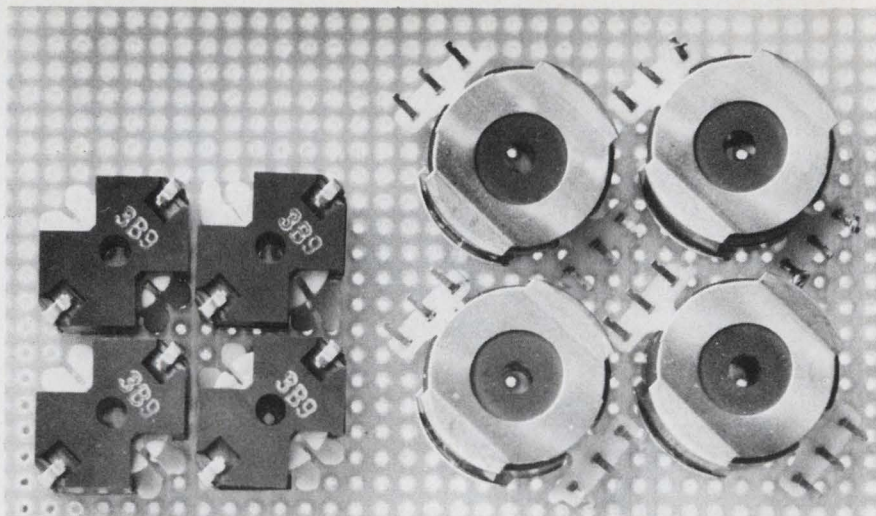

Square shaped ferrites are finding wide acceptance because they have a higher packing density and are easier to assemble.

### What are ferrites?

Ferrites are ceramic structures made by mixing iron oxide ( $\text{Fe}_2\text{O}_3$ ) with oxides, hydroxides or carbonates of one or more of the divalent metals, such as zinc, nickel, manganese, copper, cobalt, magnesium, cadmium or iron. Nowadays practically all commercial ferrites contain zinc, which is very effective in lowering core losses.

The general formula for ferrites is  $\text{MFe}_2\text{O}_4$ , where M stands for one or a combination of ions of the divalent metals. If M stands for iron, we get  $\text{Fe}_3\text{O}_4$ , which is the formula for magnetite or lodestone.

The success of ferrites is based on the fact that they have high resistivities and thus low eddy current losses compared with metals.

Because ferrites are ceramics, they can be manufactured in a great variety of shapes and sizes. Metallic components are more limited in this respect.

The resistivity of a ferrite material at low frequencies is determined by the grain boundaries of the ferrite. Since these boundaries are made of the insulating material in which the ferrite is embedded, the low-frequency bulk resistivity is high. At high frequencies the capacitance between the granules shunts the boundaries formed by the insulating material. Thus the over-all resistivity is determined by the intrinsic resistivity of the ferrite granules.

to  $1 \times 10^{-6}$ .

These lower losses, van der Poel explains, have resulted in devices that have either a larger Q or are physically smaller. These lower-loss ferrites may also be a significant factor in reversing the trend from LC circuits toward active circuits. Simple, passive ferrite inductors are more reliable, more stable and can take wider extremes of environment than complex, active circuits that are often used to replace them.

Some important developments in material permeability are also taking place, van der Poel reports. Materials with a permeability as high as 15,000 are already being looked at. Some companies have them already, he says, others don't. Magnetics, Inc., of Butler, Pa., does.

According to Dr. Alex Goldman, director of research at Magnetics, materials with a permeability of 15,000 are available today, but only as special orders. And in many cases they are available only in very small sizes, such as 1/4-inch toroids.

The higher permeability, Goldman says, is achieved by strictly controlling the raw materials and processing all along the line. It is not due to any dramatic discovery. If the permeability can be raised high enough, he continues, ferrites will be able to compete with nickel-iron laminations at the voice frequencies.

Indiana General also has the high permeability ferrites. Its engineering manager notes that the



# MCM'S

## Each GE Planar Ceramic Triode Delivers Acknowledged\* Excellence ...

## And You'll Find The Same Quality in Every GE Microwave Circuit Module (MCM)!

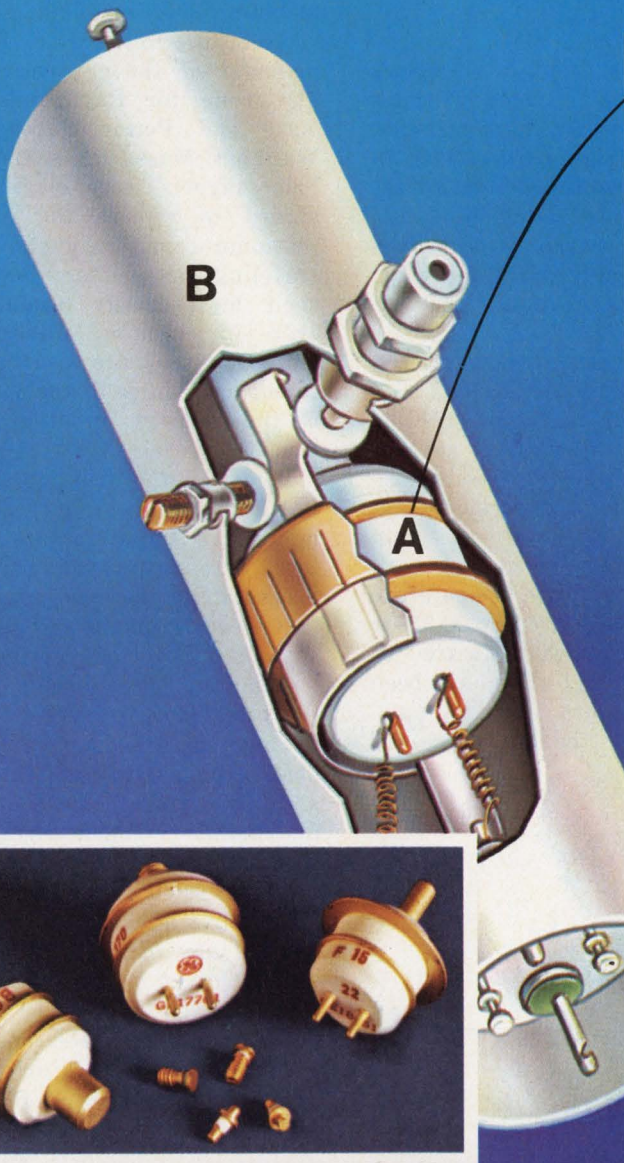

**A** GE Planar Ceramic Triodes deliver acknowledged state-of-the-art performance: thirty years' GE tube research with triodes has resulted in exceptional tolerance to the most adverse thermal, shock and vibration environments; very high ratio of power, efficiency, reliability and gain bandwidth to product size and weight; fast warmup; lower noise levels; and more efficient operation at higher frequencies.

And we've put our extensive knowledge of triode technology to work developing a family of pre-packaged microwave circuits called General Electric MCM's (Microwave Circuit Modules)

**B**— each built around a GE triode or solid-state diode. And each MCM is built with such care and precision that it, too, is fast becoming a recognized standard of excellence.

Functioning as an oscillator, an amplifier, or as a complete assembly (with a power supply, and/or integrated isolator/circulator, and/or modulator), GE MCM's solve five of your toughest problems:

- circuit-active component interfaces
- reproducibility     on-time delivery
- in-line rejects     field failures.

Chances are there's a GE MCM already available for your microwave system. If not, we'll design and build the exact module you need. And we'll get it to you fast.

Contact: Microwave Devices, General Electric Company, 316 East 9th Street, Owensboro, Kentucky 42301. Or use the reader service card.

\*In a recent Brand Recognition Study by a leading business publication, more designers expressed a preference for General Electric Planar Ceramic Triodes... 11% more chose GE over the next leading brand. (Copies of the Study are available upon request.)

360-09

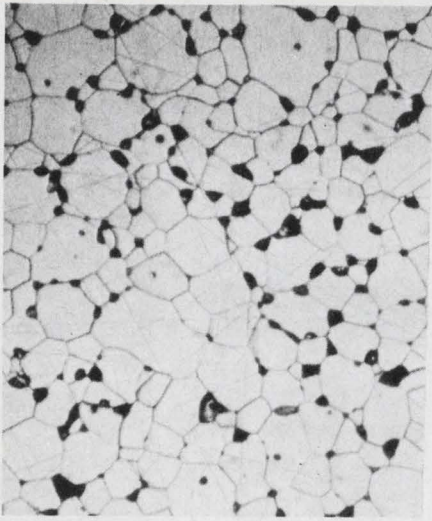

**Hot pressed ferrites** (right) from National Micronetics have a much finer grain structure than ferrites produced by other methods (left).

initial permeability of ferrites at 10 kHz has been increased to 16,000 in commercial products and up to 50,000 in laboratory experiments.

Whereas Magnetics has limited its production of high permeability ferrites to small toroids, Indiana General is manufacturing larger toroids and mated parts, like E cores, with outside diameters or lengths of up to 1.5 in. and permeabilities as high as 10,000. Hill at Indiana General notes that with these devices, the mating surfaces must be flawlessly lapped and meticulously clean to obtain the full benefit from the high permeability.

### Hot pressed cores make the scene

One new processing technique that is being applied to recording-head ferrites is hot pressing of the material. Patrick Rivelli, vice president of National Micronetics, West Hurley, N.Y., notes that this approach offers several advantages over the conventional mechanical and isostatic techniques. Among the gains, he explains, is the ability to get greater material densities—and consequently less voids—better edge definition and greater control of grain structures.

With the hot-press process, Rivelli reports, the pressing and heating of the material is reduced from two steps to one, giving a finer grain structure.

The finer grain structure, in turn, is allowing ferrite recording heads to replace alloy heads, says Paul Baba, manager of the Fer-

rite Materials Dept. at Ampex's Sunnyvale, Calif., plant. Ferrites have longer wear characteristics, he notes, and are harder than alloys. But conventional ferrites are susceptible to edge chipping and gap erosion, because of the brittleness of the material. Hot-pressed materials don't have this problem, Baba asserts.

Another development in ferrites, the Ampex manager notes, is a new family of materials, lithium ferrites, for microwave applications. The lithium devices are replacing the more expensive magnetic garnets, he reports. Lithium ferrites, in addition to low cost, feature a high Curie temperature and good memory properties. Their memory characteristics are so good, in fact, that they have been used in computers.

In outlining the advantages of

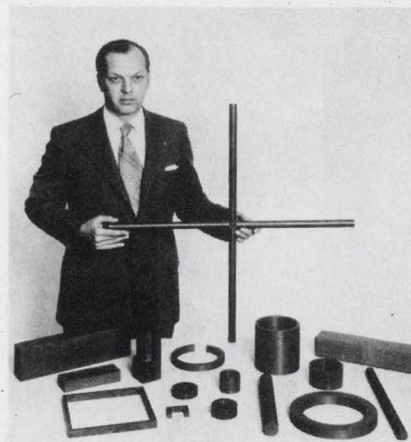

**Ferrite loop cores**, like these from Ceramic Magnetics, result in compact low-frequency antennas.

lithium ferrites over garnets, Baba points out that the magnetization of garnets is limited to about 2000 G, whereas lithium ferrites can go as high as 5000 G.

The only area where garnets are still strongly competitive with the new ferrite is at S band, he notes, adding that this should change in the next year or two.

### Rare-earth magnets advancing

The application of rare-earth cobalt magnets has increased dramatically in the five years since their introduction. There was, for example, immediate acceptance by the microwave industry of samarium-cobalt magnets.

According to Albert E. Paladino, manager of the electrical materials group for Raytheon's Microwave and Power Tube Div. in Waltham, Mass., the samarium-cobalt magnets were originally designed to replace the expensive platinum cobalt magnets used on traveling-wave tubes. Because of their high energy product, however—15 million Gauss-Oersted (MGOe)—they are also beginning to replace Alnico 5, the workhorse of the industry, in other applications.

Some of the new applications, Paladino says, include crossed-field microwave tubes, motors, generators, gyroscopes, watches, meters, magnetic clutches and actuators.

Rare-earth magnets offer several advantages over conventional ones, he remarks. These include the highest resistance to demagnetization of any material currently available, extremely good temperature stability—which allows operation at higher temperatures—better linearity and the possibility of larger gaps in magnets.

The size advantages are particularly interesting, and Paladino notes that a 90-pound Alnico 5 magnet can be replaced by a 6-pound samarium cobalt one.

In addition to work on improved magnetic properties, efforts are also under way to reduce the cost of rare-earth magnets. Samarium metal currently sells on the open market for about \$60 a pound, according to Paladino. Cheaper substitutes are being sought. One is mischmetal, a combination of rare-earth metals. Mischmetal cobalt

# Specify GE Bulk-Effect Diodes & Oscillators

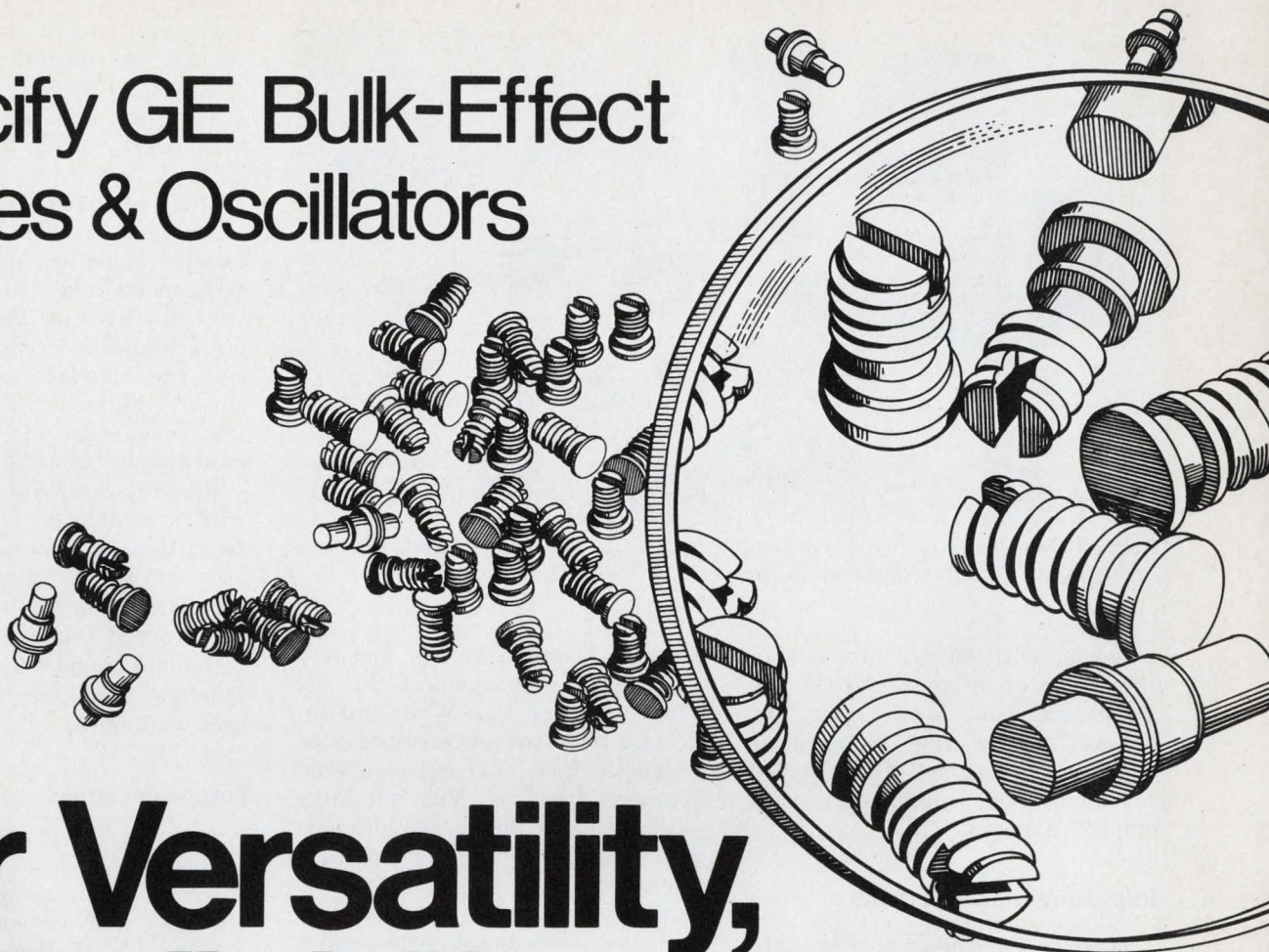

# for Versatility, Reliability and Application Design Assistance.

**Versatility?** General Electric's capability allows you to choose a bulk effect diode or oscillator with a threaded or unthreaded case, power output levels of 5 to 250 mW and frequencies from 5 to 18 GHz.

**Reliability?** In-house life tests show over 1/2 million device-hours without failure or significant performance changes. These tests include cycling and monitoring of RF, DC and noise changes with time.

**Application Design Assistance?** Just let us know how we can help you! Odds are we already have the precise diode or Microwave Circuit Module (MCM) you need. If not, we'll design and build it. Call us at (502) 683-2401, Ext. 422, or write Jim Rush, Microwave Devices Products Section, General Electric, 316 East 9th Street, Owensboro, Kentucky, 42301. Or use the reader service card.



GENERAL  ELECTRIC

362-04

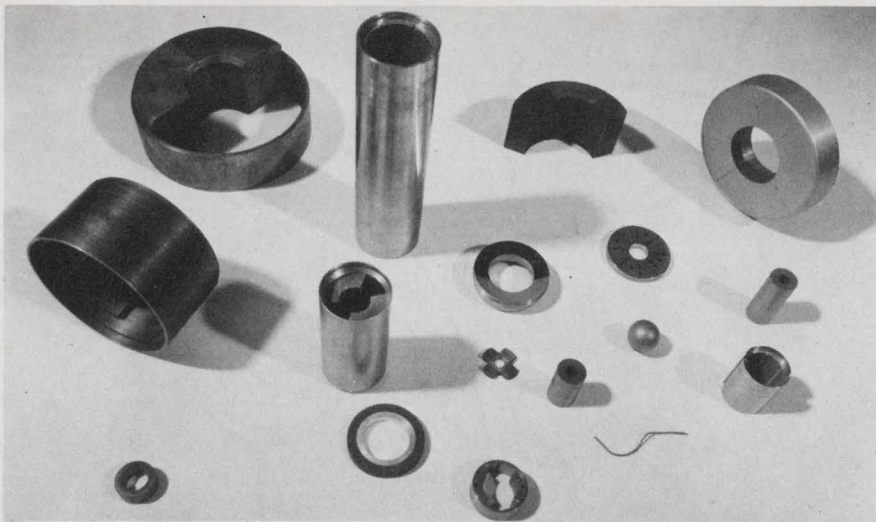

**Rare-earth magnets**, originally designed for use in microwave tubes, are now being used in motors, generators, watches and meters.

magnets, with energy products in the range of 10 to 12 MGOe will be available at lower cost. The reason is the raw material is cheaper. In contrast with the \$60 for samarium, mischmetal costs only \$6 a pound.

### Improving magnetic tapes

Lower recording speeds, improved dynamic range and increased signal-to-noise ratios are only a few of the results that can be attributed to improvements in materials for magnetic recording tapes. Most of these improvements are the result of higher coercivity tapes that are available today.

Back in 1946, when magnetic tape first started to appear, the coercivity was about 125 Oe, says Victor Mohrlant, manager of technical services for the Magnetic Audio and Video Products Div. of the 3M Co., St. Paul, Minn. Early tapes also had to operate at relatively high speeds—30 inches per second.

Improvements in tape heads and in the gamma-ferric oxide particles used have resulted in tapes that now can operate at 1-7/8 inches per second and give the same, or better, performance as tapes that formerly ran at 30 inches per second.

Another approach to improving recording fidelity has been taken by DuPont, which in the mid-60s developed a new particle to be used on tapes—chromium dioxide. The coercivity of the chromium dioxide tape is about 500, reports

George Armes, Ampex's manager of product management in the Magnetic Tape Div. While this increases the frequency response of magnetic tape, it requires special biasing circuitry. This circuitry provides twice the normal bias current so the chromium dioxide tape operates in its linear region. To overcome this and increase performance even more, Armes says, manufacturers have developed gamma-ferric-oxide tapes that are doped with cobalt. These can have a coercivity of up to 3000 Oe, he notes.

3M has been a leader in developing cobalt-doped tapes. In addition to increasing the coercivity of the tape, cobalt allows the manufacturing process to be strictly controlled, Mohrlant points out. It is possible, he continues, to produce a tape with any value of coercivity from 300 to more than 1000.

Major applications for the cobalt-doped tapes are in video and instrumentation recording. But audio recordings can also use it.

The availability of high-energy materials for tapes has resulted in a new concept in recording—dual-layer tapes, Mohrlant reports. High-frequency signals are recorded in only the first 5 to 10 micro-inches of tape, he notes, and the depth beyond that is used to record low-frequency audio and control signals.

To produce tape with the characteristics of a high-energy tape but at a lower price, 3M has developed a dual-layer tape that consists of a standard gamma-ferric-oxide

base with a thin layer of high-energy, or cobalt-doped, oxide on top of it. The ratio of the thickness of the standard layer to the high energy layer is about 10 or 20 to 1.

Mohrlant likens the new tape to a speaker system in which a tweeter would be used for the high frequencies and a woofer for the lows. In this case the cobalt-doped layer would be used for the highs and the standard oxide for the lows. A high-energy cassette tape that makes use of this approach is available from 3M.

Recently Sony has also come out with a dual-layer tape. It differs from the 3M, however, in that it uses chromium dioxide for the high-energy layer instead of the cobalt-doped oxide. Like other chromium-dioxide tapes, the Sony requires special recording and playback equipment.

### Future uncertain

Just what will happen in the recording tapes in the next five years is not exactly clear. Both Mohrlant and Ampex's Armes see a decline in the use of chromium dioxide in favor of the cobalt-doped oxide. However, no one yet can estimate whether oxide tapes or the newly announced Coballoy metallic tapes will be more popular. The Coballoy metallic tapes were originally announced by Graham Magnetics, Graham, Tex., but other companies, like 3M, are now working on them.

The main advantage of metallic tape is that it has a very high density. Whereas oxide tapes have voids and contain binders, metallic tape is solid and therefore has an efficiency that is about 2.5 times higher than that of other tapes. It also has a higher coercivity, ranging from 1000 to 3000 Oe.

Mohrlant says that 3M has sent out samples of the new metallic tape to equipment manufacturers for evaluation, but he is not yet saying what the response has been. The problem with this tape is that it would require completely new recording and playback equipment.

Mohrlant predicts that equipment for the new tape will be available next year and that in three to five years, metallic tape could be very popular. ■■

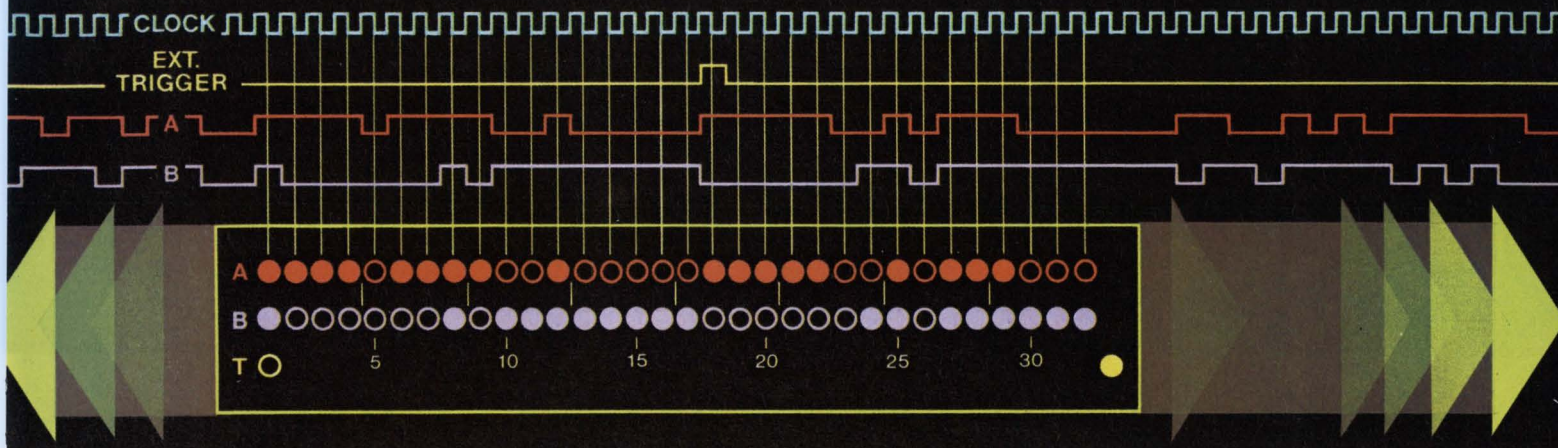

# The ordinary way of looking at digital bit streams has become obsolete.

- Diagnose Tough Digital Problems!
- See 10 ns. spikes in slow data!
- See 64 bits preceding that intermittent failure!
- See the one millionth bit after trigger!

Introducing the HP 5000A Logic Analyzer. A fast, simple, easy — and above all — accurate way to look at digital signal streams. Highs and lows are displayed by “on” and “off” states of LED’s that make intuitive sense when you’re working with truth-tables or timing diagrams.

Now you can look *backwards* as well as forwards in time from a trigger event. Plus, fast, easy-to-use waveform storage that lets you conveniently capture single-shot or transient bit streams. Add to this straightforward, almost self-explanatory controls and you have an ease of operation and display interpretation unmatched by any other method of monitoring digital bit streams.

The unique trigger circuits of the 5000A will help you extract invaluable information from your circuit. Use “CLOCKED” triggering to prevent faulty triggering in the presence

of data spikes. Use “ASYNC” triggering on that intermittent pulse from your decoder, for example, and expose its cause. Or, select a combination of any three inputs from your system for the trigger word. After triggering, the 5000A can either display the bit stream or automatically detect and display only those elusive spikes or glitches that may occur but once a day.

The HP 5000A has a capture rate of up to 10 Megabits/sec., adjustable threshold, and 1 megohm impedance. Use it with any existing logic family. Precise digital delay makes algorithm-checking and accessing of particular data in long streams incredibly easy. Timing and display are keyed to your clock signal so absolute repeatability is assured. HP 5000A, \$1900.\*

If you need to display a series of parallel words, consider HP’s 1601L Logic State Analyzer with a CRT display of 1’s and 0’s, \$2650.\*

To arrange for a demonstration, call your local HP field engineer today. Or write us for complete specifications.

\*Domestic USA prices only.

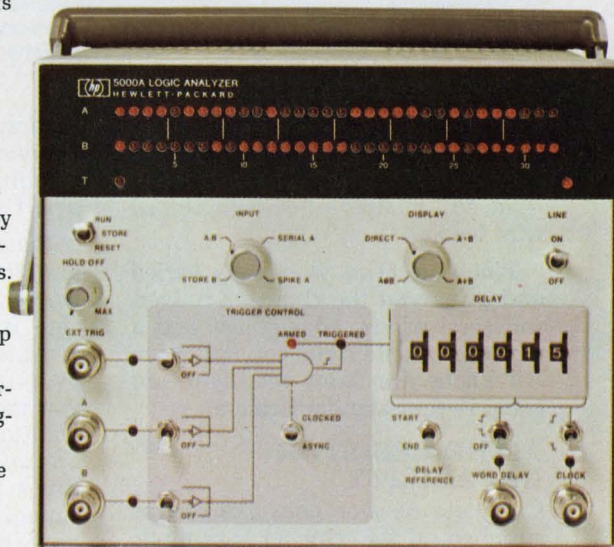

Sales and service from 172 offices in 65 countries.  
1501 Page Mill Road, Palo Alto, California 94304

# Centralab perspectives

FOR USERS OF ELECTRONIC COMPONENTS

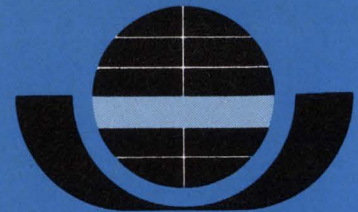

CENTRALAB

Electronics Division  
GLOBE-UNION INC.

5757 NORTH GREEN BAY AVENUE  
MILWAUKEE, WISCONSIN 53201

## With the options now available, standard cermet and carbon trimmer resistors take on new dimensions of application.

Centralab is meeting the high performance demands of navigation equipment, aircraft radio, calculators, instrumentation and automotive electronics. High volume and low cost are ancillary benefits.

Regardless of the application, if you're looking for a trimmer resistor with power handling capacity, small size, reliability, or any number of other critical parameters, you'll find the right combination in the extensive line of standard designs and options available from Centralab. And if you're looking for high volume at low cost you should know that Centralab can provide production runs in the millions with unit costs of less than 10 cents, depending on the type you select.

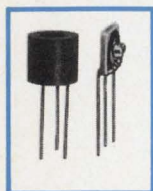

Compare the Centralab Series M trimmer with a conventional TO-5 size. The Centralab 1/20 watt unit requires 2/3 less space. That's a significant advantage for miniaturization.

Our four series of carbon or cermet trimmers offers you 18 standard models, in sizes from 1/4" to 3/4", from single to quad sections, in ratings from 1/10 to 3/4 watt. You can select from a wide range of resistor values — 100 ohms to 10 megohms in carbon, 100 ohms to 1 megohm in cermet. With standard resistor tolerances as low as  $\pm 10\%$ . To simplify assembly, all units can be furnished

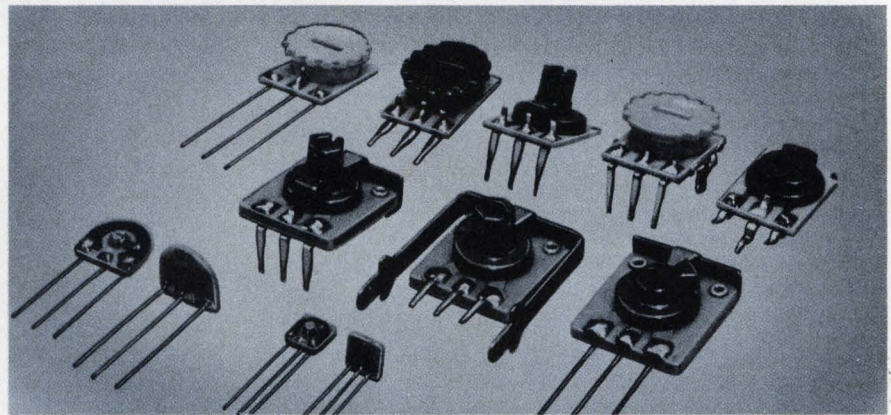

There's maximum versatility in the Centralab trimmer resistor line. Four series are available with a variety of options including mounting brackets, leads, knob styles and colors.

for vertical or horizontal mounting with your choice of three tab leads — including the new Snap-Tite® rigid PC mount — or with tinned wire leads.

Knob selection is equally varied and gives you the choice of universal, screwdriver, edge-adjust and a new thin-profile style just .130" high. All knobs are flame retardant and come in four standard colors.

### FIXED RESISTOR CAPABILITY

Complete resistor networks can be supplied on the trimmer base plate. As many as 9 fixed resistors can be added to the quad units, 3 on a single

section. And, because you also want the assurance of better tracking and stability, we offer ratio matching as a part of our fixed resistor capability.

Even with all these features, there are other reasons why you can confidently specify Centralab trimmers. One is the ceramic substrate that gives them performance unmatched by phenolics. First of all it gives you the stability you need. But in addition, you get higher wattage in a smaller space. They're conservatively rated at double the wattage capability of phenolics. Ceramic bases mean they'll withstand higher operating temperatures — greater dimensional stability — no flux migration during flow soldering.

Centralab can help you match up their world of options and standard designs to give you new dimensions in trimmer resistor specification. Complete data, including new simplified part descriptions for each trimmer family, is included in a new Specification Guide. Write for your copy today. Ask for Catalog 1549T.

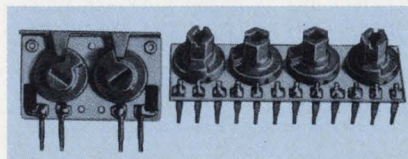

Multiple sections — double, triple and quad — plus fixed resistors are every-day requirements being met by Centralab trimmers.

INFORMATION RETRIEVAL NUMBER 205



**Centralab**  
perspective:

**Rotary  
Switches.**

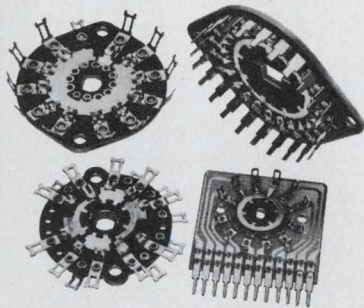

**Design them in  
for multi-circuit  
switching needs.**

When your best circuit design requires switching an array of many circuits, the benefits of rotary switches makes them the logical choice. Centralab, with the most complete line, gives you benefits like this:

- Simultaneous switching of many circuits by varying the number of switching decks.
- Choice of index types — for 2 to 24 positions — 15° to 90° throw.
- Shorting and non-shorting contacts can be intermixed on the same section.
- Phenolic, ceramic, glass or diallyl phthalate insulation — to match your dielectric specifications.
- Optional electrostatic shielding.

Get the facts on total benefits. Write Centralab for Bulletin 1101SR.



**Centralab**  
perspective:

**EMI/RFI FILTERS  
FROM  
USCC/CENTRALAB**

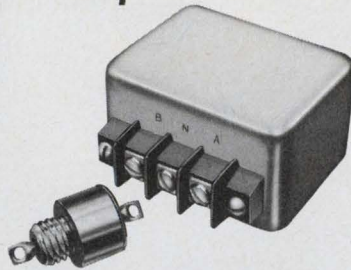

Now . . . the broadest line of filters ever available from USCC — from precise, miniature ceramics, through general purpose filters to specific application "tailored" types.

Our ceramic line starts off with the 1000 and 2000 Series Pi, L and T section low pass filters. The 3000 and 9000 Series "screw-body type" offer up to 500 VDC in Pi, L and multi-section units.

The General Purpose 5000 Series utilize paper and film type capacitors. They are available in 200, 400 and 600 VDC and 115, 250 VAC, 0-400 Hz ratings. Specifically designed for electronic data processing units and systems, USCC's new 8000 series are available in tubular, rectangular and "bathtub" styles.

Whether your application is suppression of noise interference in auto ignition systems, improving the quality of phone lines, or suppression of nuclear pulses (EMP) WE HAVE A FILTER FOR YOU.

Write USCC for complete EMI/RFI Filter catalog. USCC/Centralab 2151 N. Lincoln Street Burbank, California 91504



**Centralab**  
perspective:

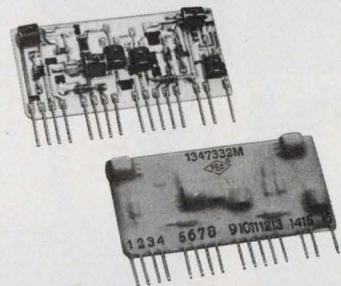

**Two thick film  
hybrid systems.  
PEC and MEC.**

Centralab offers the flexibility to design and fabricate thick film modules to fit virtually any application and cost parameter.

**Low-cost silver/carbon or PEC<sup>®</sup> systems for consumer applications:**

- Resistor Range . . . . . 10 ohms to 10 megohms
- Resistor Tolerance . . . ±10% preferred minimum
- Ratio Matching . . . . . ±5% minimum
- Capacitor Types . . . . . Ceramic and tantalum
- Active Devices . . . . . Diodes, transistors & IC's
- Operating Temp. Range . . . -55° C to +85° C

**Noble metal/cermet or MEC systems for commercial and industrial uses:**

- Resistor Range . . . . . 3 ohms to 3 megohms
- Resistor Tolerance . . . . . ±5% minimum
- Ratio Matching . . . . . ±1% minimum
- Capacitor Types . . . . . Ceramic and tantalum
- Active Devices . . . . . Diodes, transistors & IC's
- Operating Temp. Range . . . -55° C to +150° C

For Bulletin 1429H write A.R. Wartchow, Manager, Electroceramic Marketing. Outside U.S.A. contact J.H. Meunier, Manager, International Sales.



**Centralab**  
perspectives



# spice

**VARIETY IN PUSHBUTTON SWITCH SELECTION.** That's how Centralab can help put a little more spice in your work-a-day life. Because nobody else can give you all the up-to-date features and functions that let you design the way you want to. Start with the basic module . . . then select the options you want, and every functional and appearance specification suddenly becomes reality.

Maybe you'll select Centralab pushbutton switches\* because they require so little space. That's important when you also consider that up to 29 modules can be ganged on a single bracket with horizontal or ver-

tical mounting, rear or back-to-back coupling.

Or, you may want the flexibility that 5 different center-to-center spacings offer you. You can have 10, 12.5, 15, 17.5 or 20 mm in non-lighted switches. Lighted pushbutton switches are available in 15 or 20 mm. For interlock and lockout functions, Centralab is your clear choice. We not only offer you momentary, push-push and interlocking action switches, but four types of lockout as well.

You'll find some of the brightest benefits in our lighted pushbutton switches. First, we supply both white and black lamp

housings with a variety of filters and lenses for the precise control of light output over a wide range of ambient light conditions. And the snap-in lens permits relamping through a front panel. Our shock-mounted filament lamps are designed for low maintenance and long life.

The lamp circuit can be integral or separate from the pushbutton switch circuit. Where it's integral, lamp and switch circuits are in the same terminal plane and can be flow soldered simultaneously for easier installation and service.

If you're looking for the boundless variety that means true design flexibility, we've got your kind of pushbutton switch. We'd like you to know about our epoxy sealed terminals, selective pin cutting, wrap-around support bracket, dust-seal covers, line switch and 25 button styles in 18 colors. And how we can furnish legends for buttons, filters or lenses. We've put it all in a new 24 page catalog that includes complete specifications, dimensional drawings and ordering data. It's yours for the asking. Just circle the information service card or write Centralab for Catalog 1550P. Put some spice in your life.

INFORMATION RETRIEVAL NUMBER 209

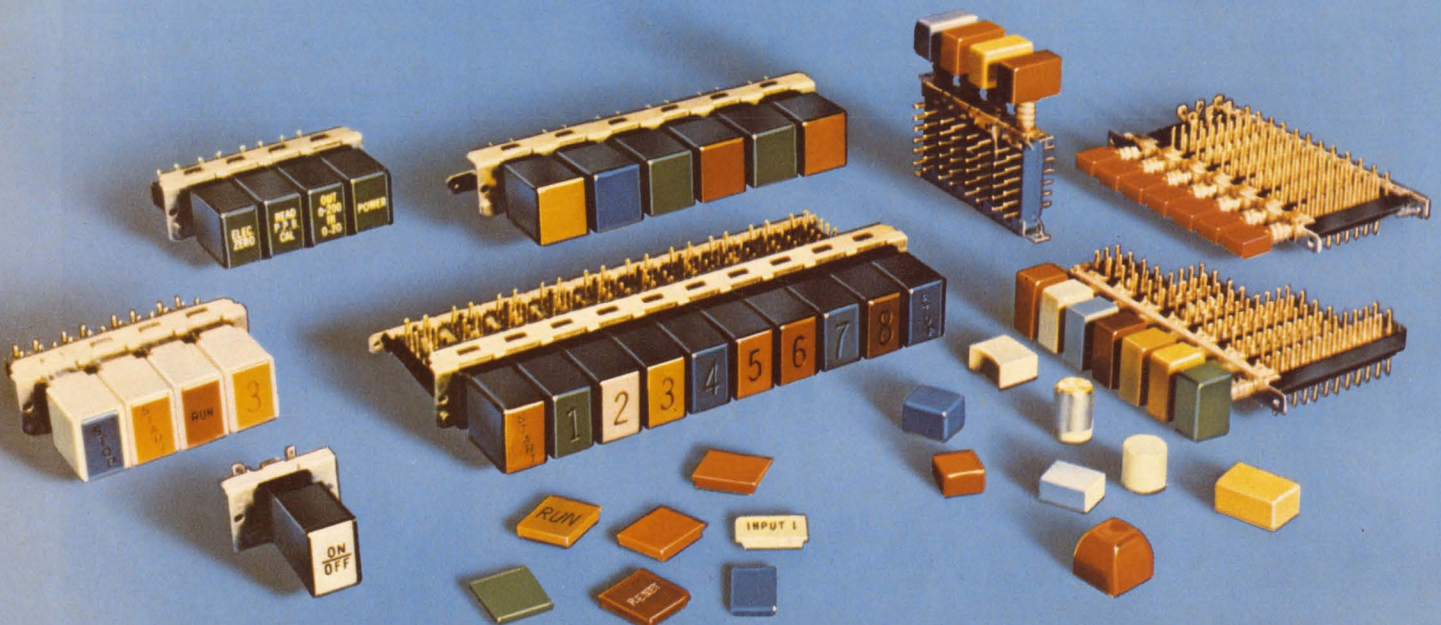

\*Isostat licensed

# More than 6,000,000 good reasons...

## To insist on RCA Rectifiers and SCR's for your fast-switching applications.

If you have an immediate need for fast-switching devices, come to RCA where large quantity production of quality products is a way of life.

We produced over six million fast-switching thyristors for TV production during the past twelve months ... and millions of fast-switching rectifiers and SCR's for other industry needs during the same period.

These low cost dependable devices represent a lot of good reasons why you should insist on RCA Thyristors and Rectifiers.

Want more good reasons?

RCA offers a large selection of fast-switching devices for your most demanding applications. High-speed inverters, choppers, high-current pulse circuits, or "free-wheeling" diode circuits ... whatever your needs

are ... you'll find the right SCR or rectifier to match your circuit design.

RCA's all-diffused SCR's bring you the best combination of features ...

- fast turn-off time
- high di/dt and dv/dt
- high peak current capability
- exceptional uniformity and stability of characteristics

Match this combination with RCA's fast recovery rectifier features ...

- low reverse-recovery current
- low forward-voltage drop
- low thermal-resistance design ... and you can rest assured that your equipment is backed by the industry's leader in fast-switching technology.

No need to be concerned about quantity, availability, or cost. RCA fast-switching devices are available in quantity ... at prices you can afford.

Want more information? Write: RCA Solid State, Section 57A-4, Box 3200, Somerville, N.J. 08876. Or phone: (201) 722-3200,

Fast Switching SCR's		40555	S3704	S5210	2N3653	2N3658
Package		TO-66	TO-66	¼" stud	TO-48	TO-48
I <sub>RMS</sub>		5 amps	5 amps	10 amps	35 amps	35 amps
T <sub>OFF</sub> (Microseconds)		2-6	6-10	5-10	10-15	6-10
1K Price:	200V	1.67	.90	3.00	7.24	7.89
	600V	2.89	1.30	12.20	15.60	17.20

Fast Recovery Rectifiers		TA7895	44938	43884	43894	43904	40960
Package		DO-26	DO-15	DO-4	DO-4	DO-5	DO-5
I <sub>AV</sub>		1 amp	1 amp	6 amps	12 amps	20 amps	40 amps
T <sub>RR</sub> (Nanoseconds)		50-500	150-500	150-350	150-350	150-350	150-350
1K Price:	200V	.44	.42	1.79	2.42	3.20	3.40
	600V	.72	.66	3.13	4.37	6.00	6.70

**RCA Solid State**  
products that make products pay off

International: RCA, Sunbury-on-Thames, U.K., or Fuji Building, 7-4 Kasumigaseki, 3-Chome, Chiyoda-Ku, Tokyo, Japan. In Canada: RCA Limited, Ste. Anne de Bellevue 810, Canada.

INFORMATION RETRIEVAL NUMBER 37

# Flat-panel TV promises are back, but this time they could be for real

Flat-panel television displays? Engineers have been hearing of the promise for at least a decade. But now it may be approaching reality. Such displays could start appearing in TV applications in about five years, according to participants in the Image Transducer and Optoelectronic Devices Sessions at the recent International Electron Devices Meeting in Washington, D.C.

John Pittman, a design engineer and now product marketing manager for Burroughs Corp. in Plainfield, N.J., noted that there were still a few problems that kept flat-panel TV displays from becoming a commercial reality. The biggest is increasing the luminous efficiency of the panels.

---

**Jules H. Gilder**  
Associate Editor

Pittman, who organized one of the sessions, said luminous efficiency for gas-plasma displays was now about 0.11 lumens per watt. At that value, a 2-by-3-foot display would require 3 kW of power. An increase in efficiency of at least an order of magnitude is needed before such displays become practical for TV applications, Pittman said.

Another major problem, he noted, is that television manufacturers are primarily interested in a color display, which is much more difficult to make. Colors can be achieved by adding phosphors, but they may also reduce the intensity of the display.

According to Pittman, flat-panel displays could start to appear commercially in about five years, but it will probably take up to 10 years to get into volume production.

An interesting approach to the flat-screen display was discussed by Yoshifumi Amano, an engineer for the Sony Corp. in Tokyo. The system he described uses a dc gas-discharge panel that consists of about 60,000 picture elements—212 by 282. The size of the picture is 105 by 140 mm.

According to Amano, ac plasma displays were not considered for this application because it is difficult to get a finely graded gray scale with them. With the dc panel, however, brightness control can be achieved by variations in the magnitude and duration of the display cell current, he explained.

## Flat-panel TV built

In a prototype flat-panel TV set built by Sony, every TV field is converted into a 4-bit BCD signal by an analog-to-digital converter. This results in a digital signal that can represent 16 amplitude levels, or shades, of gray. However, by use of a new technique known as level-shifted field switching, Amano reported, it is possible to double the number of gray levels. In practice, the a/d converting level and the current magnitude of the driver circuits are shifted to interlace with those of the odd field. The picture is then spatially interlaced in the X direction, he explained, so that the number of brightness, or gray, levels was doubled to 32—about the same number that present home TV receivers display.

The maximum brightness of the Sony display is 25 ft-L, which compares with 200 ft-L for the CRT in television sets. The contrast ratio of the flat display is 40:1.

An unusual feature that distinguishes the Sony dc plasma panel is that it has barrier elec-

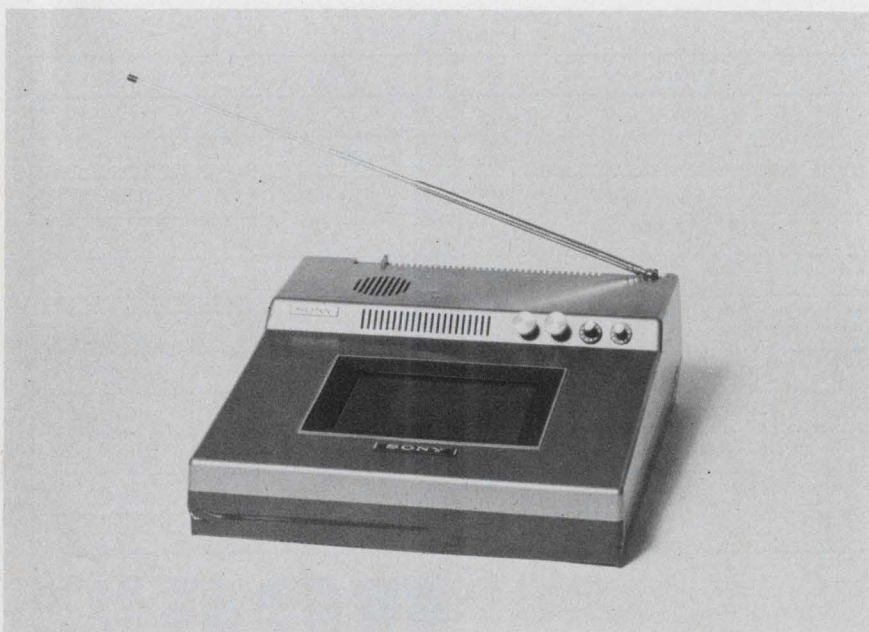

**Prototype dc plasma-panel TV** from Sony consumes 90 W of power—10 W for the panel and drivers and 80 W for the rest of the electronics.

# the 'best buy' counters are here!

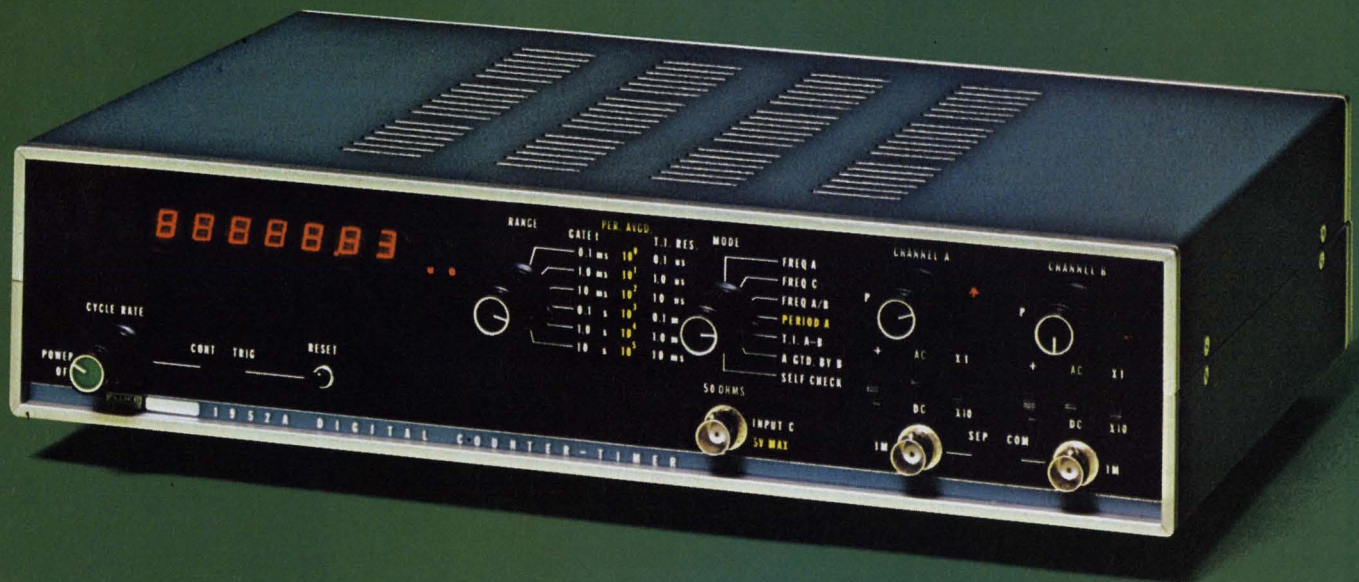

Now is the time for all of us to carefully consider every purchase.

For instance, if you are planning to purchase a new counter/timer, we invite you to take a flinty eyed look at the new Flukes. Nowhere in the entire market place are there better buys. Nowhere will you find a counter line where owner benefits are constantly raised and at the same time owner costs are being lowered.

Take our Model 1952 for instance. Here's an instrument which counts from DC to 80 MHz or 515 MHz optionally. It offers 50 mV sensitivity. It provides six functions: 1. frequency, 2. frequency ratio, 3. single period, 4. multiple period average, 5. time interval measurement, and 6. gateable totalize. Read-out is 7-digit LED or optionally 8 and 9 digits. Matched input channels feature full control of coupling, slope and trigger level. Features include units annunciation, overflow, gate and trigger level status lamps. Optionally you can add BCD output and a TCXO with improved temperature stability. Yet the base price is only \$695. Add every option we've got and you're still under \$1400.

Or look at our Model 1980A VHF/UHF Telecommunications Frequency Counter. Here's the precision instrument to service



mobile land, sea, and air communications systems quickly, accurately. Measure frequencies in the field or in the lab from 5 Hz to 515 MHz with a sensitivity of 50 mV over the entire range. Read frequency from a 6-digit LED display. For total portability, add a snap-on battery pack for completely portable operation with up to 5 hours continuous use. And the cost of this little gem is only \$795. Add all of the options and you're still under \$1200.

Then there's our blue plate special, the full five function Model 1950A. Measure frequency, frequency ratios, single periods, multiple period averages, or totals. Features include 6-digit LED display with automatic annunciation, variable trigger level control with status lamps and a switch selectable input attenuator. For field use, remember the instrument weighs only 5 pounds and will operate from 12 vdc.

Optional features include BCD output and TCXO for super stability as well as full accuracy. Price of the basic unit is just \$445. All the options are less than \$300 more.

So you see, the Fluke counter attack has been launched with a vengeance. Perhaps you should join our army.

In the continental U.S., dial our toll free number 800-426-0361 for the name and address of your nearest local source. Abroad and in Canada, call or write the office nearest you listed below, John Fluke Mfg. Co., Inc., P.O. Box 7428, Seattle, Washington 98133. Phone (206) 774-2211. TWX: 910-449-2850. In Europe, address Fluke Nederland (B.V.), P.O. Box 5053, Tilburg, The Netherlands. Phone 013-67-3973. Telex: 844-52237. In the U.K., address Fluke International Corp., Garnett Close, Watford, WD2 4TT. Phone, Watford, 33066. Telex: 934583. In Canada, address ACA, Ltd., 6427 Northam Drive, Mississauga, Ontario. Phone 416-678-1500. TWX: 610-492-2119.



trodes and glass barrier ribs to prevent electrical and optical crosstalk—a problem with plasma displays. The barrier electrodes are placed on the front panel glass—as are the anodes—and are connected in common and biased to a suitable dc voltage level. The glass barrier ribs, on the other hand, are placed on the rear glass panel—as are the cathodes. When the two plates of glass are sandwiched together, the glass ribs come in contact with the barrier electrodes of the front panel; the height of the ribs determines the spacing between the two plates. The two plates are then sealed together and filled with a mixture of neon-argon gas.

Amano noted that the orange color of the resulting display was not particularly pleasing but that this could be remedied by deposition of phosphors on the sides of the ribs. The addition of phosphors—which are excited by the ultraviolet energy released by the discharge—results in a black-and-white or color picture, depending on which phosphors are chosen.

When questioned on the commercial availability of flat-screen television sets, Amano noted that the prototype constructed at the Sony research laboratory was only 80 mm thick (see picture). He hastened to add, however, that commercial versions were still off in the future.

### Color techniques investigated

Work on multiple-color gas discharge panels, which would replace cathode-ray tubes in television sets, was described in a paper by Thomas C. Maloney, a designer with Burroughs. In "Color Techniques Utilized in Gas Discharge Panels," he noted the special characteristics that gases and phosphors need to achieve a successful color system.

Phosphors, he pointed out, must exhibit a high conversion efficiency, stability to long-term discharge radiation and adaptability to a variety of deposition techniques. In addition they must be inexpensive and highly transparent.

For gases, some key requirements are that they be transparent to the exciting radiation, produce high photon energies of excitation

in the region of high conversion efficiency of the phosphor and have a low sputtering yield, Maloney noted.

Experimental systems using different phosphors have yielded displays with two colors—green and white, the Burroughs designer reported. Panels using zinc orthosilicate phosphor on the cell walls have yielded a green output of 18 ft-L when operated at a 1% duty cycle, according to Maloney. White panels can also be made, he said, if the luminous output of a 10% xenon-neon gas discharge is combined with the green output of a zinc orthosilicate phosphor. The white light produced will have an intensity of 25 ft-L, Maloney said.

### Liquid crystals being used

Not all the action in flat-panel displays, however, is in plasma devices. Michael N. Ernstoff, a project engineer with Hughes Aircraft Co., Culver City, Calif., described a liquid-crystal pictorial display intended to replace conventional CRTs. In fact, he said, the reflective liquid-crystal display promises performance that is superior to that of the CRT.

According to Ernstoff, some key advantages of the liquid-crystal pictorial display are high contrast and resolution, low power and weight and good visibility. The image does not wash out under illumination by direct sunlight, he reported.

The Hughes display is 1 × 1 inch with a resolution density of 100 picture elements per inch, for a total of 10,000 elements. Large displays would be made of a mosaic of these small display units, Ernstoff said.

Hughes formed its display unit by sandwiching a thin layer of nematic liquid-crystal material between an array of reflective electrodes and transparent conductive electrodes. In the OFF state, with no electric potential applied to the electrode, the liquid-crystal material is clear and the cell appears black, because of black specular reflection. In the ON state, an electric potential is applied and the liquid crystal appears white—just how white is determined by the magnitude of the applied potential. At present only five or six shades of gray are possible, Ernst-

off noted, but that will be increased with further development.

Since standard video signals carry information in serial form, he went on, it is necessary to perform a serial-to-parallel analog conversion to make the signal compatible with the display.

While Ernstoff did not discuss commercial plans for the display, another engineer on the project, Henry T. Peterson, did speculate that for specialized applications, a 10-inch diagonal screen might be commercially feasible in about three years.

### Thin-film approach studied

Another approach to flat-panel television displays was outlined by T. Peter Brody, manager of the Thin Film Devices Dept. at Westinghouse Research Laboratories, Pittsburgh. In his presentation at the conference, Brody discussed a 6-by-6-inch thin-film transistor electroluminescent display panel. The 6-inch-square display contains 12,100 image elements.

Each display element, Brody reported, has integrated with it a thin-film driver transistor, a logic transistor and a storage capacitor. This forms a single circuit containing about 24,000 active and 12,000 storage elements.

Although this thin-film approach is being used with an electroluminescent display, Brody was quick to point out that it could be used with almost any display that emits or modulates light. The reason, he explained, is that the thin-film circuit goes right on the display panel, which, in effect, becomes a gigantic IC.

What this approach offers is the ability to control individual picture elements in an analog instead of digital mode. In plasma panels, for example, the bipolar nature of the device is generally used and individual elements are either ON or OFF. Shades of gray scale are difficult to achieve. In the thin-film electroluminescent display, however, the gray scale is inherent in both the phosphor and the driving circuit.

Another big potential advantage of the thin film approach is the possibility of integrating scanning circuitry onto the panel as well, thereby drastically reducing the total of external connections. ■■



## Compact rack and panel connector provides high density, reliability and performance...at low cost.

The AMP HDP-20 connector provides economical, high-density rack and panel interconnections for a variety of data processing, instrumentation and control system applications. Contacts are as close as .109-inch between centers. And economy is achieved through the use of stamped and formed contacts which are machine-applied at rates up to 4000 an hour.

HDP-20 connectors with size-20 contacts are available in 9, 15, 25, 37 and 50 positions—with low-cost hardware, such as strain reliefs, hoods, shields, latches, and so forth.

Connectors can be supplied preloaded as desired or empty and ready for loading. A rear-release plastic retainer eliminates the need for spring clips.

Conical tip of HDP-20 pin contacts eliminates stubbing, offers intermateability with other size-20 sockets.



# If you're going rack and panel, reasons to go with

More and more electronic equipment is being designed with "slide-out" circuitry. The principal virtue of the technique is that it permits greater economy of production through mechanized assembly of individual system modules. And economy with reliability is the name of the game with AMP connectors. Economy that has as its basis automated machine termination and wiring of individual contacts and posts.

A good example is the CHAMP 25 pair connector, a product that has created widespread interest for use in data and

communications links and in computer and telecommunications equipment.

The CHAMP connector, like many AMP connectors, has a unique method of termination which is the real basis for low applied cost. The CHAMP connector employs a ramp-like contact with built-in insulation cutting bar which permits an unstripped solid wire—and certain kinds of stranded wire—to be fully terminated at high speed by a semiautomatic machine. In addition to being more economical, CHAMP connector

*"Funnel-shaped" area displaces insulation.*

*Conductor extrudes into narrow, bottom part of slot.*

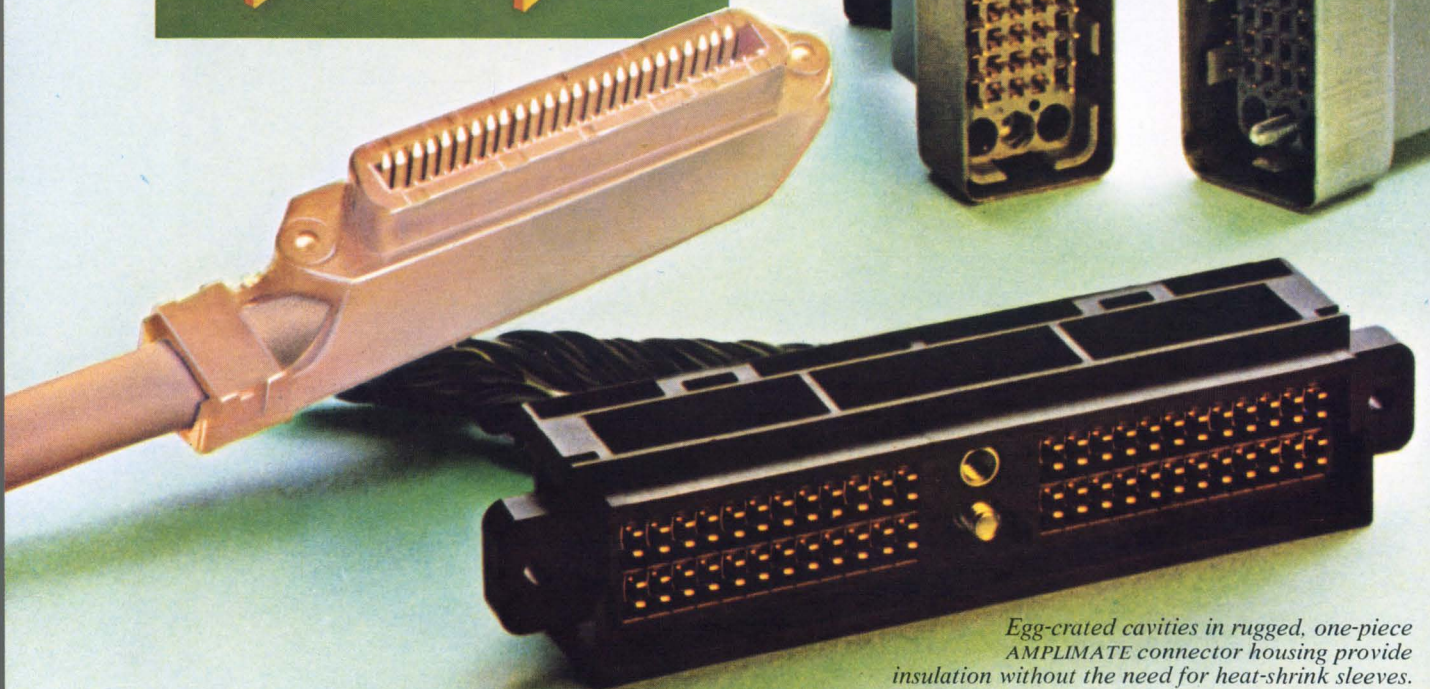
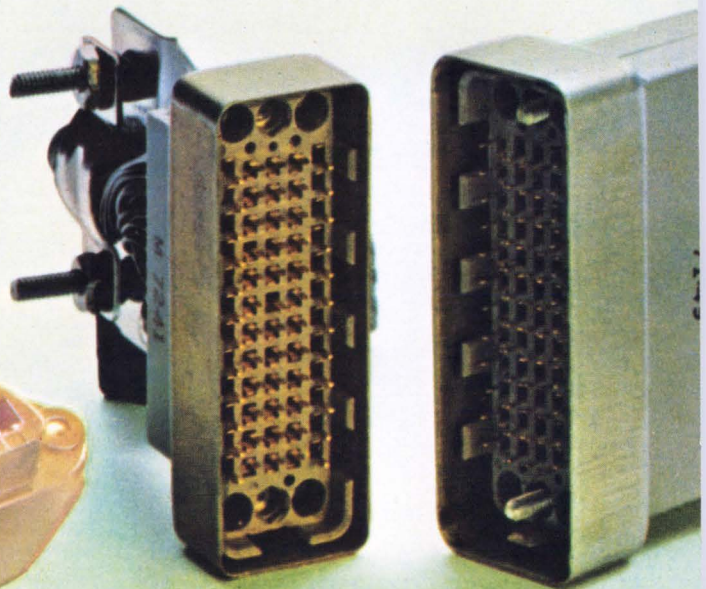
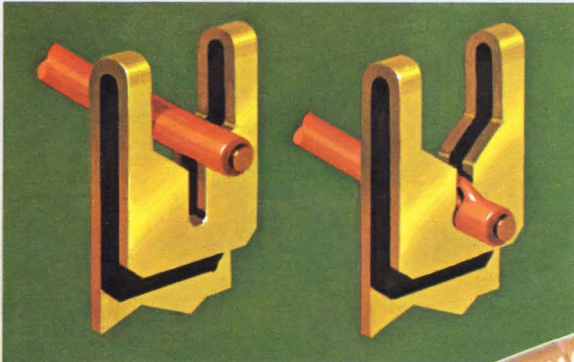

*Egg-crated cavities in rugged, one-piece AMPLIMATE connector housing provide insulation without the need for heat-shrink sleeves.*



# here are some economical AMP connectors.

terminations offer excellent density and vibration resistance. Individual contacts may be removed and replaced easily with minor disruption to total connector interfaces.

Another way to realize economy is through the use of hermaphroditic contacts. Since both connector halves use the same contact, inventories are reduced. Two cases in point are the AMP miniature DUALATCH connector and the AMPLIMATE connector. Not only are their self-wiring contacts hermaphroditic; they can also be applied by high-speed, automated machines.

And economy is matched by versatility, because of the compactness and wide range of housing configurations.

Machine wiring is still another way to get economical interconnections. Both the AMP High Density Rectangular connector and the AMP M Series connector fit into this category. Both are available with post-type contacts which can be automatically machine-wired. In addition, each can be selectively loaded, so that even further economies can be realized.

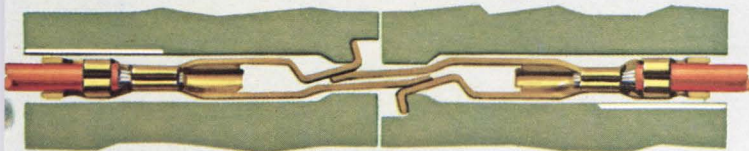

*Positive wiping action and gold-over-nickel plating of miniature DUALATCH contact ensure excellent electrical and mechanical performance.*

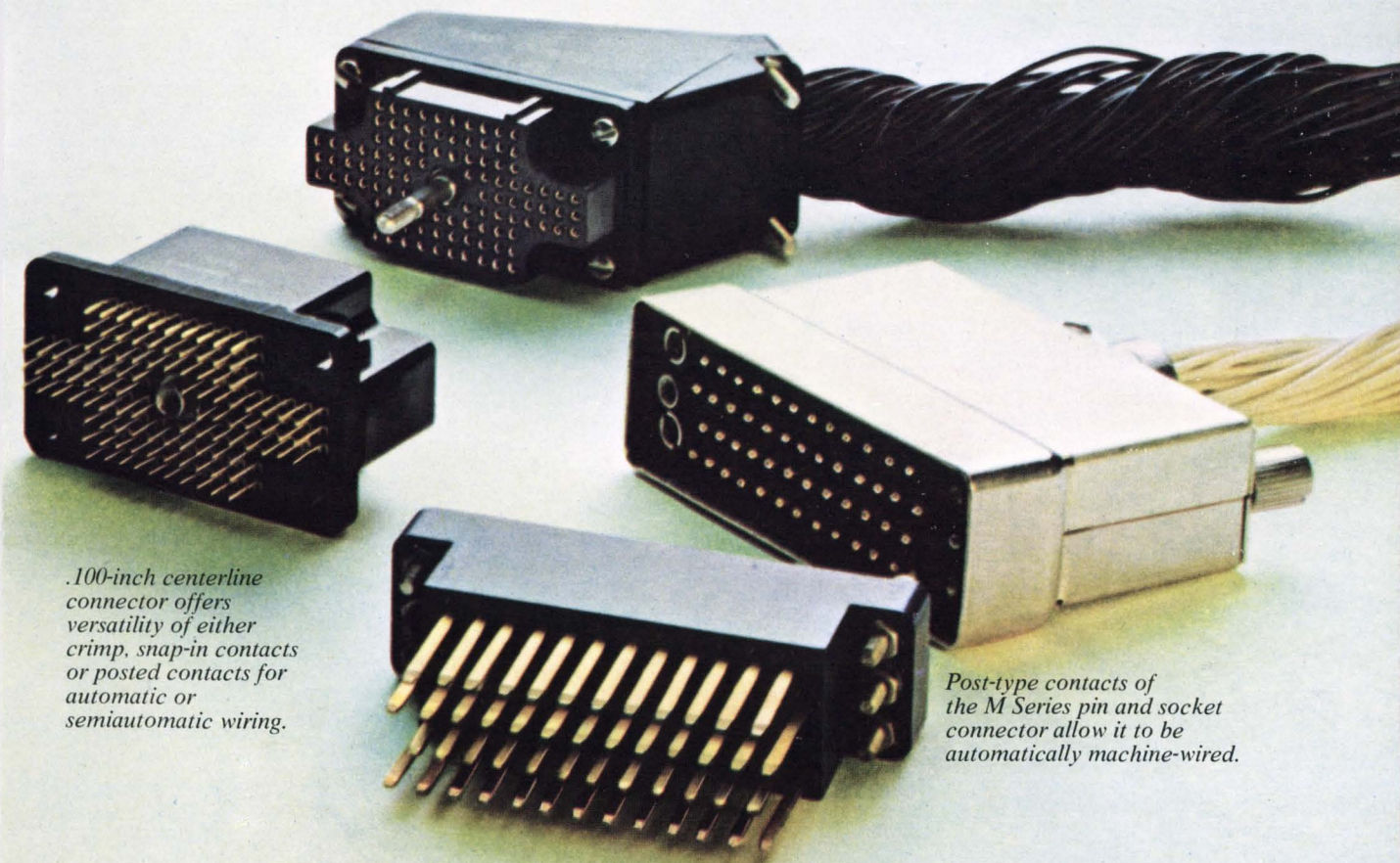

*.100-inch centerline connector offers versatility of either crimp, snap-in contacts or posted contacts for automatic or semiautomatic wiring.*

*Post-type contacts of the M Series pin and socket connector allow it to be automatically machine-wired.*

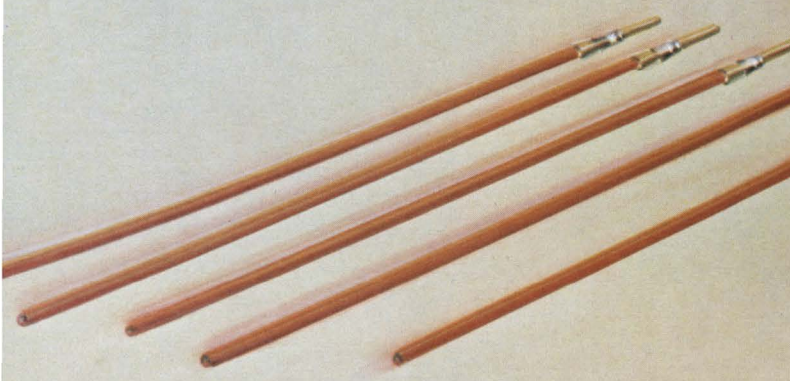

# "Economy" can mean many things to many people.

With AMP products it means low applied cost. Which comes about through better, faster, automated wiring and termination methods, often providing even better, more consistently reliable performance. With no sacrifice in product quality. Design and production knowhow provides little extra touches like redundant spring tines for greater retention, special selective platings for reasonable cost, and positive wiping contacts to ensure good, reliable electrical performance for thousands, even tens of thousands, of matings.

Finally, you get a worldwide sales and service organization that ensures customer satisfaction and product standards wherever electrical and electronic connectors are used.

If you'd like specific information about any of the products or machines in this advertisement or about the company as a whole, please write AMP Industrial Division, Harrisburg, Pa. 17105. Or circle Reader Service Number 160.

# AMP

INCORPORATED

AMP, AMPLIMITE, CHAMP, DUALATCH, AMPLIMATE, TERMI-POINT, AMP-O-MATIC and AMPOMATOR are trademarks of AMP Incorporated.

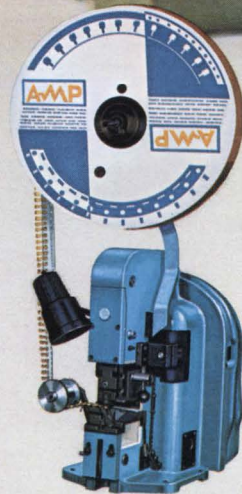
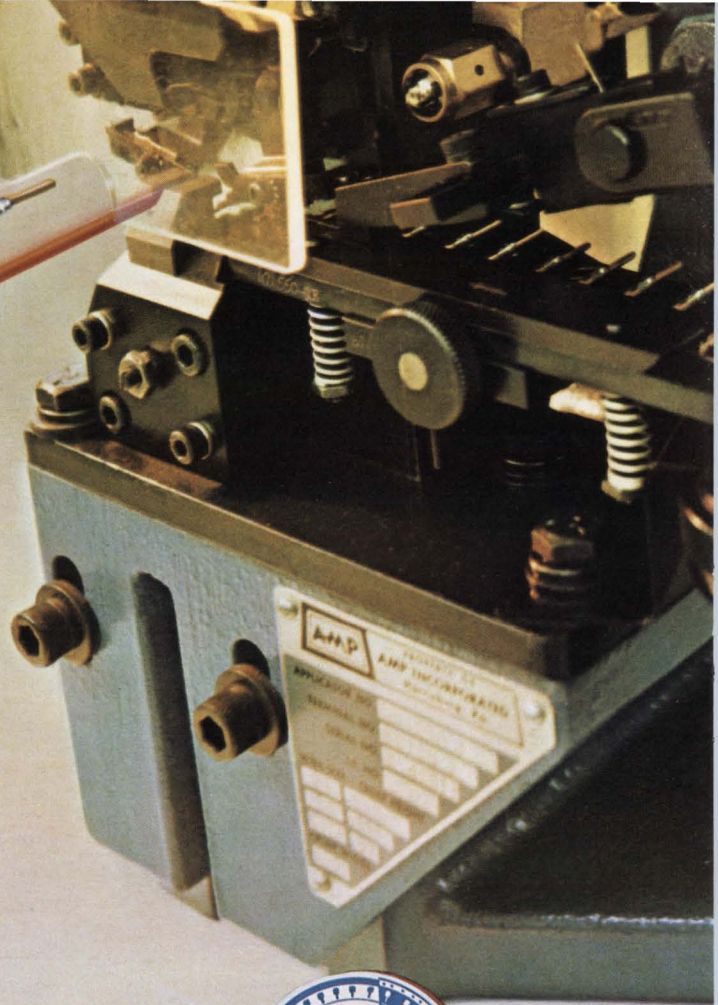

*AMP-O-MATIC stripper/crimper machine strips wire and attaches contact during each machine cycle—at rates up to 1500 an hour.*

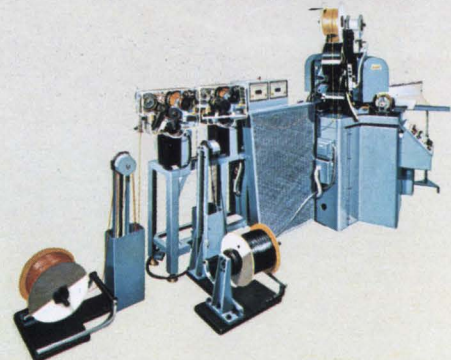

*AMPOMATOR machine with miniature applicator can produce up to 5700 doubly-terminated leads an hour.*

# THERE'S A BETTER WAY TO GO.

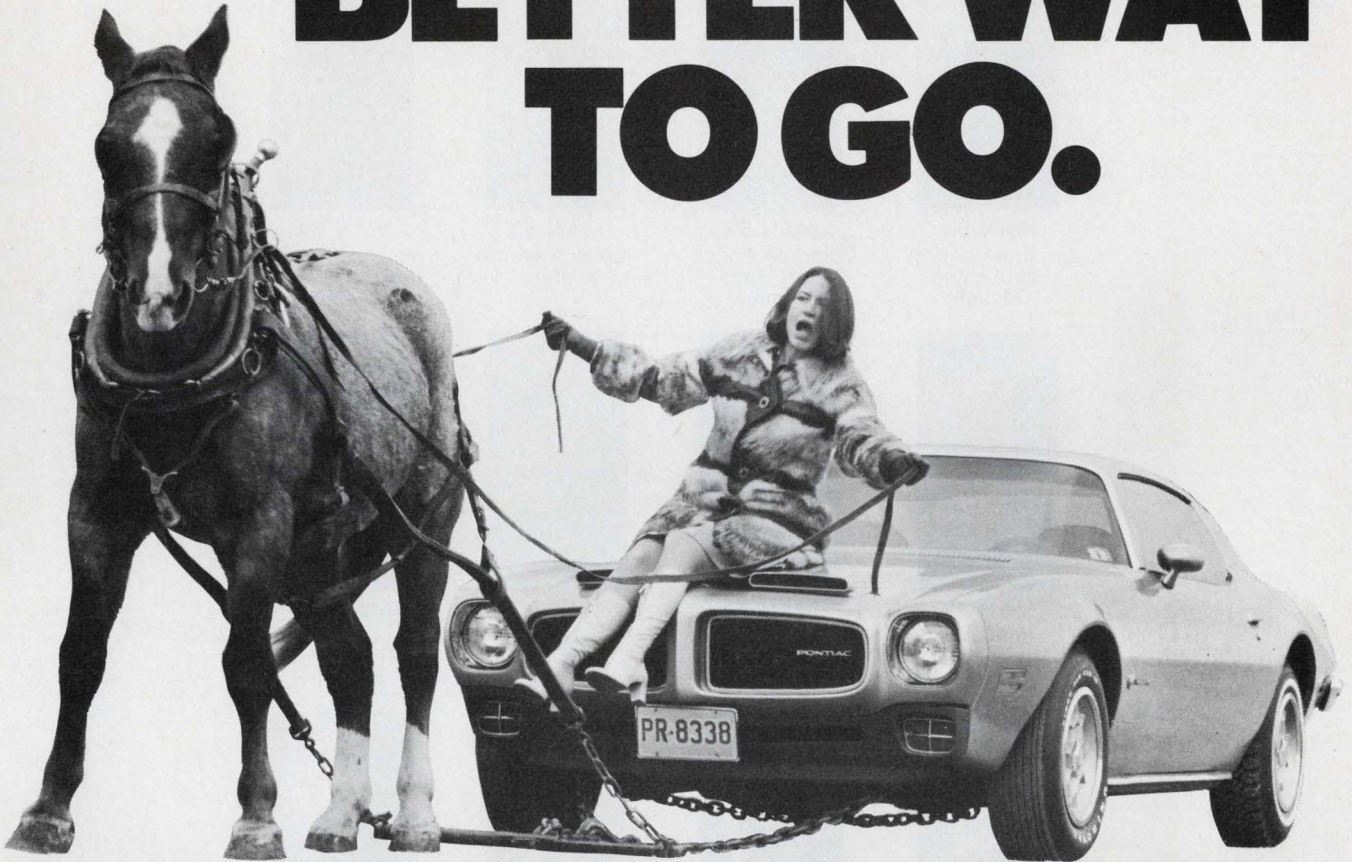

Energy shortages tell us we have to change our driving style. Now! It doesn't mean we have to go back to horse and buggy days. But it does mean we have to make every drop of gas give us the most go for our money. Anyone with horse sense knows that a well-tuned car gets better mileage, and in times of fuel shortages, better mileage means a lot.

The Mark Ten B Capacitive Discharge System keeps your car in better tune so it burns less gas. Using Mark Ten B is more than horse sense. It's the smart move under the hood, helping a nation survive an energy crisis and keeping you on the road. Delta Mark Ten. The best way to go.



## DELTA PRODUCTS, INC.

P.O. Box 1147, Dept. ED  
Grand Junction, Colo. 81501  
(303) 242-9000

Please send me free literature.

Enclosed is \$\_\_\_\_\_  Ship ppd.  Ship C.O.D.  
Please send: \_\_\_\_\_ Mark Ten B assembled @ \$59.95 ppd. \_\_\_\_\_ Mark Ten B Kit @ \$44.95 ppd. (12 volt negative ground only) \_\_\_\_\_ Standard Mark Ten assembled, @ \$44.95 ppd. \_\_\_\_\_ 6 Volt: Neg. Ground Only \_\_\_\_\_ 12 Volt: Specify \_\_\_\_\_ Pos. Ground \_\_\_\_\_ Neg. Ground \_\_\_\_\_ Standard Mark Ten Deltakit® @ \$29.95 ppd. (12 Volt Positive or Negative Ground Only)

Car Year \_\_\_\_\_ Make \_\_\_\_\_

Name \_\_\_\_\_

Address \_\_\_\_\_

City/State \_\_\_\_\_ Zip \_\_\_\_\_

# Twelve new answers for the display designer

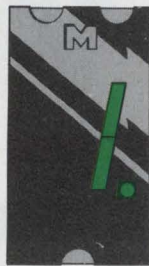

**MAN 51**  
Common Anode;  
Right Hand  
Decimal



**MAN 52**  
Common Anode;  
Left Hand  
Decimal



**MAN 53**  
Common Anode;  
Overflow ( $\pm 1$ )



**MAN 54**  
Common Cathode;  
Right Hand  
Decimal



**MAN 71**  
Common Anode;  
Right Hand  
Decimal



**MAN 72**  
Common Anode;  
Left Hand  
Decimal



**MAN 73**  
Common Anode;  
Overflow ( $\pm 1$ )



**MAN 74**  
Common Cathode;  
Right Hand  
Decimal



**MAN 81**  
Common Anode;  
Right Hand  
Decimal



**MAN 82**  
Common Anode;  
Left Hand  
Decimal



**MAN 83**  
Common Anode;  
Overflow ( $\pm 1$ )



**MAN 84**  
Common Cathode;  
Right Hand  
Decimal

Introducing twelve new .3" displays: sharp looking readouts in narrower packages; common cathode or common anode; right hand or left hand decimal; red, yellow and green. All from Monsanto, where light-emitting diode displays got started, and all priced at \$2.70 (suggested distributor price for 1,000-lot OEM orders.) Get in touch with any of our distributors: Alta, Elmar, Hamilton/Avnet, Hammond, Kierulff, Kierulff/Schley, Liberty, Schweber, Semiconductor Specialists, Wesco; Cesco in Canada; and Havulina Oy, Helsinki;

Neye-Enatechnik, Hamburg; Nordisk Elektronik, Stockholm; Omni Ray, Switzerland; RTF, Paris; Scansupply, Copenhagen; Silverstar Ltd., Milano; Techmation, Brussels; A.F. Ulrichenson, Oslo; New Metals and Chemicals Ltd., Tokyo; Takachiho, Tokyo.

**Monsanto Commercial Products Co.,**  
Electronic Special Products,  
3400 Hillview Avenue,  
Palo Alto, CA 94304,  
(415) 493-3300/TWX 910-373-1767.

*Putting innovation to work.*

## Monsanto

INFORMATION RETRIEVAL NUMBER 40

# washington report



Heather M. David  
Washington Bureau

## The annual compromise on defense nears

The fate of several major electronic projects for the Defense Dept. hangs in the balance as House and Senate conferees meet to reconcile differences in the two versions of the defense appropriations bill. The House voted to kill the Navy's much-beleaguered ELF Sanguine communications project—a system for communicating with submarines. The system requires antennas that must lie slightly buried in a territory consisting of many square miles. The Senate committee, however, voted \$16.6-million to continue research on the project—without funds for installing it anywhere. The reason: cancelling Sanguine would deprive the Navy of the only known survivable way of communicating with submerged submarines worldwide, the committee says.

Another project supported by the Senate and not by the House is a \$110-million fund for the Site Defense Program, a small antiballistic missile system designed to protect Minuteman missile sites. Deputy Defense Secretary William Clements has told the Senate committee that the Pentagon places a high priority on the program as “a timely and credible hedge against the abrogation by the Soviet arms treaties.”

The House also wants to kill a plan to put a phased-array radar on the east coast and another on the west coast, to detect submarine-launched ballistic missiles. The House committee says that present warning systems are adequate. The Pentagon says that “all points in the Continental U.S. are now subject to submarine-launched ballistic-missile attack without warning from the Pacific Ocean and the North Sea.”

Over-all, the Senate bill would give the Defense Dept. \$73.3-billion for fiscal 1974, the House bill would provide \$74.1-billion.

## U.S. aid for jobless engineers under attack

The Labor Dept. is debating whether to continue a program to help unemployed scientists, engineers and technicians, a question now complicated by a lack of data on the possible effects of the energy shortage. The \$42-million aid program was created two years ago in the face of widespread unemployment in the aerospace and defense industries. At that time the Labor Dept. estimated that between 75,000 and 100,000 aerospace and defense employees were jobless. The General Accounting Office, however, in a just-released report, terms the aid program only partly successful. It notes that about 30,000 professionals were aided in finding work but that “this figure may be inflated.”

Some of the problems in placing the unemployed, the report says, were caused by the fact that aerospace engineers were reluctant to move into other fields, hoping instead that the industry would bounce back and they

would be reinstated. The GAO says the Labor Dept. did not make adequate use of nationwide job banks and national engineer registries, nor did it adequately follow up individual cases. And although money was available to enable engineers to make job searches outside their own areas, much of it was not used.

## All-digital flight-control system to be tested

NASA's Office of Aeronautics and Space Technology will start testing the first all-digital flight-control system in an F-8 aircraft sometime this year. The space agency's Flight Research Center and Langley Research Center are doing preliminary design work and computer selection now for the all-digital system, which will be either triple or quadruple-redundant. Flight testing of a digital system with an analog backup was completed last November. Questions now being worked out in design are how to ensure safety even after computer breakdown. Technology developed in the program will one day be applied to design of a system for the next generation jumbo airliners beyond the Boeing 747 and Lockheed 1011, NASA officials say. The system is expected to result in a potential weight savings of 20%.

## FBI automating fingerprint searches

The Federal Bureau of Investigation is planning to finance the development of several automatic fingerprint systems, based on a prototype developed specifically for the bureau. The system employs a preprocessing unit that uses optical-scanning and image-enhancement techniques to identify key characteristics of fingerprints. The information is relayed to a DEC PDP-15, which matches the data with stored records of fingerprints on file. The FBI now employs more than 3000 people to search manually the 25,000 or so fingerprint inquiries it handles each day and compare them with the 20 million prints it has on file. The new equipment is expected to take only about one-half second to locate a matching print, if there is one.

**Capital Capsules:** The Aerospace Corp. is looking for R&D sources to design a truck antihijacking system. Companies with experience in intrusion sensors, vehicle-location systems, digital communications, systems analysis and other related capability are being solicited. . . . NASA will proceed this year with the launch of the second Earth Resources Technology Satellite (ERTS-B) following approval by the Office of Management and Budget. ERTS-1, NASA says, already has exceeded its design lifetime by several months and could die any day. . . . Comments on a new emergency medical communications system for hospital and ambulance radio communications have been invited by the Federal Communications Commission. . . . A contract award for the Airborne Warning and Control System (Awacs) airborne computer, which will be designed to hook into the military command and control network, has been postponed. Top defense officials want to have another look at the Air Force's plans. . . . The Air Force has signed a \$3.45-million agreement with the Dept. of Interior's Office of Coal Research for research on magnetohydrodynamics (MHD). Object is to show that a higher percentage of thermal energy can be extracted from coal by MHD than is now possible with conventional steam-generating plants.

# another handful ... with more measurement solutions

## THIS 5 MHz PORTABLE ADDS EXPANDED BANDWIDTH TO THE TEKTRONIX LINE OF MINIATURE OSCILLOSCOPES

You've got to keep your computer installation running; downtime is too costly to treat lightly. When it happens, you must get there with the proper troubleshooting equipment, find the problem and quickly correct it. The 221 from Tektronix will help get the job done.

At 5 MHz bandwidth, 5 mV/div sensitivity, and 1  $\mu$ s/div sweep, this battery-operated miniscope displays the waveforms encountered in today's computer environment.

Many operator conveniences save set-up time and make the display easy to interpret. The integral 1 M $\Omega$  probe is always there when you need it. Deflection factors are easy to read. Trigger level and slope are simplified in one rotary control. AUTO trigger mode automatically triggers the scope trace from its input signal. And in AUTO mode, a bright reference trace eliminates confusion. Rotate the switch out of AUTO mode and you can select any combination of trigger slope and trigger level. With all this, you carry just 3½ pounds.

In its 3" x 5¼" x 9" package, the 221 has rechargeable batteries. It can be operated and charged from practically any power source from 90 to 250 V, 48 to

62 Hz AC, or 80 to 250 V DC without switching. Double insulation protects the operator while making elevated voltage measurements. Its impact-resistant case absorbs the rough treatment you expect in field maintenance.

221 Portable Oscilloscope, including batteries and probe ... \$745  
Other 200-Series miniscopes offer 500 kHz bandwidth in single- or dual-trace, or dual-trace storage models.

Call your nearest field office for a look at the 221. Or write Tektronix, Inc., P.O. Box 500, Beaverton, Oregon 97005. In Europe, write Tektronix Ltd., P.O. Box 36, St. Peter Port, Guernsey, C. I., U. K.



**TEKTRONIX®**

committed to  
technical excellence

INFORMATION RETRIEVAL NUMBER 41  
FOR DEMONSTRATION, CIRCLE 221



# The go-anywhere, do-anything, easy-on-the-budget signal source



## Exact announces a new low-cost, fully portable function generator

Here's the perfect companion for your portable multimeter or oscilloscope. Exact's new Model 191 AC/DC Function Generator is equally at home on the bench, in the field operating on its own rechargeable batteries or plugged into your car's cigarette lighter.

Toss this rugged little signal source into your briefcase. Its light weight and small size make it the first truly portable function generator. It has a high-impact plastic case, and weighs just 4 pounds, including battery pack.

At a surprisingly low cost, the Model 191 and its companion AC Model 190 give you a full range of signal capability, including sine, square, triangle, pulse and ramp waveforms, VCF input, DC offset and TTL pulse output. Frequencies from 0.1 Hz to 1 MHz cover most of your signal requirements.

### check these features

**OUTPUT:** Sine, square, triangle, ramp and pulse, > 20V pp open circuit, > 10V pp into 600 ohms.

**TTL PULSE OUTPUT:** TTL compatible, < 25 ns risetime, will sink 20 TTL loads.

**SINE FREQUENCY RESPONSE:** < 0.1 db to 100 kHz, < .5 db 100 kHz to 1 MHz.

**SINE WAVE DISTORTION:** Typically 0.5%.

**SQUARE WAVEFORM:** Rise and fall time < 100 ns.

**VCF INPUT** (Voltage Controlled Frequency): Accepts d-c to wideband ac frequency modulation; approx 5V input for 1000:1 (three decades) frequency control.

**DC OFFSET:** Variable  $\pm 10V$ .

**VARIABLE TIME SYMMETRY:** For ramp and pulse operation.

**SIZE:** 7 $\frac{3}{8}$ " wide x 2 $\frac{7}{8}$ " high x 8 $\frac{1}{2}$ " deep.

**Model 190 (AC) \$245**

**Model 191 (AC/DC) \$350** complete with rechargeable battery pack and charger. f.o.b. Hillsboro, Oregon



(A Subsidiary of Danalab, Inc.)  
BOX 160, HILLSBORO, OREGON 97123  
(503) 648-6661 TWX 910-460-8811



# Quick Permanent Repairs with Confidence.

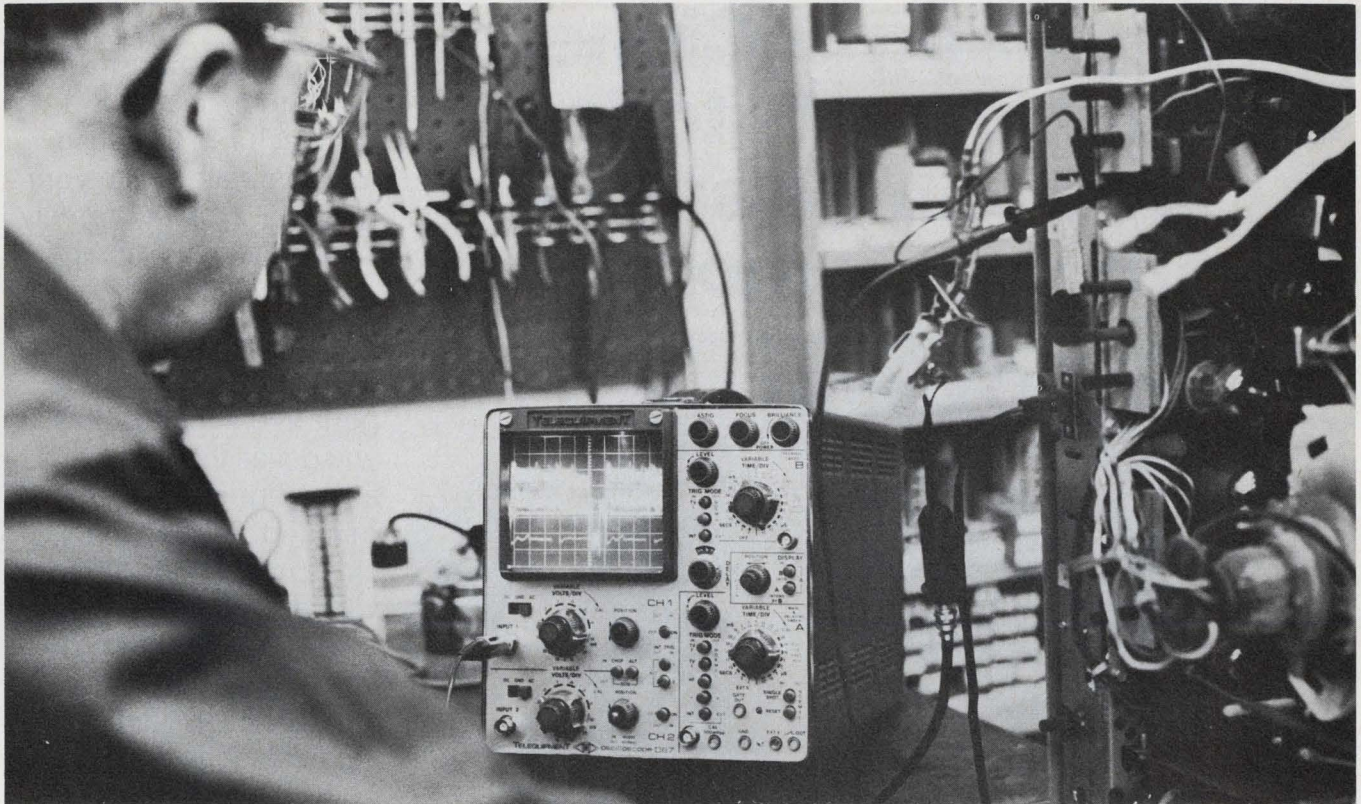

## The D67 ends troubleshooting guesswork in complex TV and audio circuits—at a low price.

TV and audio equipment servicing is outdistancing the capabilities of older test instruments. Also, greater use of electronics in consumer products (pocket calculators, microwave ovens, digital clocks, home intruder alarms, etc.) is opening up new service opportunities. Telequipment offers you the high performance you need in a low-cost scope for this new service business.

The D67 combines dual-trace, delayed sweep, and 25 MHz bandwidth, at a very low price. Non-delayed sweep scopes just can't compete with the D67's delayed sweep measurement flexibility. It allows quick, accurate troubleshooting of IF tuning and color bandpass problems. You can also see fast circuit conditions after relatively long time delays.

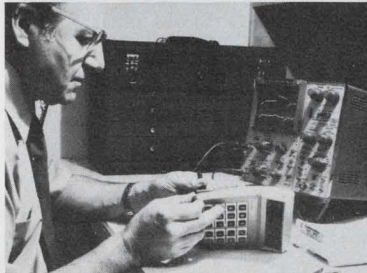

If you don't require delayed sweep but need dual trace at 25 MHz, here's another economical, quality scope—the D66. Troubleshooting consumer digital products such as mini-calculators is made easier by using dual trace. Also a "SUM" mode with normal-invert capability makes it possible to look at small signals in the presence of common mode noise—such as power supply hum.

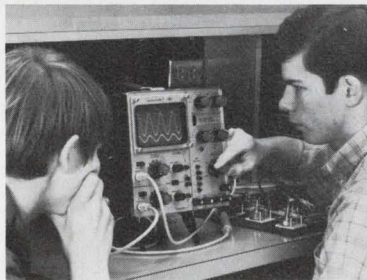

This simple to use, dual trace, 10 MHz D54 gives you low-cost, dependable performance in a wide variety of applications. Like all Telequipment scopes, it is light weight, easy to carry and is backed by Tektronix' warranty and reputation for quality. Students shown are testing amplifier circuit by measuring the gain between input and output signals.

Dual-trace waveforms displayed on a bright CRT are essential for servicing TV and high quality audio systems, where time and phase relationships between signals are critical. Whatever the consumer's electronic service problem, 25 MHz is probably all the bandwidth you will need.

Telequipment products are marketed and supported in the U.S. through the Tektronix network of 52 Field Offices and 35 Service Centers. Telequipment prices range from \$245 to \$1495. For a Telequipment catalog, and a reprint of the ET/D review of the D67, write: Tektronix, Inc., Box 500, Beaverton, Oregon 97005



INFORMATION RETRIEVAL NUMBER 43  
FOR DEMONSTRATION, CIRCLE 222

# If you're using Pertec, Wang or Cipher tape transports today, you can be saving money tomorrow.

You have a right to be skeptical. You've heard the claim before. But Microdata backs it up.

Microdata tape transports are priced lower than any other major manufacturer. Because we're plug-compatible with your OEM product, it's also extremely easy for you to take advantage of the savings we offer.

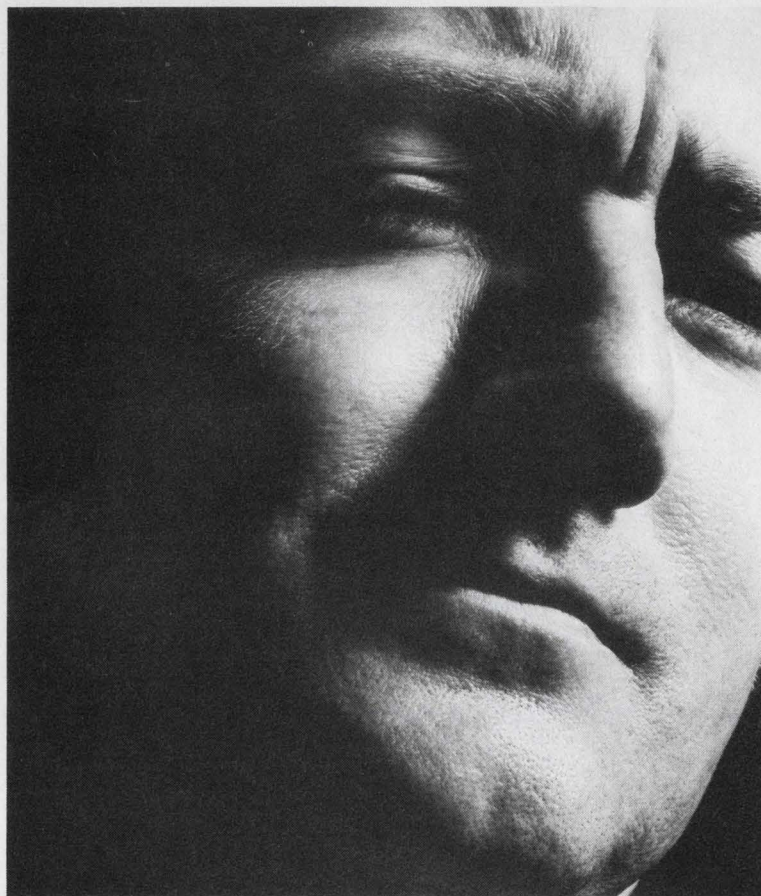

When you put Microdata 8.5" or 10.5" tape transports into your systems, you get all the performance and reliability you demand. At the same time, you pick up some very attractive sales features to build a strong competitive edge into your product. These include such welcome additions as dynamic braking. Full 200 inches per second fast forward and rewind. Trouble-free direct drive. The security of file protection. The accuracy of a forward and reverse electronic de-skewer. With the added convenience and economies of a Microdata formatter readily available.

If you want to start saving tomorrow, talk to us about price and delivery today. Or if you'd like more information first, send for literature and we'll include data on our new disc drives. With the same kind of impressive features, the same spectacular pricing as our tape transports. Microdata Corporation, 17481 Red Hill Avenue, Irvine, California 92705. Telephone 714/540-6730.

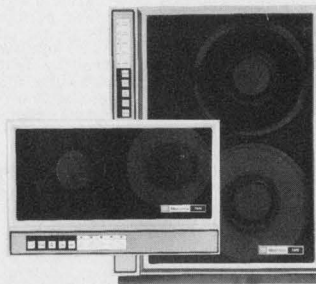

**Microdata.**  
**Bring us your  
problems.**

**And what a beautiful team!**

Recently Tektronix introduced to you two new time saving products, the Digital Processing Oscilloscope and the Tektronix Type 31 Programmable Calculator. Now, we have married them. Meet the Digital Processing Oscilloscope/31 Calculator (DPO/31).

How did we do it? First from our 7000 Oscilloscope family we took the 7704A 200 MHz mainframe, added a processor to digitize waveforms, and interfaced the processor with our Type 31 programmable Calculator. The complete assembly can be programmed to perform waveform calculations and measurements with the stroke of just a few keys.

Calculator programming is easy because Tektronix removed the program language barrier making it possible for you to communicate with the machine in the math language you grew up with. 24 user definable keys enable you to customize the calculator to meet your own specific needs.

Now, you can stop making waveform measurements by plotting or photographing and then doing your calculations point by point. Computations which presently take hours can be performed in just minutes.

By the way, there is no requirement to keep the DPO/31 constantly together. The calculator can be used all by itself just like any other scientific programmable calculator. Use the Digital Processing Oscilloscope as a stand alone unit to measure, store and playback waveforms. The DPO/31 adapts to you and your requirements.

Price depends on options and plug-ins chosen. A complete operating DPO/31 costs as low as \$11,745. For all the details on this versatile new package, use the reader service card, contact your field engineer or write Box 500A, Beaverton, Oregon 97005. In Europe TEKTRONIX LTD., Guernsey, C.I., U.K.



**TEKTRONIX®**

committed to  
technical excellence

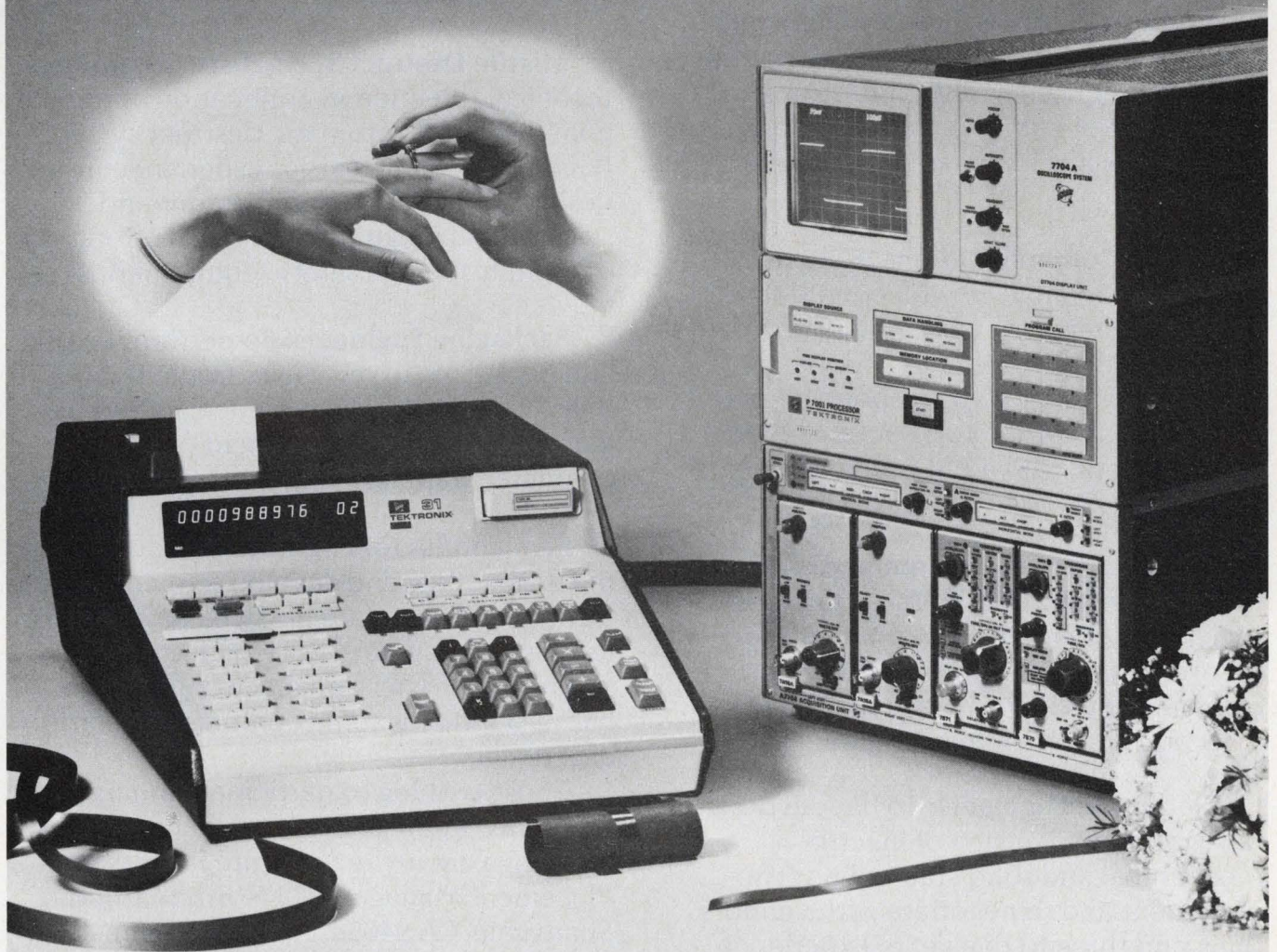

# JUST MARRIED

INFORMATION RETRIEVAL NUMBER 45  
FOR DEMONSTRATION, CIRCLE 223

# ELECTRONICS

Major programs at Lockheed Missiles & Space Company have created a number of positions for engineers possessing an unusually high level of ability in the following areas:

**Analog Circuit Design Engineers:** To develop solid-state designs for linear and non-linear circuit synthesis and analysis. BSEE and two years' experience.

**Analog Circuit Design Engineers:** To develop circuit designs on missile-destruct system electronic packages. BSEE and two years' experience.

**Communications Systems Engineers:** For communication systems and satellite transponder design. BSEE and strong knowledge of communication theory and microwave hardware from S-Band to K-Band.

**Senior Communications Systems Engineers:** To analyze wideband transmission systems for voice, video and digital data, including non-linear and linear distortion effects; to be responsible for selecting subcontractors for transponder development. MS or PhD and eight years' experience.

**Control Systems Equipment Development Engineers:** To design inertial components and handle electronic interface; to function as Responsible Equipment Engineers interfacing with subcontractors. BSEE and two to six years' experience.

**Electronic Engineers:** To handle design fabrication and testing of electro-mechanical and solid-state relays; to document and to negotiate with vendors. BSEE and three to five years' experience.

**Flight Control Systems Engineers:** To perform digital autopilot functional design analysis and simulation. BSEE and four years' experience.

## Guidance and Control Systems

**Engineers:** To design, analyze, test and evaluate guidance and control systems for advanced missile systems. BSEE and at least three years' experience in automatic control systems.

**Microelectronic Hybrid Parts and Components Specialists:** With at least three years' experience and detailed knowledge of microelectronic active and passive chips and other electronic parts in general; knowledge of related materials.

**Microwave Engineers:** To design microwave components such as tunnel diode amplifiers, mixers, upconverters, filters and equalizers. BSEE and four years' experience.

**Missile Destruct Specialists:** To provide technical direction in application of missile command and automatic destruct systems. BSEE and several years of experience in design or application of RF command systems and negotiation and interpretation of flight test range safety requirements.

**Packaging Engineers:** To perform layout and packaging of microelectronic hybrids. BSEE with six years' experience, including automatic drafting equipment or computer graphics.

**Semiconductor Engineers:** To document, negotiate and develop semiconductor devices and associate passive components for missile programs. BSEE with strong solid-state physics and electronic design background plus some computer operation experience.

Those wishing to participate in large programs offering severe technical challenge are invited to write Professional Placement Manager, 1184 North Mathilda, Sunnyvale, CA 94088. Lockheed is an equal opportunity F/M employer.

**LOCKHEED**  
**Missiles & Space Company, Inc.**

# PULSED LASER MEASUREMENT RESULTS IN MINUTES!

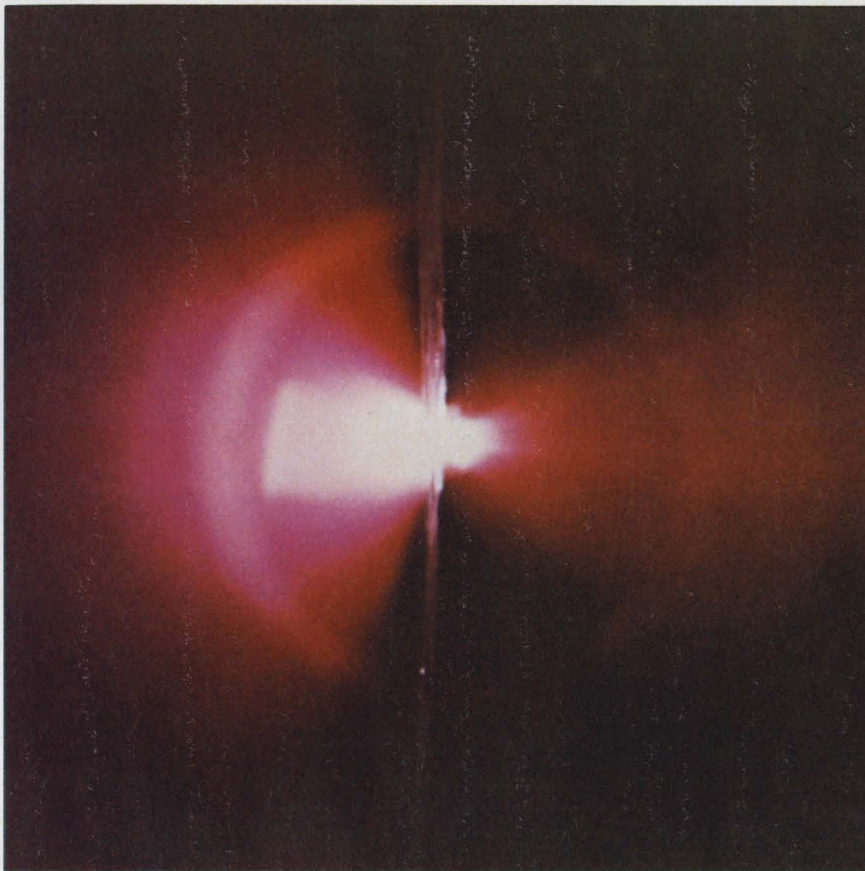

The TEKTRONIX R7912 Transient Digitizer represents orders of magnitude improvement in high speed transient measurements. It allows you to make your laser measurements quickly and easily—such measurements as checking switch-out effectiveness, looking for multi-modes, checking pumped amplifiers, and measuring effects on targets. One such target measurement is the study of particles generated from a plasma like that shown in the photo above.

Fast transient measurements can be viewed rapidly—with no need for photographs—whether your laser is running at a few pulses per second or single shot. The R7912 can be configured for direct viewing or for computer analysis. For repetitive signals (low or high rate), the TV mode offers large bright displays. For single transients, the digital display controller provides for viewing a refreshed display of the waveform on a monitor. For computer analysis, the PDP-11 interface allows waveform manipulation and measurement with Tektronix developed software.

The R7912 offers you the following measurement capabilities:

**Analog Bandwidth:**

1 GHz at 4 V/DIV  
500 MHz at 10 mV/DIV

**Resolution:**

320 by 400 lines  
512 by 512 addressable points

**Writing Rate:**

8 DIV/N sec—Digital Mode  
30 DIV/N sec—TV Mode

**Sampling Rate (effective):**

10 psec (100 GHz) or slower

Investigate the TEKTRONIX R7912 Transient Digitizer, it can make your pulse laser measurements easier and quicker. To obtain a copy of "New ways to see Fast Transients" and/or pertinent application notes, contact your Tektronix Field Engineer, use the reader service card, or write to Tektronix, Inc., P.O. Box 500A, Beaverton, Oregon 97005. Phone: 503/644-0161.

In Europe: Tektronix, Ltd., Guernsey, C.I., U.K.



  
**TEKTRONIX®**  
committed to  
technical excellence  
**SYSTEMS  
DIVISION**

Sure



# Guardian's number one in solenoids

The Guardian Angel put us in the winner's circle by offering you more types of solenoids . . . with more features . . . than anyone else in the world. Solenoids in every imaginable shape and size to meet any electromechanical requirement you can name. Solenoids with hefty 50 pound pull . . . or a fraction of an ounce. AC and DC. Intermittent or continuous duty. Pull or push or with switch attached. In more than a score of basic designs and 61 thousand variations! Plus specials to fit your specialized applications.

## ...but what have we done for you lately?

**NOW:** Virtually all Guardian Solenoids are recognized under the component program of Underwriters' Laboratories, Inc.

**NEW:** Uni-Guard Molded Coil Covers are now standard on most Guardian laminated, box-frame and U-frame solenoids.

**MORE:** The Tubular Solenoid line is expanded to include pull and push types from lifts of a fraction of an ounce to 10-pounds-plus.

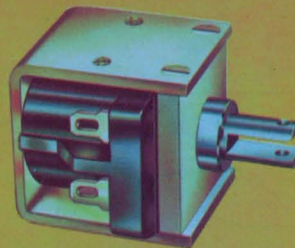

**Box-Frame Solenoids** in AC or DC for mechanical life of millions of cycles.

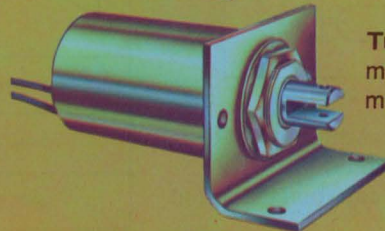

**Tubular Solenoids** that mount with only one mounting hole. DC only.

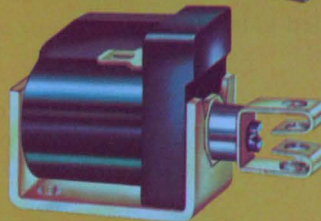

**U-Frame Solenoids** in AC or DC for minimum cost with high reliability.

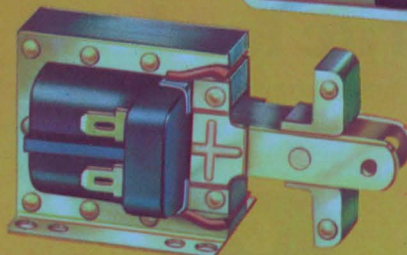

**Laminated Solenoids** in AC only for more pull over a longer stroke than DC solenoids of the same size.



# GUARDIAN®

GUARDIAN ELECTRIC MANUFACTURING CO. • 1550 West Carroll Ave., Chicago, Illinois 60607

*In a hurry? Call your Guardian Distributor.*

# CMOS Analog Switches

**TTL-controlled switches handle full  $\pm 15V$  signal swing with only  $\pm 15V$  supplies.**

New **DG200** and **DG201** devices provide channel and gain selection for analog signals up to  $\pm 15V$  power supply levels without exceeding switch signal handling levels (see typical applications circuit below). Devices feature:

- Monolithic CMOS construction; drivers and gates on a single chip.
- Low  $r_{DS}$  over full temperature and signal range.  
 $< 100 \Omega$  for **DG200** (dual SPST)  
 $< 250 \Omega$  for **DG201** (quad SPST)
- Static protection on all terminals.
- Break-before-make switching action.
- Independent pairs of sources and drains for maximum flexibility.
- Direct TTL, DTL and CMOS compatibility.

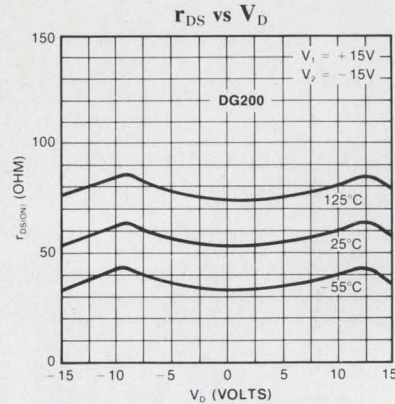

With supply voltage levels less than  $\pm 15V$ , the maximum analog signal always equals supply voltage.

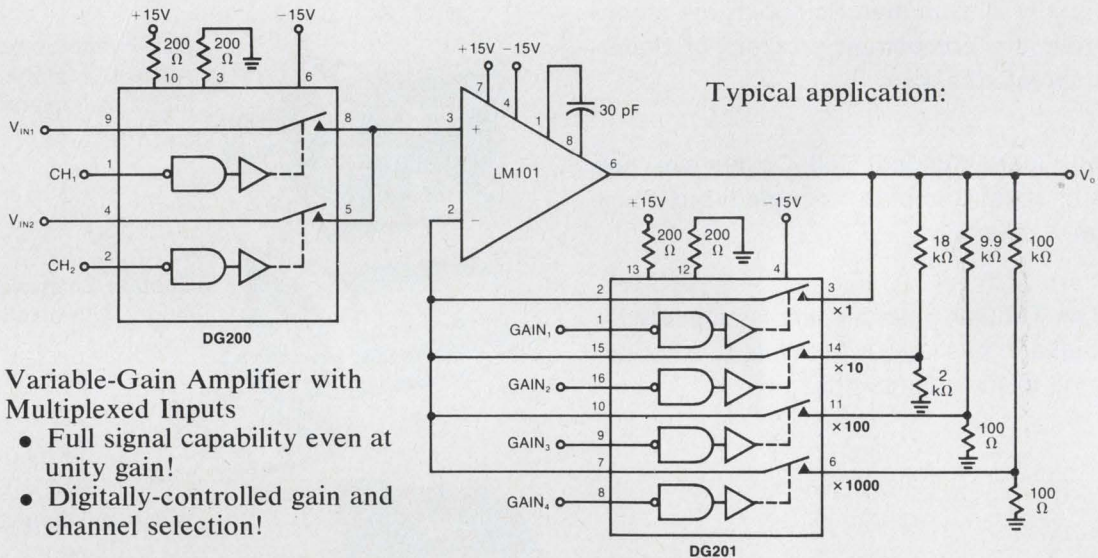

### Variable-Gain Amplifier with Multiplexed Inputs

- Full signal capability even at unity gain!
- Digitally-controlled gain and channel selection!

The **DG200** and **DG201** are ideal devices for digital computer interface with this analog world. If your switching problems are unique—and whose aren't—our applications people are eager to help. For complete information

## write for data

Applications Engineering: (408) 246-8000 Ext. 802



**Siliconix incorporated**

2201 Laurelwood Road, Santa Clara, California 95054

INFORMATION RETRIEVAL NUMBER 49



## The troublemakers

Troublemakers were always supposed to be the bad guys. They created problems where none existed. They were unpleasant when everything was fine. Or they simply had a malicious streak.

In recent history, troublemakers included reporters who dared to suggest that the behavior of high political officials was less than admirable. But engineers can be troublemakers, too.

This was brought to our attention by reader Clarence Fordham, who sent us Stephen Unger's article, "The BART Case," published by the IEEE Committee on Social Implications of Technology. Unger describes the plight of three troublemaker engineers—Max Blakenzee, Robert Bruder and Holger Hjortsvang—who were fired by California's Bay Area Rapid Transit District for warning that BART's Automated Train Control System was headed for trouble.

These men called attention to mismanagement of the system, unprofessional installation and unprofessional testing. They argued that reliability would be poor. After attempts to shut them up failed, they were fired. BART—whose record has been less than enviable, its reliability dismal—declined to give the troublemakers a written reason for their discharge.

Will these men be vindicated? They are suing BART for \$885,000. If they win their suit, taxpayers will lose money in addition to the transit service they're losing because of erratic operation. But what about the guys who covered up for what may have been bad management? What about the people accused of trying to silence the three engineers and discredit them with other potential employers? If the accusations are true, will they be prevented from inflicting similar damage on future systems and on future engineers who have the honesty and guts to speak up? Will they be exposed? Will they be penalized? Probably not. They're more likely to get promotions.

The lesson is sad. If we want to take greater pride in our profession, more of us will have to speak up. We'll have to learn to be troublemakers.



A handwritten signature in cursive script that reads "George Rostky".

GEORGE ROSTKY  
Editor-in-Chief

# TRI-STATE AND CMOS, TOGETHER AT LAST.

Tri-State® Logic comes to CMOS.

For all you designers of bus organized systems who know and love Tri-State, now you can have your heart's desire in CMOS, too.

## Fast-Acting Buffers

Introducing two new CMOS buffers that convert standard CMOS outputs to Tri-State outputs.

They incorporate all the mouth-watering features of 54C/74C. Not to brag, but this includes a wide supply voltage range (3v to 15v), high noise immunity (typically 45% of VDD), and guaranteed noise margin of 1.0v (which is 2½ times that of TTL).

And in addition they can drive one TTL load *directly*. So you can mix TTL and CMOS on the same board as well as on a board-to-board basis.

The numbers (get your pen out) are MM70C95/MM80C95, which has common output controls for all six buffers... and MM70C97/MM80C97, which has two controls (one for two buffers, one for the other four) in case that's the kind of thing that turns you on.

Not to mention the four additional Tri-State buffers we have on the drawing boards.

## Fascinating Flip-Flops

And, as if that weren't enough to make your day, we've also enhanced our already illustrious 54C/74C line with a Tri-State Flip-Flop. MM54C173/MM74C173 Tri-State Quad D Flip-Flop, to be exact. It also



has logically controllable gated D characteristics, which greatly simplifies control circuitry.

It operates synchronously from a common clock, with a Tri-State output that allows it to be used in a bus organized system.

Ask for it wherever Flip-Flops are sold.

## Tri-State Revisited

Just in case it slipped your mind or you've been living in a cave, Tri-State logic devices give you the ability to interconnect outputs of similar devices to a common bus line.

This lets you do data bussing without the huge current transients on the line, because, cleverly, Tri-State has a third impedance state.

Fewer packages are needed to effect the same logical solution.

And noise susceptibility is improved 3-to-1 compared to a transmission gate.

## CMOS Revisited

The 54C/74C bandwagon keeps rolling.

New products (27 now available, with more on the way).

Volume production (on your distributors' shelves now).

A highly successful program of seminars all over the country just completed.

A standard of the industry in the making.

For the whole story write for our CMOS catalog. National Semiconductor Corporation, 2900 Semiconductor Drive, Santa Clara, California 95051.

# NATIONAL

National Semiconductor Corp., 2900 Semiconductor Drive, Santa Clara, Calif. 95051; Scottsdale, Ariz. (602) 945-8473; Mountain View, Calif. (415) 961-4740; Sherman Oaks, Calif. (213) 783-8272; Tustin, Calif. (714) 832-8113; Miami, Fla. (305) 446-8309; Chicago, Ill. (312) 693-2660; Indianapolis, Ind. (317) 255-5822; Lenexa, Kan. (816) 358-8102; Glen Burnie, Md. (301) 760-5220; Burlington, Mass. (617) 273-1350; Farmington, Mich. (313) 477-0400; Minneapolis, Minn. (612) 888-4666; Englewood Cliffs, N.J. (201) 871-4410; Syracuse, N.Y. (315) 455-5858; Dayton, Ohio (513) 434-0097; Dallas, Tex. (214) 233-6801.

# BROWN PROPOSES CANNON® ZERO FORCE RECTANGULAR CONNECTORS. POINTS OUT LOWEST WEAR, LOWEST COST. VP NEW PRODUCTS STARTLED.



**"DISC MEMORIES CAN'T FLY; SO WHY DO WE NEED CANNON?" he retorts.**

Brown took off: "Don't knock Cannon's aerospace background. That's how they came up with their DL rack and panel connector with a 10,000-cycle life, instead of the 500 or less we've had to live with."

The VP blinked at the order of magnitude difference. But Brown had the ammunition: "It's simple. There's no wear because the contacts don't touch during insertion. A quarter turn of the actuator

cams them together and cleans the surfaces at the same time. No jackscrews, no problems."

As usual, someone brought up cost. Brown levelled him: "Cannon's zero-force

DL's cost less than any other rectangular connector. And they've got an automatic strip-and-crimp machine, too.

We just cut the wires to length; it strips the end and crimps on a contact. Takes jacketed cable, and you know how much trouble we're having with that... come to think of it, since our present sources can't



hack it, maybe it's time now to look at Cannon."

Now maybe your forte isn't startling VP's, like Brown, but maybe if you shook them up just a tiny bit, it might help them. And you.

Write for our free catalog today. ITT Cannon Electric, International Telephone and Telegraph Corporation, 666 E. Dyer Road, Santa Ana, CA 92702. Phone (714) 557-4700.



Collection of  
The Art Institute of Chicago  
"Brussel's Construction," 1958  
Jose di Rivera



## new dimensions in Bodine drive capabilities

For office machines / machine tools / industrial equipment / processing apparatus / electronic equipment /  
electrical control devices / medical apparatus / data processing equipment /  
recording instruments / graphic arts equipment / scientific apparatus / and many other uses.



**The people at Bodine are doing exciting things in fractional hp drives.** Putting more power into smaller, lighter packages. Creating greater control capabilities than you might believe possible. Developing "specials" to meet the most demanding design criteria. Motors that keep their cool in hottest application environments. That run whisper quiet. And

deliver long-haul reliability and economy. Adding to an extensive line of standards to provide a virtually unlimited range of fhp motors, gearmotors and speed/torque controls. Talk to Bodine about your stock and built-to-order fhp drive requirements. We can help you get what you need. Over 3500 catalog specifications, 340 stock types and sizes. Ratings from

1/2000 thru 1/2 hp . . . torques from 0.18 oz.-inches to 350 lb.-inches . . . speeds from 0.6 to 10,000 Rpm. Write or call Bodine Electric Company, 2500 W. Bradley Place, Chicago, Ill. 60618. Phone 312/478-3515. Telex: 25-3646.

**BODINE  
ELECTRIC  
COMPANY**

ATTENTION PROGRAM MANAGERS:

# How to win a \$10 million government contract with the new \$20,250 Rolm Ruggednova:

For \$20,250 you can meet Mil Specs E-5400 airborne environment, E-16400 shipboard environment, eliminate software and interfacing problems . . . and still buy the world's toughest computer system with 8K of memory and teletype.



If you're in the business of producing military systems, we don't have to tell you about budgets, risks, deliveries and design problems. Instead, let's talk about the Ruggednova 1602 . . . and how Rolm can help you win those big contracts.



A new technique for armchair control of RPVs (Remotely Piloted Vehicles) has been developed by Motorola Government Electronics Division for the Navy. The Ruggednova in the background helps provide either discrete or proportional control for up to six RPVs of any variety at ranges exceeding 250 nautical miles.

## SOFTWARE IS THE FIRST SAVING

You can effectively reduce the most expensive and longest lead-time item in a system's task with our wide selection of proven and documented software. You'll see your program working on the 1602 in less time because the Rolm software set includes assemblers, compilers, debugging aids, utility routines, math libraries and powerful operating systems. A significant benefit of our system is the availability of a compatible commercial equivalent. Any program written on the Data General Corporation's Nova series will operate on the Ruggednova. Our licensing agreement with Data General allows us to provide more software than any other mil spec computer.

## OUR EXPANDED INSTRUCTION SET GIVES GREATER FLEXIBILITY

With the Ruggednova 1602 your applications programming task has been simplified with a new extended instruction set. For example, our file search instruction enables you to do an "in limits / out of limits" comparison on a file up to 64,000 words long with one single instruction. Other examples include 1602's stack processing capability, auto-

matic branching and nesting of interrupts, immediate mode instructions and double precision arithmetic.

## INTERFACING IS MADE EASY

Over 30 general purpose interfaces to select from gives you another edge on that contract. No design costs. No technical risks. The I/O interfaces range from series and parallel digital interfaces to communication interfaces to D/A and A/D converters all the way to NTDS interfaces. If you have your own special interface it can be placed inside the 1602 chassis. You save money by not having to design a rugged chassis or rugged power supply.

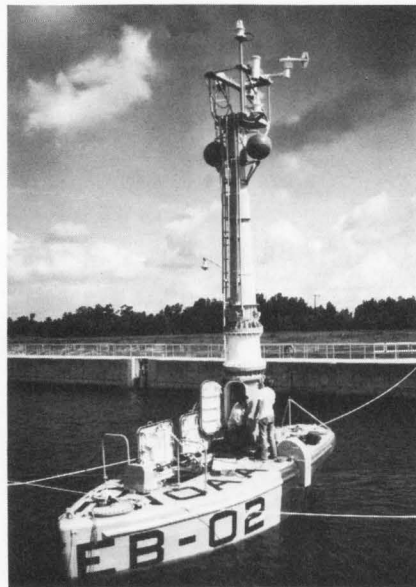

This new prototype, 30-ton buoy, built by Lockheed Missile & Space Company for the National Oceanic and Atmospheric Administration, has been placed in the Gulf of Mexico to record meteorological and oceanographic data. It is equipped with a Rolm Ruggednova for data acquisition and communications processing.

## MIL SPECS ARE ALREADY MET

We supply you with a qualification test report free. You don't have the hassle, risk, or expense of qualification testing. The 1602 meets Mil-E-5400 airborne environments, Class II; Mil-E-16400 shipboard environments, Class I; Mil-Std-461A electromagnetic interference and Mil-S-901 for high impact shock. It has

an operating temperature range of  $-55^{\circ}$  to  $+95^{\circ}\text{C}$  case temperature, at altitudes from sea level to 80,000 feet. The 1602 meets shock specifications of 15 g's with 11 ms duration and vibration tests of 10 g's, 5 to 2000 Hz.

## AND THERE'S A SUPPORT PACKAGE AT NO EXTRA COST

Rolm's program doesn't stop with just hardware and software. We also help you reduce your budget and design risk with a number of back-up items. These include detailed reliability reports, two weeks of training, complete documentation and a 90-day warranty. For software support there's also a "how-to" software manual, individual software write-ups, and full diagnostic software.

## NEW DEBUGGING FEATURE

Within the first 15 minutes of loading a program into the 1602 you can localize most program errors. A new "panel breakpoint" switch allows you to execute your program until it hits the address located on the 16 data switches. This allows you to verify good routines and identify program bugs. No more single stepping through 2,000 word subroutines or keying halts. It's a great time-saving software feature.

Now that we've told you about all the ways Rolm can help you get that multi-million dollar contract, there's no space left to describe a host of other features about the Ruggednova 1602. So, drop us a line and we'll send you complete data on the world's toughest computer. If you're interested in getting a head start on that contract . . . give us a call.

**ROLM**  
CORPORATION

18922 Forge Drive, Cupertino, CA 95014  
(408) 257-6440 • TWX 910-338-0247

**REGIONAL SALES OFFICES:** Los Angeles 213-784-8500; Palo Alto 415-965-2224; Washington D.C. 703-893-2696; Boston 617-237-5752; New York 914-297-9533; Cincinnati/Dayton 513-874-5406; Texas 214-661-8905.

**DOMESTIC REPRESENTATIVES:** Colorado 303-355-3521; Kansas 913-362-0919; Missouri 314-895-4100; Washington 206-762-2310; Canada 416-742-8015.

INFORMATION RETRIEVAL NUMBER 147

# COMPUTER-COMPATIBLE PROGRAMMABLE ANALOG FILTER 16 CHANNELS



## SYSTEM 816

- DIRECT INTERFACE WITH COMPUTER, PROGRAMMER OR SWITCH CLOSURES
- PLUG-IN CARDS PROVIDE UP TO 16 INDEPENDENT FILTER CHANNELS IN 5¼" HIGH PANEL
- LOCAL, REMOTE, AND ON-CARD PROGRAMMING OF CUTOFF FREQUENCY
- CUTOFF FREQUENCY RANGE: 10 Hz to 150 KHz
- FUNCTIONS: Low pass, high pass, bandpass, band reject
- ATTENUATION SLOPE: 48 db/octave/channel
- DYNAMIC RANGE: 80 db
- PASSBAND GAIN: 0 db
- OUTPUT SIGNAL: 20 volts p-p
- IMPEDANCES: 1 Meg input, 50 ohm output

### SOME APPLICATIONS:

- BAND LIMITING ANALOG SIGNALS PRIOR TO A/D CONVERSION (ANTI-ALIASING)
- NOISE ELIMINATION IN DATA CHANNELS
- TRANSDUCER OUTPUT FILTERING
- FAST FOURIER ANALYSIS

# ROCKLAND

Rockland Systems Corporation 230 W. Nyack Road, West Nyack, N.Y. 10994 • (914) 623-6666 • TWX 710-575-2631

INFORMATION RETRIEVAL NUMBER 50

# Improve CRT-display systems with NMOS.

Compared to a PMOS approach, NMOS memories allow greater and more efficient storage, and hence, a larger variety of characters.

The increasing availability of n-channel MOS (NMOS) memory elements is making possible significant improvements in CRT-display designs. Compared with equivalent systems<sup>1</sup> that use p-channel ICs, the NMOS approach yields a greater variety of characters, resulting from greater storage capability and more efficient storage.

A design example shows how to obtain a CRT-system that can display 128 characters in a  $9 \times 7$  matrix. The system contains an NMOS 8k-bit character generator and NMOS 80-bit shift registers. It uses row generation to display characters that include shift (lower case) descenders—such as g, j, p, q and y. Moreover, the system can interface with a 16-bit minicomputer.

The popular dot-matrix method provides the basis for the display system. Any size dot matrix is possible but the  $5 \times 7$  and  $7 \times 9$  are the most common, with the  $7 \times 9$  offering clearer definition. For either matrix, alphanumeric characters are formed by illuminating the proper dots.

The character generator—a read-only memory—determines which dots are to be illuminated (Fig. 1). Because of pin limitations, the entire dot matrix cannot be read out at one time. Instead characters are read out a row at a time. The row character generator is used with a horizontal scan.

## NMOS generator boosts storage

The 8192-bit NMOS character generator can be mask programmed with any set of 128 characters. These include Japanese, Hebrew or any special set of character or symbol formats. In our design example, the IC is the MCM 6571. The IC generates each character in the  $7 \times 9$  matrix, and it can yield automatically shifting descenders.

A 7-bit character code selects any one of the available characters. The rows can be sequen-

ROW SELECT TRUTH TABLE				
RS 4	RS 3	RS 2	RS 1	OUTPUT
0	0	0	0	R 0
0	0	0	1	R 1
0	0	1	0	R 2
0	0	1	1	R 3
0	1	0	0	R 4
0	1	0	1	R 5
0	1	1	0	R 6
0	1	1	1	R 7
1	0	0	0	R 8
1	0	0	1	R 9
1	0	1	0	R 10
1	0	1	1	R 11
1	1	0	0	R 12
1	1	0	1	R 13
1	1	1	0	R 14
1	1	1	1	R 15*

\*ROW R15 IS BLANKED ON MCM6571

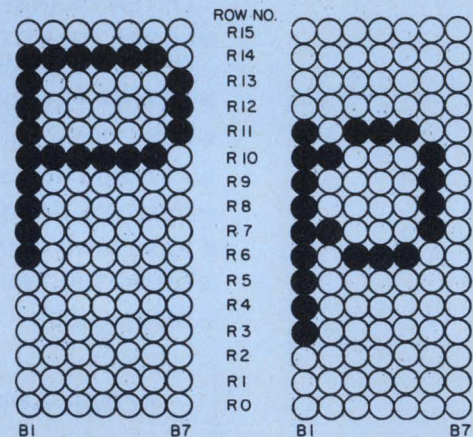

1. The 8192-bit character generator automatically places a  $7 \times 9$  character in one of two preprogrammed positions in the 16-row matrix.

tially selected to provide a nine-word sequence of seven parallel bits per word for each character selected. As the row-select inputs are sequentially addressed, the ROM automatically places the  $7 \times 9$  character in one of two preprogrammed positions on the 16-row display matrix, as shown in Fig. 1.

The positions are defined by four row-select inputs. Maximum access time is 500 ns. However, if a device is programmed with shifted charac-

Bob Bratt, Computer Applications Engineer, Motorola, Inc., Semiconductor Products Div., Phoenix, Ariz. 85008.



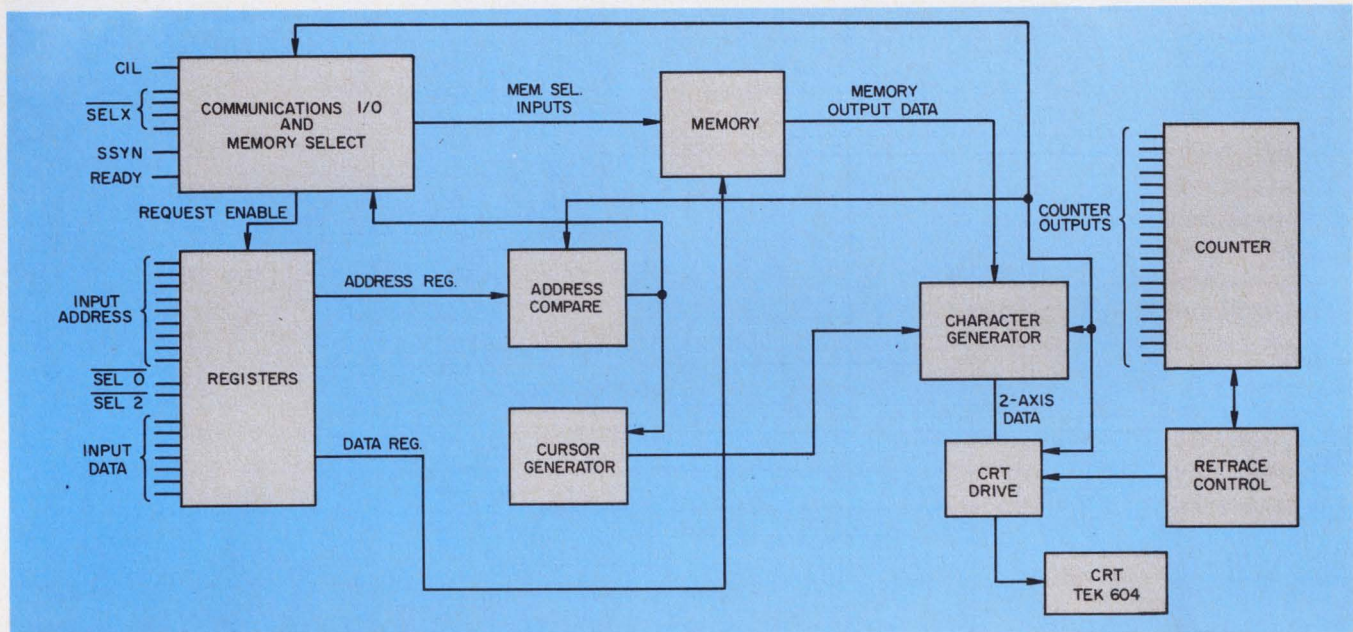

2. A CRT-display system uses an NMOS character generator and 80-bit NMOS shift registers. The counter func-

tions as the central coordinator of the system. Six circuit boards can contain the system.

ters, the access time can be reduced to 300 ns.

Fig. 1 shows which row of the character matrix is generated for each of the possible row-select inputs. With a descending character selected, for example, rows  $R_{14}$  through  $R_{12}$  are automatically blanked. The next nine rows form the descending character matrix. Thus while any one character is contained in a  $7 \times 9$  matrix, a  $7 \times 12$  matrix must be available on the CRT screen to contain both normal and descending characters. The MCM 6571 uses a down count to display the rows of the character from top to bottom.

#### Storage device retains data

Since the image on the CRT must be constantly refreshed, a storage device is required to retain the information. Two types can be used: random-access memories (RAMs) and shift registers. RAMs offer minimum access time when they interface with a computer. Also, because of the

random-access feature, no buffer storage is required. Shift registers provide simple editing functions—specifically, insertion operations.

The need for a buffer register is an unattractive requirement of shift storage and results from the way characters are written on the screen. As the electron beam moves across the screen, each character code is applied in turn to the character generator and the first row of each character is read out. At the end of the row, the electron beam retraces and begins to move across the screen again. The same set of character codes must be presented to the character generator again so that the second row can be written.

This procedure must be repeated until all nine rows have been written. With shift-register storage, the information for a particular line would not be available after the first row was written unless the information were shifted all the way around. With a large shift register, system speed limitations result.

The buffer register can be eliminated by the

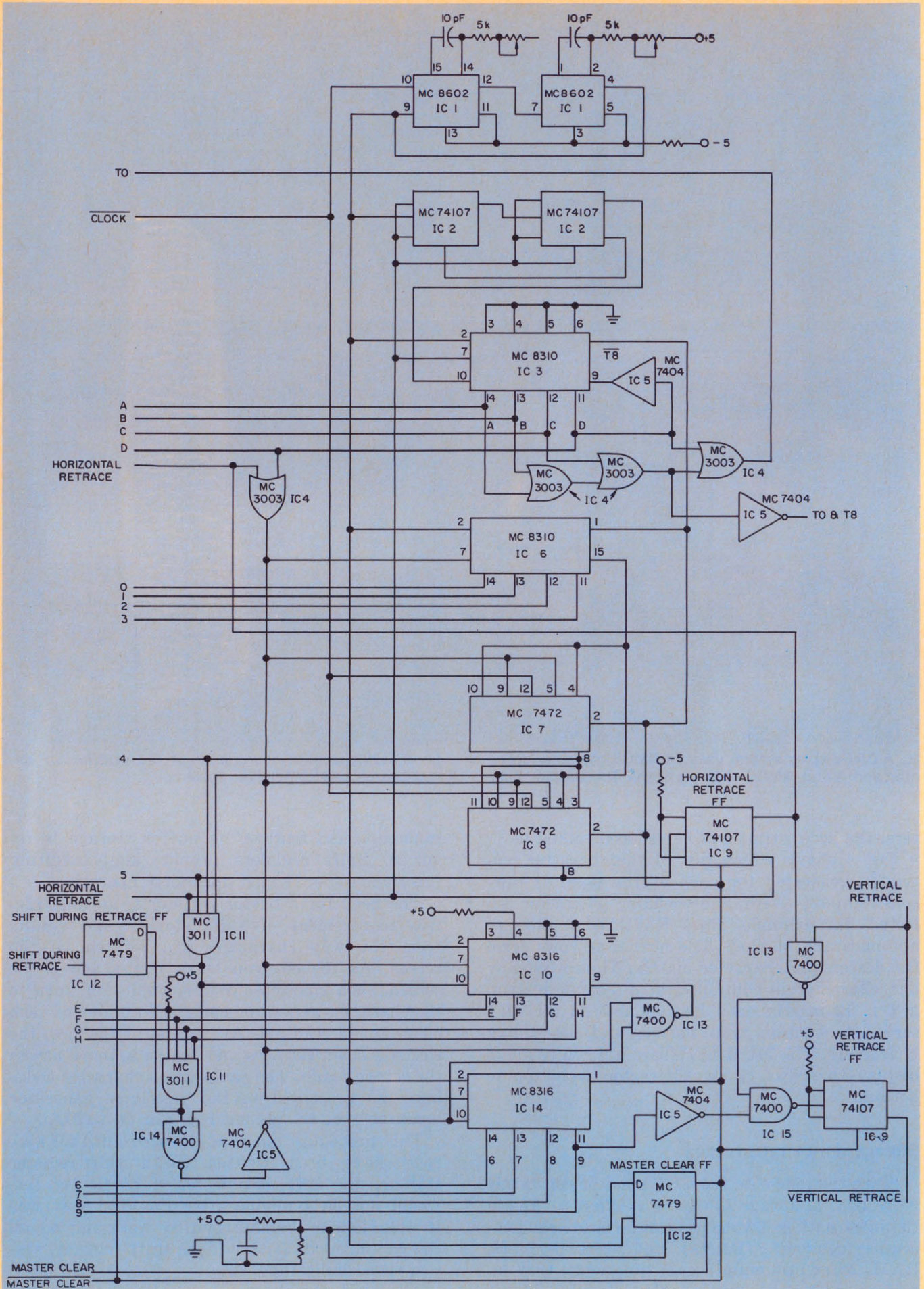

3. The counter and retrace control board uses two one-shots to drive synchronously all the counters in the chain.

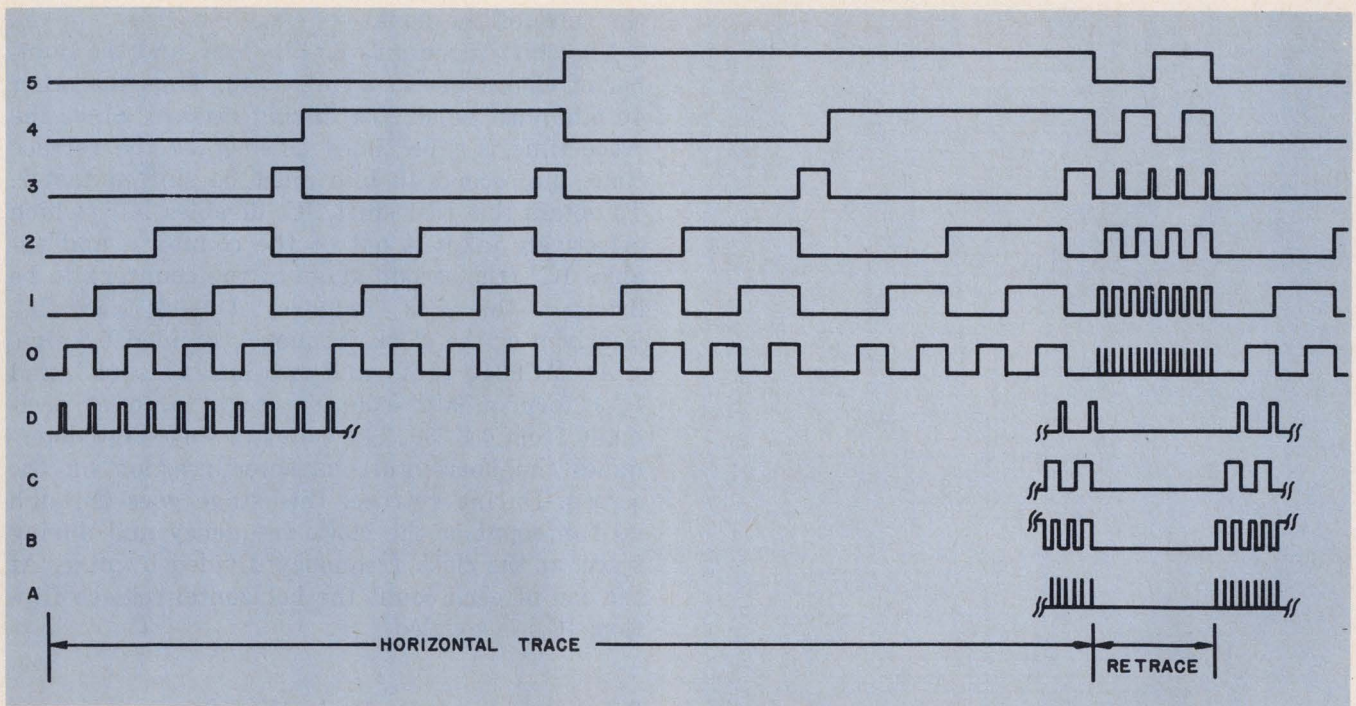

4. During trace, 40 characters per line can be shifted out of the 80-bit registers. The remaining 40 bits must

be handled during retrace. Trace time exceeds retrace time by a factor of nine.

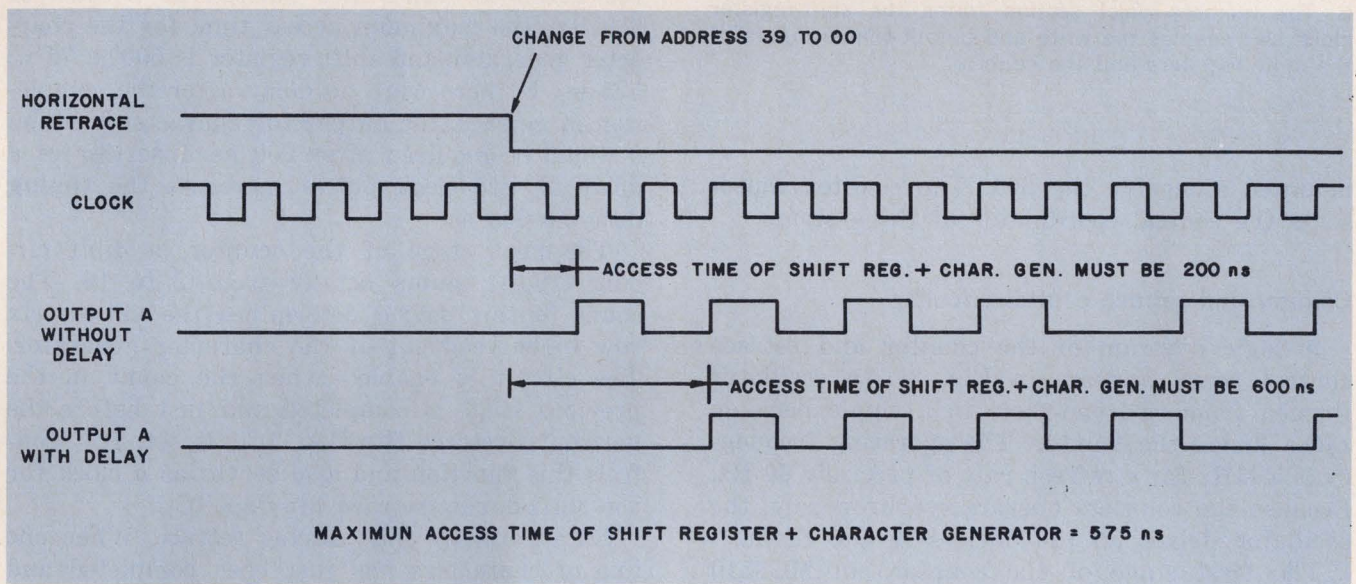

5. Character codes shift at a 5-MHz rate during retrace. A delay must be added after retrace to ensure sufficient

time to access location 0. The delay is provided by an insertion of two clock pulses.

use of small shift registers—with storage capability of only one or two lines. The design can be further simplified by three-state outputs on the registers. These features are contained in the quad 80-bit shift register, an MC6565, used in our design.

#### CRT-display system uses NMOS storage

A block diagram of the CRT-display system that uses the NMOS elements appears in Fig. 2. The system has a refresh rate of 60 Hz and could display up to 640 characters—16 lines with 40 characters per line.

Six circuit boards contain the system. The boards consist of circuits for the following functions:

- Counter and retrace control.
- Memory.
- Character generation and CRT drive.
- Input address and data, and cursor generation.
- Communications I/O and memory select.
- Power supplies.

The CRT display—a Tektronix 604—can be mounted in a standard 19-inch rack and the X, Y and Z inputs can be driven by 5 and 12-V supply circuitry. The other circuit blocks are

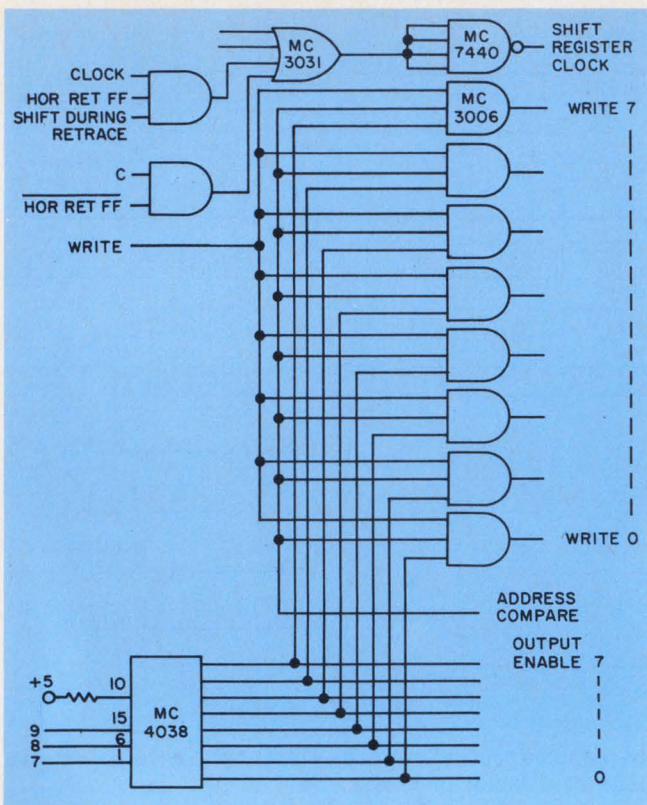

6. The memory-select section forms the shift-register clock and enables the write and output-enable inputs of the shift registers and the counter.

mounted alongside the 604. The counter represents the central coordinator of the system.

### Counter and retrace control circuitry

A logic diagram of the counter and retrace control board appears in Fig. 3. An oscillator formed from two one-shots in a single package (IC<sub>1</sub>) drives the counter. The operating frequency is 5 MHz for a refresh rate of precisely 60 Hz. Because the counters operate synchronously, the oscillator drives all the devices in the chain.

The first stage of the counter, an MC8310 (IC<sub>3</sub>), counts decimally from 0 to 8. The dot matrix columns 1 through 7 are written when the count in this register is 1 through 7. During counts 0 and 8, the Z-axis is blanked to form a space between horizontally adjacent characters. IC<sub>4</sub> and IC<sub>5</sub> generate the periods T<sub>0</sub>, T<sub>8</sub>, and T<sub>0</sub> and/or T<sub>8</sub>. In addition to the clock input, IC<sub>2</sub> and IC<sub>9</sub> enable IC<sub>3</sub>, while IC<sub>2</sub> serves to delay the beginning of the trace by two clock pulses.

The horizontal retrace flip-flop, IC<sub>9</sub>, enables counter IC<sub>3</sub> during the trace operation and disables it during retrace (Fig. 4). As mentioned earlier, to write one line of characters, the codes must be presented to the character generator once for each row of the dot matrix. In addition, the shift register must be shifted completely around between the beginning of one trace and

the start of the next.

The shift register is 80-bits long and the number of characters in a line is 40. Thus the other 40 bits must be shifted during retrace. Since the trace time is nine times as long as the retrace time, the second 40 bits must be shifted faster. To obtain this fast shift, IC<sub>9</sub> disables IC<sub>3</sub> (which effectively takes it out of the counter), and enables IC<sub>6</sub> (the second stage of the counter) to be driven at the clock frequency. During trace, IC<sub>6</sub> is driven at the clock frequency divided by nine.

An MC8310 (IC<sub>6</sub>) and two MC7472s (IC<sub>7</sub> and IC<sub>8</sub>) form a 6-bit counter stage to count decimally from 0 to 39. The count in this stage determines the horizontal character position on the screen. During retrace, this stage goes through its full count at the clock frequency and during trace, at the clock frequency divided by nine. At the end of each count the horizontal-retrace flip-flop, IC<sub>9</sub>, is toggled.

### Delay ensures access for location 0

Fig. 5 shows the need for IC<sub>2</sub>. During retrace the character codes are shifted at a rate of 5 MHz; the maximum access time for the character generator and shift register is  $500 + 75 = 575$  ns. If there were no delay after the completion of retrace, the output for character location 0 would be required after 200 ns. Insertion of a delay of two clock pulses increases the timing delay to 600 ns.

The next stage of the counter, a 4-bit circuit (IC<sub>10</sub>), counts octally from 2 to 16. The count in this device determines the dot-matrix row to be read out of the character generator. The circuit is enabled when the count in the previous stage is completed and just before the horizontal-retrace flip-flop, IC<sub>9</sub>, is set. IC<sub>11</sub> controls this function and also serves as a clock for the shift-during-retrace flip-flop, IC<sub>12</sub>.

Data normally shift during retrace. When one line of characters has just been completed and another begins, the shift must then be inhibited. Thus the shift-during-retrace flip-flop is clocked as each row is completed.

If additional rows in the character line must still be written, the D-input will be at logic ZERO and the shift will be enabled. If the completion of the row is also the completion of the line (the count in IC<sub>10</sub> equals 16), the D input will be a ONE and the flip-flop set, and this will inhibit IC<sub>12</sub>. Circuit IC<sub>11</sub> decodes the count in IC<sub>10</sub> and drives the D-input of IC<sub>12</sub>.

The outputs of both gates of IC<sub>11</sub> are AND-connected to form an enable for the last counter stage, IC<sub>14</sub>, which counts octally from 0 to 17. The count in this device determines the vertical character position or character line. At the end of the last count, the vertical-retrace flip-flop is

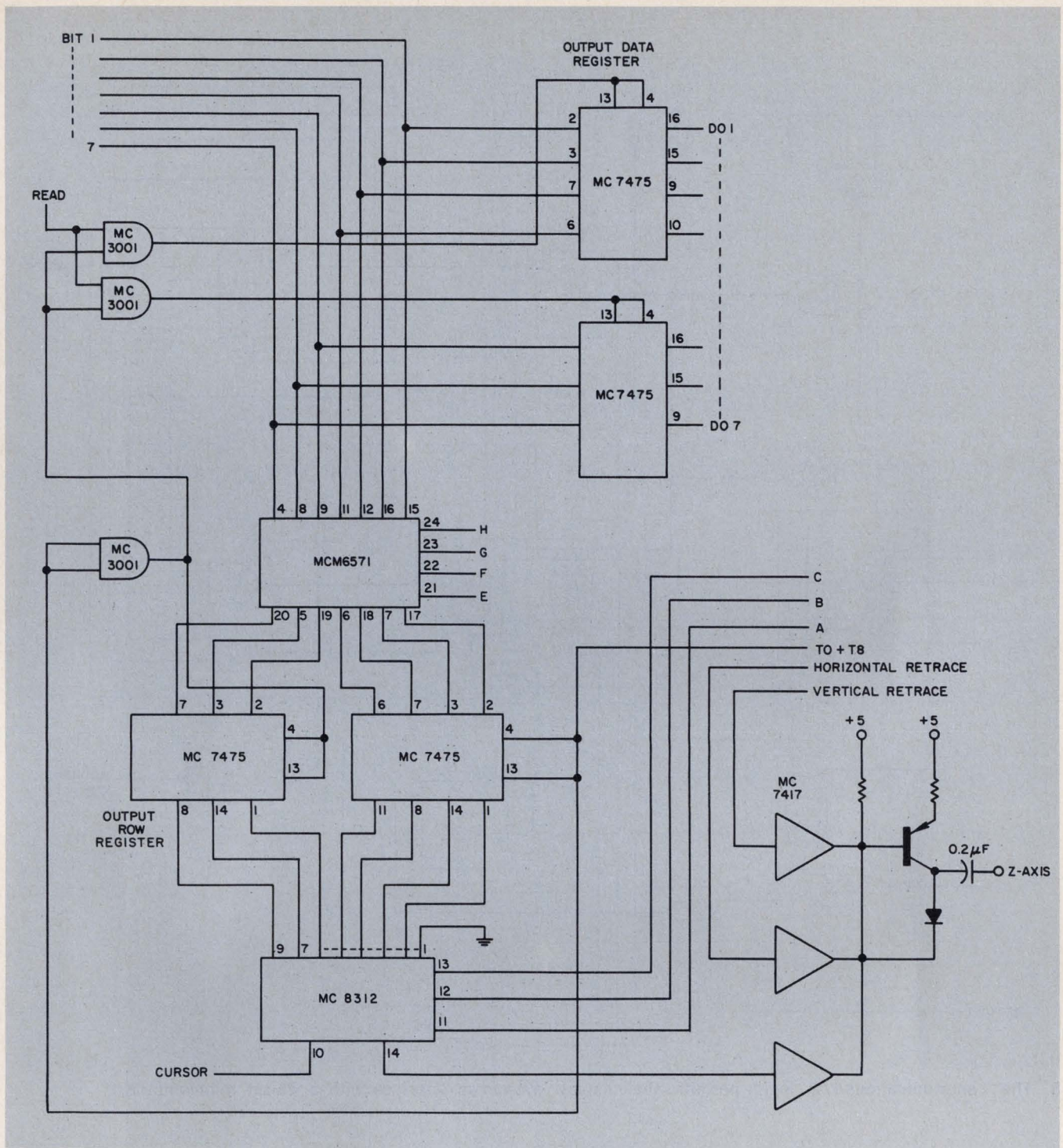

7. The character-generation section obtains data from the shift registers and the counter.

set. A vertical retrace takes the same amount of time as a horizontal retrace, so that the horizontal-retrace flip-flop resets the vertical-retrace flip-flop. The master-clear flip-flop initializes the system when power is first applied.

#### Memory-select section

The memory-select section forms the shift-register clock, and enables the write and output-enable inputs of the selected shift registers (Fig.

6). A one-of-eight decoder (MC4038) uses the three highest-order bits of the counter to generate an output enable. A set of logic gates generates a write enable for the selected pair of shift registers when a write cycle is being executed. And an address-compare indicates that the desired location has been reached.

When the horizontal-retrace flip-flop is reset, an AND-OR gate (MC3031) uses output C of the counter to clock data out of the shift registers. When the horizontal retrace flip-flop

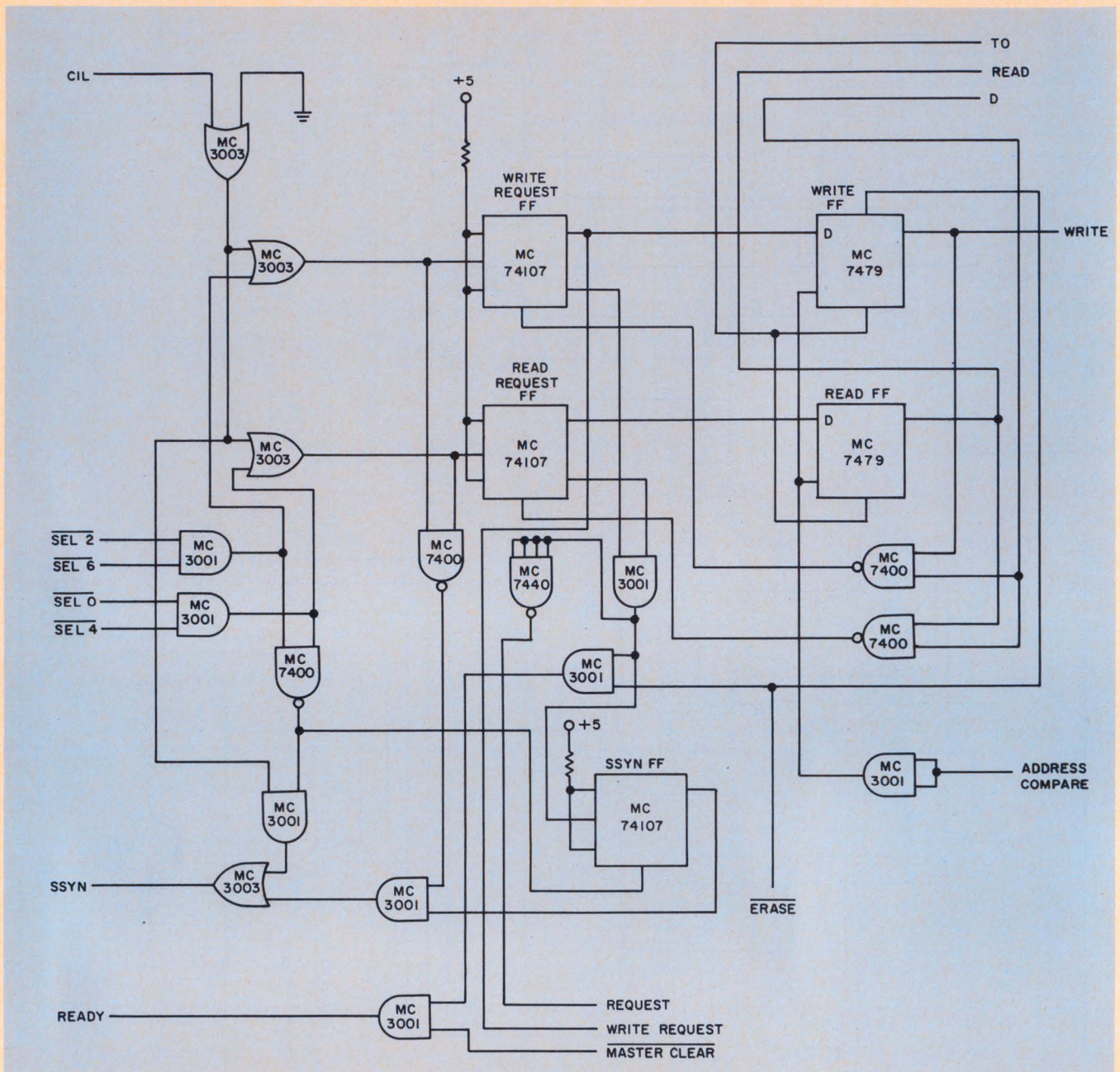

8. The communications-I/O logic permits the display system to interface with a 16-bit minicomputer.

is set, and a shift-during-retrace is required, the counter clock is enabled by the gate to form the shift-register clock. The 3031 output goes to a 7440 high fan-out driver that in turn drives the clock inputs of all 16 shift registers.

At this point, the desirability of the double one-shot oscillator for the counter clock becomes apparent. The shift-register clock is required to be in both the high and low state for at least 90 ns. Since the counter clock runs at 5 MHz (200 ns), a duty cycle close to 50% at the shift-register clock input is required. The counter clock pulses go through the 3031 and a 7440 before they reach the shift-register clock input. Thus some skew in the positive and negative

propagation times may occur. To compensate for this skew, the pulse widths of the two one-shots can be adjusted as required.

The memory section consists of 16 MC6565 shift registers arranged in pairs. Each pair holds 80 seven-bit character codes for two lines of the display. The inputs are driven by TTL gates. The three-state feature of the shift register allows the outputs to be bussed together, since only one pair of shift registers is accessed at a time.

#### Character-generation circuitry

The output data from the shift registers go to the character-generation section (Fig. 7).

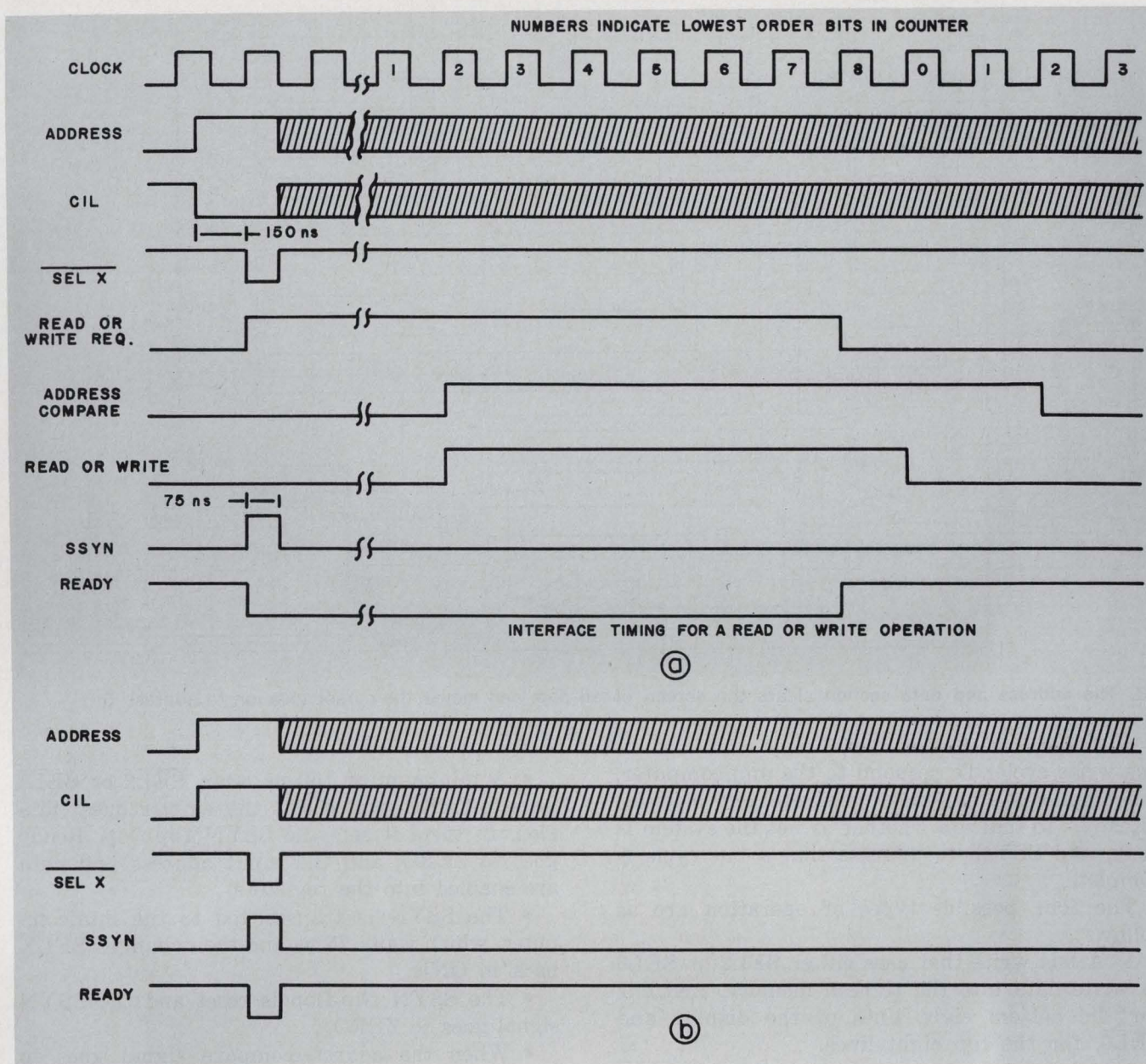

9. A write sequence commences with the application of the address and data to the system input lines (a). To

transfer data from the output-data register to the mini, the timing sequence in (b) applies.

With the system in a read cycle, the data are enabled into the output-data register made up of two 7475s. In any case, the data go to the character generator as does the row-select count from the counter. The output-row register stores the specified row for the character at time  $T_0 + T_8$ .

An eight-channel data selector, the MC8312, selects each row input to be enabled to the single output according to the input count. The three lowest-order bits of the counter supply the input counter. In this manner parallel data convert to serial data. At times  $T_0$  and  $T_8$ , the grounded input pin is enabled.

The output of the MC8312 goes to the Z-axis driver, which consists of three collector-ORed

7417s that drive an output transistor. The Z-axis driver output goes to ZERO during vertical and horizontal retrace and whenever the data input from the MC8312 reaches ZERO.

#### Communication-I/O section

The read/write logic permits the use of a 16-bit bus-oriented minicomputer. The display system uses four addresses on the bus. A bus-interface card generates four signals— $\overline{\text{SEL0}}$ ,  $\overline{\text{SEL2}}$ ,  $\overline{\text{SEL4}}$  and  $\overline{\text{SEL6}}$ —to indicate when these four addresses are selected.

A control signal, C1L, indicates whether the external minicomputer executes a bus-read or a

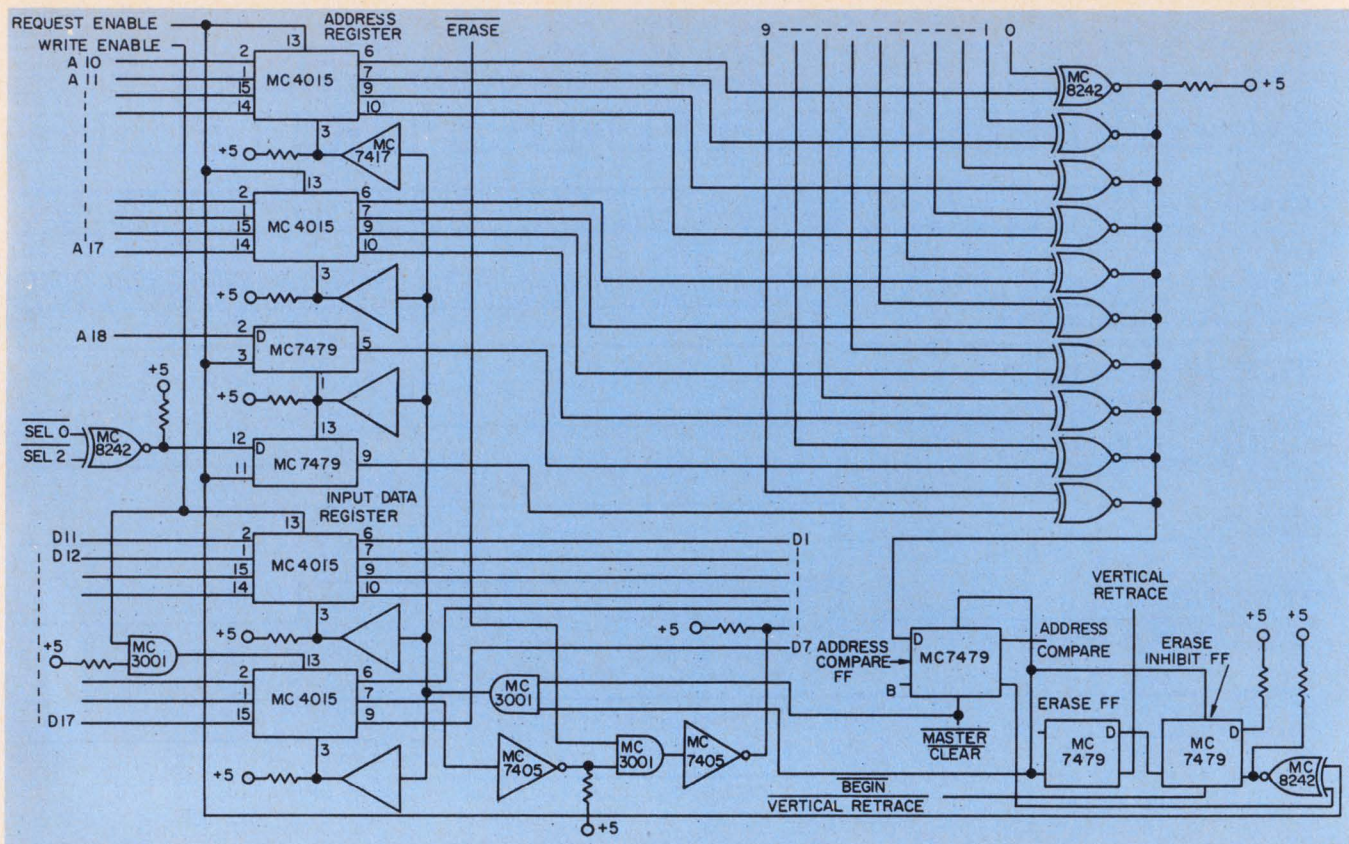

10. The address and data section clears the screen of all data and moves the cursor location to address 0.

bus-write cycle. To respond to the minicomputer, the display system must generate two signals: "Ready," to indicate whether or not the system is busy, and SSYN, to indicate that a bus cycle is complete.

The four possible types of operation are as follows:

1. A bus write that uses either  $\overline{\text{SEL2}}$  or  $\overline{\text{SEL6}}$  to write data into the refresh memory.  $\overline{\text{SEL2}}$  is for the bottom eight lines of the display and  $\overline{\text{SEL6}}$ , for the top eight lines.

2. A bus write that uses either  $\overline{\text{SEL0}}$  or  $\overline{\text{SEL4}}$  to specify the location to be read.  $\overline{\text{SEL0}}$  indicates the bottom eight lines of the display and  $\overline{\text{SEL4}}$ , the top eight lines.

3. A bus read that uses either  $\overline{\text{SEL2}}$  or  $\overline{\text{SEL6}}$  to determine the status of the Ready signal.

4. A bus read that uses either  $\overline{\text{SEL0}}$  or  $\overline{\text{SEL4}}$  to retrieve the data requested in operation 2. The 16-bit word of the minicomputer divides into two sections. The seven least-significant bits specify the character code, and the remaining nine specify the address.

The communications I/O logic, shown in Fig. 8, executes a write operation in the following manner (Fig. 9a):

- Address and data are applied to the input lines of the CRT-display system. At the same time, the C1L input goes to ZERO, which enables the OR-gate inputs to the read-request and write-request flip-flops.

- A minimum of 150 ns later,  $\overline{\text{SEL2}}$  or  $\overline{\text{SEL6}}$  goes to ZERO, which sets the write-request flip-flop. In turn, it sets the SSYN flip-flop. Ready goes to ZERO, and the input address and data are enabled into the registers.

- The SSYN is transmitted to the minicomputer, which waits 75 ns and then changes  $\overline{\text{SELX}}$  back to ONE.

- The SSYN flip-flop is reset and the SSYN signal goes to ZERO.

- When the address-compare signal goes to ONE, which indicates that the address register and the counter contain the same address, the write-request is clocked into the write flip-flop. This flip-flop enables the necessary logic to write the new data into memory. An erase execution directly sets the write flip-flop.

- At the next T8 to T0 times, respectively, the write-request and write flip-flops are reset and Ready goes to ONE. The system can now accept a new request.

A read operation occurs in a similar manner, except that  $\overline{\text{SEL0}}$  and  $\overline{\text{SEL4}}$  are used.

To transfer data from the output-data register (Fig. 7) to the minicomputer or to check the status of the CRT system, the following sequence occurs (see Fig. 9b):

- C1L goes to ONE.
- A minimum of 150 ns later, one of the  $\overline{\text{SELX}}$  signals goes to ZERO.
- The SSYN signal goes to ONE, and stops



in that state for at least 75 ns.

■ The SELX signal returns to ONE and SSYN goes to ZERO.

#### Input address and data section

The address register consists of two MC4015s and an MC7479 (Fig. 10). The input address is enabled into the register when the read-request or write-request flip-flop is set. The input to bit 9 of the address register depends on the SELX input. If SEL0 or SEL2 is used, a ZERO enters bit 9, which means that the bottom eight lines of the display are to be accessed. If SEL4 or SEL6 is used, a ONE enters bit 9 and the top eight lines are to be accessed.

Ten MC8242 exclusive-NOR gates are constantly comparing the input and counter addresses. They are open-collector output devices: The output goes to ONE when they all indicate a "Compare." The address-compare flip-flop sets at the first positive edge of the B output of the counter. A read or write request can be performed at this time. Also the address-compare flip-flop enables the cursor row-compare logic and inhibits an erase.

When address-compare or a read or write request goes from ZERO to ONE, the erase-inhibit flip-flop sets. After each frame is written, the Q side of the erase-inhibit flip-flop is clocked into the erase flip-flop. As long as the latter stays reset, nothing happens. However, an illegal address—the four lowest-order bits contain a decimal number between 10 and 16—can be entered into the address register.

Since the counter does not duplicate the illegal address, the address-compare flip-flop and consequently the erase-inhibit flip-flop, do not switch. Then at the end of the frame the erase flip-flop is set.

A setting of the erase flip-flop forces the following to occur:

1. The input data to the shift registers go to the character code for a blank.
2. The address and input-data registers go to all ZEROS.
3. The erase-inhibit, address-compare and write flip-flops are set.

These steps clear the screen of all data and move the cursor location to address 0.

The cursor is written at a specific location in the address register—row 2 of the dot matrix (Fig. 1). Four MC7405s are collector-ORed to output a ONE each time that row-select 2 and address-compare exist at the same time. An MC-7490 then divides the frequency of this output by five to make the cursor blink. ■■

#### Reference:

1. Bratt, R., "TV set is display for data terminal," *Electronic Design*, No. 19, September 14, 1972.

## ac, dc, volts, amps, ohms 25 ranges \$595 complete 5-day delivery

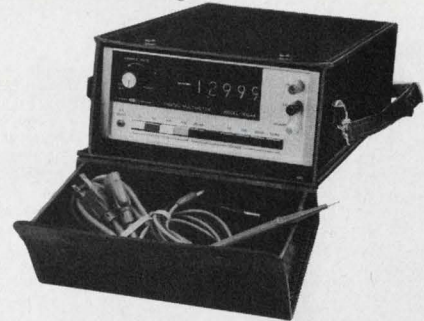

- New expanded AC response to 100 KHz
- New carrying case option
- New color-coded pushbuttons
- Optional battery pack with recharger (\$95) mounts internally
- 0.01% dc accuracy
- 1,000 megohm input impedance on 3 lowest ranges
- lab, field, or systems use.

For Model 7004A literature, contact your Scientific Devices office or Systron-Donner at 10 Systron Drive, Concord, CA 94518. Phone (415) 682-6161. **Europe:** Munich, W-Germany; Leamington Spa, U.K.; Systron-Donner S.A. Paris (Port Marly) France. In **Australia:** Systron-Donner Pty. Ltd. Melbourne.

**SYSTRON**  **DONNER**  
INFORMATION RETRIEVAL NUMBER 142



## 50 MHz automatic counter/timer

- Frequency, TIM, period, ratio, totalize
- Automatic gain control
- Autorangeing
- 8-digit readout (standard)
- 25 mV input sensitivity
- BCD output

- Model 6250 Options include:**
- Choice of 5 higher oscillator stabilities
  - Internal battery pack
  - 5-day delivery

Contact your Scientific Devices office or Concord Instruments Division, 10 Systron Drive, Concord, CA 94518. (415) 682-6161  
**Europe:** Munich, W. Germany, Leamington Spa, U.K.

**SYSTRON**  **DONNER**

INFORMATION RETRIEVAL NUMBER 143



No one else can  
The Products  
A Subsidiary of OAK Industries Inc.

CIRCLE NO. 201 FOR IMMEDIATE SWITCH NEED

CIRCLE NO. 202 FOR IMMEDIATE INDICATOR NEED



**make this statement.**

**of Marco-Oak**  
207 S Helena St, Anaheim, CA 92803

# Unify two-port calculations with a single analysis technique—the indefinite matrix. With this approach, you can handle any circuit, piece by piece.

## First of two articles

Finding the input-output characteristics of a complicated linear network can be a dreary job for the engineer—unless he uses a single-analysis technique that can handle linear networks without regard to their configuration.

The usual analysis techniques—generally a combination of Z, Y and H matrices—require the designer to break down the circuit into a number of suitably connected two-ports, then apply a suitable transformation to merge each two-port into the others. With the single-analysis approach, a generalized Y matrix, designated YF, is defined to describe the network topology in terms of simple circuit elements. The YF, also called an indefinite admittance matrix, is then reduced to the conventional Y matrix. With the application of a few simple formulas—used in conjunction with the Y matrix—we get the input impedance, output impedance, current gain and voltage gain for the network.

A useful property of the YF matrix is that it can be built up from simpler submatrices—based on selected portions of the circuit—with simple matrix additions.

## Describing the indefinite matrix

A three-terminal network is a simple model to illustrate the indefinite matrix (Fig. 1). Voltages are taken with respect to a reference point, instead of a particular node, and equations written for current  $I_j$ , which flows into node  $j$ . In this case three nodes give rise to the three equations shown in the figure. A simple rearrangement gives the currents in terms of the indefinite node voltages  $V_1, V_2, V_3$ :

$$I_1 = (\eta_{12} + \eta_{31}) V_1 - \eta_{12} V_2 - \eta_{31} V_3 \quad (1a)$$

$$I_2 = -(\eta_{12} + g_m) V_1 + (\eta_{12} + \eta_{23} + g_m) V_2 - \eta_{23} V_3 \quad (1b)$$

$$I_3 = -(\eta_{31} - g_m) V_1 - (\eta_{23} + g_m) V_2 + (\eta_{31} + \eta_{23}) V_3 \quad (1c)$$

The indefinite admittance matrix relates the cur-

rents to the voltages in the same manner as Eqs. 1a to c and therefore:

$$\begin{bmatrix} I_1 \\ I_2 \\ I_3 \end{bmatrix} = \begin{bmatrix} \eta_{12} + \eta_{31} & -\eta_{12} & \\ -(\eta_{12} + g_m) & (\eta_{12} + \eta_{23} + g_m) & \\ -(\eta_{31} - g_m) & -(\eta_{23} + g_m) & \end{bmatrix} \begin{bmatrix} V_1 \\ V_2 \\ V_3 \end{bmatrix} \quad (2)$$

All elements of the  $3 \times 3$  matrix have the physical dimensions of admittance. The generalized expression for Eq. 2 is

$$\begin{bmatrix} I_1 \\ I_2 \\ I_3 \end{bmatrix} = \begin{bmatrix} y_{11} & y_{12} & y_{13} \\ y_{21} & y_{22} & y_{23} \\ y_{31} & y_{32} & y_{33} \end{bmatrix} \begin{bmatrix} V_1 \\ V_2 \\ V_3 \end{bmatrix} \quad (3)$$

with the  $y_{rs}$  given by

$$\begin{aligned} y_{11} &= (\eta_{12} + \eta_{31}) \\ y_{12} &= -\eta_{12} \\ y_{13} &= -\eta_{31} \\ y_{21} &= -(\eta_{12} + g_m) \\ y_{22} &= (\eta_{12} + \eta_{23} + g_m) \\ y_{23} &= -\eta_{23} \\ y_{31} &= -(\eta_{31} - g_m) \\ y_{32} &= -(\eta_{23} + g_m) \\ y_{33} &= (\eta_{31} + \eta_{23}). \end{aligned} \quad (4)$$

## Properties of the indefinite matrix

At first glance, the indefinite matrix seems to contain redundant information. For example, nine different elements are needed to describe a three-node network. A  $2 \times 2$  Y matrix that contains four elements can also describe this two-port network. Why use nine different elements, and why the  $3 \times 3$  matrix?

Here are the answers: First, to use the Y matrix, you must convert the three-terminal network to a two-port network by selecting one of the nodes to be the common point. And there are now three possible—but different—Y matrices that represent the same network (Fig. 2). In fact, this is why the  $2 \times 2$  matrix is considered to be definite; a given matrix applies to a circuit connected in a specific, or definite, way to the outside world.

Second, the indefinite matrix of Eqs. 2 or 3 contains redundant elements: The sum of all the elements in a given row or column is zero. There-

**D. J. Daruvala**, Senior Lecturer, Electrical Engineering, Middlesex Polytechnic, Queensway, Enfield EN3:4SF, Middx., England.

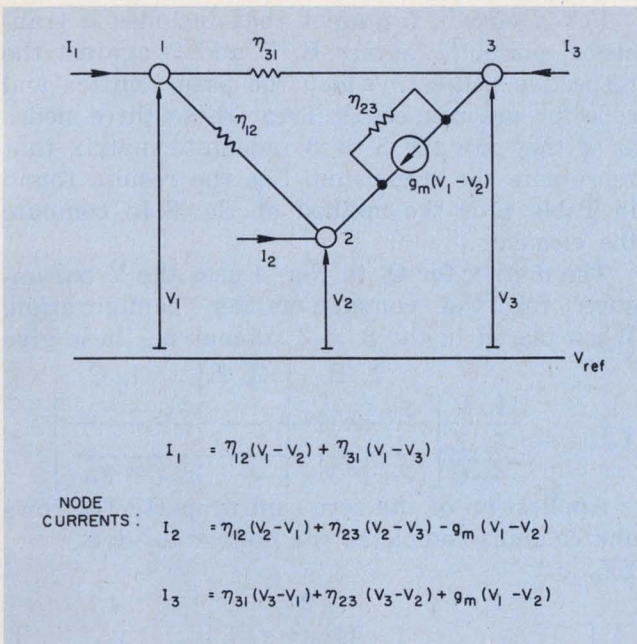

1. **Indefinite-matrix circuit analysis** begins with a description of the currents that flow into each node, including that of the dependent source. Voltages are taken with respect to a floating reference rather than the voltage at any particular node. The indefinite matrix relates the currents  $I$  to the voltages  $V$ .

fore only four quantities need be specified; the remaining five can be calculated from the property that all elements in a given row or column sum to zero.

Also the row and column sum property holds true for  $n \times n$  indefinite matrices—provided that the network contains no independent sources.<sup>1,2</sup> And the matrix is symmetrical—that is,  $y_{rs} = y_{sr}$  if the network is passive.

**Relation of YF to two-port parameters**

A transistor can be considered a two-port element: One terminal is common; the two others are input and output, respectively. Each of these configurations can be described by means of the two-port  $y$  parameters.

For the common-emitter configuration:

$$\begin{bmatrix} I_b \\ I_c \end{bmatrix} = \begin{bmatrix} y_{ie} & y_{re} \\ y_{fe} & y_{oe} \end{bmatrix} \begin{bmatrix} V_{BE} \\ V_{CE} \end{bmatrix} \quad (5a)$$

For the common-base configuration:

$$\begin{bmatrix} I_e \\ I_c \end{bmatrix} = \begin{bmatrix} y_{ib} & y_{rb} \\ y_{fb} & y_{ob} \end{bmatrix} \begin{bmatrix} V_{EB} \\ V_{CB} \end{bmatrix} \quad (5b)$$

And for the common-collector configuration:

$$\begin{bmatrix} I_b \\ I_e \end{bmatrix} = \begin{bmatrix} y_{ic} & y_{rc} \\ y_{fc} & y_{oc} \end{bmatrix} \begin{bmatrix} V_{BC} \\ V_{EC} \end{bmatrix} \quad (5c)$$

The coefficients for the YF matrix of a transistor (Fig. 3) are found by comparing the coefficients in the YF matrix with those in each of the three  $Y$  matrices. The voltage of the corresponding common terminal is set to zero for each comparison.

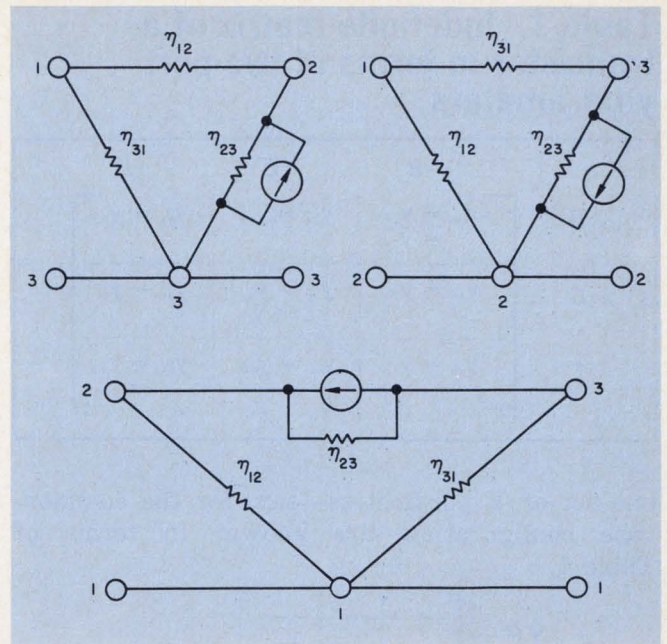

2. **Three separate two-port matrices** are needed to characterize the three-node network. The contents of each matrix depend on which node is chosen as the common point. By contrast, a single indefinite matrix (Eq. 3) describes this circuit. All terminal voltages are then specified with respect to a floating reference.

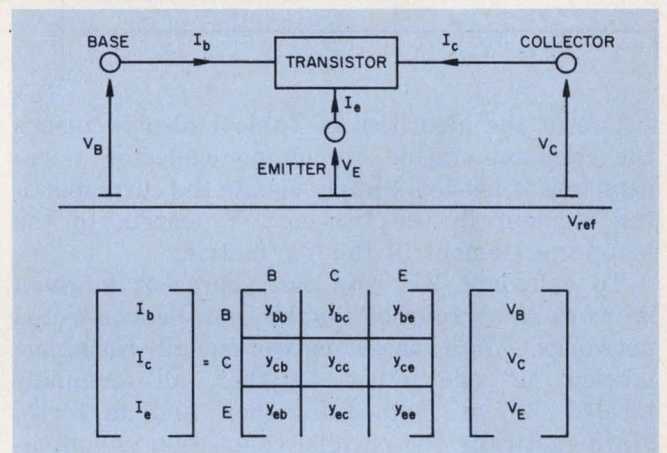

3. A **3 × 3 indefinite matrix** represents a simple transistor model. The coefficients of the matrix can be found through a comparison with two-port  $y$  parameters.

With  $V_E$  set to zero, the indefinite matrix in Fig. 3 describes the common-emitter configuration currents:

$$\begin{aligned} I_b &= y_{bb} V_B + y_{bc} V_C, \\ I_c &= y_{cb} V_B + y_{cc} V_C. \end{aligned} \quad (6)$$

And comparison with Eq. 4a gives

$$\begin{aligned} y_{bb} &= y_{ie} \\ y_{bc} &= y_{re} \\ y_{cb} &= y_{fe} \\ y_{cc} &= y_{oe} \end{aligned} \quad (7)$$

Similar calculations for the common-emitter and common-base configurations provide the identities shown in Table 1.

The zero-sum property of the columns and rows also allows the calculation of YF if only

**Table 1. Indefinite matrix of a transistor in terms of two-port y parameters**

	B	C	E
B	$y_{bb} = y_{ie} = y_{ie}$	$y_{bc} = y_{re}$	$y_{be} = y_{rc}$
C	$y_{cb} = y_{fe}$	$y_{cc} = y_{oe} = y_{ob}$	$y_{ce} = y_{fb}$
E	$y_{eb} = y_{fc}$	$y_{ec} = y_{rb}$	$y_{ee} = y_{oc} = y_{ib}$

one set of Y parameters—say, for the common-base configuration—are known. In terms of Table 1,

$$YF = \begin{bmatrix} \text{---} & y_{ob} & y_{fb} \\ \text{---} & y_{rb} & y_{ib} \end{bmatrix}$$

To complete the matrix, use the zero-sum property and find that

$$YF = \begin{bmatrix} (y_{ob} + y_{fb} + y_{rb} + y_{ib}) & -(y_{ob} + y_{rb}) & -(y_{fb} + y_{ib}) \\ -(y_{ob} + y_{fb}) & y_{ob} & y_{fb} \\ -(y_{rb} + y_{ib}) & y_{rb} & y_{ib} \end{bmatrix} \quad (8)$$

Use of the identities in Table 1 also furnishes the common-emitter or common-collector y parameters if needed. Simply equate the corresponding element in the two-port Y matrix to the matching element in the YF matrix.

To calculate YF, you can represent a given network as a group of simpler, parallel-connected networks. With these networks, all terminals labeled "1" are joined together, all terminals labeled "2" are joined together, and so forth. Mathematically the parallel connection is equivalent to the addition of the YF matrices that correspond to these networks. The steps to determine the indefinite matrix for the over-all network are then:

1. Label each node.
2. Break the circuit up into component networks—one network for the passive elements and separate networks for each active element.
3. Determine YF for each component network.
4. Add the individual YFs to give the complete indefinite matrix.

Each of the matrices for the component networks, as well as the over-all matrix, have dimensions of  $n \times n$ , where  $n$  is the number of nodes in the network. Each row, column of the component matrix or the over-all matrix corresponds to a particular circuit node. The row and column that correspond to an unconnected node of the component network are set to zero.

For a circuit fragment that includes a transistor, place the letters B, E and C against the respective nodes to which the base, emitter and collector are connected. Treat these three nodes as if they are the  $3 \times 3$  indefinite matrix that represents the transistor. Use the results found in Table 1 or the method of Eq. 8 to compute the elements.

The matrix for  $Q_1$  in Fig. 4 uses the Y parameters for the common-emitter configuration. When placed in the  $3 \times 3$  submatrix, these give

$$YF_{(Q1)} = \begin{matrix} & \begin{matrix} 1, B \\ 2, E \\ 4, C \end{matrix} & \begin{matrix} 2, E \\ 4, C \end{matrix} & \begin{matrix} 4, C \end{matrix} \\ \begin{matrix} 1, B \\ 2, E \\ 4, C \end{matrix} & \begin{bmatrix} y_{bb} = y_{ie} & & \\ & y_{bc} = y_{re} & \\ & & y_{cc} = y_{oe} \end{bmatrix} & & \end{matrix}$$

Application of the zero-sum property for rows and columns completes the matrix to give

$$YF_{Q1} = \begin{matrix} & \begin{matrix} 1 & 2 & 4 \end{matrix} \\ \begin{matrix} 1 \\ 2 \\ 4 \end{matrix} & \begin{bmatrix} y_{ie} & -(y_{ie} + y_{re}) & y_{re} \\ -(y_{ie} + y_{fe}) & y_{ie} + y_{re} & -(y_{re} + y_{oe}) \\ y_{fe} & -(y_{fe} + y_{oe}) & y_{oe} \end{bmatrix} \end{matrix}$$

The final result is obtained by transferring the elements to their proper position in the  $5 \times 5$  matrix.

The indefinite matrix for the passive portion of the network is written by inspection. The rules are:

- Each diagonal element  $y_{rr}$  equals the sum of all admittances connected to node  $r$ .
- An off-diagonal element  $y_{rs}$  equals minus the admittance connected between node  $r$  and node  $s$ .
- Elements in rows or columns that correspond to unconnected nodes are zero.

### Reduce the YF matrix

With the YF matrix well in hand, you can proceed to analyze the input-output relationships for the over-all network (Fig. 5). The trick is to compute the two-port y parameters for the network. Then conventional two-port transformations can supply the values for input impedance, voltage gain, current gain or the output impedance of the circuit.

With a two-port connection, there is no need to make external connections to nodes 2 and 3; nor is there any reason to know their voltages. All you need know is the voltage of node 1 with respect to node 5 and the voltage of node 4 with respect to node 5.

A glance at Fig. 5 shows that if you "suppress" nodes 2 and 3 and make 5 the reference node, you can obtain the two-port Y parameters from the YF matrix.

When any node  $j$  is suppressed, it is no longer available for connection to an external circuit, and the corresponding current  $I_j$  must be zero.

Then for node 2

$0 = y_{21} V_1 + y_{22} V_2 + y_{23} V_3 + y_{24} V_4 + y_{25} V_5$ ,  
 where the  $y_{sr}$  correspond to the entries in row 2  
 of YF (Fig. 4). Solve for  $V_2$  and get

$$V_2 = -\left(\frac{y_{21}}{y_{22}}\right)V_1 - \left(\frac{y_{23}}{y_{22}}\right)V_3 - \left(\frac{y_{24}}{y_{22}}\right)V_4 - \left(\frac{y_{25}}{y_{22}}\right)V_5 \quad (9)$$

The substitution of  $V_2$  into the original matrix  
 equations gives

$$\begin{bmatrix} I_1 \\ I_3 \\ I_4 \\ I_5 \end{bmatrix} = \begin{bmatrix} \text{See table 2 for} \\ \text{computation of } y_{rs} \end{bmatrix} \begin{bmatrix} V_1 \\ V_3 \\ V_4 \\ V_5 \end{bmatrix} \quad (10)$$

Similarly the current to node 3 is made zero,

Circuit		Indefinite matrix				
		1	2	3	4	5
1		$g_b$	0	0	0	$-g_b$
2		0	0	0	0	0
3		0	0	$g_4$	0	$-g_4$
4		0	0	0	$g_3$	$-g_3$
5		$-g_b$	0	$-g_4$	$-g_3$	$g_b + g_4 + g_3$
		1	2	3	4	5
1		$y_{ie}$	$-(y_{ie} + y_{re})$	0	$y_{re}$	0
2		$-(y_{ie} + y_{re})$	$y_{re} + y_{oe} + y_{ie} + y_{re}$	0	$-(y_{re} + y_{oe})$	0
3		0	0	0	0	0
4		$y_{re}$	$-(y_{re} + y_{oe})$	0	$y_{oe}$	0
5		0	0	0	0	0
		1	2,B	3,E	4,C	5
1		0	0	0	0	0
2,B		0	$y'_{ie}$	$-(y'_{ie} + y'_{re})$	$y'_{re}$	0
3,E		0	$-(y'_{ie} + y'_{re})$	$y'_{ie} + y'_{re} + y'_{re} + y'_{oe}$	$-(y'_{re} + y'_{oe})$	0
4,C		0	$y'_{re}$	$-(y'_{re} + y'_{oe})$	$y'_{oe}$	0
5		0	0	0	0	0
		1	2	3	4	5
1		$g_b + y_{ie}$	$-(y_{ie} + y_{re})$	0	$y_{re}$	$-g_b$
2		$-y_{ie} - y_{re}$	$y_{re} + y_{ie} + y_{re} + y_{oe} + y'_{ie}$	$-y'_{ie}$ $-y'_{re}$	$y'_{re}$ $-y_{re} - y_{oe}$	0
3		0	$-y'_{ie} - y'_{re}$	$y'_{ie} + y'_{re} + y'_{re} + y'_{oe}$ $g_4$	$-y_{re} - y'_{oe}$	$-g_4$
4		$y_{re}$	$-y_{re} - y_{oe} + y'_{re}$	$-y'_{re} - y'_{oe}$	$y'_{oe} + g_3 + y'_{oe}$	$-g_3$
5		$-g_b$	0	$-g_4$	$-g_3$	$g_b + g_3 + g_4$

4. Fragmentation of the original circuit helps calculate the YF matrix. Each submatrix is first calculated in the

absence of the other components. Then like elements in each array are added to form the over-all YF matrix.

**Table 2. Elements of matrix YF with nodes 2 and 3 deleted**

Entity	Deletion of node 2	Deletion of node 3																									
Equation	$\begin{bmatrix} I_1 \\ I_3 \\ I_4 \\ I_5 \end{bmatrix} = \begin{bmatrix} (y_{11})_1 & (y_{12})_1 & (y_{13})_1 & (y_{14})_1 \\ (y_{21})_1 & (y_{22})_1 & (y_{23})_1 & (y_{24})_1 \\ (y_{31})_1 & (y_{32})_1 & (y_{33})_1 & (y_{34})_1 \\ (y_{41})_1 & (y_{42})_1 & (y_{43})_1 & (y_{44})_1 \end{bmatrix} \begin{bmatrix} V_1 \\ V_3 \\ V_4 \\ V_5 \end{bmatrix}$	$\begin{bmatrix} I_1 \\ I_4 \\ I_5 \end{bmatrix} = \begin{bmatrix} (y_{11})_2 & (y_{12})_2 & (y_{13})_2 \\ (y_{21})_2 & (y_{22})_2 & (y_{23})_2 \\ (y_{31})_2 & (y_{32})_2 & (y_{33})_2 \end{bmatrix} \begin{bmatrix} V_1 \\ V_4 \\ V_5 \end{bmatrix}$																									
Matrix elements	<table border="1"> <tr> <td><math>y_{11} - \frac{y_{12} y_{21}}{y_{22}}</math></td> <td><math>y_{13} - \frac{y_{12} y_{23}}{y_{22}}</math></td> <td><math>y_{14} - \frac{y_{12} y_{24}}{y_{22}}</math></td> <td><math>y_{15} - \frac{y_{12} y_{25}}{y_{22}}</math></td> </tr> <tr> <td><math>y_{32} - \frac{y_{32} y_{21}}{y_{22}}</math></td> <td><math>y_{33} - \frac{y_{32} y_{23}}{y_{22}}</math></td> <td><math>y_{34} - \frac{y_{32} y_{24}}{y_{22}}</math></td> <td><math>y_{35} - \frac{y_{32} y_{25}}{y_{22}}</math></td> </tr> <tr> <td><math>y_{41} - \frac{y_{42} y_{21}}{y_{22}}</math></td> <td><math>y_{42} - \frac{y_{42} y_{23}}{y_{22}}</math></td> <td><math>y_{44} - \frac{y_{42} y_{24}}{y_{22}}</math></td> <td><math>y_{45} - \frac{y_{42} y_{25}}{y_{22}}</math></td> </tr> <tr> <td><math>y_{51} - \frac{y_{52} y_{21}}{y_{22}}</math></td> <td><math>y_{53} - \frac{y_{52} y_{23}}{y_{22}}</math></td> <td><math>y_{54} - \frac{y_{52} y_{24}}{y_{22}}</math></td> <td><math>y_{55} - \frac{y_{52} y_{25}}{y_{22}}</math></td> </tr> </table>	$y_{11} - \frac{y_{12} y_{21}}{y_{22}}$	$y_{13} - \frac{y_{12} y_{23}}{y_{22}}$	$y_{14} - \frac{y_{12} y_{24}}{y_{22}}$	$y_{15} - \frac{y_{12} y_{25}}{y_{22}}$	$y_{32} - \frac{y_{32} y_{21}}{y_{22}}$	$y_{33} - \frac{y_{32} y_{23}}{y_{22}}$	$y_{34} - \frac{y_{32} y_{24}}{y_{22}}$	$y_{35} - \frac{y_{32} y_{25}}{y_{22}}$	$y_{41} - \frac{y_{42} y_{21}}{y_{22}}$	$y_{42} - \frac{y_{42} y_{23}}{y_{22}}$	$y_{44} - \frac{y_{42} y_{24}}{y_{22}}$	$y_{45} - \frac{y_{42} y_{25}}{y_{22}}$	$y_{51} - \frac{y_{52} y_{21}}{y_{22}}$	$y_{53} - \frac{y_{52} y_{23}}{y_{22}}$	$y_{54} - \frac{y_{52} y_{24}}{y_{22}}$	$y_{55} - \frac{y_{52} y_{25}}{y_{22}}$	<table border="1"> <tr> <td><math>(y_{11})_1 - \frac{(y_{12})_1 (y_{21})_1}{(y_{22})_1}</math></td> <td><math>(y_{13})_1 - \frac{(y_{12})_1 (y_{23})_1}{(y_{22})_1}</math></td> <td><math>(y_{14})_1 - \frac{(y_{12})_1 (y_{24})_1}{(y_{22})_1}</math></td> </tr> <tr> <td><math>(y_{31})_1 - \frac{(y_{32})_1 (y_{21})_1}{(y_{22})_1}</math></td> <td><math>(y_{33})_1 - \frac{(y_{32})_1 (y_{23})_1}{(y_{22})_1}</math></td> <td><math>(y_{34})_1 - \frac{(y_{32})_1 (y_{24})_1}{(y_{22})_1}</math></td> </tr> <tr> <td><math>(y_{41})_1 - \frac{(y_{42})_1 (y_{21})_1}{(y_{22})_1}</math></td> <td><math>(y_{43})_1 - \frac{(y_{42})_1 (y_{23})_1}{(y_{22})_1}</math></td> <td><math>(y_{44})_1 - \frac{(y_{42})_1 (y_{24})_1}{(y_{22})_1}</math></td> </tr> </table>	$(y_{11})_1 - \frac{(y_{12})_1 (y_{21})_1}{(y_{22})_1}$	$(y_{13})_1 - \frac{(y_{12})_1 (y_{23})_1}{(y_{22})_1}$	$(y_{14})_1 - \frac{(y_{12})_1 (y_{24})_1}{(y_{22})_1}$	$(y_{31})_1 - \frac{(y_{32})_1 (y_{21})_1}{(y_{22})_1}$	$(y_{33})_1 - \frac{(y_{32})_1 (y_{23})_1}{(y_{22})_1}$	$(y_{34})_1 - \frac{(y_{32})_1 (y_{24})_1}{(y_{22})_1}$	$(y_{41})_1 - \frac{(y_{42})_1 (y_{21})_1}{(y_{22})_1}$	$(y_{43})_1 - \frac{(y_{42})_1 (y_{23})_1}{(y_{22})_1}$	$(y_{44})_1 - \frac{(y_{42})_1 (y_{24})_1}{(y_{22})_1}$
$y_{11} - \frac{y_{12} y_{21}}{y_{22}}$	$y_{13} - \frac{y_{12} y_{23}}{y_{22}}$	$y_{14} - \frac{y_{12} y_{24}}{y_{22}}$	$y_{15} - \frac{y_{12} y_{25}}{y_{22}}$																								
$y_{32} - \frac{y_{32} y_{21}}{y_{22}}$	$y_{33} - \frac{y_{32} y_{23}}{y_{22}}$	$y_{34} - \frac{y_{32} y_{24}}{y_{22}}$	$y_{35} - \frac{y_{32} y_{25}}{y_{22}}$																								
$y_{41} - \frac{y_{42} y_{21}}{y_{22}}$	$y_{42} - \frac{y_{42} y_{23}}{y_{22}}$	$y_{44} - \frac{y_{42} y_{24}}{y_{22}}$	$y_{45} - \frac{y_{42} y_{25}}{y_{22}}$																								
$y_{51} - \frac{y_{52} y_{21}}{y_{22}}$	$y_{53} - \frac{y_{52} y_{23}}{y_{22}}$	$y_{54} - \frac{y_{52} y_{24}}{y_{22}}$	$y_{55} - \frac{y_{52} y_{25}}{y_{22}}$																								
$(y_{11})_1 - \frac{(y_{12})_1 (y_{21})_1}{(y_{22})_1}$	$(y_{13})_1 - \frac{(y_{12})_1 (y_{23})_1}{(y_{22})_1}$	$(y_{14})_1 - \frac{(y_{12})_1 (y_{24})_1}{(y_{22})_1}$																									
$(y_{31})_1 - \frac{(y_{32})_1 (y_{21})_1}{(y_{22})_1}$	$(y_{33})_1 - \frac{(y_{32})_1 (y_{23})_1}{(y_{22})_1}$	$(y_{34})_1 - \frac{(y_{32})_1 (y_{24})_1}{(y_{22})_1}$																									
$(y_{41})_1 - \frac{(y_{42})_1 (y_{21})_1}{(y_{22})_1}$	$(y_{43})_1 - \frac{(y_{42})_1 (y_{23})_1}{(y_{22})_1}$	$(y_{44})_1 - \frac{(y_{42})_1 (y_{24})_1}{(y_{22})_1}$																									

and the equations reduce to

$$\begin{bmatrix} I_1 \\ I_4 \\ I_5 \end{bmatrix} = \begin{bmatrix} \text{See table 2 for} \\ \text{computation of } y_{rs} \end{bmatrix} \begin{bmatrix} V_1 \\ V_4 \\ V_5 \end{bmatrix} \quad (11)$$

Since reduced YF matrices are also indefinite, the zero sum property holds. A good error check is to make sure that the rows and columns still add up to zero at each stage of the computation.

Voltages  $V_1$ ,  $V_4$  and  $V_5$  are still indefinite—that is, specified with respect to some reference voltage,  $V_{ref}$ . Since  $V_1 - V_5$  and  $V_4 - V_5$  are required, make  $V_5$  the reference voltage by setting it to zero. The corresponding matrix operation—deletion of the row and column for  $V_5$ —gives the two-port Y matrix:

$$\begin{bmatrix} I_1 \\ I_4 \end{bmatrix} = \begin{bmatrix} (y_{11})_2 & (y_{12})_2 \\ (y_{21})_2 & (y_{22})_2 \end{bmatrix} \begin{bmatrix} V_1 \\ V_4 \end{bmatrix}$$

And the matrix terms are now the standard y-parameters of the two-port network.

The calculations needed to characterize the network are simple. Use the standard y-to-h parameter conversions<sup>3</sup> to compute  $h_{11}$ ,  $h_{12}$ ,  $h_{21}$  and  $h_{22}$  for the network. As an example, the quantity  $e_2/e_s$  (Fig. 5) can be computed from

$$e_2/e_s = (e_1/e_s) \cdot (e_2/e_1). \quad (12)$$

The first term is given by

$$e_1/e_s = \frac{Z_{in}}{Z_{in} + Z_s}. \quad (13)$$

The quantities  $Z_{in}$  and  $(e_2/e_1)$  are calculated from the well-known expressions for terminated two-ports:

$$e_2/e_1 = A_v = \frac{-h_{21} Z_L}{h_{11} Z_L \Delta_h} \quad (14)$$

and

$$Z_{in} = \frac{h_{11} (1 + Z_L h_{22}) - h_{12} h_{21} Z_L}{(1 + h_{22} Z_L)}, \quad (15)$$

where  $\Delta_h = \det \begin{bmatrix} h_{11} & h_{12} \\ h_{21} & h_{22} \end{bmatrix}$

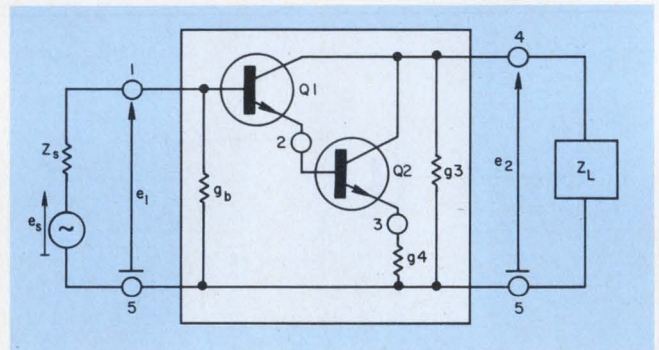

5. Only nodes 1, 4 and 5 are necessary to characterize the circuit's two-port operation. Nodes 2 and 3 are not used for any external connections, and the external currents to these can be set to zero in the YF matrix.

The methods described are more versatile than those that depend on the breaking down of a given network into combinations of two-ports. The advantages are particularly great when numerical answers, rather than algebraic expressions, must be obtained. The method also permits frequent self-checks, because of the zero-sum properties of the rows and columns of the indefinite matrices. ■■

**References**

- Weinberg, L., "Network Analysis and Synthesis," McGraw-Hill, 1962, p. 57.
- Barabaschi, S., and Gatti, E., "Modern Methods of Analysis for Active Electrical Networks with Particular Regard to Feed-Back Systems," Part 1, *Energia Nucleare*, Vol. 2, December, 1954, pp. 105-109 (proof in Appendix II).
- Seshu, S. and Balabanian, N., "Linear Network Analysis," John Wiley & Sons, Inc., New York, 1959, p. 300.

The second article will discuss the use of the indefinite matrix for CAD calculations.





# ONE KEY to your rf measurement problems

**One key** unlocks the full potential of the new GR 2260 Automatic Network Analyzer — a fully automatic system for detailed measurements of transmission, reflection, magnitude, phase, and group delay from 200 kHz to 500 MHz.

**One key** for rapid go/no-go production testing. The 2260 eliminates the need for multiple test stations by producing simultaneous measurements of multiple rf parameters against individually tailored limits — all at the push of a button and in little more time than it takes to connect the device.

**One key** for high-precision R & D work. The 2260 provides real-time displays of interactive rf parameters for visual interpretation of design changes and allows modification of test conditions in seconds — all by ultra-simple keyboard commands.

The key —



**General Radio**

300 Baker Ave., Concord, MA 01742



# More ideas from Amphenol's

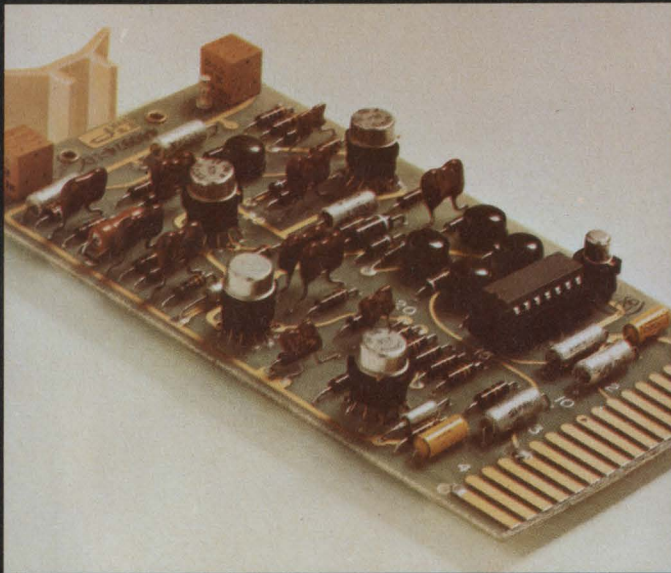

**level 1** Low-cost sockets for transistors in TO packages (above) allow easy replacement and service. ■ New IC sockets are end and side stackable for maximum single board density. Low profile design also allows maximum multi-board density.

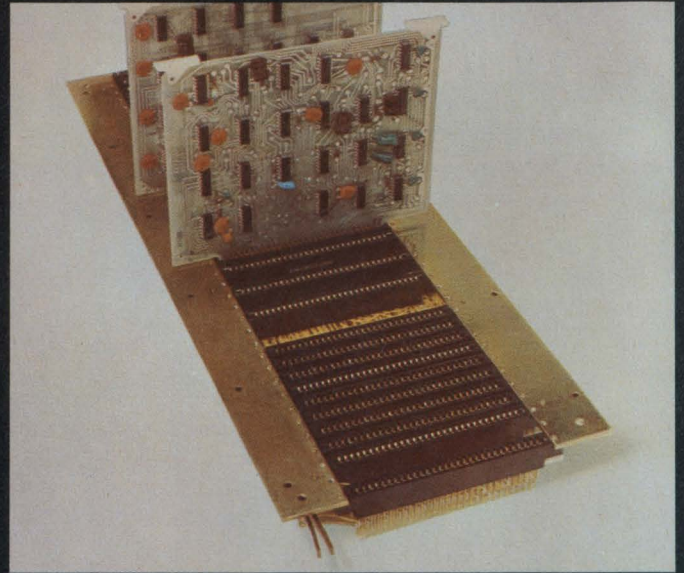

**level 2** Back panel edge board connectors with bifurcated contacts (above) can be wire wrapped or clip-terminated. ■ Bellows contact PC connectors (below) cut interconnection costs without sacrificing performance.

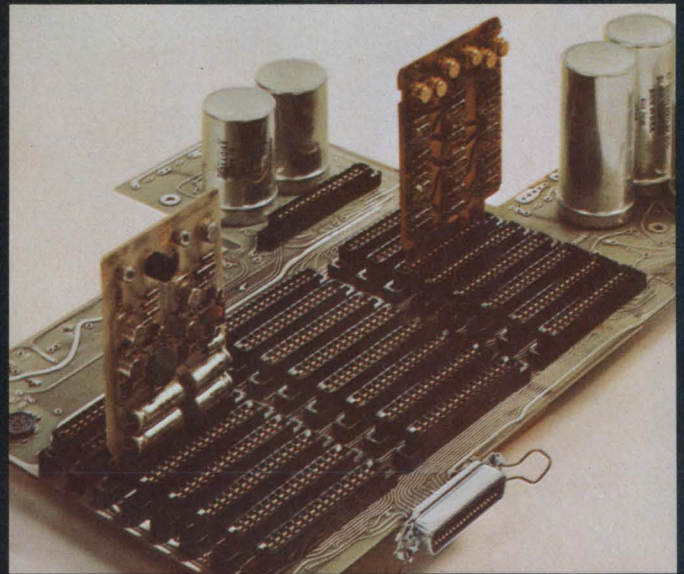
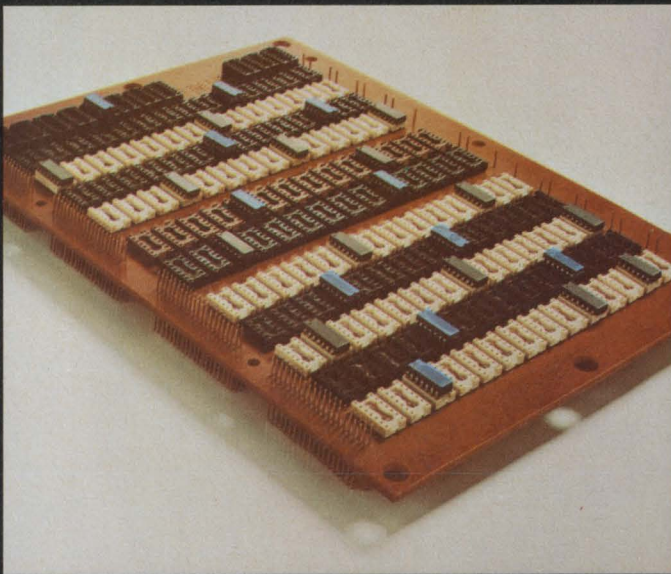

Above are seven new ideas from Amphenol Industrial Division's Spectrum of interconnection capability.

Amphenol's SPECTRUM offers you *all four* levels of interconnections from our unmatched breadth of product line:

**Level 1 . . . DEVICE TO BOARD OR CHASSIS.** We offer interconnections for components such as tubes, relays, transistors, IC packages, trimmers, resistors or capacitors to a PC board or chassis.

**Level 2 . . . BOARD TO MOTHERBOARD OR BACK PLANE.** We offer interconnections for PC boards or

other sub-circuit modules to a motherboard or to a back plane.

**Level 3 . . . MOTHERBOARD OR BACK PLANE WIRING.** We offer interconnections for levels to each other and to other sub-circuits with multi-layer circuit boards, wire wrapping, clip terminations, jumper techniques and dip-soldering.

**Level 4 . . . INPUT/OUTPUT CONNECTIONS.** We offer interconnections for power and signals to and from a system. This interface may be between sub-assemblies within the same enclosure or between individual units.

# Spectrum of interconnections.

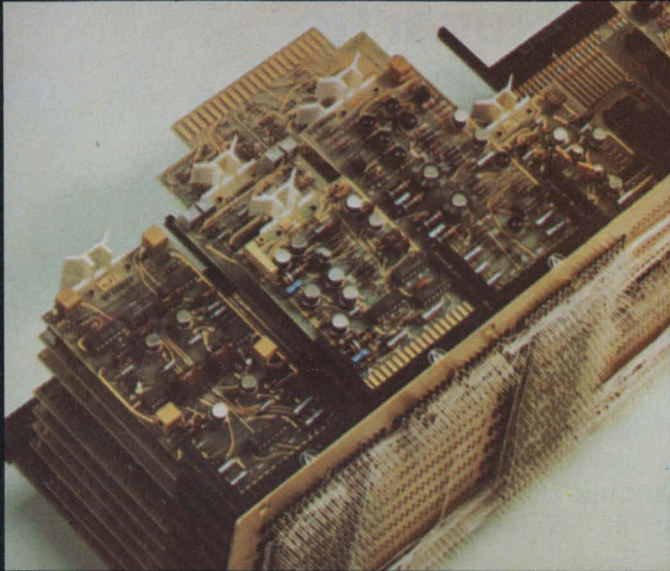

level **3** Direct entry plate assembly offers modular packaging flexibility. Custom designed plates accommodate any size or style PC board with no tooling cost to you. Rectangular posts are true positioned for automatic wire-wrapping.

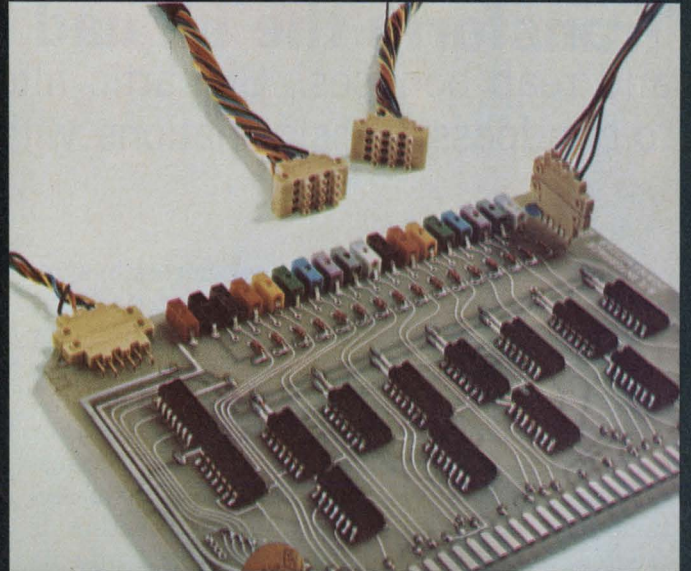

level **4** Miniature contact (3 input, 3 output) hermaphroditic connectors can be snapped together to connect as many circuits as required. ■ Single finger-tip mounting of low cost connector saves assembly time. Available in UL Class SE-1 flammability rated material.

Write for our Spectrum brochure covering all levels of interconnections.

**Spectrum**  
OF INTERCONNECTION CAPABILITY

AMPHENOL  
INDUSTRIAL DIVISION

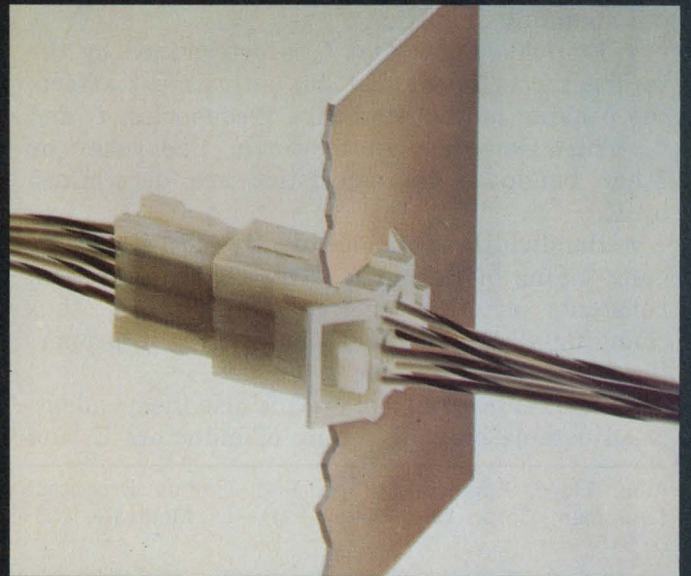

From the simple tube socket—to a myriad of electrical/electronic connectors—to complete and complex termination systems . . . SPECTRUM.

But SPECTRUM is far more than products. It is a depth of capability in engineering, manufacturing and quality control. Amphenol's SPECTRUM is a new height of service, availability and distribution backed by seven Amphenol interconnection-oriented divisions.

Amphenol can fulfill your total interconnection requirements because we are not limited to specifics such as one or two product lines, one or two levels.

Therefore we approach your interconnection needs with complete open-mindedness.

For more new ideas and specific information, write for your copy of "SPECTRUM." Amphenol Industrial Division, Bunker Ramo Corp., 1830 South 54th Ave., Chicago, Illinois 60650.

**BUNKER RAMO** AMPHENOL

# Transform the biquad into a biquartic and reap bonuses.

Biquartic filters allow easy low-pass to-bandpass transformations with few calculations.

Want to avoid the mathematical morass in symmetrical bandpass designs? Use a biquartic filter.

Many designers cascade second-order filter building blocks, using the biquad circuit of Fig. 1, to get higher-order filters. The higher-order bandpass transfer function must first be written. For symmetrical functions, this is done by a transformation of the frequency variable. If two sections are cascaded, a fourth-order function is created, and this then must be factored into its quadratic forms—a messy procedure at best.

The biquartic design (Fig. 2) offers the following features:

- Zeros are generated in symmetrical pairs. They are easily added or shifted by a change in only one resistor (coefficient d or f) in the output summing amplifier.

- Equivalent low-pass Q is determined by the feedback coefficient, K. This adjustment affects the peaking at the band-edge frequencies,  $f_1$  and  $f_2$ . Thus Gaussian, Butterworth, Chebyshev or other bandpass characteristics are determined by K.

- Bandwidth is independently adjustable by gang-tuning of  $R_1$  and  $R_2$ . This changes the gain constants of the bandpass integrators, thus changing all the bandwidths and zeros in proportion.

- The center frequency,  $\omega_0$ , is also independently adjustable by gang-tuning of inductors  $L_1$  and

**Allan Lloyd**, Engineering Specialist, Philips Broadcast Equipment Corp., One Philips Parkway, Montvale, N.J. 07645

$L_2$  or their active equivalents.

- All capacitors can have the same value.

- All tuning adjustments can be made with voltage-variable resistors, thus allowing remote control of these factors.

Since the biquartic filters are a modification of the now common biquad circuit, we can start by analyzing the transfer function of the biquad. For the circuit of Fig. 1, the transfer function is

$$G(s) = \frac{R_4}{R_3} \frac{ds^2 - e\alpha_1 s + f\omega_c^2}{s^2 + k\alpha_1 s (1 + R_4/R_3 + R_4/R_5) + \omega_c^2 R_4/R_5} \quad (1)$$

where  $\alpha_1 = 1/R_1 C_1$ ,  $\alpha_2 = 1/R_2 C_2$ , and  $\omega_c^2 = \alpha_1 \alpha_2$ . Output coefficients d, e and f determine the actual circuit function—low-pass, high-pass, bandpass, etc. Table 1 shows some of the transfer functions for combinations of the three output coefficients. The corresponding frequency response curves are shown in Fig. 3.

Substitution of  $(s^2 + \omega_0^2)/s$  for the "s" terms in Eq. 1 doubles the order of the transfer function and shifts the center frequency from  $\omega = 0$  to  $\omega = \omega_0$  while preserving all the bandwidths. In Fig. 3, second-order curves a through g are transformed into fourth-order curves a' thru g'.

To transform any RLC network, the rules are as follows: Shunt every original C with an added parallel L, and place a C in series with every original L. Resonate all newly formed LC pairs to  $\omega_0$  by choosing the value of the added component. This is illustrated in Fig. 4. Resistor values in the circuit remain unchanged.

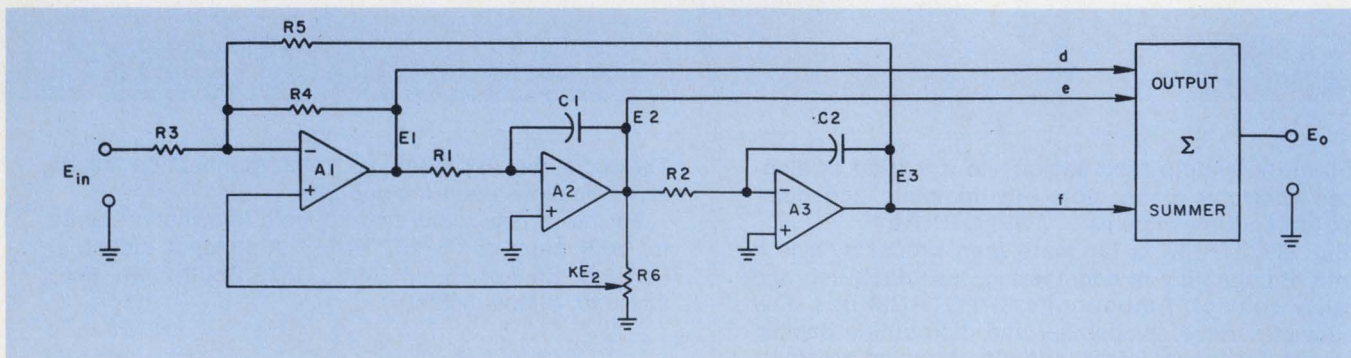

1. The basic biquad active filter delivers the low-pass, high-pass, bandpass and all-pass functions simultaneously

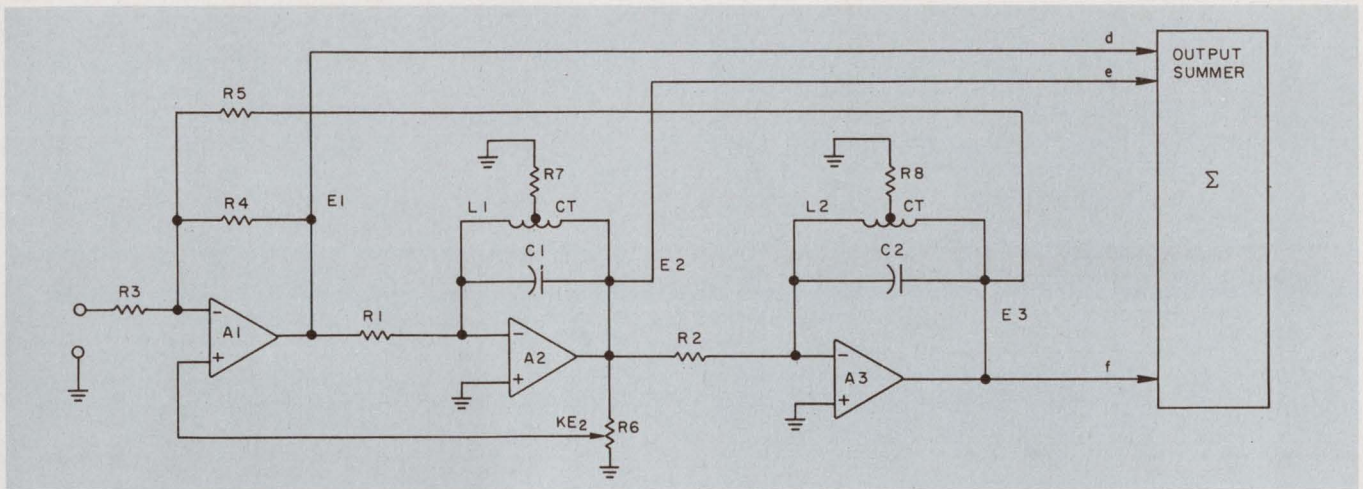

2. With the addition of some inductors, the biquad is easily transformed into an LC biquartic.

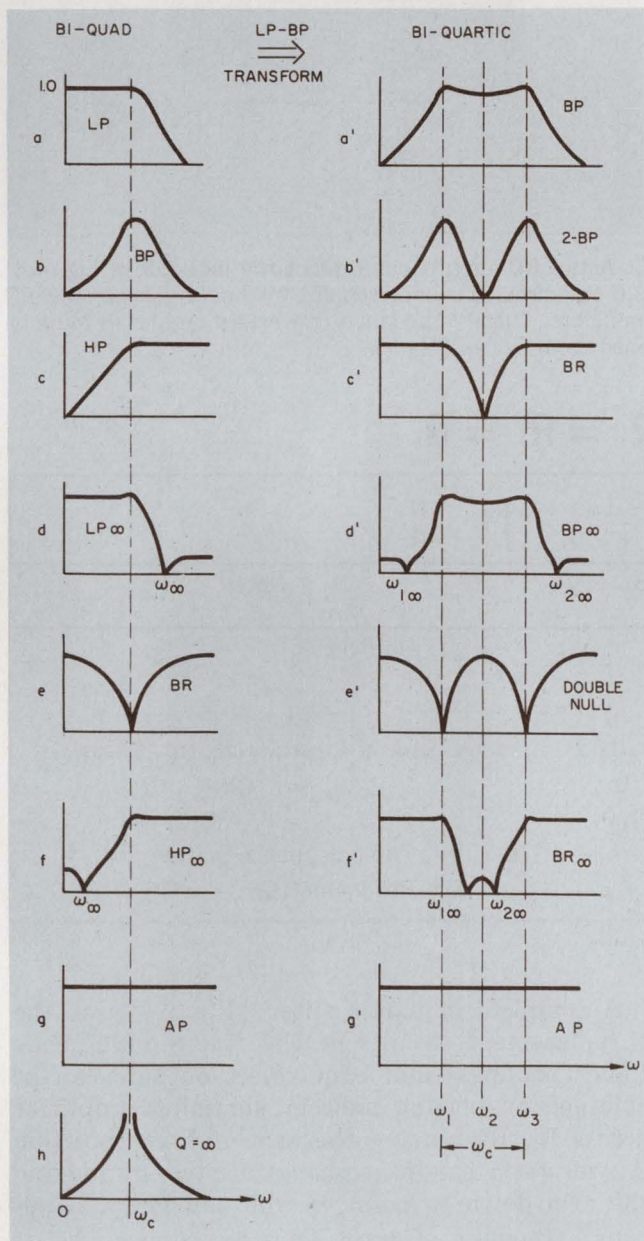

3. When an LP-to-BP transformation is performed, a fourth-order biquartic transfer function results.

By adding inductors  $L_1$  and  $L_2$  and compensating resistors  $R_7$  and  $R_8$  to the biquad of Fig. 1, we can convert it into a biquartic filter with the resonator  $Q$ 's approaching infinity. Although adding inductors may seem like a retrogression, it isn't; the circuit of Fig. 2 is quite usable. The uncompensated  $Q$ 's of the LC circuits are typically greater than 100. Positive feedback is then less than 1%, and bandwidths to 0.1% are possible over a 2-to-50-kHz center frequency range.

#### Designing out the inductances

There are several ways to eliminate the  $L$  from the circuit in Fig. 2. Three direct replacement circuits for  $L$ 's are shown in Fig. 5. The circuits of Figs. 5b and 5c depend upon component balance to establish  $Q = \infty$ , while that of Fig. 5a doesn't need balancing but requires more op amps and may need some phase-shift compensation. All of these circuits produce an output current that is the positive integral of the input voltage. They are for use as the feedback  $L$  in the inverting bandpass integrator of Fig. 4d, or as replacements for  $L_1$  and  $L_2$  of Fig. 2; they do not work as general  $L$  replacements.

The only difference between Figs. 4c and 4d is in the integrators. They are transformed from low-pass, where  $G = \alpha/s$ , to bandpass, with  $G = -\alpha s/(s^2 + \omega_0^2)$ . For the same value of  $\alpha$ , both the low-pass and bandpass bandwidths are the same.

Any second-order active circuit that has a bandpass integrator function of the form  $G = Ks/(s^2 + \omega_0^2)$  can be used in the biquartic filter to replace the entire active LC integrator of Fig. 4d. Fig. 6 shows four such circuits and their transfer functions. Positive feedback is used for the circuits of Figs. 6a, 6b and 6c, thus achieving  $Q = \infty$ . In Figs. 6a and 6b a nominal input resistance of  $R \Omega$  is split to form a divider of  $R/n$

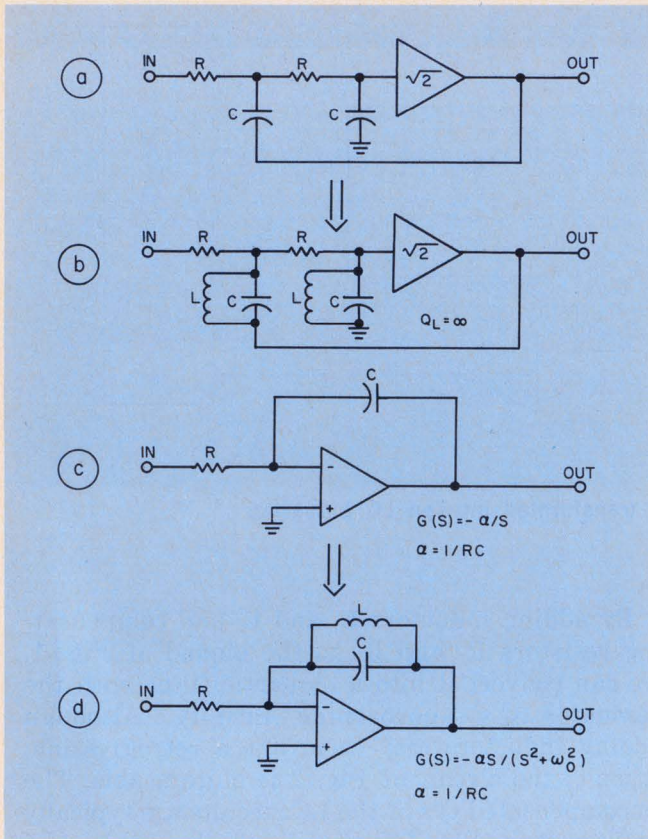

4. Some simple LP-to-BP realizations include a two-pole LP Butterworth to a four-pole BP Butterworth (a and b) and a single-pole LP integrator to a  $Q = \infty$  resonator (c and d).

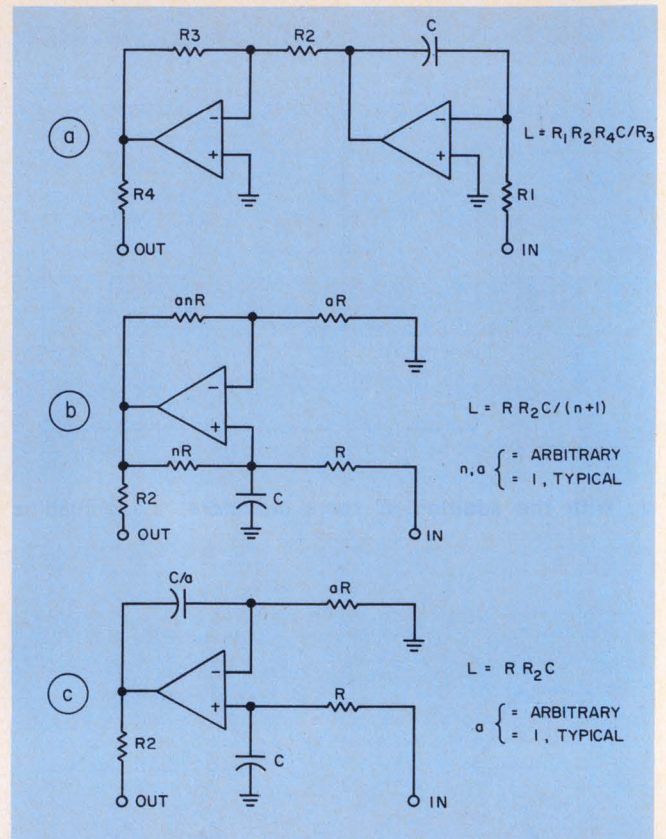

5. Active RC circuits can replace the inductor of Fig. 4d. But the circuits cannot replace all floating or grounded inductors. These impedance converters create an inductance from a capacitance.

Table. Biquad transfer functions for  $R_3 = R_4 = R_5$

$G(s) = - \left[ \frac{d s^2 - e \alpha_1 s + f \omega_c^2}{s^2 + 3K \alpha_1 s + \omega_c^2} \right] = \frac{N}{D}$				
Output option	Curve (Fig. 3)	Coefficients d e f	G (S) =	Notes
LP	a	0 0 1	$-\omega_c^2/D$	All Pole
BP	b	0 1 0	$s \alpha_1/D$	" "
HP	c	1 0 0	$-s^2/D$	" "
LP $\infty$	d	d 0 1	$-(ds^2 + \omega_c^2)/D$	$d = 1, \omega_\infty = \omega_c/\sqrt{d}, G(\infty) = d$
BR	e	1 0 1	$-(s^2 + \omega_c^2)/D$	$\omega_\infty = \omega_c, G(0) = G(\infty) = 1$
HP $\infty$	f	1 0 f	$-(s^2 + f \omega_c^2)/D$	$f = 1, \omega_\infty = \omega_c \sqrt{f}, G(0) = f$
AP	g	1 3K 1	$-(s^2 - 3K \alpha_1 s + \omega_c^2)/D$	Two-pole/phase shifter
"Q = $\infty$ "	h	0 e 0	$e \alpha_1 s / (s^2 + \omega_c^2)$	Resonator*, $Q = \infty = G(j\omega_c)K = 0$

\*Two biquads with  $K = 0$  can be used as the  $Q = \infty$  resonators in the biquartic. Such a biquad is unstable by itself—it's an oscillator.

and  $R/(1 - n) \Omega$ . The Thevenin equivalent becomes  $nE_{in}$  volts and  $R \Omega$ . Thus  $\alpha$  and transformed bandwidth are functions of  $n$ , while  $\omega_0$  is not.

Fig. 6c, a variation of 6b, has independent  $\omega_0$  and bandwidth controls. A biquartic using this circuit would contain five op amps per section—an input summer and two sections like Fig. 6c. The circuit of Fig. 6d uses the feedback null of a parallel T network to obtain an infinite  $Q$ .

A complete biquartic filter (Fig. 7) uses the L replacement circuits of Fig. 5a. Simultaneous Cauer bandpass and band-reject outputs can be obtained by placing another summing amplifier across  $R_7$ . By moving the arm of  $R_7$  to position A, you get a bandpass characteristic; by moving the arm down to point B, you can get a band-reject response. If zeros are not required,  $E_0 = E_3$  (or  $E_1$ ).

To tune the biquartic filter of either Fig. 2 or

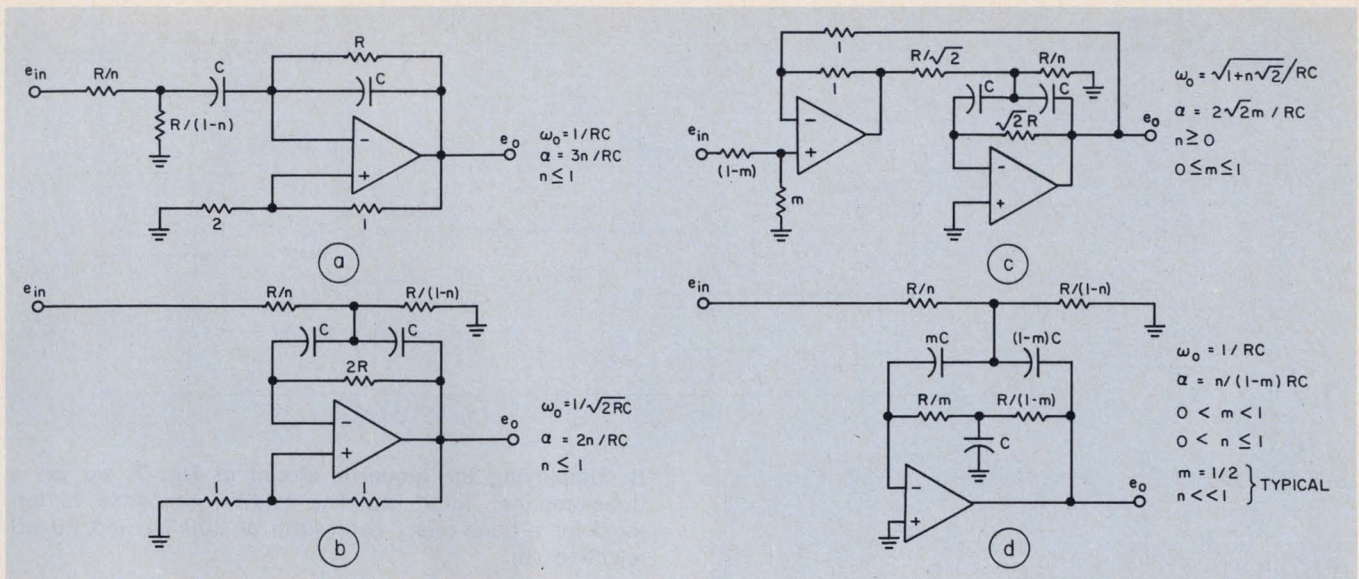

6. A Wein-bridge circuit with positive feedback (a) forces  $Q = \infty$ . The bridged-T circuit (b) also forces  $Q = \infty$ . A modified bridged-T circuit (c) allows  $\omega_0$  and BW to be

independently adjusted. The parallel-T circuit (d) creates a null in the feedback path to force  $Q$  to approach infinity.

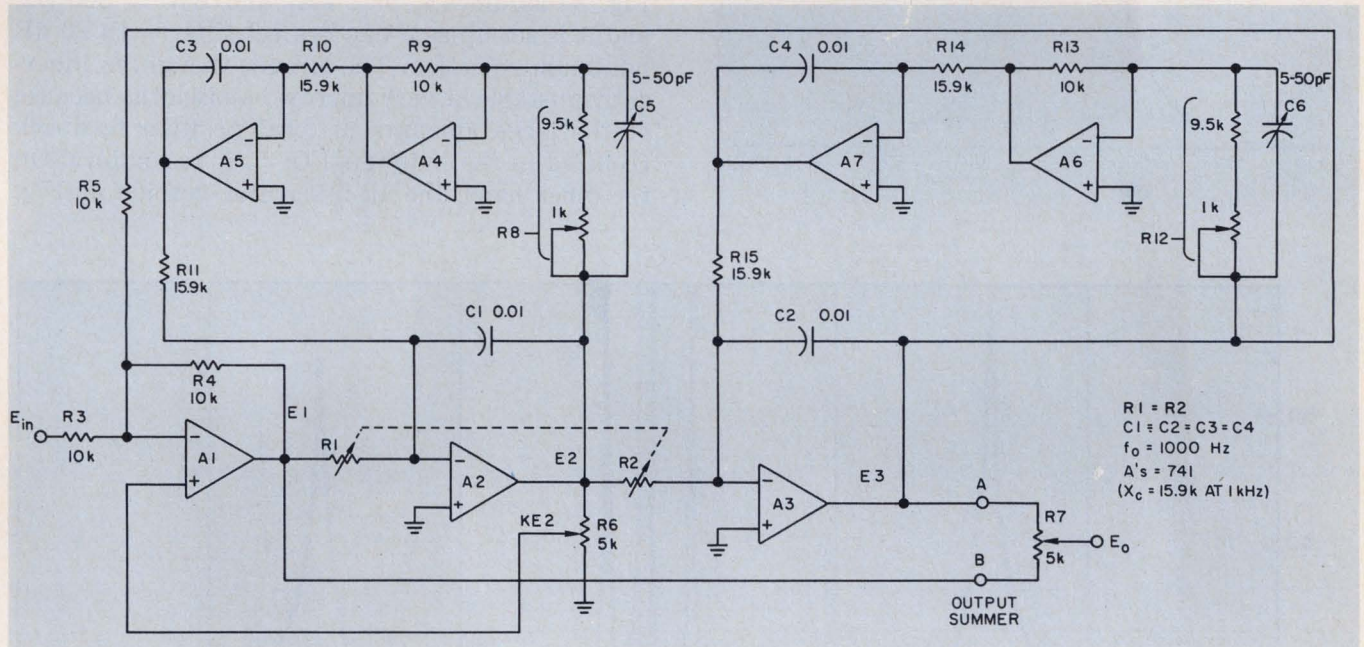

7. A working version of the biquartic filter can be built with the circuit shown here. Though it uses seven op

amps, it is very stable and can easily be adjusted for center frequency and bandpass.

7, feed in a convenient value of  $E_{in}$  at a center frequency of  $\omega_0$ . Detune the second integrator by temporarily connecting a 10-k $\Omega$  resistor across  $C_2$  to get a developed voltage at  $E_2$ . Now tune the first integrator for a complete null at  $E_1$  by adjusting its  $Q$  and resonant frequency. In Fig. 7 this is done by juggling the values of  $R_8$  and  $C_5$ .

able amounts of signals from  $E_1$  and  $E_3$  in the output summer; equal amounts yield the double-null network of Fig. 3e'. This response marks the transition between bandpass and band-reject. The value of  $KE_2$  adjusts the edge peaking at  $f_1$  and  $f_2$ , where  $f_{2,1} = [(BW/2)^2 + f_0^2]^{1/2} \pm (BW/2)$ . Thus  $f_1 f_2 = f_0^2$  and  $f_2 - f_1 = \text{bandwidth (BW)}$ .

Next, remove the detuning resistor from the second integrator and tune it for a complete null at  $E_2$ . The full output will still appear at  $E_3$ , even with  $\omega_0$  nulls at  $E_1$  and  $E_2$ , since  $\beta_1 \beta_2 = \infty$ . Adjust bandwidth by changing the integrator gains,  $R_1$  and  $R_2$ . Introduce or shift zeros by mixing vari-

A few of the measured response curves for the breadboard of Fig. 7 are shown in Fig. 9. This circuit has a bandwidth determined by  $BW = 1/2 \pi R_1 C_1$ ,  $R_{10} = 1/2 \pi f_0 C_3$ ,  $R_{11} = 1/2 \pi f_0 C_1$  and  $K = 1/(3Q_{LP})$ .

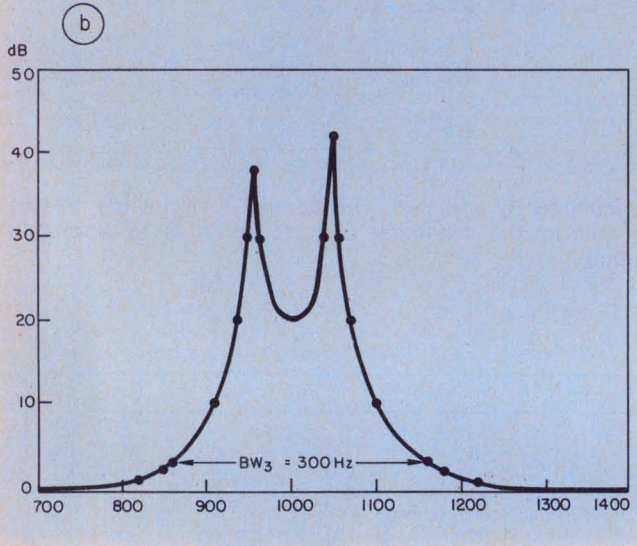
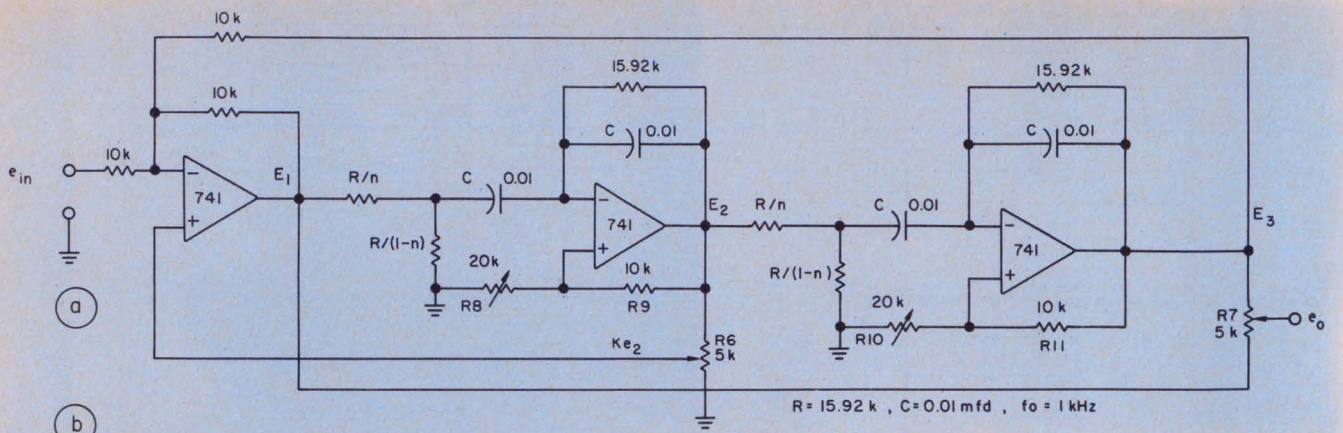

8. Simplifying the biquartic circuit of Fig. 7, we get a three-amplifier filter (a). The relative response is tailored for a band-reject bandwidth of 300 Hz and 20 dB rejection (b).

Fig. 8a shows a triple op-amp realization that uses the circuit of Fig. 6a. Any  $Q = \infty$  resonator will work in this versatile circuit. It has the value of  $n$  determined by  $BW/3f_0$ . The output curve in Fig. 8b assumes  $f_0 = 1$  kHz and  $BW = 300$ -Hz, and it is set up as a band-reject filter with 20 dB minimum rejection. The circuit, though, is inherently unstable at very narrow bandwidths because of the large amounts of local positive feedback required in the individual  $Q = \infty$  resonators. On the other hand, the all-integrator version of Fig.

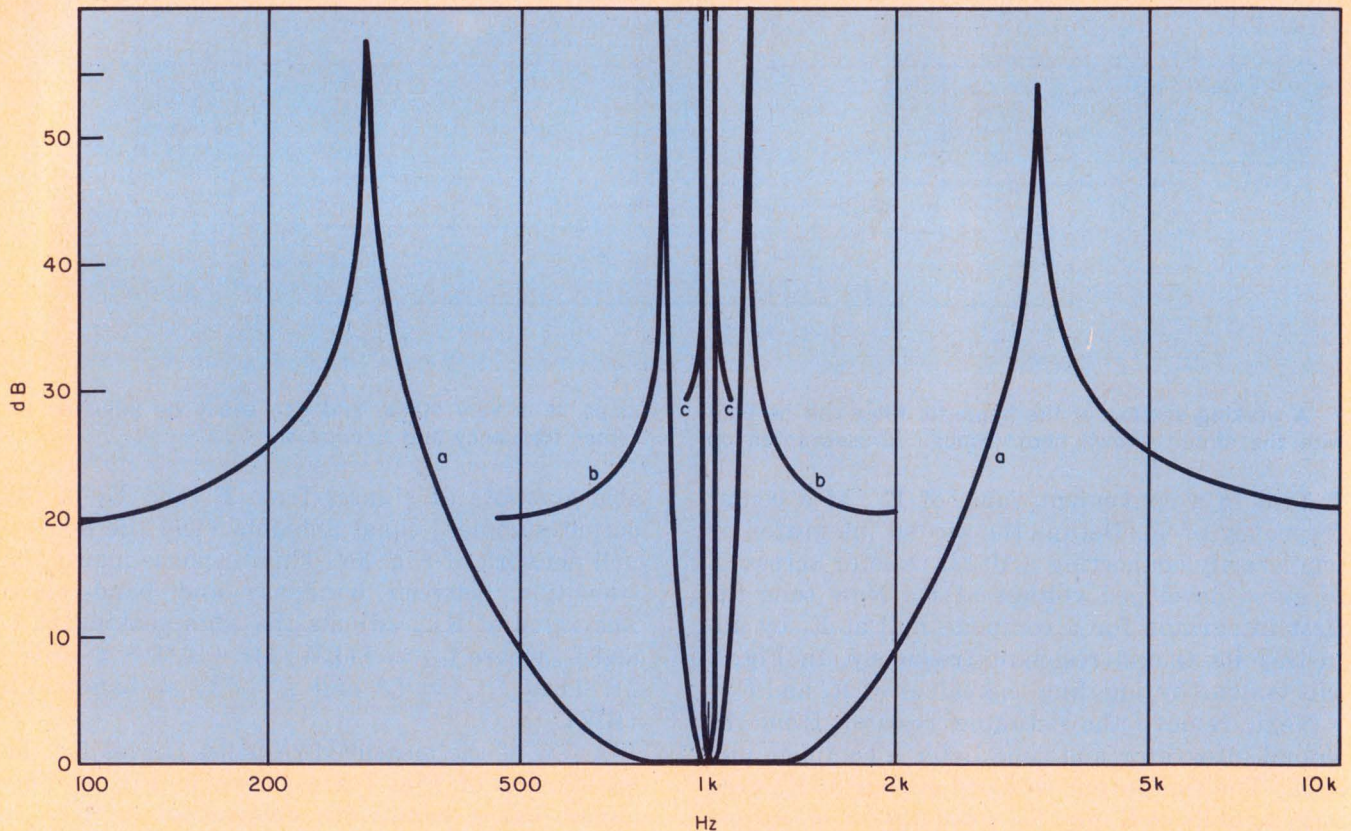

9. Three response curves for the circuit shown in Fig. 7 correspond to resistances  $R_1$  and  $R_2$  of 16 k $\Omega$  and a bandwidth of 1 kHz (a), 150 k $\Omega$  and 105 Hz (b), and 620 k $\Omega$  and 30 Hz (c).



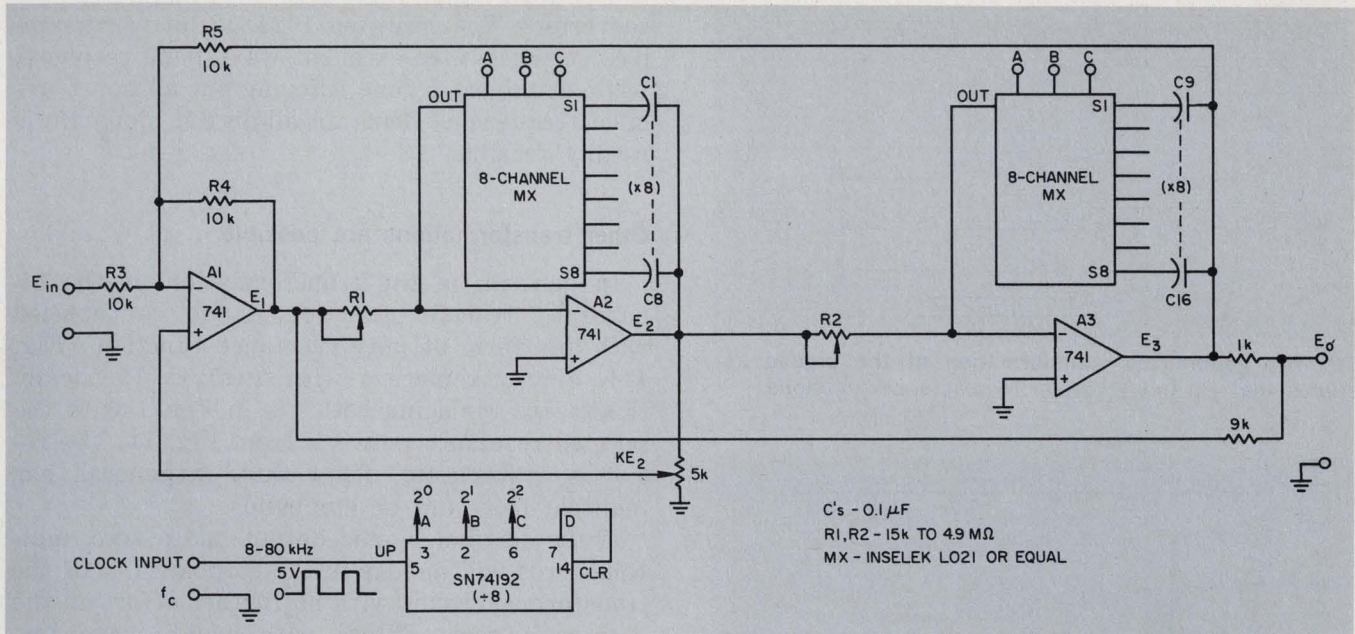

10. A quasi-digital version of the biquartic filter can be built if multiplexers are placed in the amplifier feed-

back loops. Unfortunately this quantizes the analog output and gives multiple passbands.

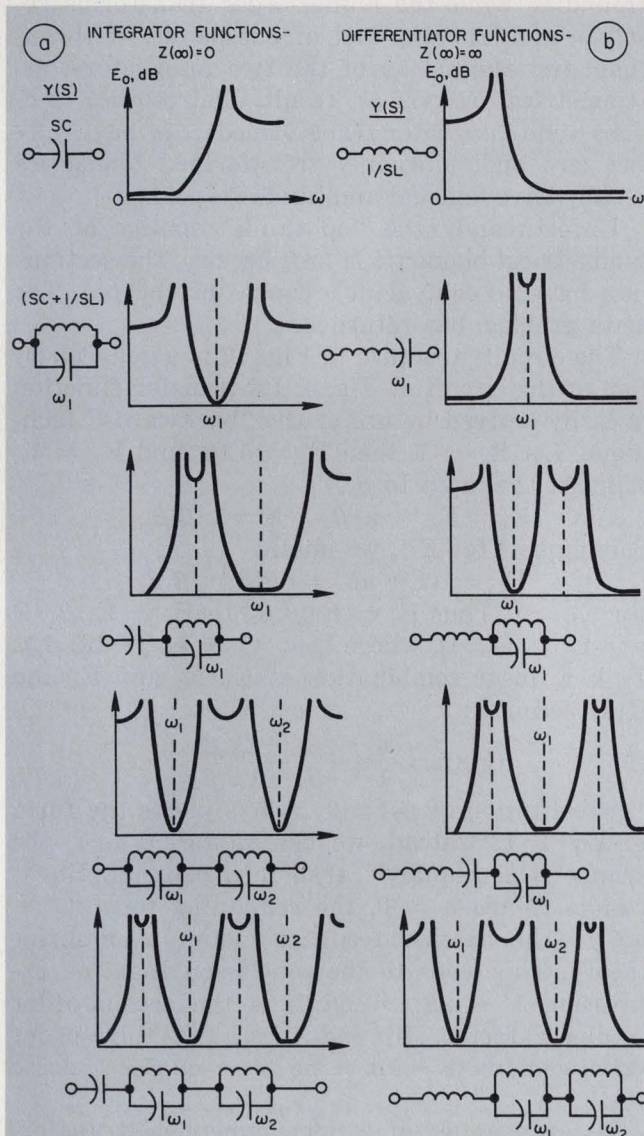

7 has an inherently high  $Q$ , so only a small amount of phase trim,  $C_5$  and  $C_6$ , yields  $Q = \infty$  with high stability at narrow bandwidths.

### Digitizing the filters

A variation of the biquartic filter is the quasi-digital, multiband "bi-n-tic" filter (Fig. 10). This unit doesn't depend upon positive feedback or component balance for  $Q = \infty$ . Its bandwidth can also be varied by duty-cycle switching integrator input resistors,  $R_1$  and  $R_2$ .

The fundamental center frequency of the filter is  $f_0 = f_c/n$  where  $f_c$  is the clock frequency and  $n$  the number of capacitors switched. The clock frequency thus directly determines the center frequency,  $f_0$ .

By sequential switching (multiplexing) of feedback capacitors  $C_1$  to  $C_8$  and  $C_9$  to  $C_{16}$  across high-slew-rate op amps  $A_2$  and  $A_3$  multiple band-pass integrators are formed. This, in turn, creates integrator poles at  $f = 0, f_0, 2f_0, 3f_0, \dots, mf_0$ . The result is a comb response with center frequencies at  $0, 2f_0, \dots, mf_0$ . Now the circuit can pass or reject nonsinusoidal waveforms on the basis of slight differences in period while still preserving the waveshape.

As an example, if  $E_{in} = E_s + E_t =$  a 60-Hz square wave + a 62-Hz triangle wave, let  $BW = 1$  Hz and  $f_0 = 60$  Hz. The outputs are  $E_3 = 60$ -Hz square wave and  $E_1 = 62$ -Hz triangle wave.

11. Pure  $n$ -order reactances and their corresponding "bi-2n-tic" response curves assume that  $E_o = dE_1 + E_3$  and  $0 < d < 1$ .

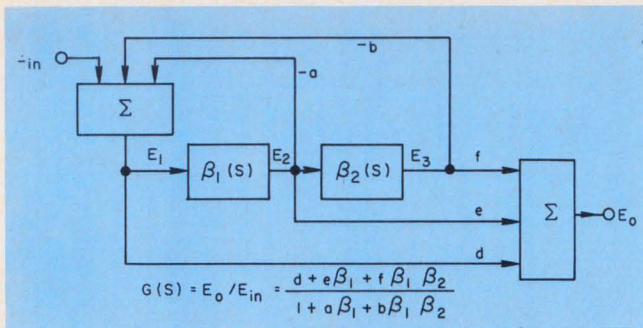

12. The generalized transformation of the biquad assumes that  $\beta_1$  and  $\beta_2$  are pure reactance functions.

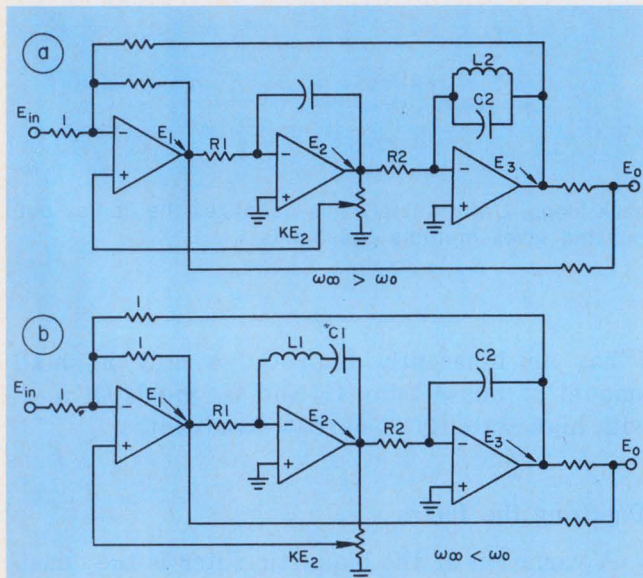

13. One-zero LC bicubes with  $\omega_0 < \omega_\infty$  (a) don't permit the integrators to be exchanged. But when  $\omega_\infty > \omega_0$  (b), the circuit is stable, since feedback is around only one differentiator.

The larger the value of  $n$ , the better the approximation. With  $R_1 = R_2 = 15 \text{ k}\Omega$  and  $C = 0.1 \mu\text{F}$ , the bandwidth measured is 30 Hz at a  $f_0$  of 1 kHz. In this case the zeros are present but are slightly masked by the switching steps. With increases in  $R_1$  and  $R_2$  to 470 k $\Omega$ , bandwidth decreases to 1 Hz. At an  $f_0$  of 10 kHz, this represents a bandwidth ratio of 0.01%—which rivals crystal filters in performance.

Increasing the  $R$ 's by another order of magnitude reduces the bandwidth ratio to 0.001%. At this point the circuit is still functional, but multiplexer imperfections distort the output waveforms. Although the output waveform is a quantized  $n$ -step approximation of the input waveform, the sum of  $E_1$  and  $E_3$  still results in two signal-frequency zeros. For narrow bandwidths ( $R$  large), beats between  $E_{in}$  and clock-related frequencies appear at  $E_0$ .

A one-pole digital version can be constructed using 12, 1 k-bit shift registers as storage elements (integrators), interfaced with  $a/d$  and  $d/a$

converters. The resulting 1024, 12-bit word samples per cycle give excellent waveshape response, while at the same time filtering out all non- $f_0$  related frequencies. Thus an all-digital biquartic is readily feasible.

### Other transformations are possible

In general, in the transformation of the bi-quadratic transfer function,  $s$  can be replaced with any form of pure reactance function (Fig. 11). Simply replace  $s$  with  $Y(s)/C$ . Physically this means replacing both  $C$ 's in Fig. 1 with the selected reactance network from Fig. 11. The result is a "bi-2n-tic" filter that, in general, has multiple pass/and/or stopbands.

If the original biquad output had a zero, multiple zeros will appear in the stopband(s) of the transformed circuit with no further effort on the designer's part. Filters with square-wave frequency response are possible.

So far both integrators in the biquad have been transformed equally with the same transformation. Thus the biquartic is always symmetrical around  $\omega_0$  while the higher-order transforms result in multiple stop and/or passbands. With unequal transformation of the two integrators, asymmetrical responses result. Third-order sections (one integrator transformed) can have only one zero and, unequally transformed biquartics usually have unequal amplitude responses.

Unfortunately the "no think" quality of the symmetrical biquartic is lost, because the sections now have no equivalent low-pass prototypes. The math problem has returned.

The circuit structure in Fig. 12 is a generalization of the circuit of Fig. 1. Its transfer function is easily derived by use of the "backwards" technique. Let  $E_3 = 1$ , then  $E_2 = 1/\beta_2$  and  $E_1 = 1/\beta_1\beta_2$ . At the input to  $\beta_1$ ,

$$E_1 = E_{in} - a/\beta_2 - b = 1/\beta_1\beta_2.$$

Solving this for  $E_{in}$ , we obtain

$$E_{in} = (1 + a\beta_1 + b\beta_1\beta_2) / \beta_1\beta_2$$

for  $E_3 = 1$ . Thus  $E_3 = E_{in}\beta_1\beta_2/D$ ,  $E_2 = E_{in}\beta_1/D$  and  $E_1 = E_{in}/D$ , where  $D = (1 + a\beta_1 + b\beta_2\beta_1)$ .  $E_0$  is a linear combination of  $E_1$ ,  $E_2$  and  $E_3$  and  $G(s)$  becomes:

$$G(s) = \frac{d + e\beta_1 + f\beta_1\beta_2}{1 + a\beta_1 + b\beta_1\beta_2}.$$

Substitution of  $\beta_1 = \beta_2 = \alpha/s$  yields the form of Eq. 1. If instead, we use  $\alpha s/(s^2 + \omega_0^2)$ , the symmetrical biquartic transformation of Eq. 1 results. When  $b = 0$ , the remaining term  $(1 + a\beta_1)$  is the classical feedback factor in amplifier theory. This leads to the conclusion that the expression  $1 + a\beta_1 + b\beta_1\beta_2$  is the second-order feedback factor. By induction, the third-order term would be  $1 + a\beta_1 + b\beta_1\beta_2 + c\beta_1\beta_2\beta_3$ , and so forth.

As an example of a nonsymmetrical transfor-

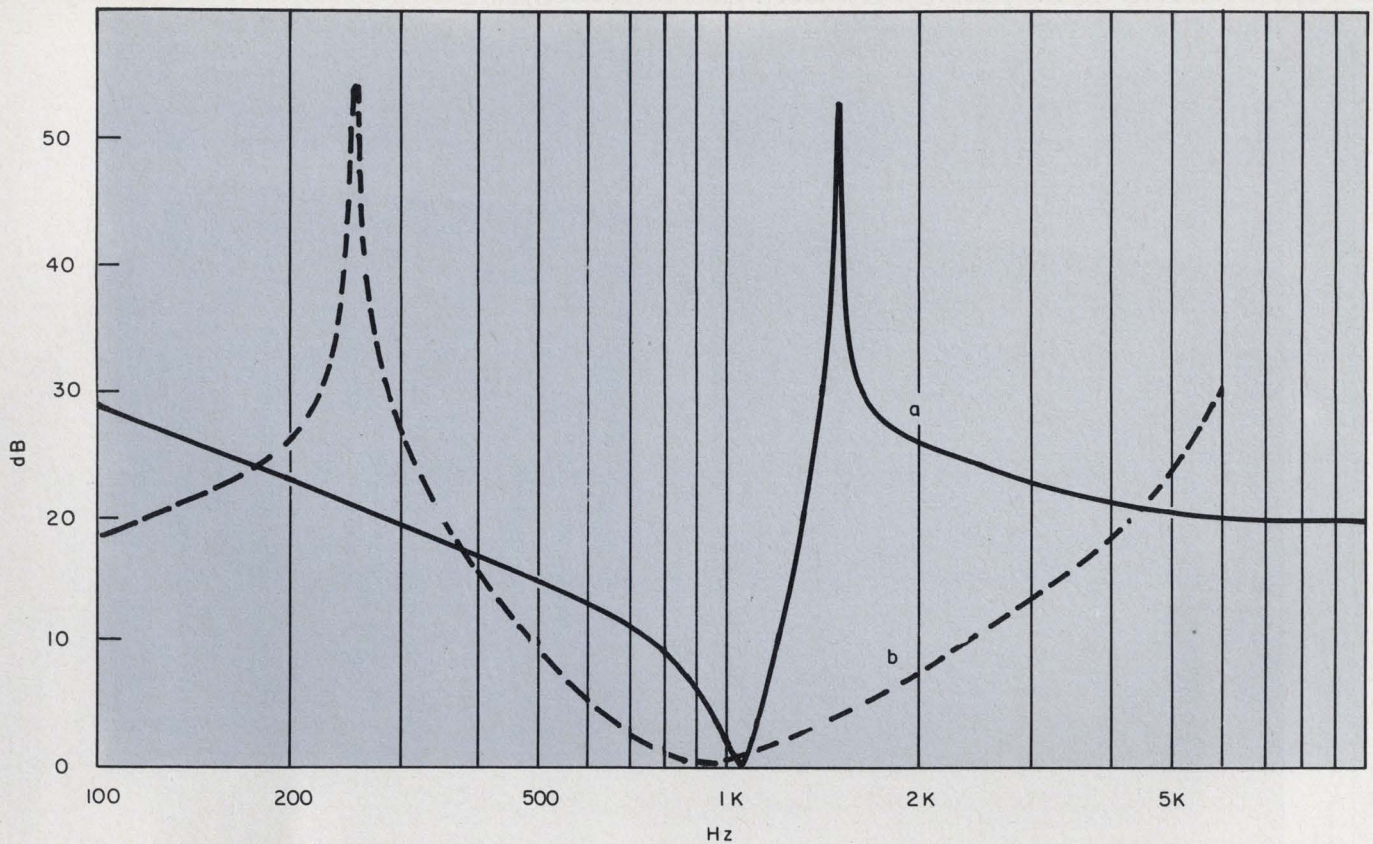

14. Response curves of the bicube circuits show a high-side zero (a) and a low-side zero (b). For both  $BW_1 \neq BW_2$ .

mation, let  $\beta_1 = \alpha_1/s$ ,  $\beta_2 = \alpha_2 s/(s^2 + \omega_0^2)$ ,  $e = 0$  and  $f = 1$ . This corresponds to the bicube circuit of Fig. 13a, except for the sign of the  $E_2$  feedback. Making these substitutions and clearing the result, we get the following:

$$G(s) = \frac{s[ds^2 + (d\omega_0^2 + \alpha_1\alpha_2)]}{s^3 + s^2 a\alpha_1 + s(\omega_0^2 + b\alpha_1\alpha_2) + a\alpha_1\omega_0^2}$$

The resulting circuit has zeros at  $s = 0$  and  $s = \pm j(\omega_0^2 + \alpha_1\alpha_2/d)^{1/2}$ . Thus the circuit has one real frequency zero and  $G(\infty) = d$ . The zero must lie above  $\omega_0$ , since  $\beta_1$  and  $\beta_2$  must be of the same sign for it to occur at all and the terms  $d$  and  $f$  also must be of the same sign. ( $\beta_2$  must be capacitive like  $\beta_1$ .)

Fig. 14a shows the measured response of an RC version of Fig. 13a. In practice this circuit will not work if  $\beta_1$  and  $\beta_2$  are interchanged, since the dc bias for the second integrator would be ambiguous.

A low-side-zero bicube is shown in Fig. 13b. Here  $\beta_1 = (s^2 + \omega_0^2)/\alpha_1 s$ ,  $\beta_2 = \alpha_2/s$ ,  $d = 1$  and  $e = 0$ . If we substitute in these terms and clear the fraction,  $G(s)$  becomes

$$G(s) = \frac{s^2(\alpha_1 + f\alpha_2) + f\alpha_2\omega_0^2}{as^3 + s^2(\alpha_1 + b\alpha_2) + s(a\omega_0^2) + b\alpha_2\omega_0^2}$$

For this circuit, zeros occur at  $s = \infty$  and  $s = \pm j\omega_0[f\alpha_2/(\alpha_1 + f\alpha_2)]^{1/2}$  while  $G(0) = f/b$ . The measured response of this circuit is shown in Fig. 14b. This circuit is less stable than that of Fig. 13a because of the bandpass differentiator circuit located in the  $\beta_1$  block of Fig. 12.

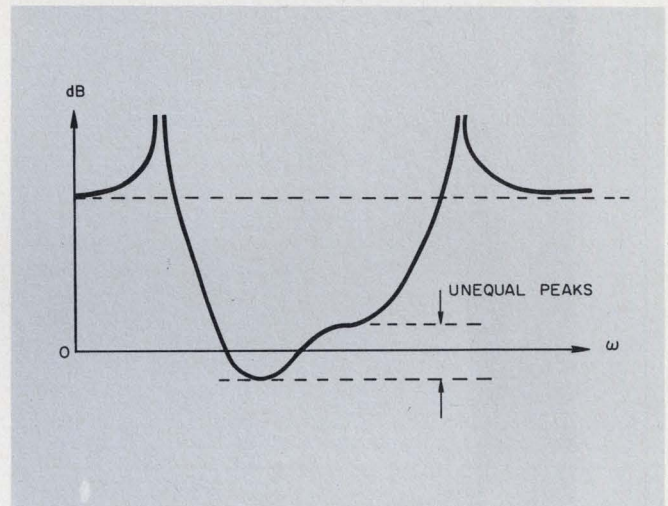

15. Typical response curve of an asymmetrically tuned biquartic.

To generate an asymmetrical biquartic transfer function, let  $\beta_1 = \alpha_1 s/(s^2 + \omega_1^2)$  and  $\beta_2 = \alpha_2 s/(s^2 + \omega_2^2)$ . This results in the asymmetrical response curve in Fig. 15. Zeros are symmetrically located around  $\omega = (\omega_1\omega_2)^{1/2}$ . For flat frequency response several of these sections may have to be cascaded. The differentiator functions of Fig. 11b (output at  $E_3$ ) are all duplicated by the more stable integrator functions in the circuit of Fig. 11a with an output at  $E_1$ . ■■

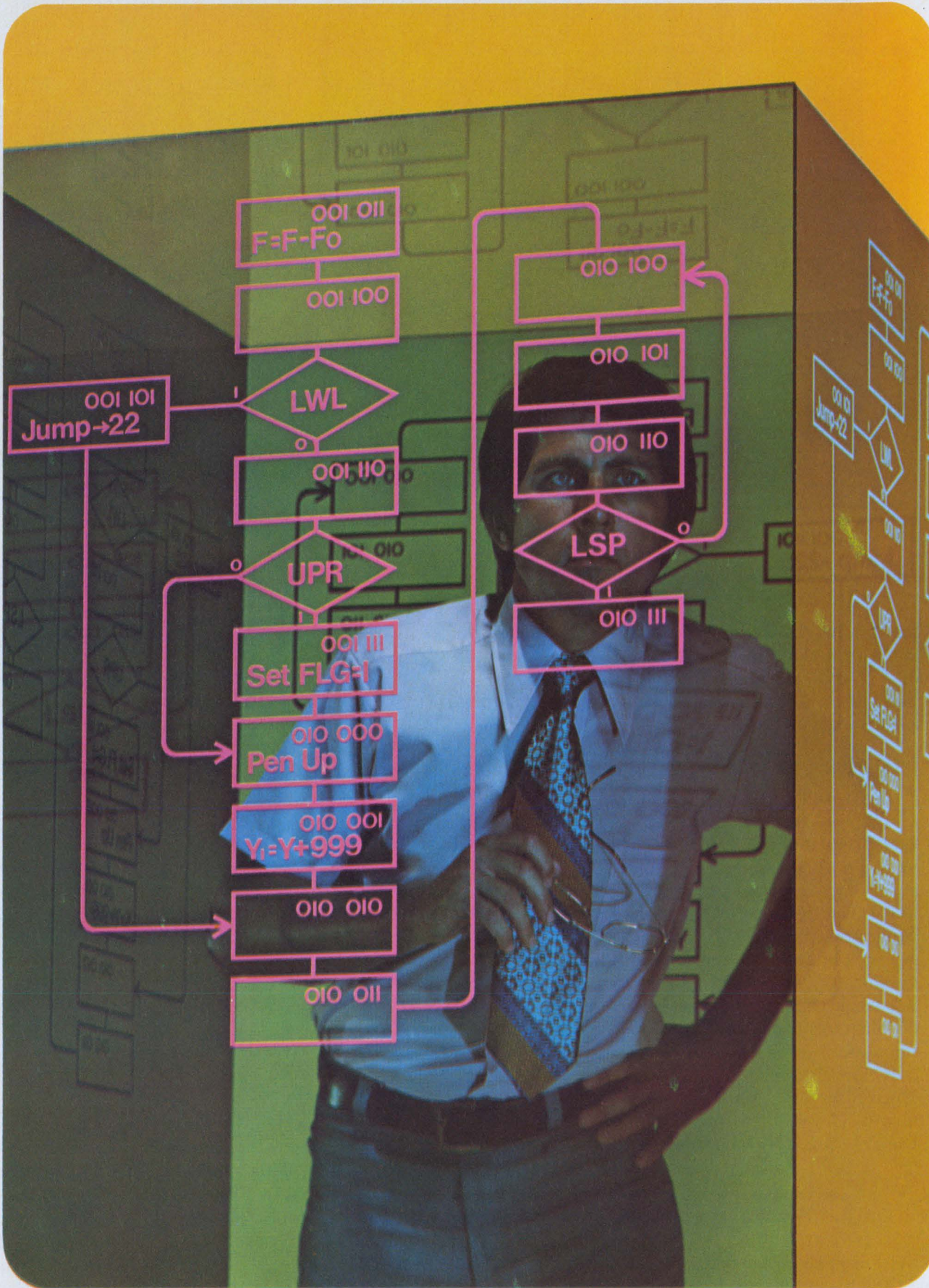

**Now — Put Yourself Inside Your Designs.  
See Your Logic Programs In Action.  
See Negative Time.**

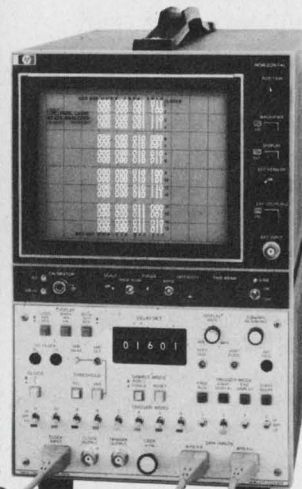
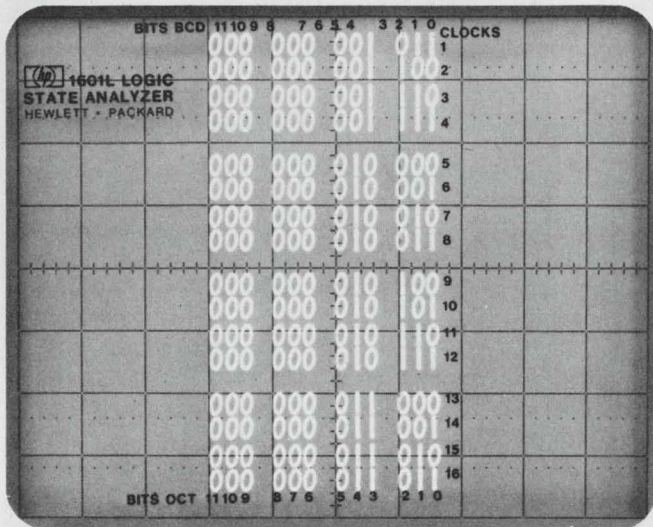

**Breakthrough...  
The HP 1601L  
Logic Analyzer...**



Here's a functional tester that can make a world of difference in helping you solve your digital design or test problems. With HP's 1601L you actually see each word displayed in "1's" and "0's", as shown here. Sixteen words at a time, each twelve bits wide.

**Now see what's really happening.** See each sequential step of your design, or of the equipment you're analyzing for problems. Display your digital words in "1's" and "0's," in hexadecimal, BCD or octal format. Select positive or negative logic corresponding to the type of circuitry you're working with, and adjust threshold over the  $\pm 10V$  range provided. Think of all the time you'll save in design and troubleshooting.

**See your logic in action.** "Step inside" your design and watch it pace through its sequences. If a "glitch" should occur, end your display and look back in time to see what events lead up to the problem. Diagnostics couldn't be easier.

**See dynamic data flow, negative time, much more.** The 1601L displays an action portrait. Dynamically timed by your strobe signal (up to 10 MHz), you can

delay the start of display up to  $10^5$  bits and really track your system's performance. If a problem develops, look back from the problem word (negative time) at least 15 words. Your oscilloscope will help you find the component or circuit at fault; the 1601L provides a trigger for your scope making fault isolation even easier.

**See things you've never seen before.** See those digital events you've always wanted to see. For all this capability the 1601L is priced at only \$2650\*. Or, consider the 5000A, a unit with LED display, two channels, thirty-two bits. It sells for only \$1900\*. Your local HP field engineer will be happy to arrange a "hands-on" demonstration in your office or lab.

\*Domestic U.S. prices only.



Sales, service and support in 172 centers in 65 countries.  
Palo Alto, California 94303. Offices in principal cities throughout the U.S.

083/8

# Slash power converter design time

and get optimum performance, too. Here are component specification tables and a step-by-step technique.

Nearly every engineer can, by plodding effort, design a power converter. But most take much too long to do the job. On top of that, most don't get the desired performance from the circuit when the design is completed, because they almost never choose the optimum core size and material for the transformer or the transistor with the right ratings.

You can cut converter design time by 75% and get an optimum design. Here's how: Check the guidelines for transistor selection. Consult the three tables given here for core parameters. Follow a step-by-step design procedure.

To see why transformer design is so crucial in determining converter performance, let's first analyze the operation of a typical converter.

## How a converter works

A converter is basically a magnetically coupled multivibrator. While there are many useful converter circuits—for example, circuits that use a single transistor and transformer, and others that have two transistors and two transformers—the two-transistor, single-transformer circuit (Fig. 1) is widely considered the most practical and trouble-free.

The transistors in the circuit of Fig. 1 operate as switches. Their function is much the same as the contacts in a mechanical vibrator. The feedback windings,  $N_f$ , supply the switching energy to the transistor bases. The transformer core is used fully—the flux is driven, on alternate half cycles, to positive and negative saturation. This induces a square wave voltage in the secondary windings (Fig. 2).

The inductive kickback, caused by transistor turnoff, produces a voltage spike at the leading edges of the output pulses. While these spikes are useful for aiding transistor turn-on, they may damage transistors if they are too high. For this reason, magnetic materials with a rectangular hysteresis loop should be used. With these cores, windings exhibit low inductance at

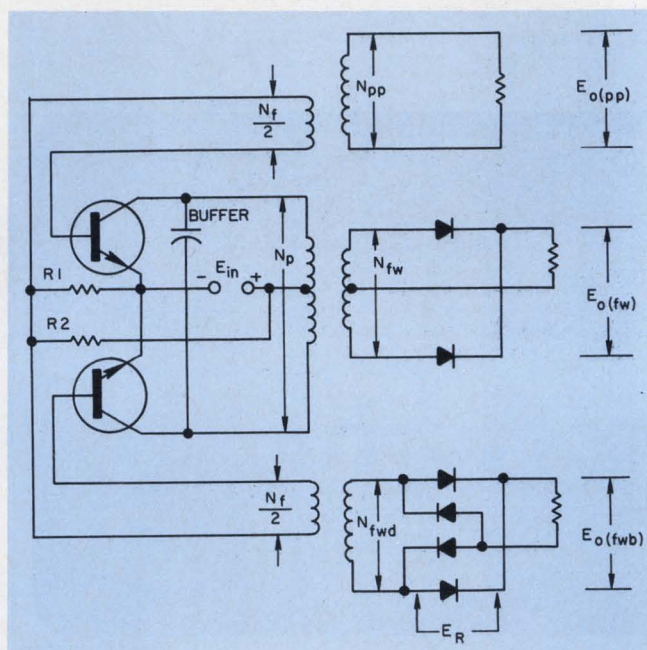

1. A practical converter circuit can be used to obtain a variety of outputs—ac (square wave), full wave and a full wave obtained from a bridge.

saturation, thus limiting spike amplitude.

If the supply voltage is kept constant, output regulation depends on the transformer construction. Low leakage inductance, for instance, results from good coupling between primary, secondary and core. Long winding lengths (360° arc for winding vs 90° arc) and small mean turn length about the core also contribute to low leakage inductance. Wire with a large cross-section (to minimize  $I^2R$  losses) also helps regulation. If the windings and the load are kept constant, the output voltage varies linearly with the supply voltage. The output voltage should not vary more than 5% from no load to full load with a well-built transformer. Better regulation can be achieved by regulation of the converter input or output, or both.

The circuit of Fig. 1 has built-in short-circuit protection. During a secondary short, a current equal to the instantaneous core saturation collector current flows in the primary. But because of the limiting resistor, saturation cannot be maintained, and the conducting transistor

David M. Lisbin, Engineering Consultant, Fairfield, Conn.

moves out of saturation. The primary impedance remains low because of the short, so the second transistor cannot maintain saturation either. Therefore the circuit stops oscillating. Since all voltages drop to zero, no damage occurs; the circuit works normally again after the short is removed.

### Select the right transistor

Price considerations aside, the following major electrical characteristics must be examined when

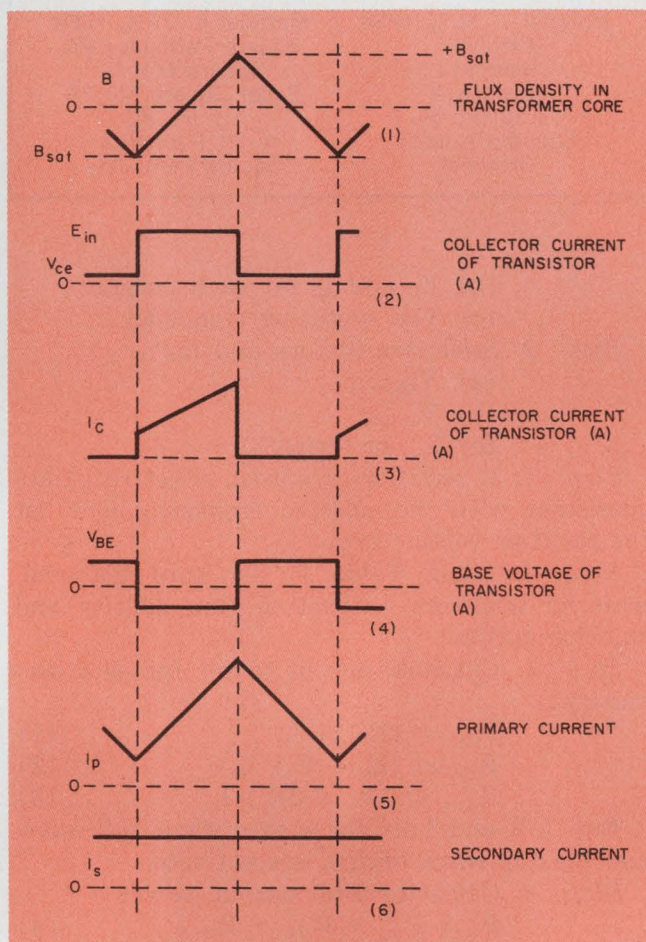

2. Understanding the various waveshapes that occur within a converter is crucial to building a reliable circuit.

transistors are selected for a converter:

- Voltage rating.
- Power rating.
- Cutoff frequency.
- Efficiency.

The maximum voltage rating of each transistor should be at least twice the supply voltage. When one transistor is on, the other (off) transistor must block the full supply voltage plus the induced supply voltage in the primary winding and the transient spike. The latter may be as high as the supply voltage when the converter is loaded lightly. If the converter is expected to

operate unloaded, a buffer capacitor should be added (Fig. 1).

Most power transistors can safely switch powers equal to eight times their class-A power rating. For example, a transistor rated at 2 W for class-A operation, will safely switch 16 W, or 32 W for a pair. Thus if a system is 80% efficient, the converter will output 25.6 W.

The cutoff frequency of the transistors must be at least five to 10 times the selected operating frequency. Excessive junction heating will occur if the transistor cannot switch fast enough. The higher the cutoff frequency of the transistor, compared with the converter operating frequency, the more nearly square will be the waveform obtained at the output.

To achieve maximum converter efficiency under load, the transistors should switch the highest voltage possible. Indeed, regardless of the supply voltage, the permissible junction heating determines the maximum collector current that can be switched. And with collector current fixed, power output will increase proportionally with the supply voltage. It can be reasonably assumed that core, copper and transistor losses are constant, so that converter efficiency will increase with an increase in supply voltage.

Transistors with high current gain should be used, since the feedback power to the bases must be supplied through the primary windings. It is also necessary to provide current limiting to the bases ( $R_1$  in Fig. 1), but the  $I^2R$  losses in this resistance should be kept small for better efficiency. The ratio of primary to feedback turns should be as high as possible, yet the feedback turns must be adequate to provide sufficient voltage and current to saturate the transistors at high collector currents.

### Choosing magnetic materials and core shapes

The great majority of converter needs can be satisfied by use of one of the two magnetic materials in Table 1. The 50% NiFe has high maximum flux density with relatively low losses. The 79% NiFe has about half the maximum flux density of the 50% NiFe, with one-tenth the losses.

In most applications the choice is obviously the 50% NiFe. By use of the material that allows higher flux density, less iron and copper are required. This leads to a small size that is consistent with high efficiency.

The efficiency is high because the core losses are small compared with the output power. High efficiencies can be attained up to the high audio frequencies. This is because core size is reduced as frequency is increased, so that core losses are offset by the reduction in core volume with the increased frequency.

If you're designing low-power converters and you need high efficiencies under light load, consider the 79% NiFe. Such converters are usually portable, driven by battery, and high efficiency is needed to conserve battery power. For these applications, low core losses are essential, and this outweighs the fact that the core operates at a lower flux density.

Boxed, tape-wound, toroid cores are selected for most standard designs because a transformer built in this form has good coupling, owing to the closed, gapless shape.

Strip thickness is an important consideration in selecting cores. Eddy-current losses in the core can be reduced at higher frequencies by use of thinner strip stock. Since the strip is coated, or "boxed," with insulating material, a stack of extremely thin material contains a smaller percentage of iron than does the same sized stack of thicker material. To compute the effective cross-section of the magnetic material in the stack multiply the cross-section of the insulated stack by a stacking factor (Table 1).

Vendor core tables (Table 2) may list the *gross cross-section* of the core. This is the strip width multiplied by the stack height and is the *gross area* that the insulated strip material occupies in the core box. The core box protects the strips from mechanical shock and also provides insulation between the strips and the windings. The *gross cross-sectional area* must be multiplied by the *stacking factor* to get the core's *effective cross-sectional area* ( $A_c$ ), which is used in magnetic calculations. Sometimes the core vendor will list cores by *effective cross-section* of a particular strip thickness—say, 0.002 in. In this case the designer must calculate the effective area of the particular strip thickness he needs by multiplying the effective cross-section given in the table by the ratio of the strip thickness stacking factors. For example, if  $A_c$  is given for a 0.002-in. strip (stacking factor 0.85) and for a 0.004-in. strip (stacking factor 0.9), then

$$A_{c(0.004 \text{ in.})} = A_{c(0.002 \text{ in.})} \times (0.9/0.85).$$

The core box adds thickness to the strips it contains. Then a core window ( $W$ ) refers to a hole that is smaller in diameter than the actual strip material by two core box thicknesses. Generalized guidelines for transformer construction are listed in Table 3.

### The generalized converter design procedure

With the transistor and core parameters selected, we can now proceed with the detailed converter design. Throughout the design procedure Fig. 1 is used as the circuit reference, and the steps are as follows:

**Step 1.** List:

- (a)  $E_{in}$ , the dc supply voltage.

**Table 1. Core materials**

Frequency range (Hz)	Mat'l code	Mat'l thickness (thous)	$B_{max}$ (gauss) ( $\times 10^3$ )	Stacking factor	Core loss (watts/pound)
25 - 60	1	0.004	15.0	0.90	0.3
61 - 400	1	0.004	15.0	0.90	2.5
401 - 1000	1	0.002	15.0	0.85	6.0
1001 - 5000	1	0.001	15.0	0.75	50
5001 - 20,000	2	0.001	7.5	0.75	45
20,000 - 50,000	2	0.0005	7.5	0.5	100

Material 1- 50% NiFe Orthonik Deltamax Hipernik V 49 Square Mu Square Orthonol Orthonol	Material 2- 79% NiFe Square Permalloy 80 Square Mu 79 Super Square Mu 79 Hy Ra 80 4-79 Permalloy Square Permalloy
---	---

(b)  $E_o$  and  $I_o$  for each output.

(c) The operating frequency.

**Step 2.** Select transistors and list:

(a)  $V_{BE(sat)}$ .

(b)  $V_{B(BEO)}$ .

(c)  $h_{fe}$ , or "beta."

**Step 3.** If rectifiers are used, select rectifiers consistent with the selected frequency and list the rectifier voltage drop,  $E_r$ .

**Step 4.** Using Table 1, list core material, material thickness, saturating flux density and stacking factor.

**Step 5.** Calculate output power for each secondary:

$$P_{opp} = (E_o/2) I_o, \quad (1)$$

$$P_{ofw} = (E_o + E_r) I_o, \quad (2)$$

$$P_{ofwb} = (E_o + 2E_r) I_o. \quad (3)$$

Eqs. 1, 2, and 3 are for square wave, full wave, and the full-wave bridge, respectively.

**Step 6.** Calculate total output power:

$$P_o = P_{opp} + P_{ofw} + P_{ofwb}. \quad (4)$$

**Step 7.** Calculate input power at 80% efficiency:

$$P_{in} = P_o/\text{Eff.} = P_o/0.8. \quad (5)$$

**Step 8.** Calculate input current:

$$I_{in} = P_{in}/E_{in}. \quad (6)$$

**Step 9.** Since each half of the primary works at a 50% duty cycle (at each alternate switching of the transistors), select the primary wire size rated for one-half of the input current given in Eq. 6:

$$\text{Primary copper wire area } A_p = (I_{in}/2) (1000) = \text{circular mils at } 1000 \text{ cm/A.} \quad (7)$$

Wire size can be selected from Table 4 to within  $\pm 5\%$  of the value computed in Eq. 7. If no such size exists, take the next larger wire size. List:

- (a) Wire size (AWG). (8)



**Table 2. Representative core specifications**

WA <sub>c</sub> for 0.002" strip (× 10 <sup>6</sup> )	W Box area circular mils (× 10 <sup>6</sup> )	A <sub>c</sub> for 0.002" strip (cm <sup>2</sup> )	Gross core cross section (cm <sup>2</sup> )	Core weight (lb × 10 <sup>-2</sup> )	Core dimensions (in.)			Boxed core dimensions (in.)			Manufacturers part no.	
					ID	OD	HT	ID	OD	HT	Magnetics Inc	Arnold Eng Co.
0.030	0.348	0.086	0.101	1.13	0.650	0.90	0.125	0.575	0.975	0.220	50002	5515
0.059	0.308	0.193	0.227	2.64	0.625	1.00	0.188	0.540	1.085	0.280	50076	5958
0.074	0.865	0.086	0.101	1.64	1.00	1.25	0.125	0.915	1.335	0.220	50011	4168
0.079	0.462	0.171	0.201	2.56	0.75	1.00	0.250	0.670	1.080	0.345	50061	5502
0.079	0.308	0.257	0.302	3.57	0.625	1.00	0.250	0.540	1.085	0.345	50007	5651
0.089	0.462	0.193	0.227	3.09	0.75	1.125	0.188	0.670	1.205	0.280	50106	5504
0.470	1.369	0.343	0.403	8.78	1.25	1.75	0.250	1.160	1.840	0.350	50030	5387
0.593	0.865	0.686	0.807	14.63	1.00	1.50	0.500	0.915	1.585	0.605	50038	6847
2.687	1.960	1.371	1.613	46.8	1.50	2.50	0.500	1.380	2.610	0.620	50001	5320
4.949	3.610	1.371	1.613	58.5	2.00	3.00	0.500	1.880	3.120	0.625	50103	6110
14.670	5.350	2.742	3.226	140.4	2.50	3.50	1.000	2.380	3.620	1.135	50042	5468
99.665	14.54	6.855	8.064	541.2	4.00	5.25	2.000	3.835	5.415	2.205	50112	5611
159.4	14.53	10.97	12.9	936.2	4.00	6.00	2.000	3.825	6.175	2.205	50426	9260

When ordering cores, identify manufacturers part number and list material and strip thickness.

- (b) Wire area (cm, copper only). (9)
- (c) Wire area (A<sub>w</sub>), including insulation. (10)
- (d) Resistance (ohms per 1000 feet). (11)

For effective winding of wire, the area of all the wire should occupy no more than 40% of the toroid's window area. The total primary should occupy no more than one-half of this total area, or 20% of the window.

Step 10. Write the equation for the total effective core area, A<sub>c</sub>, given by

$$A_c = (2E_{in} \times 10^8) / (4B_{max} N_p f), \quad (12)$$

where N<sub>p</sub> = total primary turns

f = frequency

B<sub>max</sub> = saturation flux density.

Step 11. The theoretical maximum number of turns, N, of wire with an over-all circular mil area of A<sub>w</sub> that can be placed in the window of a toroid core of W (circular mil) area is given by:

$$N = W / A_w. \quad (13)$$

Since the total primary can occupy only a fraction of the window, then

$$W = N_p A_w / K. \quad (14)$$

Combining Eqs. 12 and 14, we get

$$WA_c = (A_w E_{in} \times 10^8) / (2B_{max} f K). \quad (15)$$

From the core table (Table 2) select a core with a corrected (for stacking factor) WA<sub>c</sub> product that is slightly larger than the calculated value in Eq. 15. Record the effective A<sub>c</sub> in cm<sup>2</sup> for the selected core.

Step 12. Calculate the total number of primary turns for the selected core from the rearrangement of Eq. 12:

$$N_p = (E_{in} \times 10^8) / (2B_{max} A_c f). \quad (16)$$

If N<sub>p</sub> is an odd whole number, adjust it to the next highest even whole number. The whole even

**Table 3. Transformer terminology & building rules**

Some general rules for winding:

- a—Windings with heaviest current to be closest to the core.
- b—For best coupling, primary and secondary should be distributed about at least a 270° arc of the core and should be physically on top of one another.
- c—Primary should be bifilar wound.
- d—Feedback winding should be bifilar wound and may be placed on top of all windings centered on 270° arc occupying about a 60° arc, or may be wound in the 90° space left by other windings.
- e—Use core box with at least 500 volt insulation.
- f—Insulate with suitable tape for at least 3 times the potential difference between windings.
- g—Use heavy film wire (500-V insulation min).
- h—The diagram shows the common terminology associated with strip-wound boxed cores.

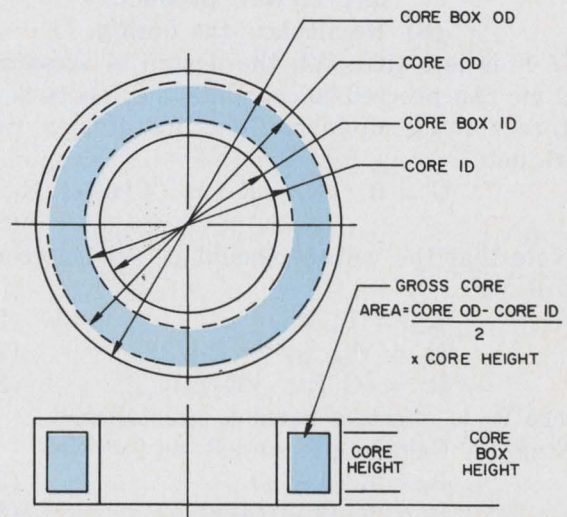

number computed in Eq. 16 is divided by two to give the turns for half of the primary.

*Step 13.* The induced retrace voltage,  $E_{fb}$ , in the feedback winding must be less than the sum of  $V_{B(sat)}$ , positive-direction clamp, and the transistor's  $V_{B(bo)}$ :

$$E_{fb} = (V_{BE(sat)} + V_{B(bo)}) - 1.0. \quad (17)$$

*Step 14.* Calculate total number of feedback turns,  $N_f$ , as follows

$$N_f = (E_{fb} N_p) / (2E_{in}). \quad (18)$$

If calculated number  $N_f$  is a whole even number or within  $\pm 5\%$  of a whole even number, set  $N_f$  equal to this number. If not, adjust  $N_f$  to next larger whole number. This adjusted  $N_f$  value divided by two is then the number of turns on each feedback winding.

*Step 15.* Calculate turns for each secondary ac winding (refer to Fig. 1 for notation) by:

$$N_{pp} = (N_p E_o) / (4E_{in}). \quad (19)$$

Calculate total turns for each full-wave winding:

$$N_{fw} = [N_p (E_o + E_r)] / E_{in}. \quad (20)$$

Calculate turns for each full-wave bridge winding:

$$N_{fwb} = [N_p (E_o + 2E_r)] / (2E_{in}). \quad (21)$$

For simplicity, use the same wire size for the feedback windings as for the primary.

*Step 16.* Calculate the copper cross-sectional areas needed by each secondary winding based on 1000 circular mils per ampere:

$$A_{pp} = I_s \times 1000, \quad (22)$$

$$A_{fw} = (I_s/2) \times 1000, \quad (23)$$

$$A_{fwb} = I_s \times 1000. \quad (24)$$

After selecting the wire sizes, record wire data.

Calculate total wire area:

$$A_T = A_p + A_{pp} + A_{fb} + A_{fw} + A_{fwb}. \quad (25)$$

*Step 17.* Calculate fractional window fill:

$$F = A_T / W. \quad (26)$$

If  $F$  is more than 0.4 (40% of the window), then

- Select a core with the next largest  $WA_c$  product.
- Recalculate the design.

If  $F$  is less than 0.4, the design is acceptable and we can proceed to calculate the feedback resistors for the divider. Denoting divider ratio as  $G$ , get

$$G = R_2 / (R_1 + R_2) = (4 \text{ volts}) / E_{in}. \quad (27)$$

Note that the voltage should be set between 3 and 6 V:

$$I_{base} = I_{in} / h_{fe}, \quad (28)$$

$$E_T = V_{BE(sat)} - (E_{fb}/2), \quad (29)$$

$$R_p = (G \cdot E_{in} - E_T) / I_{base}, \quad (30)$$

where  $R_p$  is effective parallel resistance.

*Step 18.* Calculate  $R_1$  and  $R_2$  as follows:

$$R_1 = R_p (4/E_{in}) \quad (31)$$

$$R_2 = R_p [1 - (4/E_{in})]. \quad (32)$$

**Table 4. Heavy film wire sizes**

Wire size (AWG)	Diameter (max) insulated (circ-mils)	Diameter bore (circ-mils)	Ohms per 1000 ft.
12	7310	6529	1.588
13	5852	5184	2.001
14	4679	4109	2.524
15	3758	3260	3.181
16	3003	2581	4.020
17	2421	2052	5.054
18	1936	1624	6.386
19	1560	1289	8.046
20	1246	1024	10.13
21	1005	812.3	12.71
22	807	640.1	16.20
23	650	510.8	20.30
24	524	404.0	25.67
25	424	320.4	32.37
26	342	252.8	41.02
27	272	201.6	51.44
28	219	158.8	65.31
29	180	127.7	81.21
30	144	100.0	103.7
31	117	79.21	130.9
32	96.0	64.0	162.0
33	77.4	50.41	205.7
34	60.8	39.69	261.3
35	49.0	31.36	330.7
36	39.7	25.0	414.8
37	32.5	20.25	512.1
38	26.0	16.0	648.2
39	20.2	12.25	846.6
40	16.0	9.61	1079.6

*Step 19.* Calculate winding resistance by first calculating mean turn length from

$$L_M = (\text{core box O.D.} - \text{core box I.D.}) + 2 (\text{core-box height}), \quad (33)$$

so that the winding resistance,  $R_w$ , becomes

$$R_w = [N(L_M/12) (\text{ohms}/1000 \text{ ft})] / 1000. \quad (34)$$

The iron and copper losses are then calculated to estimate the efficiency of the transformer.

*Step 20.* Calculate the copper losses in each winding from the winding resistance and current in each winding.

$$P_L = R \cdot I^2 \quad (35)$$

and sum the individual winding losses to find the total copper loss.

*Step 21.* Obtain the weight of the core from Table 2 and the core loss per pound for the selected frequency from Table 1. Then,

$$P_c = \text{weight} \times \text{core loss}. \quad (36)$$

The sum of the copper losses and the core losses should approximate 20% of the input power to the transformer. ■■

**References:**

- "Converter and Inverter Design," Magnetics Inc., Butler, Pa.
- Johnson, G., "Help Yourself to a Good DC-to-DC Converter Design," *Electronics*, October 12, 1970, pp. 102-105.

# CAUTION: 50,000 VOLTS



## LET ERIE DESIGN and BUILD YOUR HIGH VOLTAGE POWER SUPPLIES and VOLTAGE MULTIPLIERS

When you talk about designing and packaging miniature, low current High Voltage Power Supplies and Voltage Multipliers, the name ERIE should come to mind first. Why? *No other manufacturer of these sophisticated devices has its own capacitor and rectifier technology in-house.* Only ERIE does it all. Our many years experience in producing State of the Art high voltage capacitors and high voltage silicon rectifiers — plus an unsurpassed technology in circuit designing, packaging and encapsulation, makes ERIE an ideal source for your high voltage component needs. From very low input voltages, ERIE can produce output voltages up to 50,000 volts. Application for these compact, high reliability devices includes night-vision image intensification systems. Apollo TV cameras. CRT displays. Avionics systems exposed to rugged environments. Industrial, commercial and military equipments . . . an almost infinite variety of applications. So bring ERIE in early. Let us design and build *your* High Voltage Power Supplies and Voltage Multipliers. We're equipped to handle large or small volume orders . . . in-house.

Write for our 32-page catalog . . .  
High Voltage Components and  
Devices . . . or for technical  
assistance, call  
613/392-2581

ERIE TECHNOLOGICAL PRODUCTS, INC.

Erie, Pennsylvania 16512

INFORMATION RETRIEVAL NUMBER 56



**DEC,  
EAT YOUR  
HEART  
OUT.**

For the past few months, DEC has been the biggest name in real-time and disk-based standard operating systems.

But the picnic's over.

Now we've got two new standard hardware/software systems. And both of them have price/performance stories that can beat the socks off DEC's corresponding models.

## **SAVE \$20,000 ON OUR NEW DBOS.**

DEC's disk-based systems will run you about \$60,000.

Our DBOS-II is only \$39,500 and it's superior to any disk-based system on the market.

If we haven't got your attention yet, maybe we should mention that our DBOS-II lets you do more computation with less memory in far less time.

You get faster program generation because we give you both scientific and commercial languages.

While other systems are confined to either interactive or batch operation, DBOS-II offers a combination of both. Plus a comprehensive file management system, text editors, interactive debug routines, mathematical functions and commercial libraries. That explains our faster program implementation.

As for program execution, we do it faster because the heart of our system is the SPC-16/65 minicomputer which has the most powerful instruction set available and therefore requires less memory.

## **AND UP TO \$40,000 ON OUR NEW RTOS.**

If you want to combine your program generation and computation with control of real-time tasks, DEC's RSX-11D will set you back more than \$80,000.

Our new RTOS-II will do the job for \$46,950. And if you don't need a line printer and card reader, we can start you out at \$29,950.

RTOS-II has all the advantages of DBOS-II in background, with a very responsive foreground for handling events that occur in real time.

And compared to DEC's RSX-11D, we pack more power and features in far less memory.

You can tailor our system to fit your application starting with as little as 16K memory, expandable to 128K.

## **NOW IT CAN BE TOLD.**

Some manufacturers go to incredible lengths to protect their juicy trade secrets.

We publish ours.

The reasons we can give you price/performance advantages are all spelled out in "The Value of Power." For a free copy, or for more information on RTOS-II or DBOS-II, write General Automation, 1055 South East Street, Anaheim, Calif. 92805. If you're in a hurry, call (714) 778-4800.

# **GENERAL AUTOMATION**

# Look out! All electrolytic capacitors are not alike. Internal construction determines unwanted inductance that limits high-frequency performance.

Though many engineers tend to treat capacitors as ideal components in circuit design, real capacitors can have annoying amounts of inductance and resistance along with the desired capacitance. These unwanted properties (Fig. 1) are particularly prevalent in conventional electrolytic capacitors and they hamper filtering of high-frequency power-supply ripple and noise. But manufacturers have simple ways of minimizing unwanted effects. The wise designer should be aware of them when specifying capacitors.

A capacitor's equivalent series resistance (ESR) and equivalent series inductance (ESL) are particularly harmful when the capacitors are used for filtering in switching-regulator designs and for decoupling in digital circuits. In both applications unwanted pulses with very-high-frequency components extend into the megahertz region.

A conventionally constructed electrolytic capacitor provides an increasing impedance vs frequency response (Fig. 2, curve A). The minimum impedance point corresponds to the series-resonant frequency, typically about 20 kHz, of the ESL and capacitance in the unit's equivalent circuit (Fig. 1a). The ESR is then the minimum shunt impedance of the capacitor in a filter circuit at this frequency.

As the frequency increases beyond resonance in a series-resonant circuit, the inductance begins to dominate and the impedance increases with frequency. This behavior is, of course, undesirable.

One solution is to use several capacitors in parallel, each selected to filter a successively higher frequency band. These capacitors can include solid-tantalum and ceramic units for the higher frequencies. Another and more practical solution—especially for medium-voltage and higher power supplies—is to use improved electrolytic capacitors that feature extremely low ESR and ESL.

Conventional electrolytic capacitors with either single-ended or axial leads have the same basic

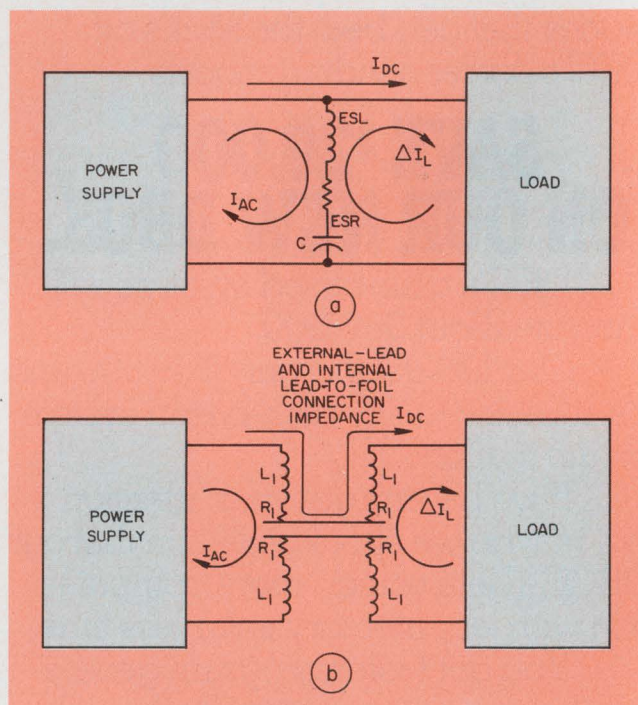

1. In a two-terminal capacitor (a), all the power-supply ripple and noise is coupled to the load via the total impedance of the capacitor and its leads. But in a four-lead unit (b), the leads form an effective decoupling circuit for the capacitor's internal impedance.

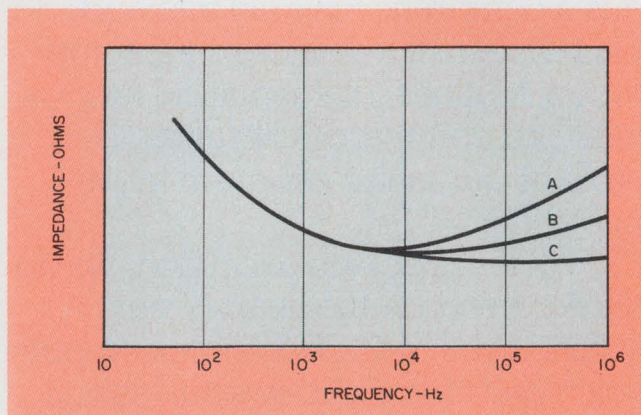

2. The conventionally constructed electrolytic capacitor's impedance (curve A) increases at frequencies above its resonant frequency. Careful attention to internal lead connections (curve B) and use of a four-terminal configuration (curve C) improve the capacitor's impedance-frequency response.

Edward L. Bowling, Application Engineer, Cornell-Dubilier Electronics, Box 2070, Sanford, N.C. 27330.

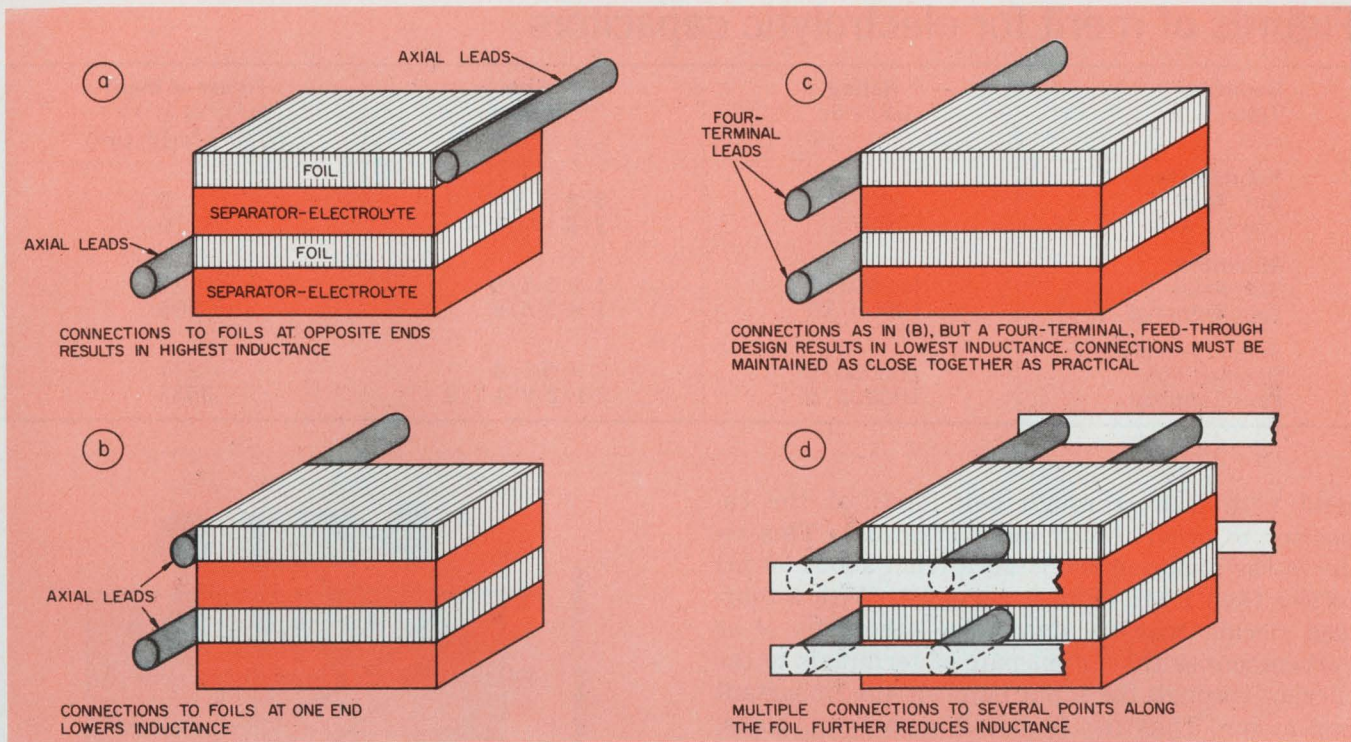

3. Internal lead-to-foil attachment is critical in determining an electrolytic capacitor's impedance properties.

After the leads are attached, the foil sandwich and its electrolytic separators are rolled to fit a tubular housing.

construction details. In both types the aluminum anode and cathode foils are separated by paper that is saturated with electrolyte. This sandwich is then wound into a roll and inserted in a suitable container. After leads are attached, the container is sealed. However, the placement of the lead-to-foil connection has a decisive effect upon the capacitor's inductance.

If the anode connection is on the inside of the roll and the cathode connection on the outside and at the opposite end of the foils, the inductance and impedance will be excessive at high frequencies (Fig. 3a).

On the other hand, if both foil connections are made at the inside of the roll (Fig. 3b), the inductance is reduced considerably (Fig. 2, curve B). For capacitors of 3/8 in. dia. or less, which have short lengths of foil, this type of lead connection provides a reasonably low impedance at high frequencies. This is adequate for small, low-watt power supplies. Fig. 4 compares the impedance of a conventional capacitor, with leads connected as in Fig. 3a, and the improvement that the inside, single-ended connection provides (Fig. 3b).

But large capacitors are needed for high-wattage power supplies, and these capacitors also have proportionately higher inductances. Again, simple changes in capacitor construction can reduce the inductance to acceptable levels. In addition to connecting the capacitor's internal leads to the foil at the inside of the roll, we ex-

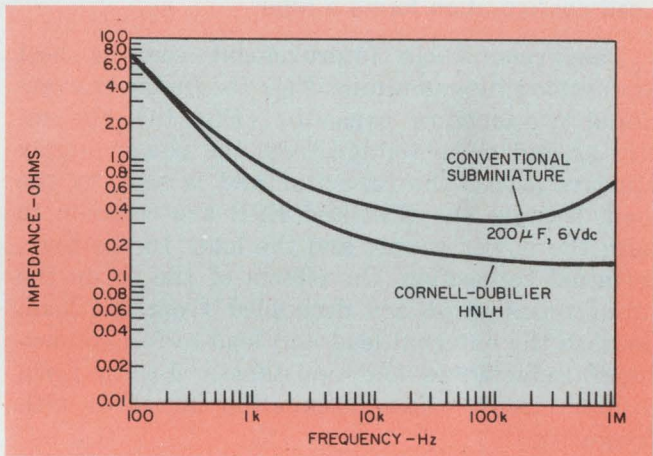

4. Simple attention to the details of lead-to-foil attachment can produce a significant improvement in an electrolytic's impedance properties.

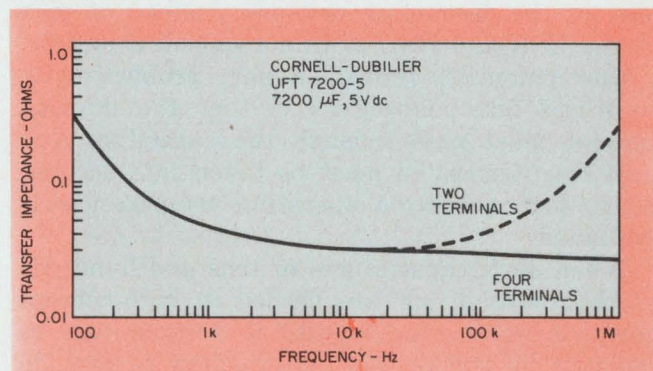

5. A four-lead configuration can further lower an electrolytic capacitor's transfer impedance.

# Figures of merit for electrolytic capacitors

Capacitor Type	Rating $\mu\text{F}/\text{V dc}$	Size inches	Figure of Merit $(\mu\text{F})(\text{V}) \times 10^{-4}$ $(Z @ 1 \text{ MHz}) (\text{in}^3)$
<b>Subminiature</b>			
Std. Axial	200/6	3/8 × 3/4	2.1
Low-Z, Axial	200/6	3/8 × 1-1/4	6
<b>Miniature</b>			
Std. Axial	12000/10	1 × 3-5/8	27
Four-Terminal	12000/10	1 × 3-5/8	306
<b>Screw Terminal</b>			
Stacked Foil	100000/5	3 × 5-5/8	271
Four-Terminal	100000/5	2-1/2 × 4-1/8	3536

tend both leads through both ends of the capacitor to provide four leads (Fig. 3c). This reduces the apparent inductance from about 50 nH to less than 1 nH (Fig. 2, curve C). With a four-lead circuit, transfer impedance—the ratio of ac voltage across the output pair of terminals to the current through the input pair—is the important parameter. Thus for four-lead capacitors, transfer impedance, as measured on a typical four-terminal capacitor versus frequency is shown in Fig. 5 and compared to a similar two-lead unit.

## Lead configuration forms a filter

This remarkable improvement can be best understood by examining Fig. 1b. In the conventional two-terminal capacitor (Fig. 1a), the entire ac and noise voltage from the power supply appears across the capacitor and is seen by the load, because the ESL and ESR are common to both the power supply and the load. In the four-terminal connection, the effects of the ac on the input termination are decoupled from the load, because the external lead and lead-to-foil connections' inductances and resistances,  $L_1$ ,  $R_1$ , form a filter circuit whose attenuation increases with frequency.

Another advantage of the four-lead design is that a feedthrough configuration can be used to connect the load to the power supply. And any extra wire needed to connect the two becomes part of the decoupling network, instead of part of the ESR and ESL as in a two-lead capacitor.

One potential, though minor, problem with four-lead filter capacitors is that the dc load current must pass through the capacitor. Any heat thus generated must be taken into account when the capacitor's operating temperature is evaluated.

When large capacitances of tens and hundreds of thousands of  $\mu\text{F}$  are needed in high-current power supplies, the rolled-foil designs can be replaced by stacked-foil construction to provide the necessary capacitor-voltage (CV) product and low ESR (in milliohms) and low ESL (less

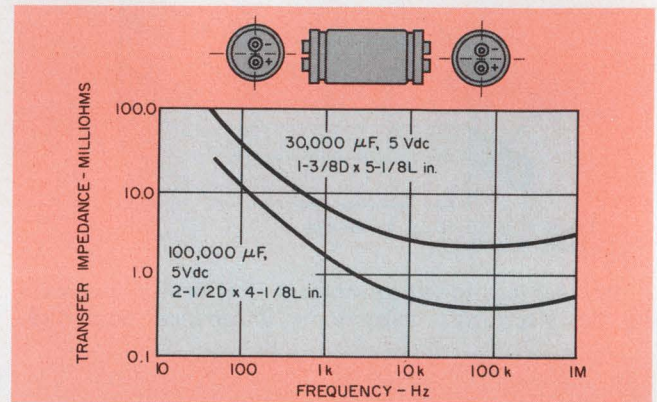

6. Four-terminal and internal multiconnection construction provide even the largest capacitors with low transfer-impedance properties.

than 2 nH). However, the voltage ratings of stacked-foil designs are presently restricted to the 5-to-50-V range.

To overcome this voltage limitation, the capacitor can be wound conventionally and multiple connections to the foil (Fig. 3d) can reduce the ESR and ESL to approach the values of a stacked-foil design. And with four-terminal, double-ended terminals, low impedance is retained into the MHz region, though at about 10 kHz the stacked-foil capacitor may have a slightly lower impedance. However, voltage ratings can then range up to 150 V dc. Such a low-impedance design permits ripple currents as high as 60 A, which far exceed the ratings of conventional capacitors. Multiple-tab construction usually permits a smaller package than an equivalent stacked-foil design (Fig. 6).

A figure-of-merit table (see accompanying table) compares the capabilities of the various construction techniques. The figure of merit takes into account the CV product, the capacitor's impedance at 1 MHz and its volume. The higher the figure of merit, the better the design. ■■

## Reference

*Designer's Kit No. 1*, "Low Inductance Electrolytic Capacitors," Cornell-Dubilier Electronics, 150 Ave. L, Newark, N.J. 07101—request on company letterhead.



# P&B low-profile R50 Relays let you tee off on critical printed circuit board spacing problems.

New low profile R50 relays with 0.1" grid spacing are designed for switching currents where larger relays are usually required. Up to 2 amps @ 26 VDC or 1 amp @ 115 VAC, resistive.

While retaining a small package size—0.415" height—some R50 operating parameters exceed those of reeds. Special 1 Form C contacts, for example, will switch capacitive or lamp loads that normally would weld reed relay contacts.

Additional features include contact resistance of less than 50 milliohms, sensitivity to 125 mw, and

standard coil voltages from 6 to 115 VDC with operate and release times of less than 6 ms.

Enclosures are ultrasonically welded to their base making them ideal for use with production techniques requiring flow soldering and spray cleaning.

R50 relays can be used in most applications demanding high density packaging such as 0.6" center to center spacing of printed circuit cards. Other applications include: Annunciator circuits that only require a single contact and limited mounting space for switching device . . .

communication systems such as intercoms, modems, auxiliary tape devices, interfacing systems and read out devices . . . machine tool control circuits.

For complete information, contact your local P&B representative or call Potter & Brumfield Division of AMF Incorporated, Princeton, Indiana 47670. Telephone: 812 385 5251.



**Solving switching problems is what we're all about.**

INFORMATION RETRIEVAL NUMBER 58



# DIVA'S COMPUTROLLER, PDP 11, AND 3330 TYPE DISC DRIVE UNITE. AN INCREDIBLE MARRIAGE.

*An Episode in the True Chronicle of the DIVAS, Proudest Peripheral Family in the Computeworld.*

The computeworld stares in awe at the incredible wedding scene which has unfolded before them. The bride is minicomputer PDP 11, offspring of the illustrious maxi-computer clan, begat of Abacus. The bridegroom is DIVA COMPUTROLLER, scion of this proud, most respected peripheral family. Officiating at the ceremony is Duke DIVA Disc Drive, direct descendant of IBM compatible 3330 type disc drives.

Realizing the great impact this interfacing will have on the computeworld, our happy guests monitor the wedding with joyous solemnity.

"Mated," Interdata 70 whirrs, "PDP 11 will have access to 100 million bytes of data on a single spindle or 200 million bytes on a dual spindle disc drive unit within an average access time of 32 msec."

"And with COMPUTROLLER providing a buffering sector, data will be transferable at the rate of 645,000 bytes/sec," marvels Nova II.

"And keep in mind," interrupts a breathless TI 980A, "that with COMPUTROLLER controlling eight drives, mini will have access to 1.6 billion 8-bit bytes of data!"

But, hush! Listen to Duke DIVA repeating those always-inspiring words: "With the data stored in me, and with provided interconnecting cables and distribution panel, I now pronounce you linked in holy matrimony."

Resounding cheers befitting the occasion arise from the crowd. "A toast! A toast! A toast!" they roar. As is the custom, the proud parents, mini processor and DIVA controller, propose the toast to the dazzling couple: "To the most splendid and significant union in all our memories."



Duke DIVA Disc Drive

Mini PDP 11

"Vive, DIVA! Vive, DIVA! Vive, DIVA!" Everyone unwinds.

But even as we listen to the clink of ceremonial glasses and the exuberant laughter, we sense an underlying sadness. Those unchosen minis — do they count for nothing now? Will they not be able to enter the world of high speed data storage/access and low cost/bit performance? And why — throughout this entire festivity — has COMPUTROLLER remained hidden under his purple robe? Is there more to

COMPUTROLLER than meets the eye? Be sure to join us for the next episode in the True Chronicle of the DIVAS when we will hear the horrendous accusation: "Bigamy! BIGAMIST!"

In the meantime, learn COMPUTROLLER'S inside story. Find out about the free implementation and training courses, the software packages, and warranties that go with each disc system. All you PDP 11 users call George Roessler at 201-544-9000 for cost and delivery information. Or write: DIVA, Inc. 607 Industrial Way West Eatontown, N.J. 07724 TWX 710-722-6645.

REGIONAL SALES OFFICES:  
 CT: 203-526-3222  
 CA: 415-349-3482  
 Wash. DC: 703-370-5211.  
 GSA CONTRACT NO. GSS-OOC-00159.



# The New Jermyn Heat-Pipes.

## What they are and what they do.

First, a little sales talk: A heat-pipe is a clever device with about 400 times the thermal conductivity of solid copper.

An  $\frac{1}{8}$ " diameter heat-pipe can carry away about 20 watts; one  $\frac{1}{2}$ " diameter can carry 500 watts.

With a heat-pipe you can pack your components closer and remove the heat to a sink somewhere else.



## How to use your heat-pipes:

Connect a power diode to a distant heat sink.

Pack your transistors closer without heat problems.

Put your airborne electronics where you want them and pipe the heat to somewhere cooler.

Use one cooling fan and one sink, to cool hundreds of hot spots.

Keep a lot of ganged devices all at the same temperature.

A heat-pipe, or its relative the heat-plate, can keep dozens of devices at the same temperature.

It can operate as low as  $-170^{\circ}$  or as high as  $400^{\circ}\text{C}$ .

And a complete range of heat-pipes can now be obtained from your favourite manufacturer, Jermyn.

## How it Works:

The heat-pipe is a tube, made of copper, stainless steel or sometimes pyrex glass, with an inner lining, or wick, of capillary material.

Both ends are sealed; inside is a small amount of fluid (it might be water or it might be all sorts of things), in a partial vacuum.

When one end of the pipe is made hot, the fluid boils off, and the molecules shoot along the pipe at high speed. They hit the other end, condense, give up their latent heat, and the capillary lining gently sucks them back to the beginning again.

Although that last paragraph took about ten seconds to read, in fact it all happens in an amazingly short time. Molecules are whizzing along at thousands of miles an hour; and that's how you get the enormous rate of heat transfer.

Stick a heat-pipe into your morning coffee and see how your fingers hurt immediately.

As you can imagine, by using different fluids at different pressures, one can make heat-pipes to operate at a wide range of temperatures.

And different shapes and sizes of pipes, or flat plates, or sandwiches etc., give a huge variety of uses and applications.

## What to do next:

You can write for our heat-pipe leaflet.

But essentially this is a problem and solution business. You tell us the sort of circuit, the watts, and operating temperatures required. We'll recommend a heat-pipe to do the job.

## Jermyn

712 Montgomery Street  
San Francisco CA 94111  
San Francisco (415) 362-7431

Paris 744 29-71

Munich (089) 39 88 01

San Francisco (415) 362-7431

# Watch out for problems in switching-mode power equipment. Filters added to prevent EMI can cause your system to oscillate.

With switching-mode power equipment—such as regulators, amplifiers, dc/dc converters and dc/ac inverters—it's usually good engineering practice to insert an LC, low-pass decoupling filter between the prime dc-power source and the switching-mode equipment. This filter keeps switching transients off the power bus.

But following this good practice to avoid problems can, itself, cause an insidious problem—oscillations that arise from the interaction between the filter and the negative dynamic input resistance of the switching equipment. Fortunately, these oscillations can be prevented by damping and other methods.

The problem can occur in any equipment that: (1) supplies substantial power output to a load; (2) keeps that output relatively independent of any variations in dc input voltage ( $E$ ); and (3) operates with an efficiency ( $\eta$ ) that is relatively independent of the dc input voltage; specifically, if the relationship between  $\eta$  and  $E$  is approximated by  $\eta = kE^n$ ,  $n$  must be  $> -1$  for oscillation to be possible.

Specific examples of such equipment are dc power supplies that use either self-oscillating or driven switching regulators (typically,  $n \approx 0$  and the efficiency is approximately independent of  $E$ ); switching-mode ac or dc power amplifiers, the inputs of which are static or dynamic; and power oscillators that use switching-mode output leveling or amplitude modulation.

## Negative input resistance is the culprit

In such equipment, either feedback control or feed-forward compensation is used to make the output relatively independent of the input voltage. Either technique can make the input resistance go negative. Let's take a closer look.

Fig. 1 shows a piece of equipment decoupled from its dc source by a single-section LC filter.  $L$  and  $C$  are the filter elements;  $R_s$  and  $R_c$  will be discussed later. Analyses can be made for

systems using decoupling filters of other configurations.<sup>1</sup>

Assuming that  $L$  and  $C$  are the resonant elements of a negative-resistance oscillator, several problems can occur:

- $E$  can reach instantaneous values small or large enough to cause the equipment or the filter to malfunction or to be overstressed.

- If other equipment is also being supplied by  $E$ , that equipment can malfunction or be overstressed, even if the source of oscillation continues to function properly.

- The oscillating current drawn from the power source can overstress the filter, can cause the source to malfunction or may be coupled into other equipment via the source impedance or via magnetic coupling either to  $L$  or to the power lines feeding  $L$ .

## Possible remedies

Oscillations can be prevented by any of the following (see Eq. 3):

- Provide sufficiently high  $C$  or sufficiently low  $L$ . This may or may not be feasible in a given application.

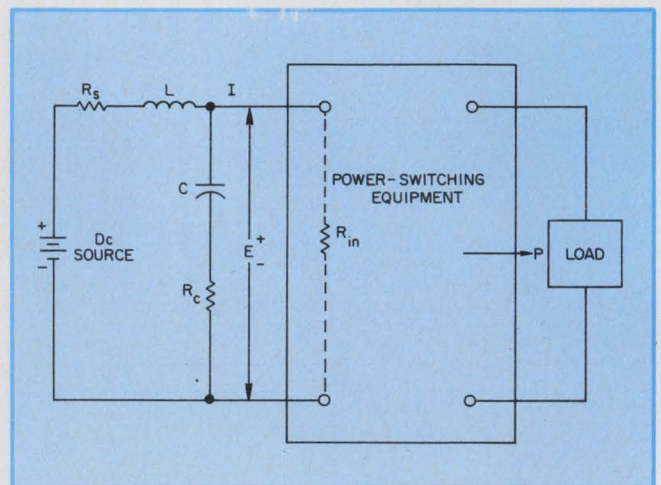

1. Oscillations in power-switching equipment can occur when the equipment is decoupled from the dc prime source by an L-C filter. The oscillations are caused by interaction between the filter and the negative dynamic input resistance at the switcher input port.

Nathan O. Sokal, Chief Engineer, Design Automation, Inc., 809 Massachusetts Ave., Lexington, Mass. 02173.

- Make the conversion efficiency,  $\eta$ , high; this is usually a design objective anyway.

- Plan the system to operate from a high voltage input, rather than a low voltage, if possible.

- Provide sufficiently high  $R_s$ . However, this causes a power loss and reduces the system power efficiency.

- Provide sufficiently high  $R_c$ . But this reduces the effectiveness of the filtering and causes a power loss.

- Provide an ac-coupled damping as shown in Fig. 2.

Whether an increase of  $R_s$  or  $R_c$  will enhance or degrade stability in a given case depends on the relative values of  $R_s$ ,  $R_c$ , and  $L/C$ .

It can be shown that stability is enhanced by an increase of  $R_c$  when  $L/C > R_s^2$ , and also by an increase of  $R_s$  when  $L/C > R_c^2$ .

Fig. 2 shows the system of Fig. 1 with a damping resistor,  $R_D$ , added to cancel the negative input resistance,  $R_{in}$ . Resistor  $R_D$  is capacitively coupled via  $C_D$  so as to load any ac across  $C$  (the oscillations to be suppressed) but not to absorb dc power.

If  $R_D$  performs properly, there won't be any oscillations across  $C$ . Oscillation will not occur if:

$$\frac{1}{(R_D + LC/R_D C_D^2)} > [P/\eta E^2 - (R_c + R_s) C / (L + CR_s R_c)]. \quad (1)$$

### Why input resistance is negative

Consider a system supplying power,  $P$ , to its load. This power can be ac, dc, static or modulated. Assume the system output is regulated by feedback or compensated by feed-forward against the voltage variations at the dc input. Therefore,  $P$  can be considered to be independent of the voltage input.

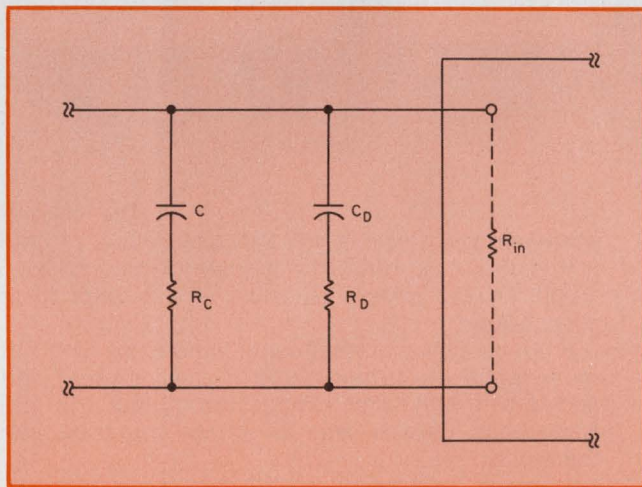

2. One way to prevent oscillations is to provide an ac-coupled damping circuit,  $C_D$  and  $R_D$ , at the input port. In effect, the damping resistor,  $R_D$ , cancels the negative input resistance at the port. Capacitor  $C_D$  prevents the dissipation of dc power in  $R_D$ .

The efficiency of power conversion is  $\eta$ ; thus the input power is  $P/\eta$ . If the input voltage is  $E$ , the input current is then  $I = P/\eta E$ , and the dynamic input resistance is  $R \equiv 1/(dI/dE)$ .

Initially, consider the case for which  $\eta$  (proportional to  $E^n$ ) can be considered to be independent of  $E$ , that is,  $n = 0$ . Then, the input resistance becomes

$$R_{in} = 1/(dI/dE) = -\eta E^2/P \quad (2)$$

If, in fact,  $\eta$  and  $P$  are functions of  $E$ , then those functions must be included in the expression for  $I = f(E)$ , which is differentiated to find  $R_{in}$ . But in well-designed equipment,  $\eta$  and  $P$  are relatively independent of  $E$  and, consequently, a substantial negative input resistance exists.

### Conditions for oscillation

Refer again to Fig. 1. In the diagram,  $L$  includes the source and line inductances;  $R_s$  is the sum of the inductor winding resistance, the line resistance, the dc-source output resistance and an equivalent lumping of the losses in the magnetic core of  $L$ ; and  $R_c$  is the equivalent series resistance of the filter capacitor.

If the loss elements,  $R_s$  and  $R_c$ , are cancelled by the negative input resistance,  $R_{in}$ , an oscillation could be maintained at the resonant frequency of  $L$  and  $C$ . The condition for oscillation not to occur can be found by writing the differential equation of the circuit, and then setting the damping term in the equation to a positive value. Thus, oscillation will not occur if,

$$\eta E^2/P > (L/C + R_s R_c) / (R_s + R_c). \quad (3)$$

Similar expressions can be derived for equipment in which  $P$  and  $\eta$  are functions of  $E$  or which uses other than a single-section LC filter.

Note that, because  $R_{in}$  varies with  $E$ , the system is nonlinear, and the oscillation waveform is therefore nonsinusoidal. Note also that  $L$  usually varies with the current and  $C$  may vary with the voltage.

If the resonant frequency of  $L$  and  $C$  is not much lower than the cutoff frequency of the equipment's power output controller, a reactive component of input impedance must also be accounted for. The reactive component is caused by the lag of the controller in responding to a change of  $E$ .

Finally, note that, even though  $P$  and  $\eta$  vary little with  $E$  at low frequencies, this situation can change at higher frequencies. This should be taken into account in systems where  $E$  and  $P$  vary at rates that are fast compared with the controller response time. ■■

### Reference:

1. Yu, Y. and Biess, J. J., "Some Design Aspects Concerning Input Filters of DC-DC Converters," Proc. IEEE Power Processing & Electronics Specialists Conference, 1971.

# THIS LITTLE SWITCH

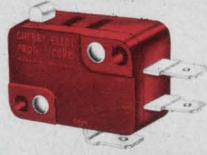

# STARTED SOMETHING BIG

# CHIEF

**IN 1953 WE HAD ONE PRODUCT . . . AND ONE CUSTOMER.** Our "factory" was a leased basement and our work force totaled 15 people.

But we introduced something besides just another product to the switch industry . . . our contribution was *creative engineering*. We gained a reputation for innovation by an ability to manufacture switches, custom for the application, at lowest possible cost.

Engineers liked our ideas and our switches and our way of doing business . . . so they helped us grow.

**AND, BOY, DID WE EVER GROW!** The old leased basement has grown to 170,000 square feet of modern plants. Our customer list has grown from one to over 5,000. Our 15 people have become a work force of over 1,300.

From our home in Waukegan, Illinois, we direct three manufacturing subsidiaries in Germany, England and Japan with sales offices throughout the United States and Canada and 24 other countries around the world.

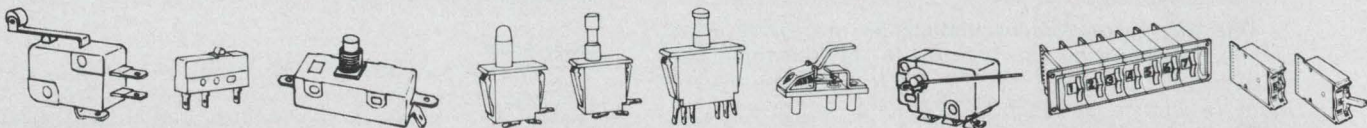

**PRECISION SNAP-ACTION SWITCHES • PANEL MOUNT PUSHBUTTON • GOLD "CROSSPOINT" • THUMBWHEEL AND**

**CHERRY ELECTRICAL PRODUCTS CORP.** 3600 Sunset Avenue, Waukegan, Illinois 60085

Cherry Worldwide: (Subsidiaries) Hirose Cherry Precision Co., Ltd., Tokyo • Cherry Mikroschalter GmbH, Bayreuth, Germany  
• Cherry Electrical Products (U.K.) Ltd., St. Albans, Herts • (Licensee) G.W. Engineering Pty. Ltd., Sydney



# CHERRY

**WHERE DO WE GROW FROM HERE?** Creative engineering produced the first snap switch with a coil spring mechanism and developed gold "crosspoint" contacts for low energy switching. Creative engineering is the basis of our lever-action thumbwheel switches, electronic calculators, keyboards and plasma displays.

We intend to keep our emphasis on *creative engineering* and *customer service* . . . so we're looking forward to even greater things in the future (like a new line of digital readouts).

## CALL THE BIG ONE . . . Cherry

(312) 689-7700 if you have an application. Or, if you would like a copy of our latest complete-line catalog, circle the reader service number and watch us move fast! One thing is sure: we'll deliver you quality products at attractive prices. That's what Cherry is all about.

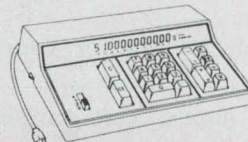
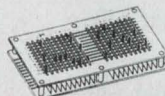
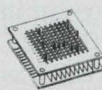
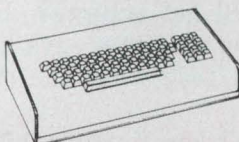
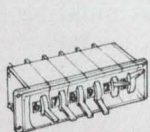
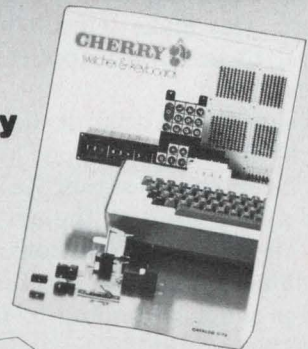

**LEVERWHEEL • KEYBOARDS & KEYBOARD SWITCHES • MATRIX SELECTOR • ELECTRONIC CALCULATORS • DIGITAL READOUTS**

## Forecasting is an engineering job, too,

says corporate head. Physics, a feel for customer needs and attention to detail all help turn designs into products.

The guy who said, "Never before has the future so rapidly become the past," probably had to forecast the design of an electronic product. Technology used to change completely in seven years, but now three years is about the limit that I can set to put a product plan in motion and reasonably predict its outcome.

With a shorter and shorter lead time to get the product to market, the tricks of good design forecasting and subsequent follow-through take on more and more importance for both top management and the designer.

Our company's corporate officers look at the computer models of the U.S. economy to get a good idea of where our products are going to go. I've found these models to be quite accurate and a lot more bullish on America than the stock market has been.

But what about the designer? Technical forecasting is now a very vital function of the engineer. What can he do to tighten his forecasting and to get the product to the market on time?

### The physics approach to forecasting

One thing designers should do is go back to school. Our director of research, for example, spent a month in Phoenix learning how to design integrated circuits. We don't make ICs, but we felt that he needed to know how they're made so he could help guide our product development.

The chief engineer at our Maryland division, where we make circuit-breakers, is going to school to learn the applications of the computer industry.

We've found that it helps the designer if he sits at the feet of a good physicist, someone who can help the designer take a very long-range look at the state of the art he's in. Someone who can answer such questions as: Is there anything fundamental in the art that's going to change? Is a product line going to become obsolete? If so, why?

Some questions you can answer yourself. For

example, five years ago we predicted that the mechanical contact would not become obsolete in the next five years, and that number still holds. There are other contacts in development, but they're not ready yet for production on a practical basis.

But for the development of the circuit-breaker, we went to a good physicist for some answers.

About 10 years ago we had to decide where the Maryland plant should put its product development. We asked: Would a magnetic circuit-breaker be an invaluable part of electronic and electrical goods in the next 10 years? The first question was whether or not solid state was going to replace it.

So we went to school and questioned a really good physicist who knew solid state and what made it work. We asked: What are the limits of the state of the art of solid state in the next five years? Will semiconductors be able to handle more power? His answer was, "No."

Well, how about differential devices like diodes? What would happen to them? Would they handle very large currents? "Well, yes, to some extent," the physicist said.

Would they provide the effect of a contact and remain open when the switch is off, and stay closed at a very low resistance of far less than a tenth of an ohm in a forward direction? The answer was, "No, they have a constant voltage drop."

We looked at the other techniques that were creeping around the fringes of the art, and we saw nothing promising. So we decided that it was safe to stay in the electrical contact business.

The whole thing was a good application of physics, management and knowledge of industry.

### Customer 'wants' differ from needs

Besides schooling, the designer must also understand his customer's needs, and from them, predict what design will get accepted. He must try to interpret what the customer says he wants and try to evolve from that what the customer really needs.

If the designer doesn't look further, what hap-

---

**Herb Cook**, President, Airpax, Fort Lauderdale, Fla. 33313.



pened to us can happen to you. One of our designers was working on a project that I'd assumed he was making modular. Lo and behold, he came up with something that was nonmodular. All of us were looking for a modular design, except the designer. We were horrified. We had to scrap his design and start all over again.

The problem is describing the customer's need. After the customer loosely describes what he wants, the designer must try to restate the problem in his own words and then state what he's

going to do to solve it. Then if the customer says, "Oh, no, that's not what I meant at all," they have a chance to go around again.

Getting the customer and the designer to agree on what design is needed requires constant follow-through. But then that's true of any part of the project. You have to follow through from beginning to end to make a forecast a reality.

If you're not convinced, let's talk about what the lack of follow-through does to keep products from reaching the market.

---

## Herb Cook

*Education:* B.S., electrical engineering, University of Iowa; special courses at American Management Association.

*Experience:* Chief of field engineering, Collins Radio; section chief, Bendix Radio; founded Airpax Electronics in 1948.

*Responsibilities:* President and Board Chairman, and active in the engineering activities of the company.

*Patents:* Several on electromechanical devices.

*Publications:* Authored "The Contact Modulator," a technical book on choppers, which convert direct to alternating current; "The Choice of Protection," a pamphlet on circuit protectors; and a number of articles on electronics.

*Employer:* Airpax Electronics is a moderate-sized (\$11,000,000 sales in 1972) manufacturer of electronic components and industrial controls. Major domestic plants are located in Cambridge, Md., Fort Lauderdale, Fla., and South El Monte, Calif., while a joint venture with Sanken Electric Company provides the company with broad exposure to the electronics markets of Japan and the Orient. The company's recent addition is the privately owned American Data Corp. of Huntsville, Ala., a company that makes switching devices and equipment used by TV stations, CATV and closed circuit educational systems.

Electronic components, 64% of revenues, consist mainly of magnetic circuit breakers produced in Cambridge and through Sanken Airpax. Industrial controls, 36% of revenues, consist of a line of devices designed to measure and control many industrial events finding broad application in the automation of mechanical processes.

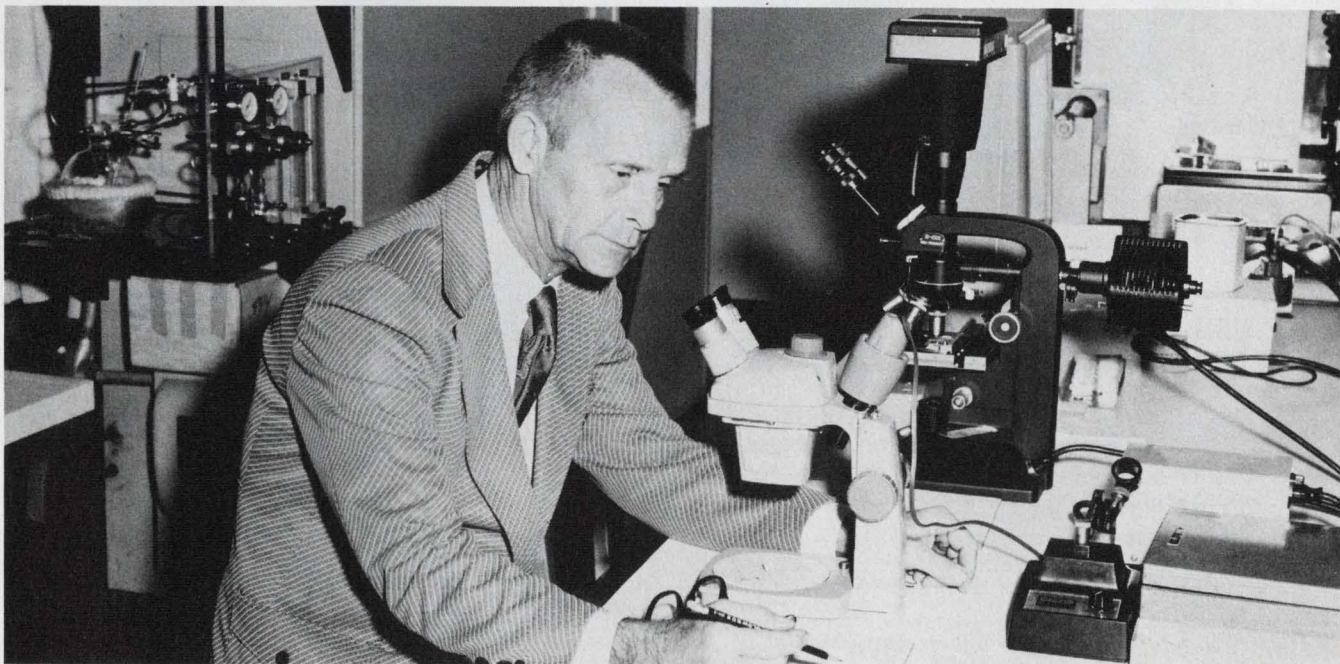

First, there's the completion problem. Some designers never finish. I'll ask: "How are you coming along, Joe?" and he'll say: "Oh, great! I'm 99% done." I'll say: "Oh, that's fine—you'll be finished the day after tomorrow." But that isn't quite what he meant. What he meant was that he had 99% of the thinking done.

We use PERT (Program Evaluation and Review Technique) to help us keep a tight schedule, and it helps eliminate the "99% finished" syndrome. I think a project is successful when you come within 25% of the time and budget, and the harder you PERT, the more successful you are.

The most serious problems that designers have with long-range forecasting is that they don't like to plan their activities ahead. I guess it's not exciting. You can convince some engineers to schedule, and others you have other people schedule for them. I try to get an engineer to commit himself.

#### **Wanted: engineers who'll do the dirty work**

Another problem is that designers tend to be fascinated with the "quantity" of products. They get excited about the prospect of making a million of them. I have a designer who wants to turn his products out like jelly beans. He says that everyone will be doing the same thing.

But these other people he's talking about plan to make money on a volume basis, and I don't. I think I want to stay in the lower-volume, higher-quality, higher-profit areas. Our difficulty with this designer is steering him to do his development in areas that are profit-oriented rather than quantity-oriented. I've got to convince him that a few well-designed products are nicer to produce than a lot of anything.

Another problem is that engineers don't like to do the dirty work. A good electronics engineer is capable of doing printed-circuit-board layouts, even though he thinks it's a job he ought to relegate to a draftsman. An engineer today has to be able to do the layout for a draftsman and have the draftsman clean it up. That's the trick today—to translate a problem into a commercial reality. But there aren't enough engineers today who can do printed-circuit-board layouts. An experienced engineer can lay one out in about 35 hours. It would take a technical draftsman maybe 400 hours to do the same thing. It takes personal discipline on the part of the engineer, because it's a laborious task. But it pays off.

One of the biggest problems today for the designer is making a choice among the fantastic array of components. That is a real problem, and I don't know a good solution to it. Like everyone else, we try to adopt a group of standard parts and stay with those as long as possible. ■■



## **Woven's flat got it.**

You name it. All types of conductors. Any quantity, 2 to 200. Unlimited combinations of lead sizes, insulations and functions. It's computer loomed to meet your most rigid specifications.

### **WOVEN ELECTRONICS**

P.O. Box 189, Mauldin, South Carolina 29662

# SPECIAL STYLES. ENDLESS CHOICE. CUTLER-HAMMER.

Cutler-Hammer has responded strongly to the new emphasis on styling in appliances and other equipment with fresh new design in switches.

Our unique rocker and paddle type switches have a new look. They're not only the finest in performance, but smartest in styling compared to traditional toggle and rotary operators.

From a simple one pole Rockette® switch to a specifically designed unit combining a variety of features, Cutler-Hammer can solve your special problem. Illuminated, snap-in-, nest-, sub-panel- or flush-mounted, sealed miniature, multi-pole, you name it. AC and DC ratings. Up to 20 amps. The choice has to be Cutler-Hammer!

And when you need an *extra special* special design, we'll work with you to make just what you want.

Call your Cutler-Hammer Sales Office or Stocking Distributor. Or write for full-line catalog LD 110A.

**CUTLER-HAMMER**

SPECIALTY PRODUCTS DIVISION, Milwaukee, Wis. 53201

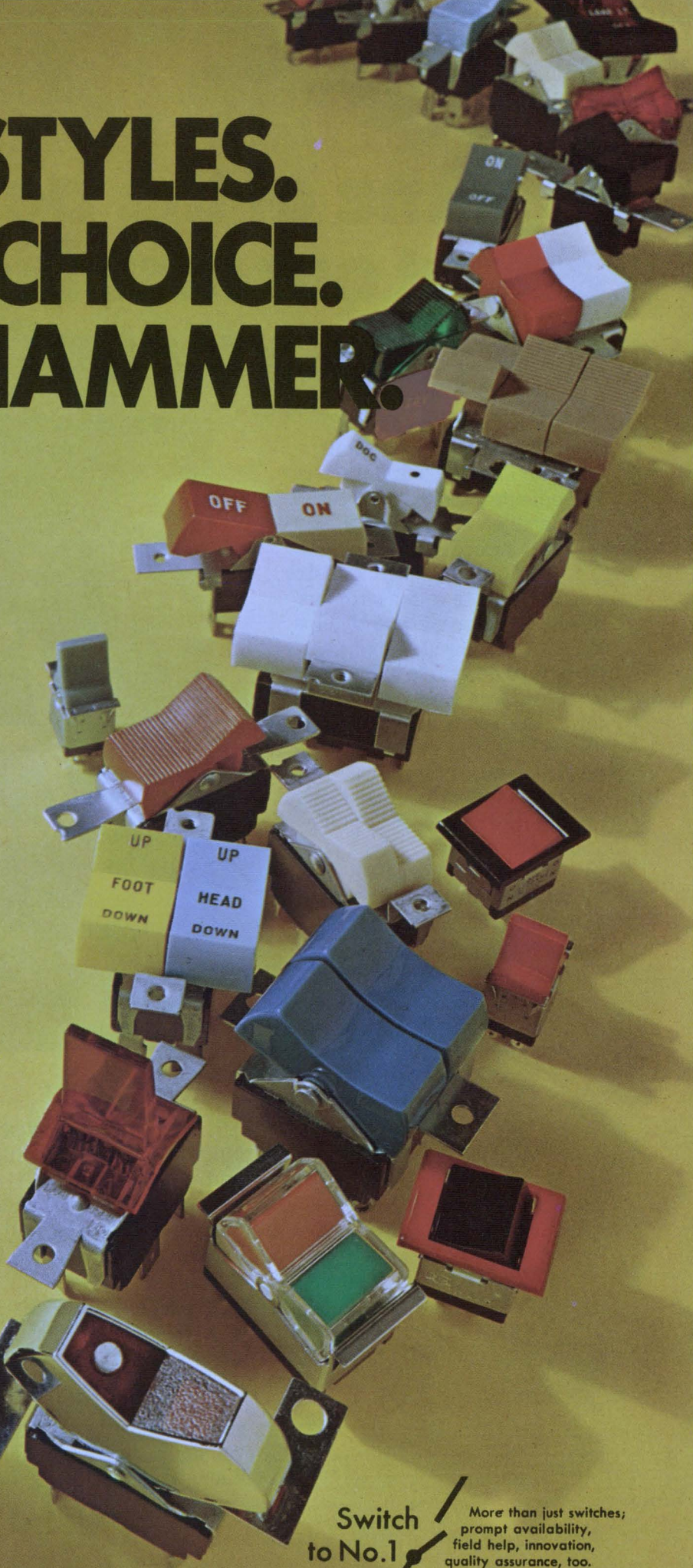
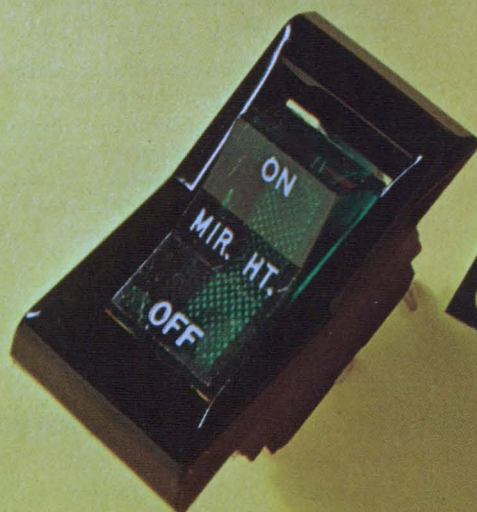

Switch  
to No.1

More than just switches,  
prompt availability,  
field help, innovation,  
quality assurance, too.

# Some of the best things about our new Digivac<sup>®</sup> 1000 are what you can't see.

When you look at our vacuum fluorescent readout, you won't see the low voltage requirements making it directly compatible with available MOS IC logic packages.

You won't see the exclusive mica substrate which supplies mechanical strength and helps emphasize lighted segments through a desirable halo effect.

You won't see the low cost, lower than competing readouts with fewer customer advantages.

Of course, there are things about our Tung-Sol<sup>®</sup> Digivac 1000 you can see.

Like the Digivac 1000's brightness. 50% more brightness and greater uniformity than ever before.

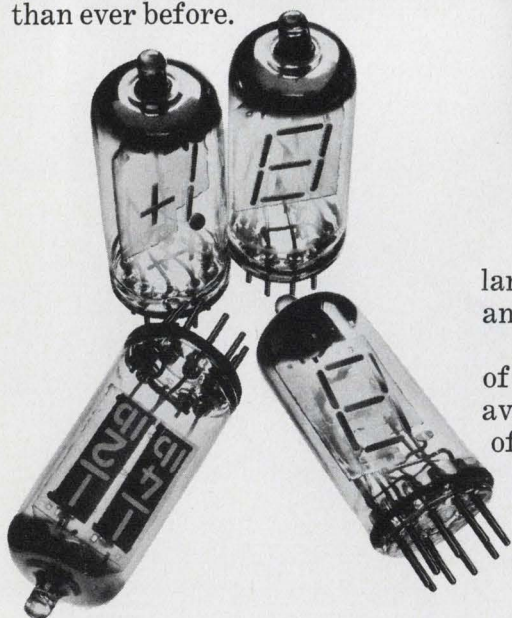

You can see the flexible language with alpha, numerical and symbolic figures.

You can see the wide range of colors, including white, available with common types of filters.

And because of the unique construction, you can see the accurate viewing assured from virtually any angle.

With the Digivac 1000 readout, whether you see it or you don't... it's still nice to know it's all there.

For additional information on the Digivac 1000, write to: Wagner Electric Corporation, 1 Summer Avenue, Newark, New Jersey 07104.

*Wagner makes other quality products in volume for the electronics industry, including bridges, power supplies and subsystems, silicon rectifiers, resistors, miniature lamps and status indicators. And Wagner offers contract manufacturing.*

## **WAGNER<sup>®</sup>**

**We've got a lot more riding for you.**

# We'd like to give a plug to a great new IC connector.

It's our new pluggable dual in-line IC connector. And it offers a combination of quality, reliability and savings never before possible.

**Saves money.** Our new IC connector uses tin-plated contacts that give you excellent electrical connections. So you get connections as good as gold without the price of gold.

**Saves rejects.** The unique contact design of the dual in-line package prevents wicking during soldering to protect circuit integrity and quality. And the receptacle's cut-out design permits easy cleaning after assembly.

**Saves space.** Our new dual in-line receptacle is only .241" high by itself. Only .287" including a 1/8" package. Which means closer densities and more design possibilities. And it's available in 14, 16, 22, 24, 28 and 40 positions.

**Saves service.** This pluggable package will save service time — especially in the field. Remove and replace the IC package quickly and easily. No need to replace the entire PC board. And you can remove and replace a package more than 25 times with no appreciable increase in contact resistance.

So if you want a high quality, reliable IC connector for leaded packages at a reasonable price, find out more about the new pluggable dual in-line socket from Burndy. Simply write: Burndy, 1530 Birchmount Road, Scarborough, Ontario. Or call (416) 757-8761. Our operator will see to it that you get plugged into the right circuit.

 **BURNDY**

INFORMATION RETRIEVAL NUMBER 65

Sales Offices: Saint John • Montreal • Toronto • Winnipeg • Calgary • Vancouver

# BURNDY'S CONNECTS

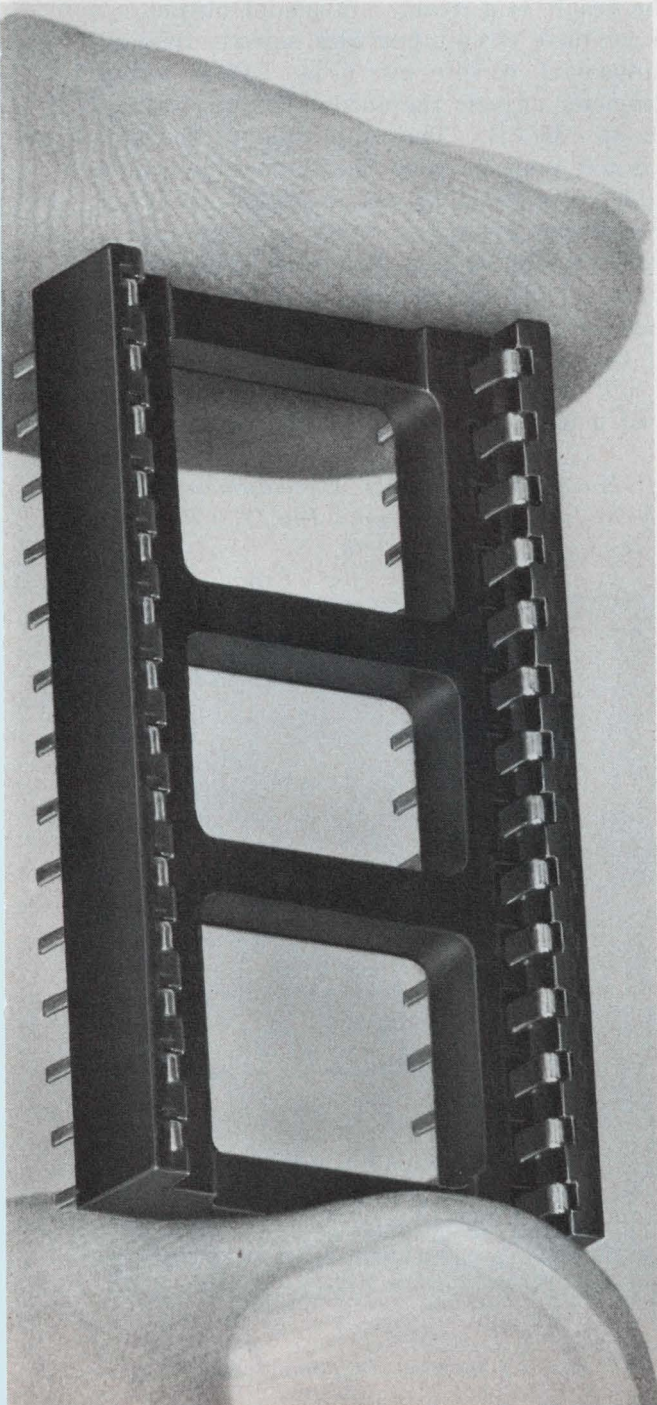

## Less than 1.5% distortion over 1000:1 range provided by swept-frequency oscillator

Combine a good triangle waveform generator with a simple sine shaper, and you get a swept-frequency oscillator that has less than 1.5% total harmonic distortion over a 1000:1 range.

IC<sub>1</sub> provides simultaneous triangle and square-wave waveforms and can operate over a frequency range of 0.01 Hz to 1 MHz (Fig. 1). The

triangular waveform—available at pin 14—is shaped to a low-distortion sine wave by a differential gain stage. The input transistors Q<sub>1</sub> and Q<sub>2</sub> operate near the cut-off point at the positive and negative peaks of the triangle wave. The sharp edges of the input wave are rounded and the result is a nearly sinusoidal output.

The complete circuit provides square, triangle and sinusoidal waveforms (Fig. 2). A single potentiometer adjusts the output frequency from 100 Hz to 135 kHz. The amplitude of the sine wave is 5.0 V pk-pk, and the distortion ranges from 0.5% (in the 1 to 4 kHz region) to 1.5% at the extreme points.

Potentiometers R<sub>0</sub> and R<sub>E</sub>, once adjusted for minimum distortion, require no additional adjustment for the temperature range of 0 to 50 C. Use of the XR2207 provides a frequency stability of IC<sub>1</sub> of 20 ppm/°C over the temperature range of 0 to 75 C.

*Yoshiji Kurahashi, Product Development Manager, Exar Integrated Systems, Inc., 750 Palomar Ave., Sunnyvale, Calif. 94086.*

CIRCLE No. 311

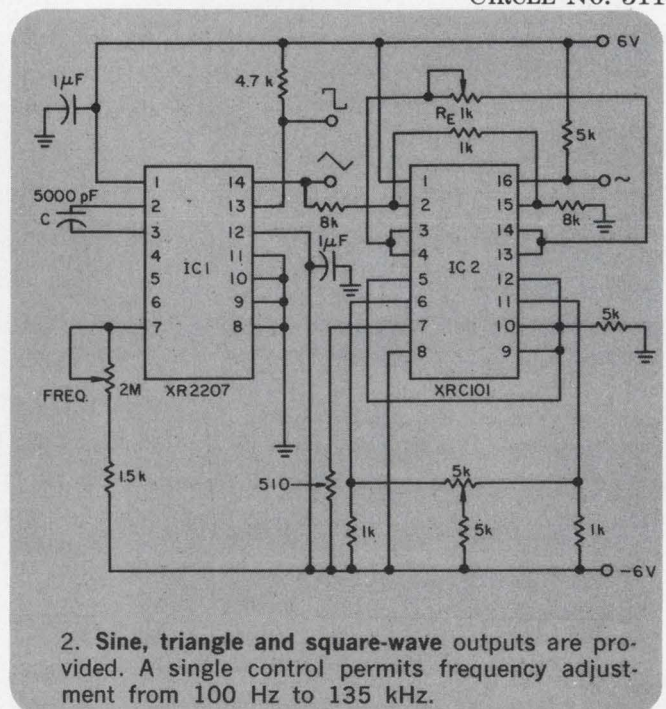
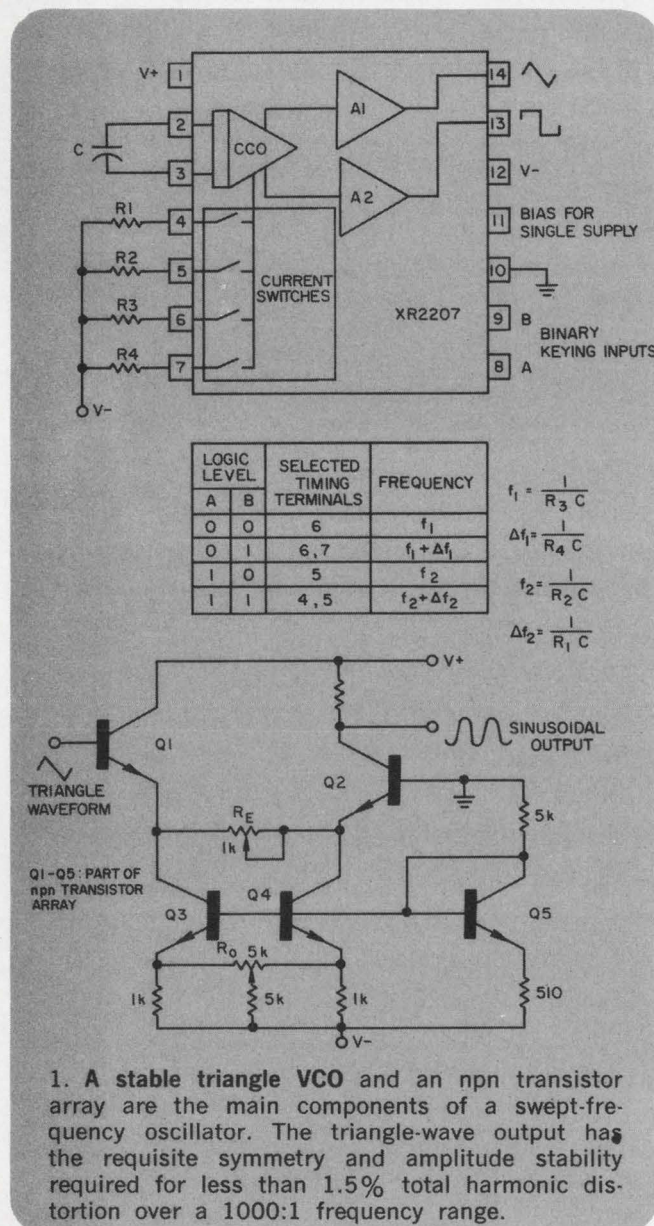

If your problem is **measuring  $\mu\text{V}$ ,  $\mu\text{A}$  and milliohms** in transistorized and integrated circuits . . . Solve it with **Triplett's 801**

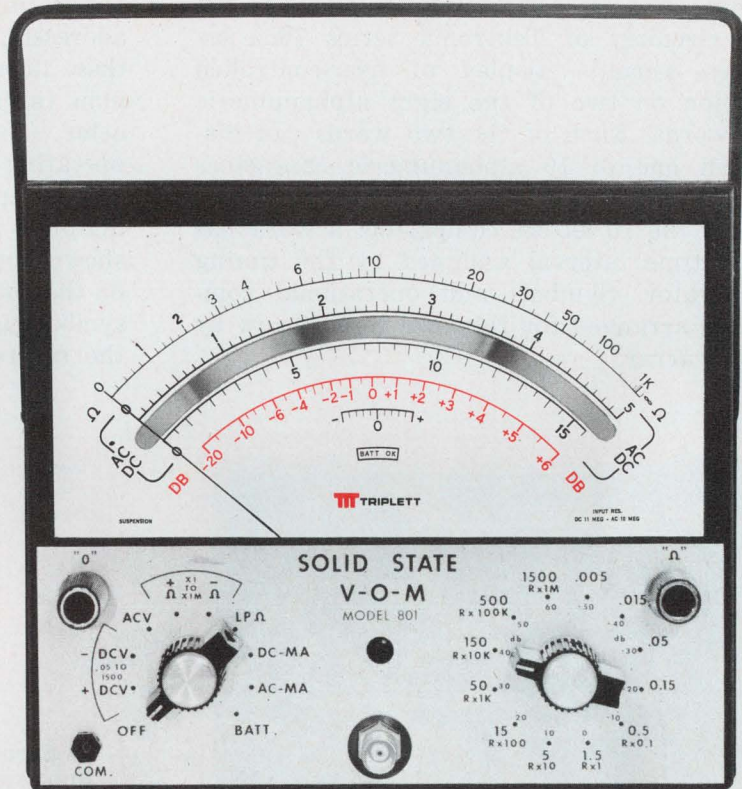

Model 801  
\$ 231

1. Lower power ohms — 8 ranges with 35 mV power source and 1 ohm center scale.
2. High sensitivity — 5 mV AC full scale at 10 megohm input impedance; 50 mV DC at 11 megohm input resistance.
3. Simplified scale — 8" meter with only 4 arcs for all 73 ranges.

It offers 73 measurement ranges including 8 low-power resistance ranges that apply only 35 mV to the device under test . . . does not activate or damage solid-state components. With full-scale readings as low as 50 mV DC and 5 mV AC, 5  $\mu\text{A}$  DC and 100 Ohms (1 Ohm center-scale) — plus a 10 megohm input impedance on the AC scales and 11 megohm input resistance on DC — Triplett's Model 801

V-O-M is ideally suited to in-circuit testing. When you add 2% DC and 3% AC accuracy on the voltage ranges (current: 3% DC and 4% AC) and a 25  $\mu\text{A}$  suspension-type meter with a nearly 7 1/2" scale length, there's no doubt that the Model 801 has no equal among analog V-O-M's in terms of sensitivity and versatility. And there's an optional **Leakage Adapter (\$33)** that measures leakage currents

as low as 1  $\mu\text{A}$ .

See the remarkable **Model 801 V-O-M** — priced at **\$231** — at your Triplett distributor. For more information—or for a free demonstration—call him or your Triplett sales representative right away. Triplett Corporation, Bluffton, Ohio 45817.

**TRIPLETT**

The World's most complete line of V-O-M's . . . choose the one that's just right for you

INFORMATION RETRIEVAL NUMBER 66

# Diode-resistor network adds user-selected readout capability to scope display system

A simple diode-resistor network—added to the readout circuitry of Tektronix series 7004 oscilloscopes—permits display of user-controlled information on two of the eight alphanumeric display words. Each of the two words can display from one to 10 alphanumeric characters (Fig. 1).

Each of the 10 letters comprising a word has a unique time interval assigned by the timing slot generator. Symbols and operational commands are arranged for retrieval in a 10-row by 11-column array.

Two input lines, for each word, control the addressing of the array. The current levels on these lines specify respectively the row and column (array element) to give the required character. (Consult a Tektronix 7504, 7704 or 7904 operating manual for details on the array.)

A separate wire transmits each character timing-pulse (Fig. 2); the column/row-select lines shown control the two rightmost display words on the bottom readout line of the scope face. The symbols used correspond to labelled pins found on the reverse side of the tray that supports the

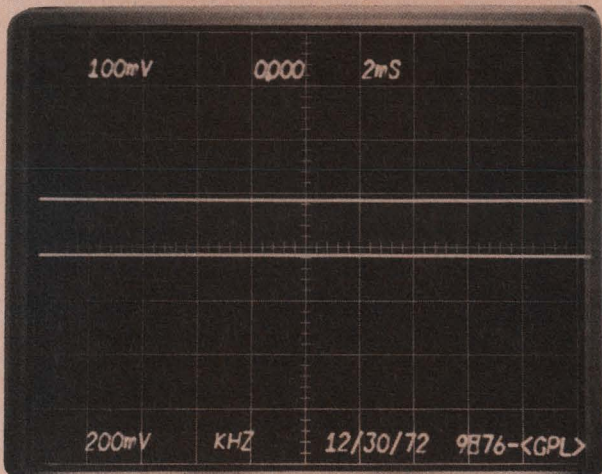
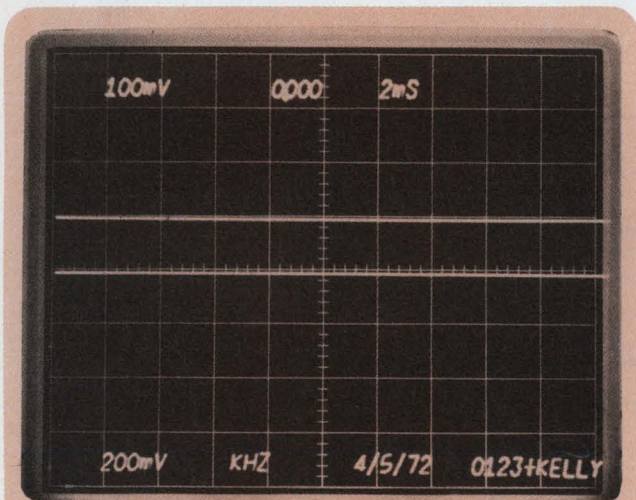

1. Modified scope readout has user-selected information on two rightmost display words (at the bottom of the tube). The first word shows the date; the second the run number (4 digits) plus arbitrary alphanumeric data.

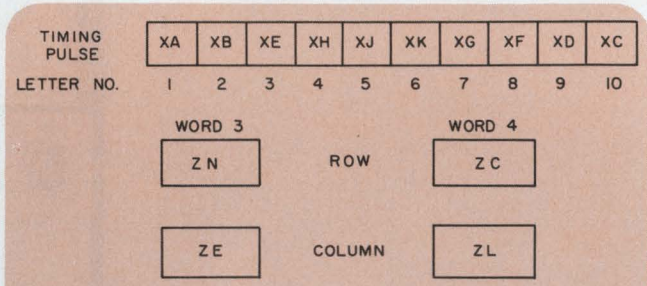

2. Sequence of 10 timing pulses on pins XA through XC selects the position in which a character is displayed. Current levels, applied by a timing pulse to control lines ZN and ZE or ZC and ZL, select the character to be displayed on the scope-face readouts.

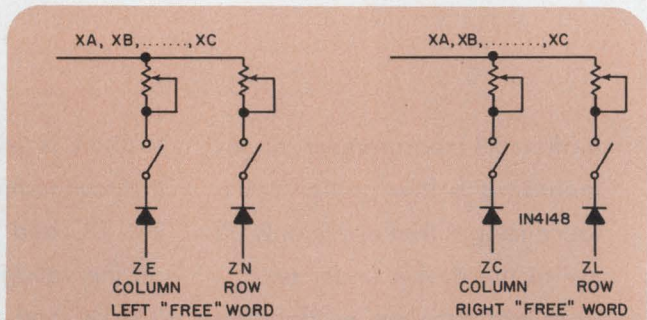

CURRENT (ma)	0	0.1	0.2	0.3	0.4	0.5	0.6	0.7	0.8	0.9	1.0
RESISTOR (K Ω)	-	14.3	69.8	46.4	35.7	28.0	23.7	20.0	17.8	15.8	14.7
COLUMN	0	1	2	3	4	5	6	7	8	9	10
ROW	1	2	3	4	5	6	7	8	9	10	-

3. Circuitry required for character selection. Each timing pulse selects an element (letter) from the scope's character-generation circuitry by row and column number. One two-diode circuit is required for each character displayed.



# Our tester is a big name-dropper.



## When it comes to programming ease.

Our Hustler 44 — the IC tester that's bought by people who really understand automatic testing — is KO'ing our big competitors time after time.

And for good reason. Ours does more, yet costs less.

Take programming. Our software is designed so that your techs & engineers can generate programs to test any kind of IC after a few hours of training in *your* plant. On the other hand, our worthy competitors require a week or more of training at the factory.

Why the difference? Because our simple English language programming is designed for the typical test operator — not a computer programmer. Programs can be generated, edited, listed & debugged even while testing is in progress.

New programs can be generated in far less time, too. And with our unique parallel test concept, the Hustler 44

can DC & functionally test from 5 to 10 times more IC's per hour than Teradyne's SLOT or Fairchild's Sentry series.

That's why such knowledgeable companies as Bell Labs, Control Data, Fairchild Semiconductors, Honeywell,

ITT Semiconductors, Motorola, RCA, Stewart Warner & Western Electric (just to name-drop a few) have chosen our tester. And many are repeat customers.

Here's an offer you can't refuse. If you're really serious about testing, we'll get you and a Hustler together so you can prove to yourself how easy it is to program our tester.

### EASE OF PROGRAMMING BOX SCORE

Job Classification	Datatron Hustler 44	Teradyne SLOT	Fairchild Sentry Series
Technician	Yes with just a few hours of training in your facility	Doubtful. Might take a semester of training at factory	A long shot. Could botch things up
Production Engineer	No problem after a few hours of training in your facility	Possible, but only after weeks of training at factory	"Ditto"
Computer Programmer	Not required but could learn in couple of hours	Recommended. But would still need weeks at factory	"Likewise"

### PROGRAM GENERATE & DEBUG TIME BOX SCORE

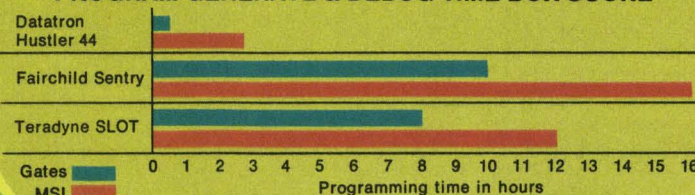

Datatron Hustler 44

# datatron inc.

1562 REYNOLDS AVENUE • SANTA ANA, CALIFORNIA 92711 • (714) 540-9330

readout-circuit board.

Implementation of the display requires the basic circuitry shown in Fig. 3. Each letter of a given word requires a two-diode circuit connected to the corresponding timing-pulse line. The timing-pulse line drives two character-select lines—row and column—of each word. The tabulation gives the resistances needed to select an element (row, column) in the character array.

Fixed resistors (1%) or potentiometers can provide the necessary currents. Multiposition rotary switches afford a convenient means for changing digits—only the column currents require change in this case. Zero current applied to a given column eliminates the readout for the designated letter. The readout circuitry generates an address skip and shifts the remaining

displayed characters one slot to the left to fill in the gap—as can be seen in comparing the “date” display on the two photographs (Fig. 1).

One modification to the mainframe circuitry is needed—disconnection of leads XU and XT. This permits simultaneous display of both words but also causes display of two time-base settings— independent of the horizontal mode. To avoid confusion set both time-base controls to the same value. Alternatively, for single time-base operation, set the B plug-in—usually a 7B50—to the “amplifier” mode, thereby blanking the “B” display entirely.

*Arnold J. Kelly, Assistant Professor, School of Engineering and Applied Science, Princeton University, Princeton, N.J. 08540. CIRCLE NO. 312*

## Simple reconnection reduces rise time of CMOS delay circuit

CMOS gates with their high input impedance can provide large time delays with economical RC circuits. However, the rise time is poor—typically as much as 5% of the total delay time. A simple circuit change reduces the rise time to only about 200 ns—even with delays of several seconds—by eliminating the slow rise of capacitor voltage in the region of the gate’s hysteresis band.

With the conventional circuit (a), voltage  $V_C$  must pass through the hysteresis band before the output attains the full value. However, with the

improved circuit (b)  $V_C$  need only equal the lower threshold voltage of the IC. Then  $V_{OUT}$  begins to go positive; the capacitor stops charging, and  $V_C$  increases to  $V_{DD}$  at a rate determined by the delay time of the IC. The same regenerative effect occurs during a negative transition. An unpolarized capacitor is required for this scheme.

*Charles Murphy, Project Engineer, Logicon, Fairfax, Va. 22030, and Alvaro Quiros, Senior Project Engineer, Pulsecom, Alexandria, Va. 22313. CIRCLE NO. 313*

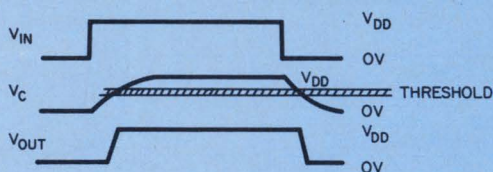
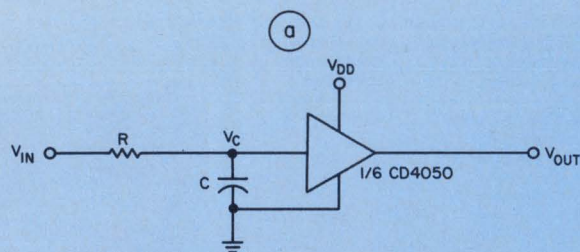

1. Rise times of about 200 ns are obtained from the simple CMOS delay circuit. The slow rise of  $V_C$

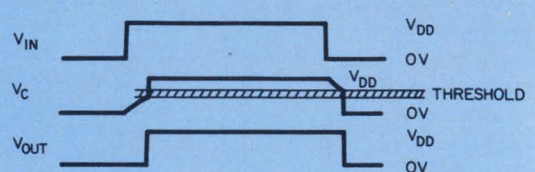
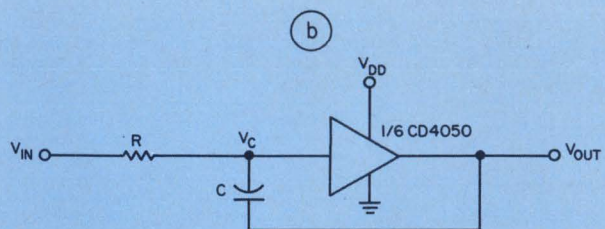

through the gate's threshold (a) is eliminated by the capacitor connection (b).

# Need a DMM with a difference? ...Keithley's got 'em!

Tired of "general purpose" Digital Multimeter performance? Want that something extra that'll make your job easier? Then we've got the Multimeters for you. Take our new 5-1/2 digit,  $10\ \mu\text{V}$  resolution, \$750, ac/dc Model 190...or our new 5-function, 32-range Model 165. It's even got a built-in 1 mA source for semiconductor testing. Then there's our model 171...a real do-it-all DMM.  $4\frac{1}{2}$  digits,  $1\ \mu\text{V}$  resolution, dc volts, ac volts, ac/dc amps, ohms too.

But the Keithley family doesn't end there. We can give you resolution to 30 nanovolts, or let you measure currents of  $10^{-15}$  amp, or resistances to over  $10^{14}$  ohms...we've even got a DMM that has the read-out in a probe.

If you have a job that needs a DMM and then some, we can help. Send for our Digital Multimeter selector guide or call us for a demo now.



Our latest "How sweet it is" proclamation is on a marble base paperweight. It's free when you request a DMM demo. Get one now!



**KEITHLEY  
INSTRUMENTS**  
U.S.A.: 28775 AURORA ROAD, CLEVELAND, OHIO 44139  
EUROPE: 14, AVENUE VILLARDIN, 1009 PULLY, SUISSE

INFORMATION RETRIEVAL NUMBER 68

# Program selects standard resistor values for calculated values when tolerance is given

Resistors and capacitors come in standard values—not the exact values calculated by computer programs—but a simple computer program lets you choose the nearest standard value. Values with 1, 5 or 10% tolerance are chosen to match any calculated value between 1  $\Omega$  and 22 M $\Omega$ .

Three stored arrays of numbers contain the significant digits of the three allowable tolerances. After the selected tolerance is inputted, a scratch array, E\$, is set equal to the corresponding stored array. The program then requests the resistance value and subsequently tests the inputted value to determine the decade. The E\$ array is multiplied by 10 raised to the decade power. A sequential search of E\$ selects the standard value.

After the answer is printed—with units stated in ohms, kilohms or megohms—the program loops back to request additional input. A user response of zero stops the program. Selection of a tolerance other than 10, 5 or 1% causes the program to repeat the request for the tolerance.

The program, written in Super Basic, can be appended to existing programs to obtain standard-value components. The same scheme can also be applied to give standard capacitance values.

Russell L. Gephart, Test Equipment Design Engineer, Spinco Div., Beckman Instruments, 1117 California Ave., Palo Alto, Calif. 94304

CIRCLE NO. 314

```
100 V=2E0
101 DIM E$(13),YS(25),IS(97)
102 MAT READ WS,YS,IS
103 DATA 1,1,2,1,5,1,8,2,2,2,7,3,3,9,4,7,5,6,6,8,8,2,10
104 DATA 1,1,1,2,1,3,1,5,1,6,1,8,2,2,2,4,2,7,3,3,3,6,3,9,
4,3,4,7,5,1,5,6,6,2,6,8,7,5,8,2,9,1,10
105 DATA 1,1,10,2,1,10,5,1,10,7,1,11,1,13,1,15,1,18,1,21,1,24,1,27,1,3,
1,33,1,37,1,4,1,43,1,47,1,5,1,54,1,58,1,62,1,65,1,69,1,74,1,78,1,82,
1,87,1,91,1,96,2,2,10,5,2,1,2,11,2,21,2,26,2,32,2,37,2,43,2,49,2,55
106 DATA 2,6,1,2,6,7,2,7,4,2,8,2,8,7,2,9,4,3,10,3,10,9,3,16,3,24,3,32,3,4,
3,48,3,57,3,65,3,74,3,83,3,92,4,10,4,12,4,22,4,32,4,42,4,53,4,64,
4,75,4,87,4,99,5,11,5,23,5,36,5,49,5,60,5,76,5,9,6,10,6,19,6,34
107 DATA 6,49,6,65,6,81,6,98,7,15,7,32,7,5,7,68,7,87,8,106,8,25,8,45,
8,66,8,87,9,109,9,31,9,53,9,76,10
108 PRINT
109 PRINT"WHAT TOLERANCE IS REQUIRED (10,5,1) ":
110 INPUT AS
111 IF AS=10 THEN STOP
112 IF AS=11 THEN 113 ELSE 116
113 DIM E$(13)
114 MAT E$=WS
115 GO TO 127
116 IF AS=5 THEN 117 ELSE 120
117 DIM E$(25)
118 MAT E$=YS
119 GO TO 127
120 IF AS=1 THEN 121 ELSE 124
121 DIM E$(97)
122 MAT E$=IS
123 GO TO 127
124 PRINT"10%, 5%, OR 1%":
125 GO TO 110
126 PRINT
127 PRINT"WHAT IS RESISTANCE":
128 INPUT B$
129 IF B$=22E6 AND B$>=1 THEN 130 ELSE 151
130 IF B$>=1E11 AND B$<=1E11 THEN CS=1,JS="OHMS",KS=1
131 IF B$>=1E1 AND B$<=1E2 THEN CS=1,JS="OHMS",KS=1
132 IF B$>=1E2 AND B$<=1E3 THEN CS=2,JS="OHMS",KS=1
133 IF B$>=1E3 AND B$<=1E4 THEN CS=4,JS="KILOHMS",KS=1E3
134 IF B$>=1E4 AND B$<=1E5 THEN CS=4,JS="KILOHMS",KS=1E3
135 IF B$>=1E5 AND B$<=1E6 THEN CS=5,JS="KILOHMS",KS=1E3
136 IF B$>=1E6 AND B$<=1E7 THEN CS=6,JS="MEG OHMS",KS=1E6
137 IF B$>=1E7 AND B$<=1E8 THEN CS=7,JS="MEG OHMS",KS=1E6
138 OS=INT(CS
139 MAT E$=(OS)*E$
140 F$=""
141 IF B$=E$(F$) THEN 144
142 F$=F$+1
143 GO TO 141
144 G$=E$(F$)-B$
145 IF F$#1 THEN H$=B$-E$(F$-1) ELSE 147
146 IF (H$<G$) THEN 149
147 PRINT"THE CLOSEST "AS;"% RESISTOR TO "B$;" IS "IES(F$)/KS;" "J$
148 GO TO 108
149 PRINT"THE CLOSEST "AS;"% RESISTOR TO "B$;" IS "IES(F$-1)/KS;" "J$
150 GO TO 108
151 PRINT"YOU MUST PICK BETWEEN 1 OHM AND 22 MEGOHMS."
152 GO TO 108
```

Nearest standard-value resistor is chosen when tolerance and calculated value are entered into the program. Values between 1  $\Omega$  and 22 M $\Omega$  are selected, and the readout is given in units of ohms, kilohms or megohms.

## IFD Winner of Sept. 1, 1973

Sol L. Black, Western Electric, Dept. 355, 6200 E. Broad St., Columbus, Ohio 43213. His idea "Get square-wave tone bursts with a single timer IC" has been voted the Most Valuable of Issue Award.

Vote for the Best Idea in this issue by circling the number for your selection on the Information Retrieval Card at the back of this issue.

**SEND US YOUR IDEAS FOR DESIGN.** You may win a grand total of \$1050 (cash)! Here's how. Submit your IFD describing a new or important circuit or design technique, the clever use of a new component or test equipment, packaging tips, cost-saving ideas to our Ideas for Design editor. Ideas can only be considered for publication if they are submitted exclusively to ELECTRONIC DESIGN. You will receive \$20 for each published idea, \$30 more if it is voted best of issue by our readers. The best-of-issue winners become eligible for the Idea of the Year award of \$1000.

# Fastest.

This new wide band inverting op amp is so fast no other monolithic device can match its speed.

Until now the only way you could obtain the performance speed of our new HA-2530 wide band inverting op amp was with expensive discrete modules. Say at around \$50 each. Now, for far less money you can have it all on

one cost-saving chip. For example, typical slew rate at + 25°C is 320V/μS, settling time (0.1%) is 550nS. No other monolithic op amp can match these speeds. Application range is excellent, too. Among applications are video

summations, high speed integrators, wave form generators, coaxial line drivers, and fast D/A outputs. For details see your Harris distributor or representative.

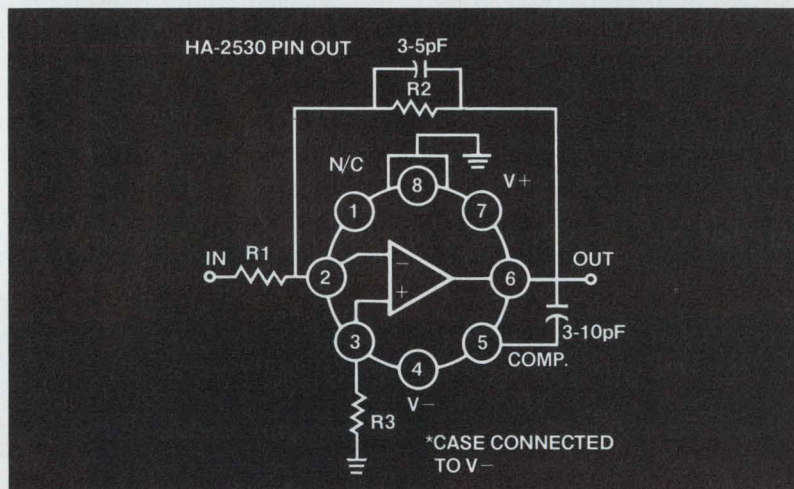

**Features:**

Offset voltage	0.8mV
Average offset voltage drift	5μV/°C
Slew rate	± 320 V/μS
Power bandwidth	5 MHz
Gain bandwidth	70 MHz
Settling time	550nS
Open loop voltage gain	140db
Power consumption	100mW
Supplied	TO-99 pin out
	100-999 units
HA-2535	
0°C to +70°C	\$14.30
HA-2530	
-55°C to +125°C	\$33.00

# Harris



**HARRIS**  
**SEMICONDUCTOR**  
 A DIVISION OF HARRIS-INTERTYPE CORPORATION

P.O. Box 883, Melbourne, Florida 32901  
 (305) 727-5430

**WHERE TO BUY THEM:** ARIZONA: Phoenix—Liberty, Weatherford; Scottsdale—HAR (602) 946-3556 CALIFORNIA: Anaheim—Weatherford; El Segundo—Liberty; Glendale—Weatherford; Long Beach—HAR (213) 426-7687; Mountain View—Elmar; Palo Alto—Weatherford, HAR (415) 964-6443; Pomona—Weatherford; San Diego—Liberty COLORADO: Denver—Elmar, Weatherford WASHINGTON, D.C.: HAR (202) 337-3170  
 FLORIDA: Hollywood—Schweber, Hamilton; Melbourne—HAR (305) 727-5430 GEORGIA: Atlanta—Schweber ILLINOIS: Chicago—Schweber; Schaumburg—HAR (312) 894-8824; Schiller Park—Hamilton INDIANA: Indianapolis—Pioneer KANSAS: Lenexa—Hamilton MARYLAND: Baltimore—Hamilton; Rockville—Schweber MASSACHUSETTS: Lexington—R&D; Waltham—Schweber; Wellesley—HAR (617) 237-5430 MICHIGAN: Livonia—Hamilton; Troy—Schweber MINNESOTA: Edina—Hamilton; Minneapolis—Schweber, HAR (612) 432-6111 MISSOURI: Hazelwood—Hamilton NEW JERSEY: Cedar Grove—Hamilton; Mt. Laurel—Hamilton; Somerset—Schweber NEW MEXICO: Albuquerque—Weatherford NEW YORK: Melville—HAR (516) 249-4500; East Syracuse—Hamilton; Syracuse—HAR (315) 463-3373; Rochester—Schweber; Westbury—Schweber  
 NORTH CAROLINA: Raleigh—Schweber OHIO: Beachwood—Schweber; Cleveland—Pioneer; Dayton—Pioneer, HAR (513) 226-0636 PENNSYLVANIA: Wayne—HAR (215) 687-6680 TEXAS: Dallas—Hamilton; Weatherford, HAR (214) 231-9031; Houston—Weatherford WASHINGTON: Seattle—Liberty, Weatherford.

**LEGEND FOR HARRIS SALES OFFICES & DISTRIBUTORS:** Harris Semiconductor (HAR); Elmar Electronics (Elmar); Hamilton Avnet Electronics (Hamilton); Harvey/R&D Electronics (R&D); Liberty Electronics (Liberty); Pioneer Standard Electronics (Pioneer); Schweber Electronics (Schweber); R.V. Weatherford Co. (Weatherford); Western Radio (Western).

## High-density memory cell has but a single transistor

An experimental single-transistor memory cell with a storage density of 1600 bits/mm<sup>2</sup> has been developed by Siemens of West Germany. Previously dynamic semiconductor memories in which the information is stored as a charge in a capacitor used three-transistor cells, and the storage density with conventional photo-etching technology was up to 900 bits/mm<sup>2</sup>.

The new memory, which measures 20 by 31  $\mu\text{m}$ , consists of an n-silicon-gate select transistor and a silicon-gate storage capacitor constructed with the aid of an inversion layer. The cell incorporates aluminum word lines with a width and separation of 5  $\mu\text{m}$ , diffused bit lines with a width of 4  $\mu\text{m}$ , and a contact hole from the word line to the silicon gate measuring  $4 \times 6 \mu\text{m}$ . The storage capacity of the cell is expressed as 55 femto farads (1 femto farad (fF) =  $10^{-15}$  As/V).

The cell also features regenera-

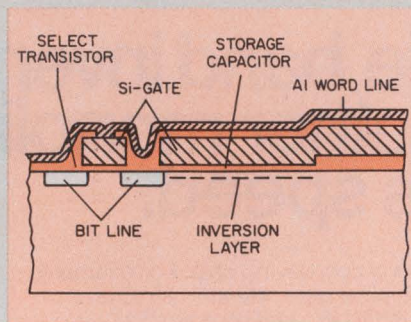

Single-transistor memory cell has a storage density of 1600 bits/mm<sup>2</sup>.

tive circuits that are integrated with the memory cells. These circuits are provided for analysis of the signal voltages—about 1 V in destructive readout—and one circuit can be used for 256 memory cells.

Siemens expects to design memory chips with capacities of up to 16 kilobits/chip with these memory cells and the regenerative amplifiers.

## YIG-tuned oscillator covers 4-to-8-GHz range

A C-band, YIG-tuned Gunn-diode oscillator has been developed by the Sanders Div. of Marconi Instruments Ltd. in England. It covers a frequency range from 4 to 8 GHz and provides a minimum power output of 25 mW across the band. The device has a modified magnetic circuit that is said to consume less drive power and to give minimal hysteresis.

Until now, frequency coverage of YIG-tuned oscillators (in which the yttrium-iron-garnet sphere acts as the equivalent of the tuned cavity in a conventional microwave oscillator) has been limited to less than one octave. Units with a range of 3.5 to 8.5 GHz may be built in the near future, according to Sanders.

Basic problems include: fabrication of suitable Gunn diodes, design of an oscillator circuit that could provide a conjugate match for the Gunn-diode impedance over a wide frequency range, provision for a suitable thermal circuit and the design of a low-hysteresis magnetic circuit.

CIRCLE NO. 195

## Power needs forseen by computer program

A computer program that anticipates future power requirements is in use at the Newag-Theiss power station in Austria.

One step ahead of energy customers, the program—developed by Schrack-Automatisierungs-GmbH—evaluates readings from environmental sensors for air and water temperatures, daylight brightness and humidity. The date is also entered. The program keeps the power output at anticipated levels.

change occurs outside preset limits, so the prototype engine is saved from destruction. The reason for failure can also be determined, as the system provides a second-by-second analysis of the preceding half hour.

The new equipment is to be installed at Ford's Research Center in Dunton, Essex, England.

## Wristwatch planned with one CMOS chip

A quartz oscillator circuit for wristwatches—with all the CMOS components on one silicon chip—is under development by the Sescosem Div. of Thomson-CSF in France. Complementary MOS is used for frequency-dividing because of its low power dissipation.

The new chip contains the oscillator, divider and interface circuits. A passive charge inverter decreases supply-voltage requirements. The p-channel transistor gate in the circuit is connected to zero voltage.

## Computer-based test bed monitors six engines

A computer-controlled, engine test bed has been devised that can monitor automatically up to six diesel or gasoline engines simultaneously. The developers are Ford Motor Co. and London University's Queen Mary College, both in England.

The test bed—based on a General Automation SPC 16-45 mini-computer with 16 k of core store—will monitor 22 parameters on each engine and check such items as oil levels and exhaust emission.

The test stops at once if any

Always select the best materials...assure your product's performance, reliability and profitability

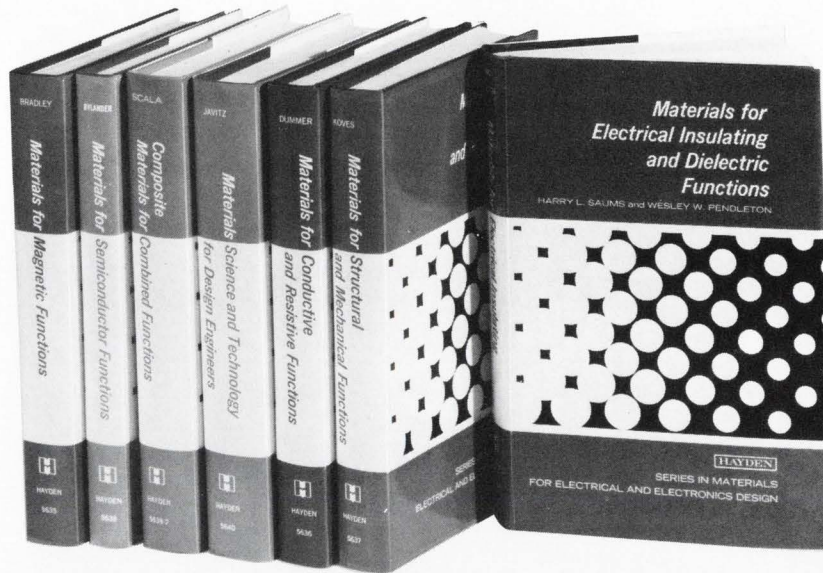

## Hayden Series in Materials for Electrical and Electronics Design

ALEX. E. JAVITZ, *Editor-in-Chief*

Practical design references specifically planned to help you and your colleagues meet the challenge of proper materials selection on all fronts. These volumes place at your disposal the concepts, data, and techniques you need to:

- understand how fundamental properties of materials affect their ultimate performance.
- exploit the potential of advanced materials.
- make optimum use of conventional materials.
- use the latest techniques in processing, fabrication, test and measurement.
- specify materials that resist environmental damage.
- guard against misuse of materials that may be hazardous or produce pollutants.

**All books are 6 x 9, illustrated,  
cloth editions and include:**

### MATERIALS SCIENCE AND TECHNOLOGY FOR DESIGN ENGINEERS

(An interdisciplinary volume surveying the entire spectrum of design considerations) 560 pp., #5640-0, \$23.95.

### MATERIALS FOR ELECTRICAL INSULATING AND DIELECTRIC FUNCTIONS

352 pp., #5634-6, \$21.95.

### MATERIALS FOR SEMICONDUCTOR FUNCTIONS

220 pp., #5638-9, \$13.50.

### COMPOSITE MATERIALS FOR COMBINED FUNCTIONS

392 pp., #5639-7, \$14.95.

### MATERIALS FOR MAGNETIC FUNCTIONS

360 pp., #5635-4, \$14.95.

### MATERIALS FOR STRUCTURAL AND MECHANICAL FUNCTIONS

360 pp., #5637-0, \$13.95.

### MATERIALS FOR CONDUCTIVE AND RESISTIVE FUNCTIONS

360 pp., #5636-2, \$13.95.

**Review any of these books  
on 15-day free examination!**

Please send the book(s) checked on 15-day free examination. At the end of that time, I will remit payment plus postage, or return the book(s) with no further obligation.

- |                                 |                                 |                                 |
|---------------------------------|---------------------------------|---------------------------------|
| <input type="checkbox"/> 5640-0 | <input type="checkbox"/> 5635-4 | <input type="checkbox"/> 5638-9 |
| <input type="checkbox"/> 5636-2 | <input type="checkbox"/> 5637-0 | <input type="checkbox"/> 5639-7 |
|                                 |                                 | <input type="checkbox"/> 5634-6 |

### Save Money!

Payment Enclosed. Publisher will pay all shipping and handling charges. Same 15-day return privilege and full return if not satisfied.

Name \_\_\_\_\_

Firm \_\_\_\_\_

Address \_\_\_\_\_

City/State \_\_\_\_\_ Zip \_\_\_\_\_

ISBN Prefix 0-8104

**HAYDEN BOOK COMPANY, INC.**  
50 Essex Street, Rochelle Park, N.J. 07662

73-72

# Reliability is staggered steps and a hunk of DAP

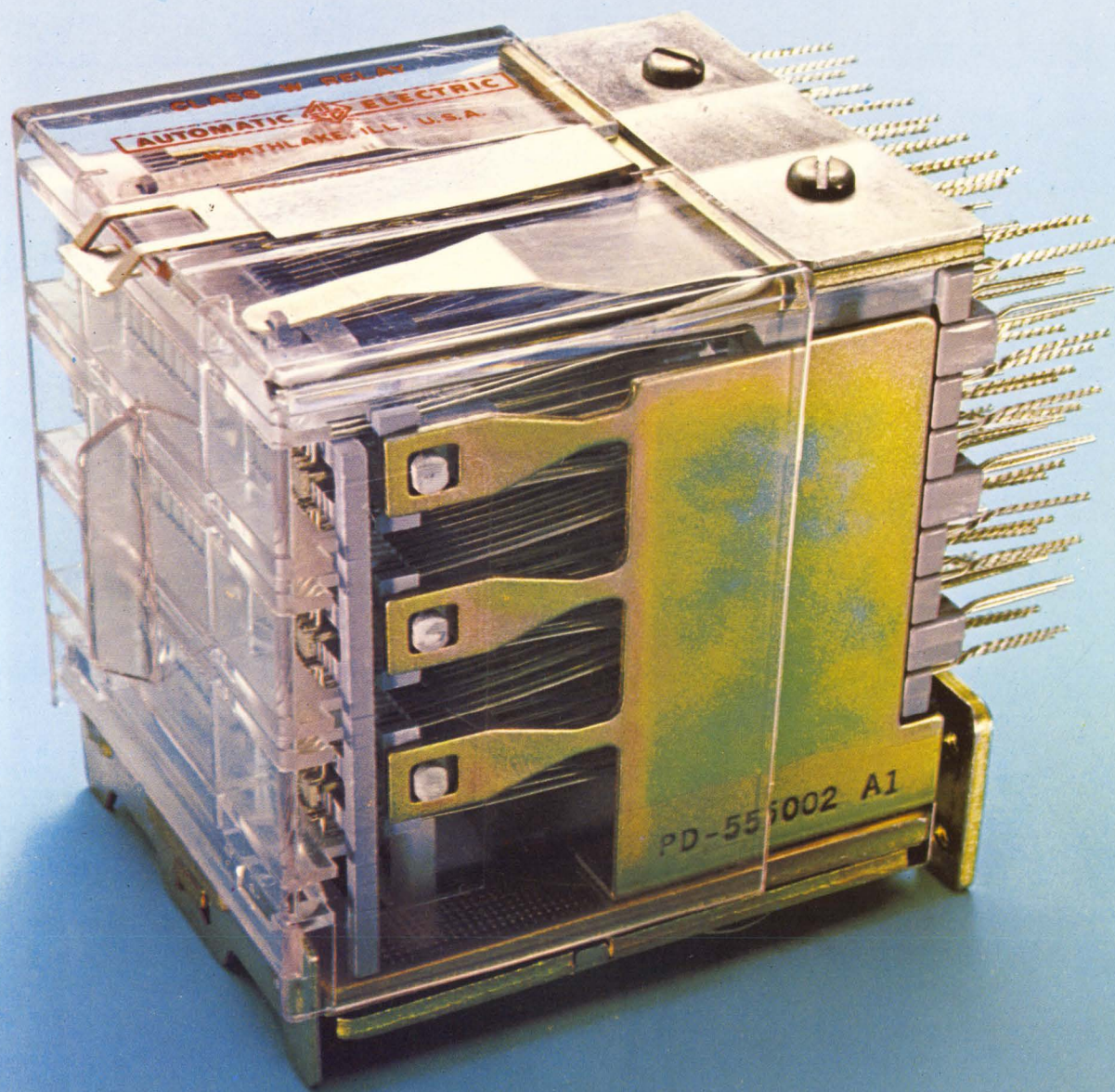



## Expect over a billion operations.

Our Class W wire-spring relay is different. In fact, there's nothing like it in the entire industry. Where else can you find a relay with lots of contacts and a mechanical life of more than a billion operations! That's about two and a half times the life of the best conventional relay around.

Another nice thing about our Class W is that it takes up a lot less space and costs less than using a bunch of other relays. That's because we build our Class W relay with one, two or three levels of contact assemblies, with 17 form C combinations per level. By the way, they're available with gold contacts for low-level switching.

## Making it tough on creepage.

All those staggered steps you see on the side were put in to raise the breakdown voltage between terminals. These molded steps add extra creepage distance between the terminals. This really counts for high voltage testing, or when using our Class W in unfavorable ambient conditions.

These steps, and all the molding compound used for insulating the contact springs, are made from

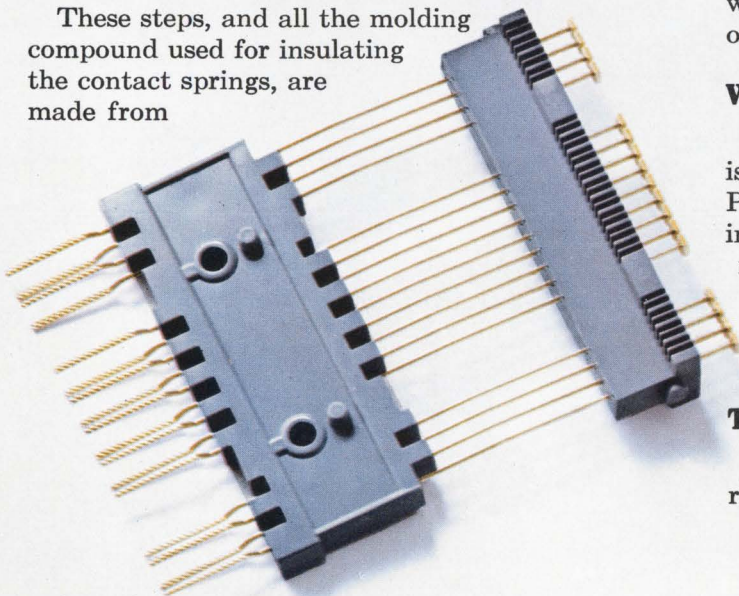

diallyl phthalate. (They call it DAP for short.) It has great insulating properties and it wears like iron. Even if the humidity is high, you have excellent protection.

## Redundancy—two springs are better than one.

Each of our long wire-spring contacts has an independent twin with the same function. One tiny particle of dust could prevent contact on other relays. Not with our Class W. You can be sure one of the twins will function. That's back-up reliability.

The twin contacts are twisted together at the terminal end. Then we give them a spanking (you might call it swedging) to provide solderless wrap.

## We're for independence.

Our springs are longer, because the longer the spring, the more independent they get. And the better contact they make. Don't forget, the wire-spring relay is the most reliable way to get a permissive make or break contact. You can rely on it.

The middle contact springs have to be stationary. To make sure they stay that way forever, we actually mold them between two thick pieces of DAP on both ends. Just try to move one.

## When we say flat, it's flat.

Each frame, banged out by a gigantic machine is extra thick and extra flat. Then they're planished. Planishing is another step we go through in forming the frame to add strength and stability by relieving surface strain.

We've made our spring-loaded pile-up clamp extra thick, too. Once it's tightened down, the whole pile-up is nice and tight, and stays tight.

## There's more.

We could tell you a lot more about our Class W relays. Like how the tough high-temp molded

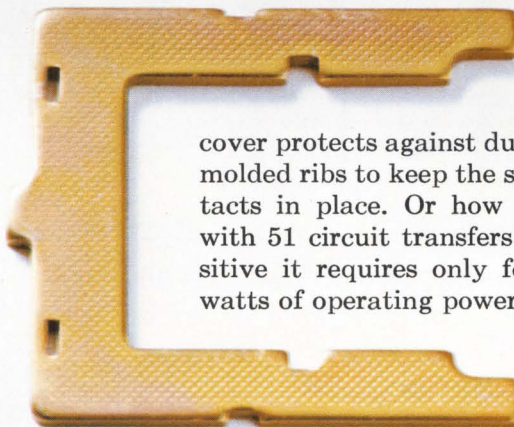

cover protects against dust and has molded ribs to keep the spring contacts in place. Or how this relay with 51 circuit transfers is so sensitive it requires only four to six watts of operating power.

But why don't you let us prove how much reliability we put into our Class W? We'll be waiting to hear from you. GTE Automatic Electric, Industrial Sales Division, Northlake, Ill. 60164.

# GTE AUTOMATIC ELECTRIC

# Simple Solution to SSB/AM Transceiver Problems

## Radio Communications IC's from PLESSEY

Put Plessey's SL600 series together. You have all the circuits to design an 60MHz SSB/AM transceiver. For military or commercial applications. Without any hassle.

Functionally integrated, these fully-compatible circuits replace troublesome discrete components 30 to 1. For less time and money. Yet with better reliability and performance than you thought possible.

Or use each circuit separately. The SL600 series includes a comprehensive range of IF and RF amplifiers with full AGC and bandwidths to 140MHz. VOGAD, audio and AGC amplifiers are available too. Plus double balanced modulators and mixers with carrier leaks as low as -60db. All operating with low power consumption from a single 6 volt supply . . . over a temperature range of -55°C to +125°C.

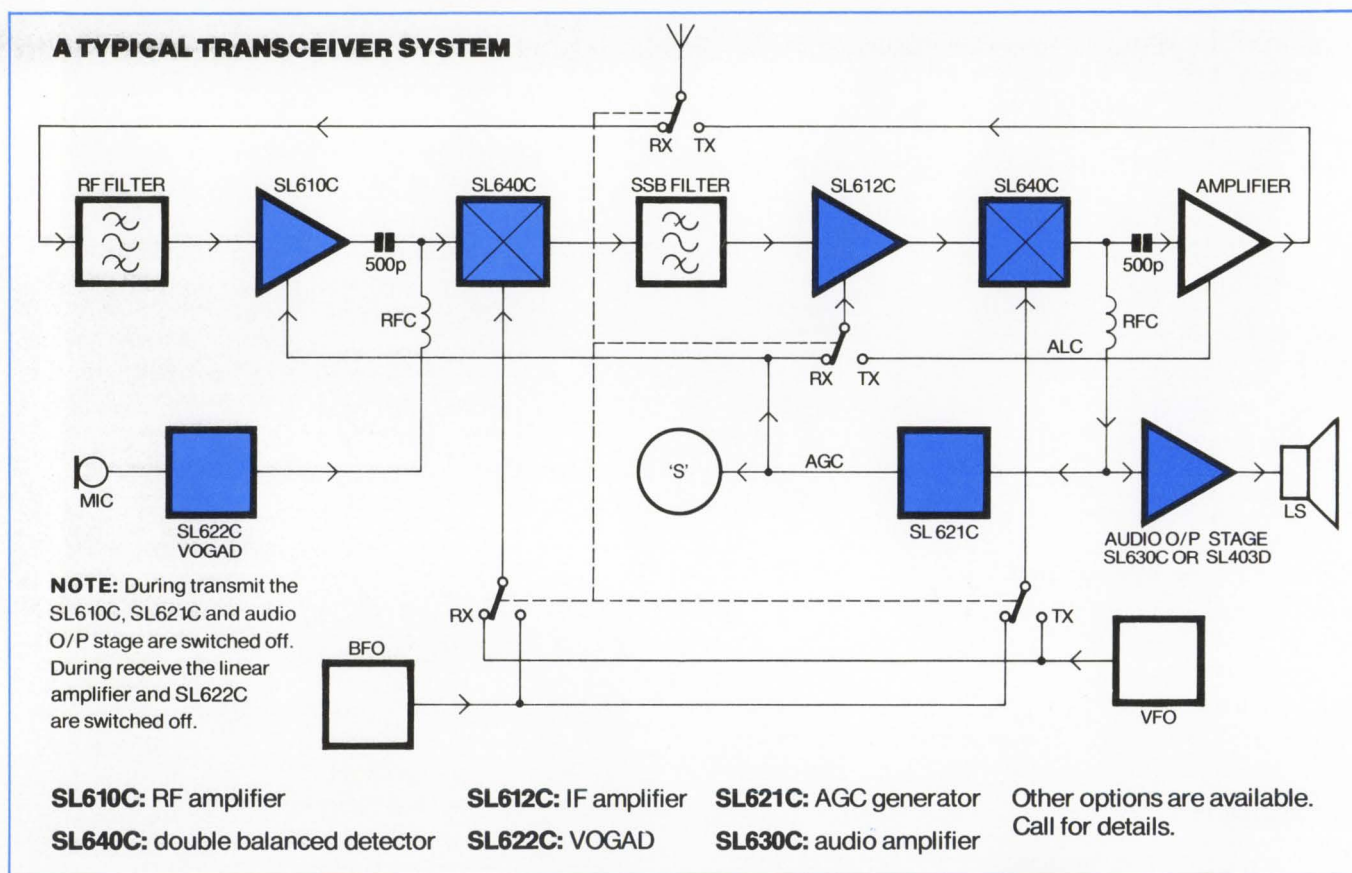

### FREE APPLICATIONS MANUAL

Ask for all the facts in our 56-page problem-solving applications manual on integrated circuits for radio communications. Call today. Or write to Plessey on your company letterhead. **You'll find it pays to specify Plessey.**

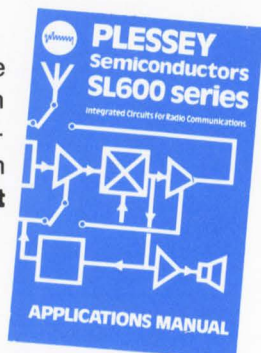

## PLESSEY SEMICONDUCTORS

1674 McGaw Avenue, Santa Ana, California 92705  
(714) 540-9945

170 Finn Court, Farmingdale, New York 11735  
(516) 694-7377

Dial (800) 645-9200 toll free  
for name of local representative.

## new products

# Low-cost data converters provide 0.01% linearity

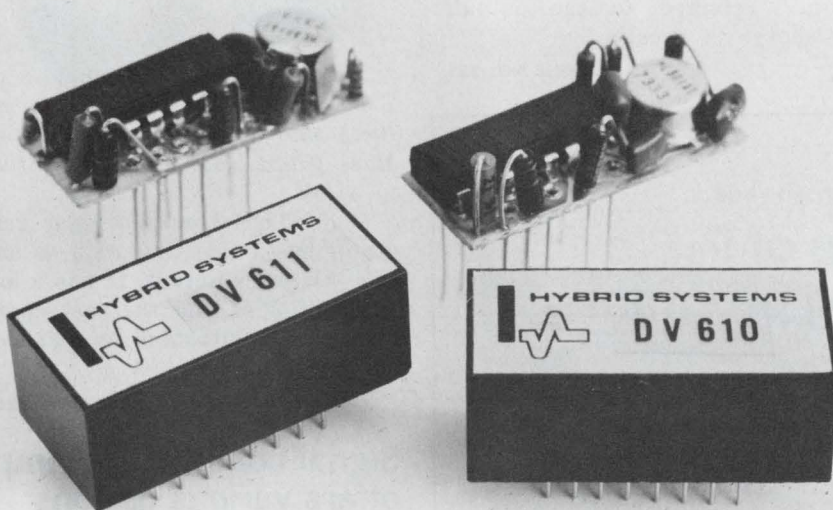

Hybrid Systems Corp., 87 Second Ave., Burlington, Mass. 01803. (617) 272-1522. \$39 (1 to 9); stock.

Low-cost data conversion with relatively high linearity is here. The Deltaverta modules from Hybrid Systems Corp. can convert analog data into digital or vice versa. The Model DV 610 encoder and DV 611 decoder cost only \$39 each. In contrast, voltage-to-frequency converters, useful in similar applications, cost several times as much.

The DV 610 encoding module accepts analog input voltages from 0 to  $-10$  V and needs a TTL clock. The encoder performs what is essentially a voltage-to-pulse rate conversion with a linearity of 0.01%—equivalent to a 12-bit a/d converter. The drift with temperature is 30 ppm/ $^{\circ}$ C over an operating temperature range of 0 to 70 C. Input impedance for the 610 is greater than 10 k $\Omega$ .

The DV 611 decoding circuit takes the pulse-rate digital signals from an encoded data train and converts the signals back to analog form. The major difference between the 611 and the 610 is in their output characteristics. The output impedance of the 611 is less than 0.1  $\Omega$  but it can deliver a

signal of 0 to  $-10$  V at 10 mA into its rated load.

Both units are designed to fit into a 16-pin DIP socket. The size of either module is only 1.4  $\times$  0.6  $\times$  0.5 in. Their power-supply drain is 10 mA at +15 V and 5 mA at  $-15$  V. They both have a power-supply rejection ratio of 0.001%/.

Input clock frequencies from 5 to 200 kHz can be used, but the linearity deteriorates from the nominal 0.01% as the frequency increases. This deterioration is caused by the internal frequency compensation of the converter amplifiers.

The Deltaverta encoding and decoding circuits use delta-sigma modulation to provide a means of transmitting multiplexed digital data over two or three-wire lines. For instance, aside from the encoding circuit, all that's needed to build a complete a/d converter system are counters to accumulate pulses and a few gates. The encoding circuit can even be placed at some distance from the counters—closer to the signal source, say, to reduce line noise pickup. And since the transmitted signal is digital, there is almost no distortion caused by noise.

CIRCLE NO. 252

## Data translator helps encode analog signals

Crypto Industries, P.O. Box 23163, San Diego, Calif. 92123. (714) 224-0224. \$385.

The Model 215 analog data translator used in conjunction with the firm's Model 213 crypto generator provides a means of secure analog data transmission and reception. In the transmit mode the translator accepts a 0 to 10.0 V analog input signal, digitizes it to a selectable resolution of 2 to 8 bits with up to 200,000 samples per second and provides a serial digitized output of the analog input. This digital signal can now be encrypted by the Model 213, transmitted and then be decoded and retranslated back to analog data by another Model 213 and 215 pair. Operating mode of the Model 215 is slaved to the mode of its associated crypto generator. A clock input that must be common to both units generates an encryption bit for each output bit of the translator. Power requirements of the translator are 5 V at 400 mA, +15 V at 80 mA and  $-15$  V at 40 mA—all  $\pm 5\%$ . The unit operates over a 0 to 50 C temp range and is housed in a 4.625  $\times$  3  $\times$  0.85 in case.

CIRCLE NO. 253

## Coordinate converter has wide versatility

Optical Electronics, Inc., P.O. Box 11140, Tucson, Ariz. 85734. (602) 624-8358. \$170 (10-up); stock.

The Model 5762B is a coordinate converter that has angle and radius input and delivers the sine and cosine radius product. It can be used to convert from polar to Cartesian coordinates in PPI displays, circular scan displays, helical scan displays and for rotating coordinates in various displays and analog computational applications. The 5762B is in a 3.125 by 2.625 by 0.625 in. module and features:  $\pm 0.5\%$   $\pm 5$  mV maximum error at output,  $\pm 10$  V full scale inputs and outputs, dc to 300 kHz frequency response, dc to 15 kHz large signal bandwidth and a  $-55$  C to  $+85$  C operating temperature range. Power requirements are  $\pm 15$  V at  $\pm 35$  mA.

CIRCLE NO. 254

## MODULES & SUBASSEMBLIES

### Shock amplifier uses piezoresistive front end

Endevco Dynamic Instrument Div., 801 S. Arroyo Pkwy., Pasadena, Calif. 91109. (213) 681-2401.

The Model 2740 shock amplifier furnishes digital rather than analog information. It gives a digital readout in g's, of both pulse peak amplitude and width. With the Model 35364 piezoresistive front

end, it can provide the same information from piezoresistive accelerometers. Frequency response of the amplifier, when using the conditioner, is 0.1 Hz to 50 kHz  $\pm 5\%$ , unless limited by selections of the internal high-pass and low-pass filters. Excitation voltage is 5 or 10 V, front end selectable. Residual noise is rated at less than 15  $\mu\text{V}$  rms referred to the input, or 5 mV referred to the output, whichever is greater.

CIRCLE NO. 255

### Pulse trigger generator gives fast signals



To be Deutschman Laboratories, Inc., 550 Turnpike St., Canton, Mass. 02021. (617) 828-3366. Stock to 4 wk.

Model TGE-2 pulse/trigger generator has a rise time of 5 ns and a 50 kV pulse output. It has a low jitter of 3 ns and the cast epoxy housing will withstand severe shock and vibration.

CIRCLE NO. 256

### When a standard switch won't do... take advantage of P&B's free engineering program



After you've seen the standard switches and still can't find what you need, call us. P&B offers unique design and manufacturing capabilities in actuator assemblies, push buttons and pneumatic actuated units. From dry circuit to 25 amps. And, there's no charge for reasonable initial engineering services and samples.

Besides the more common actuating assemblies, special P&B designs can include push on/push off, rocker maintain, rocker momentary, bar lever, air cylinders, relays, rotary, and many more. P&B was the first to qualify with U/L TV rated switches.

For help with your switch problem, call your P&B representative or write Potter & Brumfield Division AMF, Princeton, Indiana 47670. 812 385 5251.

**AMF**  
**Potter & Brumfield**

### Signal conditioning amp offers various options



Sensotec Inc., 1400 Holly Ave., Columbus, Ohio 43212. (614) 294-5436. From \$365; stock.

The Series 5 Model SCA-5 signal conditioner handles outputs from strain gauges. Built into the unit is a single channel peak or track-and-hold detector and a strain gauge bridge power supply. The amplifier is housed in a 1.75  $\times$  4  $\times$  11.125 in. case, complete with power cord and MS type input and output connectors. Plug-in functions available as options are: TPS-5 card with high and low limits and the TPST-5 process control card with high and low limits and threshold, logic, or high current outputs.

CIRCLE NO. 257

# AVX backs a low-cost EMI filter with a multi-million dollar capability



Men, methods and machines are what make AVX ceramic EMI filters truly great. That's AVX capability in a nutshell. Add to that our recent acquisition of the Potter Company California Operations with its widely accepted line of filters and that's real capability.

The heart of a filter's performance is its ceramic capacitor element. And no one knows ceramic capacitors better than AVX.

A search by AVX for the perfect ceramic for capacitors led to the development of the CERALAM®

process. AVX uses the same techniques which proved so successful in billions of AVX-produced capacitors. This identical, stable monolithic block is used in AVX ceramic filters. It is responsible for attaining the highest quality and uniformity of characteristics in the industry. So — specify AVX ceramic filters. There are none better.

Write for AVX's new Filter Catalog FC-73.  
AVX Ceramics Western Operations, 10441 Roselle St.,  
San Diego, California 92121. Telephone: (714) 453-6610.



**THE** CERAMIC FILTER MANUFACTURER

INFORMATION RETRIEVAL NUMBER 75

## Signal conditioners offer many options

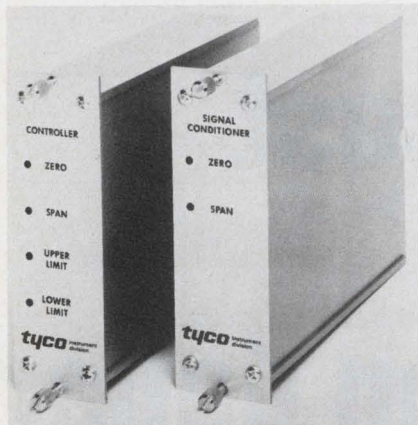

Tyco Instrument, 4 Hartwell Pl., Lexington, Mass. 02173. (617) 861-7450.

The Series 100 signal conditioners and the Series 200 controllers interface with strain-gauge pressure transducers, load cells, or transmitters and indicators, recorders, controls, and alarms. The units amplify the low-level transducer output, producing either voltage or current. There are models available for ac or dc line operation, output signals up to 10 V, current outputs of 4 to 20 mA, zero and span controls, and, in the Series 200 controllers, single and dual set point contacts and set point indicators.

CIRCLE NO. 258

## Analog signal mux includes a/d converter

Media III, 2454 E. Fender Ave., Fullerton, Calif. 92631. (714) 870-7660. \$6675 (128 channels).

The Model 1510-400 is a self-contained, analog signal multiplexer/analog-to-digital converter. It is designed for use in hard-wired and computer controlled data logging and process control systems. Up to 128 channels of three-wire analog input switching are contained in a single 7-in. high rack mountable chassis. A maximum of 32 chassis can be bussed for a total analog input capability of 4096 points. The unit offers conversion resolutions of up to 14-bits, sampling rates of up to 20 kHz, automatic zero offset correction and programmable gain over the ranges of  $\pm 10$  mV to  $\pm 10$  V full scale.

CIRCLE NO. 259

## VCXO provides good low noise performance

Damon Corp., 80 Wilson Way, Westwood, Mass. 02090. (617) 449-0800.

Model 6889WA voltage controlled crystal oscillator has low noise characteristics. The 30 MHz VCXO is available with the following noise specifications: for  $f_0$ ,  $\pm$ (kHz), 0.05, .5, 1, 10 and 50; the dB-Hz values are 105, 132, 138, 148 and 150, respectively. Other specifications include a frequency deviation of  $\pm 1$  kHz, a linearity of  $\pm 1\%$  of best straight line and a modulation rate of dc to 10 kHz.

CIRCLE NO. 260

## Hybrid 12-bit DAC is laser trimmed

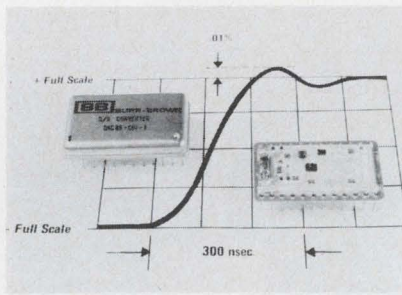

Burr-Brown Research Corp., International Airport Industrial Park, Tucson, Ariz. 85706. (602) 294-1431.

The DAC85 hybrid IC 12-bit d/a converter has laser trimmed linearity to  $\pm 1/2$  LSB and its own internal reference and output amplifier. All this in a hermetically sealed 24-pin DIP. Two fast settling models are available. The DAC85C provides nonlinearities of  $\pm 0.024\%$  over a 0 to 70 C temperature range. The DAC85 offers nonlinearities of  $\pm 0.012\%$  over an extended temperature range of  $-25$  to  $+85$  C. Both models are offered with a choice of current or voltage output. Voltage output models settle to  $\pm 0.01\%$  in 5  $\mu$ s, and current output models settle to  $\pm 0.01\%$  in 300 ns. Gain drift for the DAC85C is  $\pm 15$  ppm/ $^{\circ}$ C and  $\pm 10$  ppm/ $^{\circ}$ C for the DAC85. Optional features include binary or BCD codes, +5, +10,  $\pm 2.5$ ,  $\pm 5$  or  $\pm 10$  V output voltage ranges and current output options.

CIRCLE NO. 261

# more relay per DIP

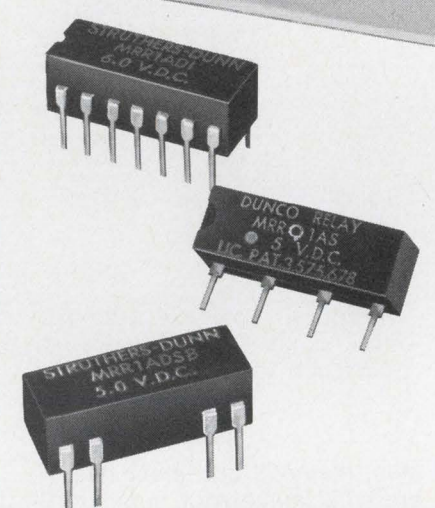
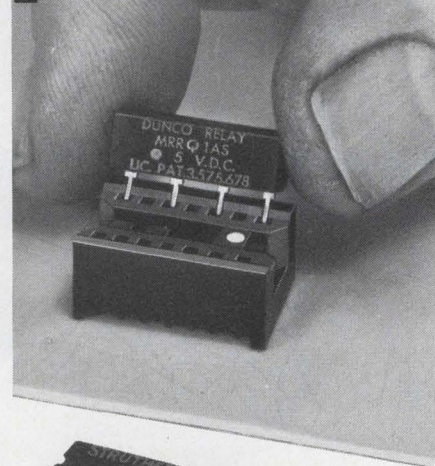

**DIP Reed Relays Offer More** switching versatility than ever and in so little space. Two MRRQ relays even fit side by side in a single 14 pin DIP socket. And that's just a start on what we cram into 4, 8, or all 14 pins. We now have Form B, Form C, up to two 10 VA Form A switches and coils for all logic systems—5, 6, 12, or 24 volt. There's even a new 2-coil latching model.

For details on this expanding line of DIP dry reed relays circle reader service card for our 1974 complete Relay Catalog. As a bonus you'll learn more about one of the world's largest lines of reed, electromechanical, hybrid, and solid state relays, plus our solid state programmable controllers.



**STRUTHERS-DUNN, INC.**  
Pitman, New Jersey 08071  
Canada: Struthers-Dunn Relay Div.,  
Renfrew Electric Co. Ltd.

# relays renewed

## 2 HANDED DEADMAN'S THROTTLE

OSHA should be happy with this foolproof interlocked switching circuit that occupies both hands of a machine operator. The Run switch of Fig. 1 can't be simply taped closed, it must be cycled after each "Stop" of the "Forward-Stop-Reverse" Traverse switch.

Almost any combination of electromechanical or reed relays can be used since most contacts switch other control relays. Depending upon the size of motor starter MSF, control relays CRA and CRD could be S-D Frames 283, MRRN, or 314. For TCRB a modification of our Frame 236 would make an excellent choice.

Thanks to B.C.M., Nazareth, Pa. for this idea which he suggests for overhead cranes to insure that the operator keeps both hands inside the cab and on the controls.

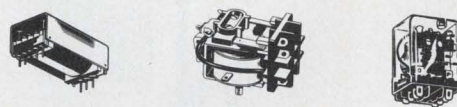
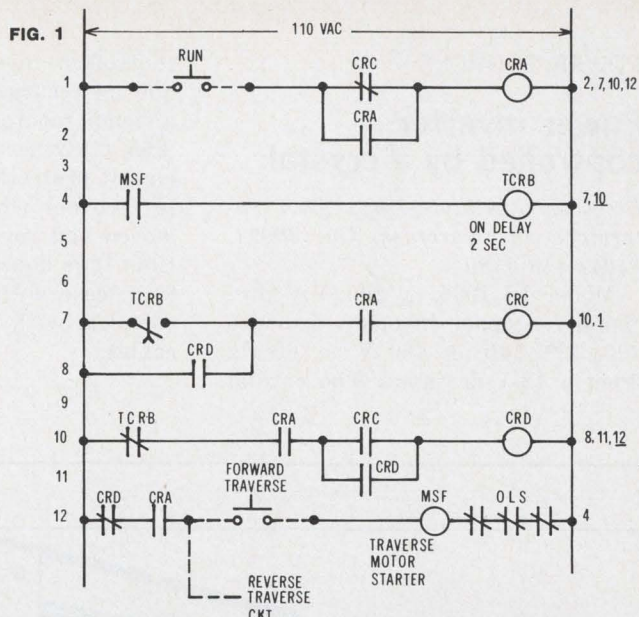

Here are just two of more than 800 relay applications submitted during Struther's-Dunn's 50th Anniversary Relay Contest last year. These thought starters are a small sample of the endless possibilities for relay-operated systems.

## RELAY GUARDS SPRING-OPERATED MECHANISM

Here's a device that actually operates a conventional relay both electrically and mechanically. Its use of spring-stored energy may have other applications where a mechanical operation is needed without power or with only a local standby power source. Now used on stored energy operators of oil circuit breakers, this suggestion comes from F.L. of Foxboro, Ma.

The gear reduction motor of Fig. 2 charges a spring in one revolution of its output shaft. With the spring fully charged, a cam mechanically actuates the control relay into the energized position. As Fig. 3 shows, CR1 then stops the motor while CR2 readies a solenoid circuit that can delatch the spring whenever required. When the spring discharges, the cam "unlatches" the relay and the motor starts recharging the spring. A failure elsewhere in the mechanism operates a contact that electrically energizes the control relay and stops the motor to prevent damage from repetitive spring discharges.

Relays such as S-D Frames 314, B1, 425, 219, are only a few of many types suited for such an arrangement. The choice depends largely on mounting requirements and number of poles required.

FIG. 2

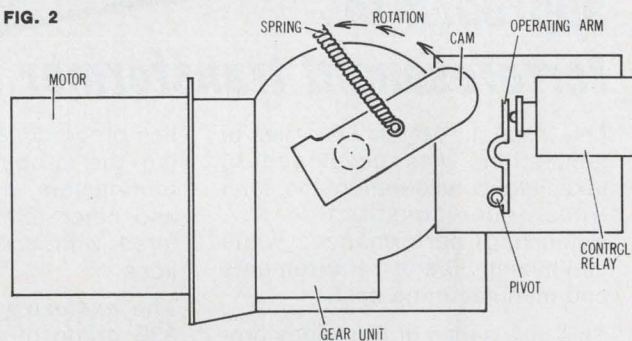
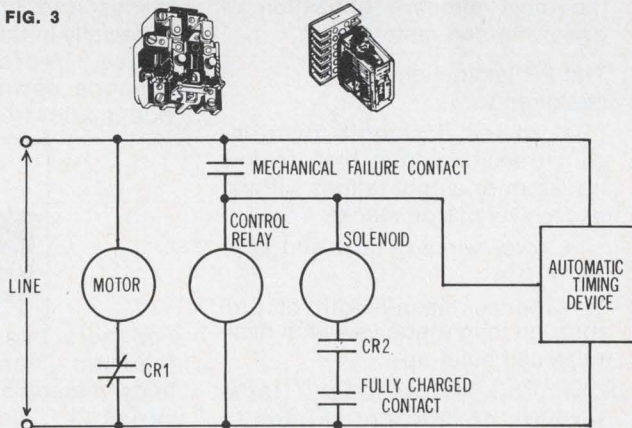

FIG. 3



**STRUTHERS-DUNN, INC.**

PITMAN, NEW JERSEY 08071

Canada: Struthers-Dunn Relay Div., Renfrew Electric Co., Ltd.

1974 Catalog includes over 100 basic relay types —EM, Reed, Hybrid, Solid State plus solid state programmable controllers. Circle reader service card number for your copy.



## POWER SOURCES

### Power inverter controlled by a crystal

Electronics-Atlanta Inc., 2275 Interstate 85, Norcross, Ga. 30071. (404) 448-9380.

Model PI-1003, a 200 VA precision frequency inverter, provides 100, 120, 140, or 160 V ac, 60 Hz from a 12-V-dc input. The crystal

controlled inverter offers a frequency accuracy of  $\pm 0.005\%$  over a temperature range of  $-40$  to  $+55$  C. Other features are short-circuit protection that automatically recovers when the short is removed and reverse polarity protection. It is housed in a  $5.1 \times 5.7 \times 8$  in. case with a carrying handle, complete with a set of 6 ft battery cables.

CIRCLE NO. 262

### Multiple output supply includes digital meter

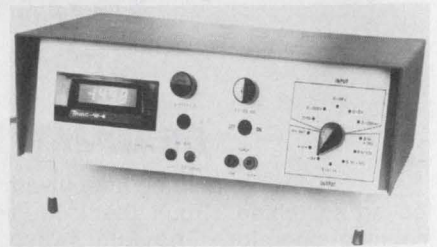

Technical Hardware Inc., P.O. Box 3609, Fullerton, Calif. 92634. (714) 870-1882. VS-200: \$395.

The VS-200 has five power supplies plus a digital voltmeter in one cabinet. The power supplies consist of a  $\pm 15$  V, 100 mA; a  $\pm 0$  to 20 V, 200 mA adjustable and a 0 to 200 mV, 10 mA reversible polarity supply. Other power supplies can be added to the same instrument. An integral 3-1/2 digit liquid crystal voltmeter can be used to monitor the output of any power supply. The VS-200 also can function as a digital voltmeter.

CIRCLE NO. 263

## a NEW approach to ferroresonant transformer design

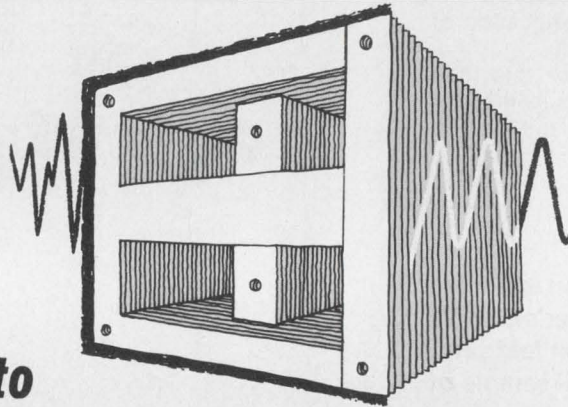

The Magnetic Metals FR series of laminations was developed to take into consideration the total transformer construction . . . optimizing performance, while minimizing space requirements and manufacturing cost.

This new series of EI shapes provides the utmost in versatility and the most effective utilization of grain-oriented materials.

The FR laminations are designed to:

- provide a smooth overlapping transition from high to low transformer output ratings without excessively large stacks
- lower winding time and copper costs
- reduce mean-length of turn through long windows which minimize coil build-up
- allow ferroresonant transformers of different ratings to have a family resemblance because of the similarity of lamination

proportions . . . thus eliminating the problems of changing form-factors, winding proportions, and other relationships encountered with conventional laminations.

The exclusive Magnetic Metals 33B grade of grain-oriented silicon steel provides relatively low losses and high permeability, especially in the saturated region. These improved properties enhance performance and provide greater freedom of design.



For more information on Ferroresonant Transformer Laminations, materials and shunts for FR series . . . contact your local Magnetic Metals Representative or write for our new catalog to:

**MAGNETIC  
METALS**

Hayes Avenue at 22nd Street, Camden, N. J. 08101 • (609) 964-7842

### Programmable supply delivers dual outputs

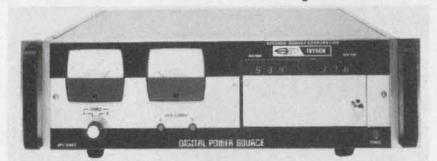

Trygon Electronics, 1200 Shames Dr., Westbury, N.Y. 11590. (516) 997-6200. Single channel DPS \$1275, dual channel DPS \$2058; 60 day.

The new DPS Series of digitally programmable power sources provides one or two digitally controlled dc voltage outputs of 0 to 50 V at 1 A or 0 to 100 V at 0.15 A. It allows digital programming of such analog functions as output voltage, overvoltage protection settings and overcurrent limit settings. Each function is independently controlled by a four-bit binary address code, directly from the computer's I/O circuit. Up to 16 test parameters can be programmed into the DPS addressable memory using only eight dual channel DPS units fed from one computer I/O circuit. The unit is housed in a 5-1/2 by 21 in. EIA rack mounting case.

CIRCLE NO. 264



# THE INFLATION FIGHTERS



HIGH SWITCH COSTS

"SIR RICHARD"

**SERIES 23000  
SNAP-IN  
SLIMSWITCH**



- Costs less to buy, assemble, install.
- Prices start at \$2.50 per switch module. (25¢ per switch function for 10 positions).
- No tools needed for assembly or mounting.
- Only .315" (8mm) wide, greater panel density, easier readability.
- Lots of output code options.
- Life of a million detent operations or more.
- *Stock parts and build assemblies yourself or we'll build them at no added cost.*

"SIR ROBERT"

**SERIES 25000  
SNAP-IN  
MINISWITCH**



- Like the SLIMSWITCH, but it can be used and mounted individually.
- Prices start at \$3.00 per switch assembly (only 30¢ per switch function for a 10 position switch).
- A million detent operations or more.

"SIR DIGIDAN"

**SERIES 29000  
ECONOMY  
MINISWITCH**

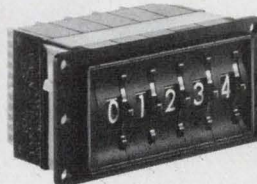

- A high quality economy switch for industrial environments...it's sealed against dust and fluids.
- Prices start at \$3.00 per module (25¢ per switch function for a 12 position switch).
- No tools needed for assembly.
- Back panel mounted.
- Lots of output code options.
- A million detent operations or more.
- *Stock parts and build assemblies yourself or we'll build them at no added cost.*

"SIR LYNN"

**SERIES 26000  
DIGIDIP**

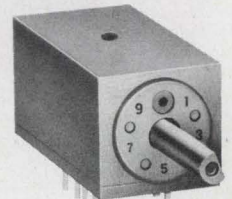

- A mini-rotary for 14 or 16 pin dual in-line sockets or dip or wave solder it to your P.C. board.
- Prices start at \$3.00 per switch (30¢ per switch function).
- Shaft or screw driver slot operated.

There is a Digitran authorized distributor and a sales engineering group in your area.

See pages 1148 and 1149, Vol. 2 in the 1973-74 EEM Directory for more Digitran products.

Call one of our inflation fighting experts; Sir Richard, Sir Robert, Sir Digidan or Sir Lynn or...

Send for details and quantity-prices for our "INFLATION FIGHTERS". You'll be delighted to find you can buy a DIGITRAN "INFLATION FIGHTER" for less per switch function than most toggle, pushbutton, lever, slide or rotary switches.

# indiana general...

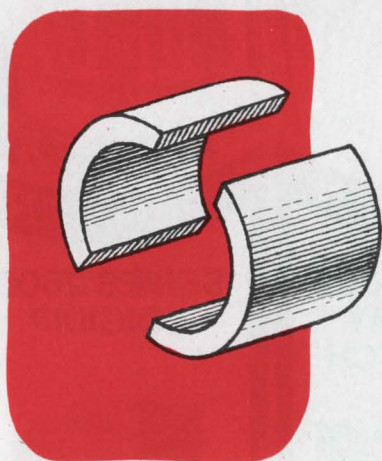

## pm motor segments

Our engineers can select from all magnet materials and shapes in meeting whatever tradeoffs you desire in your motor design. Our experience includes computer analysis of these tradeoffs to give you the best answers that magnet technology can provide.

For PM Motor Magnets Data File, circle **161**



## highest coercive force

High coercive force magnet materials are providing new solutions. We have the full range of materials to give you the highest Hci available in either cast alnico, sintered alnico or ceramic magnets. And our new Incor® Rare-Earth magnets are available now in qualification samples to meet your most difficult design requirements.

For High Coercive Force Materials Data File, circle **162**

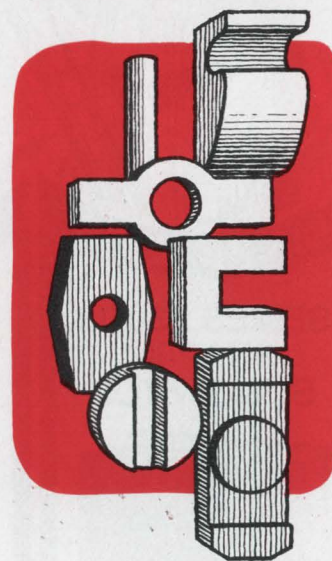

## small, intricate shapes

Get close tolerances and smooth surfaces with our complete family of sintered alnico materials. Our Sintered Alnico 8 combines the economy and the advantages of sintered shapes with the best magnetic specifications available anywhere. If larger sintered shapes can meet your requirements, talk to us about our special production capabilities.

For Sintered Alnico Data File, circle **163**

# problem solver\*



\*And the largest permanent magnet producer in the United States.

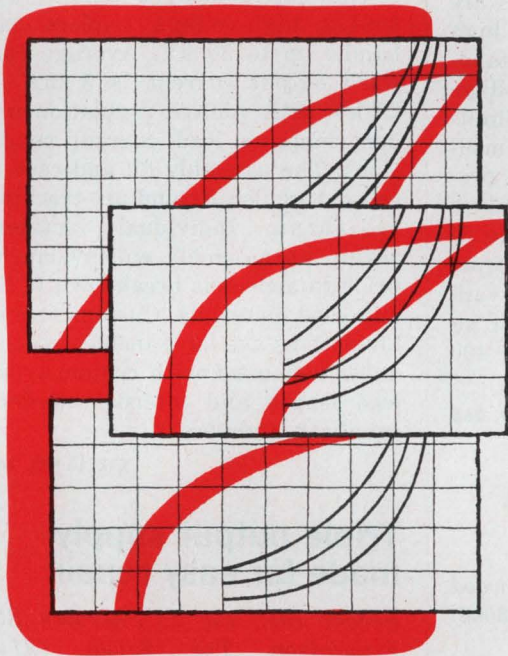

## complete range of materials

Indiana General supplies production quantities of all grades of alnico (both sintered and cast), cunife and ceramic materials. We will examine the full scope of possibilities from industry-proved materials to the latest rare-earth compositions in meeting your requirements at the lowest possible cost.

For complete Magnet  
Materials Data File,  
circle

**164**

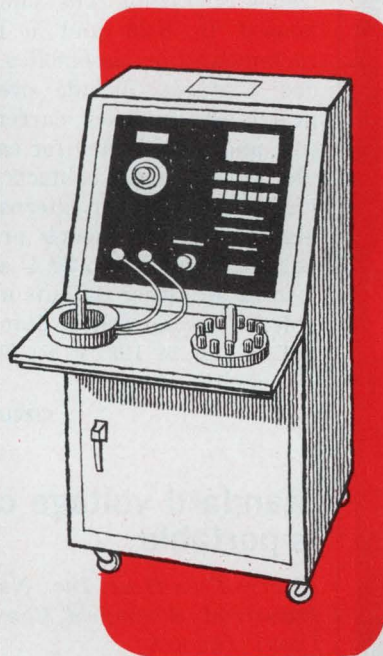

## magnetizing, calibrating systems

We can also meet your requirements for complete magnetizing, stabilizing and calibrating systems. From high volume production requirements to high energy systems for rare-earth materials, we can give you the complete magnetizing system to insure optimum performance from any magnetic circuit.

For Magnetizing and  
Calibrating Systems  
Data File, circle

**165**



## whatever your requirement

For assistance in applying the latest magnet technology to your requirements, call Applications Engineering: (219) 462-3131.

Or circle the Bingo Card number below and get a complete file of our current materials manuals, design guides, application notes and technical data.

Indiana General, Magnet  
Products, Valparaiso, Ind. 46383.

For complete Magnet  
Data File, circle

**166**

# AMPERITE DELAY RELAYS

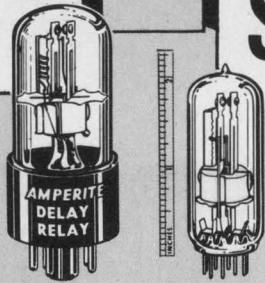

THERMOSTATIC  
DELAYS: 2 to 180 Sec.\*

Actuated by a heater, they operate on A.C., D.C., or Pulsating Current... Being hermetically sealed, they are not affected by altitude, moisture, or climate changes... SPST only — normally open or normally closed... Compensated for ambient temperature changes from  $-55^{\circ}$  to  $+80^{\circ}$ C... Heaters consume approximately 2 W. and may be operated continuously. The units are rugged, explosion-proof, long-lived, and inexpensive!

TYPES: Standard Radio Octal and 9-Pin Miniature.  
List Price, \$4.00

\*Miniatures Delays: 2 to 120 seconds.

All Amperite Delay Relays are recognized under component program of Underwriters' Laboratories, Inc. for all voltages up to and including 115V.

PROBLEM? Send for Bulletin No. TR-81.

## AMPERITE BALLAST REGULATORS

Hermetically sealed, they are not affected by changes in altitude, ambient temperature ( $-50^{\circ}$  to  $+70^{\circ}$ C), or humidity... Rugged, light, compact, most inexpensive.

List Price, \$3.00

Write for 4-p. Bulletin No. AB-51.

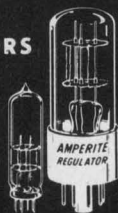

# AMPERITE

600 PALISADE AVE., UNION CITY, N.J. 07087

Telephone: 201 UNION 4-9503

In Canada: Atlas Radio Corp., Ltd.,  
50 Wingold Ave., Toronto 10

## POWER SOURCES

### Redundant output supply has high reliability

Acopian Corp., Easton, Pa. 18042.  
(215) 258-5441. From \$695 to \$1095; 3 wk.

System power supplies offer 100% redundant operation. Two power modules are included in each supply, and interwired in a manner permitting one to continue furnishing the rated output to the common output terminals should the other fail. A defective module may be removed from the assembly for repair while the supply continues operating. The supplies are housed in 5.25 and 7 in. high rack-mounting assemblies. Standard features include overvoltage protection, foldback current limiting, and a voltmeter for each module. Form C relay contacts are provided for control of external failure alarms. Various models provide dc outputs from 3.6 to 28 V and from 5 to 32 A. Other outputs are available on special order. Standard input is 105 to 125 V ac, 50 to 400 Hz, single phase.

CIRCLE NO. 265

### Standard voltage cell is portable

Electro-Flex Heat, Inc., Northwood Industrial, Bloomfield, Conn. 06002.  
(203) 242-6287.

The Model 121 standard voltage reference consists of four saturated cells in a compact, constant temperature air bath. A thermostat guard is provided to prevent cell damage from overheating in the event of failure of the main regulator. The heating job itself is accomplished through the use of a fiberglass reinforced flexible silicone rubber heating element. The 17.5 by 19 in. dual circuit heater operates at 115 V ac, 13.25 W or 12 V dc, 7.2 W. The voltage reference device features an automatic provision for changeover to 12 V dc stand-by power in the event of an ac power failure. A second heater, located at the top of the cell, is 5 by 3.5 in. and is used to provide complete, even heating while allowing access to the cell's interior.

CIRCLE NO. 266

### Voltage tripler handles up to 30 kV

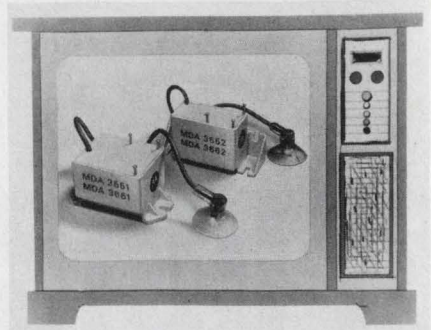

Motorola, P.O. Box 20912, Phoenix, Ariz. 85036. (602) 244-6900. MDA 3551: \$10.31, MDA 3662: \$12.26 (100-up); stock.

The MDA 3551/2 and MDA 3661/2 high-voltage triplers can handle up to 30 kV. Average forward output current is 3 mA at 25 kV with voltage regulation under changing load current conditions. The assembly fill and case is self-extinguishing and arc-tracking resistant. Individual rectifiers within an assembly will avalanche prior to dielectric breakdown to fill and case materials. Custom assembly options available include special anode connector with custom type/lead length and internal bleeder/ equalizer resistors.

CIRCLE NO. 267

### Triple output supply made for easy repair

Reacor Inc., 740 S. Sherman St., Richardson, Tex. 75080. (214) 235-1952.

The MPS Series of triple output power supplies has been designed with the field service engineer in mind. All subassemblies and components including transformers, capacitors, regulator boards, and pass elements are completely replaceable in a matter of seconds without the use of a soldering iron. Units are available with outputs of 5 V at 3 A and  $\pm 12$  or  $\pm 15$  V at 1.5 A; 5 V at 6 A and  $\pm 12$  or  $\pm 15$  V at 2 A. Other models are available with output voltages from 4.7 to 30 V dc. All models operate from 115/230 V ac, 47 to 440 Hz and feature adjustable overcurrent and overvoltage protection, logic inhibit control, line and load regulation better than 0.05% and ripple less than 1 mV rms.

CIRCLE NO. 268

A CAMBION DOUBLE "QQ" PRODUCT LINE

# Color your IC systems Cambion.

You can let your imagination soar, and still keep your most advanced IC packaging concepts practical. With Cambion's growing line of digital products, state of the art design ideas become a reality. And we can meet your needs with repeatable Quality, no matter how great the Quantity. Our variety of components is so extensive you won't have to think "specials".

Just take a look at our new Catalog 119. It features advanced new Cambi-Cards<sup>®</sup>, card files, drawers, universal panels with and without premounted socket strips and power planes, specific logic function cards, general purpose and discrete component cards, plus strip connectors, cable assem-

blies, integrated socket strips, component socket adapters, cable cards and card extenders.

We also offer a complete NC wrapping service to speed economical production of your IC system designs.

Develop your system ideas to their fullest potential *without component restriction*. Get your own copy of the new Cambion Catalog. It has 22 more pages than its predecessor showing more new products to keep ahead of your design needs. And they all have the Cambion Double "QQ" approach: the Quality stands up as the Quantity goes on. Order your copy today. Cambridge Thermionic Corporation, 445EM Concord Avenue, Cambridge, Mass. 02138. Phone (617) 491-5400. In Los Angeles, 8703 La Tijera Blvd. 90045. Phone (213) 776-0472.

Standardize on

## **CAMBION**<sup>™</sup>

... the Guaranteed Digital Products



## Low-cost, 10-MHz FET op amp provides higher stability

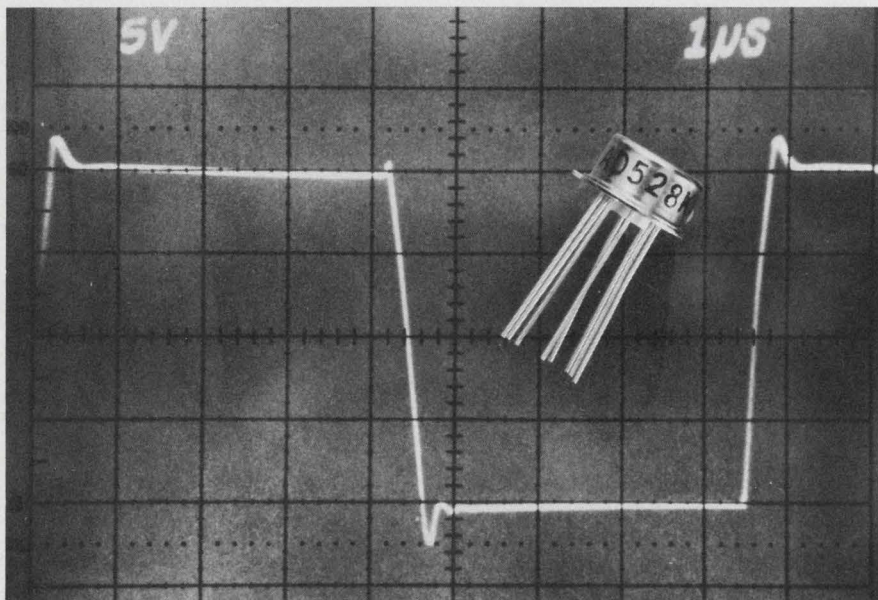

Analog Devices, Route 1 Industrial Park, Norwood, Mass. 02062. (617) 329-4700. P&A: See below.

The latest high-speed, low-cost FET-input op amp IC—Analog Devices' AD528—gives better ac stability than competing ICs. Internally compensated and using laser-trimmed, thin-film techniques, it achieves a 60° phase margin—virtually guaranteeing absolute stability and the elimination of ringing and overshoot in a transient response (see waveform in photo).

The AD528 requires no external compensation for normal operation, and it combines a high slew rate of 50 V/μs minimum (at unity gain) and a wide bandwidth of 10 MHz (unity gain, small-signal response) with a low input bias current of 15 pA maximum. For the 0-to-70-C range, the AD528 costs \$16 (suffix K) in quantities of 100 to 999.

The only other competing op amp in this price and performance range is the LH0062C amplifier from National Semiconductor, 2900 Semiconductor Dr., Santa Clara, Calif. 95051. This FET op amp sells for \$12 (100 to 999). The LH0062C has the same slew rate as the AD528, a higher bandwidth

of 15 MHz, but a higher bias current of 65 pA. Phase margin is not listed on the LH0062 spec sheet.

The term "phase margin" refers to the difference between 180° and the actual frequency-dependent phase shift at the system's unity-gain frequency. It is a figure-of-merit for stability and gives the margin between the actual system phase shift and the critical shift at which oscillation occurs. Up to now, phase margin has not generally been specified.

The use of laser-trimming results in a low offset voltage of 1 mV maximum and offset drift of 25 μV/°C maximum for the AD528K. In addition the FET op amp offers a minimum gain of 50,000 and a minimum CMRR of 80 dB.

A lower-priced version of the AD528—also for the commercial temperature range—sells for \$12 in quantities of 100 to 999 (suffix J). This version relaxes the offset specs to 3 mV maximum and 50 μV/°C maximum. Also, maximum bias current rises to 30 pA and minimum gain falls to 25,000.

For the -55-to-125-C range, the AD528S is available with the same key specs as the premium commer-

cial model (suffix K). Model S sells for \$28 in quantities of 100 to 999. National Semiconductor's corresponding circuit, the LH0062, has a higher bias and offset and sells for \$42.50 (100 to 999). And like its commercial version, the LH0062 doesn't have a phase-margin spec.

The addition of external feed-forward compensation to the AD528 can be used to increase slew rate to over 100 V/μs and almost double the bandwidth. Similarly settling time to 0.1% can be reduced to less than 1 μs with a single external capacitor.

All versions of the AD528 FET-input op amp come in TO-99 packages. Delivery is from stock.

For AD528

CIRCLE NO. 251

For LH0062

INQUIRE DIRECT

## Power transistors seek automotive uses

Fairchild Semiconductor, 464 Ellis St., Mountain View, Calif. 94042. (415) 962-3816. \$2.07 to \$4.95 (100-999).

Eight high-voltage, high-current transistors, specifically designed for automotive applications, expand the company's line of power transistors. Part numbers of the devices are the FT401/2, 410/11, 413/23/30/31. All are high voltage npn transistors that are equivalent to the Delco DTS series. All are rated at 100 W, except the FT430 and FT431, which are rated at 125 W. The new parts are manufactured with the company's Bimesar structure. Reported advantages of this structure over equivalent single-diffused devices are higher voltage capability, lower saturation voltages, better linearity and increased ruggedness.

CIRCLE NO. 269

# 3,500,000,000 WATTS

(3.5 BILLION)

THAT'S THE POWER HANDLING  
CAPACITY OF THE POWER TRANSISTORS  
STC DELIVERED IN 1973

STC delivers the widest  
line of hermetically sealed  
power transistors. Over  
1000 standard types span  
50mA to 200 Amps at  
up to 800 Volts  
and 350 Watts

At STC Silicon,  
Germanium NPN, PNP  
and Darlington Power  
Transistors are built with  
the optimum of every major  
process in a modern  
facility totally committed to  
power transistors

Building power supplies, regulators,  
amplifiers, controllers or whatever?  
Compare our specs and prices. If you  
look to STC first you will seldom need  
to look further.

For your free copy of the STC power  
transistor catalog circle below or  
contact



THE POWER SOURCE

SILICON TRANSISTOR CORPORATION KATRINA ROAD, CHELMSFORD, MASS. 01824  
TEL. (616) 256-3321

INFORMATION RETRIEVAL NUMBER 83



**“You’ve gotta be kidding.  
A battery-powered design like that  
would need a dense, static CMOS RAM  
with a 200 nanosecond access time  
and around 500 microwatt  
power dissipation.**

**“No way you’re going to find  
an outfit that can hack that.”**

**Give him  
the good news:**

**AMI**

AMERICAN MICROSYSTEMS, INC.

Our new S2222 512x1 CMOS RAM does it all. It combines the highest density and performance with the lowest power requirements on the market—three more firsts from Number One. For complete information, write AMI, 3800 Homestead Road, Santa Clara, CA 95051. Phone: (408) 246-0330. Or call your distributor.



# Here's that dense, static CMOS RAM.

Our S2222 is a 512 word by one-bit RAM, constructed with silicon gate CMOS devices integrated on a monolithic array. Fully decoded on the chip, this memory uses DC stable (static) storage elements and needs no refresh to operate. The memory matrix is organized as 32 rows by 16 columns. High-speed operation and micropower supply requirements make our new RAM ideal for applications where you have to conserve electricity or use a battery.

You can't beat its performance, either. It has a 200 ns access time and 420 ns cycle time, with power dissipation of only 1  $\mu$ W/bit and typical stand-by power of just 200 nW/bit. Since it is static, the data can be read without interruption. Maximum power dissipates only when the inputs change.

The unique circuit design lets the chip select precharge the internal nodes which minimize the power dissipation and maximize the performance. And for greater density, we designed in five transistors per cell. All in all, it's the densest, lowest powered CMOS RAM ever produced.

## S2222 Specifications

Access time: 200 ns at room temperature.  
300 ns at military temperature range.

Cycle time: 420 ns

Power dissipation: typically 1  $\mu$ W/bit.

Stand-by power: 200 nW/bit.

Power supply: single +10 volt.

Current sink output with "OR" tie capability.

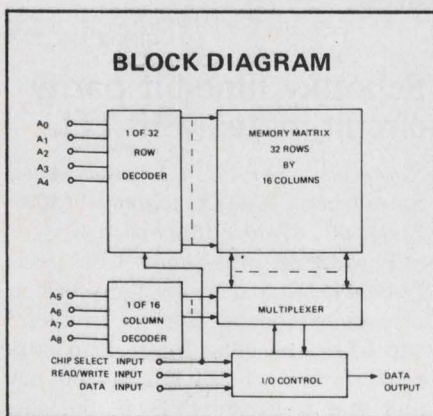

# AMI

INFORMATION RETRIEVAL NUMBER 84

## ICs & SEMICONDUCTORS

### Decoder/driver ICs simplify displays

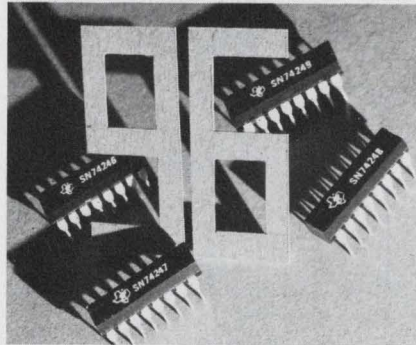

Texas Instruments, P.O. Box 5012, M/S 308, Dallas, Tex. 75222. (214) 238-3741. \$2.93 up (100-999); 16 wk.

Four TTL BCD-to-seven-segment decoder/driver ICs feature display fonts that are compatible in systems using the SN54/74143 or SN54/74144 counters/latches/decoders/drivers. Called the SN54/74246 through 249, these drivers can be used in applications requiring parallel or remotely located LED indicators. Latch outputs of the 143 and 144 can be used for BCD data input to the new decoders/drivers. The 246 through 249 interface directly to the BCD outputs of the 143 or 144. The 246 and 247 ICs have a sink current rating of 40 mA and a respective voltage rating of 30 and 15 V. The 248 and 249 ICs have a voltage rating of 5.5 V and a respective sink-current spec of 6.4 and 10 mA.

CIRCLE NO. 270

### 3-terminal regulator ICs spec'd at 0.5 A

Fairchild Semiconductor, 464 Ellis St., Mountain View, Calif. 94042. (415) 962-3816. \$1.50 to \$1.65 (100-999).

A line of three-terminal voltage regulator ICs, called the 78M series, are fixed positive voltage units rated at 0.5 A. Voltage ratings are 5, 6, 8, 12, 15, 20 and 24 V. The 78M regulators provide an output voltage tolerance of better than  $\pm 5\%$  over their rated temperature range. They also feature internal thermal overload protection and short-circuit limiting. Output transistors have built-in safe-area compensation.

CIRCLE NO. 271

### Calculator ICs include one with memory

Mostek Corp., 1215 W. Crosby Rd., Carrollton, Tex. 75006. (214) 242-0444. \$13.50 (100-499).

Three new MOS/LSI calculator ICs include an eight-digit, four-function circuit and a fully independent memory. Called the MK 5022 A, the new circuit requires 20 keys to operate. The MK 5022 A also features automatic constant, floating decimal, floating negative sign, algebraic entry, display blanking and internal debouncing and decoding of keyboard inputs. Other circuits include the MK 5020 A—an eight-digit, six-function programmable circuit—and the MK 5021 C—a 10-digit, six-function circuit.

CIRCLE NO. 272

### 4-bit register shifts at 110 MHz

Signetics, 811 E. Arques Ave., Sunnyvale, Calif. 94086. (408) 739-7700. \$6.20 (100).

A 4-bit bidirectional Schottky-clamped TTL shift register, the N74S194, achieves a typical shift frequency of 110 MHz, and is fully compatible with most other TTL and DTL circuits. The N74S194 has four modes of operation, including parallel (broadside) load, shift right, shift left and hold (recirculate) data. With the equivalent of 46 gates on the monolithic chip, typical power dissipation is less than 10 mW per equivalent gate.

INQUIRE DIRECT

### Quad 80-bit SR has dc-to-5-MHz range

Motorola, P.O. Box 20924, Phoenix, Ariz. 85036. (602) 244-3466. \$10 (100-999); stock.

An n-channel MOS monolithic quad 80-bit shift register, called the MC6565L, features an operating range of dc to 5 MHz and includes recirculate logic on the chip. Direct TTL compatibility is achieved by using standard 5-V power supplies. Power dissipation for the entire register is 650 mW. The MC6565 is supplied in a hermetic 22-pin ceramic DIP.

CIRCLE NO. 273

at prices from \$50  
Hipotronics offers you  
delivery from stock  
on over 800 standard  
models of

# hv dc power supplies

... with output voltages  
from 1 to 1000 KV and  
current outputs from  
2 ma to 50 amperes.



model 860-6.5  
60 KV, 6.5 ma.

## ALSO:

■ **Custom design units:** for wide range of applications — electrostatics, accelerators, lasers, monocyclic charging, high power radars, high voltage testing, and more.

■ **HV power packs:** wide range of compact, miniaturized power packs, with output voltages from 2.5 to 100 KV and current ratings of 2 to 10 ma. Also, standard 5-ma and 2-ma HV power packs with simplified controls.



model R-30B

Send for our 24-page catalog, "High Voltage DC Power Supplies and Components," or call our Sales Department and ask for the Power Supplies Manager.

**HIPOTRONICS**  
**HIPOTRONICS, INC.**  
Brewster, N. Y. 10509 / (914) 279-8091  
TWX: 710-574-2420

INFORMATION RETRIEVAL NUMBER 85

## ICs & SEMICONDUCTORS

### 128-bit ECL RAM accesses in 15 ns

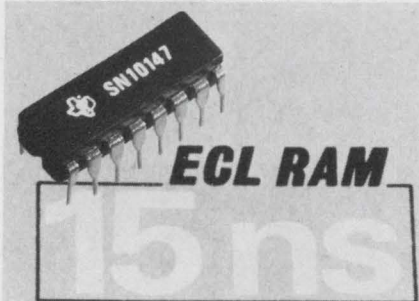

Texas Instruments, P.O. Box 5012,  
M/S 308, Dallas, Tex. 75222.  
(214) 238-3741. \$31.24 (100); 2  
wk.

An ECL 128-bit RAM features a maximum access time of 15 ns. Called the SN10147, the new memory is fully compatible with existing ECL 10-k circuits. The RAM operates from a  $-5.2 \text{ V} \pm 10\%$  power supply over the temperature range of 0 to 75 C. The ECL memory contains full address decoding and output sense amplifiers on the chip.

CIRCLE NO. 274

### MOV varistor spec drops to 40 V

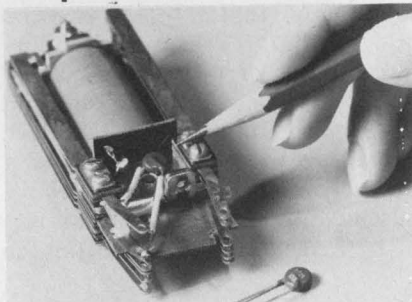

General Electric, Electronics Park,  
Bldg. #7, Mail Drop 49, Syracuse,  
N.Y. 13201. (315) 456-2021. 57¢  
up (1000).

The company's line of voltage transient suppressors now include six lower voltage Mini-MOV varistors. They cover the 40-to-80-V rms applied voltage range. Two models each are available with 40, 60 and 80 V rms ratings, together with respective 53, 80 and 110 V dc ratings. Respectively, they are Models V40LA2A and V40LA-2B; Models V60LA3A and V60LA3B; and Models V80LA4A and V80LA4B. Over-all dc clamping ratios range from 2.5 to 2.1. Maximum energy handling capability includes 2, 3 and 4-joule ratings.

CIRCLE NO. 275

### 1024-bit-RAM line grows

Mostek Corp., 1215 W. Crosby Rd.,  
Carrollton, Tex. 75006. (214) 242-  
0444. \$4.05 (100-499).

The latest  $1024 \times 1$ -bit memory in the company's dynamic MOS RAM series—the MK 4008-9 P—is functionally equivalent to the MK 4006/4008 RAMs, but offers 800-ns access time and 1-ms refresh time. It has TTL-compatible inputs and comes in a 16-pin ceramic DIP.

CIRCLE NO. 276

### Op amp, comparator form a/d control circuit

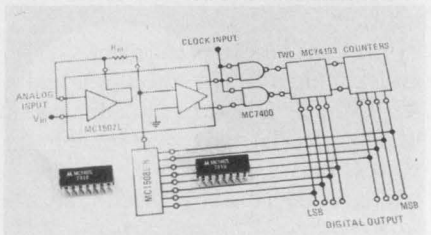

Motorola, P.O. Box 20924, Phoenix,  
Ariz. 85036. (602) 244-3466. MC-  
1507L: \$6.95; MC1407L: \$3.95  
(100-999); stock.

A wideband op amp and a high-speed, dual-threshold comparator are combined in an a/d control circuit called the MC1507/1407. The Schottky comparator has a 75-ns propagation delay and requires a typical input current of only  $0.4\text{-}\mu\text{A}$ . The op amp features a  $20\text{-V}/\mu\text{s}$  slew rate and 24-MHz typical bandwidth at unity gain. Standard supply voltages of +5.0 and  $\pm 15$  V dc are used, permitting full TTL and CMOS compatibility. The op amp section of the new MC1507 can be used as a high-speed buffer with a full-scale settling time of 800 ns.

CIRCLE NO. 277

### Schottky nine-bit parity circuit mates with TTL

Signetics, 811 E. Arques Ave.,  
Sunnyvale, Calif. 94086. (408)  
739-7700. \$7.60 (100 up).

The 82S62 nine-input TTL parity-generator/parity-checker has a propagation delay for  $p_n$  to even/odd of 16 ns. The input load current for a logic ZERO is  $800\text{ }\mu\text{A}$  and for a logic ONE is  $50\text{ }\mu\text{A}$ . Outputs deliver 20 mA at 0.5 V for logic ZERO and 1 mA at 2.7 V for logic ONE.

INQUIRE DIRECT

INFORMATION RETRIEVAL NUMBER 86 ►

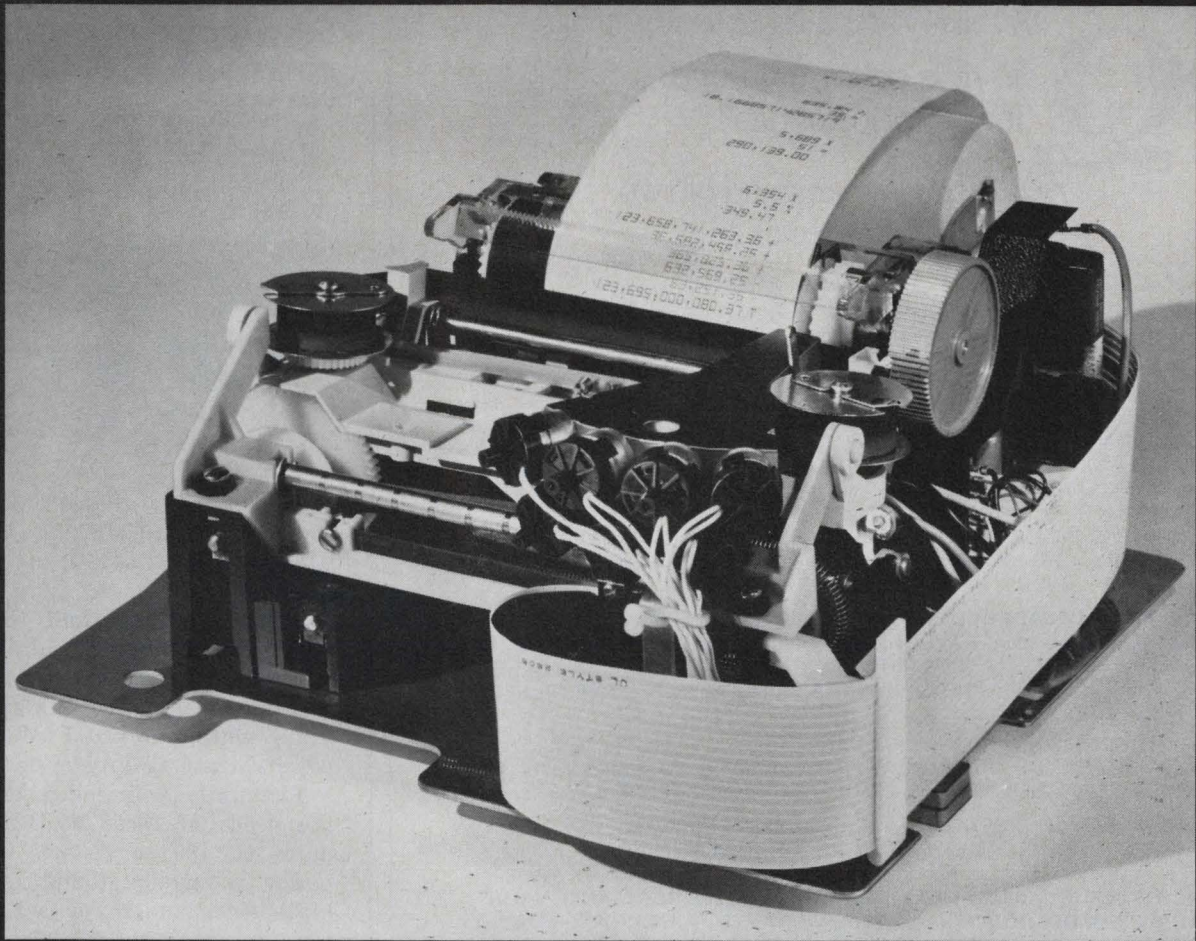

# Our Supersonic Printer can speed up your next design.

If your next design requires a narrow print-out,  
consider Victor's high-speed matrix printer.

Why?

Because it's outstandingly reliable. Reliable enough to  
print 35 million characters without periodic maintenance.

Because its 5 x 7 dot matrix head can form alphabetical,  
numeric, and symbolic characters. 34 per line.  
110 per second. In two colors.

Because it's a compact unit—8½" wide, 5" high, 12" long  
—that accepts adding machine tapes up to 3¾" wide.

And because it utilizes all technology and expertise  
that Victor's design engineers and factory personnel  
can build into a machine.

That's why we use it in our own top-line  
electronic calculators. Victor's Supersonic Matrix  
printer. It can speed up your next design.

Victor Comptometer Corporation  
Component Products  
3900 North Rockwell Street  
Chicago, Illinois 60618

Please send me complete specifications  
on the Victor Matrix Printer.  
 Also have a representative call.

Name \_\_\_\_\_

Title \_\_\_\_\_

Firm \_\_\_\_\_

Address \_\_\_\_\_

City \_\_\_\_\_

Zip \_\_\_\_\_

Phone \_\_\_\_\_

State \_\_\_\_\_

 **VICTOR**

ED

**An Important Public Service Message**

**HyComp Addresses the Problem of Inflation**

**Q** What is better than two for the price of one?

**A** Using one instead of two for the price of one!

WHEN YOU USE PRECISION THIN FILM RESISTOR LADDER NETWORKS WITH CURRENT SWITCHES AS INTERSIL'S 8018A THRU 8020A AND FAIRCHILD'S  $\mu$ A 9650 FOR A/D AND D/A CONVERSION, YOU CAN REDUCE COSTS AND SIZE SIGNIFICANTLY!

**HOW?** WITH HyCOMP'S **HC-130 and HC-135 SERIES 12 BIT WEIGHTED LADDER NETWORKS** WHICH ARE MADE ON SINGLE 110 x 190 mil, GLASS SUBSTRATE CHIPS AND REPLACE THE PREVIOUS STANDARD TWO CHIP NETWORKS. THEY PROVIDE SUPERIOR T.C. TRACKING AND OTHER CHARACTERISTICS AND COST AS LITTLE AS \$24(1-9) and \$17(1K). AVAILABLE IN 24 LEAD DIP OR FLAT PACK, HERMETIC OR NON-HERMETIC . . . OR IN CHIP FORM. HC-130 SERIES USED WITH INTERSIL SWITCHES. HC-135 SERIES USED WITH FAIRCHILD'S.

THE **THREE DECADE BCD WEIGHTED LADDER COUNTERPARTS**, DESIGNATED **HC-130A and HC-135A**, HAVE THE SAME EXCELLENT SPECS AS THE OTHER HyCOMP RESISTOR LADDER NETWORKS WITH THE EXCEPTION THAT RATIO ACCURACY IS 0.05% AND MAXIMUM ACCUMULATED POSITIVE OR NEGATIVE ERROR IS 0.05% F.S.

IF **THE OLD STANDARD** TWO PACKAGES HAVE ALREADY BEEN FROZEN INTO YOUR DESIGNS . . . THEN USE THE **HC-420 and HC-430 SERIES** WITH THE INTERSIL SWITCHES. AVAILABLE IN 14 LEAD DIP OR FLATPACK.

AND WHEN YOU USE THIN FILM R-2R LADDER NETWORKS, GET THEM ON THE SMALLEST SINGLE CHIPS AND AT THE LOWEST PRICES!

**HC-210 SERIES . . . 12 BIT LADDER NETWORK WITH A RESISTANCE VALUE OF 50K for MOS** OR ANY ANALOG SWITCH WITH A HIGH SATURATION RESISTANCE. AS LITTLE AS \$25(1-99). AVAILABLE IN 16 LEAD DIP OR FLATPACK, HERMETIC OR NON-HERMETIC . . . OR 100 x 190 MIL CHIP.

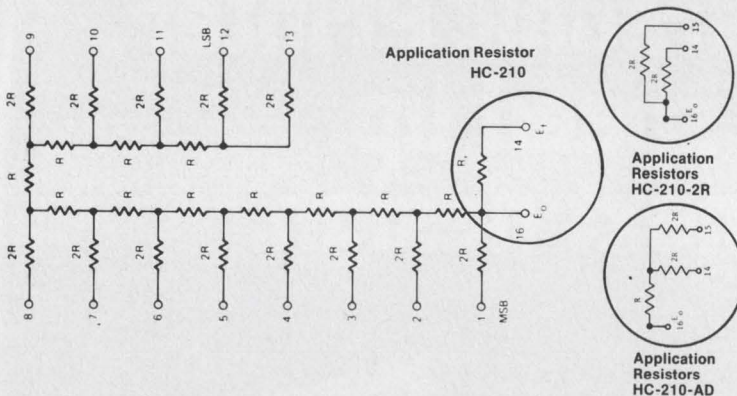

**HC-1000 SERIES . . . 12 BIT LADDER NETWORK WITH STANDARD RESISTANCE VALUES OF 5K, 10K, and 25K.** IN 16 LEAD DIP OR FLATPACK, HERMETIC OR NON-HERMETIC . . . OR 100 x 150 MIL CHIP. AS LITTLE AS \$23.20(1-99)

SPECIFICATIONS FOR 12 BIT THIN FILM LADDER NETWORKS (unless otherwise noted).

T.C. TRACKING: < 1 PPM/°C RATIO ACCURACY: 0.01%  
 MAXIMUM ACCUMULATED POSITIVE OR NEGATIVE ERROR: 0.012%  
 10 AND 8 BIT MODELS ALSO AVAILABLE.

**HYCOMP ALSO DESIGNS AND MANUFACTURES PRECISION THIN FILM LADDER NETWORKS, ARRAYS, AND HYBRID MICROCIRCUITS TO CUSTOMER SPECIFICATIONS WHENEVER ECONOMICALLY FEASIBLE.**



146 Main Street, Box 250 Maynard, Mass. 01754 (617) 897-4578

**INSTRUMENTATION**

**5-kW pulse generator costs just \$1990**

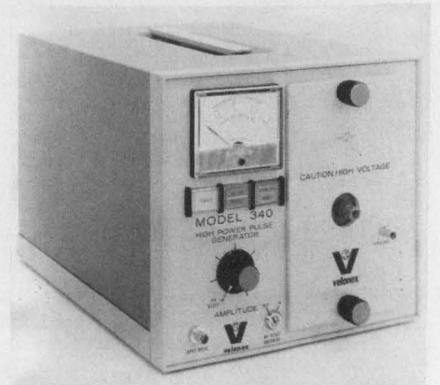

Velonex, Div. of Varian, 560 Robert Ave., Santa Clara, Calif. 95050. (408) 244-7370. \$1990; stock to 30 days.

Selling at about half the price of other high-power pulse generators, the \$1990 Model 340 from Velonex—a specialist in high-power units—outputs up to 5 kW of peak power at a 1% duty cycle.

The unit is intended to fulfill the needs of those who don't require the 20 to 30 kW of peak power commonly found in many high-power units, or who don't want to spend the \$5000 or \$6000 that these units cost.

Amplitude capabilities of the 340 include an output voltage variable from -100 to -1000 V, and current ranging from 0 to 5 A. Higher duty cycles are possible at lower output powers.

An external pulse source is needed to drive the Velonex unit. With 10-V input, the Model 340 outputs pulses with width continuously variable from 0.1  $\mu$ s to 1 ms, and with repetition frequency ranging to 100,000 pulses per second.

Input pulse width and rep rate determine width and rate of the output pulses. However, rise and fall times of the output—into a 200- $\Omega$  resistive load—are fixed at 50 ns, maximum.

Just how good is a 5-kW pulse? In the case of the Velonex unit, jitter of the width is less than 0.1% + 0.005  $\mu$ s; and interpulse jitter is a maximum of 0.1% + 0.02  $\mu$ s.

Droop is less than 0.005%/ $\mu$ s or 1%, whichever is greater; and overshoot doesn't exceed 3%. According to the 340 spec sheet, pulse-top ripple is "negligible."

CHECK NO. 250

## Wattmeter controller senses true rms power

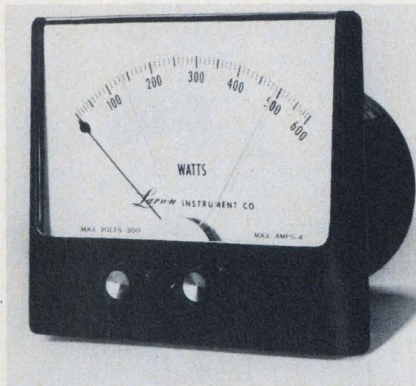

Larson Instrument Co., Greenbush Rd., Orangeburg, N.Y. 10962. (914) 359-3800. \$158; 2-3 wk.

The CMC Wattmeter Control uses a photoelectric sensing system directly coupled to a dynamometer meter movement. The unit controls motors, solenoids, heaters and other equipment based on actual rms power, rather than voltage or current ratings. CMC Wattmeter Controller is available in 3.5 or 4.5-in. sizes, with ranges of 0-30 W to 0-100 kW in single phase or 3-phase versions. Ranges up to 1500 W are self-contained.

CIRCLE NO. 278

## Safety analyzer checks leakage

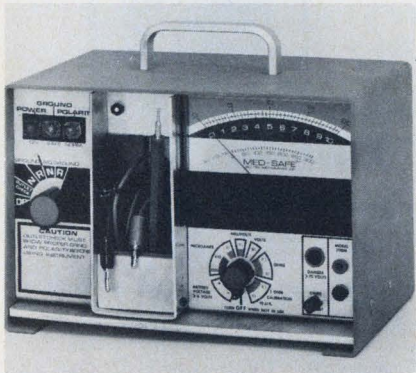

Bio-Tek Instruments, 5000 Shelburne Rd., Shelburne, Vt. 05482. (802) 985-3543. \$475; 30-60 days.

Model 300M is a self-contained instrument that tests any device for leakage currents in microamps, resistance in ohms, and both millivolts and volts. Built-in features include a receptacle for easy testing and the ability to quickly alter ground and polarity while testing. Microamp testing covers three ranges: 0-20, 0-100, and 0-1000; ohms from 0-.2 0-2; mV, 0-20; and volts, 0-300.

CIRCLE NO. 279

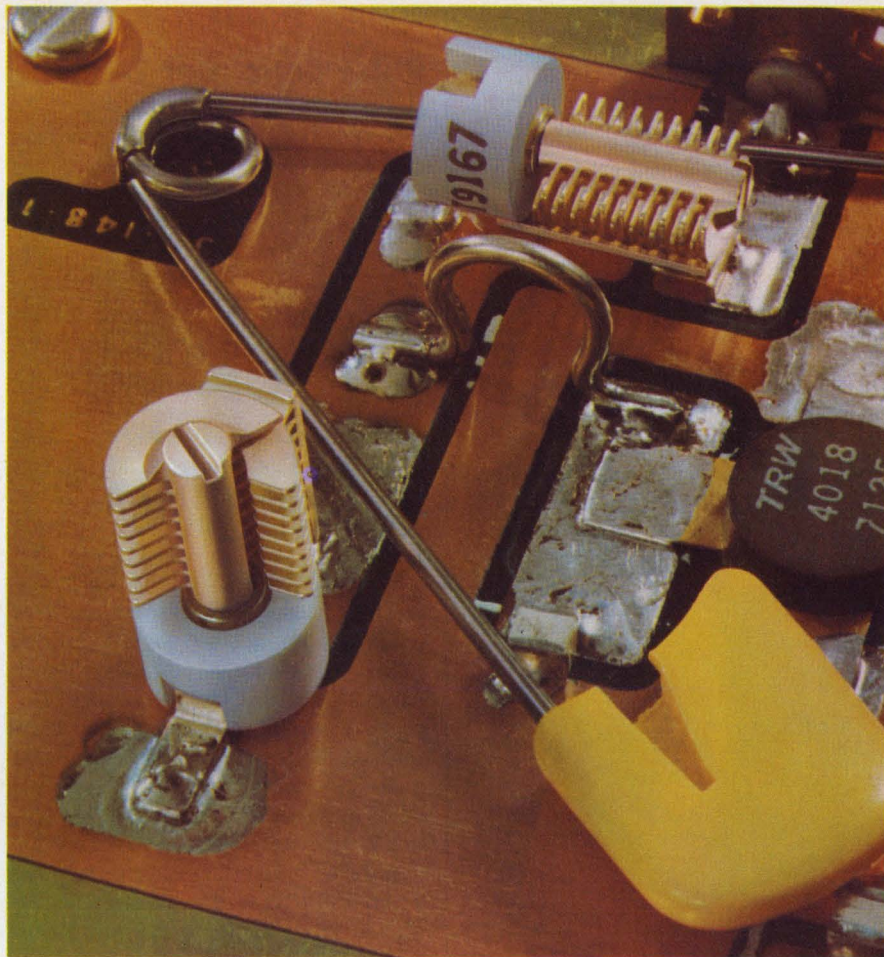

## The smallest 180° tuning air variable capacitors just had babies!

Right. Johnson's exclusive subminiature type "T" air variable capacitors (PC mounts) now come with stripline terminals for microwave applications, either vertical or horizontal tuning.

These space-savers are only about 1/4 the volume of a "U" capacitor, but they offer extraordinarily high mechanical and electrical performance for critical applications.

Rotors and stators are as stable and uniform as precision machining from solid brass extrusion can make them. A high 1 1/2 to 8 ounce-inches torque holds the rotor securely under vibration.

Temperature coefficient is very low plus 30 ± 15 ppm/° C. Q is high, typically 1800 at 200 MHz. Three capacitance ranges span from 1.3 pF to 15.7 pF.

Our 45 years of experience really shows up in these new capacitors. But why take our word for it when a stamp will get you a couple of freebies and you can check them out for yourself.

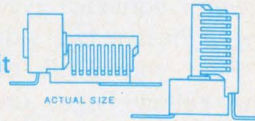

E. F. JOHNSON COMPANY / 3306 Tenth Ave., S.W. / Waseca, Minnesota 56093

Check type and range of sample(s) needed:	Capacitance range	1.3 to 5.4	1.7 to 11.0	1.9 to 15.7
	Horizontal tuning	<input type="checkbox"/>	<input type="checkbox"/>	<input type="checkbox"/>
	Vertical tuning	<input type="checkbox"/>	<input type="checkbox"/>	<input type="checkbox"/>

Name \_\_\_\_\_ Phone \_\_\_\_\_

Firm \_\_\_\_\_ Title \_\_\_\_\_

Address \_\_\_\_\_

City \_\_\_\_\_ State \_\_\_\_\_ Zip \_\_\_\_\_



**E. F. JOHNSON COMPANY**

INFORMATION RETRIEVAL NUMBER 88



## hot stuff

or cold, CHR's family of TEMP-R-TAPE of Kapton provides outstanding endurance. They retain their excellent mechanical and electrical properties over a wide temperature range,  $-100$  to  $+500$ F.

Available in thicknesses from .001" to .0045" with a choice of several adhesive systems including adhesive two sides.

Find your CHR distributor in the Yellow Pages under "Tapes, Industrial" or in industrial directories. Or write for complete specification kit and sample. The Connecticut Hard Rubber Company, New Haven, Conn. 06509.

# CHR

an ARMCO company

INFORMATION RETRIEVAL NUMBER 89

### INSTRUMENTATION

## Pulse generator delivers 16-V pulses



Hewlett-Packard, 1501 Page Mill Rd., Palo Alto, Calif. 94304. (415) 493-1501. \$435; 90 days.

With pulse amplitude variable from 250 mV to 16 V, and rep rate from 0.1 Hz to 20 MHz, the 8011A Pulse Generator can test most commonly used logic families. Source impedance on the lower ranges is 50  $\Omega$ , while in the 4-V to 16-V range, either 50  $\Omega$  or high impedance can be selected. Pulse polarity can be positive, negative or symmetrical. The pulse complement can be selected positive or negative, and duty cycle can be up to 100%. Pulse width can be varied from 25 ns to 100 ms. Transition times are fixed at less than 10 ns.

CIRCLE NO. 280

## Chart recorder offers five input ranges

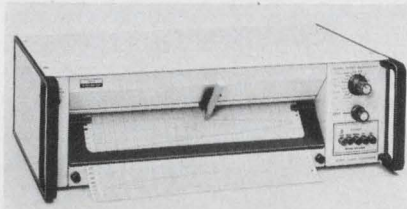

Heath/Schlumberger Instruments, Benton Harbor, Mich. 49022. (616) 983-3961. \$335.

The new SR-255B Strip Chart Recorder gives a choice of four, front-panel, switch-selectable calibrated spans: 10 mV, 100 mV, 1 V and 10 V. A variable span capability extends the range to 100 V full scale. Chart speeds of 10, 5, 2, 1, 0.5, 0.2, 0.1, 0.05, 0.02 and 0.01 inches or cm per minute are provided, accurate to better than 0.5%. The entire chart transport can be removed from the recorder in seconds and the paper changed in just a few more. The floating input has  $10^7$ - $\Omega$  impedance.

CIRCLE NO. 281

## Three DMMs are unveiled



Tekelec, Inc., 31829 W. La Tienda Dr., Westlake Village, Calif. 91361. (213) 889-2834. P&A: See text.

Three DMMs in a new series include the \$249 TA 356, a 3-1/2-digit portable unit, the \$269 TA 355, a 3-1/2-digit bench unit, and the \$395 TA 365, a 4-1/2-digit bench instrument. All three feature liquid-crystal displays, five functions and five ranges per function.

CIRCLE NO. 282

## Digital unit reads degrees to $\pm 0.1$ C

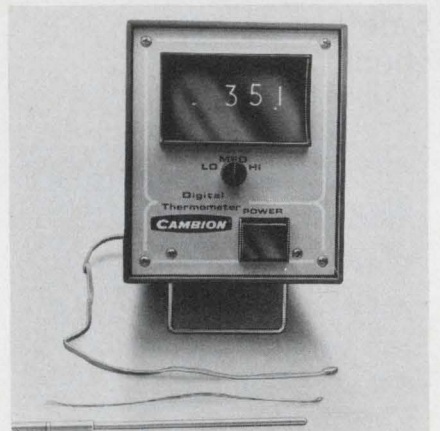

Cambridge Thermionic Corp., 445 Concord Ave., Cambridge, Mass. 02138. (617) 491-5400. \$828 ea.; stock.

Digital Temperature Indicator, Model 811-7209, requires only a 117-V-ac source and can be used with a variety of thermistor sensors. A single lighted power switch is all that is required to operate the system. Sensor accuracy is  $\pm 0.1$  C. With three Nixie tubes, plus an overrange digit, the indicator records up to 125 C and down to  $-30$  C with automatic polarity indication.

CIRCLE NO. 283



SCHADOW

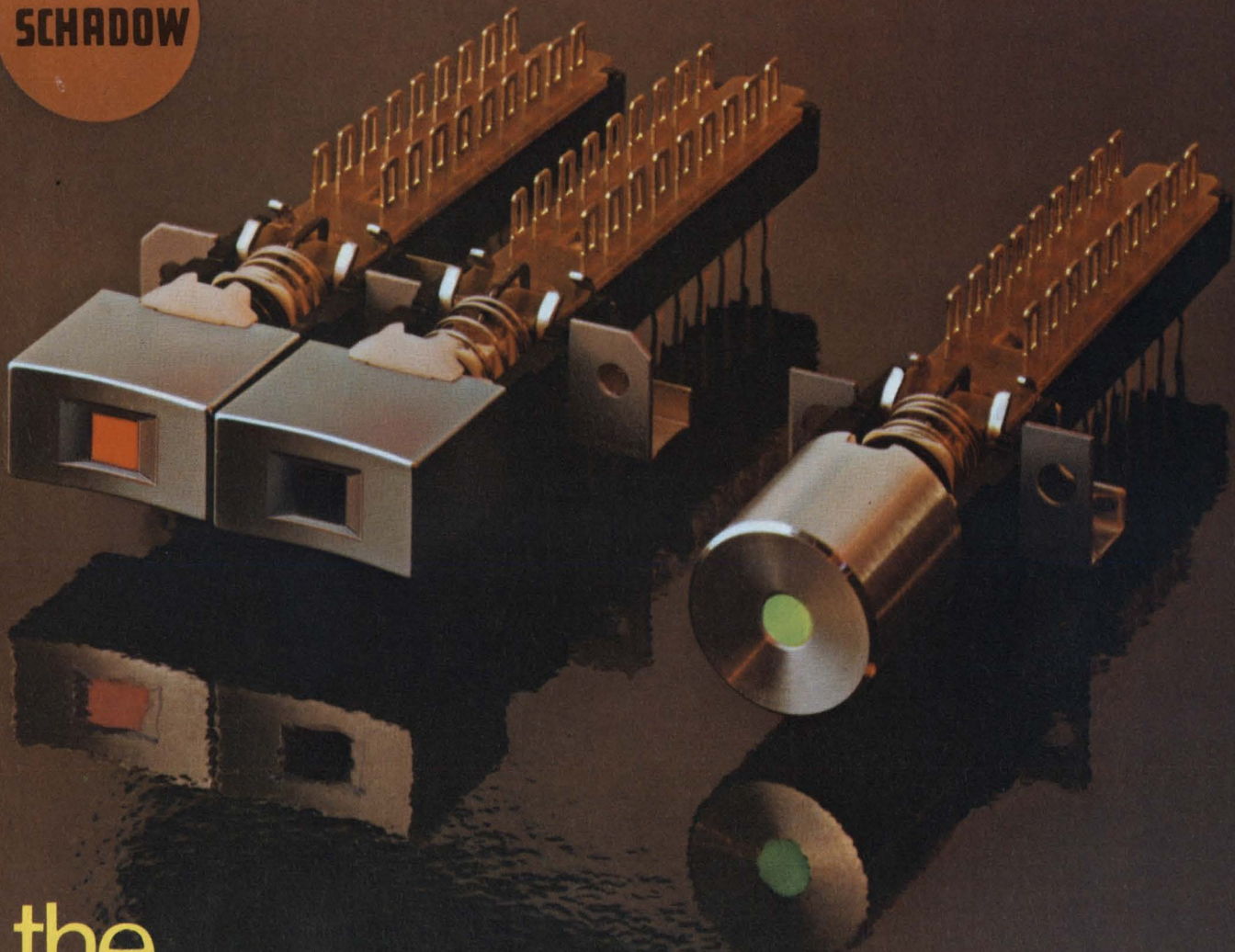

the  
right touch to  
turn your  
equipment on

Out of Schadow and into the limelight emerges a significant and exclusive breakthrough in modular push button switches.

Schadow Series H push buttons always return to the out position to provide continuity of attractive appearance . . . indicate function by a remarkable mechanical reflecting principle . . . and are quieter both in push-push and interlocking actions. Add these pluses: constant low contact resistance, coil spring loaded punctu-form bridging contacts, solder lugs on top, PC spikes bottom, with molded circuit board stand-offs . . . pin centers .157"

. . . all the proven characteristics of Schadow successful Series F.

**Coming Soon!** Series HL illuminated version with minute shock interlock resulting in infinitely longer lamp life.

If it's a better switch you need . . . better switch to Schadow.



SCHADOW  
AMERICA, INC.



**INTERNATIONAL ELECTRO EXCHANGE CORPORATION**

8081 Wallace Road, Eden Prairie, Minn. 55343  
612/944-1820 • TWX 910-576-2469

Manufacturing facilities in Minneapolis, Minnesota, Einbeck, W. Germany and W. Berlin.  
Covered by one or more US Patents: 3722313, 3673365, 3582592, 3715548. Patents Pending.

# NEW 18 Bit Bipolar A/D Converter

FUNCTION MODULES, INC.  
Irvine, Calif.



MODEL 107

ANALOG-TO-DIGITAL CONVERTER

## MODEL 107 DUAL-SLOPE ADC

- **Resolution**  
4½ Digits BCD plus Sign  
or 14 Bits Binary plus Sign
- **±0.005% max. Nonlinearity**
- **Low Drift** —  
±2ppm/°C max. Offset  
Drift and  
±5ppm/°C max. Gain  
Drift
- **Automatic Zero Correction**
- **Rejects 60Hz/50Hz Noise**
- **Pin compatible with Analog  
Devices 17-1 and 14-1**

And this new analog-to-digital converter is versatile... you can connect it to automatically recycle or to convert on external command. Also you can connect it for ratiometric operation or use the internal references.



And they're in stock!

Call or write today.

**Function Modules, Inc.**  
2441 Campus Drive  
Irvine, California 92664  
Phone: (714) 833-8314  
TWX: 910-595-1706

## INSTRUMENTATION

### Constant-%-bw analyzers scan 2 Hz to 20 kHz

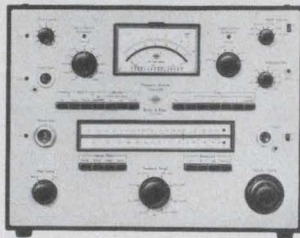
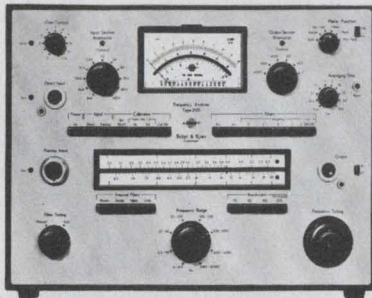

*B & K Instruments, 5111 W. 164th St., Cleveland, Ohio 44142. (216) 267-4800. 2120: \$5206; 2121: \$3195.*

The 2120 and 2121 are Frequency Analyzers designed for noise and vibration analysis and harmonic analysis in audio applications. They offer adjustable high/low-pass filtering and band-rejection, plus automatic recording of spectra. The 2120 covers 2 Hz to 20 kHz and is particularly suited for applications where extremely narrow bandwidth at the low frequency end of the spectrum is important.

CIRCLE NO. 284

### 5-1/2-digit DMM costs only \$750

*Keithley Instruments, 28775 Aurora Rd., Cleveland, Ohio 44139. (216) 248-0400. \$750.*

Included in the Model 190's price are 1000-MΩ input resistance, BCD outputs, 100-dB CMRR and 13 ranges of ac/dc V from 1 V to 1000 V, and ohms from 1 kΩ to 10 MΩ. Resolution is 10 μV and basic accuracy of the 100%-overranging unit is ±(0.005% of reading + 0.005% of range). Tempo is ±0.002% of reading/°C.

CIRCLE NO. 285

### Test system checks linear ICs



*Teradyne, 183 Essex St., Boston, Mass. 02111. (617) 482-2700. Basic price: \$84,800; 20 wk.*

The J273 Test System for Linear Circuits handles such devices as audio amplifiers, stereo demodulators, i-f detectors, and color-processing and video circuits. Other devices that can be tested include operational amplifiers, comparators and voltage regulators. Operated by the company's M365 Computing Controller, the basic test station of the system contains six voltage sources, one voltage/current source, and a sample and difference a/d converter. Each source has ranges of ±2, ±20 and ±60 V with a maximum current of 120 mA in any range.

CIRCLE NO. 286

### Digital thermometer takes 5 thermocouples



*Omega Engineering, Box 4047, Stamford, Conn. 06907. (203) 359-1660. \$895; stock.*

This Digital Temperature Readout can be used interchangeably with any of five different thermocouple calibrations—Chromel-Alumel, Iron-Constantan, Copper-Constantan, Chromel-Constantan and Platinum-Rhodium—by just flipping a switch. The unit also serves as a Digital Microvolt Meter with 10 μV per digit resolution. The 2809 Temperature Indicator uses a 4-digit LED readout and contains a built-in cold junction temperature compensating circuit and a linearizer.

CIRCLE NO. 287



# Improve your hybrid yields with SINGLE-CHIP TC ZENER CHIPS from DICKSON

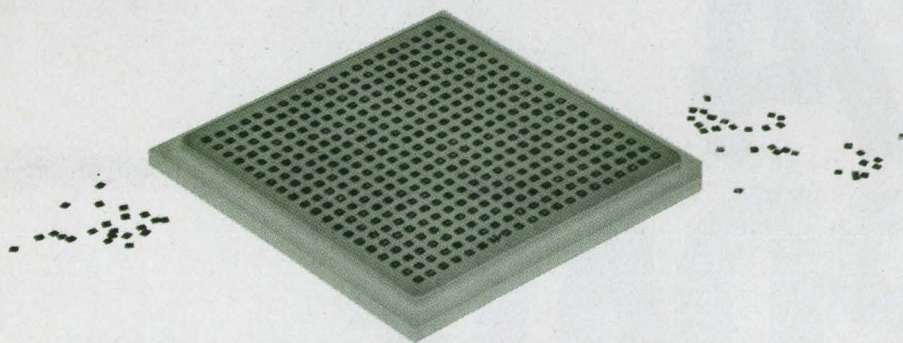

You can now design temperature compensated voltage reference diodes in your hybrid circuits with assurance that temperature coefficients will meet your design requirements. Dickson provides them on a single-chip, 100% tested, to help save time, simplify circuit fabrication and improve your yields.

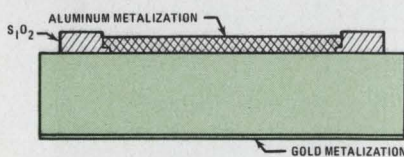

CROSS SECTION OF SINGLE CHIP TC ZENER

Each 37 mil square Dickson chip contains two totally passivated junctions with a 6.2 Volt or 6.4 Volt temperature compensated reference. Temperature coefficients to 0.0005%/°C are available. The chips are electrically equivalent to the JEDEC 1N821-829 and 1N4565A-4584A series.

The Dickson chips have gold metalization on the back, compatible with all common die bonding and soldering

techniques. Aluminum metalization on upper surface is compatible with ultrasonic and thermocompression wire bonding.

FOR COMPLETE TECHNICAL INFORMATION contact your local Dickson Sales Representative, or write to Dickson.

AVAILABLE IN ASSEMBLIES, TOO!

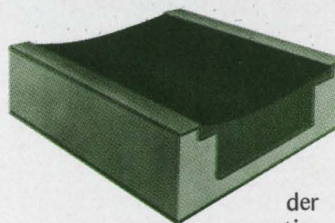

Dickson "single-chip" TC diodes are also available bonded in a ceramic channel for ease of handling and testing. These LID's are available with solder

coated runners for reflow mounting or with gold runners for wire bonding. In addition, Dickson supplies a wide variety of components in chip assembly form to hybrid manufacturers. Ask for details.



**DICKSON**  
ELECTRONICS CORPORATION

PHONE (602) 947-2231 TWX 910-950-1292 TELEX 667-406  
P. O. BOX 1390 • SCOTTSDALE, ARIZONA 85252

"Where Quality Makes the Difference"

INFORMATION RETRIEVAL NUMBER 92

# **BIPOLAR MEMORIES, 1974 UPDATE.**



Basically, what the chart on the right tells you is that Fairchild makes an awful lot of RAMs, ROMs and even PROMs.

That, and a lot more.

**We're No. 1. And then some.**

The chart tells you, for example, that Fairchild offers immediate 256-Bit ECL and TTL RAM availability.

What's more, we offer the only 256-Bit and 1024-Bit ECL RAMs available in quantity today. Also our first F10K ECL RAM, the 15ns 128-Bit F10405. Priced lower than many 64-Bit ECL RAMs.

We also offer the only 1024-Bit TTL RAMs available in substantial quantity.

And latest devices from Fairchild include our new full MIL 1024x1 RAM, listed as 93415DM, and our new 256x1 3-state RAM, listed as 93421DC.

In all, Fairchild offers the broadest line of bipolar RAMs available *period*.

And just for the record, we've shipped more RAM bits than all other bipolar RAM makers put together.

**The Isoplanar difference.**

Another thing to remember, only Fairchild RAMs are Isoplanar.

And in memories, Isoplanar fabrication can mean more compact devices with better performance.

Increased availability at reasonable prices.

And better dependability on the job.

**First ROMs and now PROMs.**

In addition to our existing Planar ROMs we now offer Planar TTL programmable ROMs, listed as 93416DC (open collector) and 93426DC (3-state).

**FAIRCHILD BIPOLAR MEMORY FAMILY**

Device Type ‡	Output †	Max. Read Cycle (ns)		Max. Write Cycle (ns)		100 to 999 Price	Availability
<b>TTL RAMs</b>							
<b>256X1</b>							
93410DC	OC	60	60	13.10		In Stock	
93410PC	OC	60	60	11.20		In Stock	
93410ADC	OC	45	45	14.60		In Stock	
93410DM	OC	70	70	26.20		In Stock	
93410FM	OC	70	70	35.00		In Stock	
93411DC	OC	55	55	15.00		In Stock	
93411DM	OC	75	75	33.00		In Stock	
93421DC	3S	50	50	15.00		In Stock	
93421DM	3S	70	70	33.00		In Stock	
<b>1024X1</b>							
93415DC	OC	90	90	56.00		Contact Fairchild Locally	
93415DM	OC	110	110	135.00		Contact Fairchild Locally	
<b>ECL RAMs</b>							
<b>128X1</b>							
F10405DC	—	15	15	15.00		In Stock	
<b>256X1</b>							
95410DC	—	40	40	21.00		In Stock	
<b>1024X1</b>							
95415DC	—	65	65	90.00		Contact Fairchild Locally	
<b>TTL PROMs</b>							
<b>256X4</b>							
93416DC	OC	60	—	22.00		In Stock	
93426DC	3S	60	—	22.00		Contact Fairchild Locally	
<b>TTL ROMs</b>							
<b>32X8</b>							
93434DC	OC	50	—	10.00*		8 wks. ARO (1st. 100 pcs).	
<b>256X4</b>							
93406DC	OC	50	—	14.00*		8 wks. ARO (1st. 100 pcs).	
93406PC	OC	50	—	13.20*		8 wks. ARO (1st. 100 pcs).	

\* Plus 600.00 mask charge — Minimum order 100 pcs. per mask.  
 † OC — Open Collector; 3S — Three State  
 ‡ D — Ceramic DIP; P — Plastic DIP; C — Commercial Grade; M — Military Grade  
 For more information call your nearest Fairchild Sales Office or Distributor.

**What next? Here's your chance to tell us.**

If you'd like a sample of our new devices, we'd like to send you one. All we ask you to do is something you'd probably like to do anyway. Simply write us a note on your company letterhead telling us about your memory needs. And where you think we should go from here.

*Future product requirements? More emphasis on RAMs, ROMs or PROMs? TTL or ECL logic? Number of words by bits? Read and write cycle times? New applications under consideration? Quantities required? And anything else you may wish to mention.*

In return we will send you a free sample of any one of the following three devices:

- 93410DC (256x1 TTL RAM)
- 95410DC (256x1 ECL RAM)
- F10405DC (128x1 ECL RAM)

Send your letter to Bipolar Memories, M.S. 20-1066, at the Fairchild address below. And of course, don't forget to indicate your free sample preference.

Along with your sample, we'd like to send you a special portfolio of information on Isoplanar memories.

It's yours free, too.

So write today.



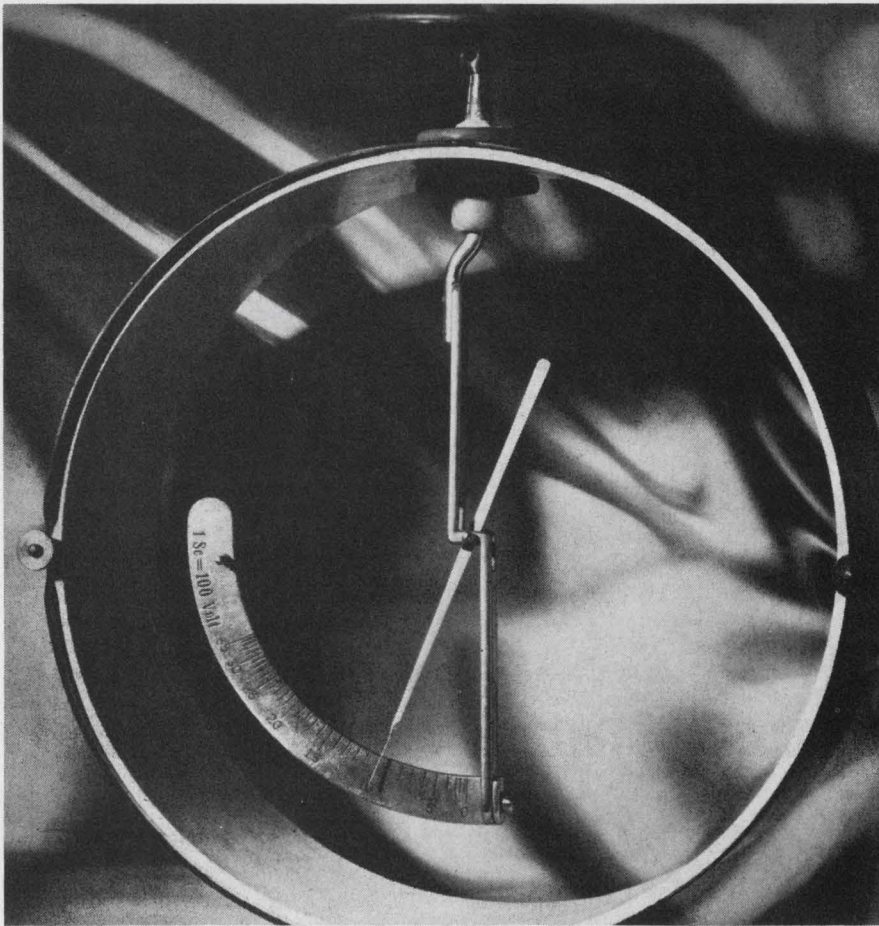

# How would you get a measureable signal from only 6,000 electrons per second?

Most people do it Victoreen's way

With just 6,000 electrons, our  $10^{12}$  RX-1 will give you a good clean one millivolt signal . . .

We've been making hi-meg resistors for over 30 years, making it possible for engineers like you to make big things out of little things. And with Victoreen RX-1 resistors, hi resistance is just one of the nice things you get . . . how about accuracy to  $\pm 1\%$ , good stability, and ranges from  $10^7$  to  $10^{14}$  ohms . . .

Victoreen . . . where else can you get so many accurate ohms for your money?

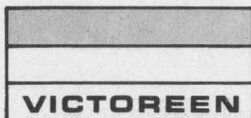

VICTOREEN  
INSTRUMENT DIVISION  
10101 Woodland Avenue  
Cleveland, Ohio 44104

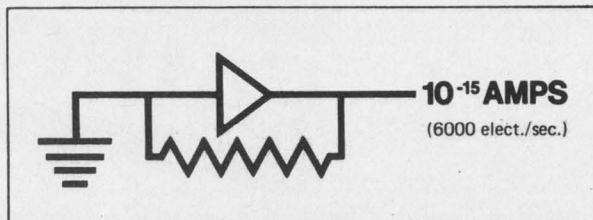

DMA 722

INFORMATION RETRIEVAL NUMBER 94

## DATA PROCESSING

### Acoustic coupler has 450-baud data rate

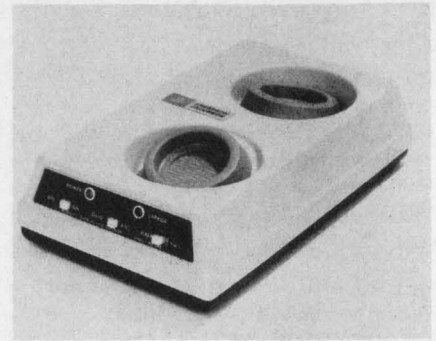

Andersen Jacobson, Inc., 1065 Morse Ave., Sunnyvale, Calif. 94086. (408) 734-4030. \$395; Nov.

The AD 342 acoustic coupler operates at speeds up to 450 baud with an EIA RS232C interface or a TTY interface. Full or half-duplex operation can be selected and the coupler can "originate" or "answer" calls. Performance features include  $-50$  dBm sensitivity (with direct access attachment), frequency accuracy of 0.1% and good immunity to ambient noise.

CIRCLE NO. 288

### Solid state controller has 60 input channels

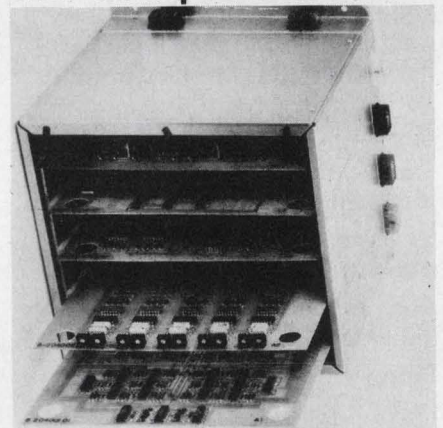

Electro Development Corp., 16700 13th Ave. W., Lynnwood, Wash. 98036. (206) 743-1313. From \$2000.

A high capacity logic controller, the EDC 8-150, features 20 output lines, a 60-channel input capacity and 86 logic commands. The unit interfaces with a wide variety of signal sources such as solid-state proximity switches, optical sensors and reed switches. The outputs can interface with solenoids, motors and computer peripherals.

CIRCLE NO. 289

## COM recorders operate on line or with mini

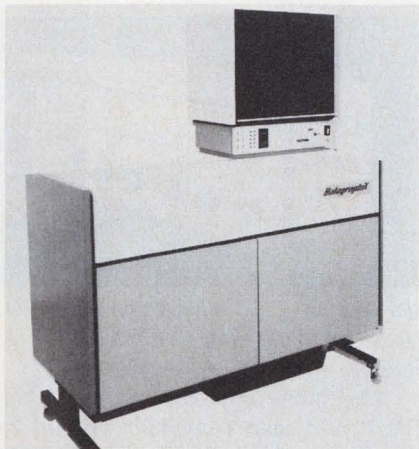

*Stromberg DatagraphiX, P.O. Box 2449, San Diego, Calif. 92112. (714) 283-1038.*

A family of computer-output-microfilm (COM) readers designated the system 4500 provide the choice of on-line, off-line or off-line with minicomputer operation. The off-line unit Model 130 accepts phase-encoded NRZI tapes; the on-line unit (Model 120) interfaces with IBM 360/370 computers. Model 150, with minicomputer, provides editing and data formatting capabilities. All units offer reductions of 24, 42 and 48 $\times$ . The camera records images in horizontal or vertical sequence on 105 mm microfiche or on 16 mm film. The characters are produced on a charactron CRT.

CIRCLE NO. 290

## Modem tester operates at speeds to 100-k

*Bowmar Instrument Div., 531 Main St., Acton, Mass. 01720. (617) 263-8361. \$750; 15 days.*

A modem test set, the model 251A, tests asynchronous and synchronous modems at rates of 150 to 9600 bit/s for asynchronous modems and zero to 100-k bit/s for synchronous modems. The tester combines a pattern generator, a self-synchronizing receiver, an error detector and a counter. Five different patterns can be selected and the counter displays the number of times the received pattern differs from the reference pattern. The test length is switch-selectable so that a known error rate per number of bits can be read directly on the display.

CIRCLE NO. 291

From out of the West . . .

## Switchlight combinations that just don't quit!

In the old days, the Western general store seemed to handle everything, and the price was right. When it comes to modern, reliable switchlights, think of us the same way. Gang switch assemblies . . . snap in adapters . . . special military switchlights . . . Monoform . . . switchlights so compact you could mistake them for shucked peas . . . some others so new they aren't on the shelf yet. But, unlike the general store, we deliver . . . and in a hurry! Just tell us what you need, and depend on Clare-Pendar.

 **CLARE-PENDAR™**  
Phone 208-773-4541

P.O. Box 785 Post Falls, Idaho 83854  
Telex 32-6448



DATA PROCESSING

**Test set generates or can recycle 128 characters**



Mission Data Products, P.O. Box 2254, Westminster, Calif. 92683. (714) 892-0911. \$795; 2 to 8 wks.

Up to 128 characters of data can be received then retransmitted—a line or character at a time—by the model 578 Data Analyzer. And the unit displays the received data as well as the RS 232 interface control signals. The model 578 generates and detects Baudot, IBM and ASCII code formats at rates up to 1200 baud (9600 baud with external clock). Hookup is simple. The Data Analyzer is interposed between terminal and modem by use of RS 232 connectors.

CIRCLE NO. 292

**Flatbed plotter improves mini-generated graphics**

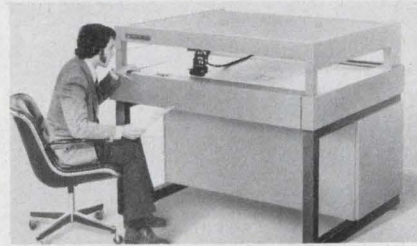

Xynetics, 6710 Variel Ave., Canoga Park, Calif. 91303. (213) 887-1022. \$22,500; 10 wks.

A flatbed plotter, designated the Model 1050, offers 0.001-in. resolution, 0.005-in. accuracy and a repeatability of 0.001-in. The positioner moves the drawing head at plotting speeds up to 40 in/s. The interaction of magnetic fields replaces the usual gears, pulleys or lead screws. The model 1050 also features a plotting surface of 33-by-45 in. Standard interface modules are available for the IBM 1130, the Data General Nova-800/1200 and 820/1220, the PDP-11 series and the HP-2100A computers. Price is \$22,500 in five-unit quantity.

CIRCLE NO. 293

**Scan converter boasts 3000-line resolution**

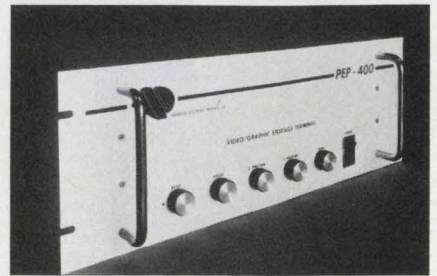

Princeton Electronic Products, P.O. Box 101, North Brunswick, N.J. 08902. (201) 297-4448.

The 3000 line resolution of the PEP 402 scan converter is said to be the highest available commercially. The proprietary silicon-silicon oxide storage tube used can provide a 10 log-level gray scale range, nondestructive readout and continuous display for 30 min. The PEP 402 can "frame grab" images and convert slow-scan information to TV-compatible formats. Other members of the PEP 400 series include a 525-line X-Y-Z to TV raster converter (PEP 404) and 525-line analog waveform storage units (PEP 405 and 406).

CIRCLE NO. 294

**INNOVATIVE SWITCHES by CDI**

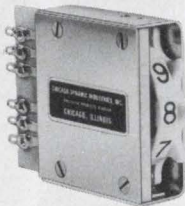

Sealed Switch Module. Completely sealed and/or RFI shielded.

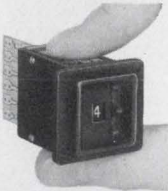

Series TSM Mini Thumb-wheel switch mounts on 1/2" centers. Retrofit most miniature thumb-wheel switch panel openings.



Series SL (Pat. Pending) Linear Slide Switch. Up to 100 or more positions. Mounts EITHER left/right OR up/down. Single or multiple position selectors.



No Down-Time Rotary Switch. 5-Second wafer replacement. Mfd. under Tabet U.S. Patent 2,956,131 & others.

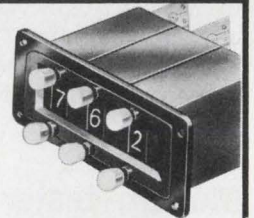

Miniature Add/Subtract Pushbutton units retrofit most mini-thumb-wheel switch panel openings. Pat. #3,435,167.



Series SP Rotary Switch. Economical, flexible, compact. More options on one wafer than previously available.

CDI earns its reputation every day for Consistently High Quality, Consistently Good Delivery. Request catalog.



**CHICAGO DYNAMIC INDUSTRIES, INC.**  
PRECISION PRODUCTS DIVISION

1725 Diversey Blvd., Chicago, Illinois 60614 Phone (312) 935-4600, TELEX 25-4689

# BARGAINS GALORE on LEDs from DIALIGHT

## FEATURES:

High luminous intensity

Low cost

Low power consumption

IC compatible

Vibration/shock resistant

Solid state reliability

Life measured in years

Wide viewing angle



Dialight's high brightness 521-9200 LED is an intense large area light source that has this typical luminous intensity:

@  $I_F = 20 \text{ mA}$   $I_0 = 2.0 \text{ mcd}$ .

## APPLICATIONS:

Panel lighting • Circuit-status indicators • Back lighting of annunciators • Alpha-numeric displays • Automobile dashboards • Appliances • Desk-top calculators • Housewares

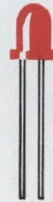

# 9¢

Quality LEDs are 9¢ each when purchased in million piece quantities



# 21¢

LEDs from 100 to 999 are only 21¢ each.

# 17¢



If you need LEDs from 1000 to 9999, Dialight has them for 17¢ each.

# 28¢

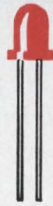

Even if you only need LEDs from 1 to 99, Dialight has them for 28¢ each.

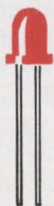

# 16¢

Quantities from 10,000 are a low 16¢ each and Dialight can fill your order today

# FREE!

With this coupon you can get a free LED sample. Send this coupon to your nearest Dialight distributor or give him a call.

## DIALIGHT DISTRIBUTORS

**ARIZONA**  
Moltronics of Arizona, Inc.  
602-272-7951

**CALIFORNIA**  
Western.  
Electromotive  
213-870-7621  
Bell Electronics Corp.  
415-323-9431  
Fisher/Brownell  
408-244-6182  
Richey Electronics, Inc.  
213-875-2862  
Westates  
Electronics Corp.  
213-341-4411

**COLORADO**  
Meter Master  
Instrument Corp.  
303-722-5766

**FLORIDA**  
Hammond  
Electronics, Inc.  
305-241-6601

**ILLINOIS**  
Newark Electronics  
312-638-4411

**INDIANA**  
Graham Electronic  
Supply, Inc.  
317-634-8486  
Radio Distributing Co.  
219-287-2911

**MARYLAND**  
Pioneer Washington  
Elect. Co.  
301-424-3300  
Radio Electric  
Service Co.  
301-823-0070

**MASSACHUSETTS**  
Cramer Electronics,  
Inc.  
617-969-7700  
DeMambo Supply  
Co., Inc.  
617-787-1200  
Gerber Electronics, Inc.  
617-329-2400  
Sager Electrical  
Supply Co.  
617-542-2281

**MICHIGAN**  
RS Electronics  
313-491-1000

**MINNESOTA**  
Gopher Electronics Co.  
612-645-0241

**MISSOURI**  
Lcomp-St. Louis, Inc.  
314-647-5505

**NEBRASKA**  
Scott Electronic Supply  
402-434-8308

**NEW JERSEY**  
Federated Electronics  
201-376-8900  
Resco Electronics  
609-662-4000

**NEW YORK METROPOLITAN AREA**  
Arrow Electronics,  
Inc.  
516-694-6800  
Harvey Radio Co.,  
Inc.  
516-921-8700  
Melville Radio Corp.  
914-592-7100  
Peerless Radio Corp.  
516-593-2121

**NEW YORK STATE**  
Summit Distributors,  
Inc.  
716-884-3450

**NORTH CAROLINA**  
Hammond  
Electronics of  
Carolina, Inc.  
919-275-6391

**OHIO**  
Pioneer-Cleveland  
Div.  
Pioneer-Standard  
Electronics  
216-587-3600  
Stotts-Friedman Co.  
513-224-1111  
Sun Radio Co., Inc.  
216-434-2171

**PENNSYLVANIA**  
Almo Electronics  
Corp.  
215-676-6000  
George D. Barbey Co.  
215-376-7451  
Cameradio Co.  
412-288-2600

**TEXAS**  
Harrison Equipment  
Co., Inc.  
713-224-9131

**UTAH**  
Standard Supply Co.  
801-355-2971

**WASHINGTON**  
Almac/Stroum  
Electronics  
206-763-2300

**WISCONSIN**  
Parts Mart Corp.  
414-276-4160

**CANADA**  
Saynor Electronics Ltd.  
416-445-2347  
L. A. Varah Ltd.  
604-736-9252

All prices are domestic and subject to change without notice.

# FREE!

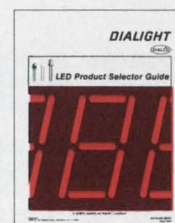

Ask for free LED Product Selector Guide. 60 pages of LEDs: discretes, indicators, displays, fault indicators, opto-isolators, etc.

# DIALIGHT

Dialight Corporation, A North American Philips Company  
60 Stewart Avenue, Brooklyn, N.Y. 11237 (212) 497-7600

INFORMATION RETRIEVAL NUMBER 97

# Guess what's new in HYBRIDS

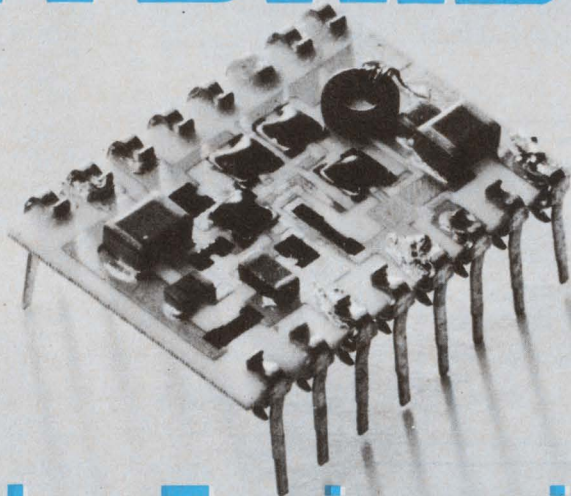

## Pulse Engineering!

**NOW 10 YEARS OF HYBRID EXPERIENCE  
COMBINES WITH 15 YEARS OF  
MINIATURE MAGNETIC CAPABILITY  
GIVING YOU:**

- Vast creative design experience
- Proficiency in communications and instrumentation
  - Excellent designer-to-designer rapport
    - High volume capability
    - Special regard for cost

### 3 WEEK DELIVERY

- Resistor networks
- Pull up/pull down networks
- High voltage 4-digit display networks

# Pulse Engineering

P.O. Box 12235 • San Diego, Calif. 92112  
Phone 714-279-5900 • TWX 910-335-1527

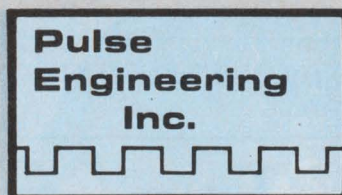

A Varian Subsidiary

## DATA PROCESSING

### Source records captured by card reader/tape set

*Decision, Inc., 5601 College Ave.,  
Oakland, Calif. 94618. (415) 654-  
8626. \$15,000.*

An optical mark reader and IBM-compatible tape drive capture and store up to 7200 source records. The MCS-1 system reads forms in sizes from 3 × 5-in. to 8.5 × 11-in. The reader permits entry of block-print numerics, marked data and plastic card impressions. If desired, additional records entered from an auxiliary keyboard can be merged with scanned records on the tape.

CIRCLE NO. 295

### Chart recorder shares two channels on one pen

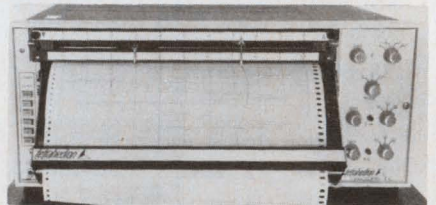

*Tetrahedron, Inc., 7605 Convoy  
Ct., San Diego, Calif. 92111. (714)  
277-2820.*

One pen writes continuously while the other is shared between two channels—a feature that allows the RS-360 chart recorder to handle three channels. Range switches for each pen are scaled in steps of 1, 2 or 5 units—10 mV to 50 mV for pen 1 and 100 mV to 100 V for pen 2. Chart speeds from two to 240<sup>-1</sup> in/min can be selected in 12 steps.

CIRCLE NO. 296

### Audio-response device used for routing tests

*Cognitronics Corp., 25 Crescent  
St., Stamford, Conn. 06906. (203)  
327-5307. \$1995.*

Nicknamed "Ava" for automatic verification announcer, the audio response unit answers trunk verification calls with the area code and exchange identification. A MOS ROM stores information for 10 spoken digits 0 to 9. A single Ava installation handles up to 10 exchanges and eliminates the need for assistance from "A" board telephone operators to verify trunk routing of the dialed exchange.

CIRCLE NO. 297



# Everything you need in ferrites

**MADE IN  
SAUGERTIES**

**Broad Product Line:** Ferroxcube offers a complete array of sizes and shapes of ferrite cores. They're made in Saugerties, N.Y. and stocked throughout the U.S.A. Toroids for pulse transformers, pot cores or square cores for precision filters, transformer cores in all sizes and shapes— E, U, I, specials and read-only memory cores—you can trust Ferroxcube to provide the optimum core for your inductors.

**Unsurpassed Materials Technology:** Ferroxcube, the acknowledged U.S. leader in ferrite technology, offers a wide range of standard materials for your cores. Chances are that one of them has exactly the *right combination of characteristics* for your application. And, you can depend on Ferroxcube to deliver the same uniform,

product characteristics year after year for consistent, optimum circuit performance in your designs.

**24-hour Availability:** Standard components are available for 24-hour delivery from any of seven warehouses conveniently located in Boston, New York, Saugerties, Philadelphia, Chicago, Santa Clara and San Diego.

If you're up on the advantages of ferrites, discover the added values of dealing with Ferroxcube. Ask for the new 1973 catalog. If you're new to ferrites and the design possibilities they open up, talk to one of our applications engineers. Call 914•246-2811, TWX 510-247-5410 or write Ferroxcube, Saugerties, N.Y. 12477.

Ferroxcube linear ferrites—made in Saugerties, N.Y. and stocked in seven U.S. locations.



**FERROXCUBE** CORPORATION, SAUGERTIES, N.Y. 12477

A NORTH AMERICAN PHILIPS COMPANY

Distributed through North American Philips Electronic Components Corporation with warehouses in Boston, 617•449-1406; New York, 516•538-2300; Saugerties, 914•246-5861; Philadelphia, 215•927-6262; Chicago, 312•593-8220; Santa Clara, 408•249-1134; San Diego, 714•453-9250

16402

INFORMATION RETRIEVAL NUMBER 99



# HELP IS ON THE WAY!

**WHEN YOU SEE THE GOLD BOOK,  
YOU'LL WONDER HOW YOU  
EVER GOT ALONG WITHOUT IT**

If you've never used a directory before, THE GOLD BOOK will astonish you with its convenience and utility. If you are accustomed to currently available directories, THE GOLD BOOK will introduce you to what a directory should be. From mid-year on, you'll be referring to it daily for purchasing information and catalog data.

THE GOLD BOOK contains more useful and more detailed listings in its directories; more directory

pages; more catalog pages divided into more product classifications than ever assembled in one convenient package. THE GOLD BOOK puts the entire electronics industry at your fingertips. It's the complete one-step purchasing tool — a place where you can find what you want to find — and find it easily.

Watch for it mid-year '74. THE GOLD BOOK is another information service, FREE, to *Electronic Design* subscribers.

## PASS THE WORD

**HERE'S THE ADVERTISING BARGAIN OF THE CENTURY — PLEASE TAKE A MINUTE TO ALERT YOUR ADVERTISING AND MARKETING PEOPLE — SAVE THOUSANDS OF DOLLARS FOR YOUR COMPANY**

There's never been a bargain like this, never such a fantastic marketing opportunity:

**FOR EVERY PAGE OF ADVERTISING YOUR COMPANY PLACES IN ELECTRONIC DESIGN IN 1974 . . .  
IT EARNS A PAGE OF SPACE FREE IN THE 1974 GOLD BOOK!**

\$4,000,000 — 4,000 pages are up for grabs through this offer. Some of it can be your company's. Your advertising people will never forgive themselves (or you) if they miss this opportunity. Be sure to pass the word. (If they need more information, ask them to contact Tom Carr, V.P. Sales, at 201-843-0550. Tell them to act fast, FREE PAGES are on a first-contracted — first-reserved basis.)

NOTE: Be sure your company takes advantage of FREE LISTINGS in THE GOLD BOOK. Do your company, and us, a favor by requesting a listings questionnaire. Just indicate your ad manager's name on the card bound-in next to this ad. We'll contact him by return mail.

# THE GOLD BOOK

## Electronic Design's 1974 Master Directory



## Turn to Amphenol—your new mini-power supplier.

New Amphenol miniaturized regulated power supplies are in stock for immediate shipment. Ideal for use with CMOS, op amps, and simple DC circuits. Single output styles range from 3 to 28 volts (50 ma to 1500 ma) in sizes as small as 2.3" x 1.8" x 1.0". Dual models with tracking outputs are also available in popular sizes and ratings.

Special design features include excellent regulation and ripple parameters as well as short circuit protection. In addition,

rugged encapsulated construction and generously derated components assure years of reliable operation.

There's no better way to meet your mini-power supply needs, whether you're talking quality, availability, or advantages over in-house construction. Good reasons to make an Amphenol distributor your local power supplier. Call him for our catalog or contact us: Amphenol Component Marketing Service, 2575 S. 25th Ave., Broadview, Ill. 60153. 312/345-4260.

**BUNKER RAMO** **AMPHENOL**

INFORMATION RETRIEVAL NUMBER 100

## These distributors are stocking Amphenol mini-power supplies.

### DRW ELECTRONICS CORP.

100 Milbar Blvd.  
Farmingdale, NY 11735  
516-249-2660  
600 Pleasant Street  
Watertown, MA 02172  
617-923-1900

### MOLTRONICS

5610 East Imperial Hwy  
South Gate, CA 90280  
213-773-6521  
TWX: 910-583-1947  
7969 Engineer Road  
San Diego, CA 92111

### MOLTRONICS OF ARIZONA

2746 West Palm Lane  
Phoenix, AZ 85009  
602-272-7951  
TWX: 910-951-1512

### PYTTRONICS

#### INDUSTRIES, INC.

Stump Road—PO Box 433  
Montgomeryville, PA 18936  
215-643-2850  
TWX: 510-661-6593  
8220 Wellmorr Court  
Savage, MD 20863  
301-792-7000

### SCHUSTER ELECTRIC COMPANY

11320 Grooms Road  
Cincinnati, OH 45206  
513-984-1600  
Telex: 21-4112

### SOLID STATE ELECTRONICS COMPANY

2643 Manana Drive  
Dallas, TX 75220  
214-352-2601

### STERLING ELECTRONICS

1061 Industrial Way  
San Carlos, CA 94070  
415-592-2353  
Telex: 34-8451  
TWX: 910-376-4398

### ZEPHER ELECTRONICS SALES CO.

152 Southwest 153rd  
Seattle, WA 98186  
206-242-2517



# AMPHENOL

## PACKAGING & MATERIALS

### Cooling fan uses brushless dc motor

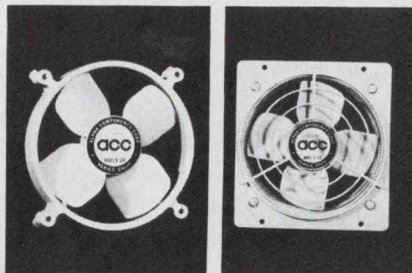

Alpha Components Corp., 115 Eucalyptus Dr., P.O. Box 947, El Segundo, Calif. 90245. (213) 322-7780. \$16.40 (500 up); stock.

A new brushless dc cooling fan operates from 24 V dc and draws only 1.5 A. Designated Model D-24, the fan supplies 150 ft<sup>3</sup>/min of air at 24 V, 75 at 12 V and 160 at 28 V. The axial fan weighs only 24 oz, complete with grille and venturi. It measures 5 in. in diam and 2-3/8 in. deep and it mounts on 4.125-in. centers.

CIRCLE NO. 298

### Mold-release agent packaged in aerosol can



Starnetics Co., P.O. Box 9308, North Hollywood, Calif. 91604. (213) 766-4890. \$3.95 per 16 oz can; stock.

The new mold-release agent, MR-501, has a high-temperature tolerance and it is packaged in 16-oz aerosol containers. It provides an ultra-thin film and does not exhibit the usual residue build-up effect. This release agent can also be used as a dry-film lubricant and is compatible with most industrial plastics, rubbers, ceramics, glasses and metals.

CIRCLE NO. 299

### Gold can be plated by electrodeless process

Engelhard Industries, 430 Mountain Ave., Murray Hill, N.J. 07974. (201) 464-7000.

A special electrodeless gold process can deposit a pure gold (99.99+%) plating at a rate of 2.5 to 3.1  $\mu$ /h. The deposits are ductile, soft and have excellent die-bonding and solderability characteristics, according to Engelhard. The new process can plate discontinuous circuits and provide a uniform distribution on complex shapes and in deep, small, aperture cavities. The process is capable of depositing gold on gold, thereby making it a truly auto-catalytic process.

CIRCLE NO. 300

### Nonbrittle PM material near strength of ceramic



3M Company, 3M Center, St. Paul, Minn. 55101. (612) 733-1590.

Plastiform 1.4H is a permanent magnet material that compares favorably with oriented ceramic magnets in strength, but does not have the brittleness of a ceramic. It is a nitrile, rubber-bonded, barium-ferrite composite material. Ceramic type-2 magnets have stronger residual induction (2800 gauss) as compared with 1.4H material (2540), but the Plastiform magnet has greater demagnetizing resistance (3250 oersteds compared with ceramic's 3000). And the 1.4H material has a coercive force of 2200 oersteds compared with ceramic's 2400. The 1-4H material has a maximum energy product that is 30% greater than its predecessor, Plastiform 1H material. 3M says that Plastiform, unlike brittle ceramics, can be flexed, twisted and bent without breaking or losing magnetic energy. In addition, the company says Plastiform is easily cut, slit, punched, stamped, drilled or milled and can be machined into complex configurations.

CIRCLE NO. 301

### Cap nuts made of nylon resist damage

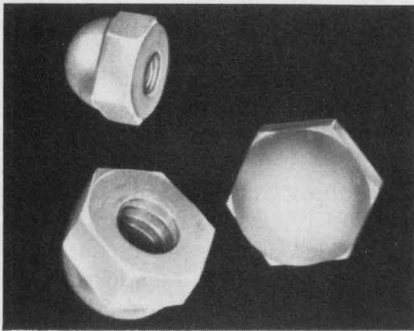

Non-Metallics, Inc., 58 Felton St., Waltham, Mass. 02154. (617) 899-2530.

A complete line of precision, molded-nylon, cap nuts are available in seven standard sizes: 4-40, 6-32, 8-32, 10-24, 10-32, 1/4-20 and 1/4-28. They protect protruding threads and provide an attractive finished appearance. The nuts are self-locking, and they have excellent abrasion, scratch and dent resistance, and thus they can retain an attractive appearance much longer than can metal cap nuts.

CIRCLE NO. 302

### Tiny cable connector fits 30-gauge wire

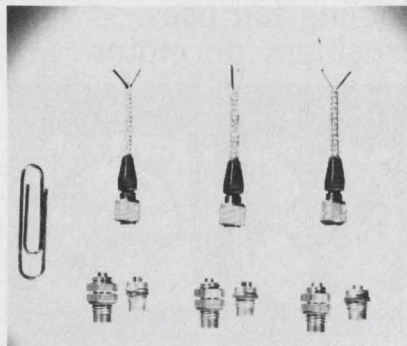

Microtech, Inc., 777 Henderson Blvd., Folcroft, Pa. 19032. (215) 532-3388. \$0.95 (OEM qty); stock.

These two, three, and four-pin cable connectors provide the extreme miniaturization often required in transducer, instrumentation, medical and computer applications. The outer diameters are less than 0.110 in. and they fit a Teflon-insulated, stranded, 30-AWG shielded cable. All bodies, pins and sockets are gold-plated brass; the dielectric inserts are made of TFE Teflon and the washers, silicone rubber.

CIRCLE NO. 303

### Fastener connects with partial turn

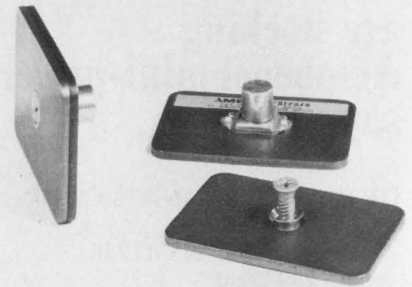

Ametek/Straza, 790 Greenfield Dr., El Cajon, Calif. 92022. (714) 442-3451.

The Ametek/Straza, Zahodiakin, positive-retention, rotary fastener allows quick access to doors, panels and structural members. Ametek/Straza claims that this fastener is one of the most rapidly threaded fasteners on the market and that it will not cross thread. Fastener connection is achieved by simply pushing the threaded stud firmly into the receptacle and then making a partial turn with a screwdriver. The stud self-adjusts to compensate deformation in panels being secured.

CIRCLE NO. 304

HP COUNTERS PROMISE A LOT — AND DELIVER IT ALL.

# The counter system that

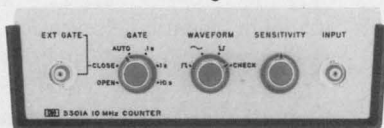

**5301A — 10 MHz Module:** 10 Hz to 10 MHz range. Direct counting and totalizing to over 10 MHz. Automatic or manual gating. Input waveform selector. External gate control. \$145.



**NEW 5306A — Digital Multimeter/Counter Module:** Six-digit frequency readings to 10 MHz. Five full digits of AC/DC volts, ohms. Floating, guarded input. Automatic zero adjust. Up to 10 readings/sec. Overload protection. \$450.

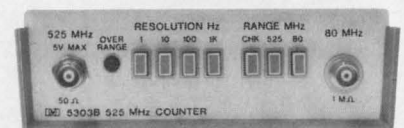

**5303B — 525 MHz Counter Module:** DC to 525 MHz range, burst or CW frequency. 50Ω or 1 MΩ input. Automatic gain control. Fuse protected front end. Optional high stability time base (FCC Type-Approved). \$800.

The heart of HP's versatile frequency/time/volts/ohms measurement system is the sophisticated six-digit HP 5300A mainframe (\$395) which contains basic counting circuitry. Snap this mainframe onto the bottom module you need and it instantly becomes one of six feature-loaded instruments — each with traditional HP quality and ruggedness... each operating

from power line or optional battery pack.

Best of all, once you have the mainframe, it's the low cost way to build a complete workshop of first-line instruments. It's the one system that truly does stay on top of your needs — and your budget.

Send for a free detailed brochure on HP's 5300 Series Counters.

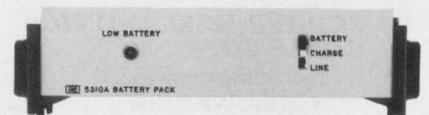

**Battery Pack Module:** Sandwiches in between any mainframe/module combination. Permits up to 5 hours of continuous operation. Battery level indicator. Recharge while in use. Carrying handles and shoulder strap. \$195.

02306

All prices domestic U.S.A. only.

## DIP connector can terminate flat cables

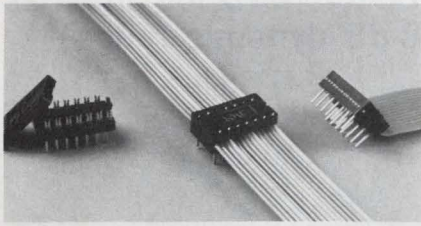

Amp Inc., Harrisburg, Pa. 17105.  
(717) 564-0101.

The AMP Latch Connector provides instant multiple terminations for flat cable having round conductors on 0.050-in. centers as well as for woven flat cable. The conductors can be 28 stranded or 30 solid AWG wire, and all terminations are made simultaneously without a need for prestripping the insulation. Connectors can be applied at the end of a cable or anywhere in its length. The 14 or 16-position plugs mate with a DIP header or they can be inserted directly onto the board and soldered. Other configurations include 10 to 50-position receptacles that mate with two rows of 0.025-in. square posts on 0.100-in. centers.

CIRCLE NO. 305

## Formica cases house test instruments



W.A. Miller Co., Inc., Mingo Loop,  
Oquossoc, Me. 04964. (207) 864-3344. \$15.90 to \$52 (100-200).

These ruggedized cases for instruments feature laminated Formica-wood-Formica, which is made with a waterproof epoxy glue cured under heat and pressure, and internally reinforced corners. The cases are suited for portable, field, test equipment as well as for laboratory instruments. Special Neoprene gaskets seal the case against moisture and dust. A new suede finish in a choice of wood-grain or solid-color patterns is standard.

CIRCLE NO. 306

## Aluminum extrusion holds DIP devices

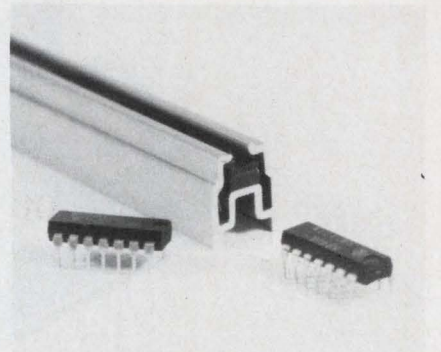

Aham, 968 W. Foothill Blvd., P.O. Box 909, Azusa, Calif. 91702.  
(213) 334-5135.

AHAM 7026 is an aluminum extrusion (6063-T5) specially designed to store the popular 14 and 16-lead DIP devices. The aluminum construction can provide good thermal conductivity to the devices during temperature-cycling and thermal-shock treatment. The holder can also be used to load DIPs into IC handlers for functional testing. The extrusion can be ordered in any length and with a variety of finishes.

CIRCLE NO. 307

# stays on top of your needs.

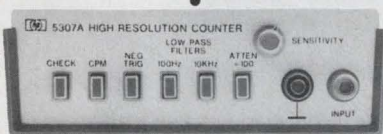

**NEW 5307A — High Resolution Module:** Range, 5 Hz to 2 MHz and 50 to  $1 \times 10^7$  counts/minute (CPM). Measures frequency and RPM much faster than conventional counters... 0.0001 Hz or 0.001 CPM resolution in less than 1 second. \$350.

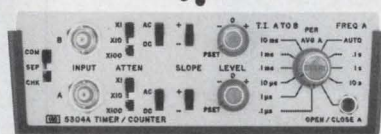

**5304A — 10 MHz Timer/Counter Module:** DC to 10 MHz range. 100 nsec. time interval accuracy. Unique "Time Interval Holdoff" ignores input ringing or contact bounce. Two DC coupled amplifiers with attenuators, slope, polarity and gain control. \$325.

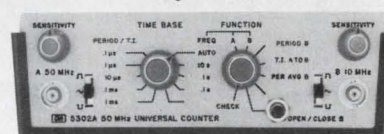

**5302A — Universal 50 MHz Counter Module:** 10 Hz to 50 MHz range. Automatic or manual gating. 100 nsec. time interval accuracy. Period, period average, ratio and totalize functions too. Input waveform selector. \$275.

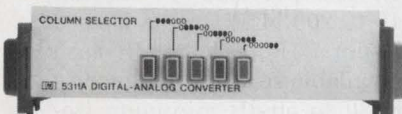

**Digital-to-Analog Converter Module:** Sandwiches in between modules — even with battery in place. Permits high resolution analog plots of digital measurements. Galvanometer and potentiometer recorder output. \$295.

HEWLETT  PACKARD

Sales, service and support in 172 centers in 65 countries.  
Palo Alto, California 94304. Offices in principal cities throughout the U. S.

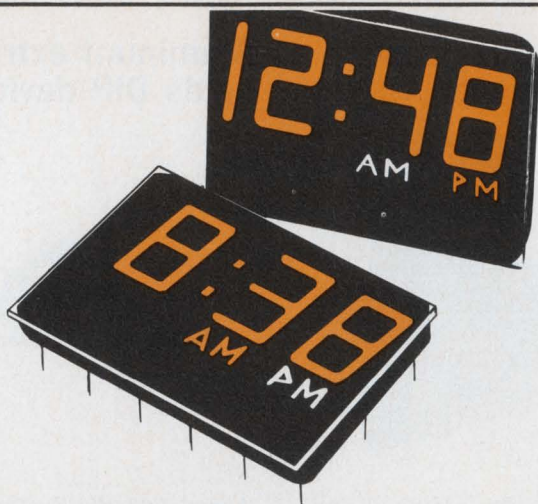

## New SPERRY™ Clock Display

**lowers cost of electronic clocks!** This unique SPERRY Clock Display not only helps cut engineering expense, reduce assembly time and lower component cost,

it looks a lot better than other displays now on the market.

**FOR COMPLETE TECHNICAL INFORMATION,**

write Sperry Information Displays, P.O. Box 3579, Scottsdale, Arizona 85257 or phone (602) 947-8371.



There's more eye appeal in SPERRY Displays!

INFORMATION RETRIEVAL NUMBER 102

## FREE '74 Heathkit catalog

... fully describes the new Heathkit IB-1103 Counter featuring phase-locked multiplier, extremely high resolution with 8½-digit readout and 180 MHz capability. Pushbuttons permit multiplication by 1 (direct), 10, 100 or 1000. Also, it has temperature compensated crystal oscillator (TCXO) and pushbutton selection of 1 msec., 100 msec. and 1 sec. gate times. Input sensitivity is 50 mV to 120 MHz and 100 mV to 180 MHz. Includes lighted indicators for MHz, kHz, Hz, Gate, Overrange and unlocked conditions. Kit utilizes plug-in circuit boards for fast assembly. Mail order price, \$379.95\*. Shipping weight, 12 lbs. ... there are more than 350 other Heathkit products for '74. Including assembled and kit-form automotive and lab test instruments. Kits for every interest — marine, ham, color TV, stereo hi-fi, automotive, home appliances, educational, etc.



Send for your **FREE Heathkit catalog, NOW**

HEATH  
Schlumberger

HEATH COMPANY, Dept. 60-1  
Benton Harbor, Michigan 49022

Please send FREE Heathkit Catalog.

Please send IB-1103. Enclosed is \$379.95, plus shipping.

Name \_\_\_\_\_

Address \_\_\_\_\_

City \_\_\_\_\_ State \_\_\_\_\_ Zip \_\_\_\_\_

\*Mail order prices; F.O.B. factory. TE-297R

INFORMATION RETRIEVAL NUMBER 103

## MICROWAVES & LASERS

### Dc-to-5-MHz log amp has 8-dB dynamic range

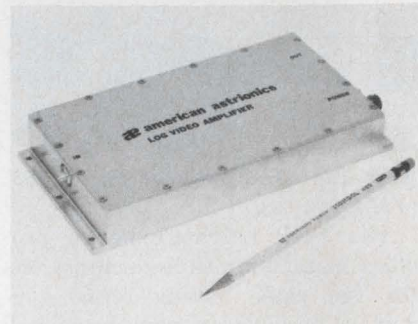

American Astrionics, Div. of Technicolor Corp., 291 Kalmus Dr., Costa Mesa, Calif. 92626. (714) 557-8480. \$500 to \$800; 4 wk.

A dc-to-5-MHz log amp can accommodate an input dynamic range as high as 80 dB, with input voltages as low as 70  $\mu$ V and as high as 2 V. The output voltage range of the dc-coupled log amp is 0 to 3 or 0 to 4 V. Pulsed data can be processed at duty factors exceeding 25%. Each dc amplifier is tested to ensure that a small pulse whose leading edge occurs 2 to 3  $\mu$ s after the trailing edge of a large pulse can be accurately detected, and that its amplitude will always be within the specified log linearity of  $\pm 0.75$  dB.

CIRCLE NO. 308

### DIP switches operate from 10 to 200 MHz

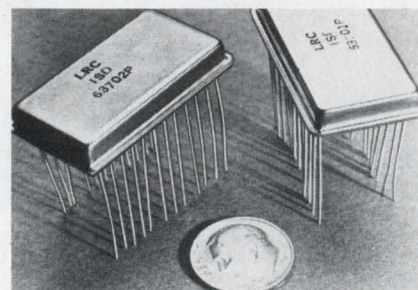

LRC, Inc., 11 Hazelwood Rd., Hudson, N.H. 03051. (603) 883-8001.

A series of integrated switches and drivers provides rf control from 10 to 200 MHz and is housed in a 24-pin DIP package. In each of six available series, three models provide 30 to 50-dB minimum isolation and from 1.5 to 2.2-dB maximum insertion loss. No bias connections or dc blocks are required in the rf line. Driver inputs are TTL compatible.

CIRCLE NO. 309



# **This is it !**

**THE SUPER CONTEST  
OF ALL  
SUPER CONTESTS  
FOR**

**(1) Electronic Design READERS**

**(2) ADVERTISERS & THEIR ADVERTISING AGENCIES**

**Electronic Design's**

**1974 SUPER  
TOP TEN CONTEST**

*TURN THIS PAGE  
TO SEE THE  
VALUABLE  
PRIZES THAT  
CAN BE YOURS*

# WOULD YOU LIKE A CAREFREE WEEK FOR TWO IN THE BLUE CARIBBEAN?

Relax or lend a hand, swim, scuba dive, or just put your feet on the rail. Visit exotic tropical islands and foreign ports. It's the vacation for thinking people with a spirit of adventure. Sail in air conditioned comfort on big, safe windjammers. Choice of Bahamas, Virgin Islands, Windward or Leeward islands cruises. Pick your own departure dates. It's a trip you'll always remember. AND it's only part of the big first prize offered this year.

## PLUS: \$1,000 IN CASH!

Everyone can use some extra money—especially on a cruise. Use it for babysitters, tropical clothes, shop the free ports, bank it or spend it. It goes along as an extra bonus to the lucky first prize winner who picks the Top Ten ads in the January 4 issue.



**REPEATING  
BY POPULAR  
DEMAND**

**Electronic**  
**1974 SUPER TOP**

"TRY YOUR LUCK -- ENTER THE CONTEST"

## AND: FREE AIR TRANSPORTATION

This really makes the 1st prize complete. Think about it! The cruise . . . the \$1,000 in cash, AND free round-trip tickets for two on



regularly scheduled airlines to the cruise's point of departure. It all adds up to the vacation of a lifetime. AND, **you** can be the lucky winner!

## AND: YOU CAN WIN VALUES UP TO \$4,500—OR MORE— FOR YOUR COMPANY

Another big feature of the Top Ten Contest is the free advertising you can win for your company. Here's what your company can win if it has an ad in the January 4 issue:

**A FREE RERUN . . .** for each of the ads that are voted in the Top Ten by *Electronic Design's* readers.

**A FREE RERUN . . .** if one of your company's engineers wins any one of the first 3 prizes — whether or not your ad placed in the top ten.

**A FREE RERUN . . .** if one of your company's advertising or marketing people, or your advertising agency, wins any of the first 3 prizes.

Suppose you are one of the first three prize winners. If your company has a full page, 2-color ad in the January 4 issue, your company will receive a free rerun worth \$2,375. But suppose it is a 4-color spread. You've just racked up space worth \$4,700 for your top brass.

Be sure to alert your advertising or marketing manager to these possibilities. Urge him to schedule your company's ad in the January 4 issue . . . It's an opportunity no company can afford to miss.

# Design

# TEN CONTEST

COMPLETE INSTRUCTIONS ON PAGE 230

## PLUS 99 OTHER VALUABLE PRIZES

There are two separate Top Ten Contests, one for **Electronic Design's** engineer-readers, and one for advertisers and their advertising agencies.

### PRIZES (Reader Contest)

- 1st Prize: Windjammer cruise for two.  
Air transportation for two.  
\$1,000 cash.  
Free ad rerun.
- 2nd Prize: Portable color TV.  
Free ad rerun.
- 3rd, 4th & 5th Prizes: Bulova timepieces.  
Free ad rerun (3rd Prize only).
- 6th thru 100th Prizes: Technical books.  
(Title to be announced.)

### PRIZES (Advertiser Contest)

- 1st Prize: Windjammer cruise for two.  
Air transportation for two.  
\$1,000 cash.  
Free ad rerun.
- 2nd Prize: Portable color TV.  
Free ad rerun.
- 3rd Prize: Bulova timepiece.  
Free ad rerun.

## NO STRINGS, NO GIMMICKS ... HERE'S ALL YOU HAVE TO DO TO ENTER

- (1) Read the January 4th issue of *Electronic Design* with extra care.
- (2) Select the ten advertisements that you think will be best remembered by your 79,666 fellow engineer readers.
- (3) Identify the advertisements by company name and *Information Retrieval Number* (Reader Service Number) on the entry blanks bound in the issue. Mail before midnight February 15.

## THIS IS THE CONTEST ISSUE LOOK FOR RULES ON PAGE 230

Entry blanks are bound inside the front and back covers of this issue.

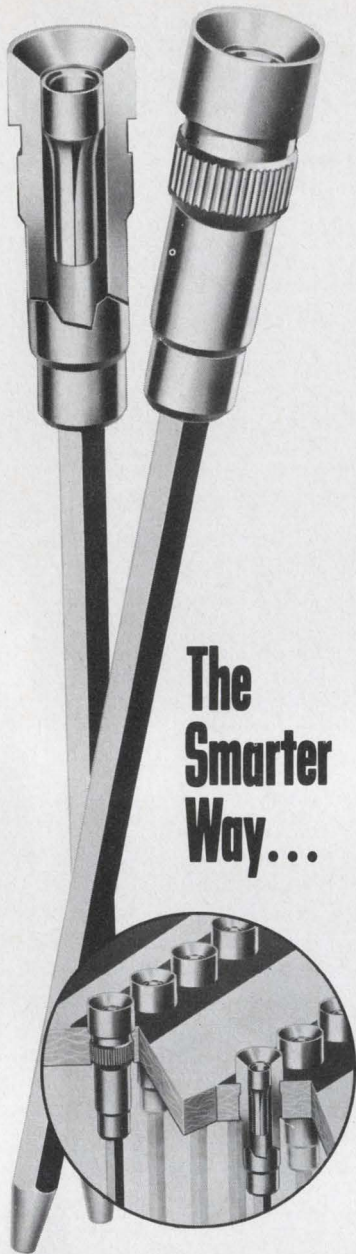

**The  
Smarter  
Way...**

## EMC's Pin-in-Board

Still best! EMC's high density Wire-Wrap® non-warping epoxy panels assure accurate true position, especially on 1/16" boards. Edgeboard finger patterns, power and ground planes, and new TIP-DIPTM for double density! Funnel-Entry design simplifies lead insertion; Nurl-Loc® terminals prevent twist during wrap. Standard and Custom panels for every requirement, too.

**ELECTRONIC MOLDING CORP.**  
96 Mill St., Woonsocket, R. I. 02895  
Phone (401) 769-3800

Write or phone for latest  
Computer Products Catalog



INFORMATION RETRIEVAL NUMBER 104

## MICROWAVES & LASERS

### Mm-switch actuator draws low current

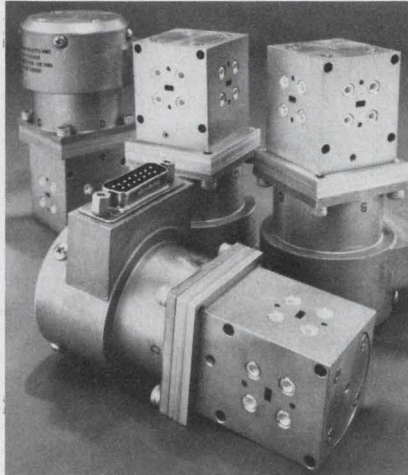

*Transco Products, 4241 Glencoe Ave., Venice, Calif. 90291. (213) 821-7911.*

An SPDT/transfer millimeter switch, for WR-15 waveguide, uses the company's Transactor 28-V-dc latching actuator. According to Transco, this proprietary actuator draws about 1/3 the current of conventional solenoids. Specifications include a VSWR of 1.15, insertion loss of 0.2 dB and isolation of 40 dB. The switch meets MIL-E-5400, Class 2 environmental requirements.

CIRCLE NO. 320

### 50-W transistors cover broad band

*Power Hybrids, 1742 Crenshaw Blvd., Torrance, Calif. 90501. (213) 320-6160. \$350 (1-24); stock to 3 wk.*

Two internally matched hermetically sealed rf power transistors with internal matching permit pulsed and cw operation in the TACAN/DME and phased-array radar bands. The PH1114-50 is rated at 50 W broadband under long pulse conditions of 1 ms and 20% duty cycle, or 50-W cw for narrowband applications. Power gain is 6 dB minimum with greater than 50% efficiency. These ratings are for a 28-V supply. The PH0912-50 is also rated at 50 W broadband under long pulse conditions, or 40 W cw in the 960-to-1215-MHz range. Both transistors feature gold metalization and emitter ballasting.

CIRCLE NO. 321

### L-band osc transistor delivers 0.75 W

*RCA Solid State Div., Route 202, Somerville, N. J. 08876. (201) 722-3200. \$9.90 (100-999); stock.*

An oscillator transistor generates 0.75 W at 1.68 GHz when operated from a 20-V supply. Called the 41038, the silicon npn transistor uses multiple-emitter-site construction and emitter-ballasting resistors. It is supplied in a three-lead TO-46 hermetic package, with the collector lead connected to the case.

CIRCLE NO. 322

### 225-to-400-MHz array yields 8-dBI gain

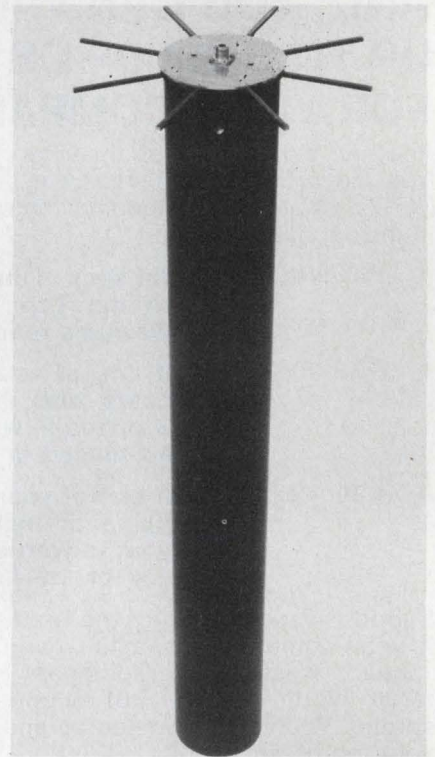

*Tecom Industries, 9000 Owensmouth Ave., Canoga Park, Calif. 91304. (213) 341-4010.*

A high-gain, high-power sleeve antenna for the 225-to-400-MHz military air-traffic communications band consists of a four-bay, vertically polarized, omnidirectional collinear array. Called the TECOM 401031, the array has a gain of 8 dBI, with an average VSWR of 1.2:1, and handles 2-kW average power. The array weighs 60 lbs. and measures 104 inches in height. A radome enclosure permits operation in an 85-mph wind and with half an inch of ice.

CIRCLE NO. 323

**ATLAS** positively guarantees...

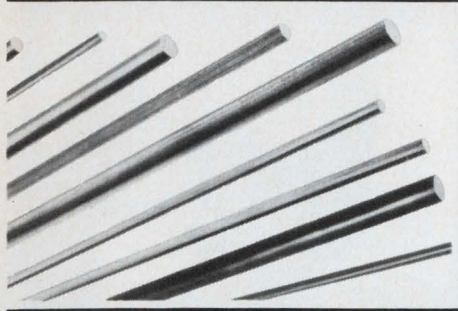

fastest  
delivery  
↓  
unsurpassed  
accuracy  
↓  
lowest  
prices

on Turned and Precision-Ground

## PHENOLIC RODS

EPOXY

BAKELITE

Glass Supported TEFLON

- Stock sizes in any diameter from 3/32" to 3/8"
- Increments of .001 at no extra charge
- Most sizes available for immediate delivery
- Accuracy guaranteed to  $\pm .001$ "

Plus... the largest inventory in the world!

SEND FOR  
COMPLETE  
PRICE LIST

### ATLAS FIBRE COMPANY

6980 N. Central Pk. Ave. Chicago, Ill. 60645  
(312) 465-1234

INFORMATION RETRIEVAL NUMBER 105

**3' x 4' on the floor.**  
**Tenney gives you more!**

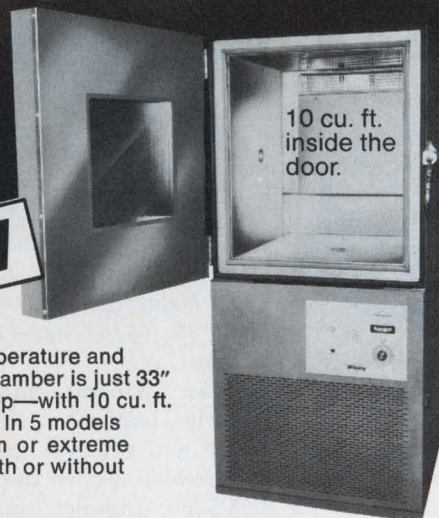

**NEW**

TenneyTen temperature and humidity test chamber is just 33" wide by 49" deep—with 10 cu. ft. inside capacity. In 5 models offering medium or extreme temperature, with or without humidity.

- Model TTH: 0°F to 200°F with humidity
- Model TTRS: -40°F to 350°F with humidity
- Model TTTC: -100°F to 350°F with humidity
- Model TTS: -40°F to 350°F
- Model TTC: -100°F to 350°F

Write or call for details.



**Tenney**  
ENGINEERING, INC.

1090 Springfield Rd., Union, New Jersey 07083 • (201) 686-7870  
Western Division: 15721 Texaco St., Paramount, Calif. 90723

INFORMATION RETRIEVAL NUMBER 106



Licon takes the  
"butterflies" out of  
holding patterns.

By putting its double-break, double reliable Butterfly® switches to work in today's modern aircraft.

Waiting to touch down. Critical moments for a jet flying a tight holding pattern in heavy air traffic. No room for ordinary switching performance. Which is why Licon® patented double-break Butterfly switches are on board so many jetliners today. Performing with beautiful precision.

Even if you're not designing jumbo jets, you can be sure of the same quality and dependability throughout the entire Licon switch line. Basic Switches, Lighted Pushbutton Switches, Keyboards. Shorten your design time—put Licon's engineering know-how to work for you. Your Licon representative or distributor has a switch solution for you.

**ITW LICON**

Division Illinois Tool Works Inc.  
6615 W. Irving Park Road  
Chicago, Illinois 60634  
Phone (312) 282-4040  
TWX 910-221-0275

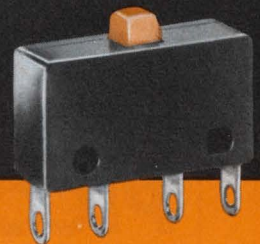

**LICON**  
puts ideas to work  
in electronics

The Innovative Electronic Group of ITW...  
LICON ■ ELECTRO MATERIALS ■ PAKTRON

© ILLINOIS TOOL WORKS INC. 1974

INFORMATION RETRIEVAL NUMBER 107

# 1/4" x 1/4" transformers

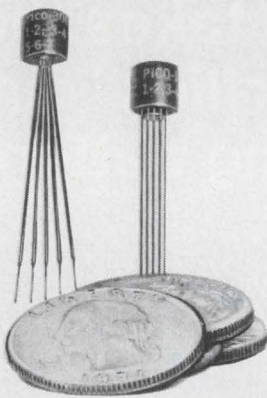

Ultra-miniature, high reliability transformers that handle 100 milliwatts at 1KHz; 150 milliwatts at 7.5KHz;  $\pm 3$ db 400Hz-250KHz; Pulse applications .05 to 100 $\mu$ s; Primary or secondary impedances 5 ohm to 30K ohm; Hermetically sealed in metal case; MIL-T-27; Inductors to 10 Henries; Extreme resistance to thermal shock; Terminals either T0-5 plug-in or insulated.

Send for 36 page catalog

## PICO Electronics

50 South MacQuesten Pkwy.  
Mt. Vernon, New York 10551  
Telephone 914-699-5514

(All PICO Products are patented)

### MICROWAVES & LASERS

#### Linear rf amp delivers 16 W

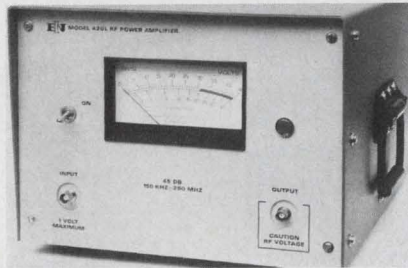

*Electronic Navigation Industries, 3000 Winton Rd. S., Rochester, N.Y. 14623. (716) 473-6900. \$2890; 60 day.*

The Model 420L solid-state, Class A power amplifier can provide, without tuning, more than 16 W of linear rf power and up to 25 W of saturated power at frequencies from 150 kHz to above 250 MHz. The 420L can be driven by any signal generator, frequency synthesizer or sweeper capable of supplying  $-3$  dBm into its 50- $\Omega$  input. The 420L has a gain of 45 dB, with a maximum variation of  $\pm 1.5$  dB. All harmonics are more than 25 dB below the fundamental at 15 W output. Typical third-order intermodulation intercept point is  $+51$  dBm, and noise figure is less than 9 dB.

CIRCLE NO. 324

#### Holographs don't need lasers for viewing

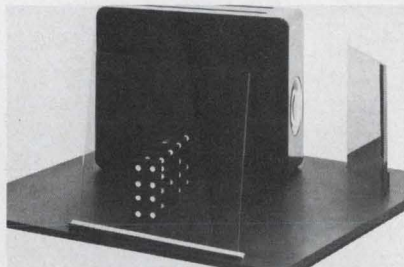

*Holox Corp., 2544 W. Main St., Norristown, Pa. 19401. (215) 539-0828. \$99.50; 3-6 wk.*

Containing a white-light source, narrow bandwidth interference filter, lens and mirror, a 12  $\times$  12  $\times$  5-in. holographic unit permits three-dimensional viewing without lasers. The unit comes complete with three 4-1/2  $\times$  4-1/2-in. holograms that are bleached for increased efficiency. A track built into the block-matte plexiglass base conveniently accepts the holograms.

CIRCLE NO. 325

#### Instrument combines synthesizer, oscillator

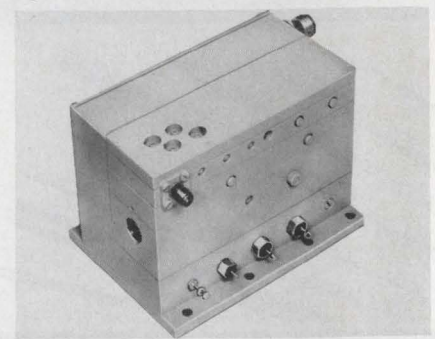

*Engelmann Microwave, Skyline Dr., Montville, N.J. 07045. (201) 334-5700.*

A synthesizer/oscillator permits the selection of 27 equally spaced frequencies in 20-MHz steps via a special-purpose C-Band microwave synthesizer. Called the Model SL-A02, the new instrument has an output of 10-mW minimum from 4.8 to 5.32 GHz, with the stability of an internal crystal (1 part in 10<sup>6</sup>/day at 15 to 35 C) or a stability equal to an external reference at 5 MHz. DSB FM noise is 40 Hz, 10 kHz from the carrier in a 3-kHz bandwidth, and 20 Hz at 100 kHz from the carrier.

CIRCLE NO. 326

#### Mixer-preamp has 5.9-dB noise figure

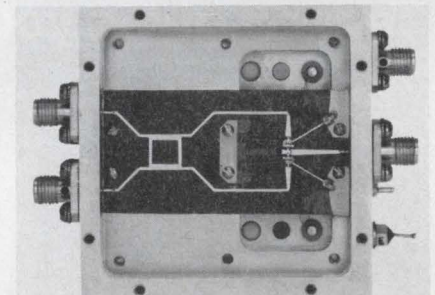

*RHG Electronics Laboratory, 161 E. Industry Ct., Deer Park, N. Y. 11729. (516) 242-1100. \$1950; 60 days.*

An X-band mixer-preamplifier series features a 5.9-dB noise figure and greater than 20-dB image rejection. Called the Model IRRDM 8.5/60, the new unit can replace complex tunnel-diode and transistor-amplifier front ends. Other specifications include a frequency range of 8.5 to 9.6 GHz, i-f frequency/bandwidth of 60/20 MHz and a nominal over-all gain of 20 dB. The isolation between LO and rf exceeds 25 dB.

CIRCLE NO. 327

# Our one-two punch knocks heat problems cold. It delivers up to 125 cfm against the toughest opposition. We call it, "The Tandem Boxer."

Synergistic. Push-pull operation of the Tandem's impellers moves volumes of air through systems where high density component packaging would otherwise impede air flow. Nearly twice the output of two equivalent fans working independently.

Parallel redundancy. Wiring and fusing the fan motors in parallel adds an extra measure of protection.

Interchangeable with all standard Boxers (or the other contenders). Only depth dimension is increased.

Eliminates the problem of premature air-mover specification.

Other airmovers? Of course!

Send for our full-line catalog No. ND4r. It's free, and contains performance data, electrical and mechanical specifications on more than 100 units.

And valuable application information too.



For immediate service, contact us at **IMC Magnetics Corp., New Hampshire Division**, Route 16B, Rochester, N.H. 03867, tel. 603-332-5300. Or the IMC stocking distributor in your area. There are more than 50 nationwide and overseas.



IMC New Hampshire Division Airmovers are available at the following locations:

- Calif., Menlo Park/Bell Electronic Corp., 1070 O'Brien Dr. 94025/(415) 323-9431
  - Conn., East Hartford/Eastco, Inc., 95 Leggett St. 06108/(203) 528-6581
  - Fla., Fort Lauderdale/C.D.I., 2631 E. Oakland Park Blvd. 33306/(305) 564-0387
  - Kans., Wichita/Radio Supply Corp., 115 Laura St. 67211/(316) 267-5216
  - Md., Savage/Pyttronic Industries, Inc., 8220 Wellmoor Ct. 20863/(301) 792-7000
  - Mass., Somerville/Electro-Sales, 100 Fells-way St. 02145/(617) 666-0500
  - Mich., Jackson/Fulton Radio Supply, 1208 Greenwood Ave. 49204/(517) 784-6107
  - Minn., Minneapolis/Industr'l Components, 4004 W. 78th St. 55431/(612) 927-9991
  - Miss., Jackson/Ellington Electronics, Box 8038, 1425 Terry Rd. 39204/(601) 355-0561
  - N.C., Raleigh/Leigh Electronics, Box 6183, 2911 Essex Circle 27607/(919) 787-9090
  - N.J., Clifton/Eastern Radio Corp., 312 Clifton Ave. 07015/(201) 365-2600
  - N.Y., Buffalo/Summit Distributors, 916 Main St. 14202/(716) 884-3450
  - N.Y., Farmingdale/Norelcom Electronics, 200 Allen Blvd. 11735/(516) 249-7262
  - R.I., Providence/William Dandretta, 28 Wolcott Street 02908/(401) 861-2800
  - Tenn., Nashville/Electra Distributing, 1914 West End Ave. 37203/(615) 255-8444
  - Tex., Dallas/All-State OEM Div., 510 S. Good Latimer Expy. 75226/(214) 651-0242
- Send for the complete IMC Distributor Directory.

INFORMATION RETRIEVAL NUMBER 109

## NEW UV SILICON PHOTOCELL

200 to 1100 NM  
MACROSCOPIC COST  
Low noise, wide range, stable, fast  
and all the good things that you have  
asked for in a detector.

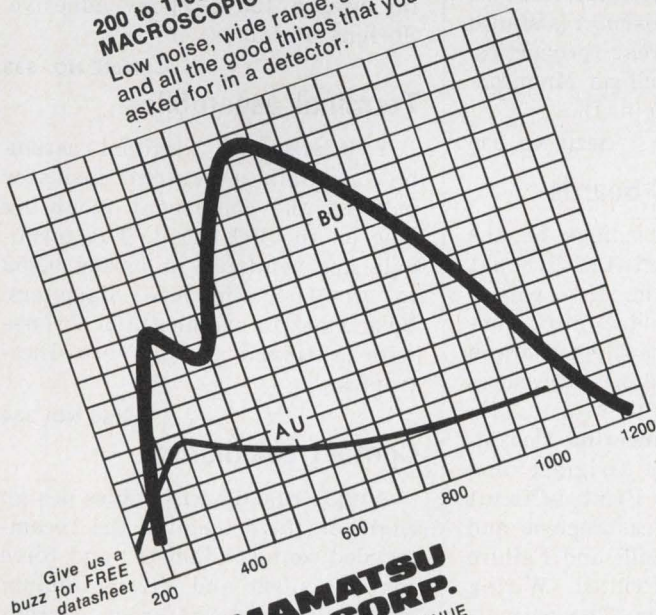

Give us a buzz for FREE datasheet

**HAMAMATSU CORP.**  
120 WOOD AVENUE  
MIDDLESEX, N.J. 08846  
(201) 469-6640

INFORMATION RETRIEVAL NUMBER 110

ELECTRONIC DESIGN 1, January 4, 1974

## Buy the Ballantine 3/24 DMM

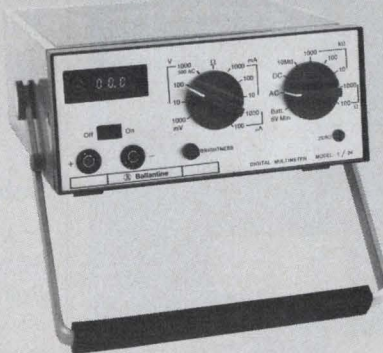

### 24 Ranges — 3 Full Digits

- AC Volts, AC Current, Ohms, DC Volts, DC Current
- Fully Overload Protected
- 300 Hour Dependable Battery Life
- Pocket Size — Weighs Under 2 Pounds
- 0.2% DC Accuracy — AC to 20 kHz

Available from Stock  
Factory/Distributor

**\$195**  
complete



**Ballantine Laboratories, Inc.**

P.O. Box 97, Boonton, New Jersey 07005  
201-335-0900, TWX 710-987-8380

INFORMATION RETRIEVAL NUMBER 111



**our products  
are more fully  
developed...**

Standard Condenser capacitors are indeed fully developed to produce the optimum in performance and durability. Standard is in one business only, the design and manufacture of the world's finest capacitors. We have designed and delivered thousands of specialized capacitors for industry. In fact, what you think of as "special" may be among the many designs already available from stock at Standard. However, if you require capacitors of unusual shape, size, value and material, our engineering department will help you design and produce them to your exact specifications at stock prices. For immediate action, send us a sketch and complete details.

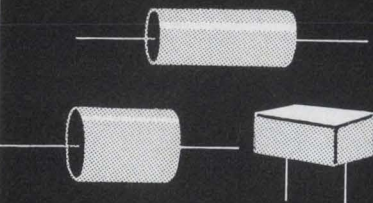

Write or phone for catalog and details.

**Standard**

**CONDENSER CORPORATION**

Dept. ED-1 1065 West Addison Street  
Chicago, Illinois 60613 • (312) 327-5440

INFORMATION RETRIEVAL NUMBER 112

212

## application notes

### Power transistors

The methods used to test the thermal-cycling capability of silicon-power transistors are described in a 12-page application note. It presents a brief discussion of thermal fatigue, application requirements and rating charts, and then describes the design of thermal-cycling racks and test conditions. Photographs and diagrams describe construction, use and performance. RCA Solid State Div., Somerville, N.J.

CIRCLE NO. 328

### Nomograph handbook

The Nomograph Handbook serves as a guide for computing cumulative time errors in precision clocks, by considering drift and time-setting errors in the time-base oscillator vs elapsed time period. Datametrics, Wilmington, Mass.

CIRCLE NO. 329

### Electrical contacts

Complete information on how to obtain better price/performance from electrical contacts is contained in a four-page reprint. Electrical and thermal conductivities of the most popular contact materials, as well as their corrosion resistance and mechanical wear properties, are pointed out. Deringer Manufacturing Co., Mundelein, Ill.

CIRCLE NO. 330

### Soldering of PC-boards

A 113-page proceedings on the Soldering of Printed-Circuit Boards contains the five papers presented at the solderability seminar. They are: The Meniscograph Method of Solderability Measurement, Intermetallic Growth in Tin-Rich Solders, Engineering Considerations Affecting Original and Repaired Joints, Printed-Circuit Board Cleaning Measurement and Removal of Ionic Soils and Failure Mechanisms in Printed Wiring Board Solder Joints. The price is \$5. Institute of Printed Circuits, 1717 Howard St., Evanston, Ill. 60202.

INQUIRE DIRECT

## evaluation samples

### PC-board spacer

Dual-locking series DLCBS circuit-board spacer features "barbed arrow" locking tips at both ends. Available in seven lengths, it spaces two boards from 3/16 in. to 7/8 in. apart—either in vertical tiers or side-by-side. Made of rigid natural nylon, the spacer compression-snaps into 0.156 in. diameter holes on the two boards to be spaced. Richco Plastic Co.

CIRCLE NO. 331

### Thermistors

Rugged chip thermistors are interchangeable with many disc and bead thermistors used between -50 and 150 C. Western Thermistor Corp.

CIRCLE NO. 332

### Coil bobbins

Glass epoxy coil bobbins used in high reliability solenoids and power supplies come in a variety of sizes. The core sections are molded tubes of fiberglass laminated epoxy—sanded outside and cut to length. Flanges are fabricated from G11 epoxy sheet material, wire side sanded, and made for a drive fit over the core tube. Bonding uses a 155 C epoxy adhesive. Stevens Products.

CIRCLE NO. 333

### Terminal assemblies

Two sizes of terminal assemblies contain a ceramic insulator between the component mounting hole on the PC board. The terminals are available in either 0.052 in. or 0.040 in. hole diameters. Base material is phosphor bronze with a tinned finish Vero Electronics.

CIRCLE NO. 334

### Contact calculator

A slide rule device enables design engineers to determine the recommended contact diameter and force for fine silver and silver-cadmium oxide alloys at different current ratings in different types of electrical apparatus. Engelhard Industries.

CIRCLE NO. 335



# dip clip

T.M.

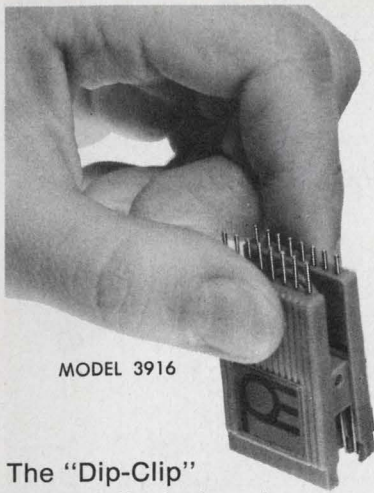

MODEL 3916

The "Dip-Clip" is specially designed to allow the attachment of test probes to 14 or 16 lead DIPs. The unique patented design greatly reduces the possibility of accidental shorting while testing live circuits. Numerous test probes may be quickly connected for hands-free testing.

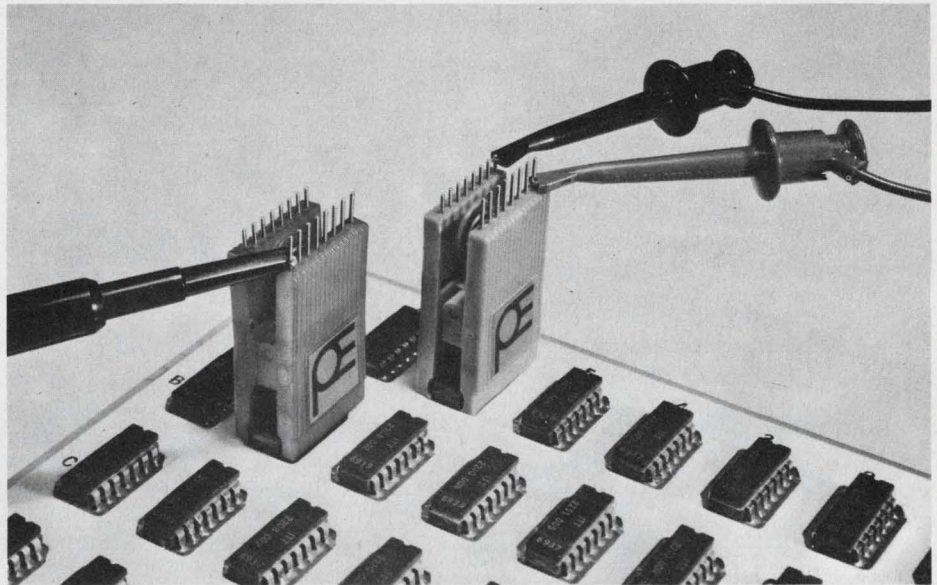

**POMONA ELECTRONICS**

A Subsidiary of ITT

1500 E. Ninth St., Pomona, Calif. 91766 • Telephone: (714) 623-3463

INFORMATION RETRIEVAL NUMBER 113

## NEW SUB-MINIATURE TOGGLE SWITCH\* FOR PRINTED CIRCUIT BOARDS

- IDEAL FOR SUB-CHASSIS CHECKOUT, INTERLOCK CIRCUITS AND FIELD SERVICE
- NO MOUNTING HARDWARE REQUIRED

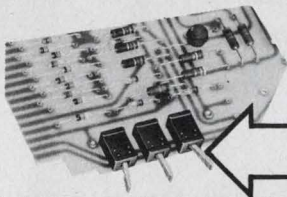

2 & 3 Position Toggle (Actual Size)



### PCB TOGGLE SWITCH SPECIFICATIONS

(Available in 2 position or 3 position momentary and/or maintained)

Volts	Load	Life (ops., min.)
6 VDC	0.01 amp, res.	500,000
6 & 12 VDC	1 amp, res.	100,000
28 VDC, 120 VAC	0.5 amp, res.	100,000
Contact Resistance	.....0.025 ohms, max.	
Ambient Temperature Range	.....-20°C. to +70°C.	
Weight	.....0.06 ounce	

\* Pushbutton style also available in momentary action or latch-down, screwdriver-slot or snap-on button.

Send for technical bulletins

## CONTROL SWITCH INC.

A SUBSIDIARY OF CUTLER-HAMMER INC.  
1420 Delmar Drive • Folcroft, Pa. 19032 • (215) LU-6-7500

Representatives and Stocking Distributors Throughout the United States, Canada, and Europe



SCIENCE • OPTICS • ELECTRONICS

## ONOSOC & HARD BARGAINS

NEW PRODUCTS • NEW MATERIALS • NEW METHODS

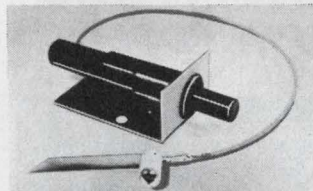

**PIEZOELECTRIC DEMONSTRATOR**  
Piezoelectrically energized ceramic capsule releases powerful 18,000v spark thru universal electrode at the push of a button. Solid state. Operates 1 million cycles (typical spark gap 3/16-1/4"). Instantly ignites any flammable gas! Use for welding/soldering torches, portable propane stoves & lanterns, anything that req. a hi-voltage spark. Metal bracket. 9" teflon wire for permanent mounting. Overall length 3" capsule with 2" electrode.  
Stock No. 42,102DA .....\$5.95 Ppd.

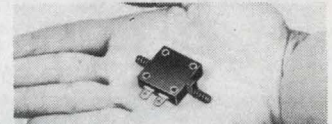

**ULTRA LOW PRESSURE SENSOR**  
Big surplus bargain—tiny electrical pressure switch activated by only 0.02 psi air or 1/2" or less water pressure. Single pole, normally open. 10ma DC contact rating. 30v AC/DC (usual loads require sensitive relay or solid state control). Use as sensor, switch, control, counter, edge guide, instrument alarm. Long Life (1,000,000 operations), impervious to extreme shock, vibration. 1" sq. polycarbonate case, 3/16" diameter barbed pressure ports. Wt—10 grams. ORIGINAL COST \$11.50.  
Stock No. 41,623DA .....\$4.50 Ppd  
100 or more .....\$3.95 each  
No. 41,509DA 1-OZ. BOTTLE .....\$8.75 Ppd



**SUPER GLUE! DROP HOLDS TON**  
Clear PermaBond obsoletes other adhesives! No mixing; sets in seconds—no solvents, catalysts, heat. Tensile strength to 5000 lb. in.! Joins, welds, seals, mounts; bonds rubber, plastic, wood, etc. Use for assembly, repair, O.E.M. wk. Mend china; bond silicone chips to ceramics; metal to glass; fix parts to rivet. Impervious to most chemicals (enters cracks others can't); non-water soluble; non-toxic.  
No. 41,509DA 1-OZ. BOTTLE \$8.75 Ppd.  
No. P-42,107DA  
(5-PAK 2 Gm. TUBES) .....\$7.95 Ppd.



**GIANT FREE CATALOG**  
Brand new 1974 edition — 180 pages. Hundreds of unique new items! Hard-to-get surplus bargains. Ingenious scientific tools. 1000's of components: lenses, prisms, wedges, mirrors, mounts, all types of accessories. 100's of instruments, lasers, comparators, magnifiers, telescopes, projectors, microscopes, binoculars, photoattachments, black-light equipment and the world's largest selection of unique lighting equipment. Fully illustrated. Great buys! Write for Catalog "DA".

**EDMUND SCIENTIFIC CO.** TELEPHONE: 609-547-3488  
300 EDSORP BLDG. BARRINGTON, NEW JERSEY 08007  
ORDER BY STOCK NUMBER. MINIMUM ORDER \$10.00 ON OPEN ACCOUNT TO RATED FIRMS. MONEY-BACK GUARANTEE.

INFORMATION RETRIEVAL NUMBER 114

ELECTRONIC DESIGN 1, January 4, 1974

INFORMATION RETRIEVAL NUMBER 115

213



# 18 sizes...

10•14•20•24•26•30•36•40•44•50•54•56•60•66•70•90•100•120

We have expanded our series WTB right angle PC Connectors to include sizes up to 120 contacts and a choice of solder cup, dip pin, or Wire-Wrap\* terminals. Crimp terminals available on all sizes up to 90. This very versatile subminiature connector features .100" spacing, 2 rows offset for .050".

For details, call 214/233-2000 or write our Dallas plant at 4321 AirBorn Drive, Addison, Texas 75001

\*Registered trademark of Gardner-Danver Company

## AirBorn, Inc.

INFORMATION RETRIEVAL NUMBER 116

## PHOTO CONTROLS FOR EVERY PURPOSE

303 TYPES • 3003 VARIATIONS

- |                   |                    |
|-------------------|--------------------|
| ■ AUTOMATION      | ■ FAULT DETECTION  |
| ■ COUNTING        | ■ LIMITING         |
| ■ PACKAGING       | ■ ORIENTATION      |
| ■ CONVEYORS       | ■ POSITIONING      |
| ■ CUT-OFF         | ■ INSPECTION       |
| ■ DIE PROTECTION  | ■ TENSION          |
| ■ PROCESSING      | ■ TRAFFIC CONTROL  |
| ■ JAM-UP          | ■ WEIGHING         |
| ■ REGISTRATION    | ■ WINDING          |
| ■ MEASURING       | an endless variety |
| ■ SMOKE DETECTION | of applications    |
| ■ SORTING         |                    |

Send for **FREE**  
Complete Catalog



Contains latest released information on photo-electric controls developments, application survey, 61 complete application sketches and dimensional diagrams for innumerable practical uses.

### AUTOTRON

PHOTO-ELECTRIC and other ELECTRONIC CONTROLS

**AUTOTRON, INC.**  
3629 N. VERMILION ST.  
DANVILLE, ILL. 61832  
PHONE 217-446-0650

INFORMATION RETRIEVAL NUMBER 117



**Best buy power module for op amps.**  
± 15V (tracking) 400 ma .... \$85.

Regulation, ±0.1%; ripple, 1.5 mv. Size, 3.4" H x 5.1" W x 5.1" D. Input voltage, 105-125 VAC, 50-400 Hz. Order Model TD15-40. For 1.0 amp outputs, Model TD15-100... price, \$125. Other high quality models are available to power balanced loads drawing from 25 ma to 8.5 amps. Five year warranty. 3 day shipment guaranteed.



Acopian Corp., Easton, Pa. 18042  
Telephone: (215) 258-5441

INFORMATION RETRIEVAL NUMBER 118

ELECTRONIC DESIGN 1, January 4, 1974

## design aids

### Switch kit

A discount coupon is worth \$50 on the purchase of a switch kit. The kit contains four snap-in panel mount, five miniature snap-action, two low torque rotary coin, four open and stack-type, three keyboard, five general-use snap action, two low-energy gold crosspoint contact and five subminiature switches. Two thumbwheel/leverwheel modules are also included. The kit is \$17 complete and postage paid with the discount coupon. Cherry Electrical Products, Waukegan, Ill.

CIRCLE NO. 336

### Data modem selector

A compact, durable blue-and-white data modem selector describes all DAA options, mounting configurations, input/output and operational options. Upon dialing a modem model number, the device displays technical data, such as modulation, turn-around time and interface information. TeleDynamics, Fort Washington, Pa.

CIRCLE NO. 337

### Rf capacitors

A uhf/microwave rf capacitor chart provides information on the ATC 100 low-loss porcelain and ATC 700 ultra-stable ceramic chip capacitor series. Physical terminations and dimensions, capacitance ranges and tolerances and standard capacitance values are given. American Technical Ceramics.

CIRCLE NO. 338

### Templates

A template series incorporates logic, schematic and component layout patterns. Each template features a complete set of standard logic symbols meeting ANSI Y32.14 requirements. The templates are made from .030 green tinted plastic and are priced as follows: EE-1 (1:1): \$4, EE-2 (2:1): \$5, and EE-4 (4:1): \$7. Tangent Template.

CIRCLE NO. 339

# CMOS converters?

Hybrid Systems has them...

A/D Converters

D/A Converters

Plus our full line of data conversion modules

- Multiplying D/A converters
- General purpose D/A converters
- General purpose A/D converters
- Peak detectors
- Multiplier/dividers
- Fast Op Amps



**HYBRID SYSTEMS CORPORATION**

87 Second Avenue, Northwest Industrial Park, Burlington, Mass. 01803  
Telephone: 617-272-1522 TWX: 710-332-7584

INFORMATION RETRIEVAL NUMBER 119



## It's logical

Panasonic's new R-relay makes a lot of sense. It's the smallest reed-type relay you can buy with a latching function (memory). And it's available in a form C (SPDT) contact closure.

When we set out to build our logical relay, we decided not to refine old ideas. Instead we invented (and patented) a relay of revolutionary design and construction with features no other relay has. We used an easily manufactured plastic bobbin instead of the expensive glass capsule used in every other reed relay. We included a barium ferrite permanent magnet to provide latching (logic) function. And we molded it together in one piece of hermetically sealed heat-resistant epoxy resin that occupies less than one-sixth of a cubic inch. Our relay

has a mechanical life of over a billion operations performed as rapidly as 500 Hz. It operates with an extraordinarily wide range of currents—from a few microamps up to a full amp. It's even available in a two-coil bi-stable configuration.

Do you need to mount a relay on a circuit board with a high parts density? Do you need a relay that needs no maintenance over an extra long life? One with higher sensitivity in low power semiconductor circuits? Or one that can withstand currents up to a full amp? Perhaps you need a relay with negligible contact bounce, rapid response, and high operational frequency. If you do, send for more information about Panasonic's unique R-relay. It's the logical thing to do.

**Matsushita Electric Corp. of America  
Industrial Division**  
200 Park Avenue, N.Y., N.Y. 10017  
Telephone: (212) 973-8210

Attn: Tom Gottlick  
 Please send R-relay literature.  
 Please have an engineer call.

Name \_\_\_\_\_ Title \_\_\_\_\_  
Company \_\_\_\_\_  
Address \_\_\_\_\_  
City \_\_\_\_\_ State \_\_\_\_\_ Zip \_\_\_\_\_

**Panasonic**

our technology is all around you

INFORMATION RETRIEVAL NUMBER 120

# new literature



## Power supplies

A 66-page design-data catalog presents over 4000 power supplies covering commercial, industrial and MIL-qualified applications. Special sections are devoted to extensive thermal data tables, a glossary of new NEMA terminology and a metric guide. Technipower, Ridgefield, Conn.

CIRCLE NO. 340

## Illumination meter

Two-module, cosine-corrected Spectra microcandela illumination meter, available with analog meter (meter A) or nonblinking digital readout (model D) is described in a data sheet. Photo Research, Burbank, Calif.

CIRCLE NO. 341

## HP journal

A 24-page journal contains articles on logic analyzers and pulse generators for today's digital circuits. Hewlett-Packard, Palo Alto, Calif.

CIRCLE NO. 342

## Lamp jacks

Lamp jacks with wire-wrapping terminals designed to speed jack-panel assembly and reduce time-consuming wiring and soldering are described in a bulletin. Switchcraft, Chicago, Ill.

CIRCLE NO. 343

## 32-bit and 16-bit processors

Two bulletins describe the Model 7/32, a 32-bit processor, and the Model 7/16, a 16-bit processor. Interdata, Oceanport, N.J.

CIRCLE NO. 344

## Standardized components

A 48-page catalog covers 3000 standardized components including battery holders and connectors, clips and clamps, terminal, perforated and fuse boards, plug-in housings, spacers and standoffs, insulating washers and transistor sockets. Keystone Electronics, New York, N.Y.

CIRCLE NO. 345

## Laboratory stop clocks

A bulletin is designed to aid in selecting and purchasing bench or panel-mount laboratory stop clocks. Features highlighted are operating details, ordering information and dimensional drawings. A supplementary bulletin provides pricing information. North American Philips Controls, Cheshire, Conn.

CIRCLE NO. 346

## Need a custom designed instrument enclosure? Zero has a better way.



The VIP instrument enclosure system . . . gives you distinctive custom appearance with all-standard components. A wide range of sizes and virtually unlimited options in all most-needed height, width & depth combinations. Available in 2 weeks from stock.

Write for the VIP Design Guide. It's FREE.

### Zero Manufacturing Co.

777 FRONT STREET • BURBANK, CALIFORNIA 91503

Design and Manufacturing Facilities  
ZERO-WEST • BURBANK, CALIFORNIA  
ZERO-EAST • MONSON, MASSACHUSETTS  
ZERO-SOUTH • ST. PETERSBURG, FLORIDA



INFORMATION RETRIEVAL NUMBER 125

## GREAT MOMENTS

..... in electrical history

. . . the day Kalamazoo Engineering discovered that the tenacious teeth and snappy springs of Mueller Clips added a happy ending to the pull-cord of their ingenious Safety Tether Switch for snowmobilers. The product is an auxiliary switch wired into the ignition. The pull-cord tipped with a Mueller Clip is fastened to belt or jacket. If tough sledding tosses the driver, the yank shuts off the motor for safety's sake. Mueller Clips are usually electrical clips, but they do dramatically different things, if you use your imagination!

At Jobbers everywhere.

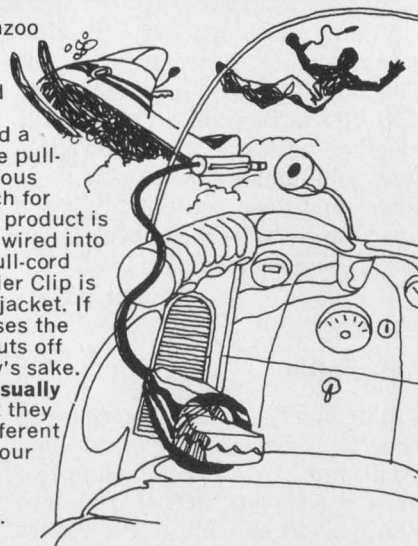

Write factory for FREE sample clips and catalog.

## Mueller Electric Co.

1580H East 31st Street • Cleveland, Ohio 44114

INFORMATION RETRIEVAL NUMBER 126

## Screening guide

A comprehensive guide to screening for users of ICs and discrete semiconductors compares various screening programs and test methods. Continental Testing Laboratories, Fern Park, Fla.

CIRCLE NO. 347

## Self-locking fasteners

All-metal self-locking captive fasteners are the subject of a four-page bulletin. Penn Engineering, Doylestown, Pa.

CIRCLE NO. 348

## Inverters and freq changers

Modular solid-state frequency changers and solid-state dc to ac inverters are described in two data sheets. Specifications, model types and block diagrams are given. ERA Transpac, Moonachie, N.J.

CIRCLE NO. 349

## Components

A 116-page guidebook to electro-mechanical equipment and components gives specifications, photos and drawings. American Design Components, N.Y., N.Y.

CIRCLE NO. 350

## Test equipment

Details on the latest panel meter developments are included in a 40-page catalog. It lists over 1500 types, styles, sizes and ranges of panel meters and includes more than 100 meter relays and general and special-purpose test equipment. Simpson Electric, Elgin, Ill.

CIRCLE NO. 351

## Product guide

A 72-page product guide covers linear, nonlinear and data conversion modules and power supplies. Included are specifications, drawings and photos. Prices are given. Teledyne Philbrick, Dedham, Mass.

CIRCLE NO. 352

## DIP delay lines

Two four-page bulletins feature transfer molded 14-pin DIP delay lines. Two package heights are offered. The 0.300-in. high units provide tapped and untapped delays from 5 ns to 1  $\mu$ s. McGraw-Edison, Manchester, N.H.

CIRCLE NO. 353



The Almost  
**No Power CMOS  
A/D Converter**

This remarkable 12-bit unit can be powered by a single +15V power supply and uses less power than a single TTL gate . . . under 25mW. Its low power and small size (2" x 2" x 0.4") makes the ADC575-12 the most remarkable product advance of the year in A/D converters. Price (1-9) is \$199.

**HYBRID SYSTEMS CORPORATION**  
87 Second Ave., Burlington, Mass. 01803 Tel: 617-272-1522 TWX: 710-332-7584

INFORMATION RETRIEVAL NUMBER 127

## OPEN-LINE REED RELAYS

Quality Engineered at Low Cost  
Broad Line . . . From Distributor Stock

An exceptionally high quality line of Form A and Form C open frame reed relays — with up to 6 contacts (Form A) and 4 contacts (Form C) per relay! Available in standard coil voltages 5 to 48 VDC . . . Capable of switching up to 1/2 amp, 250 VDC (Form A) or 1/4 amp, 28 VDC (Form C). Only .350" high by 1.125" long, with terminals on .1" or .15" grid spacing. Electrostatic and electromagnetic shielding optional. Top performance at low cost . . . Tailored to fit your cost/environmental requirements.

Phone, wire or write.

**ELEC-TROL, INC.**

26477 N. Golden Valley Road  
Saugus, California 91350  
(213) 788-7292  
TWX 910-336-1556

1973-74  
**eem**  
VOL. TWO

INFORMATION RETRIEVAL NUMBER 128

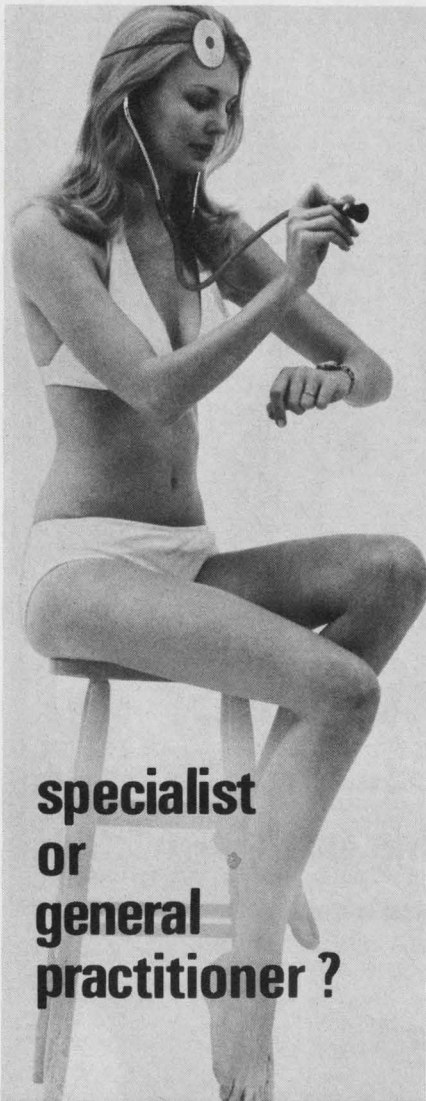

**specialist  
or  
general  
practitioner?**

Specialist, of course... in the art of reducing or eliminating unwanted, troublesome signals from electronic circuits. Rtron specializes in the design and manufacture of RFI/EMI filters to cure virtually every electronic interference problem. UL Recognized data processing filters, MIL-F-15733 types and filters for every industrial application are readily available... from stock to custom designed, tubular, rectangular or bathtub types, in single or multi-circuit units.

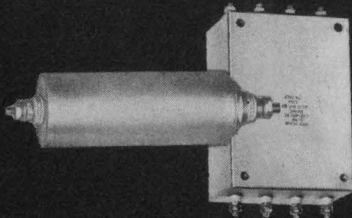

If you like our specialist, you'll like our treatment... phone or write...

**Rtron**

Dept. ED-1

P.O. Box 743 Skokie, Illinois 60076

Phone 312 • 679-7180

INFORMATION RETRIEVAL NUMBER 129

**NEW LITERATURE**

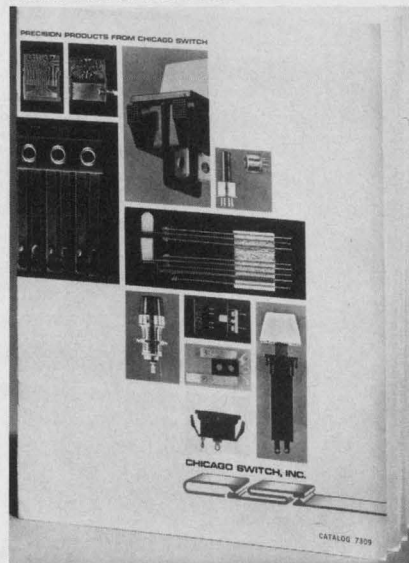

**Switches**

A 20-page handbook provides up-to-date information on switches and outlines testing and "how to specify" data. Outline drawings and illustrations are included. Chicago Switch, Chicago, Ill.

CIRCLE NO. 354

**Electrical test equipment**

Specifications and operating characteristics for insulation and dielectric breakdown testers, megohmmeters, electrostatic voltmeters, precision kV dividers and high-voltage power supplies are given in an illustrated four-page publication. Beckman, Cedar Grove, N.J.

CIRCLE NO. 355

**Book catalog**

Eighty-eight information-packed pages feature over 400 hardbound and paperback books, including ABC's of Electronics, Yearbook of Consumer Electronics 1974 and Four-Channel Sound to Modern Dictionary of Electronics. Howard W. Sams, Indianapolis, Ind.

CIRCLE NO. 356

**SCR capacitors**

Paper, paper/film and film dielectric capacitors are described in an eight-page brochure. Application information, mechanical dimensions, specifications and environmental ratings are presented in easy-to-use chart form. Cornell-Dubilier, Newark, N.J.

CIRCLE NO. 357

**This NEW...**

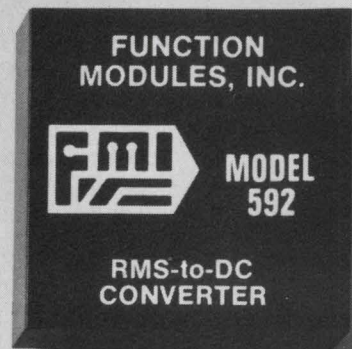

**matches the  
performance of  
expensive  
laboratory type  
true RMS  
voltmeters.**

By using dynamic matching techniques, this new unit achieves guaranteed accuracies of  $\pm 0.1\%$  of reading plus  $\pm 0.02\%$  of full scale from 10 millivolts RMS to 1 volt RMS.

So don't pay more for a complete instrument with all the extras when you only need the RMS function.

**And it's in stock.**

Send for a data sheet on our Model 592. And also ask about our general purpose unit Model 591.

**Function Modules, Inc.**  
2441 Campus Drive  
Irvine, California 92664  
(714) 833-8314

## Variable transformers

A 56-page variable transformer catalog gives ratings, dimensions, performance curves and schematic connection diagrams in an easy-to-read format. The Superior Electric Co., Bristol, Conn.

CIRCLE NO. 358

## Centertap rectifiers

Two lines of positive and negative single-phase centertap rectifier assemblies in a popular configuration with excellent surge current ratings are described in a data sheet. International Rectifier, Semiconductor Div., El Segundo, Calif.

CIRCLE NO. 359

## Spectrum analyzer

A 16-page booklet presents specifications for the Model 1510 real-time spectrum analyzer. CRT display photographs graphically illustrate the instrument's frequency domain analysis capability and ease of handling. EMR-Telemetry, Sarasota, Fla.

CIRCLE NO. 360

## Thermistor probes

A 12-page catalog details sizes, series and types of thermistor probes. Application circuits are described for temperature measurement and control and liquid-level detection. Thermistor Div., Keystone Carbon, St. Marys, Pa.

CIRCLE NO. 361

## Readouts

A full-color data sheet gives specifications on the Digivac 1000 vacuum fluorescent readout. Tung-Sol Div./Wagner Electric, Livingston, N.J.

CIRCLE NO. 362

## COS/MOS IC

A revised product guide covers COS/MOS ICs for low-voltage (3 to 15 V) digital circuit designs. The eight-page guide includes an easy-to-read wall-chart format permitting quick access to logic diagrams, functional diagrams and applications. RCA Solid State, Somerville, N.J.

CIRCLE NO. 363



**Small, Small CMOS D/A Converter**

Packaged in a 16-pin DIP socket, this low power, small size CMOS 8-bit current output D/A converter is perfect for most CMOS applications. Combined with its economy — \$19. in singles, the DAC385I-8 is another outstanding advance in D/A converters.

**HYBRID SYSTEMS CORPORATION**  
87 Second Ave., Burlington, Mass. 01803 Tel: 617-272-1522 TWX: 710-332-7584

INFORMATION RETRIEVAL NUMBER 131

# FLATPACK

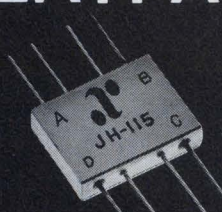

**90°**

# HYBRID

MODEL JH-115

- 40-80 MHz Frequency Range
- 3 Degrees Phase Tracking
- 1/2" x 3/8" x 1/8"
- \$45/Stock Availability

**anzac**  
ELECTRONICS



39 Green Street, Waltham, Mass.  
(617) 899-1900 • TWX 710-324-6484

INFORMATION RETRIEVAL NUMBER 132

## USC UPCC/REPC CONNECTORS

Draw-Pull and Screwlocking. Built to MIL-C-55302 & Commercial Specifications. Printed Circuit & Related Applications. REPC Connectors are Removable, Re-Entrancy, Crimp Contact Types

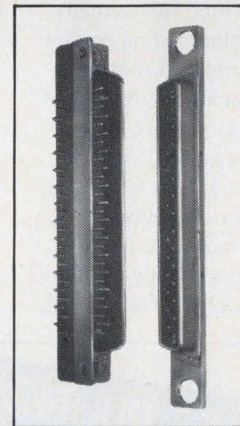

1 of over 20,000 Connector Types Manufactured. Send today for UPCC-REPC-A Series 32-page Catalog

## U.S. COMPONENTS, INC.

Leader in advanced engineering design

1320 Zerega Avenue  
Bronx, N.Y. 10462

(212) 824-1600 TWX: 710-593-2141  
Cable: COMPONENTS, NYK

INFORMATION RETRIEVAL NUMBER 133

# 8 GREAT INVERTERS

from 125 VA to 1.5KVA

- LOWEST COST
- HIGHEST RELIABILITY
- FASTEST DELIVERY

Frequency Range: 60Hz Adjustable  $\pm 5\%$

Distortion: Less than 6%

Regulation, Line and Load  $\pm 1\%$

Frequency Regulation  $\pm 0.15\%$  for line and load

Operating Temperature:  $-20^\circ$  to  $+55^\circ\text{C}$

If any of these 8 units won't satisfy your requirements, we've got 250 more — standard inverters from 30 VA to 3000 VA or choose a custom unit to meet your special requirements. Get our complete catalog and price lists; call, write or circle the reader service number.



**NOVA ELECTRIC MANUFACTURING CO.**

263 Hillside Avenue  
Nutley, New Jersey 07110  
(201) NOVA-1-3434

Output VA	Input DC Volts	Input DC Amps	Approx. Wt. Lbs.	Size HxWxD	Model No.	Price
125	11-16	17.4	19	5x6x10	1260-12	\$315
125	22-32	8.0	19	5x6x10	1260-24	315
250	11-16	35	37	7x9x13	2560-12	475
250	22-32	16	37	7x9x13	2560-24	445
500	11-16	70	60	7x11x14	5060-12	690
500	22-32	32	60	7x11x14	5060-24	635
1000	22-32	64	100	9x14x16	1K60-24	1070
1500	22-32	96	145	9x17x17	1.5K60-24	1450

INFORMATION RETRIEVAL NUMBER 900

## ABSOLUTELY

the world's most accurate rulings using vacuum deposit chrome, etch and fill or emulsion processes. They're produced on the world's largest 1 micro inch numerically controlled ruling engine with interferometric feedback controls. Need precision scales, grids, slits, reticles, Ronchis numbers, letters, circles, dots, or nickel mesh? We stock many items for immediate delivery. Send for brochure No. 38-36.

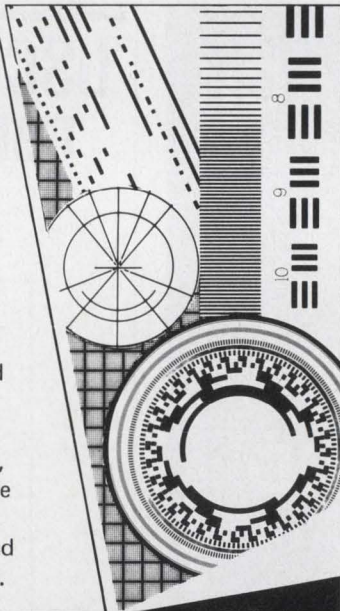

**SCALES RULINGS RETICLES & GRIDS FROM THE WORLDS LEADING SCALE MAKERS.**



JAMESTOWN, NY 14701 716/488-1958

INFORMATION RETRIEVAL NUMBER 134

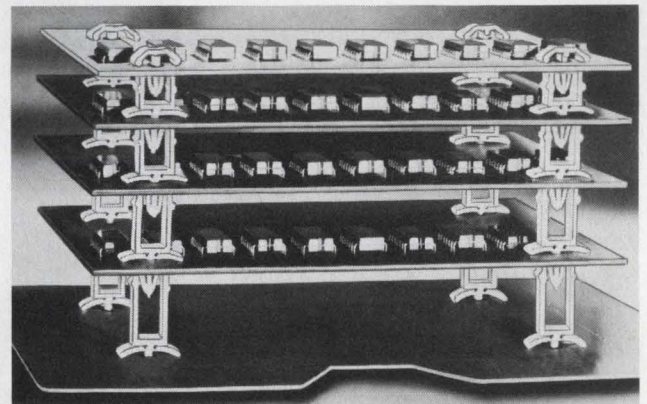

## STACK IN A SNAP

SPACE PCBs VERTICALLY OR HORIZONTALLY

Snap, stack . . . snap, stack . . . as high or wide as you want. Then lock your stack with a capping button. That's all there is to it. No tools, no screws, no grief.

Richco's unique Model CBSS Stacking Spacer System consists of two simple, rigid nylon components . . . "Barbed Arrow" locking spacers in  $\frac{1}{2}$ ",  $\frac{5}{8}$ ",  $\frac{3}{4}$ " and  $\frac{7}{8}$ " heights . . . and universal capping buttons.

All spacers fit a .156" dia. hole and capping buttons fit all spacers. Stack up. Get it on with Richco!

Tool available for easy removal.

**FREE SAMPLES**



**RICHCO PLASTIC CO.**

5831 N. Tripp Ave. • Chicago, Ill. 60646  
Phone: (312) 539-4060

INFORMATION RETRIEVAL NUMBER 135

ELECTRONIC DESIGN 1, January 4, 1974



## Recorder/reproducers

A brochure describes the Adviser Family (airborne dual-channel variable input severe environment recorder/reproducer), a new generation of video recorders. RCA, Government Communications Systems, Camden, N.J.

CIRCLE NO. 372

## Sockets

Descriptive, technical and pricing information on DIP sockets, interface boards, test/burn-in sockets and socketboard systems are given in a series of data sheets. Robinson-Nugent, New Albany, Ind.

CIRCLE NO. 373

## Diodes and transistors

IMPATT diodes and transistors for microwave applications are described in a 16-page catalog. Siemens, Iselin, N.J.

CIRCLE NO. 374

## Servo drives

A two-page brochure entitled "Hi-Ak Servo Drives" includes details on high-frequency operation, transistor switching control, current limit control and interlock and protection circuits. General Electric, Schenectady, N.Y.

CIRCLE NO. 375

## Indicator lights

Drawings and specifications highlight a 20-page catalog of midget indicators. Drake Manufacturing, Harwood Heights, Ill.

CIRCLE NO. 376

## Digital tape recorders

Incremental and synchronous tape transports for generating IBM-compatible magnet tape are described in a six-page brochure. Digi-Data, Blandensburg, Md.

CIRCLE NO. 377

## Switches and keyboards

An eight-page brochure contains prices and discount schedules for the company's switches and keyboards. Cherry Electrical Products, Waukegan, Ill.

CIRCLE NO. 378



# Low, Low Power CMOS D/A Converter

The ultimate in high accuracy and low power . . . the new DAC375-12 uses less than 60mW of power when operated from +15V, yet offers 0.0125% accuracy. It's a complete unit too, perfect for applications where power is at a premium. \$95. in singles.

**HYBRID SYSTEMS CORPORATION**  
87 Second Ave., Burlington, Mass. 01803 Tel: 617-272-1522 TWX: 710-332-7584

INFORMATION RETRIEVAL NUMBER 136

## The tough little competitor can deliver. Fast.

Call us on your OEM power supply requirements.

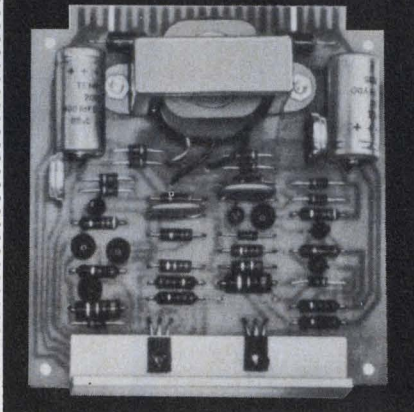

### Typical Specifications — DTS Series

\$32.95 (10-99 unit quantity)

- Input: 105-125VAC, 60 to 400Hz
- Line Regulation: 0.1% Max.
- Load Regulation: 0.1% Max.
- Ripple & Noise: 2MV. RMS. Max
- Stability:  $\pm 0.1\%$  after warm up
- Temperature Coefficient: Better than .02% / °C
- Operating Temperature: -20°C to +70°C\*
- Storage Temperature: -20°C to +85°C
- Short Circuit Proof:
- Tracking Outputs:
- \*Current is derated at temperature over +50°C.



Mighty Mouse © Viacom International

### SALIENT FEATURES

- exceptional reliability
- exceeds computer grade specifications
- packaged for computer peripheral equipment
- meets U.L. and C.S.A. requirements

All standard supplies available in both discrete and I.C. versions. Liberal mix or match discounts available. All AMPSCO products are backed by unconditional 10-year guarantee.

Power Supplies by

**AMPSCO**  
**WVBSCO**

A Tough Little Competitor

American Power Systems Corp. • 51 Jackson St. • Worcester, Massachusetts 01608 • (617) 753-8103

INFORMATION RETRIEVAL NUMBER 137

# THE LITTLE DEVICES THAT CAN...

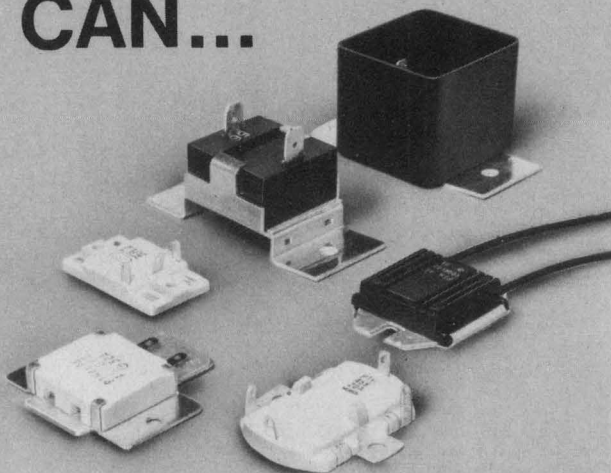

- Start Motors
- Heat Appliances and Ovens
- Control Temperature

## MURATA'S NEW POSISTORS!®

What's more, Murata's new Posistors can perform all of these functions with pure, solid state reliability. No contacts. No bi-metal strips. No centrifugal switches. No complex semiconductor circuitry.

Posistors are powerful positive temperature coefficient devices that can switch motor starting windings in and out at up to 12 amps. They can generate enough heat for small appliances and ovens while precisely controlling temperature at the same time. All without moving parts or exotic expensive circuitry.

And, we're sure that you will find applications that we've never dreamed of. Why not find out exactly what Posistors can do for you. Write for complete technical information today.

# *MURATA*

**MURATA CORPORATION OF AMERICA**

2 Westchester Plaza, Elmsford, New York 10523

Telex: MURATA EMFD 137332

Phone: 914/592-9180

A Subsidiary of

Murata Mfg. Co., Ltd., Japan

INFORMATION RETRIEVAL NUMBER 138

## Mini Bus® by Rogers

For noise and  
cost reduction

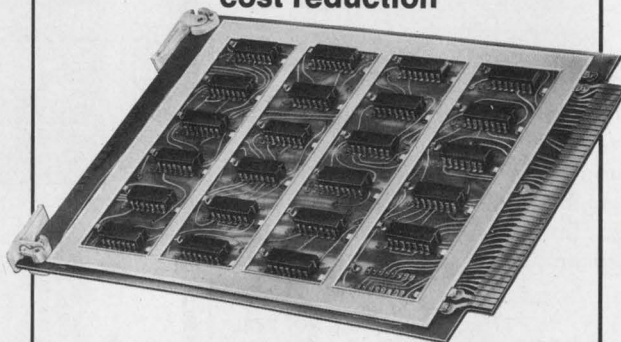

A small, voltage-distributing busbar for PC card application, each Mini/Bus gives you built-in capacitance . . . noise-cutting capacitance that means more reliable, compact circuit packaging at a fraction of multilayer prices. Write for data.



Rogers Corporation / Rogers, Conn. 06263

INFORMATION RETRIEVAL NUMBER 139

## environmental test chambers

complete program testing facilities for: high and low temperature, altitude and humidity.  
temperature ranges from: -150° to +500°F

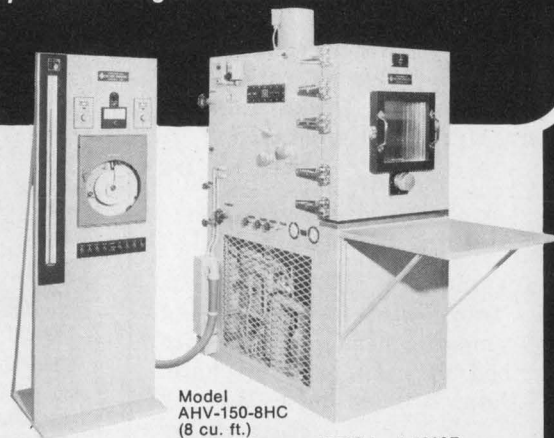

Model  
AHV-150-8HC  
(8 cu. ft.)  
Temperatures -150°F to +500°F

Custom units, designed and built to *your* specifications. For FREE, NO OBLIGATION quote, send us your temp. range, size and chamber needs.

Get the facts today. Send for our new FREE test chamber brochure.

**CINCINNATI  
SUBZERO  
PRODUCTS INC.**

2612 Gilbert Ave., Cincinnati, Ohio 45206  
Phone: (513) 751-8810

INFORMATION RETRIEVAL NUMBER 140

ELECTRONIC DESIGN 1, January 4, 1974

# bulletin board

Fairchild Camera & Instrument Corp. has added 12 circuit types to its line of **Schottky TTL integrated circuits**. The company is also making all SSI Schottky products available in plastic as well as ceramic packages.

CIRCLE NO. 379

A two-thirds-inch diameter, magnetic-focus and deflection **silicon-target (S-T) vidicon** has been announced by **RCA Electronic Components**.

CIRCLE NO. 380

Bourns has added a **5/16-in. square cermet potentiometer**, model 3279, to its line. The 3279 is sealed to MIL-spec standards to withstand board cleaning processes and adverse environments. It's priced at \$2.50 (1000 qty).

CIRCLE NO. 381

Rogers Corp. has received **UL recognition** for 20 engineering thermoset molding compounds.

CIRCLE NO. 382

Five widely used standard **rf power transistors** have been announced as ruggedized, lower-priced, second-source units by **Communications Transistor Corp.**

CIRCLE NO. 383

**Reality, a new English language computer business system** designed for easy use by anyone, has been announced by **Microdata Corp.**

CIRCLE NO. 384

Telefile Computer Products has released its new optional **disc drive handler software system routine** for the DC-16 disc drive controller/PDP-11 moving head, removable media disc systems.

CIRCLE NO. 385

Teledyne Semiconductor's first **CMOS products** will be second-sourcing **National Semiconductor's premium 74C logic family**.

CIRCLE NO. 386

Two new Texas Instruments **videotape instructional courses—linear and interface integrated circuits and optoelectronics**—are designed for the graduate-level engineer. The 10-hour linear and interface IC course covers circuit technology and options. The eight-hour optoelectronic course covers integration into system design, assembly considerations and interfacing with other solid-state circuitry. Prices are \$3600 (3/4-in. cassette) for the linear and interface IC course and \$2900 (3/4-in. cassette) for the optoelectronics course.

CIRCLE NO. 387

Xebec Systems has announced the availability of a **flexible-disc operating system, called XDOS**, for use with Data General computers.

CIRCLE NO. 388

## Price reductions

**General Electric** has announced price reductions averaging more than 40% on its **red solid-state lamps (LEDs)**.

CIRCLE NO. 389

As part of a general product repricing, **Hewlett-Packard's Data Systems Div.** has reduced prices of its **computer memory products** by an average of 10% across the division's entire line.

CHECK NO. 390

**The Signal Analysis Operation of Honeywell's Test Instruments Div.** has reduced prices nearly 40% for its **real-time spectrum analyzer line**. The SAI-51B 200-line analyzer is now \$5000. Its 400-line counterpart, the SAI-52B, is now priced at \$6900.

CHECK NO. 391

**Opcoa** has reduced prices on its low-cost **gallium-phosphide 0.33-in. LED numeric displays** to \$1.95 (1000 to 4999). Parts affected are the red SLA-7 and its  $\pm 1$  complement SLA-9 and the red SLA-8 and its  $\pm 1$  complement SLA-10.

CHECK NO. 392

**National Semiconductor** has reduced the price on the **IMP-16C 16-bit microprocessor on a card** to \$950 each in single quantity, down to less than \$500 each in OEM quantities.

INQUIRE DIRECT

# DOUBLE-BALANCED MIXERS

Great Value at

**\$7.95**  
500 piece quantities.

\$9.95 in 6-piece quantities.

DC-500MHz  
6dB conversion loss  
40dB isolation  
EMI shielded case

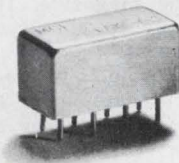

A breakthrough in technology and high production volume enables Mini-Circuits Laboratory to offer these new products at an unprecedented low price.

In today's tough competitive market can you afford not to use these remarkably low priced and high performance units?

Ruggedness and durability are built in the SRA-1. These new units are packaged within an EMI shielded metal enclosure and hermetically sealed header. They use well matched hot-carrier diodes and uniquely designed transmission line transformers.

We invite you to convince yourself. Place your order now and check our delivery, product performance and reliability.

## Mini-Circuits Laboratory

2913 Quentin Rd., Brooklyn, N.Y. 11229  
(212) 252-5252, Int'l Telex 620156  
A Division Scientific Components Corp.

\*FRANCE: S.C.I.E., \*31, rue George-Sand, Palaiseau 91, France \*GERMANY: AUSTRIA, SWITZERLAND: Industrial Electronics GMBH, \*Klüberstrasse 14, 6000 Frankfurt/Main, Germany \*UNITS IN STOCK

ENGLAND: Dale Electronics: Dale House, Wafar Road, Frimley Green, Camberley, Surrey, JAPAN: Denisho Kaisha, Ltd.: Eguchi Building, 8-1, 1-Chrome, Hamamatsucho, Minato-Ku, Tokyo. ISRAEL: Hamashbir Electronics, 76 Giborei Israel St., Tel-Aviv, Israel. \*UNIT IN STOCK.

INFORMATION RETRIEVAL NUMBER 141

ELECTRONIC DESIGN's function is:

- To aid progress in the electronics manufacturing industry by promoting good design.
- To give the electronic design engineer concepts and ideas that make his job easier and more productive.
- To provide a central source of timely electronics information.
- To promote communication among members of the electronics engineering community.

**Want a subscription?** ELECTRONIC DESIGN is sent free to qualified engineers and engineering managers doing design work, supervising design or setting standards in the United States and Western Europe. For a free subscription, use the application form bound in the magazine. If none is included, write to us direct for an application form.

If you do not qualify, you may take out a paid subscription for \$30 a year in the U.S.A., \$40 a year elsewhere. Single copies are \$1.50 each.

**If you change your address,** send us an old mailing label and your new address; there is generally a postcard for this bound in the magazine. You will have to requalify to continue receiving ELECTRONIC DESIGN free.

**The accuracy policy** of ELECTRONIC DESIGN is:

- To make diligent efforts to ensure the accuracy of editorial matter.
- To publish prompt corrections whenever inaccuracies are brought to our attention. Corrections appear in "Across the Desk."
- To encourage our readers as responsible members of our business community to report to us misleading or fraudulent advertising.
- To refuse any advertisement deemed to be misleading or fraudulent.

Microfilm copies are available of complete volumes of ELECTRONIC DESIGN at \$19.00 per volume, beginning with Volume 9, 1961. Work is now in process to complete the microfilm edition of Volumes 1-8. Reprints of individual articles may be obtained for \$2.00 each, prepaid (\$.50 for each additional copy of the same article) no matter how long the article. For further details and to place orders, contact the Customer Services Department, University Microfilms, 300 North Zeeb Road, Ann Arbor, Michigan 48106 telephone (313) 761-4700.

**Want to contact us?** If you have any comments or wish to submit a manuscript or article outline, address your correspondence to:

Editor  
ELECTRONIC DESIGN  
50 Essex Street  
Rochelle Park, N.J. 07662

# Design Data from

## Noise/Vibration Diagnosis: Real-Time Analysis Explained

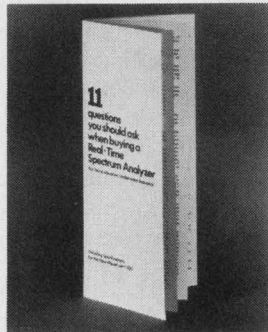

Informative booklet answers the 11 most-asked questions on what a real-time analyzer is, and how it can be used to diagnose complex machinery and trace sources of noise. It answers such questions as:  
Why do I need real time?  
How much resolution do I really need?  
Can I calibrate frequency and amplitude quickly and accurately?  
Do I need spectrum averaging?  
How can I compare past data with new data?  
How do I know I am analyzing (or averaging) valid data?  
Can I interface to my computer?

CIRCLE NO. 171

## Federal Scientific Corp.

An affil. of Nicolet Instrument  
615 West 131st St., New York, N.Y. 10027 (212) 286-4400

## DIGITAL COUNTER BUYERS' GUIDE

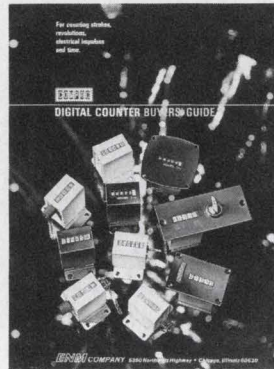

## Complete With Prices

ENM's new 8-page Buyers' Guide takes the mystery out of selecting digital counters. Provides descriptions, photos and diagrams on 76 standard devices, including (A) mechanical stroke counters, (B) revolution and direct drive counters, (C) electric counters, (D) panel mount counters, and (E) elapsed time indicators. Covers both resettable and nonresettable versions. Prices are listed for quantities of 1, 25, 50, 100, 250, 500 and 1000 to allow for replacement requirements, engineering samples, prototype runs, and large OEM production runs. Copy free on request.

CIRCLE NO. 172

## ENM Company

5340 Northwest Highway, Chicago, Ill. 60630  
Telephone: (312) 775-8400

## 400 IDEAS FOR DESIGN Volume 2

Edited by Frank Egan

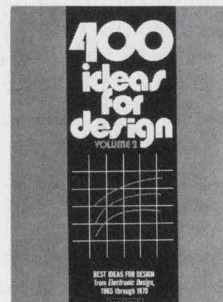

A unique sourcebook of practical design techniques and approaches using the latest components, representing the best contributions to *Electronic Design's* "Ideas for Design" column. All selected for their practical value in solving the design engineer's most common, everyday problems. They have proved useful as parts of larger designs or as aids in measuring the parameters and testing the effectiveness of existing designs. 288 pp., 7 1/8 x 9 3/4, illus., cloth, \$11.95. **Circle the reader-service number to order a 15-day examination copy.**

CIRCLE NO. 173



HAYDEN BOOK COMPANY, INC., 50 Essex St., Rochelle Park, N.J. 07662

# Manufacturers

Advertisements of booklets, brochures, catalogs and data sheets. To order use Reader-Service Card (Advertisement)

## DIGITAL FOURIER ANALYSIS SYSTEM 306

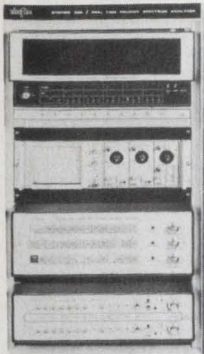

Provides complete spectral, cross spectral, correlation, cross correlation and related analysis.

- One Push Button per function eliminates programming.
- Simultaneous display of two spectra or phase and magnitude.
- Digital storage provides uninterrupted display (flicker-free).
- Drives two XY Plotters simultaneously (doubles throughput).
- Zoom FFT analysis for super high resolution.
- Unique Fourier-Fortran™ for your own non-standard or automated analysis.
- 1/3 and 1/15 octave analysis.

OPTIONAL: Magnetic tapes and discs, high speed plotters, multi processor configurations, multi channel analog multiplexer, teletypes and CRT Terminals.

ALSO AVAILABLE: Medium and high speed hardwired FFT and general purpose array processors for Data General Nova Computers.

### ELSYTEC INC.

212 Michael Drive, Syosset, N.Y. 11791  
Phone (516) 364-0560

CIRCLE NO. 174

## LOW COST MAGNETIC SHIELDS IN MINUTES



Quickly cut AD-MU high & low permeability foils to your exact shape for time saving, convenient, economical magnetic shielding. No waiting. In many applications, foils can eliminate costs of designing and manufacturing pre-fabricated shields. Also useful for those hard-to-get-at places. Furthermore, they permit more compact assemblies, accomplished by placing magnetically reacting components closer together without performance degradation. Delivery from stock. Ask about our free sample policy.

CIRCLE NO. 175

### Ad-vance Magnetics, Inc.

The Magnetic Shielding Specialists  
226 E. Seventh St., Rochester, Indiana 46975. (219) 223-3158

## Measure Vector Angle, Magnitude And Components



The new Princeton Applied Research Model 129A Two Phase Lock-In/Vector Voltmeter, enables you to simultaneously measure the magnitude and phase angle with respect to a reference signal of virtually any low-level signal within its range of 0.5 Hz to 100 kHz—even if the signal is buried 60 dB beneath background noise. At the flip of a switch, you can also measure the in-phase and quadrature components of the vector. The Model 129A features fully automatic reference tracking, independent output expansion and filtering for each channel. Complete specifications are contained in bulletin T-314, available on request.

CIRCLE NO. 176

### PRINCETON APPLIED RESEARCH CORPORATION

P.O. Box 2565  
Princeton, New Jersey 08540 (609) 452-2111

# Electronic Design

## Advertising Sales Staff

Tom W. Carr  
Vice President &  
Sales Manager

### Rochelle Park, N.J. 07662

Robert W. Gascoigne  
Daniel J. Rowland  
(Recruitment, Quick Ads, Classified)  
Allen Weinberg  
50 Essex Street  
(201) 843-0550  
TWX: 710-990-5071

### Philadelphia

Thomas P. Barth  
50 Essex Street  
Rochelle Park, N.J. 07662  
(201) 843-0550

### Boston 02178

Gene Pritchard  
P.O. Box 379  
Belmont, Mass. 02178  
(617) 489-2340

### Chicago 60611

Thomas P. Kavooras  
Berry Conner, Jr.  
200 East Ontario  
(312) 337-0588

### Cleveland

Thomas P. Kavooras  
(Chicago)  
(312) 337-0588  
(call collect)

### Los Angeles 90303

Stanley I. Ehrenclou  
Burt Underwood  
2930 Imperial Highway  
Inglewood, Calif.  
(213) 757-0183

### San Francisco 94022

Jerry D. Latta  
P.O. Box 1248  
Los Altos, Calif.  
(415) 965-2636

### London

For United Kingdom and Europe

John Ashcraft  
John Ashcraft & Co.  
12, Bear St.  
Leicester Square  
London WC2H 7AS England  
Phone: 01-930-0525

W. J. M. Sanders  
John Ashcraft & Co.  
Herengracht 365  
Amsterdam C., Holland  
Phone: 020-24-09-08

### Tokyo

Haruki Hirayama  
Electronic Media Service  
5th Floor, Lila Bldg.,  
4-9-8 Roppong  
Minato-ku  
Phone: 402-4556  
Cable: Electronicmedia, Tokyo



# advertiser's index

Advertiser	Page	Advertiser	Page	Advertiser	Page
AMP, Incorporated	79, 80, 81, 82	Fairchild Semiconductor, A Division		Mini-Circuits Laboratory	223
AVX Ceramics	169	of Fairchild Camera and		Monsanto Commercial Products Co.	84
Abbott Transistor Laboratories, Inc.	6	Instrument Corporation	190, 191	Motorola Semiconductor	
Acopian Corp.	214	Federal Scientific Corporation	224	Products, Inc.	24, 25
Ad-vance Magnetics, Inc.	225	Ferrocube Corporation	197	MuRata Corporation of America	222
AirBorn, Inc.	214	Fluke Mfg. Co., Inc., John	77	Mueller Electric Co.	216
Allen Bradley Co.	30, 31	Function Modules, Inc.	188, 218		
American Microsystems, Inc.	180, 181			National Semiconductor	
American Power Systems Corp.	221	GTE Automatic Electric	164, 165	Corporation	98
Amperite Co.	176	General Automation, Inc.	128, 129	Nova Electric Manufacturing Co.	220
Amphenol, Bunker-Ramo		General Electric Company,		Nye, William F., Inc.	227
Corp.	200, 201	Microwave Devices	67, 69		
Amphenol Industrial Division,		General Radio Company	117	Optron, Inc.	7
Bunker-Ramo Corp.	118, 119	Gold Book, The	198, 199		
Anaren Microwave Inc.	42, 43	Guardian Electric Manufacturing		Panasonic Matsushita Electric	215
Anzac Electronics	219	Company	94, 95	Pico Electronics, Inc.	210
Atlas Fibre Co.	209			Plessey Semiconductors	166
Autotron, Inc.	214			Pomona Electronics Co., Inc.	213
		Hamamatsu Corp.	211	Potter & Brumfield, Division	
Ballantine Laboratories, Inc.	211	Harris Semiconductor, A Division		of AMF Incorporated	141, 168
Bodine Electric Company	98B, 98C	of Harris Intertype Corporation	161	Princeton Applied Research Corp.	225
Bourns, Inc., Trimpot		Hayden Book Company, Inc.	74, 224	Pulse Engineering, Inc.	196
Products Division	28, 29	Heath Company	204		
Burdny Corporation	153	Heinemann Electric Company	49	RCA Solid State	
Burroughs Corporation	34	Hybrid-Packard	1, 4, 5, 32, 71, 128, 129, 202, 203	Division	14, 75, Cover IV
		Hipotronics, Inc.	182	Richo Plastic Co.	220
Cambridge Thermionic		Hybrid Systems		Rockland Systems Corporation	99
Corporation	177	Corp.	215, 217, 219, 221	Rogers Corporation	222
Centralab, The Electronics Division		Hy-Comp, Inc.	184	Rohm Corporation	98D
of Globe-Union, Inc.	72, 73, 74			Rtron Corporation	218
Cherry Electrical Products		IMC Magnetics Corp.	211	Signetics Corporation	10, 11
Corp.	146, 147	ITT Cannon Electric, International		Silicon Transistor Corporation	179
Chicago Dynamics Industries, Inc.	194	Telephone and Telegraph		Siliconix, Incorporated	96
Cincinnati Sub-Zero Products, Inc.	222	Corporation	98A	Simpson Electric Company	40
Clare & Co., C. P.	Cover III	Indiana General, Magnet		Sperry Information Displays	204
Clare-Pendar	193	Products	174, 175	Sprague Electric Company	16
Computer Design Corporation	21	International Electro Exchange		Standard Condenser Corporation	212
Connecticut Hard Rubber Co., The	186	Corporation	187	Struthers-Dunn, Inc.	170, 171
Control Switch, Inc.	213			Systron-Donner	109
Corning Glass Works,		Jermyn	143		
Electronic Products Division	22, 23	Johanson Manufacturing Corp.	227	TEC, Incorporated	52 thru 62
Cutler-Hammer, Specialty		Johnson Company, E. F.	185	TT Electronics, Inc.	227
Products Division	151			Tektronix, Inc.	37, 87, 89, 91, 93
		Keithley Instruments, Inc.	159	Teledyne Philbrick	27
Dale Electronics, Inc.	Cover III	Krohn-Hite Corporation	63	Teledyne Relays,	
Dana Laboratories Inc.	17, 18, 19, 20	Kurz-Kasch, Inc.	51	A Teledyne Company	2
Datatron, Inc.	157			Tenney Engineering, Inc.	209
Delta Products, Inc.	83	Licon, Division of Illinois		Texas Instruments, Incorporated	65
Dialight Corporation	195	Tool Works, Inc.	209	Thomas & Betts	38, 39
Dickson Electronics Corporation	189	Lockheed Missiles & Space Company	92	Triplett Corporation	155
Digitran Company, The	173				
Diva, Inc.	142	MDB Systems	227	U. S. Components, Inc.	219
Dow Corning Corporation	12, 13, 15	Magnetic Metals	172	USCC/Centralab Electronics	
Dumont, Division of		Magnetico, Inc.	227	Division, Globe-Union, Inc.	47
Thomson CSF	163	Marco-Oak, Subsidiary of		Union Carbide, Components Dept.	26
		Oak Industries, Inc.	100, 111		
ECCO	41	Micro-Line	220	Victor Comptometer Corporation	183
EMN Company	224	Microdata Corporation	90	Victoreen Instruments	192
Edmund Scientific Co.	213	Micron Industries	227		
Eldec Corporation	33	Microswitch, A Division of		Wagner Electric Company	152
Elec-Trol, Inc.	217	Honeywell	8, 9	Woven Electronics	150
Electronic Design	205, 206, 207, 230				
Electronic Molding Corp.	208			Zero Manufacturing Co.	216
Elsytec, Inc.	225				
Erie Technological Products, Inc.	135				
Exact Electronics, Inc.	88				

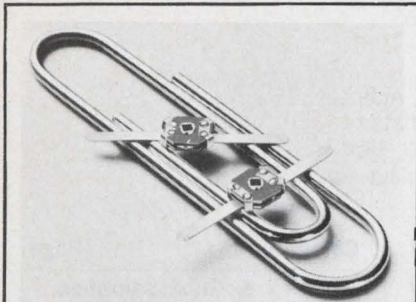

**Thin-Trim variable capacitors** provide a reliable means of adjusting capacitance without abrasive trimming or interchange of fixed capacitors. Series 9401 has high Q's and a range of capacitance values from 0.2-0.6 pf to 3.0-12.0 pf and 250 WVDC working voltage. Johanson Manufacturing Corporation, Boonton, New Jersey (201) 334-2676.

INFORMATION RETRIEVAL NUMBER 211

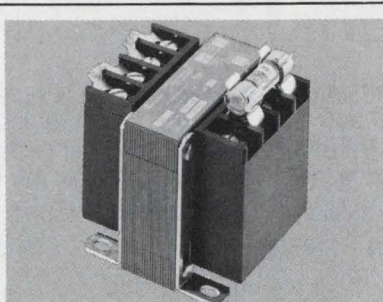

**Your transformer specs, dimensions**—our unique packaging configuration. Other magnetics such as chokes too! Virtually any V, I, f, Z combination from 10-750VA. Convenient, good-looking, cool-running with short delivery lead time. Call c/o TOLL-FREE 800-323-4893, Micron Industries, 1830 No. 32nd., Stone Pk., Ill. 60165.

INFORMATION RETRIEVAL NUMBER 212

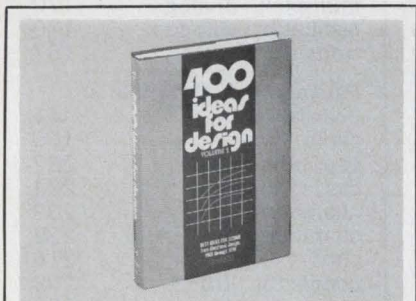

**400 Ideas for Design, Vol. 2**, Edited by Frank Egan. Ready to borrow, modify, or adapt, the top recent contributions to Electronic Design's popular "Ideas for Design" column range from amplifiers to switching circuits. 288 pp., illus., cloth, \$11.95. Circle below for 15-day examination copies. Hayden Book Co., New York, N.Y. 10011.

INFORMATION RETRIEVAL NUMBER 213



**Miniature filters** for Highpass, Lowpass Bandpass and Band Reject signal conditioning applications are described in the new catalog. Flat passbands and sharp cutoffs are featured. Specify any frequency from sub-audio to UHF. TT Electronics, Inc., 2214 Barry Ave., Los Angeles 90064. (213) 478-8224.

INFORMATION RETRIEVAL NUMBER 214

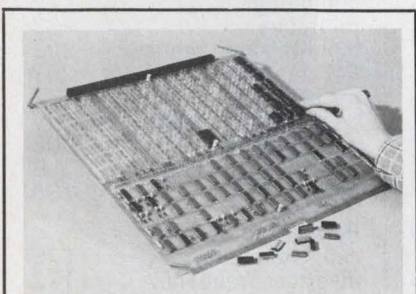

**NOVA/DCC-116 General purpose interface board** provides multiple device selection, 4 I/O registers, DMA zero word count detect, 105 socket positions for 14, 16, 24 and 40 PIN ICS. Basic board (all features of data general 4040 plus multiple device select) \$350.00. MDB Systems, Inc., 981 N. Main, Orange, CA 92667. (714) 639-7238.

INFORMATION RETRIEVAL NUMBER 215

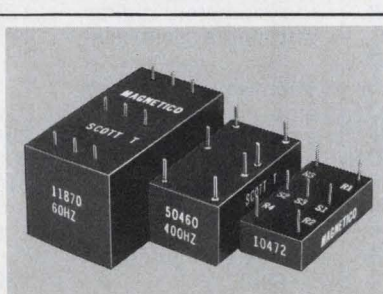

**Scott T Transformer**. 11870: 60HZ, 90v, L-L In. 1.1x2.1x1.1. 50460: 400HZ, 90v, L-L In. 7/8x1-5/8 x11/16. 50642: 400HZ, 11.8v, L-L In. 7/8x1-5/8x11/16. 10472: 400-HZ, 11.8v, L-L In. 3/4x1-1/2x3/8. All with 6v RMS sine & cosine output. MAGNETICO, INC., E. Northport, N.Y. 11731. 516-261-4502.

INFORMATION RETRIEVAL NUMBER 216

Advertisers wishing to reserve Quick Ad units should note the following mechanical requirements: Specs—Supply glossy photo of product and approximately 40 words which will set no more than 10 lines of 34 characters each. AFTER SUBMISSION NO COPY CHANGES CAN BE ACCEPTED. Quick Ads cost only \$300 per insertion, less for frequency advertisers.

## RATES:

1x  
\$300

7x  
\$280

13x  
\$255

19x  
\$250

26x  
\$245

39x  
\$240

52x  
\$235

104x  
\$230

# product index

**Information Retrieval Service.** New Products, Evaluation Samples (ES), Design Aids (DA), Application Notes (AN), and New Literature (NL) in this issue are listed here with page and Information Retrieval numbers. Reader requests will be promptly processed by computer and mailed to the manufacturer within three days.

\* Appears in the International Technology Section Outside the USA

Category	Page	IRN	Category	Page	IRN	Category	Page	IRN
<b>Components</b>			op amp, inverting			161 69		
arrestors, surge	D	187	RAM CMOS	181	84	<b>Modules &amp; Subassemblies</b>		
capacitor, ceramic	47	28	RAM, ECL	182	274	amp, chopper-stabilized	D	189
capacitors	16	11	RAM, 1024-bit	182	276	amplifier, shock	168	255
caps, variable	B	185	rectifiers (NL)	219	359	amplifiers, power	14	9
circuit breakers	49	29	register, shift	181	273	conditioner, signal	168	257
clock, display	204	102	regulator, 3-terminal	181	271	conditioners, signal	170	258
components	23	13	SCRs and rectifiers	74	36	controls, photo	214	117
displays	84	40	suppressors, transient	182	275	converter, a/d	188	91
fans	211	109	transistors, power	178	269	converter, coordinate	167	254
hybrids	196	98	zener chips	189	92	converter, d/a	170	261
indicating devices	52	243	<b>Instrumentation</b>			converters, data	167	252
LEDs	195	97	analyzers, frequency	188	284	filters, ceramic EMI	169	75
meter	17	242	capacitive discharge			filters, RFI/EMI	218	129
motors, PM	174	161	systems	83	39	generator, pulse	168	256
networks, thick-film	II	246	counters, frequency	B	182	multiplex, analog	170	259
optoelectronics	7	6	DMM	159	68	oscillator, volt-cont.	170	260
photocell, silicon	211	110	DMM	186	282	translator, data	167	253
positors	222	138	DMM	188	285	<b>Packaging &amp; Materials</b>		
relay	176	80	digital test systems	51	30	boards, socket	41	25
relays	III	247	digitizer, transient	93	47	cable	150	62
resistors	192	94	equipment, electrical			cap nuts, nylon	202	302
sockets (NL)	221	373	test (NL)	218	355	cases, formica	203	306
solenoids	95	48	generator, pulse	184	250	chambers, test	209	106
switches	147	61	generator, pulse	186	280	chambers, test	222	140
switches	168	74	instruments,			clips	216	126
switches	194	96	measurement (NL)	D	192	connector, DIP	203	305
switches	209	107	meter	5	4	connector, IC	153	65
switches (NL)	218	354	meter	40	24	connector, miniature	202	303
switches, CMOS analog	96	49	oscilloscope/calculator	91	45	connector, multicontact	D	188
switches, toggle	213	114	oscilloscopes	87	41	connectors	98A	145
switchlight	193	95	receiver, communications	D	190	connectors	160	79
transformers	210	108	recorder	186	281	connectors, PC	214	116
<b>Data Processing</b>			scales	220	134	enclosures	216	125
audio-response unit	196	297	scope, sweep	89	43	fan, cooling	201	298
controller	192	289	temperature indicator	186	283	fastener	202	304
converter, scan	194	294	tester, IC	157	67	flatpack	219	132
coupler, acoustic	192	288	tester, IC	188	286	gold plating	201	300
data entry	196	295	tester, leakage	185	279	holder, DIPs	203	307
hardware/software			thermometer, digital	188	287	interconnections	119	54
systems	137	57	wattmeter controller	185	278	lamination	172	77
keyboard, solid-state	9	235	<b>Microwaves &amp; Lasers</b>			mini/bus	222	139
memories, bipolar	191	93	amp, linear rf	210	324	modal-release agent	201	299
memories, core	B	183	amp, log	204	308	PM material	201	301
microcomputer	21	12	array	208	323	packaging	177	81
plotter, digital	194	293	holographs	210	325	packaging, plastic	IV	248
recorder, COM	193	290	laser, high-brightness			pin-in-boards	208	104
recorder, chart	196	296	(NL)	220	369	rack, instrumentation	B	181
tape transports	90	44	microwave products			tapes	186	89
tester, modem	193	291	(NL)	220	366	<b>Power Sources</b>		
tester, peripheral	194	292	mixer-preamp	210	327	cell, standard	176	266
<b>ICs &amp; Semiconductors</b>			modules, microwave			inverter, frequency	172	262
diodes (NL)	220	370	circuit	67	32	supplies, dc power	182	85
diodes and oscillators	69	33	switch, coax	B	184	supplies, high rel.	176	265
diodes and transistors			switch, SPDT transfer			supplies, power	33	20
(NL)	221	374	mm	208	320	supplies, power	135	56
ICs, calculator	181	272	switches, DIP	204	309	supplies, power (NL)	216	340
ICs, decoder/driver	181	270	synthesizer oscillator	210	326	supply, multioutput	172	263
op amp and comparator	182	277	test set, radar	B	186	supply, op amp power	214	118
op amp, FET	178	251	transistor, oscillator	208	322	supply, power	6	5
			transistors, 50-W	208	321	supply, programmable	172	264
						supply, triple output	176	268
						tripler, voltage	176	267



**new literature**

analyzer, spectrum	219	360
capacitors, SCR	218	357
capacitors and substrates	220	364
catalog	204	103
catalog	213	113
catalog, book	218	356
components	217	350
components, microwave	D	191
components, standardized	216	345
connectors	220	368
delay lines, DIP	217	353
diodes	220	370
diodes and transistors	221	374
drives, servo	221	375
equipment, elect. test	218	355
equipment, test	217	351
fasteners, self-locking	217	348
filters	220	367
HP journal	216	342
ICs, COS/MOS	219	363
instruments, electronic	D	194
instruments, measurement	D	192
inverters, freq. changers	217	349
jacks, lamp	216	343
laser, high-brightness	220	369
lights, indicator	221	376
meter, illumination	216	341
microwave products	220	366
probes, thermistor	219	361
processors, 32 and 16-bit	216	344
product guide	217	352
readout	219	362
recorder/reproducers	221	372
rectifiers	219	359
screening guide	217	347
screws, thread-forming	220	371
sockets	221	373
stop clocks, laboratory	216	346
supplies, power	216	340
switches	218	354
switches and keyboards	221	378
tape recorders, digital	221	377
temperature measurement	220	365
transformers, variable	219	358
voltmeters	D	193

**application notes**

contacts, electrical	212	330
nomograph handbook	212	329
transistors, power	212	328

**design aids**

capacitors, rf	215	338
kit, switch	215	336
selector, data modem	215	337
templates	215	339

**evaluation samples**

assemblies, terminal	212	334
calculator, contact	212	335
coil bobbins, glass epoxy	212	333
spacer, PC-board	212	331
thermistors	212	332

**recruitment and classified ads**

**IMMEDIATE DELIVERY**  
**Minis & Peripherals**  
 DEC-HIS-NOVA  
 SEL-HP-MOHAWK  
 CPU, Card, Printer, Tape, Disk  
 NEW-MOHAWK  
 4320 PRINTERS  
 DATA PRINTER V132C  
 DEC & HONEYWELL  
 MODULES  
 PDP8 CPU \$1,500  
 \$750 MINIS  
 TELETYPE 35 & 37  
 For Sale/Rent  
 617/261-1100  
 Send for Free Report  
 "Maintenance of Computers"  
**AMERICAN USED  
 COMPUTER CORP.**  
 P. O. Box 68, Kenmore Station  
 Boston, MA 02215  
 Member COMPUTER  
 DEALERS ASSOCIATION

CIRCLE NO. 230

**free catalog**  
**POTTING APPLICATORS**  
 MANUAL OR AIR OPERATED  
 2 1/2cc 6cc 12cc 30cc  
 FOR POTTING, ENCAPSULATING ETC.  
**PHILIP FISHMAN CO., INC.**  
 7 CAMERON ST. WELLESLEY, MASS 02181

**GIVE...  
 HEART  
 FUND**



**FREE ALARM CATALOG**  
 Full line of professional  
 burglar and fire alarm systems  
 and supplies. 80 pages, 400  
 items. Off the shelf delivery,  
 quantity prices.  
  
 mountain west alarm  
 4215 n. 16th st., phoenix, az. 85016

CIRCLE NO. 231

**Recruitment Advertising gets READ  
 . . . in Electronic Design**

**RATES**

1 page . . . . .	\$2,040.
3/4 page (3 cols.) . . . . .	1,530.
1/2 page (2 cols.) . . . . .	1,020.
1/4 page (1 col.) . . . . .	510.
1/8 page (1/2 col.) . . . . .	255.
1/16 page (1/4 col.) . . . . .	127.50
One column inch . . . . .	51.

**DATA**

Four column make-up. Column width: 1-3/4". Each issue mails two weeks prior to the issue date. Closing dates for camera-ready mechanicals or film is one week before mailing date. If desired, Electronic Design will set type at no charge (closing date is 2 weeks prior to mailing date).

**84,000 DESIGN ENGINEERS AND ENGINEERING MANAGERS**

Call the Recruitment Hotline: (201) 843-0550 X209 or clip & mail this coupon to: Recruitment Manager, Electronic Design, 50 Essex St., Rochelle Park, N.J. 07662.

**I'm interested in placing recruitment advertising in electronic design.**

Issue \_\_\_\_\_ Size of ad \_\_\_\_\_  
 My copy is enclosed  I need more information  
 Name \_\_\_\_\_ Title \_\_\_\_\_  
 Company \_\_\_\_\_ Telephone \_\_\_\_\_  
 Address \_\_\_\_\_  
 City \_\_\_\_\_ State \_\_\_\_\_ Zip \_\_\_\_\_

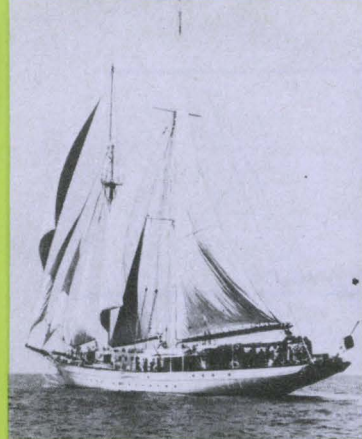

# 1974 SUPER TOP TEN CONTEST RULES

## Reader Contest

**PICK THE TOP TEN ADVERTISEMENTS IN THIS ISSUE . . . WIN A WINDJAMMER CRUISE FOR TWO . . . \$1,000 CASH . . . FREE JET FLIGHT . . . FREE RERUNS OF YOUR COMPANY'S AD . . . 100 PRIZES IN ALL.**

Examine this issue of *Electronic Design* with extra care. Pick the ten advertisements that you think will be best remembered by your fellow engineer-subscribers. List these ten advertisements on the special entry form bound in at right. (Be sure to check the box marked "Reader Contest.")

Your selections will be measured against the ten ads ranking highest in the "Recall Seen" category of Reader Recall — *Electronic Design's* method of measuring readership. In making your choices do not include "house" advertisements placed by *Electronic Design* or Hayden Publishing Company, Inc. (such as this ad describing the contest). Don't miss your chance to be a Top Ten Winner! All entries must be postmarked no later than midnight, February 15, 1974. Winners will be notified in March 1974.

### READER CONTEST RULES

1. Enter your *Top Ten* selections on the entry blank provided, or on any reasonable facsimile. Be sure to indicate the name of the advertiser and *Information Retrieval Number* for each of your choices. Do not use page number. (Ads placed by Hayden Publishing Company in *Electronic Design* should not be considered in this contest.)

2. No more than one entry may be submitted by any one individual. Entry blank must be filled in completely, or it will not be considered. The box on the entry blank marked "Reader Contest" must be checked. *Electronic Design* will pay postage for official entry blanks only.

3. To enter, readers must be engaged in electronic design engineering work, either by carrying out or supervising design engineering or by setting standards for design components and materials.

4. No cash payments, or other substitutes, will be made in lieu of any prize, (except the \$1,000 prize).

5. Contest void where prohibited or taxed by law. Liability for any taxes on prizes is the sole responsibility of the winners.

6. Entries will be compared with the "Recall Seen" category of Reader Recall (*Electronic Design's* method of measuring readership). That entry which in the opinion of the judges most closely matches the "Recall Seen" rank, will be declared the winner.

7. In case of a tie, the earliest postmark will determine the winner. Decisions of *Top Ten* contest judges will be final.

8. Free reruns of any advertisement will be made only from existing plates or negatives. If the advertisement qualifying for a free rerun is an insert, the winner's company may run a two-page spread from existing plates or negatives in up to 4-colors.

9. Hayden Publishing Company, Inc. reserves the right to schedule reruns at its discretion.

**FOR A COMPLETE DESCRIPTION OF PRIZES  
FOR BOTH READER AND ADVERTISER CONTESTS  
SEE PAGES 206 AND 207**

## USE SPECIAL ENTRY BLANK BOUND IN AT RIGHT

(Additional entry blanks are bound inside the front cover)

## Advertiser Contest

**PICK THE TOP TEN ADVERTISEMENTS IN THIS ISSUE . . . WIN A WINDJAMMER CRUISE FOR TWO . . . \$1,000 CASH . . . FREE JET FLIGHT . . . COLOR TV . . . BULOVA TIMEPIECE.**

There's a separate contest open to all marketing and advertising personnel in companies, and to advertising agencies.

Examine this issue of *Electronic Design* with extra care. Pick the ten advertisements that you think will be best remembered by *Electronic Design's* readers. List these ten advertisements on the special entry blank bound in the front or back of this issue. (Be sure to check the box marked "Advertiser Contest".)

In addition to valuable prizes, all ads that place in the Top Ten will be given free reruns. If you are a winner in the advertiser contest, and if you ran an ad in the January 4 issue that did not place in the Top Ten, that advertisement, or a like ad of your choice, will be given a free rerun. See rules if the winning ad is an insert.

### ADVERTISER CONTEST RULES

1. All rules for the Reader Contest will similarly apply for this contest, with two exceptions: readers engaged in electronic design engineering work, as defined in the reader contest rules, are not eligible to participate in this special contest. The box on the entry blank marked "Advertiser Contest" must be checked.

2. Entrants in this contest may use the official reader contest entry blanks or any reasonable facsimile.

3. This special contest is open to marketing and advertising personnel only at all manufacturing companies and advertising agencies whether or not their companies or agencies have an advertisement in the January 4, 1974 issue. However, only those companies (or divisions thereof) advertising in the Jan. 4 issue, and the advertising agencies placing such advertisements are eligible for a free rerun of their advertisement should a member of their organization win.

4. Free reruns of any advertisement will be made only from existing plates or negatives. If the advertisement qualifying for a free rerun is an insert, the winner may run a two-page spread from existing plates or negatives in up to 4-colors.

5. Hayden Publishing Company, Inc., reserves the right to schedule reruns at its discretion.

**FOR A COMPLETE DESCRIPTION OF PRIZES  
FOR BOTH READER AND ADVERTISER CONTESTS  
SEE PAGES 206 AND 207**

## USE SPECIAL ENTRY BLANK BOUND IN AT RIGHT

(Additional entry blanks are bound inside the front cover)

**“Interfacing the computer with my process is tough. The severe noise, high loads, long lines and high ambient magnetic**



**field give us nothing but problems. Add to that the rotten environment with high temperature and awful dust, and it's almost impossible.**

**I need help with my relays. Right now!”**

From signal switching to power switching—under truly bad environmental conditions—Clare's reliable mercury-wetted relays and the new solid state relays solve your problems.

The inherent design of Clare's mercury-wetted relays stands up to the extreme demands of a severe environment and provides nearly infinite life. And it makes these relays flexible. They can switch low level analog data into an A/D converter, or configured into the

access matrix, perform in severe environments. When designed into control matrix they can drive your heavy industrial loads.

If a high magnetic environment is your problem, Clare's new solid state 10 Amp and DIP (3/4 Amp) relays are another way to go. They're not position sensitive. Shock and vibration can't affect them. And they also last nearly forever.

Our expertise lies in the advanced design and manufacture of relays. But our energy lies in the application

of relays to help you solve specific problems. We specialize in getting down to work.

If you need help with your interfacing problem—or just some good information—get in touch with us right now. The “right now bunch” is ready to go to work for you.

Contact your local Clare Distributor or Sales Engineer. C. P. Clare & Co., 3101 Pratt Avenue, Chicago, Ill. 60645 312/262-7700.

**QUALITY/SERVICE/RELIABILITY**

**we help. get in touch with us.  CLARE the “right now” bunch.**

a GENERAL INSTRUMENT company

GENERAL PURPOSE RELAYS MERCURY-WETTED RELAYS REED RELAYS SOLID STATE RELAYS TELEPHONE RELAYS STEPPING SWITCHES  
INFORMATION RETRIEVAL NUMBER 247

# RCA's new plastic package is 100 times better...

We call it the E-55 Plastic Packaging System: But you don't have to remember the name — because every plastic LINEAR IC you buy from RCA is packaged in this new system that features **IMPROVED RELIABILITY OF TWO ORDERS OF MAGNITUDE... at no extra cost.**

Just look at the results of five real-time indicator tests. They tell the story.

- Temperature Cycling (at 200 cycles) — 1600 times improvement.
- Thermal Shock — 610 times improvement.
- Pressure Cooker — 250 times improvement.
- Bond Pull Strength — 10 times improvement.
- Hot intermittent opens — 250 times improvement.

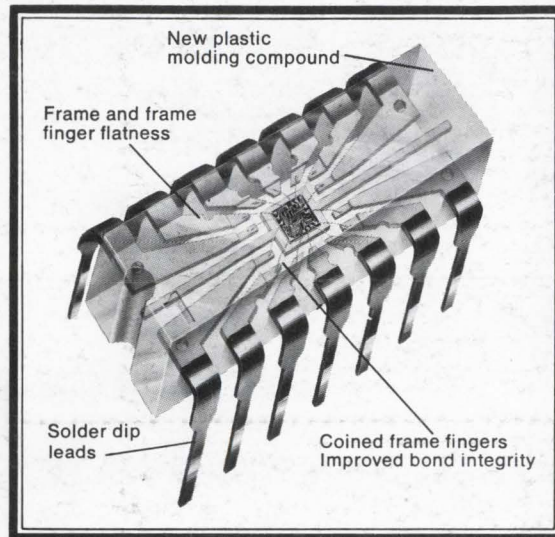

E-55 is a totally new system of plastic packaging. RCA has improved materials, handling procedures and process controls to bring you a low-cost state-of-the-art IC plastic package that matches the reliability of hermetic

packages under severe environmental stress. And it offers operation in the full temperature range of  $-55^{\circ}$  to  $+125^{\circ}\text{C}$ . So design in a real package of reliability... RCA's 100 times improved E-55 Plastic Packaging system.

Want more details on the E-55 plastic package system and reliability test data?

Write RCA Solid State, Section 57A-4, Box 3200, Somerville, New Jersey 08876. Or phone: (201) 722-3200.

**RCA** Solid State  
products that make products pay off