

# Electronic Design<sup>®</sup> 10

FOR ENGINEERS AND ENGINEERING MANAGERS

VOL. 24 NO.

MAY 10, 1976

**Bipolar bit-slice microprocessors** replace scores of conventional logic circuits at reduced power. Through microprogramming, you can achieve a precise emulation

of existing equipment without the need to change system software. The result: minis and high-speed controllers can be made smaller and more versatile. See p. 34.

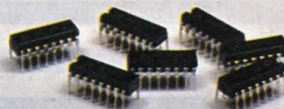
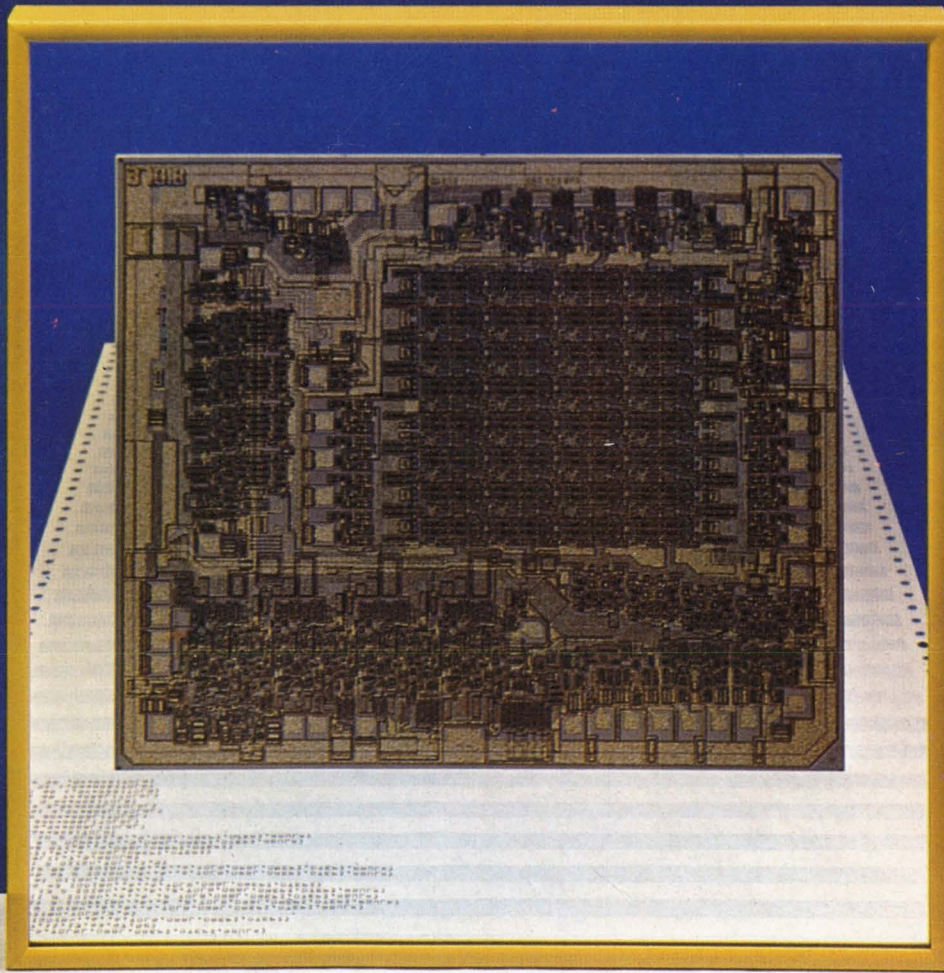

**RENEW NOW**  
YOUR SUBSCRIPTION WILL EXPIRE. See card inside cover.

**ELECTRO '76**

# Swage-Bond™ ... a revolution in trimmer reliability!

## ... here today at no extra cost in every Trimpot® Potentiometer

Historically, pin-to-element termination problems have been one of the primary causes of trimmer failure . . . especially during handling and PC board process operations. Bourns exclusive Swage-Bond™ process virtually eliminates pin termination failure . . . truly a revolution in trimmer reliability. Furthermore, Swage-Bonding results in a marked improvement in temperature coefficient consistency.

Other trimmer manufacturers utilize a simple clip-on termination. Some solder this connection, some rely on tension pressure alone. In the Swage-Bond process, the P.C. pins are secured **through** the substrate, with a high-pressure compression swage on both top and bottom sides. The pressure of the swage locks the pin solidly into the element, and thoroughly bonds it to the thick-film termination material.



Swage-Bond™ eliminates pin termination failure, provides more reliable tempco. Microphotograph shows trimmer element magnified 20X.



### The seal that seals . . . without springback

Bourns trimmers stay sealed when others fail. We know. We've tested them all. Bourns uses a chevron-type sealing technique, that seals without O-rings . . . eliminating the windup and springback that frequently occurs with such seals. The result is faster and more precise adjustability . . . with a seal that really works.



### Wrap-around wiper for better setting stability

Bourns multi-fingered, wrap-around wiper delivers more consistent, more reliable performance. The unique design significantly reduces CRV fluctuations and open circuit problems due to thermal and mechanical shock . . . by maintaining a constant wiper pressure on the element. Compare the ruggedness of Bourns design with the common "heat-staked" wiper designs. Compare performance. Specify Bourns.

### HERE'S PROOF:

Send for a copy of our new engineering report on TRIMMER PERFORMANCE. Tell us about your application, and we'll provide qualification samples that best suit your needs.

Bourns reliability is available at ordinary prices . . . off-the-shelf from nearly 100 local distributor inventories . . . plus our largest-ever factory stock. TRIMMER PRODUCTS, TRIMPOT PRODUCTS DIVISION, BOURNS, INC., 1200 Columbia Avenue, Riverside, California 92507. Telephone 714 781-5320 — TWX 910 332-1252.



International: HQ Switzerland, 042/23 22 42 • Belgium 02/218 2005 • France 01/2039633 • Germany 0711/24 29 36 • Italy 02/32 56 88 • Netherlands 070/88 93 18 • United Kingdom 01/572 6531 • Japan 075 92 1121 • Australia 86 9410 • Brazil 257-3535 • India 373 544

# The Model 186 art gallery.

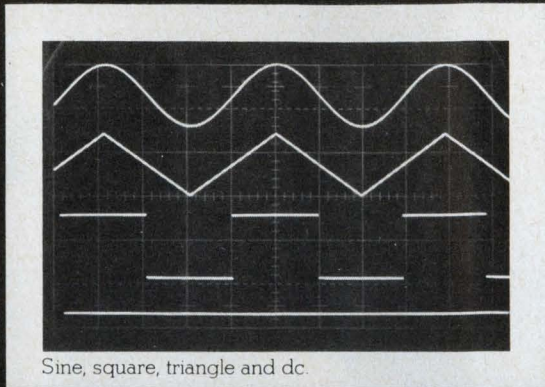

Sine, square, triangle and dc.

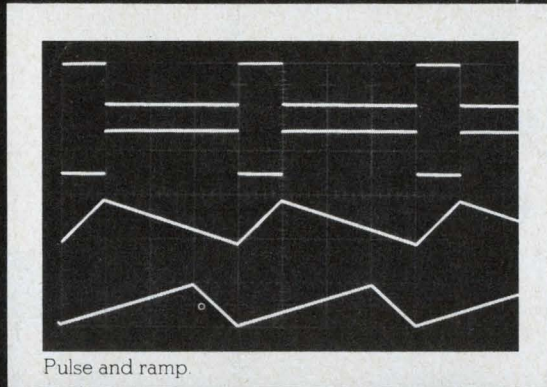

Pulse and ramp.

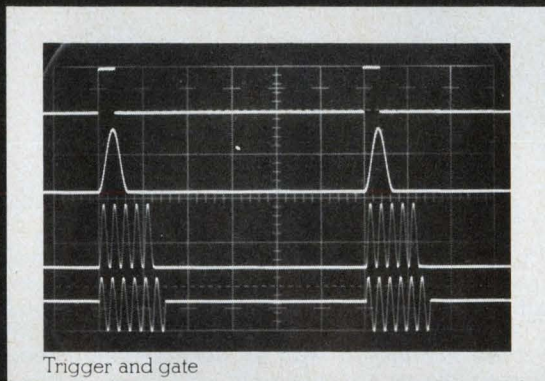

Trigger and gate

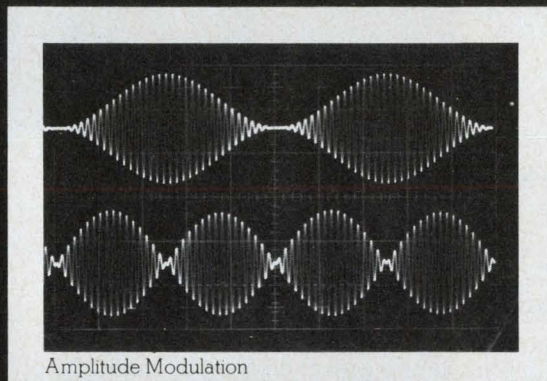

Amplitude Modulation

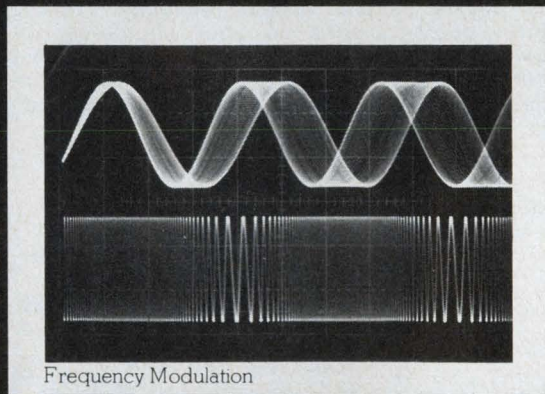

Frequency Modulation

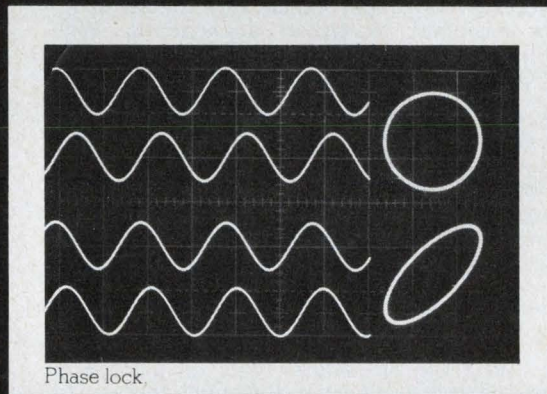

Phase lock.

There's a whole lot more to the Model 186 than just pretty pictures. Like its calibrated phase lock and built-in oscillator for 1 kHz AM/FM capabilities. It also has 30 v p-p output plus continuous, triggered and gated modes. And it's the only generator that gives you the combination of AM and phase lock.

The Model 186 has a frequency range of 0.0001 Hz to 5 MHz and sells for just \$795. Just circle our bingo number and we'll send you the complete picture.

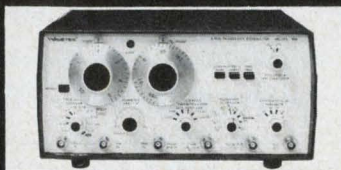

## WAVETEK®

P.O. BOX 651, SAN DIEGO, CALIFORNIA 92112  
TELEPHONE (714) 279-2200, TWX 910-335-2007

# The only Double-Balanced Mixers with a 2-YEAR GUARANTEE\*

## featuring Hi-Rel tested diodes-

still only

# \$7.95

(500 pieces)

\$9.95 (1-49)

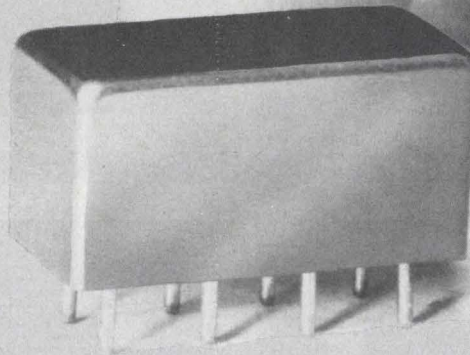

\*including diodes!

Yes, a two-year guarantee for DBM's is now a reality . . . made possible by an accelerated-life diode screening program adopted at Mini-Circuits.

Each Schottky diode used in Mini-Circuits' SRA-1 mixers is now preconditioned by the HTRB (High Temperature Reverse Bias) technique, previously reserved almost exclusively for semiconductors assigned to space applications. With HTRB testing, each diode is operated for 168 hours at 150°C with one volt reverse bias applied.

To screen out "infant mortality", the diodes are deliberately stressed to accelerate aging and to force time-related failure modes to take their toll. In conventional testing or "baking", the diode does not experience anywhere near the stress encountered with the HTRB program. Hence, the ability at Mini-Circuits' to locate the potentially-unreliable diodes before they are assembled into SRA-1 units. And, with double-balanced mixers, the overall reliability hinges almost entirely on the diodes used.

Yes, the HTRB procedure costs us more and screens out more devices. But our goal is to improve reliability to a level unmatched for off-the-shelf DBM's at no increase in cost to our customers. You — our customers by your overwhelming confidence in our product line have made us the number one supplier of DBM's in the world.

To earn your continuing support, we are now employing HTRB Hi-Rel testing for every diode used in the SRA-1, at no increase in cost to you. So, for the same low price of \$7.95, you can purchase our SRA-1, with a two-year guarantee, including diodes.

To ensure highest system reliability demand highest quality diodes on your source-control drawings and purchase orders. Specify SRA-1 mixers, with HTRB tested diodes from Mini-Circuits'.. where low price now goes hand-in-hand with unmatched quality.

#### MODEL SRA-1

Freq. range (MHz) LO - 0.5-500, RF 0.5-500, IF dc-500

Conversion loss (dB) **Typ.** **Max.**

One octave from band edge 5.5 7.5

Total range 6.5 8.5

Isolation (dB) **Typ.** **Min.**

Lower band edge to LO-RF 50 35

one decade higher LO-RF 45 30

Mid range LO-RF 45 30

LO-IF 40 25

Upper band edge to LO-RF 35 25

one octave lower LO-IF 30 20

Min. Electronic attenuation (20 mA) 3 dB

Signal, 1 dB compression level + 1 dBm

Impedance all ports 50 ohms



## Mini-Circuits Laboratory

A Division Scientific Components Corp

837-843 Utica Avenue, Brooklyn, NY 11203

(212) 342-2500 Int'l Telex 620156

Domestic Telex 125460

#### International Representatives:

**AUSTRALIA** General Electronics Services, 99 Alexander Street, New South Wales, Australia 2065; **ENGLAND** Dale Electronics, Dale House, Wharf Road, Frimley Green, Camberley Surrey; **FRANCE** S. C. I. E. - D. I. M. E. S., 31 Rue George - Sand, 91120 Palaiseau, France; **GERMANY, AUSTRIA, SWITZERLAND** Industrial Electronics GMBH, Klüberstrasse 14, 6000 Frankfurt/Main, Germany; **ISRAEL** Vectorics, Ltd., 69 Gordon Street, Tel Aviv, Israel; **JAPAN** Densho Kaisha, Ltd., Eguchi Building, 8-1-1 Chome Hamamatsucho Minato-ku, Tokyo; **EASTERN CANADA** B. D. Hummel, 2224 Maynard Avenue, Utica, NY 13502 (315) 736-7821; **NETHERLANDS, BELGIUM, LUXEMBOURG**: Cormex, Veldweg 11, Hattem, Holland; **NORWAY** Datamatik AS, Ostensjoveien 62, Oslo 6, Norway

**US DISTRIBUTORS:** **NORTHERN CALIFORNIA** Cain White & Co., Foothill Office Center, 105 Fremont Avenue, Los Altos, CA 94022 (415) 948-6533; **SOUTHERN CALIFORNIA, ARIZONA** Crown Electronics, 11440 Collins Street, No. Hollywood, CA 91601 (213) 877-3550

For complete product specifications and U.S. Rep. listing see MicroWaves "Product Data Directory," Electronic Designs' "Gold Book" or Electronic Engineers Master "EEM"

---

## NEWS

- 27 **News Scope**
- 34 **Bipolar bit-slice  $\mu$ Ps shrink** the size and cost of minis and controllers.
- 42 **Transient testing is spreading** to systems designers and so is the use of the IEEE Surge-Withstand Capability test.
- 47 **Washington Report**

---

66 **Electro 76**—A special section devoted to this year's big Boston show.

---

## TECHNOLOGY

- 53 **MICROPROCESSOR DESIGN**
- 84 **Build a compact microcomputer** by starting with a  $\mu$ P like the 8080 and surrounding it with peripheral LSI interfaces that can be programmed for specific jobs.
- 94 **Log data under  $\mu$ P control** and enjoy the benefits of software flexibility. Among the advantages: reformattable interfaces and less hardware.
- 104 **International Technology**
- 106 **Ideas for Design:**  
CMOS analog switches can precisely control an op-amp's gain.  
Control a VCO's start and stop phases with a squelch input signal.  
Efficient switching controller drives low-power dc servo motor.

---

## PRODUCTS

- 113 **Data Processing:** Data terminal features low-cost, programmable character set.
- 132 **Integrated Circuits:** Three-digit DVM chip requires only 30 mW.
- 138 **Instrumentation:** Amplifiers deliver flat output from 0.15 to 300 MHz.
- 160 **Power Sources:** Ac source regulates output as both line and load change.
- 120 Packaging & Materials
- 128 Microwaves & Lasers
- 151 Components
- 154 Modules & Subassemblies
- 157 Discrete Semiconductors

---

## DEPARTMENTS

- 63 **Editorial:** The importance of Jack
- 7 Across the Desk
- 164 Evaluation Samples
- 164 Application Notes
- 166 New Literature
- 174 Advertisers' Index
- 176 Product Index
- 176 Information Retrieval Card

**Cover:** Photo by Hal Smith, courtesy of Advanced Micro Devices.

# TEKTRONIX logic analyzers



TEKTRONIX

TRIG - 047

1101 0010 0100 1010

# for the digital domain

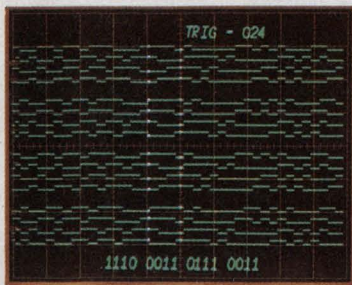

Timing and binary information together with intensified trigger marker and cursor displayed by the 7D01 Logic Analyzer. The number of sample intervals from the trigger point to the cursor appears at the top of the display; data stored at the cursor position is displayed in binary across the bottom of the crt.

## New Plug-ins with Expanded Capabilities

For digital design and testing applications, you'll find that Tektronix Logic Analyzers and Oscilloscopes are literally made for each other. To expand your digital analysis capabilities, choose either the 7D01 Logic Analyzer (a new plug-in for our 7000-Series laboratory oscilloscope family) or the LA 501 Logic Analyzer and its new companion plug-in, the WR501 Word Recognizer (these two are packaged as modular TM 500-Series instruments to work with almost any oscilloscope).

Features these analyzers have in common include:

- 16 Channel Operation
- 15-ns Asynchronous Timing Resolution
- 4k Memory to Store Pretrigger Data
- Word Recognition
- High Z Probes

For versatile data acquisition, these logic analyzers let you select the number of channels and the resolution best suited to specific applications:

- 16 Channels, 20 MHz, 256 Memory Bits
- 8 Channels, 50 MHz, 512 Memory Bits
- 4 Channels, 100 MHz, 1024 Memory Bits

You'll like what we've done to **reduce circuit loading problems** associated with testing high-speed and high-impedance logic families. With our new P6451 active probes, which have an input impedance of **1 M $\Omega$  paralleled by 5 pF at the probe head**, you'll be able to test virtually any logic family.

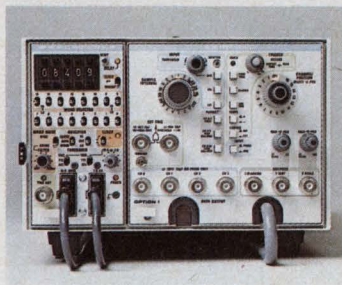

## LA501/WR501, Members of the TM 500 Series

Take your logic analyzer right to the problem with the LA 501 Logic Analyzer and its new companion word recognizer, the WR 501. Packaged as modular TM 500 test instruments, this pair works with any oscilloscope or X-Y monitor. Now you've got versatile logic analysis capabilities to complement the oscilloscope you probably already own.

**Word recognition with digital delay** gives you fast access to almost any location in the data stream.

For **channel-to-channel timing comparisons**, you can select any trace and position it next to any other. And **timing tic marks** on each channel enhance visual analysis.

No matter what your application—design, production testing, or service we've got a TM 500 logic analysis configuration for you.

On the bench, power the LA 501 and WR 501 with the TM 503 mainframe or the TM 504 mainframe (now you've got room for another TM 500 module like the DMM 502 Digital Multimeter).

In a rack, use the RTM 506—there's room enough for the LA 501, the WR 501, the SC 502 Oscilloscope, and one more module. Or you can mount the LA 501 and WR 501 in a TM 503 side by side with a 604 Monitor. The 6½-in. display is easy to read.

For **field portability**, try the TM 515 Traveler Mainframe. It's rugged and durable, yet as attractive as carry-on luggage. You can pack the LA 501, the WR 501, and the SC 502 and have a complete logic analysis system in a suitcase.

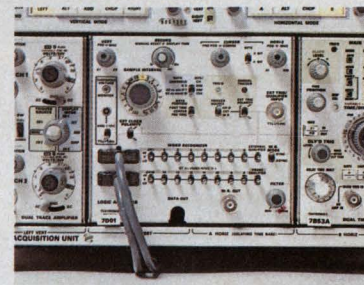

## 7D01, A Member of the 7000 Series

Turn any 7000-Series laboratory oscilloscope into a versatile 16-channel logic analyzer with the new 7D01 dual-wide plug-in. Now, gaining logic analysis capability is as simple as adding a plug-in.

With a four-compartment 7000-Series mainframe and plug-ins, you get a truly powerful logic design tool: **a logic analyzer and a real-time oscilloscope in one unit**. Use the 7D01 Logic Analyzer to locate a digital domain problem, then zero in for detailed analysis by using the 7D01's word recognizer to trigger the analog portion of your oscilloscope. Now you can do it with one instrument and display your digital and analog information on the same crt.

With the 7D01 you also get **timing and binary information displayed simultaneously** on the crt. You do it with a cursor. And because the cursor can be moved in single clock intervals, **timing comparisons are faster, easier and more error-free than visual estimates**. When the cursor is moved to a given clock position, the binary word at that point is read out across the bottom of the display.

The LA 501/WR 501 and the 7D01 Logic Analyzers will be on display at ELECTRO76. Stop by our booth for all the details and a hands-on demonstration. If you can't make it to the show, call your nearby Tektronix Field Engineer or write Tektronix, Inc., P.O. Box 500, Beaverton OR 97077.



**TEKTRONIX®**

committed to  
technical excellence

FOR TECHNICAL DATA CIRCLE #275  
FOR DEMONSTRATION CIRCLE #276

New at **ELECTRO76**

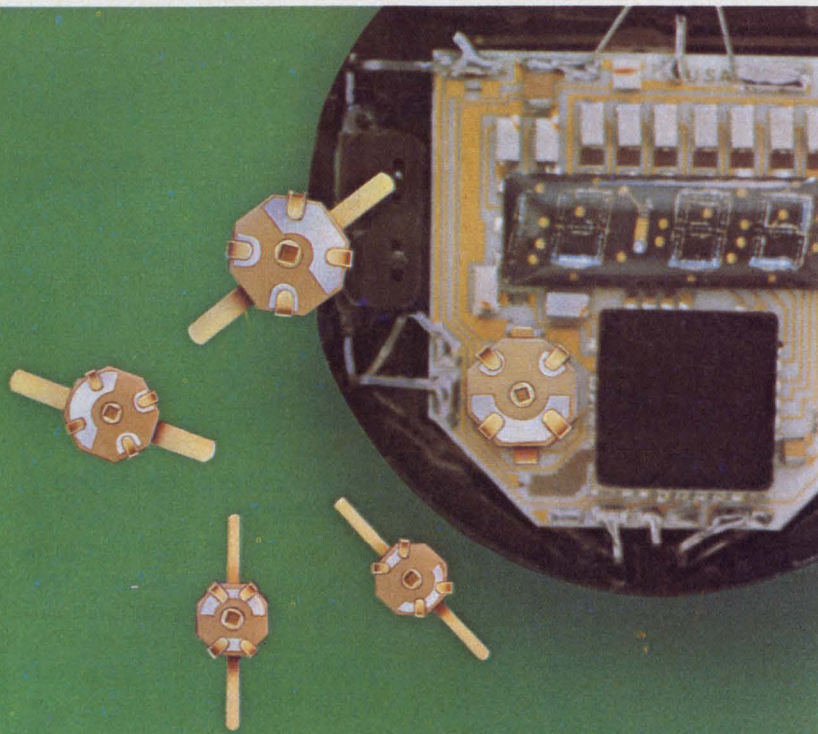

# Thin-Trim<sup>®</sup> capacitors

Tucked in the corner of this Pulsar Watch is a miniature capacitor which is used to trim the crystal. This Thin-Trim capacitor is one of our 9410 series, has an adjustable range of 7 to 45 pf, and is .200" x .200" x .050" thick.

The Thin-Trim concept provides a variable device to replace fixed tuning techniques and cut-and-try methods of adjustment. Thin-Trim capacitors are available in a variety of lead configurations making them easy to mount.

A smaller version of the 9410 is the 9402 series with a maximum capacitance value of 25 pf. These are perfect for applications in sub-miniature circuits such as ladies' electronic wrist watches and phased array MIC's.

The logo for Johanson Manufacturing Corporation, featuring the name "Johanson" in a stylized, cursive script font enclosed within an oval border.

Johanson Manufacturing Corporation  
Rockaway Valley Road  
Boonton, New Jersey 07005  
(201) 334-2676 TWX 710-987-8367

**Sr. Vice President, Publisher**  
Peter Coley

## Editors

Editorial Offices  
50 Essex St.  
Rochelle Park, NJ 07662  
(201) 843-0550  
TWX: 710-990-5071  
Cable: Haydenpubs Rochellepark

**Editor-in-Chief** George Rostky

## Managing Editors:

Ralph Dobriner  
Michael Elphick

## Associate Editors:

Dave Bursky  
Samuel Derman  
Morris Grossman  
John F. Mason  
Stanley Runyon  
Michael Shunfenthal  
Edward A. Torrero

## Contributing Editors:

Peter N. Budzilovich, John Kessler  
Alberto Socolovsky, Nathan Sussman

## Editorial Field Offices

### East

Jim McDermott, Eastern Editor  
P.O. Box 272  
Easthampton, MA 01027  
(413) 527-3632

### West

David N. Kaye, Senior Western Editor  
8939 S. Sepulveda Blvd., Suite 510  
Los Angeles, CA 90045  
(213) 641-6544  
TWX: 1-910-328-7240

Jim Gold, Western Editor  
1454 Burrell Court  
San Jose, CA 95126  
(408) 246-6094

## Editorial Production

Marjorie A. Duffy, Production Editor  
Tom Collins, Copy Editor

## Art

**Art Director**, William Kelly  
Richard Luce, Anthony J. Fischetto

## Production

**Manager**, Dollie S. Viebig  
Helen De Polo, Anne Molfetas

## Circulation

**Manager**, Barbara Freundlich  
Trish Edelmann, Gene M. Corrado

## Information Retrieval

Peggy Long

## Advertising Promotion

Paul K. Hogue

## Promotion, Creative Layouts

**Manager**, Albert B. Stempel  
Maxine Correal, Nancy Gordon



# Across the Desk

## Bicentennial issue praised

### Look ahead

Congratulations on your "200 Years of Progress" issue (ED No. 4, Feb. 16, 1976) and the letter from President Ford. The Bicentennial makes me a little worried, unfortunately, that we may become so lost in retrospection that we may overlook what needs to be done in the future.

*William N. Bushey*

5002 N. 78th Street  
Scottsdale, AZ 85253

### Required reading

Last night I couldn't put down the ED Bicentennial Issue! Reads better than fiction—absolutely fascinating! My copy is already circulating around San Antonio to selected friends who would appreciate your efforts.

I can remember lamenting the meager (or nonexistent) historical data grudgingly given by EE profs during school. Your special issue should be required reading material for students of the industry.

*Leroy H. Becker*

Union Instrument Corp.  
12108 Radium  
San Antonio, TX 78216

### 'Absolutely great'

ELECTRONIC DESIGN has done it again! Your special Bicentennial issue was absolutely great! Dr. Digner was especially pleased with your article.

Please extend our congratula-

tions to all who participated.

*Therese Michalic*

Burndy Corp.  
Norwalk, CT 06856

### An early phonograph

Your account of "200 Years of Progress" was great—really great! It was all succinctly stated and the manner in which concurrent events from other fields were woven in put your account of electrical history into refreshing perspective.

One addendum may be of interest: you mentioned (p. 102) Bell's licensing the Orthophonic phonograph system to Victor. As I recall, this system was a high-fidelity acoustic phonograph of remarkable tonal quality. According to information I recently stumbled across, the design of the acoustic pick-up head for that system was among the first applications of network theory to mechanical problems.

By manipulating the values of electrical analogs of the mechanical parts of the system, including a specially contoured aluminum diaphragm that functioned as the sound transducer, Bell engineers arrived at a design that had flat, broadband response—and it really delivered clean sound. Unfortunately, it didn't compete in the marketplace against the then-emerging, more powerful vacuum-tube systems.

*Howard Roberts*

Hewlett-Packard Co.  
1501 Page Mill Rd.  
Palo Alto, CA 94304

*(continued on page 10)*

Electronic Design welcomes the opinions of its readers on the issues raised in the magazine's editorial columns. Address letters to Managing Editor, Electronic Design, 50 Essex St. Rochelle Park, N.J. 07662. Try to keep letters under 200 words. Letters must be signed. Names will be withheld on request.

## The smallest\*

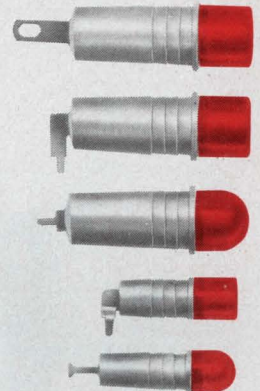

## re-lampable indicators are

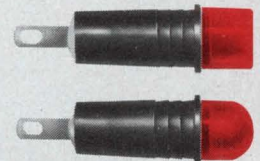

## Illuminated Products' QT Series incandescent, neon, and LED indicators

- Long-life reliability
- Simplified press-in panel mounting
- All popular lens colors and styles
- Distributor on-shelf availability now

\*Actual size shown

Lighten your decisions  
contact . . .

### ILLUMINATED PRODUCTS INC.

A subsidiary of OAK Industries Inc.  
2620 South Susan St., P.O. Box 11930  
Santa Ana, California 92711  
Tel: (714) 540-9471 • TWX 910-595-1504



COMPONENTS GROUP

CIRCLE NUMBER 5



## The AMI 6800 Micro

**We started by redesigning a CRT.  
And ended with the fastest, easiest  
way to build microcomputer systems.**

The AMI 6800 MDC architecture is so far ahead of the competition they'll have to change their whole development philosophy to catch up.

Unlike their multiple box approach, with lights and switches, our grand plan is centered around a very smart CRT, with full debug software.

There's a 6800 system in the terminal, so the processor you're working with is the same one you're developing. That cuts your learning time in half.

And you can forget about those long hassles with paper tape, front panels, teletype or cassettes. Put your hands on our keyboard and

you never have to let go. You modify information instantaneously. Interrupt a program after every instruction, and get a complete snapshot of the state of the machine. Look at all the registers and change their values, simply by pressing a key. And you never have to translate addresses into binary to get information.

Our 6800 MDC not only cuts programming time in some cases from hours to minutes, it can also be configured as a test center for incoming 6800 parts. And it adapts easily to a powerful, one megabyte microcomputer for a variety of uses, such as inventory control.

The standard AMI Microcomputer Development Center consists of the 80 char. x 25 line CRT, the dual floppy disk with disk operating system, S6834 EPROM programmer,

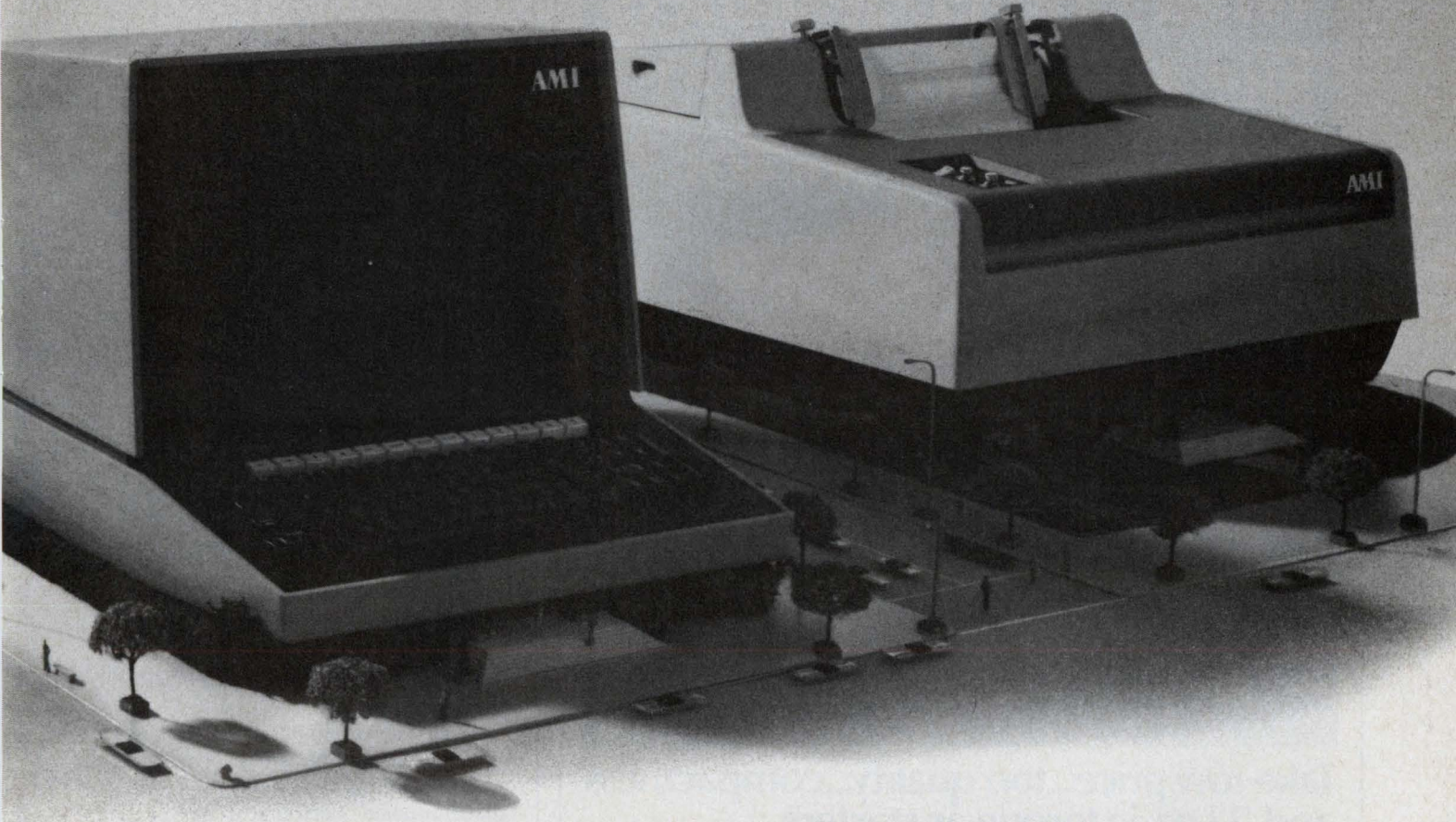

# computer Development Center.

RS232 interface and 16K words of RAM memory. The many options will include a character printer, an in-circuit emulator so you can use the CRT like a front panel, EPROM and RAM memory modules.

So now the most flexible, easiest-to-use microprocessor family, the AMI 6800, has taken another giant step ahead of the others. The AMI 6800 Microcomputer Development Center can get you to the market faster, with a better product. Ask your AMI sales office, distributor or representative for our brochure. Or write to AMI, 3800 Homestead Road, Santa Clara, CA 95051. Then see how fast things develop.

**it's  
standard  
at AMI**

AMERICAN MICROSYSTEMS, INC.

## This is the way to the Center:

### SALES OFFICES

Manhattan Beach CA •  
(213) 379-2452  
San Jose CA • (408) 249-4550  
Altamonte Springs FL •  
(305) 830-8889  
Elk Grove Village IL •  
(312) 437-6496  
Norwood MA • (617) 762-0726  
Livonia MI • (313) 478-9339  
Minneapolis MN •  
(612) 559-9004  
Monsey NY • (914) 352-5333  
Cleveland OH • (216) 292-6850  
Ambler PA • (215) 643-0217  
Richardson TX • (214) 231-5721

### DISTRIBUTORS

ALTA ELECTRONICS:  
Utah—Salt Lake City  
(801) 486-7227  
ARROW ELECTRONICS:  
Minnesota—Bloomington  
(612) 888-5522  
CENTURY ELECTRONICS:  
New Mexico—Albuquerque  
(505) 292-2700  
Utah—Salt Lake City  
(801) 487-8551  
INTERMARK ELECTRONICS:  
Washington—Seattle  
(206) 767-3160  
SCHWEBER ELECTRONICS:  
California—Costa Mesa  
(213) 924-5594 and  
(714) 556-3830  
Connecticut—Danbury  
(203) 792-3500  
Florida—Hollywood  
(305) 927-0511  
Georgia—Atlanta (404) 449-9170  
Illinois—Elk Grove Village  
(312) 593-2740  
Iowa—Cedar Rapids  
Lorenz Sales  
(319) 393-0100

Maryland—Rockville  
(301) 881-3300  
Massachusetts—Waltham  
(617) 890-8484  
Michigan—Troy (313) 583-9242  
Minnesota—Edina (612) 941-5280  
New Jersey—Somerset  
(201) 469-6008  
New York—Rochester  
(716) 461-4000  
Westbury (516) 334-7474  
Ohio—Beachwood  
(216) 464-2970  
Texas—Austin (512) 837-2890  
Dallas (214) 661-5010  
Houston (713) 784-3600  
Canada—Mississauga, Ont.  
(416) 678-9050  
SEMICOMP CORP.  
California—Newport Beach  
(213) 971-5253 and  
(714) 833-3070  
STERLING ELECTRONICS:  
Arizona—Phoenix  
(602) 258-4531  
Louisiana—Metairie  
(504) 887-7610  
Massachusetts—Watertown  
(617) 926-9720  
New Jersey—Perth Amboy  
(201) 442-8000  
New Mexico—Albuquerque  
(505) 345-6601  
Texas—Dallas (214) 357-9131  
Houston (713) 627-9800  
Virginia—Richmond "Meridian"  
(804) 335-6521  
R. V. WEATHERFORD CO.  
Arizona—Phoenix (602) 272-7144  
California—Anaheim  
(714) 547-0891  
Glendale (213) 849-3451  
Palo Alto (415) 493-5373  
Pomona (714) 623-1261  
San Diego (714) 278-7400  
Colorado—Englewood  
(303) 761-5432  
New Mexico—Albuquerque  
(505) 842-0868

Texas—Dallas (214) 243-1571  
Houston (713) 688-7406  
Washington—Seattle  
(206) 243-6340

### REPRESENTATIVES

AMMON & RIZOS  
Oklahoma—Oklahoma City  
(405) 373-2748  
Texas—Dallas (214) 233-5591  
Texas—Houston (713) 781-6240  
BARNHILL FIVE:  
Colorado—Denver  
(303) 428-0222  
BENEKE & MCCAUL:  
Missouri—Grandview  
(816) 765-2998  
Missouri—St. Louis  
(314) 567-3399  
CANTEK REPRESENTATIVES,  
INC.:  
Ontario—Ottawa (613) 225-0363  
COULBOURN DEGREIF, INC.:  
Maryland—Baltimore  
(301) 247-4646  
HADDON ASSOCIATES:  
California—San Diego  
(714) 565-9445  
HECHT HENSCHEN &  
ASSOCIATES, INC.:  
Arizona—Phoenix (602) 275-4411  
LOWREY & ASSOCIATES:  
Michigan—Brighton  
(313) 227-7067  
NORTHWEST MARKETING  
ASSOCIATES:  
Washington—Bellevue  
(206) 455-5846  
PRECISION SALES COMPANY:  
New York—Syracuse  
(315) 458-2223  
REP. INC.:  
Alabama—Huntsville  
(205) 881-9270  
Georgia—Tucker (404) 938-4358

# You'll like what printer designers like about the 82900 logic stepper motor.

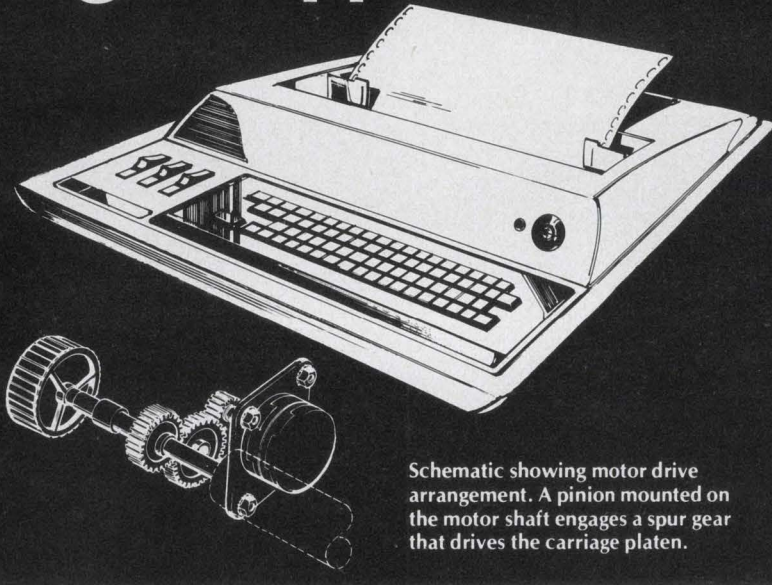

Schematic showing motor drive arrangement. A pinion mounted on the motor shaft engages a spur gear that drives the carriage platen.

## Take low price...top quality...compactness and 23 oz-in torque as starters.

The new 82900 stepper motor is built to do yeoman's service not only in impact and non-impact printers, but in small X-Y plotters, chart drives and computer peripherals. Yes, even medical instrumentation, where its reliability really pays off. Compact size, efficiency, low cost and 23 oz-in torque @ 200 PPS all combine to offer design advantages unobtainable in larger, bulkier and more expensive steppers.

A case in point. A high-speed impact terminal printer. Initially a mechanical linkage, actuated by a solenoid, was used to advance the carriage platen and paper automatically on command. This design proved to be somewhat cumbersome in making adjustments during assembly and required excessive downtime during servicing. After careful investigation, the 82900 stepper was adopted as a more vi-

able alternative. In addition to meeting the load requirements of the application, the 82900 proved capable of providing the necessary torque output, the required step angle and a minimum of 5000 hours operating time. Equally important, the motor met price parameters.

Consider the 82900 stepper in your own design. It's bidirectional. It has a nominal power rating of 12.38 w @ 5 vdc. And it is efficient, operating at lower than average temperatures. Standard construction provides 2-phase operation (requiring simplified drive circuitry) a 7.5° step angle and roller bearings. A 15° step angle, 4-phase operation or sleeve bearings in any combination desired can also be provided as options.

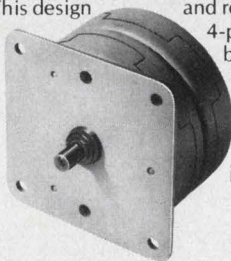

Send for  
information now!

A. W. HAYDON CO. PRODUCTS

**NORTH AMERICAN PHILIPS CONTROLS CORP.**

Cheshire, Conn. 06410 • (203) 272-0301

## ACROSS THE DESK

(continued from page 7)

### OSCAR was earlier

Your Bicentennial edition was well done. I would like to add that on Dec. 12, 1961, the OSCAR I satellite was orbited (Orbiting Satellite Carrying Amateur Radio), built entirely by radio amateurs. Is it then not the first privately owned satellite—contrary to a statement on p. 120 accompanying the picture of the Telstar satellite?

*Thomas E. Wulling*

1723 Terrace Dr.  
St. Paul, MN 55113

### Early terminology

On page 62 introducing your Bicentennial issue it is stated that Franklin "... was first to propose the theory that there are two kinds of electricity—positive and negative." Actually, this is incorrect, and Franklin's contribution of the one-electricity theory is duly noted later (p. 68) in Stanley Runyon's article.

However, earlier (p. 67), Runyon makes another small error. He writes, "It was Gilbert . . . who distinguished between electrics (conductors) and nonelectrics (insulators) . . ." The pre-19th century electricians referred to substances which could easily acquire a static charge by friction as "electrics" and those which could not (unless insulated) as "nonelectrics." Electrics today would be generally referred to as insulators and nonelectrics as conductors.

The polarity of electricity produced by rubbing electrics depended on their position in an empirical triboelectric series, ranging from glassy substances or "vitreous" (acquiring positive charge) to "resinous" like amber (acquiring negative charge), leading many of the ancients to adopt those terms for supposedly two types of electricity. Many of the phenomena associated with frictional electricity are still under investigation to this day.

*David Ecklein*

P.O. Box 203  
Newton, MA 02158

(continued on page 18)

**Who provides the industry's broadest line of electronic packaging hardware ... including Card Files?**

SAE does! In either kit form or fully assembled, VARIFILE's® exclusive snap-together construction lets you assemble a card file in just minutes—without tedious component stringing.

Designed on a modular basis, SAE card files contain only five basic parts: end plates; support bars; card guides; nylon snap locking tabs; and connector mounting feet. Also available is a complete line of accessories including identification tabs, card pullers, circuit card ejectors, circuit card ejector/retainers, printed circuit board edge connectors, and cable connector hoods.

Stanford Applied Engineering has the complete capability for the design and production of special card files in both New York and California that will accommodate mixed cards and connectors with such features as front/rear panels, divider plates, front panel hinges, chassis slides, etc. Your request for quotation will receive immediate attention!

Our new 128 page packaging handbook gives complete details, and also describes our entire line of electronic packaging and interconnection hardware.

® Stanford Applied Engineering, Inc.



**Stanford Applied Engineering, Inc.**

340 Martin Ave., Santa Clara, CA 95050  
(408) 243-9200 TWX 910-338-0132

CIRCLE NUMBER 8

# Your next digital logic analyzer.

Biomation's new 85I-D  
8-channel, 50 MHz logic analyzer.

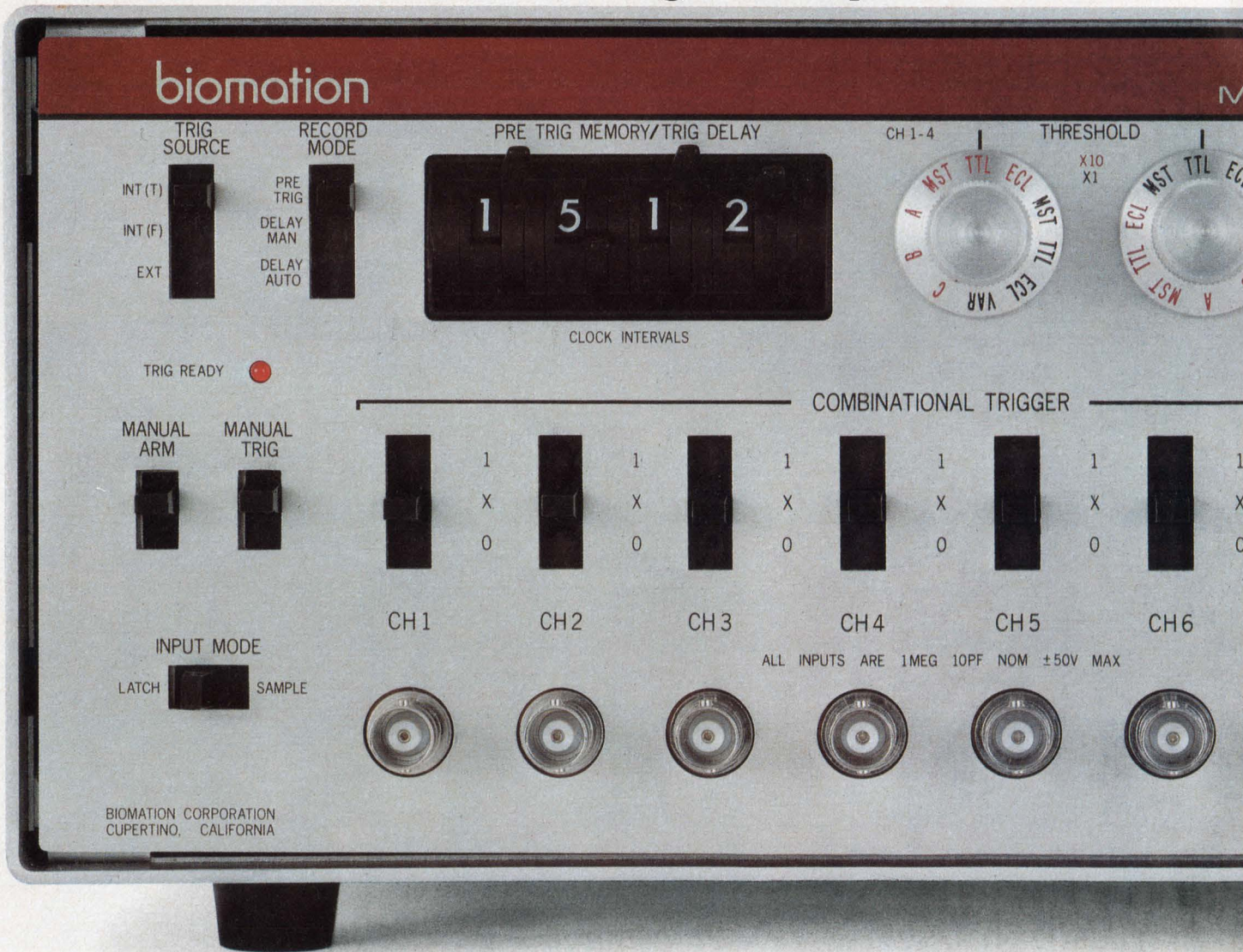

Digital logic analyzers are revolutionizing the solutions of design and trouble-shooting problems. Biomation, building on our early waveform recording technology, has created the tools you need for your fast new digital world. We offer the most complete line of logic analyzers anywhere. And our thousand-plus customers have helped us develop the most useful features for real-world problems of digital system design and test. Our new 851-D catches, records and displays 8 channels of high speed logic. It is the slickest handling, most cost-effective logic analyzer we've seen yet. But don't take our word for it. Check over the features for yourself.

- Ideal companion for your 2-trace portable scope
- Portable and self-contained
- 8 channel
- 50 MHz
- Digital delay for precise

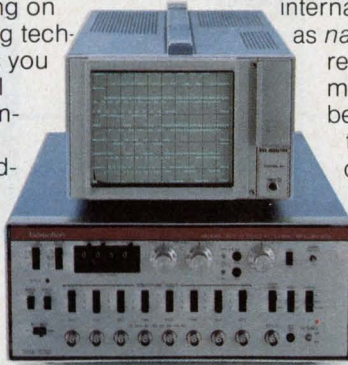

- trigger control
- Accepts synchronous clock input (0° or 180° phase)
- Provides internal clocking
- Catches glitches as narrow as 5 ns
- Pre-trigger recording
- 512 bit per channel memory
- Captures 512 words before, after, or around the trigger
- Expanded and mixed display
- Constant brightness expand to X20
- Combinational "true" trigger
- "Any-change" trigger
- Built-in delay (4 digit)
- Latch mode (catches single pulses)
- Adjustable threshold levels for channels 1-4 and 5-8
- Step-and-wait cursor control
- Steps through data one bit at a time
- Price: \$3575
- Delivery: 30 days A.R.O.



### What next?

If you want to see a demo, right now, of our new 851-D or any of our digital logic analyzers (we have both less expensive and more powerful models), pick up the phone and call (408) 255-9500. Ask for Roy Tottingham at ext. 851.D. Or circle the reader service number and we'll send data. Biomation, 10411 Bubb Road, Cupertino, CA 95014.

(851-D shown actual size.)

**biomation**  
Creating tools for technology

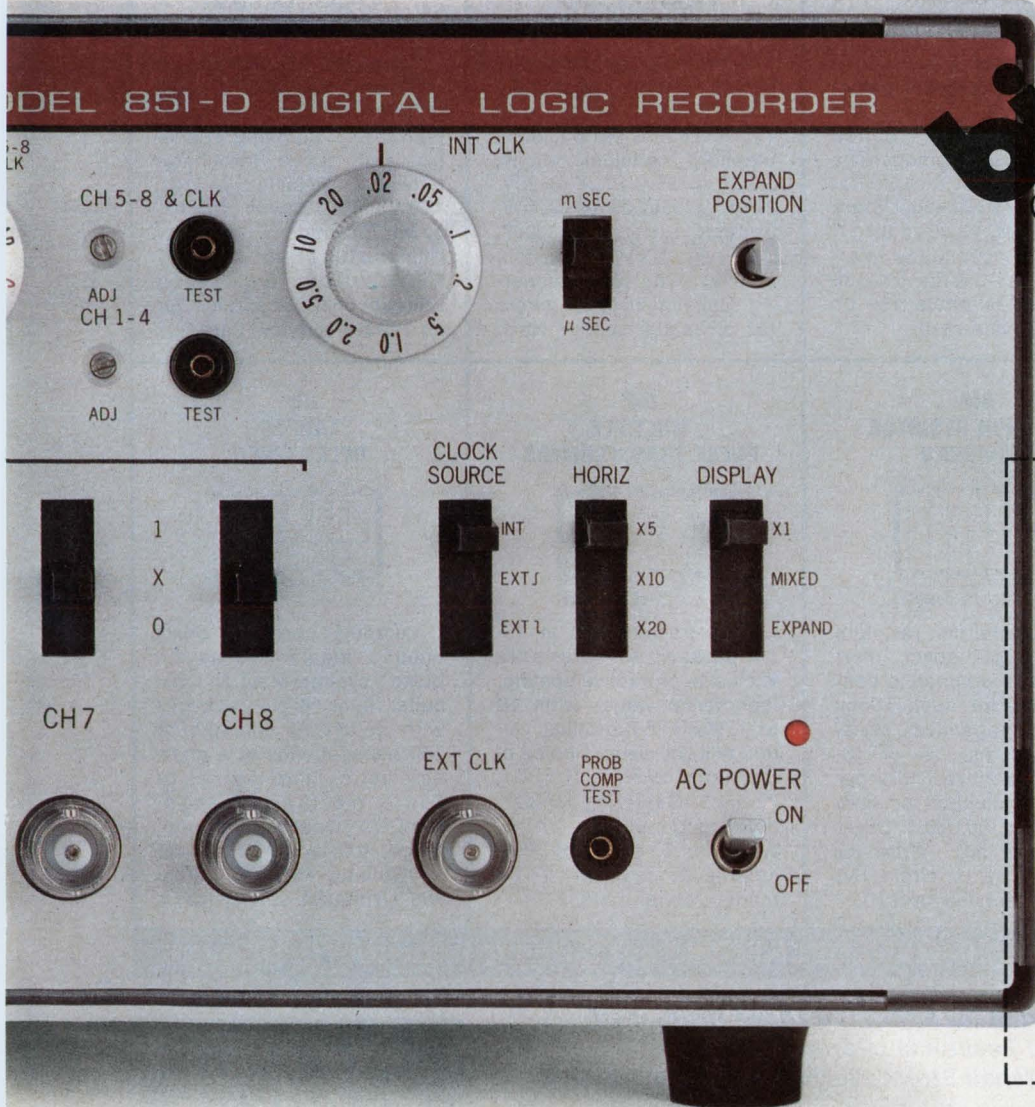

Sounds great, but I don't know what all of the features actually do. Please send more information.

Send information on your complete digital logic analyzer line.

\_\_\_\_\_

Name

\_\_\_\_\_

Title

\_\_\_\_\_

Company

\_\_\_\_\_

Street Address

\_\_\_\_\_

City State

\_\_\_\_\_

Zip

**Biomation**  
10411 Bubb Road, Cupertino, CA 95014, (408) 255-9500, TWX 910-338-0226

See us at ELECTRO '76 booth 2712-2716.

# Sprague puts more passive component families into dual in-line packages than any other manufacturer.

## Call Sprague First!

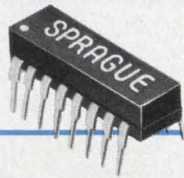

plus improved performance and compatibility with DIP microcircuits

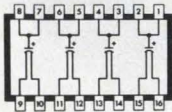

**DIP  
MULTIPLE  
TANTALUM CAPACITORS**

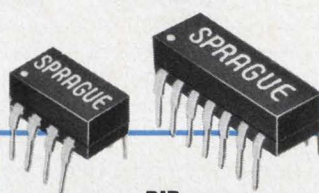

Solid-electrolyte tantalum capacitors with 2 or 4 sections per package. 8- or 16-pin configurations. Standard ratings are 6.8  $\mu\text{F}$  @ 35V, 15  $\mu\text{F}$  @ 20V, 22  $\mu\text{F}$  @ 15V, 33  $\mu\text{F}$  @ 10V. Capacitance tolerance,  $\pm 20\%$ . Operating temperature range,  $-55\text{C}$  to  $+85\text{C}$ . Write for Bulletin 3542 or circle 151 on reader service card.



**DIP  
MULTIPLE  
CERAMIC CAPACITORS**

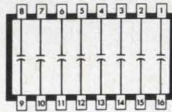

Monolithic<sup>®</sup> construction . . . alternate layers of ceramic dielectric material and metallic electrodes are fired into a solid homogenous block. 2, 4, 7, or 8 capacitor sections per package. Standard ratings, 18 pF to 0.1  $\mu\text{F}$  @ 100V. Capacitance tolerance,  $\pm 20\%$ . Write for Bulletin 6242 or circle 152 on reader service card.

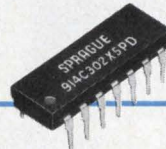

**DIP  
TANTALUM/CERAMIC  
CAPACITOR ASSEMBLIES**

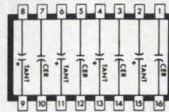

Solid tantalum and Monolithic<sup>®</sup> ceramic alternating isolated sections. Choice of 4 or 8 sections per package. Standard tantalum ratings, 6.8  $\mu\text{F}$  @ 35V, 15  $\mu\text{F}$  @ 20V, 22  $\mu\text{F}$  @ 15V, 33  $\mu\text{F}$  @ 10V. Ceramic ratings .01, .047, .1  $\mu\text{F}$  @ 100V. Cap. tol.,  $\pm 20\%$ . Write for Engineering Bulletin 6642 or circle 153 on reader service card.

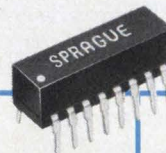

**DIP  
RESISTOR/CAPACITOR  
NETWORKS**

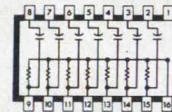

(1 of 3 designs)

Metanet<sup>®</sup> metal-film resistors and Monolithic<sup>®</sup> ceramic capacitors in bypassed pull-up, R-C coupling, speed-up, and active terminator networks. Resistor ratings, 100 to 6800  $\Omega$  with 125 mW power dissipation. Capacitor ratings, 100 pF to .01  $\mu\text{F}$  @ 100V. Write for Engineering Bulletin 6612 or circle 154 on reader service card.

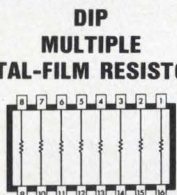

**DIP  
MULTIPLE  
METAL-FILM RESISTORS**

Noble metal film resistors encased in protective glass. Choice of 7 or 8 resistors per 14- or 16-pin package. Resistance values, 50  $\Omega$  to 100,000  $\Omega$ . Power dissipation, 125 mW. Standard resistance tolerance,  $\pm 5\%$ . Operating temperature range,  $-55\text{C}$  to  $+70\text{C}$ . Write for Bulletin 7042 or circle 155 on reader service card.

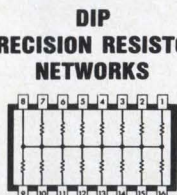

**DIP  
PRECISION RESISTOR  
NETWORKS**

(1 of 5 designs)

Noble metal film resistors in pull-up, pull-down, interfacing, and terminating configurations, for applications requiring repetitive resistance patterns. 14- or 16-pins. Up to 28 resistors per package. Individual resistors from 50 to 100,000  $\Omega$ . Dissipation, 125 mW. Write for Bulletin 7042 or circle 156 on reader service card.

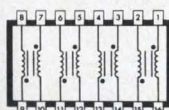

**DIP  
MULTIPLE  
PULSE TRANSFORMERS**

(1 of 2 designs)

Four transformers in 16-pin package. All cores have exclusive protective coating. Inductance values from 10 to 1000  $\mu\text{H}$ . ET product values of 5 volt- $\mu\text{sec}$ . Choice of four turns ratios . . . 1:1, 2:1, 3:1, 4:1. Operating temperature range, 0 C to  $+70\text{C}$ . Write for Engineering Bulletin 40400 or circle 157 on reader service card.

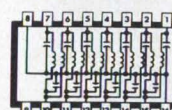

**DIP  
TAPPED  
DELAY LINES**

Lumped constant delay lines . . . ideal for timing and pulse synchronization circuits. 14- or 16-pin packages with delays of 50, 100, or 150 nanoseconds at a characteristic impedance of 100  $\Omega$ . Working voltage, 50 VDC. Operating temp. range, 0 C to  $+70\text{C}$ . Write for Bulletin 45004 or circle 158 on reader service card.

Popular Types Now Available OFF-THE-SHELF From Your Sprague Industrial Distributor.

For complete technical data, write for any of the above-mentioned Engineering Bulletins to: Technical Literature Service, Sprague Electric Company, 347 Marshall Street, North Adams, Mass. 01247.

**THE BROAD-LINE PRODUCER OF ELECTRONIC PARTS**





# CELCO makes "Above-Average" YOKES for "Above-Average" CRT Displays

Need a deflected CRT spot as small as 0.00065"?

The CELCO HDQ High-Resolution Deflectron for Satellite Photography Read-out was the choice of one of our customers for their "Above-Average" display requirements.

You can get performance like that with a CELCO YOKE optimized on your CRT for your "Above-Average" display. (measured with a CELCO CRT Spot Analyzer.)

Or YOUR "Above-Average" display may require fast Zero-approach settling time, as required in a Fingerprint Scanning job where CELCO HDN Deflectrons are specified to recover to 0.01% in 25 $\mu$ s.

Precision Linearity on the final film plane or work surface, in Integrated Circuit Mask-Generator Displays enables producers of LSI technology to make low-cost computers for all of us. CELCO Special Deflectrons and Linearity Correctors LC123 are being used by several equipment builders for their "Above-Average" displays.

For PEPR, a system for reading Bubble Chamber photographs, developed by a few individuals at MIT and refined and expanded by others at leading universities throughout the world, CELCO was asked to provide special Low Residual Yokes for their project. CELCO produced their HD Deflectron with special 0.003% residual, and GFJ irrrotational Focus Coils to help achieve the performance of these "Above-Average" displays. CELCO DAPP2N-7 Amplifiers drive the Dynamic Focus Coil; a CELCO DAPP2N-5 Amplifier was selected by another PEPR group to drive the CELCO B1700 Di-Quadrupole which produced the rotating high-resolution scanning line!

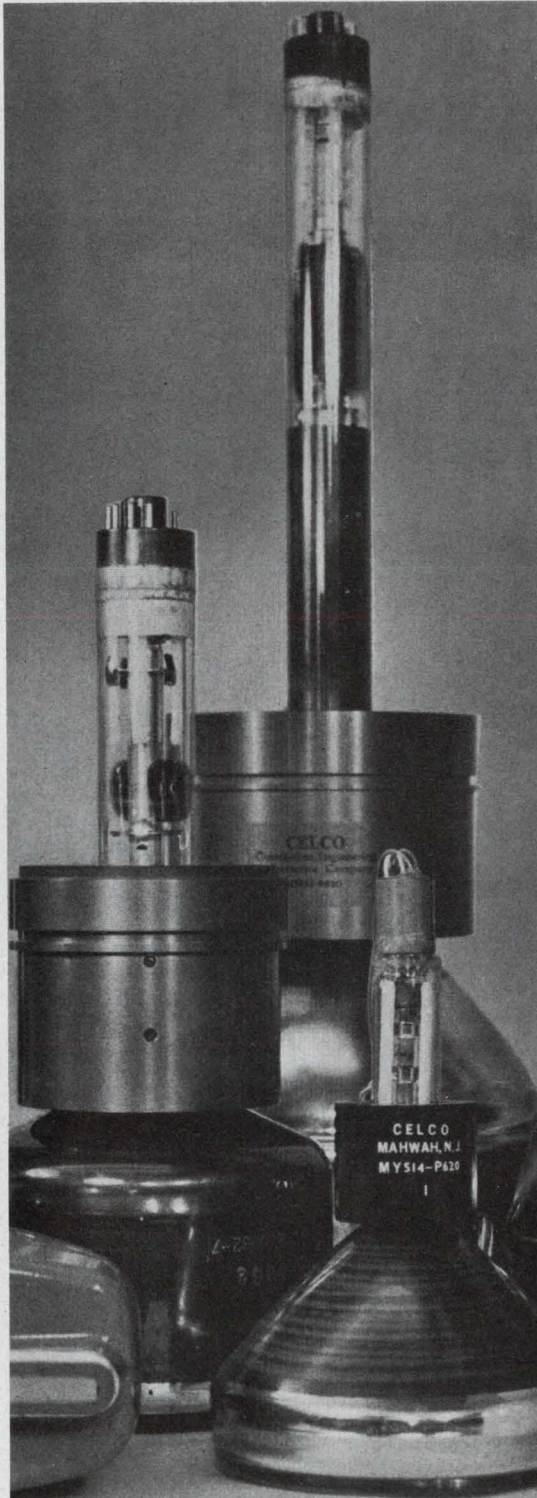

"Above-Average" Recording Storage Tube displays with 1 $\frac{1}{16}$ " neck scan converters and storage tubes need CELCO QY and QD Recording Storage Tube Yokes.

CELCO electronics and magnetics were integrated into a CELCO "DS" Special Display System for Oil Exploration and Data Reduction where "Above-Average" Linearity, Spot Growth, Zero-approach, Bandwidth, and Residual performances were required. Our customer decided to use CELCO's unique display experience to achieve his "Above-Average" display.

CELCO "Above-Average" deflection yokes, focus coils, beam-centering and aligners, astigmatic correctors, and pincushion correctors applied to your specific requirement will help you produce YOUR "Above-Average" Direct-View Display.

REMEMBER CELCO YOKES, whether you want to send a man to the moon, a probe to Jupiter or Mars, investigate chromosomes or trophoblast for cancer research, or build a large format scanner to generate typesetting masters, X-Ray enhancement, or data digitization.

- CELCO CRT Mounts, coil positioners, holders and magnetic shields will enable you to get everything together to achieve your "Above-Average" display.
- Write for CELCO YOKE BROCHURE and your FREE CELCO CRT Display Computer Slide Rule to compute the CELCO YOKE you need for your "Above-Average" CRT Display.

UPLAND CA 714-982-0215  
MAHWAH NJ 201-327-1123

(average is so . . . ho-hum to us.)

"Above-Average" YOKES for "Above-Average" CRT Displays.

CONSTANTINE ENGINEERING LABORATORIES COMPANY  
1150 E. Eighth Street, Upland, CA 91786

70 Constantine Drive, Mahwah, N J 07430

**Celco**

CIRCLE NUMBER 11

# Now There's A Better Choice

10 millivolt sensitivity, AGC inputs, bright LED displays, automatic ranging . . .

## DATA TECH

### DIGITAL FREQUENCY COUNTERS

- Model 111 . . . . . 120 MHz . . . . . 7 Digit
- Model 113 . . . . . 200 MHz . . . . . 8 Digit
- Model 115 . . . . . 520 MHz . . . . . 8 Digit
- Model 117 . . . . . 560 MHz . . . . . 9 Digit

Standard features include: Overload protection • Burst operation • Serial BCD • Options include: Battery operation • .01 Hz resolution in 1 sec. • BCD or IEEE bus • Much more.

Priced from **\$350**

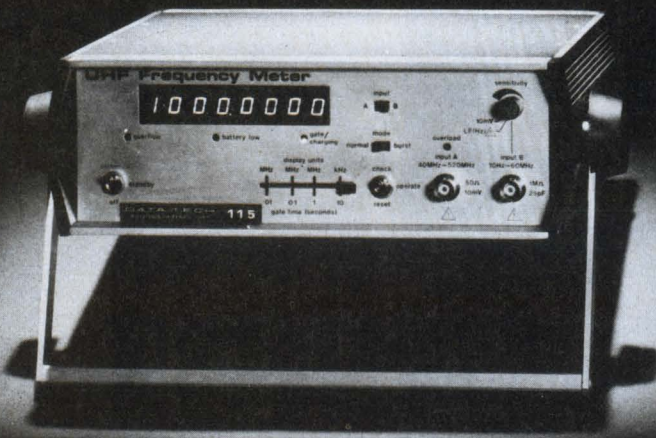

CIRCLE NUMBER 223

Measure frequency, single and multiple period, single and multiple ratio, single and dual channel time interval and t.i. average, and totalize . . .

## DATA TECH

### UNIVERSAL COUNTER TIMERS

- Model 101 . . . . . 50 MHz . . . . . 6 Digit
- Model 103 . . . . . 50 MHz . . . . . 7 Digit
- Model 105 . . . . . 200 MHz . . . . . 8 Digit

Standard features include: 10 mV sensitivity • Overload protected to 250V rms • Variable DC offset • Full complement of triggering controls including scope monitors • 100 psi TI average resolution • Auto bandwidth reduction on period • Contact or pulse measurement operation including fixed or variable delay • RFI shielded case •  $\pm 3 \times 10^{-7}$  month time base • BCD output • Many options.

Priced from **\$675**

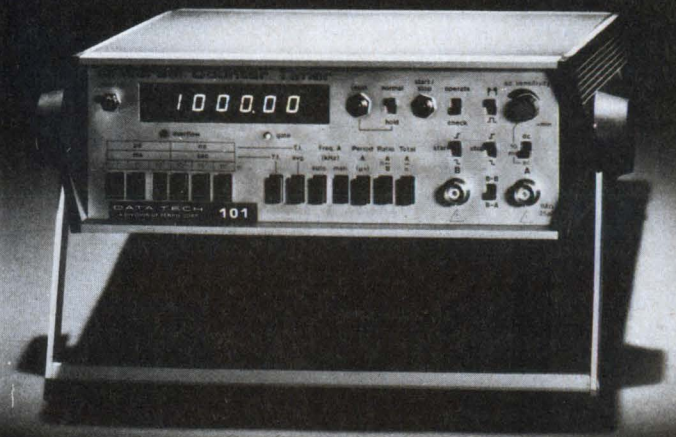

CIRCLE NUMBER 224

Completely automatic AM and FM modulation measurements to better than 3% accuracy.

## DATA TECH

### AUTOMATIC MODULATION METER

Model 209 . . . . . 1.5 GHz Frequency Range

- Standard features include: Eight FM and six AM ranges • Automatically adjusts input level • One-second automatic operation • Audio filter • Up to 100 KHz positive or negative peak FM deviation • Up to 100% AM modulation depth • Selection of peak or trough on AM measurements • I.F. and A.F. outputs • Compact and lightweight • Rugged metal case • Battery option and much more.

Priced from \$1225

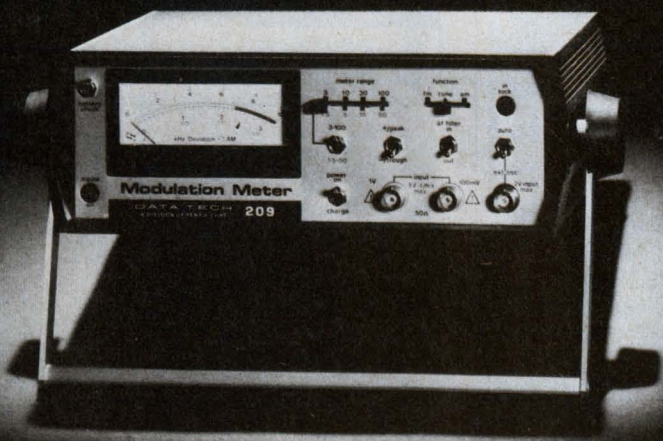

CIRCLE NUMBER 225

**Before you decide on another counter . . .  
get the full details on this all new family from**

## DATA TECH

*Data Tech (formerly Data Technology) introduces an all new family of frequency counters and universal counter/timers, plus an automatic modulation meter utilizing an entirely new concept in modulation measurement.*

*Now you have a better choice. Data Tech has a counter for every need. LSI technology significantly reduces the number of components so prices are remarkably low — and reliability is remarkably high! Each counter carries a two year full warranty.*

*Every conceivable function has been included in these precision instruments. All counters have a  $\pm 3 \times 10^{-7}$ /mo. crystal. Optional oven crystals, including  $\pm 3 \times 10^{-9}$ /day and  $\pm 1.5 \times 10^{-9}$ /mo., are available. All feature a rugged metal, RFI shielded case, and are immediately available from stock.*

*Before you decide on your next counter, get the full story from Data Tech. Circle the appropriate number for literature, or call for a demonstration.*



Hand-held  
Multimeters



Strip Chart  
Recorders



Digital  
Multimeters

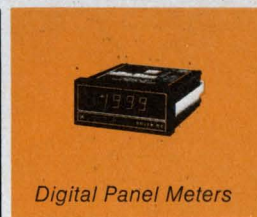

Digital Panel  
Meters

# DATA TECH

A Company to Count on

**DATA TECH**  
A DIVISION OF PENRIL CORP.

2700 Fairview, Santa Ana, CA 92704  
Phone 714 - 546-7160 • TWX 910-595-1570

# We have your High-Rel Hybrids!

At RAYTHEON/QUINCY. And if you want them produced in the most advanced designs and packages available, just tell us your specific needs. We'll custom design *your* high-rel hybrids just as we do for all our customers.

100% of our business is custom high-rel designs. 98% of that is military and medical electronics. So that means more than just high-rel. It means high performance and high technology, too. And both beam-lead and chip-and-wire packaging.

Of course we have your high-rel hybrids. At Raytheon/Quincy it's a custom. Ask K. Singh. At Raytheon Company, Industrial Components Operation, 465 Centre Street, Quincy, Mass. 02169. (617) 479-5300.

**RAYTHEON**

## ACROSS THE DESK

(continued from page 10)

### Filter article 'ideal'

Congratulations on your Feb. 16 issue! Not only did you give an exhilarating dissertation on two hundred years of progress, but the technical articles rated among the best I have ever seen.

The one article I found to be most interesting was Dr. Dela-grange's "ideal" translating filter. The technique is something I was until now unfamiliar with (and I am sure this is true of many others). Although I am not usually called upon to create such a filter, the realization of the possibility of such a filter has added a new dimension to my knowledge. This is what a technical journal is supposed to do!!

And you did it!—Keep it up.

*Rudy Schneider*  
Design Engineer

Carco Electronics  
195 Constitution Dr.  
Menlo Park, CA 94025

### Misplaced Caption Dept.



There's something about the service in our company cafeteria.

Sorry. That's Pieter Bruegel the Elder's "A Country Wedding," which hangs in the Kunsthistorisches Museum in Vienna.

### A LED lament

The News Scope item, "Color LEDs Gain in Brightness, Reliability," (ED No. 9, Apr. 26, 1976, p. 15) mistakenly said that the reliability of Monsanto's nitrogen-doped multi-colored LEDs has more than doubled in the last year. In reality, the reliability has been improved from 10 to 100 times.

# Analog Devices introduces less of a DPM.



When we designed our new line of second generation digital panel meters, we had a clear objective in mind.

Give our customers less of everything. Less of everything they don't want in DPMs, and more of what they need.

#### Less confusion.

Like less confusion finding the exact DPM they require. With six different second generation DPMs (three +5VDC logic-powered and three AC line-powered) we have the biggest selection available. And each of them benefits from advanced MOS/LSI circuitry, 3½, 4½ or 4¾ digit large LED displays, a full week of failure-free, power cycled burn-in, lower power consumption and lower cost.

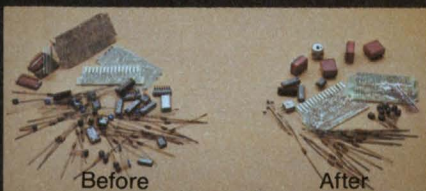

#### Less components.

But let's not talk in generalities. Let's talk specific Analog Devices DPMs where less is a plus. Take our 3½ digit 5VDC

Model AD2021 for example. Through the use of MOS/LSI circuitry, we've been able to cut the number of components in it by 42%. And in doing so, chopped power consumption by 42%. Decreased the number of interconnections adding to reliability. Reduced its size to 3"W x 1.8"H x 1.25"D. And dropped its weight to 4 ounces. That's why logic power is your logical choice for compact instrumentation. Our line-powered version, AD2016, offers similar advantages, in its industry-accepted AC-powered package.

#### Less difficult to read.

Digital panel meters should be easy to read. Get a glimpse of our logic-powered 4¾ digit AD2028 and line-powered AD2025. Like our other second generation Analog Devices DPMs, they have displays featuring big, high-intensity "light-pipe" LEDs almost twice the size of earlier ones.

#### Less cost.

With so much that's improved, you'd expect to pay more for our latest DPMs. Surprisingly, that's not the case. Our logic-powered 4½ digit Model AD2027 and line-powered Model AD2024, for instance, are priced 40% lower than their first generation predecessors.

#### Less is more.

When is less more? When you specify Analog Devices new line of second generation digital panel meters. The real company for precision measurement and control. For complete facts, get the Designers Guide to DPMs. Analog Devices, P.O. Box 280, Norwood, Mass. 02062.



The real DPM company.

East Coast: (617) 329-4700, Midwest: (312) 894-3300, West Coast: (213) 595-1783, Texas: (214) 231-5094, Belgium: 03 38 27 07, Denmark: 97 95 99, England: 01/94 10 46 6, France: 686-77 60, Germany: 089/53 03 19, Japan: 03/26 36 82 6, Netherlands: 076-122555 and representatives around the world.



You can turn to AMP  
for thumbwheel switches that'll  
snap, plug or wire in place.

Or you can go on soldering.



Maybe you're used to connecting or terminating your thumbwheel switches the traditional way—with solder.

Fine.

You can solder an AMP switch, if you want to.

But if you're more inclined to break tradition in the interest of saving time and money, then innovate with AMP: take your choice of wrap-type, snap-in, posted or plug-in interconnections plus a variety of thumbwheel switches (including .500" and .350" wide), message wheel, enclosed and sealed configurations, and BCD and BCO codes.

When you turn to AMP for thumbwheels—or any other type of switch—you can expect the type of backup for which AMP is famous.

With professionally concerned sales engineers who want to know about your switching problems. And help you solve them.

And twelve district sales offices across the country—to help them help you.

After all, if you're going to innovate, it pays to have a stable company backing your design.

Why not take time out from soldering. Ask for our thumbwheel switch catalog. Today.

Call Customer Service at (717) 564-0100, or write: AMP Incorporated, Harrisburg, Pa. 17105.

SEE US AT  
BARCELONA AUTOMAT SHOW

**AMP**  
INCORPORATED

CIRCLE NUMBER 15

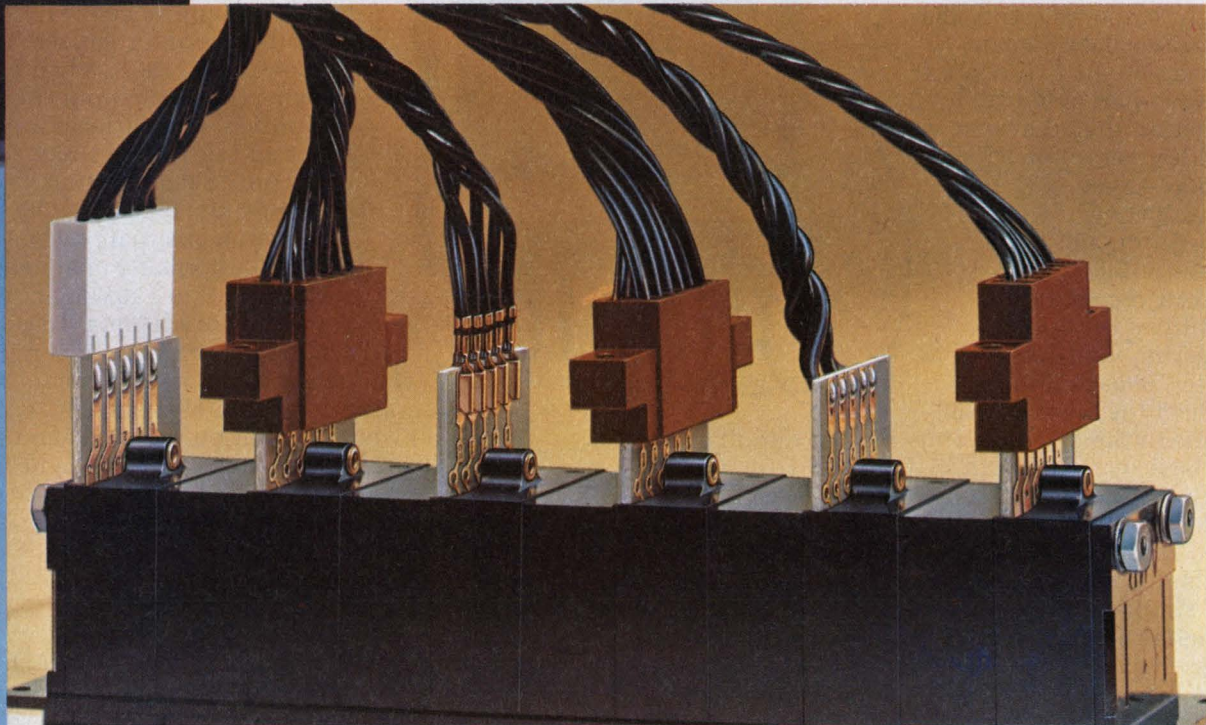

AMP is a trademark of AMP Incorporated.

# Let's talk about ending digital display jitters.

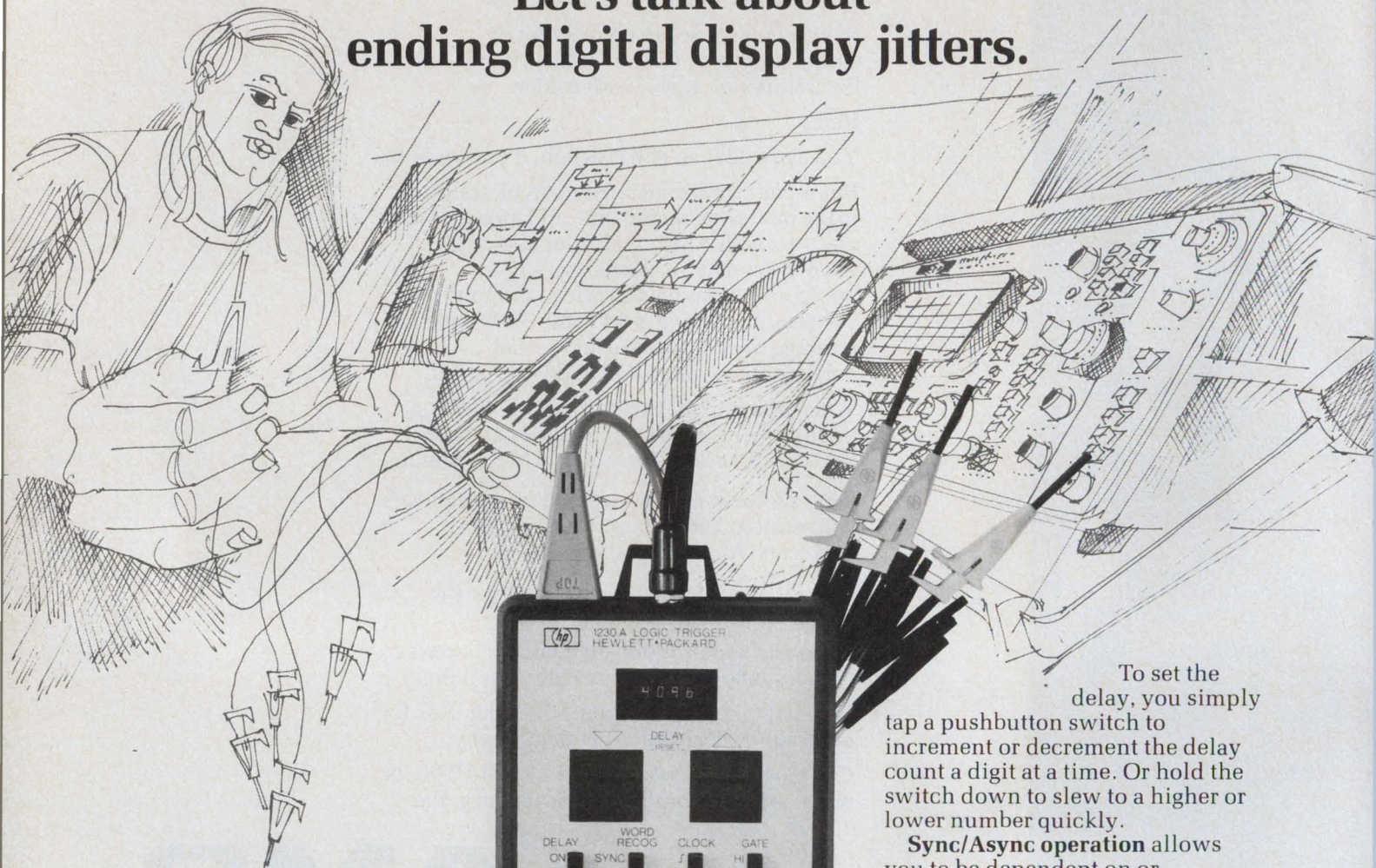

**Here's the key.** HP's new 8-bit 1230A Logic Trigger—a handy scope accessory that simplifies data-domain measurements two ways. It gives you an easy way to trigger on digital events. And it gives you a stable display—even with long delays between word recognition and the trigger point.

**Word recognition** simplifies the task of triggering your scope from digital data. Simply connect the eight parallel inputs to the desired points in your circuit and set the level switches to HI, LO, or OFF (don't care). When the operating logic states agree with the selected input levels, the unit indicates word recognition. And, after the preset delay, sends the trigger signal to your scope. It's just that simple.

**Digital delay** is the key to stable traces. Trigger delay is based on clock pulses—not time. So you can window on an event occurring up to 9999 clock pulses from the point of word recognition and obtain a jitter-free trace every time.

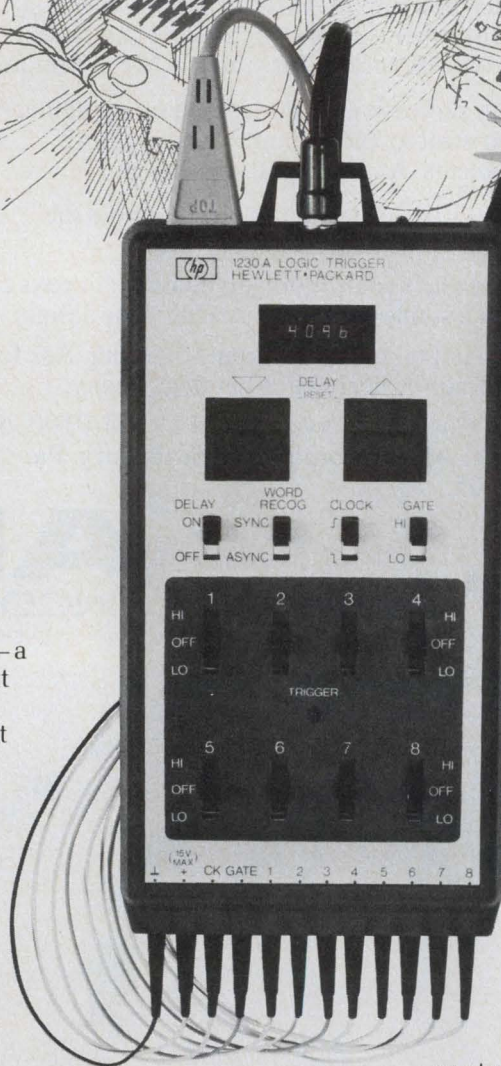

To set the delay, you simply tap a pushbutton switch to increment or decrement the delay count a digit at a time. Or hold the switch down to slew to a higher or lower number quickly.

**Sync/Async operation** allows you to be dependent on or independent of clock pulses. A gate input provides a qualifier for word recognition, or, if you need additional parallel inputs, the gate input can be the ninth bit for the word recognizer.

You get the 1230A, a handy carrying case with input cables and probes, scope trigger input cable, and a carrying strap... all for only \$495\*. Optional accessory kit (15268A, \$100\*) includes an external power supply (the 1230A normally operates from your own +5V to +15V logic supply) and a variety of adapters. To get a logic trigger for your scope, and simplify your data domain measurements, just contact your local HP field engineer.

For 4-bit word recognition, ask him about the models 10250A (TTL), 10251A (MOS), and 10252A (ECL) priced at \$95\* each. If you need 16-bit serial or parallel word recognition, he'll tell you about the 1620A priced at \$1,750\*.

\*Domestic U.S.A. prices only.

HEWLETT  PACKARD

Sales and service from 172 offices in 65 countries.  
1501 Page Mill Road, Palo Alto, California 94304





# Year after year GR is voted #1 in RLC Bridges

Whenever a product-preference study is conducted, GR is always voted #1 for RLC bridges. And by a wide margin. Perhaps it is because we've been in the business for so long (over 50 years at making bridges). Or maybe our reputation for building in high quality is a factor. Or our engineering savvy. Or whatever. We think it is all these things plus a lot more that keep us in the top spot as a supplier of bridges and RLC standards.

Today, you'll find GR bridges and/or standards in laboratories, at QC and incoming-inspection stations, and in production environments throughout the world wherever R, L, or C measurements are made.

For complete information on GR's broad line of manual, automatic, and precision bridges, as well as RLC standards, request copies of our 40-page *Impedance Measuring Instruments* brochure plus the 36-page brochure on *Impedance Standards and Precision Bridges*.

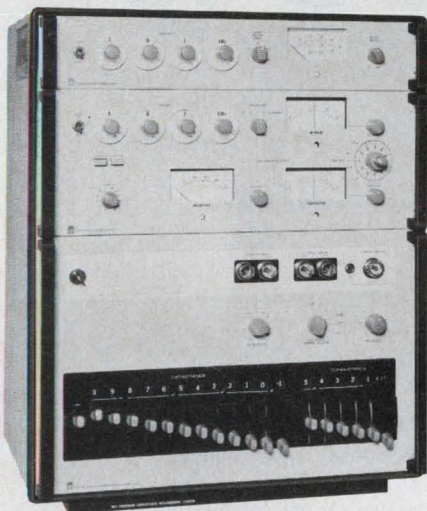

## Precision Bridges

This line of products typically find their greatest use in standards labs, where scientists and engineers push the state-of-the-art in measuring electrical parameters. The 1621 Precision Capacitance-Measurement System shown here is capable of measuring capacitance in increments as small as 0.1 attofarads ( $10^{-21}$  pF).

## RLC Standards

No bridge is complete without a standard and the GR 1408 Reference Standard Capacitor shown here is just one of dozens available from GR.

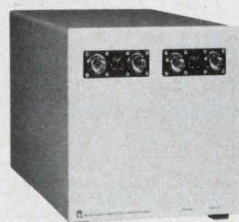

## Manual Bridges

Shown here is the 1650-B Impedance Bridge, probably the most popular bridge in use today.



## Automatic Bridges

GR introduced its first automatic bridge at the WESCON show in 1964. Several other models have followed since, with the 1686 Digital Capacitance Meter shown here being the latest addition to the product line.



**GenRad**

300 BAKER AVENUE, CONCORD, MASSACHUSETTS 01742

ATLANTA 404 394-5380 • BOSTON 617 646-0550 • CHICAGO 312 992-0800 • DALLAS 214 234-3357  
DAYTON 513 294-1500 • LOS ANGELES 714 540-9830 • NEW YORK (N.Y.) 212 964-2722, (N.J.) 201 791-8990  
SAN FRANCISCO 408 985-0662 • WASHINGTON, DC 301 948-7071  
TORONTO 416 252-3395 • ZURICH (01) 55 24 20

CIRCLE NUMBER 17

# The 100 NSEC fully static 4K RAM is here now

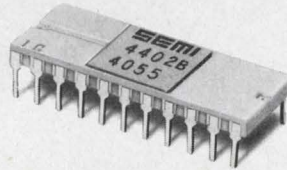

100 nsec. access time. The SEMI 4402B is the fastest 4K RAM available today. Now you can build a 150 nsec. access memory system with 4K chip density, and minimum worry about soft bit errors.

Fully static. You can design systems without losing valuable time for refresh, or wasting board space with costly refresh circuitry. The simpler timing requirements mean an easy interface design.

Data protection. Brownout protection or battery backup features can be added to your memory, since the 4402B retains data at low voltage and power levels.

The SEMI 4402B. at 100 nsec. access and 300 nsec. cycle time is available now for immediate delivery. Contact your local EMM SEMI sales office, representative or distributor today.

**EMM SEMI**

A subsidiary of Electronic Memories & Magnetics Corp. • 3883 North 28th Avenue, Phoenix, Arizona 85017  
(602) 263-0202

EMM OFFICES: WESTERN REGION, Regional Office, San Francisco (408) 247-9711, Los Angeles Area (213) 644-9881, Orange County Area (714) 639-5811; EASTERN REGION, Regional Office, Boston (617) 861-9650, Chicago Area (312) 297-7090, New York Area (516) 423-5800, Cleveland Area (216) 842-8920; INTERNATIONAL OFFICES, European Headquarters, United Kingdom (01) 751-1213, West Germany (089) 714.30.40.

REPRESENTATIVES: Gentry Associates, Orlando (305) 894-4401, Huntsville (205) 534-9771, Burlington, N.C. (919) 227-3639. In Canada: Cantec, Toronto (416) 457-4455, Montreal (514) 620-3121, Ottawa (613) 225-0363. In Sweden: Svensk Teleindustri, QB-890435. In Great Britain/Ireland, MEMAC Whitchurch (029 664) 366/7/8. In Netherlands/Belgium, Famatra, Benelux 076-133457. In Norway, Henaco A/S (02) 15 75 50. In Japan, Nissho Electronics (03) 544-8396.

# A new and better way to get crisp, clear facsimile-type records of sonar, radar, or IR thermography.

## Honeywell's new 1856A linescan recorder.

The Model 1856A from Honeywell reflects a real advancement in fiber-optic CRT technology. Offers high resolution recordings (greater than 100 line pairs/inch), a broad gray scale capability, intensity modulation to 8 MHz, variable sweep range of  $2\mu\text{sec}$  to 1 sec/cm and 1 cm pk-pk vertical recordings from dc to 75 kHz, with a choice of recording media.

In addition to print-out papers, the 1856A offers even greater flexibility through your choice of two accessory magazine assemblies. The Model 1218A, light-tight and self-contained, permits the use of recording papers and films for wet chemical photoprocessing to obtain an even

greater resolution, and optimum reproducibility. When high writing and record speeds are not required, the Model 1219 Processor provides dry-processed high contrast or gray scale recordings on paper or film.

For complete technical specifications, call or write Bob Shipman, Honeywell Test Instruments Division, P.O. Box 5227, Denver, Colorado 80217. (303) 771-4700.

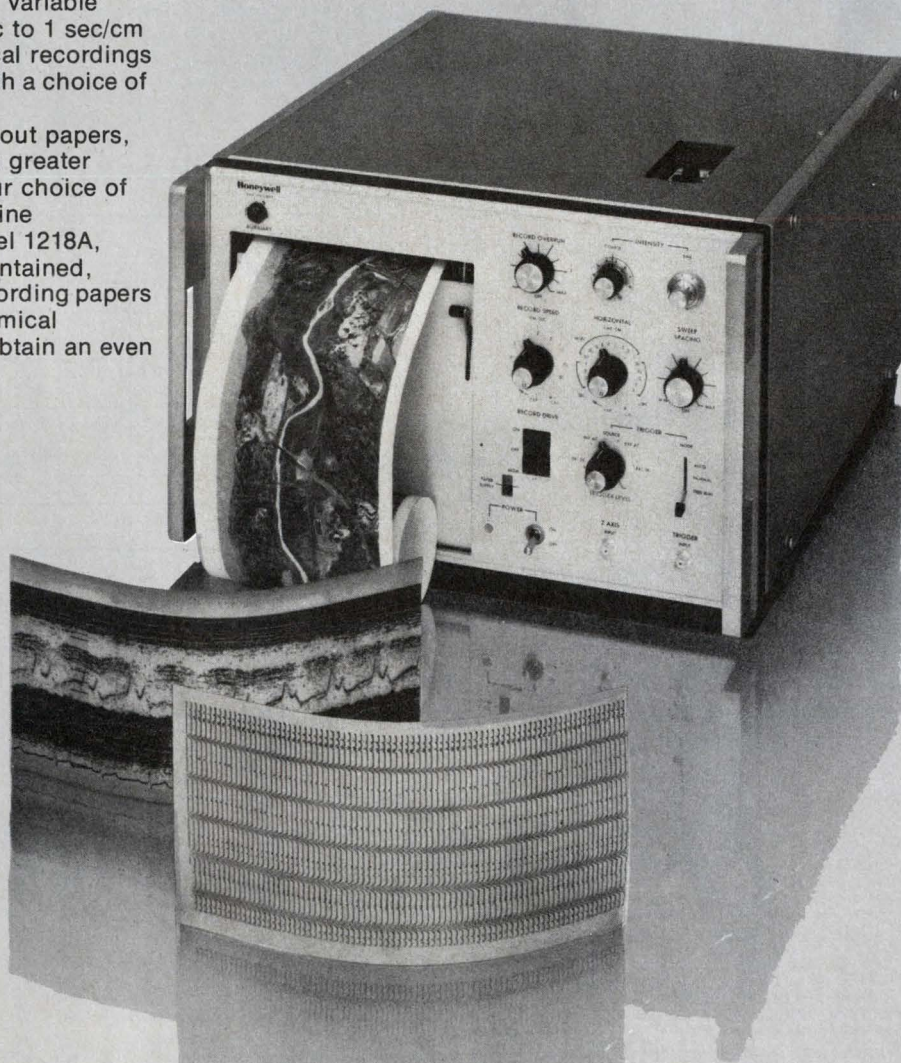

# Honeywell

FOR LITERATURE CIRCLE #19

# ARE YOU GOING TO THE HARRIS FAMILY PROM?

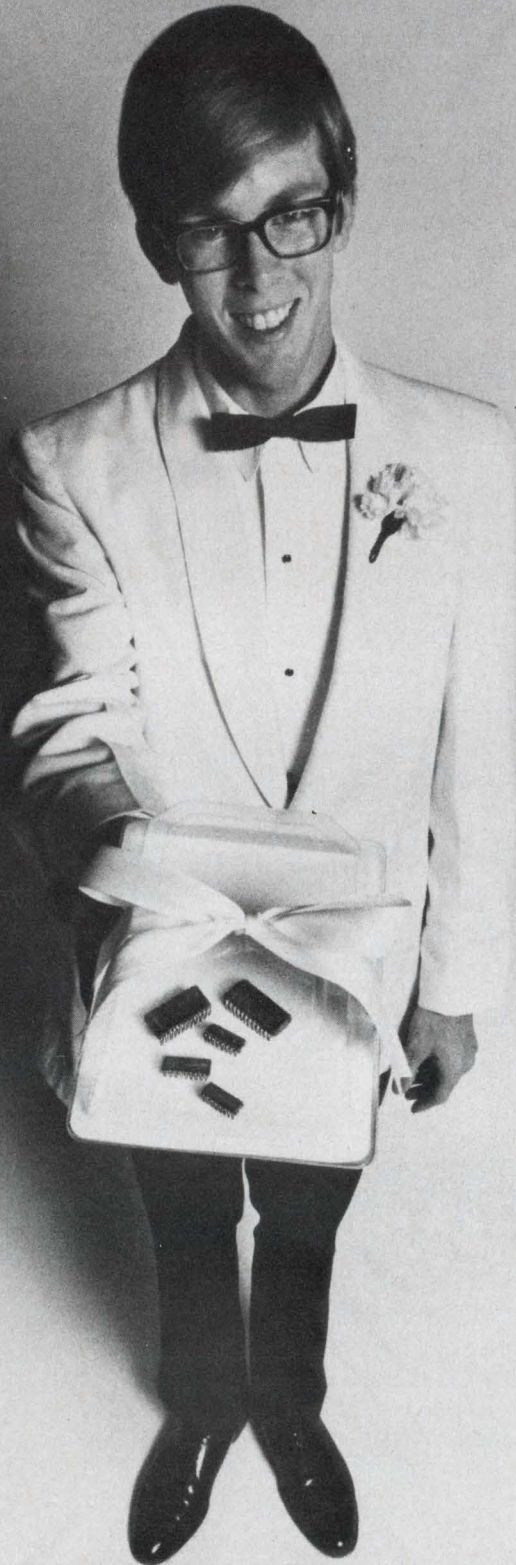

Every day, more and more companies are making plans to.

Because since the introduction of the new Harris GENERIC PROM family, stand alone PROM designs are steadily losing their popularity.

Now the diverse requirements for density, modularity, and performance within a system can be totally satisfied by this one generic family.

Once you're at the Harris PROM, you'll enjoy many of the advantages of this GENERIC concept.

For instance, each device within a series features compatible DC electrical specifications plus common programming requirements, permitting easy use of other family elements.

The Harris GENERIC PROMs also feature fast programming speeds (guaranteed 1 ms per bit, max.). Equivalent I/O characteristics for easy upgrading. Fast access time, guaranteed to meet worst case  $N^2$  sequencing over temperature and voltage. And improved testability.

Right now, our entire family of GENERIC PROMs is in volume production. With 100 up pricing below 1/2 cent per bit on the popular 1K, 2K, and 4K configurations.

So make a date to come to the Harris family GENERIC PROM.

Just about everyone will be there.

For details, see your Harris distributor or representative.

Device #	No. of Bits	Organi- zation	No. of Pins	Max. Access Time*		Price 100 up	
				Com	Mil	Com	Mil
HM-7602 (open coll)	256	32x8	16	40ns	50ns	\$2.95	\$5.95
HM-7603 (three state)	256	32x8	16	40ns	50ns	\$2.95	\$5.95
HM-7610 (open coll)	1024	256x4	16	60ns	75ns	\$4.95	\$9.95
HM-7611 (three state)	1024	256x4	16	60ns	75ns	\$4.95	\$9.95
HM-7620 (open coll)	2048	512x4	16	70ns	85ns	\$9.95	\$19.95
HM-7621 (three state)	2048	512x4	16	70ns	85ns	\$9.95	\$19.95
HM-7640 (open coll)	4096	512x8	24	70ns	85ns	\$19.95	\$39.95
HM-7641 (three state)	4096	512x8	24	70ns	85ns	\$19.95	\$39.95
HM-7642 (open coll)	4096	1024x4	18	70ns	85ns	\$19.95	\$39.95
HM-7643 (three state)	4096	1024x4	18	70ns	85ns	\$19.95	\$39.95
HM-7644 (active pullup)	4096	1024x4	16	70ns	85ns	\$19.95	\$39.95

\* Access time guaranteed over full temperature and voltage range Industrial ( $T_A = 0^\circ\text{C}$  to  $70^\circ\text{C}$ ,  $V_{CC} \pm 5\%$ )

Military ( $T_A = 55^\circ\text{C}$  to  $125^\circ\text{C}$ ,  $V_{CC} \pm 10\%$ )



**HARRIS**  
**SEMICONDUCTOR**  
A DIVISION OF HARRIS CORPORATION

P.O. Box 883, Melbourne, Florida 32901 (305) 724-7412

**WHERE TO BUY THEM: OEM SALES OFFICES: CALIFORNIA:** Long Beach, (213) 426-7687; Palo Alto, (415) 964-6443 **FLORIDA:** Melbourne, (305) 724-7430 **ILLINOIS:** Hinsdale, (312) 325-4242 **MASSACHUSETTS:** Wellesley Hills, (617) 237-5430 **MINNESOTA:** Minneapolis, (612) 835-2505 **NEW YORK:** Endwell, (607) 754-5464, Melville, L.I., (516) 249-4500 **OHIO:** Dayton, (513) 226-0636 **PENNSYLVANIA:** Wayne, (215) 687-6680 **TEXAS:** Richardson, (214) 231-9031.

**SALES REPRESENTATIVES: ARIZONA:** Scottsdale, (602) 948-5590 **CALIFORNIA:** Los Angeles, (213) 870-9191; Mountain View, (415) 961-8121; San Diego, (714) 565-9444 **COLORADO:** Denver, (303) 773-0666 **CONNECTICUT:** Trumbull, (203) 261-2183 **FLORIDA:** Boca Raton, (305) 395-6108, Oviedo, (305) 365-3283; Tampa, (813) 933-3183 **ILLINOIS:** Elk Grove Village, (312) 640-1850 **KANSAS:** Wichita, (316) 943-6221 **MARYLAND:** Randallstown, (301) 922-1248 **MASSACHUSETTS:** Burlington, (617) 273-1313 **MICHIGAN:** Farmington, (313) 476-2446 **MISSOURI:** Hazelwood, (314) 731-5799; Kansas City, (816) 761-6543 **NEW JERSEY:** Keasbey, (516) 567-5900 **NEW MEXICO:** Albuquerque, (505) 265-5655 **NEW YORK:** Albany, (518) 489-7408 or 4777; Huntington Station, (516) 567-5900 **NORTH CAROLINA:** Raleigh, (919) 828-0575 **OHIO:** Cleveland, (216) 831-8292; Dayton, (513) 890-2150 **OREGON:** Beaverton, (503) 643-1644 **PENNSYLVANIA:** Allison Park, (412) 487-4300; King of Prussia, (215) 265-0634 **TENNESSEE:** Shelbyville, (615) 684-4544 **TEXAS:** Dallas, (214) 691-4592; Houston, (713) 661-3007 **VIRGINIA:** Falls Church, (703) 534-1673; Lynchburg, (804) 237-4740 **WASHINGTON:** Bellevue, (206) 454-0300 **CANADA:** Montreal, (514) 626-6723; Ottawa, (613) 749-0740; Toronto, (416) 676-1042.

**NATIONAL DISTRIBUTORS:** Hamilton/Avnet; The Harvey Group, Inc.; Schwebel Electronics; R.V. Weatherford Company.

MAY 10, 1976

## Graphic display to compete with costly refresh systems

For the first time, an interactive graphics system combines the two leading techniques of computer-controlled displays—storage tube and refresh.

Designed by Tektronix, the industry leader in computer-graphics sales, the 4081 uses two computers to offer the memory and detailed pictures possible with a direct-view storage tube (DVST) and, simultaneously, the animation and selective updating capabilities of a refreshed system.

The Tektronix system costs \$27,000 and includes a 19-in. display, a tape-cartridge drive, an ASCII keyboard, 12 function keys, a joystick and an RS0323-C communications interface.

In the past, a user of graphics bought an expensive (up to \$200,000) refreshed system if he needed selective erase or picture dynamics: motion, three-dimensional perspective, complex rotations and translations. Other features, such as zoom and scaling, also require a refreshed system.

If the price of refresh was too steep, or such elaborate performance, wasn't needed, the user could select a graphics systems based on a DVST display. Since the tube itself captures and holds the display, no refresh is necessary, and expensive internal memories and other circuitry can be eliminated.

Although the price of storage-tube systems is accordingly slashed—to \$10,000, or less—so is the performance. Thus a user must give up the important capability of selective erase. If one character in a line has to be changed—to enter new information or because of a mistake in data entry—the entire picture must be updated.

Updating takes up both the user's and the computer's valuable time. If the graphics system is remotely operated, then fast opera-

tion is also essential to keeping down communication charges. And because the tube stores the picture, animation isn't possible.

The 4081 overcomes these limitations by use of two internal computers: a general-purpose processor from Interdata and a special display processor or controller.

With two "brains" teaming up to control the picture, refresh graphics can be written at a rate of 54,000 vector-cm/s, and storage graphics at 13,500 vector-cm/s.

However, there are some limitations to the 4081's refresh characteristics. Dynamics are limited to a band, or portion, of the display. The band can appear anywhere on the screen, at the user's discretion. In terms of the number of display vectors, or the number of points, the picture is flicker free for up to 1600 vector-cm or 800 vectors, whichever limit comes first.

A number of standard and optional software packages allow stand-alone operation or connection to a host computer.

CIRCLE NO. 319

## Thin films raise solar collector efficiency

Two thin films developed to improve solar-energy-collector efficiency may also be useful in the temperature control of electronic components or packages. The films were produced by vapor deposition at MIT's Lincoln Laboratory, Lexington, MA.

One type, a black-gold film about 0.15- $\mu$ m thick, is deposited on flat-plate collectors to act as a heat trap. It is a combination of 75% magnesium oxide and 25% gold, by volume. When the film is applied to a metal surface it allows radiant energy such as sunlight to pass through, but prevents infrared en-

ergy from being emitted.

The second type of thermal film produced by the Lincoln researchers is a transparent, tri-layer structure that acts as a transparent "heat mirror," or radiation insulator. The film is composed of a transparent silver coating that is a sub-micrometer thick, sandwiched between thin films, of titanium-dioxide. The layers are deposited sequentially on one side of a glass plate or panel that is used as a cover for energy-absorbing cells.

In experiments, 85% of the visible energy has been demonstrated to pass through the panel, while radiant heat generated internally has been reflected and contained within the cell with an efficiency greater than 90%.

Dr. John Fan, a member of the development team for the films, says the heat mirror can be reversed to maintain cool temperature inside a cell or cavity by preventing external heat from entering.

## HP adopts TI's 4-k, 18-pin RAM

The use of newer, high-density, 18-pin 4-k RAMs was given a boost with Hewlett-Packard's recent multi-million-dollar order for Texas Instruments' 4-k dynamic devices. These 18-pin RAMs will be incorporated into memory modules for new 21MX HP minicomputers, according to an HP spokesman.

More than a quarter million of the earlier—and twice as large—4-k, 22-pin RAMs were used in the 21MX machines, beginning in 1974.

HP's adoption of the 18-pin version of the 4-k RAM tilts the scales in favor of industry-wide use of the device. There are presently five U.S.-made versions of the 4-k unit. Two have 22 pins, one has 16 pins and two have 18 pins. Japanese suppliers provide two other pin-outs.

Because of the small size of TI's 18-pin unit, the HP memory modules will have 16-k words instead of the 8-k words of the 22-pin-version modules.

Memory with the new product is priced 30% less than with the earlier modules. The 21MX systems with the new memory typically

cost 12 to 24% less than those using the earlier 8-k modules.

"HP's decision to design the TI 18-pin configuration into its 21MX minicomputer is an important benefit for us," said Charles Clough, of TI. "The market for high-density RAMs is a young and growing one."

"The new 18-pin RAMs, while improving compactness and reducing costs are demonstrating a reliability equal to that achieved by the 22-pin RAMs as well as a greater reliability than that of magnetic-core memory systems of equivalent capacity," says HP's William Senske.

"Selection of the TI part was preceded by extensive qualification tests involving over 10,000 parts, through several million hours of accumulated reliability and life testing.

"In addition to our agreement with TI, we are evaluating 18-pin parts from RCA and Advanced Micro Devices for second-source purposes," Senske says.

"Building minicomputers that deliver the reliability promised by 4-k RAMs has turned out to be tougher than anyone expected," reports Richard Anderson, general manager of the HP Data Systems Division in Cupertino, CA, where the 21MX computers are produced.

"In a rush to get 4-k RAMs to the marketplace, many of the semiconductor vendors experienced process problems and included serious design flaws in their parts.

"Some of the major problems solved includes improved temperature-sensitive refresh requirements, oxide-layer breakdown under elevated temperature and voltage stress, and crosstalk internal to the chip that led to pattern sensitivities when the chips were imbedded in memory systems."

## High voltage encapsulant triples voltage ratings

The voltage rating of several transformers has been more than tripled compared with materials previously thought of as best, by use of a long-polymer modified-polyurethane encapsulant.

"The voltage rating primarily increases because the encapsulant

flows readily into all voids. The polymer cures into a flexible material, without air gaps, that is highly resistant to corona breakdown," says Lynn Whitaker of Hughes Aircraft, Culver City, CA.

"With the new material, we can go to 300 to 500 V/mm with no problem. It also allows transformer size to be reduced by 3 to 6 times that of earlier epoxy-filled designs," he continues.

The material is stable from -65 to +95 C and has a dielectric constant of about 3.0. The dissipation factor is 0.02. Hughes sometimes fills the material with aluminum oxide, or with glass bubbles, to tailor its characteristics. The nominal specific gravity of the material when filled with aluminum oxide is 1.5; when filled with glass bubbles it is 0.8.

It has been used in space applications with little or no outgassing.

The material, still in a developmental stage, has already been used for spaceborne transformers on the MARISAT program. It is also being proposed for use on the Atlas II Radar high-voltage power transformer. Whitaker says that the material is also being used to pot high voltage power supplies.

## LSI family reduces size of high-speed systems

Designers of minicomputers and high-speed controllers can now build systems with far fewer components than has been possible, thank to an upcoming LSI family from Signetics.

Called System Logic, the 10-MHz family will use both low-power Schottky TTL and I<sup>2</sup>L to replace bipolar MSI in  $\mu$ P support, communications and peripheral I/O applications.

Initial offerings of the series will be the 8X01 Cyclic Redundancy Character Generator/Checker, 8X02 Control Store Sequencer, 8X03 and 8X04 16  $\times$  2 FIFOs, 8X06 and 8X07 64  $\times$  8/64  $\times$  9 FIFOs, and the 8X300 eight-bit microcontroller—originally introduced by Scientific Micro Systems.

Signetics, of Sunnyvale, CA, is developing the System Logic family to supplement its existing 3000 series bipolar bit-slice microprogrammed  $\mu$ P. (see "Bipolar Bit-

slice  $\mu$ Ps Shrink the Size and Cost of Minis and Controllers," ED No. 10, May 10, 1976, p. 34).

## Air Force forms library of software abstracts

The Air Force has compiled more than 8000 abstracts of computer programs for design and analysis into a software library that enables users to avoid reinventing the wheel. The system allows rapid checking to determine whether or not software has already been generated for a similar problem.

During the past two years information from more than 40 government agencies has been supplied to the library, which is located at Hanscom Air Force Base, MA. M/Sgt. Patrick O'Brien, who is responsible for development of the library, says he expects the number of program abstracts in the library to reach 90,000 within the next few years.

The main data base containing the resident programs is located at the IBM 370/155 installation at Wright Patterson Air Force Base, Dayton, OH. At present the central computer-software repository is open only to government agencies.

## NASA tests solar cell for home and industry

A program to test solar cells and solar-cell systems for commercial and residential use has begun at NASA's Lewis Research Center, Cleveland, OH. Individuals and organizations can submit their photovoltaic-energy-conversion designs for testing and evaluation under controlled conditions.

The center provides a facility at which basic photovoltaic systems may be easily assembled, and their performance evaluated. A facility designed to accommodate arrays of up to 10 kW peak power is already under construction, and a 100 kW capability is planned.

To reveal problems, that might arise when solar-cell arrays are interfaced with typical home wiring systems, a residence will be constructed that incorporates a solar-cell power system to supply a major portion of the building's power.

# We saw your microprocessor

coming. So we designed an entire family of socket homes for it. Socket cards for card file mounting, and we've even got the card files. Socket boards for LSI mounting in frames, drawers, and racks,

and we've even got the frames, drawers, and racks. Our socket cards, the 3D Series, come with built-in test points, a ceramic monolithic bypass capacitor

at each socket, and solder tab connection to pins on LSI chips. Our socket boards, the 2D Series,

offer a good selection of socket complements, and are compatible with other boards for hybrid installations. We also offer automated wiring service. We're ready for you.

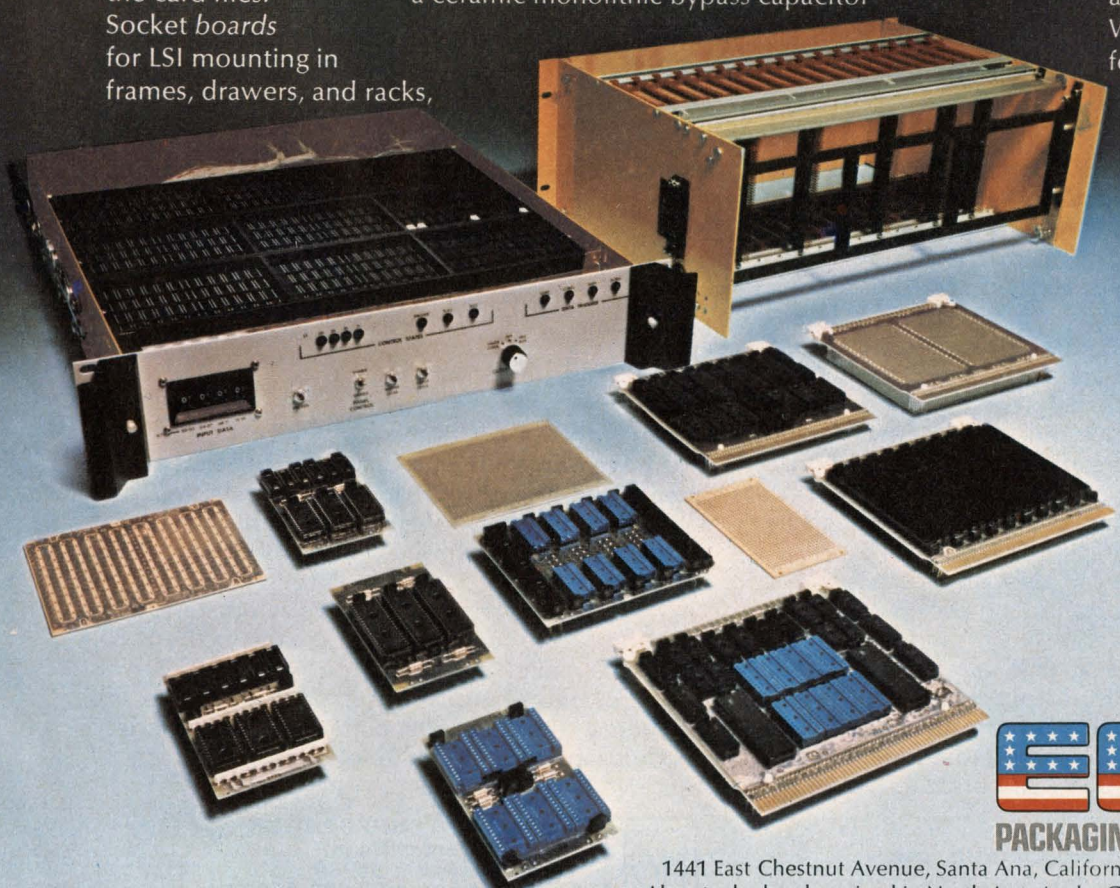

PACKAGING/SWITCHES/READERS

1441 East Chestnut Avenue, Santa Ana, California 92701 Phone 714/835-6000  
Also stocked and serviced in North America by G. S. Marshall, R-A-E, Zentronics.

# Spend less and get a PROM Programmer you can talk to.

Using plug-in personality modules, the inexpensive Series 90 can program almost any AMD, Harris, Fairchild, Intel, Intersil, Monolithic Memories, Motorola, National, Signetics or Texas Instrument bipolar or MOS PROM made. Contact us for information on the specific module you need. Series 90 shown with personality module installed and with optional MOS PROM erase light.



Close-up of Series 90 control panel.

## Pro-Log's Series 90 simplifies the interface between man and machine.

Pro-Log's Series 90 PROM programmer gives you a simple, straightforward method of programming, duplicating or verifying MOS or bipolar PROMs. You program straight from a hexadecimal keyboard so there's no need to learn computer talk. The Series 90 interacts with you and leads you through the programming process so there's less chance for error. Addresses and data appear on a six digit hexadecimal display. Thanks to our plug-in personality modules, display and formatting adjust automatically to accommodate PROM type or size.

The Series 90 can also duplicate PROMs directly from pre-programmed master PROMs, with corrections if necessary.

It has a light indicator to tell you whether or not a PROM is completely blank and will automatically indicate an unprogrammable PROM.

It weighs less than 15 pounds and comes in an attache case. An optional bench top model is available.

## Guards against MOS PROM data loss.

Pro-Log's field-proven programming technology protects against MOS PROM data dropout

caused by improper or inadequate programming pulses.

## Tailor it to your needs.

We have standard options to interface it with TTY, paper tape readers and punches, or computers.

## Low-priced.

A Series 90 control unit costs \$1,800. Personality modules range from \$350 to \$550.

## We have other microprocessor-based instruments and microprocessor subsystems, too.

Our instruments include analyzers for systems using 4004, 4040, 8008, 8080 and 6800 microprocessors.

Our microprocessor subsystems include 4004 and 4040 logic processors and 8008, 8080, and 6800 microcomputers.

For more information on the Series 90, including a complete list of the many personality modules currently available, send for a copy of our PROM User's Guide.



**PRO-LOG CORPORATION**  
2411 Garden Road  
Monterey, CA 93940  
Telephone (408) 372-4593  
TWX 910-360-7082



# What spec do you hate to trade-off when selecting switching power transistors?

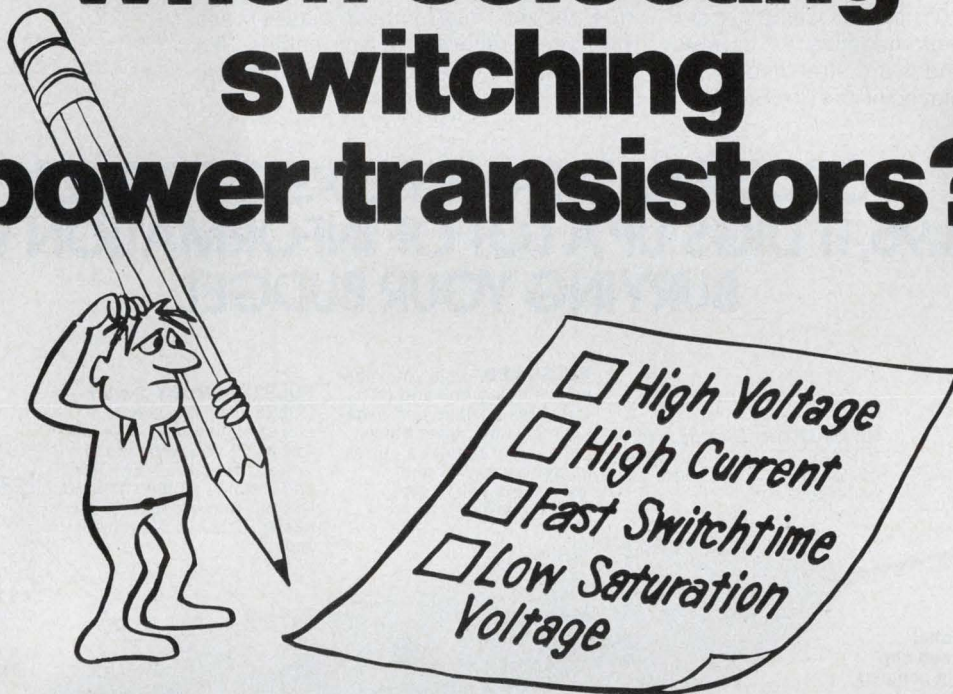

With TRW's new NPN Switching Power Transistors you trade off nothing. You don't have to check a box. You don't have to give up superior performance in one area to get it in the others. These new parts deliver:

- Operation up to 450 Volts sustaining
- Operation up to 10 Amps, continuously
- Fastest Switchtimes available— $T_r = 250$  nsec
- Typical Saturation Voltages of 1.0V at 7 Amps,  $B = 5$

This no-compromise, no trade-off, 4-way superiority adds up to the coolest operation and greatest efficiency for high frequency off-line switching regulators, Class D Switching, and any other similar applications in which high voltage *and* fast switching are essential.

Drop in TRW's new parts and test them yourself. They're competitively priced and available from stock at our distributors.

2N6579, 80, 81	350, 400, 450V	5Amp	TO-3
2N6585, 86, 87	350, 400, 450V	5Amp	TO61-Isolated
2N6582, 83, 84	350, 400, 450V	7Amp	TO-3
2N6588, 89, 90	350, 400, 450V	7Amp	TO61-Isolated

If those numbers are not now in your plans—well, the advantage of these new parts is so pronounced, maybe you should design them in!

At any rate, you'll surely want to know more about TRW's new NPN Switching Transistors. For full information call John Power at (213) 679-4561. Or use the coupon.

#### TRW Power Semiconductors

An Electronic Components Division of TRW, Inc.,  
14520 Aviation Boulevard, Lawndale, California 90260

- Please send me data sheets on TRW's new series of NPN Switching Power Transistors
- Have a salesman get in touch with me

Name \_\_\_\_\_

Company Name \_\_\_\_\_

Position \_\_\_\_\_

Address \_\_\_\_\_

City \_\_\_\_\_ State \_\_\_\_\_ Zip \_\_\_\_\_

## TRW POWER SEMICONDUCTORS

ANOTHER PRODUCT OF A COMPANY CALLED TRW

Logic Probe 1 is a compact, enormously versatile design, test and troubleshooting tool for all types of digital applications. By simply connecting the clip leads to the circuit's power supply, setting a switch to the proper logic family and touching the probe tip to the node under test, you get an instant picture of circuit conditions.

LP-1's unique circuitry—which combines the functions of level detector, pulse detector, pulse stretcher and memory—makes one-shot, low-rep-rate, narrow pulses—nearly impossible to see, even with a fast scope—easily detectable and visible. HI LED indicates logic "1", LO LED, logic "0", and all pulse transitions—positive and negative as narrow as 50 nanoseconds—are stretched to 1/3 second and displayed on the PULSE LED.

By setting the PULSE/MEMORY switch to MEMORY, single-shot events as well as low-rep-rate events can be stored indefinitely.

While high-frequency (5-10MHz) signals cause the "pulse" LED to blink at a 3Hz rate, there is an additional indication with unsymmetrical pulses: with duty cycles of less than 30%, the LO LED will light, while duty cycles over 70% will light the HI LED.

In all modes, high input impedance (100K) virtually eliminates loading problems, and impedance is constant for all states. LP-1 also features over-voltage and reverse-polarity protection. Housed in a rugged, high-impact plastic case with strain-relieved power cables, it's built to provide reliable day-in, day-out service for years to come.

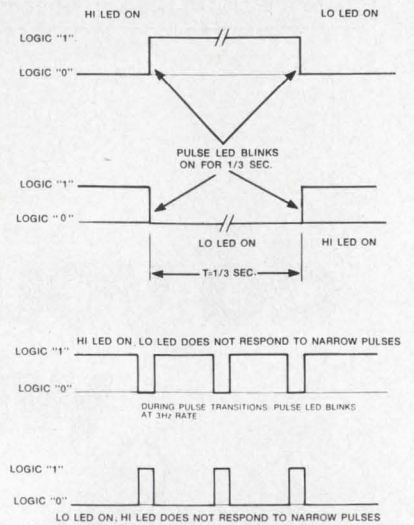

## CSC'S MULTI-FAMILY LOGIC PROBE 1. AT \$44.95, IT DIGS UP A LOT OF INFORMATION WITHOUT BURYING YOUR BUDGET.

**HI/LO LED's**—Display level (HI-logic "1", LO-logic "0") of signal activity at node under test

**PULSE LED**—Lets you know what's going on—and off. Indicates positive and negative pulse and level transitions. LP-1 stretches pulses as narrow as 50 nanoseconds to full 1/3 sec. (3Hz pulse rate)

**PULSE/MEMORY Switch**—PULSE position detects and stretches pulses as narrow as 50 nanoseconds to 1/3 sec. Switch to MEMORY and it stores single shot and low-rep-rate events indefinitely; HI/LO LED's remain active

**Logic Family Switch**—TTL/DTL or CMOS matches Logic "1" and "0" levels, for greater versatility. High Input Impedance—100K virtually eliminates circuit loading problems and is constant in both "0" and "1" states. CMOS position also compatible with HTL, HiNIL and MOS logic

**Non-corrosive nickel-plated probe tip and clip leads**—For reliable contacts and maximum life

**Rugged high impact plastic case**—Built to take it . . . in the lab or in the field

**Protected**—Features built-in reverse polarity and over-voltage protection; strain-relieved power cable

**\$44.95 Price tag**—Costs so little it can be your personal property

© 1976, Continental Specialties Corp.

CONTINENTAL SPECIALTIES CORPORATION



EASY DOES IT

For more information, see your distributor or write for our catalog and distributor list.

44 Kendall St., Box 1942 New Haven, CT 06509 • 203-624-3103 TWX: 710-465-1227 West Coast office: Box 7809, San Francisco, CA 94119 • 415-421-8872 TWX: 910-372-7992 Canada: Len Finkler Ltd., Ontario

# BME™ Capacitors- Proven Reliability For Automotive Applications

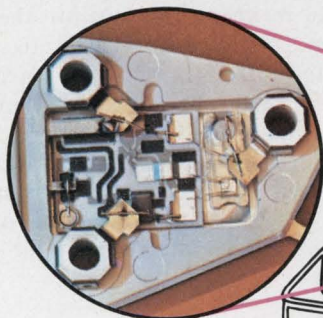

Voltage Regulators

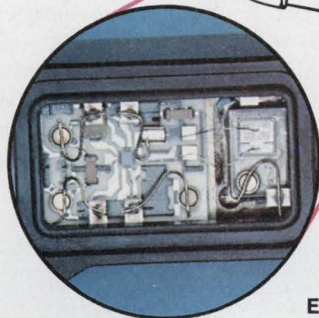
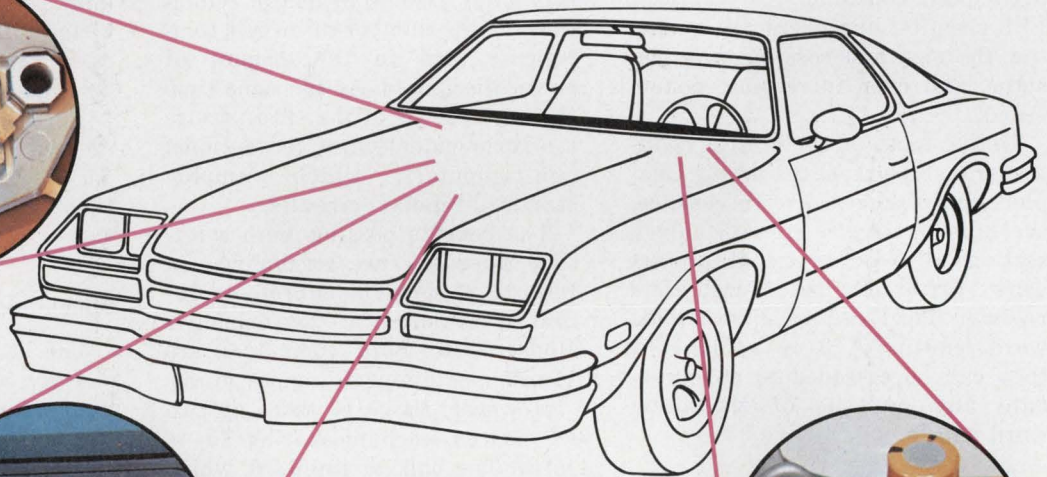

Electronic Ignition Systems

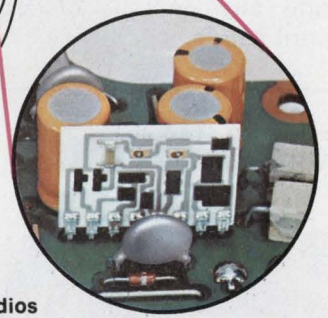

Radios

**USCC/Centralab, the major supplier of monolithic ceramic capacitors to the largest manufacturers of automotive hybrid electronics.**

The automotive environment can be considered the ultimate proving ground for component reliability. Under-the-hood systems provide a hostile environment where moisture, temperature extremes, shock and vibration are constant. It is a tremendous challenge to supply a component economical enough for an automotive application which can stand up to their rigorous specifications.

And Centralab is there, providing over 3.9 million BME-Chip™ Capacitors which are in 2.25 million domestic cars and light trucks. Over 11 billion unit life hours in ignition systems, voltage regulators and radios, without a single known failure. That's reliability! Compare your requirements with those of the automotive industry. We're sure you'll choose BME™ Capacitors . . . reliability and availability at a low cost.

Please write on company letterhead for complete technical test reports.



USCC/CENTRALAB Electronics • GLOBE-UNION INC.

4561 Colorado Boulevard • Los Angeles, Ca. 90039 • (213) 240-4880

FOR LITERATURE ONLY CIRCLE 251

FOR FREE SAMPLE, CIRCLE 252

## Bipolar bit-slice $\mu$ Ps shrink the size and cost of minis and controllers

Bipolar microprocessor "slices" have become the hottest new building blocks for minicomputers and high-speed controllers. With these LSI circuits, engineers are reducing the size and cost of their designs, and even increasing system speed.

Unlike most of their MOS counterparts, bipolar slices aren't complete microprocessors. In essence, the bipolar circuits contain only a section of a conventional processor's arithmetic-logic unit and register file. Existing slices handle word lengths of 2 or 4 bits, but they can be cascaded to accommodate any multiple of the basic word length.

**Edward A. Torrero**  
Associate Editor

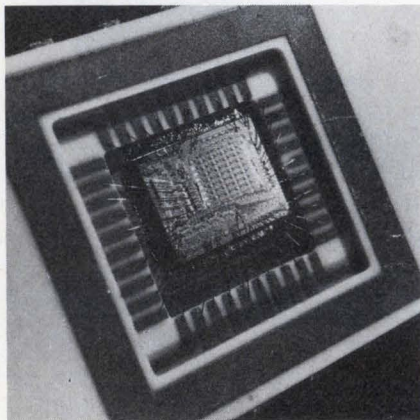

The fastest TTL microprocessor slice—Advanced Micro Devices' Am2901 (above)—specifies 100-ns microinstruction cycle over supply and operating temperature ranges. The 4-bit slice contains an eight-function arithmetic logic unit, a two-port scratchpad memory with 16-word capacity and an additional accumulator register (right).

Existing minis can be upgraded or replaced without having to discard system software. The bipolar/LSI chips permit dramatic reductions in the number of circuit components, and in the amount of power dissipated. At the same time the high speeds of the slices assure a precise emulation of conventional minicomputers, which employ standard-bipolar circuits.

The benefits possible with a bit-slice approach are exemplified in Interdata's new Model 6/16, an upgraded emulation of the company's Model 7/16. Both computers are 16-bit, medium-performance minis.

However, the 7/16 takes up two PC boards, each measuring 15 × 15 in. The bulk of the 6/16, which uses four Advanced Micro Devices' 2901 slices, comes on a single board.

The total number of circuits drops from about 300 ICs for the 7/16 to about 180 ICs for the new mini. As a result, the 6/16, complete with 8-k bytes of memory, costs \$2900, or \$300 less than the original mini.

Further, system speed was increased by about 25% from the 1.5  $\mu$ s specified for mini operations like register-to-register additions.

### Slices require microprogramming

The benefits are no less impressive for controllers and designs begun "from scratch." In all cases, the key to the slices' remarkable capabilities is microprogramming, the ability to employ a unit's fundamental microinstruction set to tailor the system to any appli-

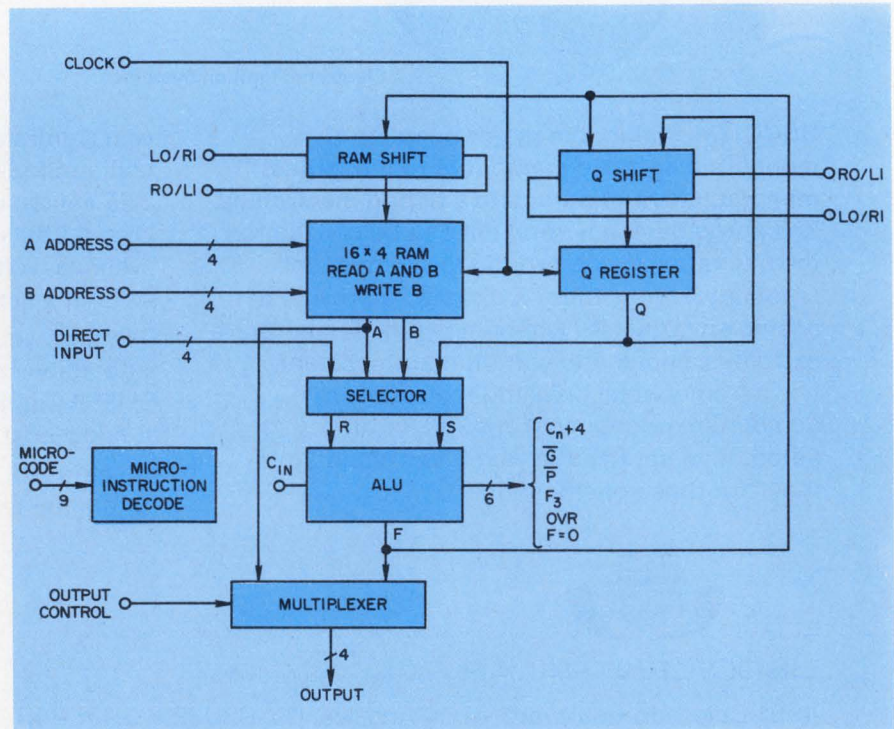

# STAR PERFORMERS

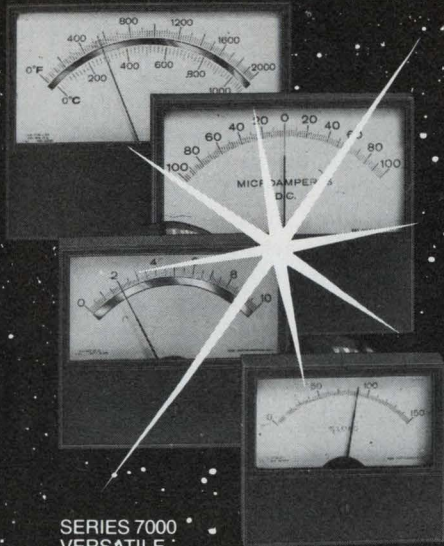

SERIES 7000  
VERSATILE

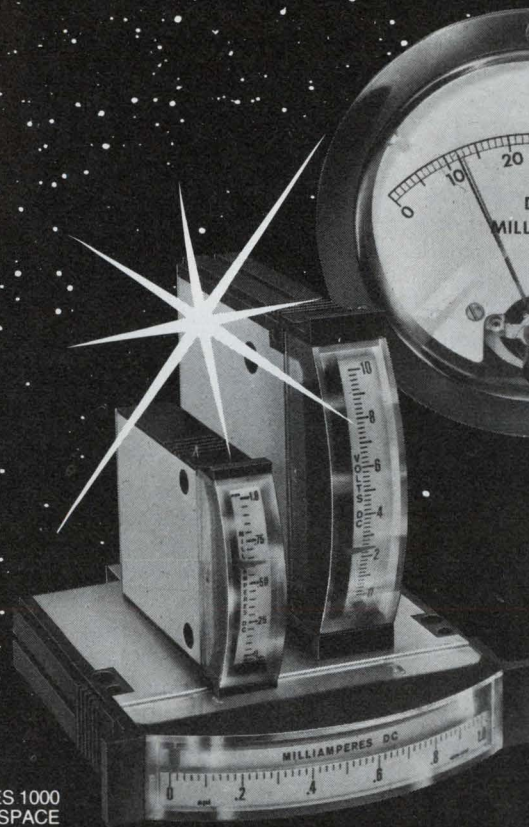

MODEL 454  
SUPER-TOUGH

SERIES 1000  
SAVES SPACE

## api Panel Meters

Get the performance you need – with API panel instruments. Need economy? Small package? Tough case?  $\frac{1}{2}\%$  accuracy? LFE has them all.

**VERSATILE:** Series 7000 can be panel, lens, or bezel mounted. Slide-out scales facilitate modification.

**SAVES SPACE:** Series 1000 in  $1\frac{1}{2}$ ",  $2\frac{1}{2}$ " and  $3\frac{1}{2}$ " sizes feature rugged polycarbonate case, quick stackable mounting, and famous API quality and styling. Surprisingly economical too.

**SUPER-TOUGH:** Our new  $4\frac{1}{2}$ " round Model 454 is an ideal replacement for glass-window instruments in portable, industrial, and plant uses. Its wrap-around polycarbonate case tosses off blows that would destroy lesser meters. Large clear dial for great visibility.

**ACCURATE:** Nobody makes more precise panel instruments. We start at a standard 2% rating, with 1% tracking for taut-band ranges. We stop at  $\frac{1}{2}\%$  accuracy. You can have anything in between.

There's a LFE distributor or authorized modification center near you to provide quick service on standard or special ranges. Call him. Or call us. We perform. LFE Corporation, Process Control Division, 1601 Trapelo Road, Waltham, Mass., 02154, (617) 890-2000

**LFE**  
CORPORATION

Process Control Division

cation.

When applied to minis, a microprogram stored in a control memory defines the computer's fixed-instruction set. For a controller, however, the microprogram can define the system's entire operation.

However, microprogramming can also be a designer's bane. It requires a designer to deal with the specific timing relationships of the chip's internal architecture. And since each application uses a separate microprogram, each has one that can't be transferred easily to another application. Nor can design aids, geared toward one slice model, be transferred to another.

Not that many aids are available. At the very least, a designer generally needs a microassembler: a program that lets him microcode without dealing with a processor's inherent and unwieldy machine language of ONES and ZEROS. He'll also want to use a ROM simulator to check out the microprogram. However, few manufacturers offer these essential design aids, or suitable equivalents.

The growing acceptance of bit-slice microprocessors has spurred semiconductor manufacturers to develop improved circuits. Efforts are now under way to build enhanced sequencers for presently available slices. Sequencers—companion circuits to the slices—provide the logic needed to operate the microprogram control memory. They also generate next-address instructions, thereby simplifying the microcode.

Also in the wings are other sophisticated support circuits, such as field-programmable logic arrays, 4-k bit RAMs and 16-k ROMs. Employing advanced forms of ECL, Schottky-TTL or I<sup>2</sup>L (integrated-injection logic), upcoming products may even include complete bipolar microprocessors on a single chip, and increase slice word lengths (presently a maximum of 4 bits) to 8 bits.

### I<sup>2</sup>L slices move up in speed

The first bipolar slice to use I<sup>2</sup>L technology—Texas Instruments' 4-bit SBP0400—never caught on. There were several reasons.

Operating at speeds comparable

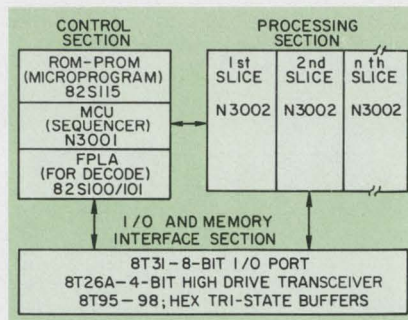

This central-processing unit, based on the 3000 slice offered by Intel and Signetics, employs the latter's field-programmable logic arrays.

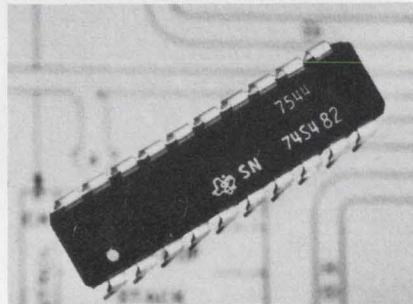

Packaged in a 20-pin DIP, a 4-bit Schottky-TTL sequencer from TI can be cascaded to handle various sizes of microprogram memory.

to complete, single-chip MOS microprocessors, the I<sup>2</sup>L slice required many more circuits to form a working system without offering any real speed advantage.

Moreover, the circuit's need for microprogramming made it more difficult to design with than MOS  $\mu$ Ps.

Still, the SBP0400 did establish TI as the only I<sup>2</sup>L slice maker. And now the company plans to strengthen that position when it offers, in the third quarter, an upgraded 0400—designated with a suffix A—that uses an advanced I<sup>2</sup>L technology to achieve Schottky-TTL speeds.

The 0400A's longest microcycle path takes 150 ns, when it is used in a 4-bit configuration. A comparison based solely on the same speed spec for other 4-bit slices puts the new slice about midway between Advanced Micro Devices' faster 2901 and Monolithic Memories' slower 6701.

Another version of the 0400—the 0401—offers speeds and capabilities similar to that of the 0400A. A key difference, though, is that the 401 can work readily with members of a forthcoming family of Schottky-TTL circuits that TI

calls, simply enough, the Schottky Microcomputer Chip Set.

"The chips were a computer before they became a chip set," observes Dick Horton, TI's manager of bipolar product development, commenting on the use of the Schottky-TTL circuits in his company's 990 computer family (see "Processor Family Debuts," ED No. 22, Oct. 25, 1975, p. 137). "They started as the upper end of the family."

The chip set will mark TI's long-awaited entry into the TTL-slice sweepstakes. At the heart of the family is the 74S481, a 4-bit circuit that TI plans to introduce in the fall and that is described as the next-generation slice. Its claim is not likely to be refuted.

Inside the S481 is a programmable logic array with "hard-wired" control algorithms that yield a whopping 24,780 set of different microinstructions. No other slice responds to more than about 500.

The algorithms are actually those of the 990 computer, and directly provide for multiply and divide without having to microprogram for those operations. When applied to a 16  $\times$  16-bit multiplication, a series of S481s can produce a 32-bit result in 2-1/2  $\mu$ s.

For such operations, the S481 employs a kind of trinary logic. Depending on whether one of the input pins is connected to ground, supply or left floating, the circuit becomes the least-significant, most-significant or intermediate-bit slice, respectively. On receiving a multiplication or divide command, the most-significant bit slice takes charge of the other slices and executes the command.

Another distinctive feature is the S481's so-called memory-to-memory architecture. The chip doesn't have a dedicated register file. Instead, internal memory-control logic allows the use of all of program memory. A work-space pointer keeps track of the external register space, and a program pointer locates instructions.

As impressive as the new Schottky family promises to be, it might well be dwarfed in comparison with an I<sup>2</sup>L family that TI only hints at now. Advances in the technology have reportedly reached the point at TI where a single-chip I<sup>2</sup>L mi-

# COULD A \$3 RESISTOR SAVE YOU A \$300 FIELD SERVICE CALL?

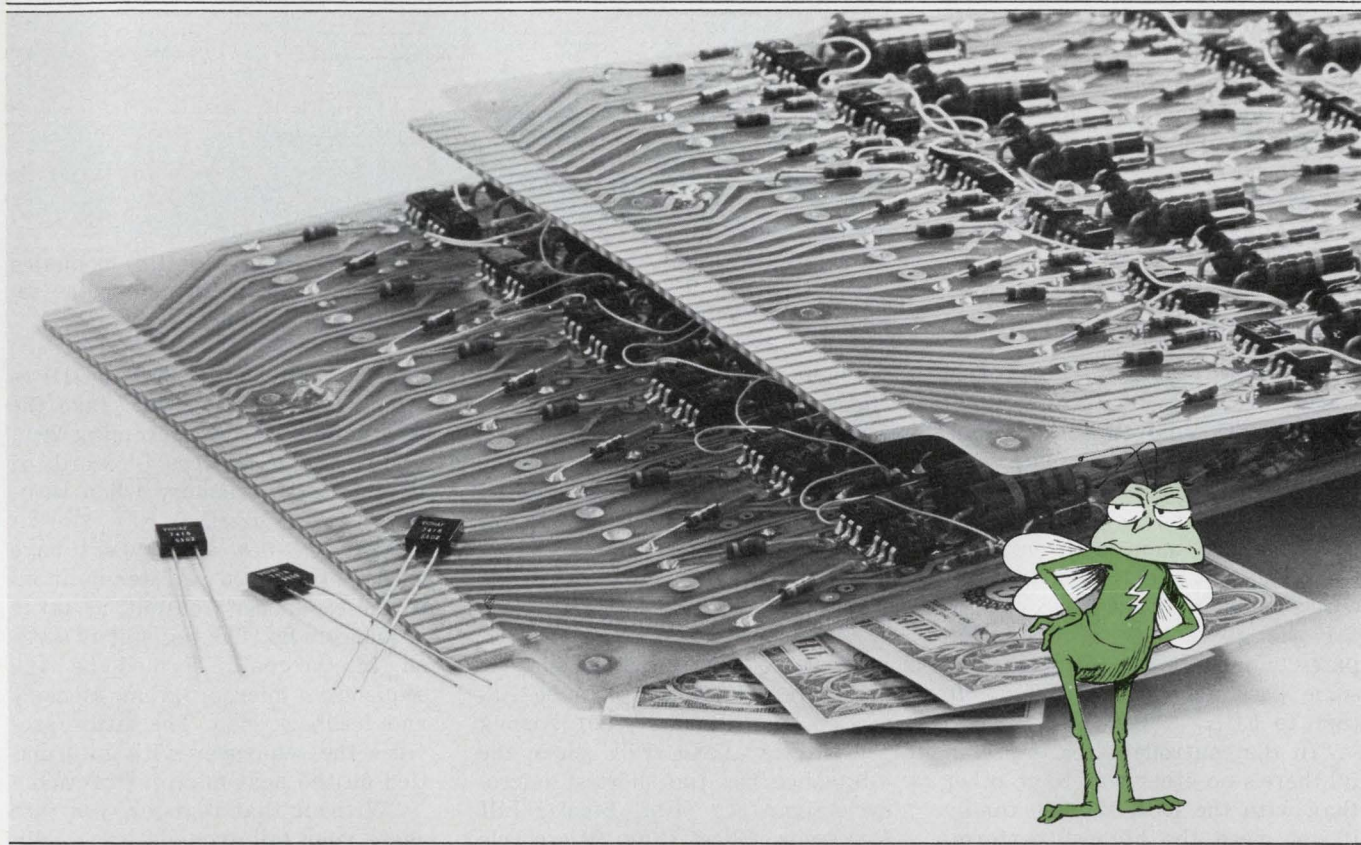

It sure could.

When the equipment you've built fails at the worst possible moment in the field, you may suddenly learn just how expensive a mere resistor can be. You may learn the hard way that the dollar or two you saved at the drawing board has cost you hundreds or even thousands in warranty service. And quite possibly even cost you a customer.

Not every resistance application cries out for Vishay quality. You may often do without this quality and still suffer no dire consequences.

But when you need a precision resistor or trimmer for rock-solid stability and reliability, think of this:

Some precision resistors offer you tight tolerance at the expense of poor frequency response. Others offer low inductance and fast rise at the expense of poor temperature characteristics. Only Vishay Bulk Metal® resistors offer you the *complete set* of top performance characteristics, including TCR as low as  $0 \pm 1 \text{ ppm}/^\circ\text{C}$ , a combination that will most often free your equipment from that tormenting bug.

And now Vishay offers you the chance to *make your own* custom bulk-metal resistors for breadboard, prototype, or even production use. Call or write for information on the simple calibration and encapsulation of Vishay resistors in your own plant. Vishay Resistive Systems Group, 63 Lincoln Highway, Malvern, PA 19355; phone (215) 644-1300; TWX 510-688-8944.



**Only Vishay resistors give you all six top performance specs.**

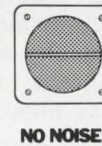
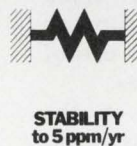

## NEWS

croprocessor—with speeds possibly overtaking Schottky-TTL—is now feasible. The  $\mu$ P could even have a word length as high as 16 bits.

Already, the company has indicated its plans to introduce such I<sup>2</sup>L components as a 4-k bit static RAM and a 16-k ROM. Along with other I<sup>2</sup>L circuits, the upcoming offerings could well mushroom into an I<sup>2</sup>L microcomputer chip set.

But as for an I<sup>2</sup>L CPU chip, Horton only says, "We're going to surprise a lot of people. They don't think you can do it in NMOS, but we'll have it in I<sup>2</sup>L."

### ECL: still the speed king

For now, though, the fastest speeds are offered by an ECL bit slice from Motorola (see "ECL Bit-Slice Processor Arrives, Setting Top Speeds for Bipolar  $\mu$ Ps," this issue, p. 53).

Like other manufacturers, Motorola doesn't see the bipolar circuits displacing their MOS cousins for the great bulk of microcomputer applications, although for some uses designers will have to turn to ECL.

"In the controller area, especially, there's no other way to go other than with the ECL M10800 family if you need the highest performance," asserts Jim Loro, Motorola's marketing manager for bipolar memories and LSI. He expects controllers to embrace his product more quickly than any other application area.

Still, the speed benefits of ECL show up dramatically when the bipolar circuits are compared with MOS ones. For the same algorithm (or system program) designers can expect an increase in speed by a factor of 10 because the ECL system's clock rate is that much faster.

And when the slice-based system is tailored to a high-speed application, the speed increase could soar to much more. The tailoring comes about primarily through microprogramming and the use of high-speed bipolar memories.

These facts aren't lost on the many designers who employ popular MOS  $\mu$ Ps like the 6800.

"I have had several customers calling to ask how one does a 10800

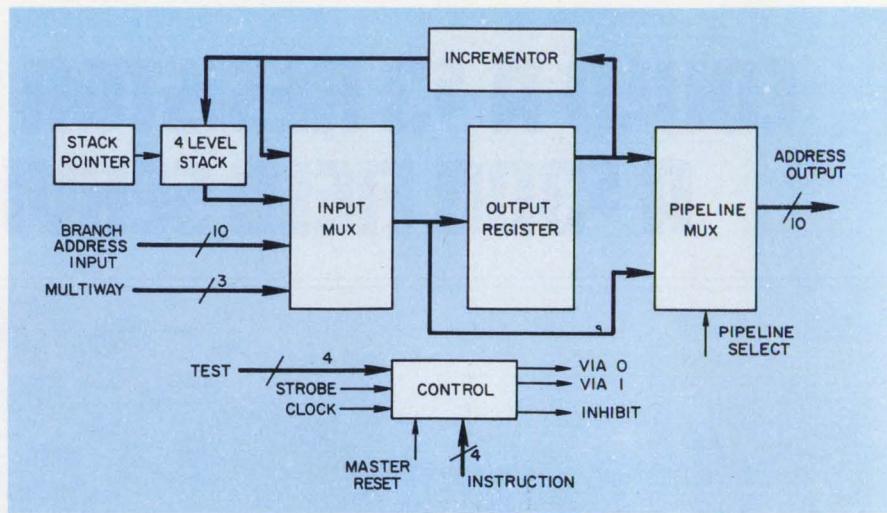

An Isoplanar I<sup>2</sup>L sequencer from Fairchild directly addresses control memories up to 1024 words in size. A bipolar CPU can be built by combining the sequencer with other circuits in the company's Macrologic line.

version of a 6800 system," says Bill Blood, manager of bipolar LSI system development. Blood, though, agrees that the use of slices to emulate MOS  $\mu$ Ps will amount to only a small part of their possible applications.

### 4-bit slices set the standard

Currently the leading slice is generally acknowledged to be Advanced Micro Devices' 2901. Among presently available TTL slices, the 4-bit slice has the shortest microcycle time (see "4-bit Bipolar/LSI Processor Slice Cuts Microcycle Time to 100 ns," ED No. 15, July 19, 1975, p. 77). It has been alternate-sourced by Raytheon and Motorola, and AMD boasts a customer list numbering over 200.

Among designers, one reason for the 2901's popularity is the flexible structure of the slice's microinstruction. The 9-bit word consists of three 3-bit segments that either control or determine the internal arithmetic-logic unit's source operand, function and destination register. The breakup reduces delays; it permits parallel decoding of different segments of the same microinstruction.

In addition, the three-way breakup leads to 512 possible microinstructions. However, not all 512 represent useful instructions.

Another factor in the 2901's success was the early availability of supporting circuits like the 2909 microprogram sequencer. AMD plans to offer a version of the sequencer housed in a smaller pack-

age—a board-saving 20-pin DIP vs 28-pin DIP for the 2909. Like the original circuit, the upcoming 2911 will be able to address 4-k words of microprogram memory when three are cascaded together.

Also, the new 2911 won't have an edge-triggered register built into the sequencer's output, as other sequencers do. The register is needed in the path formed by the sequencer, microprogram memory and feedback loop. The latter provides the sequencer with information on the next microinstruction.

"Without that register, you just chase your tail around," says John Springer, AMD's marketing manager for bipolar  $\mu$ Ps. "But if it comes at the output of the sequencer, the unit isn't really intended for a pipelined system, implying a longer system cycle." A better spot would be at the output of the microprogram memory.

The internal architecture of Advanced Micro Devices' 2901 so closely resembles Monolithic Memories' earlier 6701 that a system designed for one could be adapted readily for the other.

"If I were a designer out there, I would be frustrated because the two circuits are so similar," observes Clive Ghest, applications systems manager at Monolithic Memories. The two 40-pin parts aren't pin-compatible.

"But if a designer started from scratch, he could more than likely develop an instruction set usable with either circuit. He would need a different PC card and different control memory. However the basic



# Magnecraft's line of 1200 stock relays just increased ... by another series.

**WHY WAIT FOR SOLID STATE?** Our family of 24 solid state relays provides current ratings from 2.5 to 40 amps, with switching capacity up to 480 VAC. All models incorporate optoisolation between input and output, and zero-voltage switching. Screw type clamps and Faston "Quick-Connect" terminals are available on packages which are interchangeable with others. Output switching reflects the latest state-of-the-art technology. Both the high-reliability dual SCR approach and the more economical triac approach are available.

Magnecraft is committed to providing design engineers with the best solution for their switching applications. It is with a complete understanding of the areas where solid state relays provide the most reliable and economical switching solution, that we've included this family in our line of stock relays.

For complete information and specifications, WRITE FOR OUR SOLID STATE RELAY PRODUCT BULLETIN. Magnecraft Electric Co., 5575 N. Lynch Ave., Chicago, IL 60630



**Magnecraft**<sup>®</sup>  
ELECTRIC COMPANY

# RCL

*Offers*

## "EXPRESS DELIVERY"

*At Standard Pricing...*

*On Rotary & "PIP" Switches*

**Industry's Best Delivery at Non-Premium Prices.**

**PROTOTYPE OR PRODUCTION RUNS—ALL AT STANDARD PRICING**

Send For New '76 Catalog Or Call our Hotline For Name Of Your Local Representative Or Stocking Distributor.

(201) 374-3311

**AMF**

**RCL Electronics**

General Sales Office:  
700 So. 21st Street  
Irvington, N. J. 07111

## NEWS

operations of the two systems—operations like add, shift and compare—could be identical."

More importantly, the highly vaunted speed advantage of AMD's 2901 over MMI's 6701—as high as 2:1 for some operations—shrinks when the two are applied to a 16-bit system, like that common for minicomputers.

Though the 2901 is still the front runner, the winning margin is less. According to Ghest, the AMD circuit has a worst-case delay of 145 ns; that of his product is only 30 ns longer.

Monolithic Memories expects to close the gap and take the lead in speed with a dash-1 version to be offered later in the year. It will have worst-case cycle times of 100 ns in the commercial temperature range and 125 ns over the MIL range, making it, by Ghest's figuring, 40% faster.

### 2-bit slices available, too

Compared with 4-bit slices, which designers have embraced readily, 2-bit slices have yet to make their mark. These circuits are available in the 3000 series introduced by Intel and alternate-sourced by Signetics. Designers typically cite difficulty in using the circuits as the main reason for keeping their distance from the series.

Without minimizing the problems, Intel's Ron Yara, product manager for the 3000, points to the advantages.

The 3002 2-bit slice, for example, requires only seven bits to specify a function's source, destination and operation. That number is less than half the bits typically needed by 4-bit slices.

Also the 3002's multibus structure eliminates the need for external multiplexers. The slice has separate address and data outputs and two independent data inputs. A special "K" bus even permits the masking of unwanted bits, during logic testing, and the generation of constants.

A single 3001 sequencer can address 512 words of microprogram memory—a sufficient amount for many 16-bit minis. And the cir-

cuit's unusual row/column addressing scheme can actually be an advantage, according to Yara, since clusters of microcode can be located rather easily.

As for design aids, no manufacturer can match Intel's. The company offers a cross-microassembler (called Cromis) and a prototyping system (MDS) that allows in-circuit emulation, permitting simultaneous hardware and software development.

The 3000 series offered by Signetics provides the same functions and pinouts of Intel's. However, its slice features a 30% faster cycle time. And the company will soon have a version of the 3001 sequencer that will come in a reduced-size package but have twice the addressing range. The new sequencer will also incorporate a four-level stack.

Signetics plans to employ its bit-slice family in upcoming kits that emulate MOS microcomputers. The initial offering, planned for a June introduction, will be a bipolar version of the 8080A system. The kit will have about 60 ICs and include programmed PROMs.

Although two 2-bit slices are needed to obtain most features available from a single 4-bit slice, systems based on either circuits may actually use about the same number of IC packages.

"In the real world, you need additional circuits besides the slices to do the job," comments Steve Lau, a member of Signetics' technical staff.

"You may need additional registers for, say, memory addressing, or multiplexers to overcome bus limitations. For an 8 or 16-bit machine, you can't really say that either slice automatically leads to fewer packages."

However, there is one bipolar/LSI circuit that can lead to fewer packages than are needed for any slice. Scientific Micro Systems' SMS 300, the only bipolar single-chip CPU, isn't a general-purpose microprocessor, but it can simplify control systems.

Equipped with eight 8-bit working registers and a set of eight control-oriented instructions, the SMS 300 has an instruction-execution time of only 250 ns, which includes 85 ns for memory access. The chip will soon be alternate-sourced by Signetics. ■■

# Not New...Just the Best



## **ERIE RED CAP**

### **Miniature Ceramic Capacitors**

#### **WIDEST SELECTION OF MINIATURIZED CERAMIC CAPACITORS IN THE INDUSTRY!**

Erie is in the Red Cap winner's circle because of a well engineered component that's backed by a unique process control system. Combine this with talented, motivated people and you have Erie as the leader in its field. These tiny high quality capacitors are not new... but they are the best. Our customers attest to it. Our test laboratories prove it.

Red Cap dielectrics are manufactured by Erie's exclusive Monobloc Process<sup>®</sup>... a modern, time-proven ceramic film technology. And tough environmental extremes routinely are endured by our own Jet-Seal, a hard, bright red polymeric protective coating. (The superior aesthetic appearance of Jet-Seal comes to you at no charge.)

Erie Red Caps have it all. 21 temperature characteristics. 1pF to 10uF capacitance range. Ratings from 25 to 500 Vdc. You name the application... we've got a Red Cap for the job. All this is due to Erie's total in-house capability... from exclusive ceramic formulations to unique packaging. So on your very next buy of ceramic capacitors, do it the easy way... specify Erie Red Caps.

Write TODAY for Red Cap brochure 8000... or call our nearby factory representative.

CAPACITANCE  
RANGE  
1pF to 10uF

21  
TEMPERATURE  
Characteristics

Voltage Range  
25 to 500 Vdc

Encapsulated  
by  
"JET-SEAL"

Meet or Exceed  
Requirements  
of MIL-C-20  
MIL-C-11015  
As applicable

ERIE TECHNOLOGICAL PRODUCTS, INC.  
Erie, Pennsylvania 16512

The logo for Erie Technological Products, Inc. features the word "ERIE" in a stylized, multi-colored font. The letters are arranged in a way that suggests a globe or a circular pattern, with the 'E' and 'I' being the most prominent. The colors include purple, blue, green, and yellow.

# Transient testing is spreading to systems designers

Transient testing is spreading from the power companies to such fields as computers, instruments and even home entertainment. As a result, the IEEE Surge Withstand Capability (SWC) test is now finding a wide application throughout the electronics industry.

An IEEE group currently is defining SWC specs applicable to the computer industry. The original specs were developed in 1974 for the power distribution industry.

In some cases power-line transients can mean very little, other times they can have disastrous results. A color-TV set need not maintain a flicker-free image, but a hospital X-ray scanner must.

## Withstanding the surge

And yet, coping with transients is important in television too.

"You can have a 3000-V surge on the wall outlet for your color-TV set," warns Franz Martzloff, of General Electric's R & D facility in Schenectady, NY.

"If you could limit the transient from several thousand volts down to a sure 500-V max, then the TV-set designer could specify the component's voltage ratings with a reasonable assurance that the components would survive."

Amdahl Corporation of Sunnyvale, CA, uses a motor-generator system to ensure that line surges do not interfere with its Model 470V/6 supercomputer, but most designers cannot afford the motor-generator approach.

For digital controls, the simplest and most common method of isolating transients is to use relays or opto-isolators. For analog signals, gas discharge arc suppressors with RC or LC filtering are used.

But since relays tend to be slow and unreliable, and logic circuits with relatively low noise immunity

are being used, designers are turning to solid-state suppressors. For example, metal-oxide varistors, such as the GE MOV made by General Electric in Syracuse, NY under license from Matsushita of Osaka, Japan, can limit surges to two or three times normal operating voltages. They are used to clamp both ac line inputs and signal lines.



**Repeatable surge testing** is now as easy as pushing a button, thanks to new IEEE specs and commercial surge generators, such as this Velonex Model 510.

Surge-rated avalanche diodes, such as the TransZorb from General Semiconductor of Tempe, AZ, rated from 5 V to 1 kV, are particularly suited to protecting open-collector TTL outputs because they present no dc-leakage path until they conduct a surge. Bidirectional TransZorbs are notably good for surge-protecting analog inputs and outputs.

Another successful approach to surge protection uses 4 kV capacitors of Mylar or polycarbonate film to absorb the transient energy. This approach would also include a special cable layout and lead dress to prevent low-level signal lines from coupling transients from power lines.

Separate cable harnesses for power and signals are used, with

lines running at right angles whenever possible. Doubly shielded coaxial signal lines often are employed too.

Until recently the way to test for transients in electronic systems was to randomly connect inductive loads into the power line in an effort to simulate surges. The simulation might involve turning on electric drills, plugging large power supplies into the same wall outlet as the system being tested, or using more sophisticated impulse tests.

Impulse tests provide a unidirectional pulse input to the system under test, simulating high voltage arcing or other instantaneous phenomena. Typical of the impulse testers on the market is the Model 424 Surge Generator/Monitor by KeyTek Instrument Corporation, Waltham, MA. But most power-line surges are not impulses and there is no absolute standard for impulse testing.

All that is changing since the IEEE adopted surge-testing standard 472-1974. The test surge described in the standard is representative of typical power transients, and is a compromise between two requirements. The 2.5-kV, 1.25-MHz damped-sinewave burst applied to power and signal lines is a voltage high enough that power companies can limit surges to it. And the voltage is also low enough that system designers can build systems to withstand it.

The Velonex Division of Varian Associates, Santa Clara, CA, recently introduced a surge transient generator that meets all of the requirements of IEEE standard 472-1974 and the identical ANSI standard C37.90a-1974. The unit also allows the operator to vary the burst duration, amplitude, source impedance, and phase with respect to the power line. ■■

Monday-

John-

SUGGEST YOU INVESTIGATE & GET SAMPLE  
OF GE'S NEW 13¢ VARISTOR

SEE ATTACHED →

See

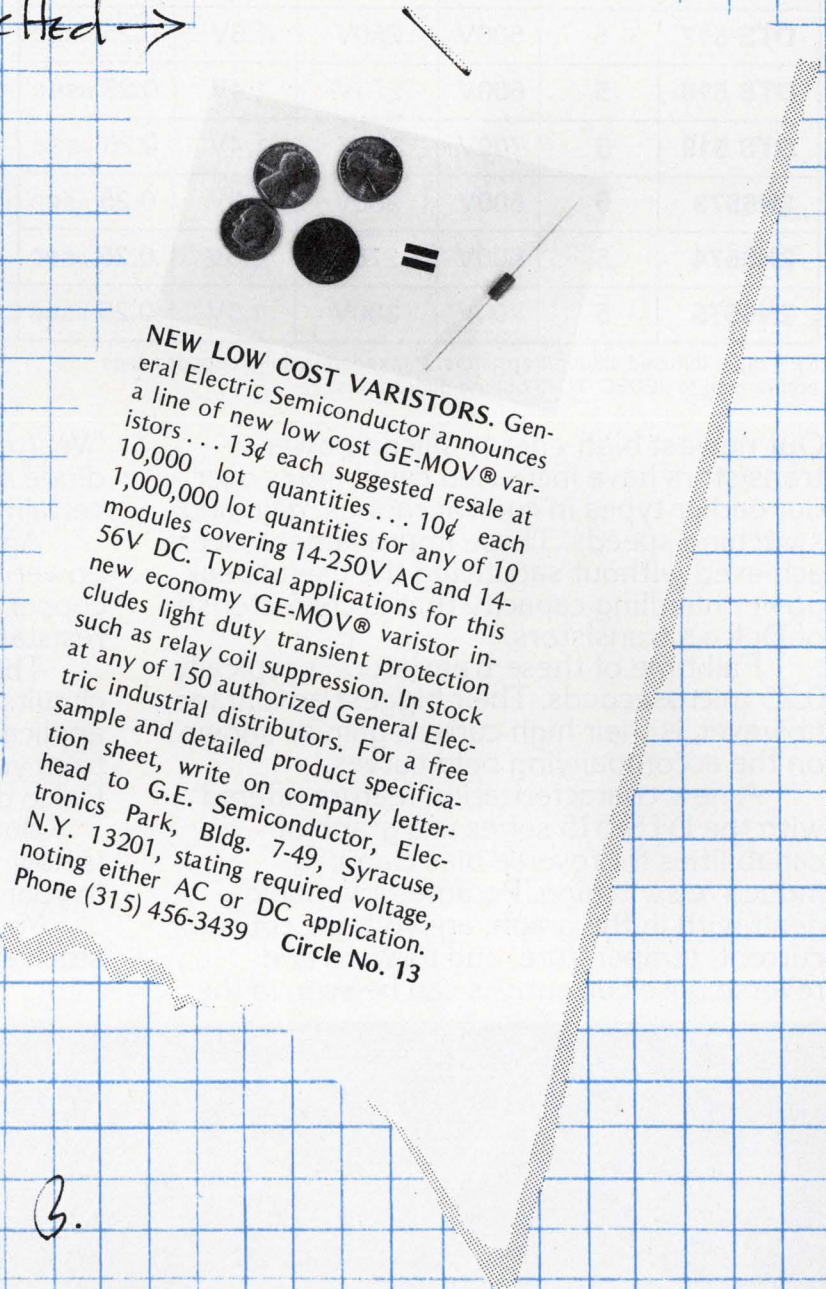

PS-

ALSO GET A  
COPY OF GE'S NEW  
TRANSIENT MANUAL  
THANKS. B.

GENERAL  ELECTRIC

# DELCO'S NEW FAS HIGH-GAIN TRANSIS

## MAJOR PARAMETER LIMITS

TYPE	$h_{FE}$ @ 10A	$V_{CBO}$	$V_{CEO}$ (sus)	$V_{CE}$ (sat) @ 7A	$t_f$ (typical) @ 5A
DTS 515	3.5	300V	250V	5.0V	0.25 $\mu$ sec
DTS 516	4	400V	250V	1.9V	0.25 $\mu$ sec
DTS 517	5	500V	250V	1.6V	0.25 $\mu$ sec
DTS 518	5	600V	275V	1.4V	0.25 $\mu$ sec
DTS 519	5	700V	300V	1.4V	0.25 $\mu$ sec
2N6573	5	500V	250V	1.5V	0.25 $\mu$ sec
2N6574	5	600V	275V	1.5V	0.25 $\mu$ sec
2N6575	5	700V	300V	1.5V	0.25 $\mu$ sec

NPN triple diffused silicon transistors. Packaged in solid copper cases conforming to JEDEC TO-3 outline dimensions.

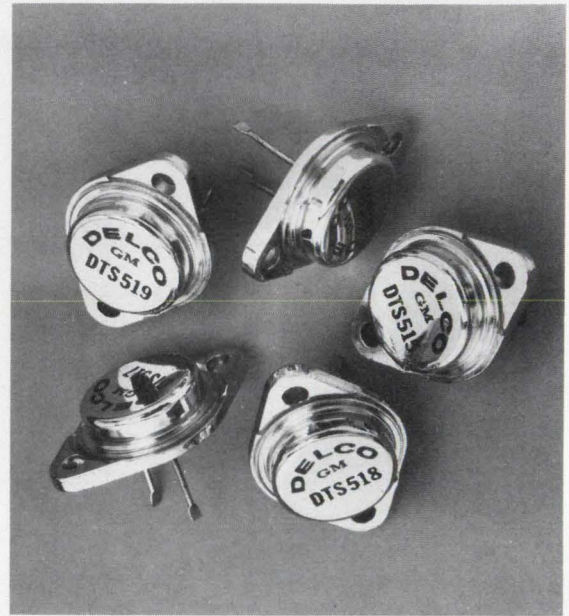

Our newest high-energy silicon power transistors have increased capabilities over our earlier types in current ratings, gain and switching speeds. These improvements were achieved without sacrificing the useful peak power handling capacity that is characteristic of Delco's transistors.

Fall time of these transistors is typically 0.25 microseconds. Their biggest advantage, however, is their high current gain as shown on the accompanying beta curves.

A new characterization feature offered with the DTS-515 series is a graph of capabilities for reverse bias clamped inductive switching. Parameter variables, dealt with in the graph, are voltage, collector current, temperature, and forward and reverse base current. As can be seen in the

" $V_{BE}(\text{reverse}) \geq 5V$ " notation, emitter diode avalanche is recommended under certain conditions.

And, of course, these high-energy silicon power transistors come in Delco's solid copper TO-3 packages to ensure low thermal resistance.

The accompanying curves, charts and circuits tell part of the story. Prices, applications literature and electrical data from your nearest Delco sales office or Delco distributor can supply another part.

But the most important part of the story is how well these new transistors function in your applications.

You can order them today; they're in stock at your Delco distributor's.

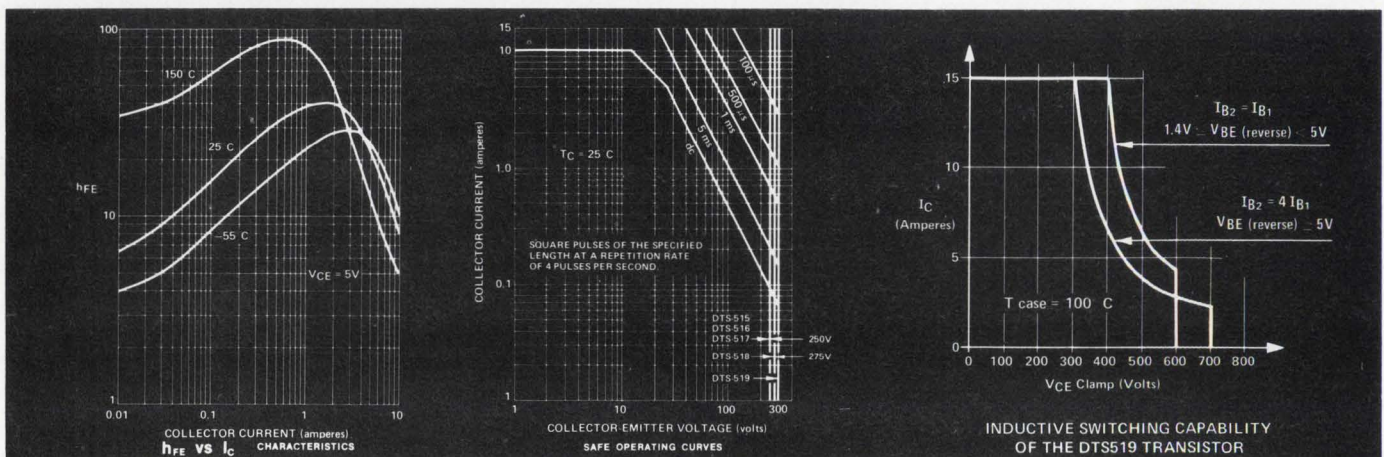

# TER SWITCHING, TORS NOW IN STOCK.

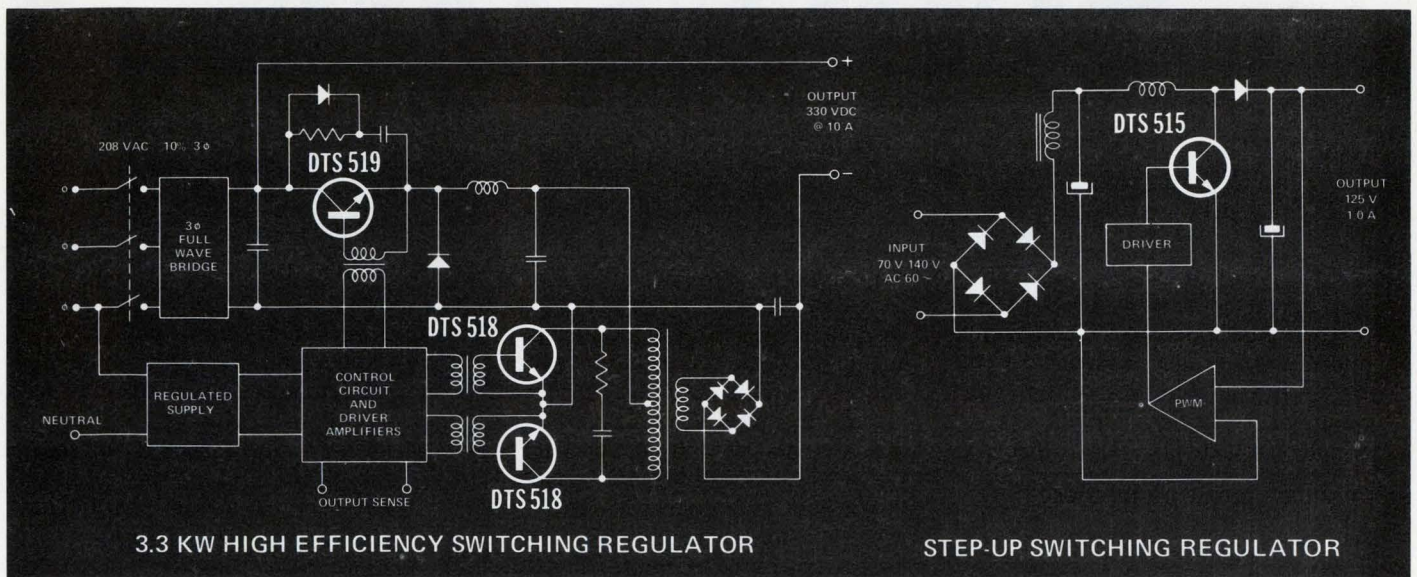

3.3 KW HIGH EFFICIENCY SWITCHING REGULATOR

STEP-UP SWITCHING REGULATOR

NOW AVAILABLE FROM THESE DISTRIBUTORS IN PRODUCTION QUANTITIES.

**ALABAMA, Birmingham**  
Forbes Distributing Co., Inc.  
(205) 251-4104

**ALABAMA, Huntsville**  
Powell Electronics  
(205) 539-2731

**ARIZONA, Phoenix**  
Sterling Electronics, Inc.  
(602) 258-4531

**CALIFORNIA, Gardena**  
Bell Industries  
Electronics Distributors Div.  
(213) 321-5802

**CALIFORNIA, Goleta**  
R.P.S. Electronics, Inc.  
(805) 964-6823

**CALIFORNIA, Los Angeles**  
Kierulff Electronics, Inc.  
(213) 685-5511

**CALIFORNIA, Los Angeles**  
R.P.S. Electronics, Inc.  
(213) 748-1271

**CALIFORNIA, Palo Alto**  
Kierulff Electronics, Inc.  
(415) 968-6292

**CALIFORNIA, San Diego**  
Kierulff Electronics, Inc.  
(714) 278-2112

**CALIFORNIA, San Diego**  
R.P.S. Electronics, Inc.  
(714) 292-5611

**CALIFORNIA, Sunnyvale**  
Bell Industries  
(408) 734-8570

**COLORADO, Denver**  
Kierulff Electronics, Inc.  
(303) 371-6500

**CONNECTICUT, Norwalk**  
Harvey Electronics  
(203) 853-1515

**FLORIDA, Clearwater**  
Diplomat/Southland  
(813) 443-4514

**FLORIDA, Miami Springs**  
Powell Electronics/Florida  
(305) 592-3260

**ILLINOIS, Elk Grove Village**  
Kierulff Electronics, Inc.  
(312) 640-0200

**ILLINOIS, Skokie**  
Bell Industries  
Electronics Distributors Div.  
(312) 282-5400

**INDIANA, Indianapolis**  
Graham Electronics Supply, Inc.  
(317) 634-8202

**MARYLAND, Baltimore**  
RESCO/Baltimore  
(301) 823-0070

**MARYLAND, Beltsville**  
RESCO/Washington  
(301) 937-5890

**MASSACHUSETTS, Billerica**  
Kierulff Electronics, Inc.  
(617) 935-5134  
(617) 667-8331

**MASSACHUSETTS, Newton**  
The Greene-Shaw Co., Inc.  
(617) 969-8900

**MICHIGAN, Livonia**  
Pioneer/Michigan  
(313) 525-1800

**MINNESOTA, Minneapolis**  
Stark Electronics Supply Co.  
(612) 332-1325

**MISSOURI, Kansas City**  
Walters Radio Supply, Inc.  
(816) 531-7015

**MISSOURI, St. Louis**  
LCOMP-St. Louis  
(314) 647-5505

**NEW JERSEY, Cinnaminson**  
Wilshire Electronics/Philadelphia  
(609) 786-8990 (215) 627-1920

**NEW JERSEY, Clifton**  
Wilshire Electronics/New Jersey  
(201) 340-1900 (212) 244-8930

**NEW MEXICO, Albuquerque**  
Sterling Electronics  
(505) 345-6601

**NEW YORK, Binghamton**  
Harvey Electronics  
(607) 748-8211

**NEW YORK, Buffalo**  
Summit Distributors, Inc.  
(716) 884-3450

**NEW YORK, Farmingdale**  
Wilshire Electronics/Long Island  
(516) 293-5775

**NEW YORK, Freeport**  
Milgray/New York  
(516) 546-6000

**NEW YORK, Woodbury**  
Harvey Electronics  
(516) 921-8700 (212) 895-9260

**OHIO, Cincinnati**  
United Radio, Inc.  
(513) 761-4030

**OHIO, Cleveland**  
Pattison Supply Co.  
Industrial Electronics Division  
(216) 441-3000

**OHIO, Dayton**  
Pioneer/Dayton  
(513) 236-9900

**PENNSYLVANIA, Philadelphia**  
Almo Electronics  
(215) 698-4000

**PENNSYLVANIA, Pittsburgh**  
CAM/RPC Electronics  
(412) 288-2600 (412) 782-3770

**SOUTH CAROLINA, Columbia**  
Dixie Radio Supply Co., Inc.  
(803) 253-5333

**TEXAS, Dallas**  
Sterling Electronics  
(214) 357-9131

**TEXAS, Houston**  
Harrison Equipment Co., Inc.  
(713) 652-4700

**TEXAS, Houston**  
Sterling Electronics  
(713) 627-9800

**WASHINGTON, Seattle**  
Kierulff Electronics, Inc.  
(206) 763-1550

**IN CANADA:**  
Zentronics Ltd.  
Toronto (416) 787-1271  
Ottawa (613) 238-6411  
Montreal (514) 735-5361

**OVERSEAS:**  
**EUROPEAN INQUIRIES:**  
European Parts & Accessories  
Marketing Group  
General Motors Continental  
Plant 2, Noorderlaan, Postbus 9  
B-2030 Antwerp, Belgium

**ALL OTHER OVERSEAS INQUIRIES:**  
General Motors Overseas  
Operations  
Parts & Accessories Dept.  
767 Fifth Avenue  
New York, N.Y. 10022  
(212) 486-4412

**Delco Electronics Regional Sales Offices**  
Charlotte, North Carolina 28209  
4600 Park Road  
(704) 527-4444  
Van Nuys, California 91404  
Box 2968  
(213) 988-7550

**General Sales Office**  
700 E. Firmin, Kokomo, Ind. 46901  
(317) 459-2175

## Delco Electronics



Division of General Motors

CIRCLE NUMBER 32

# LED SUPERSTARS

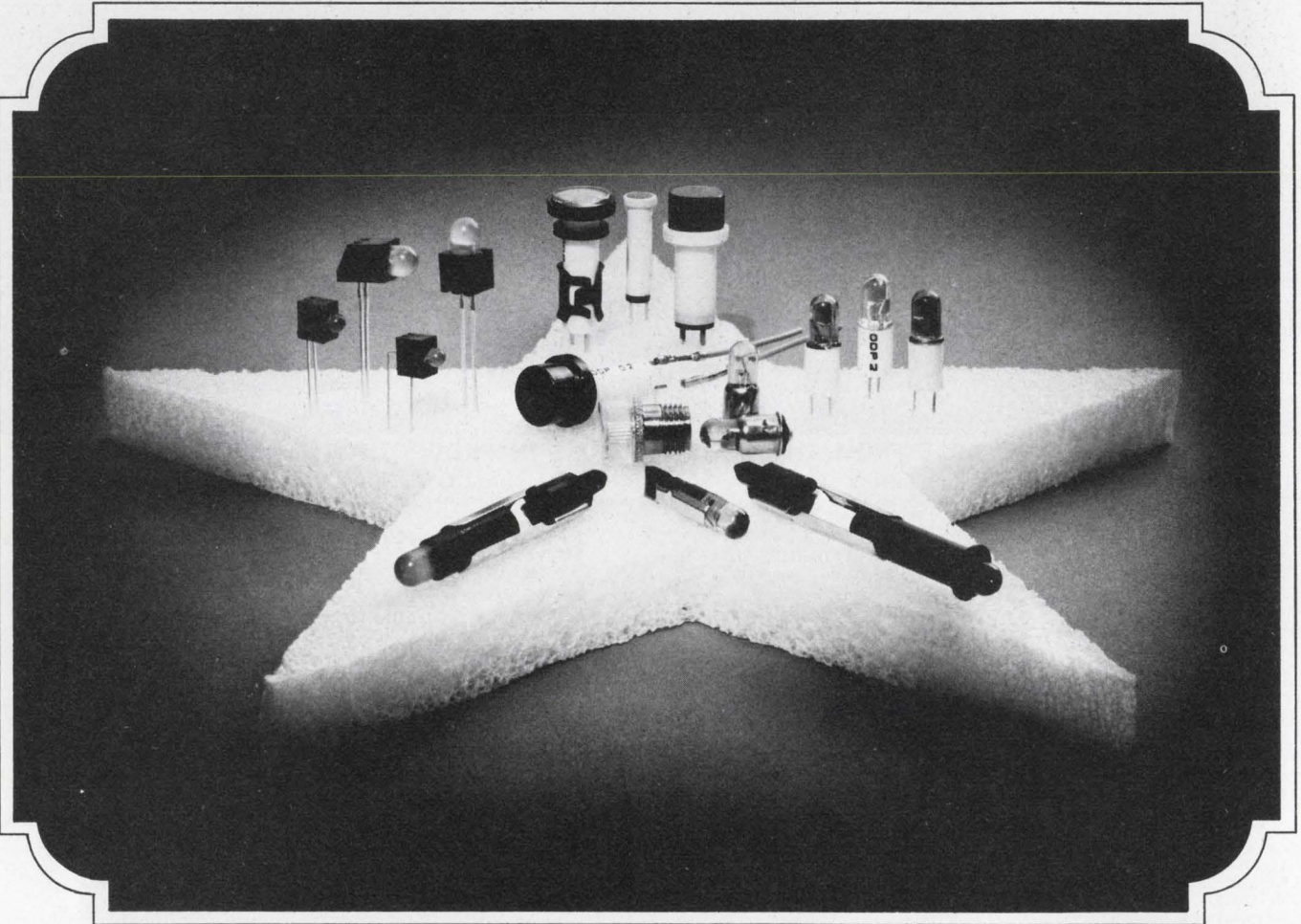

## As bright as many incandescents!

Meet the LED Superstars . . . red, amber and green superbright panel and PCB lights. Their high brightness 50 MCD @ 20 MA (typical clear red) make them **the** perfect cost and power saving replacements for incandescents. Available with built-in resistors for all popular voltages.

**Subminiature Panel LED's** (also suitable for PCB mounting)—available in hundreds of sizes, shapes and styles.

**PCB LED's**—Horizontal or vertical viewing . . . optional built-in resistor for 5V applications.

**Bi-Pin (T1- $\frac{3}{4}$ ) LED's**—Ideal for dead front panel applications, e.g. DEC's PDP Series computers.

**Midget-Flanged (T1- $\frac{3}{4}$ ) LED's**—Direct replacements for incandescents in panel light and switch applications.

**Replacement Lenses**—Specifically designed for use with Midget-Flanged LED's.

**Slide Base LED's**—Direct replacements for incandescent types.

There's lots more too, and they're all Superstars! Send for our Catalog today: Data Display Products, 5428 W. 104th Street, Los Angeles, Ca. 90045, (213) 641-1232.

Produced by the original "little light" people.

**DATA DISPLAY PRODUCTS**



# Washington Report

## Coast Guard gets more sea to patrol

The Coast Guard, which nominally patrols the sea inside the 12-mile limit, is going to have a lot more ocean to cover now that the President has signed a bill to extend the nation's fishing boundaries out to the 200-mile mark.

The relatively tiny service will have to enforce fishing and—possibly—mining bans, so more ships and aircraft will be required. Accordingly, the House of Representatives recently passed a \$304-million procurement authorization for Fiscal Year 1977 that included \$109 million more than originally asked for by the Administration.

The House added funds for six long-range surveillance aircraft and five shorter-range patrol aircraft, four side-looking radars for the present C-130 patrol planes, and two additional cutters.

## Test-before-buy procedures are questioned

The fly-before-buy concept now in favor at the Pentagon may be in for modification because of the growing length of time it takes to get a weapon from the drawing board into the hands of the troops.

Dr. Malcolm Currie, DOD director of defense research and engineering, says that in some cases the acquisition cycle "borders on the absurd" because there is too much emphasis on test and evaluation.

Some of our test programs do require a production run to support them, he says, but some testing goes on just to be able to construct statistical curves rather than because such testing is adequate and reasonable.

## Obstacles to big defense budget fade

To the shock and chagrin of liberals in Congress, the Ford Administration's defense budget is sailing along in unexpectedly calm seas. A few months back there was the probability of a \$5 to \$7-billion cut, but Congress is now convinced there is a serious shift in America's military balance with the Soviets.

The first concrete evidence of the change in opinion came when the House added \$700 million in spending authority to the Administration's procurement request, bringing it to a total of \$33.4 billion. This was a \$1.2-billion increase to the \$21.8 billion requested for hardware procurement and a \$498-million cut from the \$10.8 billion wanted for research, development, test and evaluation. The major beneficiary is the Navy's shipbuilding program, which receives \$1.08 billion more than the DOD requested for fiscal year 1977, which begins on Oct. 1.

Unsuccessful efforts were made to trim the B-1 production authoriza-

tion, delete funds for attack submarines, and to cancel a new carrier. Existing cuts were spread over some 1000 programs and few were fatal. The Army lost its aerial scout helicopter program for now, and the Navy its Shipboard Intermediate Range Combat System (SIRCS).

The House agreed to \$474.7 million for the purchase of six E-3A airborne-warning-and-control-system (AWACS) aircraft, but the Air Force can't spend the funds until a favorable decision is made by NATO members to buy the system too.

Not only has the President clearly sounded a warning that he will veto any bill that reduces defense expenditures, but the Defense Dept. is reportedly planning a whopping supplemental bill. Some \$475 million may be requested to build more Minuteman 3 missiles and upgrade older Minuteman missiles to counter the rising number of Soviet ICBMs.

## **FCC allows exhibit of nonapproved products**

The Federal Communications Commission has retreated slightly from its tough rule banning the display or showing of nonapproved electronic products at trade shows.

Now the FCC will allow the display of noncertified devices at industry trade shows not open to the general public if the displays are clearly marked: "This device has not been approved by the Federal Communications Commission. This device is not, and may not be, offered for sale or lease, or sold or leased."

The Electronic Industries Association, which led the fight for a relaxation of the rule for trade shows, told the FCC in a petition that in the government's zeal to protect the consumer, it is not only cutting industry profits, but is increasing the FCC staff workload and forcing up the price of products.

Prior to this rule change the FCC had cited six manufacturers of home video games for violations. In the future, these products can be shown at industry trade shows not open to the general public.

**Capital Capsules:** Foreign military sales are likely to be in the \$8-billion to \$10-billion range annually for the next decade, predicts Deputy Secretary of Defense William Clements. . . . The Navy says that **New Mexico and Nevada are still in the running for the Seafarer ELF site, although Michigan apparently is considered for the first choice.** The system for communication with submarines is far from finding a home. The initial rebuff came from Wisconsin, where the Navy wanted to install Sanguine, the underground version. . . . The Electronic Industries Association has **a new two-level, 12-digit designation system for microelectronic devices.** The EIA says it is designed to be compatible with the Pro-Electron System that's been in use in Europe for several years. The new system also complements the existing program for registering discrete semiconductor devices that is in universal use today. . . . **The Renegotiation Board's plan to close down its two regional boards located in Los Angeles and Washington, DC, supposedly in the interest of economy, has been shelved.** An angry letter from Rep. Jack Brooks (D-TX), chairman of the House Government Operations Committee, insisted that any reorganization should await the outcome of legislation now pending that either passes and extends the life of the agency or allows the board to die. Industry, of course, is rooting for the latter. The House has passed a bill that would alter the board slightly, and make it permanent. The board's mandate is to make industry refund "excess" profits from Government contract work.

# ANNOUNCING

A 40 MHz function generator  
you can phase lock,  
am, fm, log or linear sweep, and more.

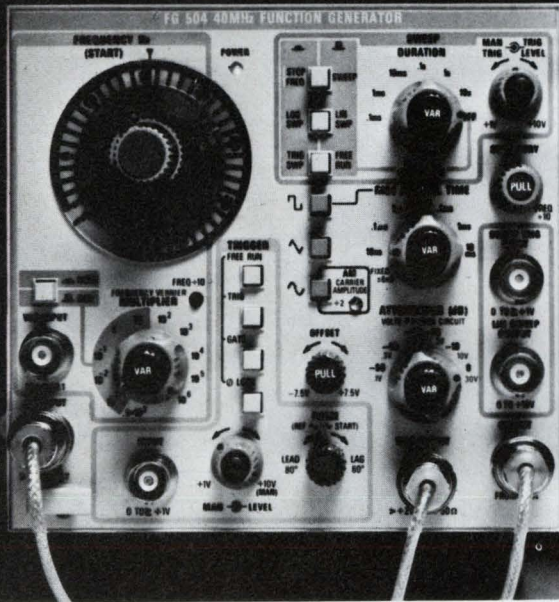

## The TEKTRONIX FG 504

In its phase lock mode, the new FG 504 Function Generator will capture and track a periodic signal, such as a logic pulse or house standard frequency, letting you synchronize the generator's output or convert from one waveform to another. Its am input circuitry senses the presence of an applied modulating signal and reduces the output amplitude by one-half, allowing 100% upward modulation without adjusting the amplitude control. It can be frequency modulated, and it can be swept with its built-in logarithmic or linear sweep. Concentric knobs set the frequency start and stop points.

**Frequency range: 0.001 Hz to 40 MHz • up to 6 ns rise/fall time • 3 basic waveforms • a wide range of pulse shaping with variable rise and fall and symmetry controls • up to 30 V p-p output • built-in attenuator • post-attenuator offset • external and manual trigger or gate.**

In the phase lock, trigger, or gate modes, a phase control shifts the output of the FG 504, so that you can create setups such as a bi-phase clock. A capable instrument for driving logic circuits, the FG 504 is a "clean," 50  $\Omega$  source of pulses to less than 20 ns wide and up to 30 V p-p. Post-attenuator offset enables

use of the full  $\pm 7.5$  V offset range with small signals.

The FG 504 features independent push-button selection of many of its operating modes, so you are not limited to typical "either-or" decisions. Special modes of operation can be set up through independent or simultaneous use of such functions as AM, VCF (fm), SYMMETRY, VAR RISE and FALL, SWEEP, Waveform HOLD, and TRIGGER or GATE or PHASE LOCK.



*Order FG 504T (\$1350) for a stand-alone instrument operable from 100-240 Vac, 48-440 Hz.*

For example, the FG 504 may be operated as a free-running burst generator by using the LIN SWEEP OUTPUT to gate the main

generator. With the generator in the SWEEP mode but the START and STOP frequencies set the same, the actual sweep will be zero. Adjusting the trigger level controls the length of the burst. SWEEP DURATION controls the period between bursts.

A special range allows the audio engineer to sweep from 20 Hz to 20 kHz, or a single internal capacitor may be replaced to change the start and stop points.

And dynamic reaction of AGC, squelch, or amplitude-sensitive circuits such as Dolby systems are easy to test with the FG 504 in a square wave or pulse am mode that varies the output between two different levels.

*Order FG 504 (\$1200) for a plug-in instrument that operates in any multi-compartment TM 500 mainframe power module.*

For further information or a demonstration of the FG 504 and TM 500 Instrumentation, write or phone: Tektronix, Inc., P. O. Box 500, Beaverton, Oregon 97077, (503) 644-0161 ext. 5542. In Europe: Tektronix Limited, P. O. Box 36, St. Peter Port, Guernsey, Channel Islands. U.S. Sales Prices FOB Beaverton, Oregon



**TEKTRONIX®**  
committed to  
technical excellence

FOR TECHNICAL DATA CIRCLE #241  
FOR DEMONSTRATION CIRCLE #242

# Let's talk about the easy way for you to spot microprocessor hardware problems.

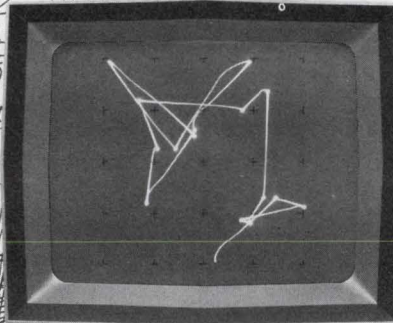
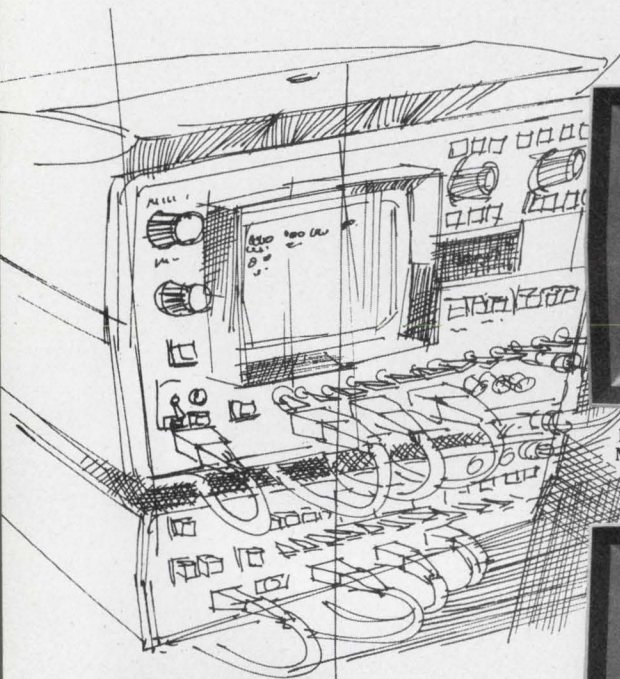

HP's 1600S Logic State Analyzer, in the MAP mode, lets you examine the unique "fingerprint" of every logic system.

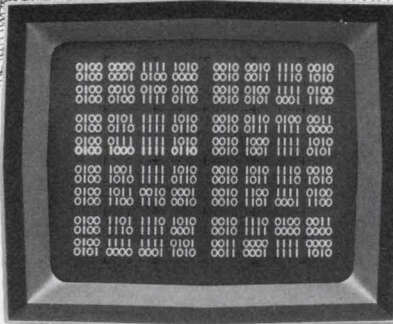

In the TABLE mode, the 1600S displays up to 16 32-bit words. These words could be combinations of addresses, instructions or states of the control lines.

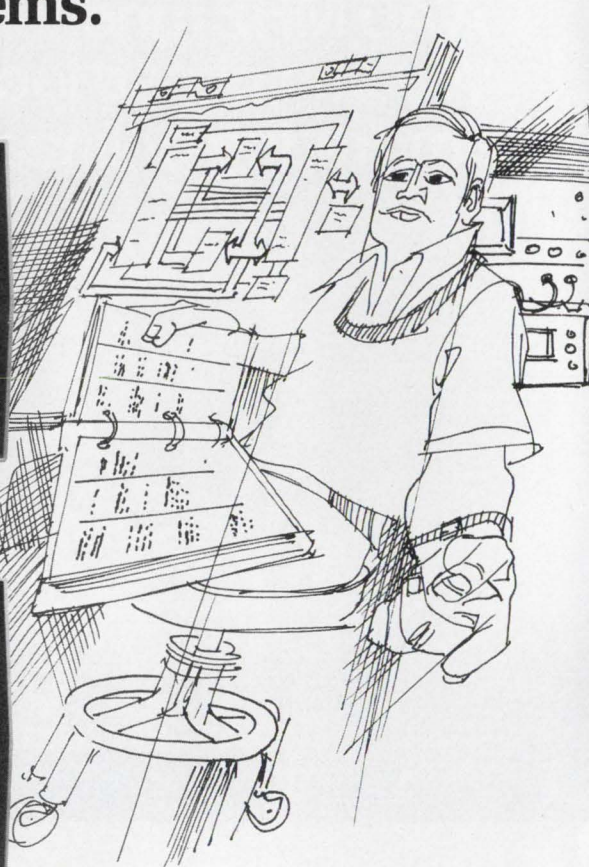

We've probably both spent hours at the simulator to prove we had good software and then discovered

the hardware won't play — what do we do? You know the traditional answer. Dig out the scope, get out the program printout, and brace yourself for hours of grinding, point-by-point checks. But I can tell you that doesn't have to be the case. Especially now that HP has introduced some new tools that can really cut down your troubleshooting time.

HP's Logic State Analyzers can really take a lot of pain out of your troubleshooting procedures. You'll find wiring errors, defective components, and even solder splashes; and you'll find them a lot more quickly than ever before.

Let me give you an example. We had an eight-bit microprocessor system with start-up problems. The clocks were running and phased right, and the address lines toggled, but the machine didn't function. So, we

set up an HP 1600S Logic State Analyzer to look at both the Address and Data buses. It was then we noticed that only "zeros" were being fetched from memory. Knowing the ROM was good, we then added several control lines to the display and the problem showed up immediately. The "Enable" line never went high. A quick look at the "Enable" driver showed the input was ok, but no output. Obviously, the gate was defective.

I don't know how long it would have taken to find that one without HP's Logic State Analyzers, but I know it would have taken us a lot longer.

Call your local HP field engineer. He'll give you all the details on the 1600S (priced at \$6800\*) including spec sheets and application notes detailing the use of mapping for troubleshooting minicomputer and microprocessor systems. He'll tell

you about the seminars that HP has arranged around the country and tell you when one will be held in your area and how you can attend. You ought to go to one, because you'll discover an exciting new concept in digital troubleshooting.

\*Domestic U.S.A. price only.

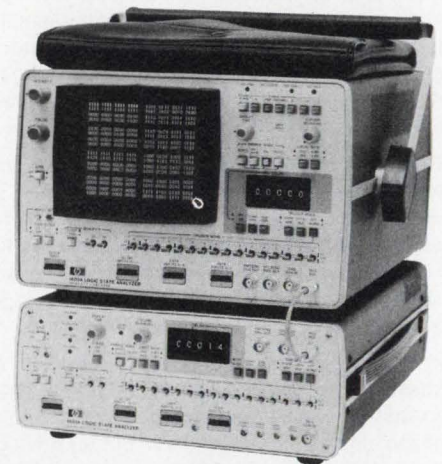

HEWLETT  PACKARD

Sales and service from 172 offices in 65 countries.  
1501 Page Mill Road, Palo Alto, California 94304



## Now our expandable line offers DC to 4 million bits per second!

We offer PCM capability, in addition to Direct and FM electronics, in three of our recorder/reproducers. There's the 7 to 14 channel Sabre III and the 28/32 channel Sabre V, both IRIG all-band portable recorders; and the Sabre IV, a 7 to 48 channel laboratory recorder/reproducer.

In addition our line includes the new Sabre VI which offers superior performance plus ultra-portability, and the Tandberg TIR-115, a 4-channel, FM, 25-pound system.

Those basic five recorders are actually an almost unlimited line because each is designed and built to adapt to an amazing variety of functions. Just tell us what you want one to do!

For information write: Sangamo Electric Company, Data Systems Division, P.O. Box 3347, Springfield, Illinois 62714. Area Code 217, 544-6411. Telex 406-461. Sales and service representatives worldwide.

**SANGAMO RECORDERS**  
THE INNOVATORS IN TAPE INSTRUMENTATION

# MARK IV CONNECTION SYSTEM

## It lowers your total installed cost.

Want to save on assembly time? Increase production? Buy in bulk? Reduce inventory? Simplify tooling? They're your system's real costs—your total installed cost—and we can cut them with our new flame-retardant plastic, UL-recognized Burgun-D Mark IV D Subminiature Connection System. It's a whole, low-cost, reliable production system built around our universal Burgun-D.

Crimp, removable contacts • Printed-circuit contacts, straight or 90° • Screw machine or stamped contacts • Semi-automatic strip and crimp—crimp



machine: 1500-2000 contacts per hour • 5 different connector sizes • 9, 15, 25, 37, 50 contact arrangements • #20-#30 wire sizes • Rugged metal shells • Complete accessories • Intermateable, interchangeable, intermountable, layout for layout with

all D Subminiatures • Available at any authorized Cannon distribution center throughout the world.

Applications: computer peripherals; data machines; telecommunications; machine tools; consumer electronics.

Send for our "Cannon Cost Cutters" brochure today. ITT Cannon Electric, 666 East Dyer Road, Santa Ana, Calif. 92702. **Toll-free, 24-hr (800) 854-3573;** in Calif., **(800) 432-7063.**



Six decades on the leading edge of interconnect technology.

**CANNON ITT**

# Microprocessor Design

## ECL bit-slice processor arrives, setting top speed for bipolar $\mu$ Ps

The fastest bit-slice microprocessor—Motorola's long-awaited M10800 ECL family—cuts instruction-execution time to as little as half that of other bipolar versions. In a 16-bit system, the MC10800 4-bit slice takes only 62 ns to execute a micro-instruction. Present processor slices employ TTL and require much longer times (see news story this issue, p. 34).

Besides the MC10800 arithmetic-logic unit (ALU), the family consists of the MC10801 microprogram-control function, the MC10802 timing circuit and the MC10803 memory interface. All members of the family are fully compatible with the company's high-speed MECL 10,000 logic line. Hence any circuit in the series—especially memory circuits—can be used in conjunction with the new circuits from Motorola (P.O. Box 20294, Phoenix, AZ 85036. 602-244-3465).

The ALU circuit requires an external register file, in contrast to TTL versions like Advanced Micro Devices' Am2901, which has an internal file. Although the requirement increases package count, the external memory can be built to any size and configuration. Also, unlike the

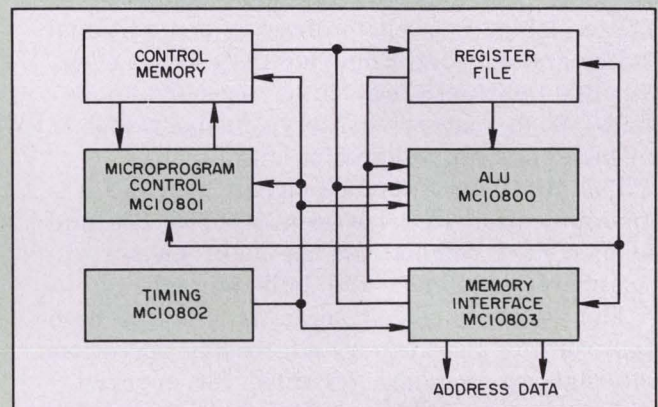

Am2901, the slice performs both BCD and binary arithmetic.

The MC10800 performs all logic operations and does both logic and arithmetic shifting. It contains an accumulator for temporary storage, and a special mask network that allows bit manipulation—an important feature for controller applications. Status bits are provided to allow branching in the main program or in the microprogram.

The MC10801 control circuit provides the addressing and sequencing logic needed to

*(continued on page 54)*

### Next in kits: do-it-yourself PROM programmers

Not only do microcomputers come in kit form. Now PROM programmers can be put together from kits offered by Cramer Electronics (85 Wells Ave., Newton, MA 02159. 617-969-7700).

The 2708/2704 EPROM Programmer Cramerkit contains all the components, software and design documentation needed to build a self-contained programmer for the popular 2708 (1 k  $\times$  8) and 2704 (512  $\times$  8) erasable EPROMs. All timing requirements of the EPROM are handled by the hardware, minimizing the required software and simplifying connection of the kit to virtually any system.

The kit is available for immediate delivery for only \$99.95. With a special customized Augat board, the cost is \$129.95. The kit was developed in conjunction with Microcomputer Techniques, Reston, VA.

Booth No. 1510-1530

Circle No. 502

## MICROPROCESSOR DESIGN

*(continued from page 53)*

operate the microprogram memory. It also generates a series of next-address instructions, thereby easing the burden of writing the microprogram code. Like the ALU slice, it can be cascaded and as a result, can handle virtually any memory size. A single MC10801 can address 256 words; three of the circuits can handle 4-k words.

Contained within the MC10801 are various registers for status, instruction and address; a last-in first-out stack; and an incrementer. Built-in logic provides 16 instructions, any one of which can generate the next address. These instructions allow direct and conditional jumps and subroutines. One instruction even permits multipath-branching decisions to be made. Such features conserve memory and save on medium-scale-integration circuits.

The MC10803 interface circuit provides a communication link between M10800 ICs and such system components as main memory, peripheral terminals and bulk storage.

The interface circuit contains logic for both data routing and memory-addressing operations. Internal registers are provided for memory address, memory data, program counter, stack pointer and other memory-related functions. Seventeen data-transfer instructions can be used to route information between different registers and I/O ports. The interface circuit may be operated in parallel with the ALU slice to enhance system speed.

The MC10802 circuit handles various timing

chores, such as starting and stopping the processor. It has a reset capability and generates up to four clock phases. A larger number can be obtained by cascading several circuits. Also offered in the MC10802 is a diagnostic capability for running through a program one step at a time. Thus the timing circuit offers a means to perform program debugging and even system checkout.

All M10800 circuits operate from MECL 10,000 supplies of  $-5.2$  and  $-2$  V and over the  $-30$ -to- $85$ -C temperature range. Typical operating dissipation for the ALU circuit is 1.4 W. Other circuits in the family need about the same amount of power.

This high dissipation is handled by a special quad in-line (QUIL) package that has a maximum rating of 2 W. Developed especially for the M10800 family, the QUIL package takes up about the same board space as a standard 24-pin DIP, but the QUIL's 48 pins are arranged in four rows of 12 pins each. The package is compact and wire-wrappable.

Initial shipments of the M10800 family will come with sockets for the QUIL packages. The MC10800 slice is available now at a price of \$75 in single-unit quantities and \$50 in hundred-up quantities. Other members of the family are similarly priced. The MC10801 will be available in August, and the MC10802 and MC10803 in October.

Motorola plans to expand the family by introducing special circuits to interface with TTL systems, but the initial offering will be the nucleus of any future system.

CIRCLE NO. 501

---

## \$295 $\mu$ C-on-board aims to satisfy most requirements

A single board measuring just  $6.75 \times 12$ -in. provides the computing power, memory storage and I/O facilities needed for the bulk of OEM-processing and equipment-control applications. Moreover, the new 8080-based SBC 80/10 from Intel (3065 Bowers Ave., Santa Clara, CA 95051. 408-246-7501) costs only \$295 in quantities of 100.

The SBC 80/10's versatility stems from its programmable parallel and serial I/O, which allows designers to use the same single-board

$\mu$ C in different equipment by simply changing six or less program instructions and plugging in appropriate line drivers and terminators.

The board's central processor subsystem includes an 8080A  $\mu$ P, interrupt control, crystal-stabilized system clock system bus control (intraconnection control logic) and high-current drivers for memory expansion.

Memory consists of 1 kbyte of static RAM and up to 4 kbytes of ROM. Sockets on the board can

*(continued on page 56)*



Point by point,  
line by line:

## See why our lowest-cost Graphics package has no competition.

**Our 1024 X by 780 Y viewable points separate Graphics from mere graphing.** The price has never been lower. But Tektronix' new 4006-1 provides the same superior information capacity that has made us the company for all your graphics needs.

**We'll throw you a curve.** Tektronix will graph circles around the competition. Now, thanks to our new low priced 4006-1, we're in the same ballgame with mere alphanumeric terminals.

**Graphics to gain. Nothing to lose.** Add the graphics extra at an everyday price: \$2995 or \$150 a month on a two year lease. Alphanumerics? Up to 2590 on screen characters. Plus a spectacular package that includes confirmed compatibility with most mainframes through proven interfaces and time-tested software packages. And expert maintenance that follows you all over the world.

**Plug-in peripherals standing by.** Like our 4631 Hard Copy Unit for up to four 4006-1's with 8½"x11" copies, or

4923 Digital Cartridge Tape Recorder for low-cost, off-line storage.

**Why wait for graphics? Let graphics wait on you.** See what our fine-line, full-line graphics can mean for your applications. Check out the whole story and all the prices right now with your local Tektronix Sales Engineer. Or write:

Tektronix, Inc.  
Information Display Group  
P.O. Box 500  
Beaverton, Oregon 97077



CIRCLE NUMBER 38

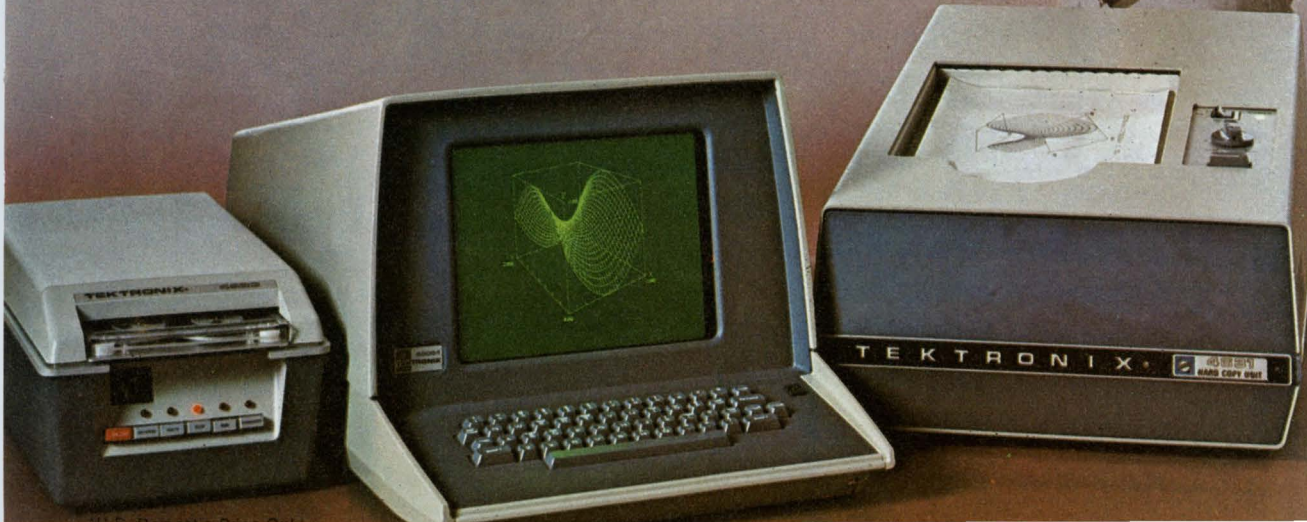
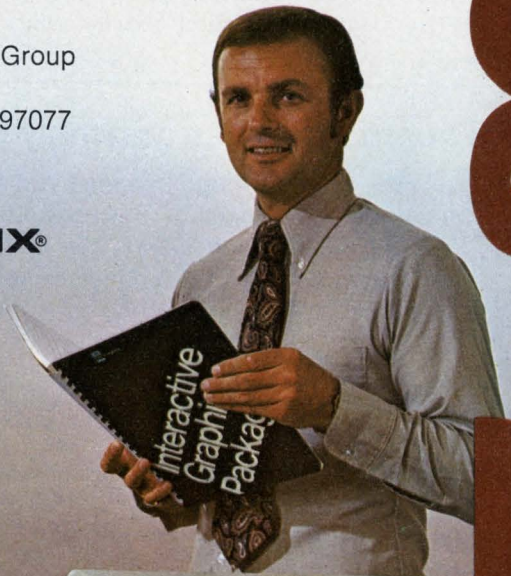

Graphics  
\$2995

## MICROPROCESSOR DESIGN

(continued from page 54)

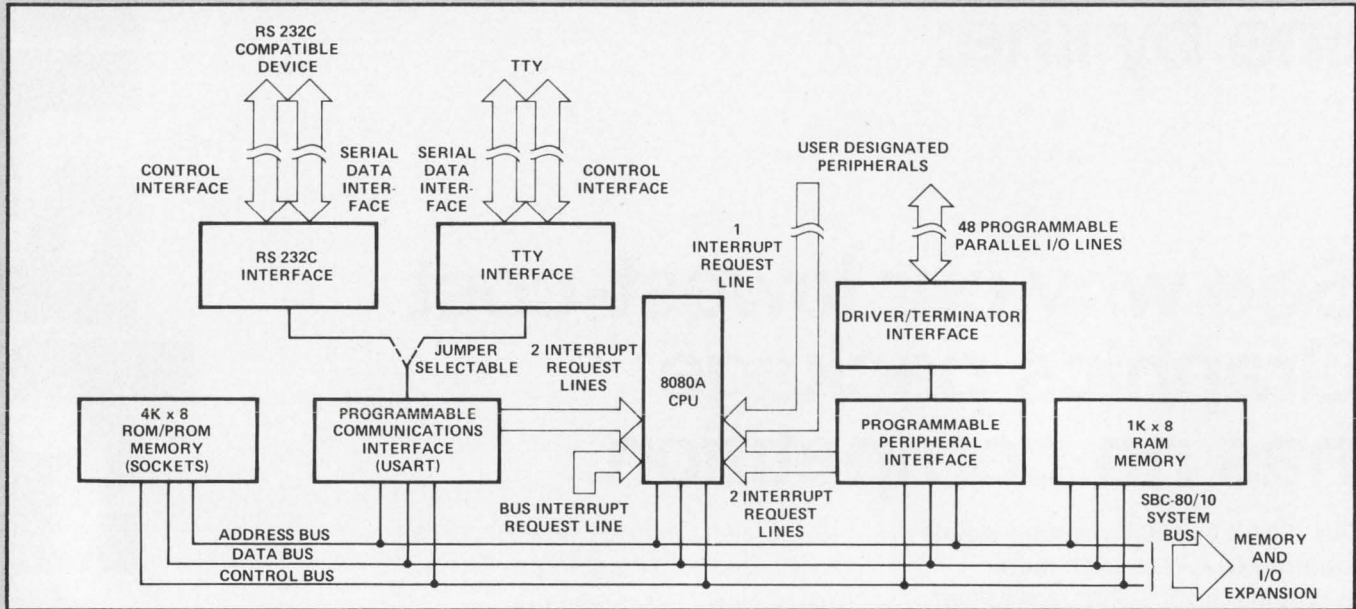

be used to plug in up to four optional 1-kbyte EPROMs, or interchangeable 1-kbyte masked ROMs.

The parallel I/O features 48 lines organized as six programmable, eight-line I/O ports. Sockets for line drivers and terminators provide a means to establish the desired electrical characteristics.

The serial I/O features a programmable USART (universal synchronous/asynchronous receiver/transmitter), standard data-communication interfaces (RS232C and teletypewriter) with built-in drivers and receivers, and a variable baud-rate generator.

CIRCLE NO. 503

## Custom board simplifies assembly of 8080A kit

With a wire-wrappable socket board, assembly time for the Intel 8080A Cramerkit can be reduced to a matter of minutes. Offered by Cramer Electronics (85 Wells Ave., Newton, MA 02159. 617-969-7700), the board sells for \$275 to \$325. The custom board is manufactured exclusively for Cramer by Augat, Attleboro, MA.

Booth No. 1516-1530

Circle No. 504

## Component tester speeds checkout of 6800 family

Users of Motorola's Exorciser development system can now employ an external component tester to speed incoming inspection of 6800 circuits.

The MEX68CT tester from Motorola (P.O. Box 20294, Phoenix, AZ 85036. 602-244-3465) consists of a "mother" board and a series of special "personality" boards and test programs that evaluate the following circuits: 6800  $\mu$ P, 6820 peripheral-interface adapter, 6850 asynchronous communications-interface adapter, and the family's 6810 RAM and 6830 ROM. Moreover, Motorola says that forthcoming boards and programs will be able to test popular micro-computer components now offered by other manufacturers.

To test a circuit, a user first connects the

circuit's personality board to the mother board, which is then hooked up to the Exorciser. The circuit's test program is entered in the Exorciser. Next the user simply installs the device to be evaluated in the tester, presses a Test switch and obtains a good/fail indication.

One Exorciser system controls up to eight testers, and power for the testers may be obtained from the development system or from an external source. Optional features include foot-switch control and extender cable for environmental testing in special chambers.

The mother board plus Exorciser-interface card cost \$1500. Individual personality boards range in price from \$175 to \$260. Delivery is from stock.

CIRCLE NO. 505

# Six great features these two popular trimmers have in common:

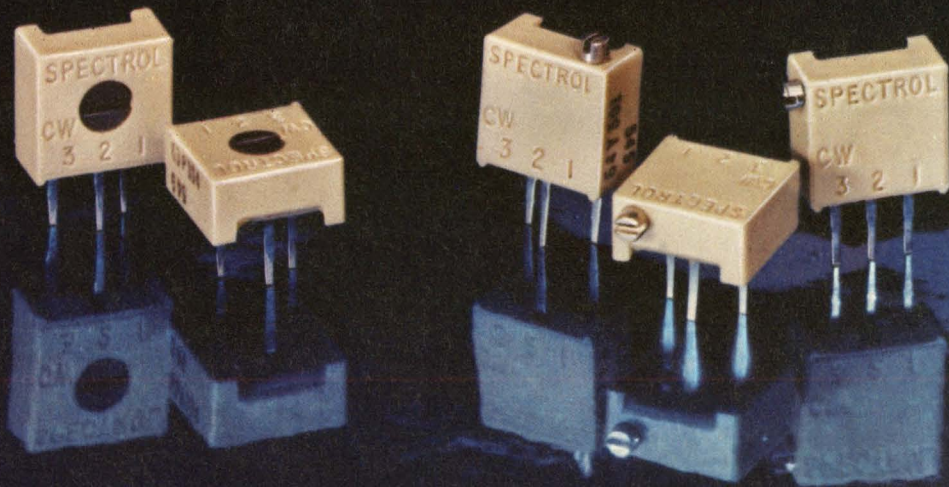

## The Model 63 3/8" Singleturn Cermet

## The Model 64 3/8" Multiturn Cermet

1. Soldered terminations for reliability.
2. Superior design for excellent setability—virtually no spring-back in the singleturn or backlash in the multiturn.
3. Eight multiturn configurations interchangeable with singleturn pin styles for flexibility.
4. Brush wiper design for low CRV.
5. O-ring seal for board wash.
6. Low cost.

Available from local distributor stock. Send for a data sheet or call for a quote. Ask about a free sample.

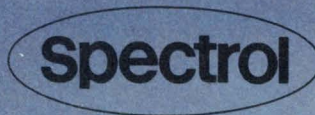

### SPECTROL ELECTRONICS GROUP

**UNITED STATES** Spectrol Electronics Corporation 17070 E. Gale Avenue, City of Industry, Calif. 91745, U.S.A. • (213) 964-6565 • TWX (910) 584-1314

**UNITED KINGDOM** Spectrol Reliance Ltd. Drakes Way, Swindon, Wiltshire, England • Swindon 21351 • TELEX: 44692

**ITALY** SP Elettronica S.p.A. Via Carlo Piscane 7, 20016 Pero (Milan) Italy • 35 30 241 • TELEX: 36091

Our incred  
“get rich ma

# ible, \$5 ybe” scheme.

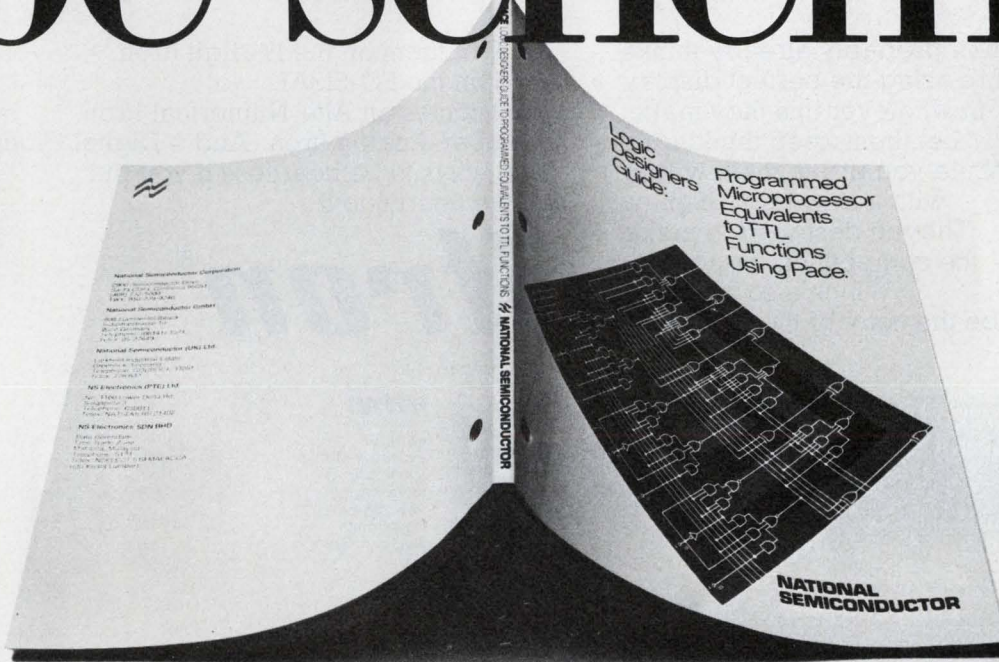

National Semiconductor Corporation  
2900 Semiconductor Drive, Santa Clara, California 95051

ED510

You clever devils:  
I think this whole thing is a scheme to get *you* rich. But here's my \$5.00, anyway.  
If the Logic Designer's Guide is as good as you say, I probably won't regret it.

Name \_\_\_\_\_ Title \_\_\_\_\_  
Company \_\_\_\_\_ Address \_\_\_\_\_  
City \_\_\_\_\_ State \_\_\_\_\_ Zip \_\_\_\_\_

It's the "Logic Designer's Guide to Programmed Microprocessor Equivalents to TTL Functions Using Pace." And it's intended to help system designers make the transition from design in hardware to design in software. Thus saving your company a lot of money, which they will probably turn over to you. Or will they?

**National Semiconductor** 

# Ise introduces five new ways to make the competition turn green.

Your competition probably already thinks they're using the perfect display in whatever it is they make. Let them keep thinking it. While you prove them wrong with a new Itron display. They're designed to make the competition turn green. Which also happens to be the color of the segments.

All 17 of them on the 17-digit Itron. All 5 on the FG-512A1. Next comes an Alfa-Numerical Itron. A Linear-Analog Itron. And a Digital Clock Itron. Five ways to be heartless if you put a little heart into it.

## *itron*<sup>®</sup>

Alfa-Numerical Display



**F6209M2**

ef = 10V  
ec = eb = 40Vp-p  
ic = 10mA-p-p  
ib = 8mA-p-p  
Wd. 205 mm  
Lg. 40 mm  
Segment 9 mm

Instruments & Large Calculator Display

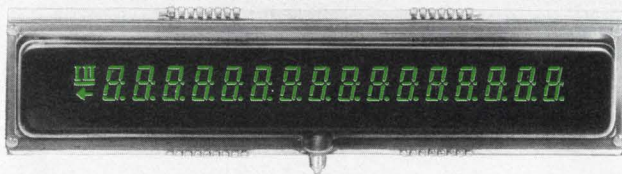

**F6179F2**

ef = 7V  
ec = eb = 35Vp-p  
ic = 7mA-p-p  
ib = 5.5mA-p-p  
Wd. 170 mm  
Lg. 40 mm  
Segment 9.5 mm

Instruments & Terminal Units Display



**F6512A1**

ef = 3.5V  
ec = eb = 24Vp-p  
ic = 4mA-p-p  
ib = 3mA-p-p  
Wd. 100 mm  
Lg. 40 mm  
Segment 12 mm

Digital Clock Display



**F6425A1**

ef = 5.5V  
ec = eb = 35Vp-p  
ic = 8mA-p-p  
ib = 6.5mA-p-p  
Wd. 140 mm  
Lg. 59 mm  
Segment 25 mm

Linear Analog Display

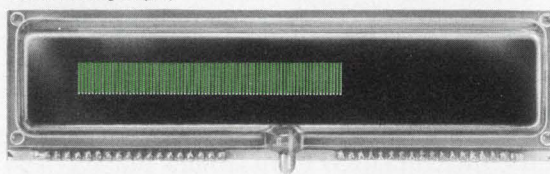

**F6120S1**

ef = 5.5V  
ec = eb = 35Vp-p  
ic = 4mA-p-p  
ib = 0.2mA-p-p  
Wd. 140 mm  
Lg. 40 mm  
Segment 8 mm

## NORITAKE CO., LTD.

### Electronics Office (U.S.A.)

22410 Hawthorne Blvd. Torrance California 90505.  
U.S.A.  
Phone: (213) 373-6704.  
Telex: "230674910"

### Electronics Division

1-1, Noritake-Shinmachi, Nishi-ku, Nagoya-City,  
Japan.  
Phone: NAGOYA (052) 561-7111.  
Telex: J59738 NORITAKE

## ISE ELECTRONICS CORP.

### London Office

c/o NORITAKE (U.K.) LTD.  
Noritake House 2, York Street W1H 1 Be, England  
Phone: (01) 935-7543 Cable: "LUCTUAL" LONDON

### Muenchen Office

c/o NEUMULLER GmbH 8 Muenchen 2, Karlstrasse 55,  
West Germany Phone: 592 421 Telex: 522106

### Hong Kong Office

Room 1403 Shing Loon Bldg  
24-26 Stanley Street, Hong Kong  
Phone: 5-232420 Telex: HX83151

### Taipei Office

72-9 SEC 2, JEN AI RD., Taipei  
Phone: 351-0293 Telex: 11176

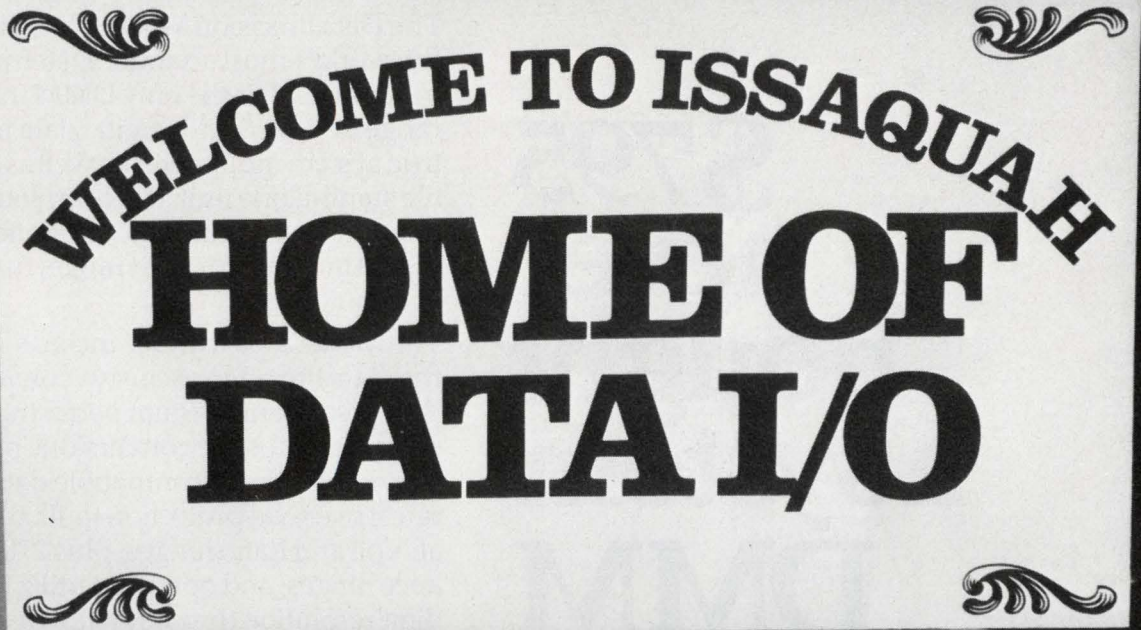

# WELCOME TO ISSAQUAH HOME OF DATA I/O

## Someday Issaquah will be famous.

Someday, people will say: "Issaquah, Washington, that's the home of Data I/O!"

But that's "someday." Today, more people remember us for our PROM programmers than for our name. We understand. After all, the 1500 companies who use our machines need programmers—not a name. So here's what's behind "Data I/O."

Our most popular programmer is the Model V. It is already out-selling every other PROM programmer in the world (including the former world champ, the Data I/O Programmer I). It can program all PROMs now available (165 at last count), and it's approved by the PROM manufacturers.

Our Programmer VI lets you program from one to eight MOS PROMs simultaneously with the same, or different, programs. (It can program an entire memory board in less than 30 seconds.)

Our new Programmer VIII is a completely portable, microprocessor based unit. You can take it anywhere and easily update it year after year.

Our Programmer X is for Programmable Logic Arrays (PLA's). It features CRT display, multiple inputs and outputs, and error detection through both logical and array verification. It's also microprocessor based.

Our Romulator lets you emulate any PROM configuration on the market today, develop a complete

program and debug it before you ever have to commit it to a PROM.

Data I/O offers a unique calibration standard which lets you calibrate to each PROM manufacturer's specs—before you program—for maximum yields and long term I-C reliability.

### Data I/O total three point service

1. Every Data I/O customer receives a quarterly update on currently available PROMs.
2. Through our direct (computerized) mailing program, Data I/O customers are kept constantly up-to-date on PROM specification changes and technological innovations.
3. Eight field offices in the U.S. and 22 distributors worldwide provide our customers with direct sales support, installation, and operator training.

## Get the facts

If you would like to know more about our products, or want copies of our quarterly PROM Comparison Chart and PROMBITS (our periodic technical bulletin on PROM applications and innovations), mail this coupon or call one of our offices. Data I/O Corporation, P.O. Box 308, Issaquah, Washington 98027.

Name \_\_\_\_\_

Title \_\_\_\_\_

Company \_\_\_\_\_

Address \_\_\_\_\_ M/S \_\_\_\_\_

City/State/Zip \_\_\_\_\_



# Data I/O

CIRCLE NUMBER 42

Data I/O offices: Washington D.C. area—301/652-7240; Chicago area—312-884-1335; Dayton area—513/435-4440; Dallas area—214/349-0877; Tulsa area—918/865-4111; Los Angeles area—714/998-9151; San Jose area—408/732-8246; Boston area—603/888-3850; Seattle area—206/455-3990; Europe: Amsterdam—020/186855, TELEX—16616.

# \$795 never bought a system DMM like this... until now.

- Fully programmable in function, range and even autorange
- Full remote control up to 12 conversions/sec
- Complete interface capability
- 0.007% Basic accuracy for 6 months

 **DATA PRECISION**®  
...years ahead

VISIT OUR BOOTHS 2618, 2620 & 2622 AT ELECTRO 76

**Until now**, you'd pay \$2000 to get what the Model 3400 gives you and even then, you might come up short.

The Data Precision Model 3400, at just \$795, is the world's most accurate systems/lab 4½-digit multimeter. It is the only DMM in this price range designed with digital data interface as a true system multimeter as well as a highly versatile stand-alone unit. It is completely and independently programmable from its rear terminal digital interface for both range, function and even autorange.

The Model 3400 features include TRI-PHASIC®, the Data Precision exclusive conversion cycle for drift-free overall system performance; up to 12 complete full-scale conversions per second providing printer-compatible data throughput rates; overload protection to 1000 Volts peak on all Volt and Ratio ranges, plus 270V on all resistance ranges; and optimum utilization of 4½ digit resolution through 100% overrange.

And there is still more. The Model 3400 implements "overlap mode" for interlacing MUX advance and sampling, so that system throughput rate equals instrument conversion rate, without MUX settling errors; BCD output is fully printer-compatible; accurate, stable, repeatable 10 µV resolution DC and AC; and it provides full function versatility: DC Volts; AC Volts; Ohms; DC/DC and AC/DC Ratio. IEEE Standard 488 BUS optional.

In the Model 3400, Data Precision has put complete system-implementing control within reach of many new customers. It's just part of our on-going commitment to provide the most accurate and reliable instrumentation at the lowest possible price.

**For complete information or a demonstration, contact your local Data Precision representative or Data Precision Corporation, Audubon Road, Wakefield, MA. 01880, (617) 246-1600. TELEX (0650) 949341.**



FOR DEMONSTRATION CIRCLE # 273  
FOR ADDITIONAL INFORMATION CIRCLE # 274



## The importance of Jack

Jack was an important executive and everybody knew it. You could tell it right away because Jack was extremely difficult to get to. Even his secretary was difficult. It was clear that her mission was to protect Jack from his subordinates. Following Jack's instructions, she spent most of her time making certain that callers didn't waste her boss' precious working hours.

Jack was always available—instantly—when his boss called. His "Hi, Sally. Can I speak to Jack?" always met a super-prompt, super-enthusiastic, "Certainly, Mr. Jones, right away."

But if one of Jack's engineers called, Sally bristled. "He's very busy. Can it wait until some other time? Can somebody else take care of it? Can you tell me about it so I can discuss it with him when he's free? Can't you take care of it yourself?" And often, Sally would so grind down an engineer that he would give up. He would make a decision that should have been Jack's and risk Jack's wrath—for which there was always time—if Jack's decision would have been different.

But most of the time Jack never knew decisions were being made. He would assemble his engineers occasionally to criticize or give them instructions. But he had little else to do with them or, for that matter, with customers or vendors. Sally warded them off, too. So customers and vendors learned to call Joe, one of Jack's subordinates. With his secretary, he made everybody feel welcome and made everybody's problems important enough to merit attention.

The sequel to this tale is predictable. In the next economy wave, Jack and Sally were let go. It was apparent that their principal activities were pleasing their bosses.

Jack and Sally probably got what they deserved. But there are probably hundreds of other Jacks and Sallies who, alone or together, render frequent disservice to their co-workers, customers, suppliers, employers and, in fact, themselves.

A secretary who derives status from sheltering her boss from the outside world injures him and everybody else. And the boss who, through design or innocence, allows himself to become too "important" to stay in touch with others soon loses touch with everything.

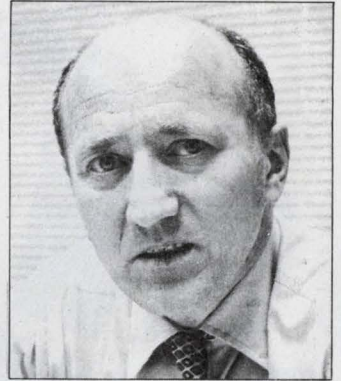

A handwritten signature in cursive script that reads "George Rostky".

GEORGE ROSTKY  
Editor-in-Chief

The EC series is ACDC's new line of power supplies designed for OEM applications. No bells and whistles, no fancy frills or extras. Just solid, reliable power supplies designed and built by ACDC Electronics... a name synonymous with quality.

The EC series is mechanically and electrically interchangeable in form, fit and function with other open frame power supplies that meet accepted industry standard. There are over 50 models to choose from in a wide range of voltages and currents so you can order the exact power supply for your application. Power supplies with a maximum of reliability at minimum cost.

**STOCK DELIVERY**  
**2 YEAR GUARANTEE**  
**18 WORLD-WIDE SERVICE CENTERS**



# INTRODUCING THE EC SERIES - A NEW LINE OF LOW COST POWER SUPPLIES



## SINGLE OUTPUT POWER SUPPLIES

Nominal Output Voltage	Max. Current (amps)	Model Number	Price	
			1	250
2 V.	3.0	EC2N3	\$ 31.00	\$ 24.95
	6.0	EC2N6	51.00	41.50
	9.5	EC2N9.5	63.00	51.00
	12.0	EC2N12	80.00	65.50
	17.0	EC2N17	101.00	82.00
	25.0	EC2N25	137.00	112.00
5 V.	3.0	EC5N3	31.00	24.95
	6.0	EC5N6	51.00	41.50
	9.5	EC5N9.5	63.00	51.00
	12.0	EC5N12	80.00	65.50
	17.0	EC5N17	101.00	82.00
	25.0	EC5N25	137.00	112.00
6 V.	2.6	EC6N2.6	31.00	24.95
	5.4	EC6N5.4	51.00	41.50
	8.5	EC6N8.5	63.00	51.00
	11.0	EC6N11	80.00	65.50
	15.0	EC6N15	101.00	82.00
	23.0	EC6N23	137.00	112.00
12 V.	2.2	EC12N2.2	31.00	24.95
	3.5	EC12N3.5	51.00	41.50
	6.0	EC12N6	63.00	51.00
	7.5	EC12N7.5	80.00	65.50
	10.0	EC12N10	101.00	82.00
	16.0	EC12N16	137.00	112.00
15 V.	1.8	EC15N1.8	31.00	24.95
	3.0	EC15N3	51.00	41.50
	5.0	EC15N5	63.00	51.00
	6.5	EC15N6.5	80.00	65.50
	9.5	EC15N9.5	101.00	82.00
	14.0	EC15N14	137.00	112.00
20 V.	1.5	EC20N1.5	31.00	24.95
	2.5	EC20N2.5	51.00	41.50
	4.2	EC20N4.2	63.00	51.00
	5.3	EC20N5.3	80.00	65.50
	8.0	EC20N8	101.00	82.00
	11.0	EC20N11	137.00	112.00

## DUAL OUTPUT POWER SUPPLIES

Nominal Output Voltage	Max. Current (amps)	Model Number	Price	
			1	250
24 V.	1.3	EC24N1.3	31.00	24.95
	2.4	EC24N2.4	51.00	41.50
	4.0	EC24N4	63.00	51.00
	5.0	EC24N5	80.00	65.50
	7.5	EC24N7.5	101.00	82.00
	10.0	EC24N10	137.00	112.00
±12/15	0.5	EC12D0.5	\$ 45.00	\$ 38.00
	1.5	EC12D1.5	69.00	57.00
	3.0	EC12D3	89.00	72.00
	3.0	EC15D3	89.00	72.00
	5.0	EC15D5	122.00	99.00
	5.0	EC15D5	122.00	99.00

## TRIPLE OUTPUT POWER SUPPLIES

Nominal Output Voltage	Max. Current (amps)	Model Number	Price	
			1	250
5V	6.0	ET401	\$113.00	\$ 85.00
	12	ET601	165.00	135.00
	15	ET602	165.00	135.00

## OVERVOLTAGE PROTECTION OPTION

Rated output current of power supply	1	Price	250
0 to 12 Amps	\$ 8.00	\$ 7.50	\$ 6.50
12 to 25 Amps	12.00	10.50	10.00

**acdc electronics**  
ACDC Electronics, 401 Jones Road, Oceanside, CA 92054 • West Coast (714) 757-1880; East Coast (201) 687-6633

# Designing broad band transformers?

Here  
comes  
help



**DESIGN DIRECTION** — Tell us your application for broad band components. We'll send you complete design information on the only ferrites manufactured, tested and guaranteed for bandwidth performance. Your design will be easier and more precise with graphs of  $R_p$  and  $X_p$  vs. frequency and design examples that work.

**COMPONENT SELECTION** — Give us your circuit parameters and we will select a Broad Band-Rated<sup>®</sup> component with 16,000 perm to replace expensive metal laminations. Or give us your bandwidth requirements from 100 Hz to beyond 250 MHz and we'll choose from our complete range of toroids and mated parts in recommending a specific solution.

Call **APPLICATIONS ENGINEERING**, (201) 826-5100 or write: Indiana General, Keasbey, New Jersey 08832.

RESCUE VEHICLE — CREATIVE PLAYTHINGS

**EMM** indiana general  
a division of Electronic Memories & Magnetics Corp.  
Keasbey, N.J. 08832 • (201) 826-5100

# Why more engineers than all other microcom

The 8080 system comes with four CPU options, twenty-five performance matched peripheral, I/O and memory components, and the industry's most useful software and hardware development systems. We've had the 8080 in volume production since April 1974 and there are now major second sources. These are just a few of the reasons why more engineers use the Intel 8080 system than all other microcomputers combined. Join them and you'll eliminate complex random logic, save design time, and get your products to market faster and at lower cost.

Start by replacing hundreds of TTL packages with the three LSI circuits in the MCS-80™ CPU Group—the 8080A CPU, 8224 Clock Generator and 8228 System Controller. Built into the Intel 8224 and 8228 are many of the extra functions that most designs require, such as TTL & MOS clocks, auxiliary timing functions and current

sinking capability that keeps memory and I/O interfaces simple.

A dozen I/O and peripheral circuits that attach directly to the system bus make it easy to add on peripheral subsystems. Five are programmable LSI devices. These operate under software control in numerous modes and can often replace up to 75—or more—TTL packages each. For example, the Intel 8251 Programmable Communication Interface provides virtually all serial data transmission protocols in use today, including IBM Bi-Sync. Or, for easy interface to printers, keyboards, displays and motor drives, use the 8255 Programmable Peripheral Interface. You can reorganize its 24 I/O lines with software as your needs change.

You have thirteen options in performance matched standard memory circuits, such as 16K ROMs, 8K erasable PROMs and 4K RAMs for high density at low cost, plus CMOS RAMs for lowest power.

You also get four CPU choices, including the M8080A for operation

MCS-80™ SYSTEM COMPONENTS		
	Part No.	Description
<b>CPU GROUP</b>	8080A 8224 8228	8-bit Central Processor Unit, 2 $\mu$ s cycle Clock Generator System Controller
<b>CPU OPTIONS</b>	8080A-1 8080A-2 M8080A	1.3 $\mu$ s cycle 1.5 $\mu$ s cycle 2 $\mu$ sec cycle (–55 to +125°C)
<b>I/O</b>	8212 8251 8255	8-bit I/O Port (15 mA drive) Programmable Communication Interface Programmable Peripheral Interface
<b>PERIPHERALS</b>	8205 8210 8214 8216  8226  8222  8253* 8257* 8259*	1 out of 8 Binary Decoder Dynamic RAM Driver (8107B) Priority Interrupt Control Unit Bidirectional Bus Driver, Non-Inverting (50 mA) Bidirectional Bus Driver, Inverting (50 mA) Dynamic RAM Refresh Controller (8107B) Programmable Interval Timer Programmable DMA Controller Programmable Interrupt Controller
<b>PROMs</b>	8604 8702A 8704 8708	512 x 8, 100 ns 256 x 8 Erasable, 1.3 $\mu$ s 512 x 8 Erasable, 450 ns 1K x 8 Erasable, 450 ns
<b>ROMs</b>	8302 8308 8316A	256 x 8, 1 $\mu$ s 1K x 8, 450 ns 2K x 8, 850 ns
<b>RAMs</b>	5101 8101A-4 8102A-6 8102A-4 8107B 8111A-4	256 x 4 Static CMOS, 650 ns 256 x 4 Static, 450 ns 1K x 1 Static, 650 ns 1K x 1 Static, 450 ns 4K x 1 Dynamic, 420 ns 256 x 4 Static Common I/O, 450 ns

\*Available 2nd quarter 1976.

# use the Intel 8080 system puters combined.

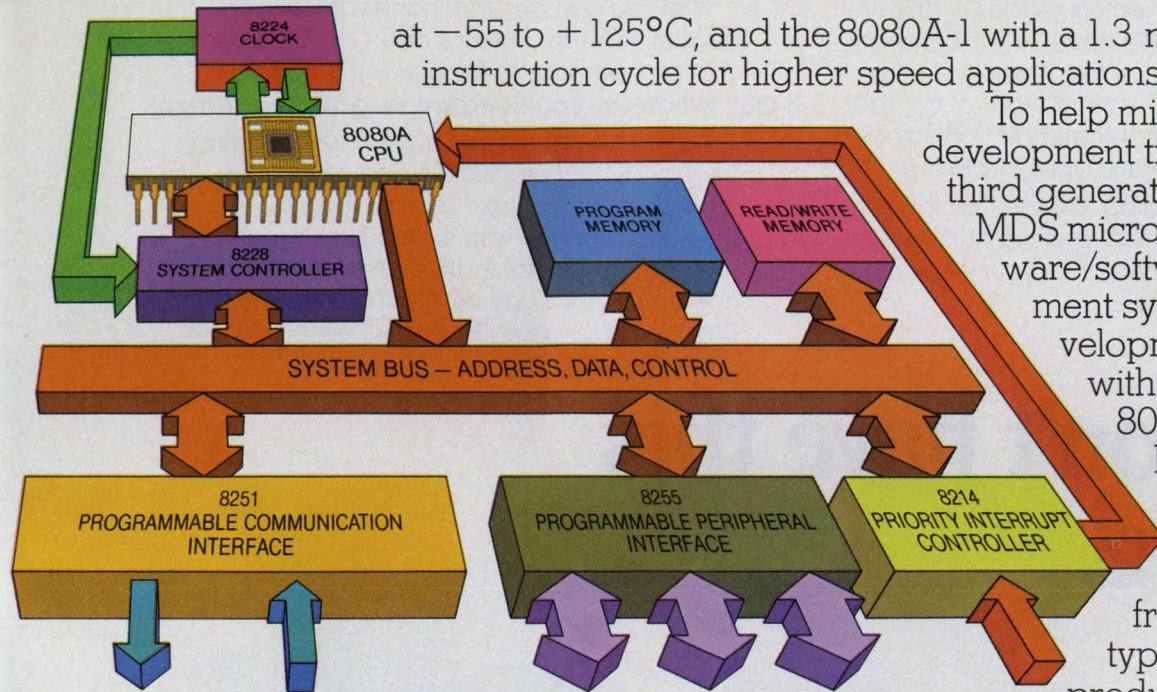

at  $-55$  to  $+125^{\circ}\text{C}$ , and the 8080A-1 with a 1.3 microsecond instruction cycle for higher speed applications.

To help minimize system development time use the third generation Intellec<sup>®</sup> MDS microcomputer hardware/software development system. This development system with its unique ICE-80 in-circuit emulator lets you simultaneously debug software and hardware, from initial prototyping right through production. The Intellec

MDS is supported by six comprehensive software packages including a macro-assembler, ICE-80 interactive software driver and a diskette operating system.

In addition to the software packages in the development system, three cross product software packages are available on magnetic tape and on several time share networks. The Intel 8080 system is also supported by the industry's largest user's library, training courses and field applications assistance.

Start now with the new SDK-80 System Design Kit. It's a complete system for only \$350 and includes: An 8080A CPU, Clock Generator, System Controller, Programmable Communications Interface and a Programmable Peripheral Interface. You also get two 1 of 8 binary decoders, 256 bytes of static RAM, two kilobytes of erasable PROM (with the system monitor supplied in one kilobyte), a PC board, clock crystal, connectors, other assembly parts, plus a user's manual and programming manuals.

To order the SDK-80 kit, contact our franchised distributors: Almac/Stroum, Component Specialties, Components Plus, Cramer, Elmar, Hamilton-Avnet, Industrial Components, Liberty, Pioneer, Sheridan or L.A. Varah.

For your free copy of the new 8080 system brochure and our Intellec MDS brochure, write: Intel Corporation, 3065 Bowers Ave., Santa Clara, Calif. 95051. For \$5.00 we'll send you a copy of our new 236 page 8080 Microcomputer Systems User's Manual that includes complete hardware, software and interfacing data for all 8080 systems.

**intel<sup>®</sup> Microcomputers. First from the beginning.**

# If you spend more than 20 minutes picking a P.C. connector

It's your guide to the broadest line of printed circuit connectors made by any single manufacturer. We have just about everything and in more combinations and more depth than anyone — more types of contact terminations, insulator materials, mounting styles, contact designs, types of plating.

Send for our catalog. Browse through it and you'll discover that picking out the right printed circuit connector for your job is as simple as it should be.

## Quick delivery.

And you can get your hands on our connectors, too — in a hurry if need be. We keep a large inventory; so do our distributors.

## Our "Whatever-you-need-we've-got" department.

As you can guess, we have a lot of tooling filed away. Our production engineers have a unique talent at taking an existing bit of tooling, fiddling with it, and turning out a "custom" connector that's exactly what you need. Your extra cost is only a modest set-up charge... a long way from a full retooling cost.

Use the coupon.

## ...you don't have this catalog.



**Ok. Send me:**  Your latest printed circuit connector catalog.  
 ...and your nearest rep. I want to talk to him about a particular problem I have.

NAME: \_\_\_\_\_

TITLE: \_\_\_\_\_ TELEPHONE: \_\_\_\_\_

COMPANY: \_\_\_\_\_

ADDRESS: \_\_\_\_\_

CITY: \_\_\_\_\_ STATE: \_\_\_\_\_ ZIP: \_\_\_\_\_

  
**Viking**  
**CONNECTORS**

Viking Industries, Inc./21001 Nordhoff Street  
Chatsworth, CA 91311 U.S.A./ (213) 341-4330/ **DATA CON DIVISION**

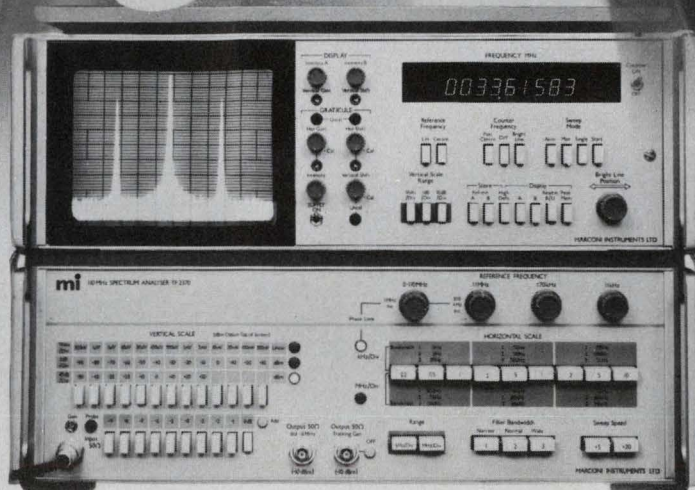

# Smash Production Bottlenecks!

You've never seen a faster, more accurate way  
of measuring frequency response from 30Hz to 110MHz

Slash your production-test times and divert your skilled engineers to more important work with our TF 2370 Spectrum Analyser. It will reduce to simple operations, complicated measurements such as response, level, gain, signal purity, modulation and many more, with a speed and degree of accuracy that has to be seen to be believed. Forget everything you have heard about spectrum analysers. The TF 2370 is unique. It employs advanced technology to make it reliable and as easy to operate as a multimeter. The facts speak for themselves.

- \* Flicker-free display of frequency response from 30 Hz to 110 MHz on a high-brightness c.r.t.
- \* Electronic graticule, with a  $\pm 15\%$  variation of horizontal divisions for pin-point positioning against waveform display.
- \* Press-button selection of three amplitude scales: one linear and two logarithmic with expansion to 1 dB/div. with an accuracy of  $\pm 0.1$  dB/dB.
- \* 9-digit electronic counter automatically gives centre frequency, reads any other frequency corresponding to manually-adjusted 'bright line' position on display, or the

difference frequency between the two, at the press of a button. All to an accuracy of  $\pm 2$  Hz  $\pm$  reference frequency accuracy on high resolution and manual. Internal reference frequency provided with setting accuracy of 1 in  $10^7$ .

- \* Internal generator supplies synchronous signal source for measuring such items as networks and filters.
- \* For comparative measurements, unique memory storage system will retain one display indefinitely as required, for simultaneous display with waveform produced by items under test.
- \* Automatic adjustment of amplifier gain to give optimum lowest-noise performance with full protection against input overloading.
- \* Automatic selection of optimum sweep speed.
- \* With the 5 Hz filter, signals 100 Hz from a response at 0dB can be measured to  $-70$  dB.

Now ask for a demonstration. It could prove that the TF 2370 is a better cure for your headaches than aspirin. We are standing by for your call.

**mi** MARCONI INSTRUMENTS  
DIVISION OF MARCONI ELECTRONICS INC.

100 STONEHURST COURT, NORTHVALE, NEW JERSEY 07647 • TELEPHONE: 201/767-7250 • TWX: 710-991-9752

"SEE US AT ELECTRO '76—BOOTH #2701-2703"

749

# IT'S WORKING FOR ME

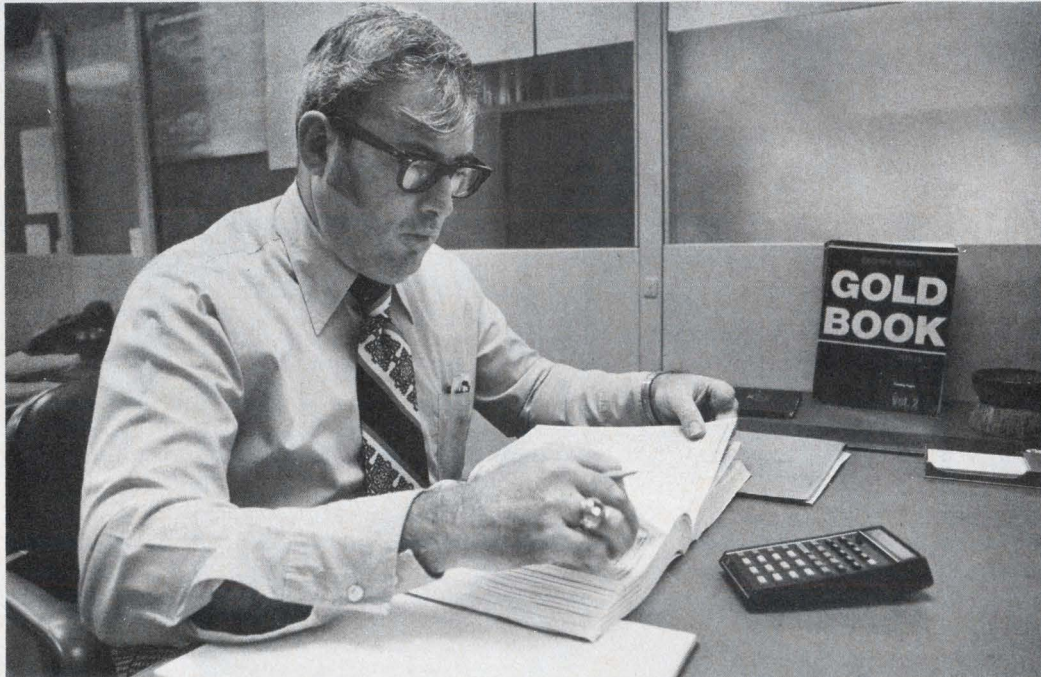

**Electronic Design's GOLD BOOK is very convenient and always on my desk. I don't have to go somewhere else to use it.**

Mr. W. T. Noel is Senior Engineer at the Naval Air Systems Command, Arlington, Virginia. He is involved with infrared avionics development and procurement for the Navy Department. Mr. Noel states:

**"I refer to the GOLD BOOK often and find it quite useful in my work. It's very convenient and always on my desk. I don't have to go somewhere else to use it.**

**"Navy avionics procurements are largely to specification. The performance sheets and vendor sources provided by the GOLD BOOK are quite useful in the preparation of these specifications."**

This is the *Electronic Design* audience working for you. (The GOLD BOOK goes essentially to *Electronic Design's* audience of engineer/specifiers.) Mr. Noel, like 78,000 electronics engineers and engineering managers, purchasing agents and distributors throughout the U.S. (plus 13,000 abroad) has his own personal copy of the GOLD BOOK.

The GOLD BOOK is *there*, at hand, ready when the need arises.

**THIS IS THE ELECTRONIC DESIGN AUDIENCE  
WORKING FOR YOU**

**Electronic Design / GOLD BOOK**

HAYDEN PUBLISHING COMPANY, INC.

50 Essex Street, Rochelle Park, New Jersey 07662 • Tel: 201-843-0550



# The programmable frequency synthesizer that lets you get on the bus without being taken for a ride

The Model 802 Frequency Synthesizer takes its place between the highly sophisticated (and highly expensive) synthesizers and the less versatile RC and LC oscillators. Now at a reasonable cost, you can have a signal source with crystal controlled stability, high frequency accuracy and resolution, and the capability of remote control programming, either BCD or ASCII compatible with IEEE STD 488-1975, the standard ASCII "BUS".

## simple

Simple to operate, simple to calibrate, simple to maintain. Just six plug-in circuit boards plus a plug-in power supply perform all frequency synthesis functions. Convenient test points make location of faulty cards quick and easy. And, in case of trouble, you can substitute a new card without extensive recalibration.



Frequency range: 0.01Hz to 20MHz plus 30MHz to 50MHz offset frequency output

Note: Exact also has a line of ASCII Programmable Function Generators.



BOX 160, HILLSBORO, OREGON 97123  
(503) 648-6661 TWX 910-460-8811

## stable and accurate

The Model 802 offers frequency stability of 10 ppm/year and accuracy of .001% of setting. Bandswitching by decade ranges maintains a constant 6-digit resolution throughout the frequency range. Outstanding signal purity with low phase noise and low harmonic and non-harmonic spurious outputs permit accurate measurement of narrow band communications circuits. Amplitude is controlled with 0.01db resolution from -69.99dbm to +26.99dbm with 0.05 db flatness.

## versatile

In one instrument, the Model 802 offers frequency coverage from 1 Hz to 20 MHz, or 0.01 Hz to 20 MHz as an option, for an extremely stable source of signals typically requiring more than one instrument. Frequency accuracy is  $\pm .001\%$ , or by using the Model 802's phase lock input, it can be slaved to an external frequency standard for even higher accuracy. Options include BCD programming, ASCII programming (compatible with IEEE STD 488-1975), several output impedances, low frequency extender (to 0.01Hz), and rack mounting adapters.

CIRCLE NUMBER 165

# The best talents in your business can be bought...

## PRACTICAL DESIGN FOR ELECTROMAGNETIC COMPATABILITY

edited by ROCCO FICCHI

A complete guide to electromagnetic compatibility for electronic systems and equipment. Includes the current techniques for analyzing, predicting, controlling and reducing unwanted signals, along with numerous charts, graphs and nomographs. Recent advances in filtering and shielding, and exhaustive treatment of the special problems encountered in computers, semiconductors and solid-state devices. #5685-0, \$17.20

## PRACTICAL VALUE ANALYSIS METHODS

by JOHN H. FASAL

This step-by-step guide transforms sophisticated VA-VE theory into concrete techniques and methods enabling you to literally take apart and scrutinize every facet of your operation—streamline everything from product costs to worker efficiency. An unlimited planning tool in the hands of today's ambitious executive or manager. #5845-4, \$13.75

## MODERN DATA COMMUNICATION

by WILLIAM P. DAVENPORT

An on-the-job handbook mapping out the latest techniques, systems and services for the most efficient data transmission. Includes simplified coding techniques; ways of dealing with distortion, distraction, interference; efficiency and control techniques; modulating and multiplexing methods; and advice on using today's commercially available services. #5810-1, \$10.30

## BASIC TELEPHONE SWITCHING SYSTEMS

by DAVID TALLEY

Offers the full array of switching techniques—from the early step-by-step type, through the common electro-mechanical group, to today's sophisticated electronic system. Special attention given to the No. 1 ESS type being installed by many companies. Here's a versatile, clearly-written handbook for the engineer, executive, and trainee alike. #5750-4, \$6.60

## RELIABILITY, MAINTAINABILITY AND AVAILABILITY ASSESSMENT

by MITCHELL O. LOCKS

All the techniques and formulas you need for calculating the reliability, maintainability and availability of your repairable and non-repairable systems and components. You'll find sample models using point and interval values, and time-to-failure and time-to-repair data; binomial and other bernoulli-type distributions; simplified goodness-to-fit techniques, and much more. #9204, \$15.95

## VIBRATION AND ACOUSTIC MEASUREMENT HANDBOOK

edited by MICHAEL BLAKE & WILLIAM S. MITCHELL

This giant, field-tested, 680-page manual enables you to master today's vibration equipment and techniques—shows you how to spot up to 90% of equipment problems months in advance and take corrective action before trouble starts. Uses scores of actual industrial problems and solutions in outlining specific procedures and techniques. #9195, \$34.50

# on a 15-day money-back guarantee.

**I'm buying!** Please send me the books listed below to read and use FREE for 15 days. At the end of that time I will send payment, plus postage, or return the book(s) and owe nothing.

Number	Title	Price
_____	_____	_____
_____	_____	_____
_____	_____	_____
_____	_____	_____
		TOTAL _____

Name \_\_\_\_\_

Firm \_\_\_\_\_

Street \_\_\_\_\_

City/State/Zip \_\_\_\_\_

I want to save money! Payment enclosed. Publisher pays postage. Same 15-day guarantee. 75-50



**Hayden Book Company, Inc., 50 Essex St., Rochelle Park, N. J. 07662**

# The first color-capped industrial toggle.

Introducing our new heavy-duty Designer Line switches with up to 20 amp, 2 hp, A-c and D-c ratings. Now you can color-code almost any function or simply use color to improve overall equipment appearance.

Select from nine distinctive lever styles, nine standard colors, two bushing lengths, as well as eleven color-coordinated decorator facenuts in two types.

You also choose from five switch bases, screw or plug-in terminals, single and double poles, plus a variety of circuit configurations.

The first color-capped industrial toggle switch gives you the new colorful choice for your heavy-duty applications. Contact your Cutler-Hammer Sales Office or Switch Distributor.



Designer Line—the broadest line of commercial toggle switches, ratings up to 8 amps, A-c and D-c, and 15 amps A-c. A rainbow of colors! Virtually unlimited combinations of toggle styles, circuits, colors.

## Electro 76

# It's an all new show--

A number of significant firsts mark this year's international IEEE convention and product exposition.

The show is being held in Boston, the first time the annual electronics extravaganza has been held outside of New York City. It's got a new name—Electro 76. And it's being held later than ever—May 11-14 instead of March or April.

The exhibition will take place in Hynes Memorial Auditorium, and according to an IEEE spokesman, has been sold out since early January. American and overseas exhibitors—including major representations from the USSR, Israel, the United Kingdom, West Germany and Japan—will occupy 250 booths. The four-day exhibition is expected to attract some 25,000 visitors.

The technical program will be held in the Sheraton-Boston and will consist of 34 morning and afternoon sessions.

Dr. C. Lester Hogan, vice chairman of Fairchild Camera and Instrument Corp., will give the keynote address during a special session on opening day.

The emphasis in the technical program is on microprocessors, microcomputers and LSI; six sessions are dedicated to applications, testing, languages, and design aids, and the impact of  $\mu$ Ps is seen in many other papers.

"Smart" instrumentation, power semiconductors, trends in communications equipment and modern radar techniques are also strongly represented in the program.

Some of the more important technical papers on microprocessors are offered in Session 8, "Design Aids for  $\mu$ Ps," and Session 23, "High-Level Languages for  $\mu$ Ps."

The papers in Session 8 survey the hardware

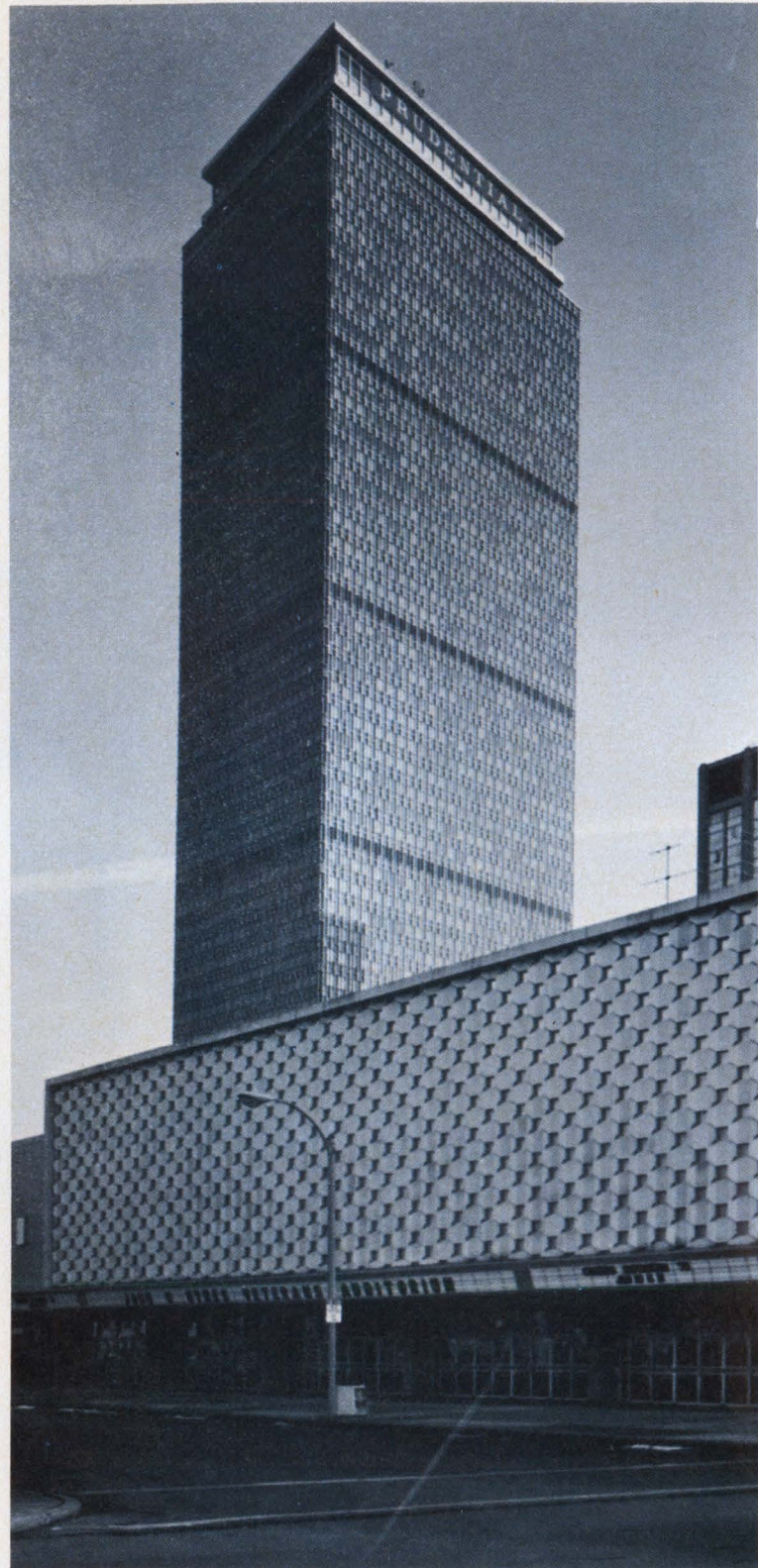

---

Boston's Hynes Auditorium and the Sheraton are expected to attract nearly 25,000 visitors.

# And it opens in Boston



and software tools available for  $\mu$ C system development, including "low-end" inexpensive kits and evaluation boards and "high-end" complete development systems, including high-level languages usable both for MOS processors and bipolar bit-slice micros.

Session 23 papers examine the higher-level vs assembly language controversy and offer guidelines to help users decide which language would be more cost-effective in their applications.

In the test and measurement area, Session 6 covers new uses of signal processing to improve measurements. Papers discuss the use of mini and microcomputers to improve measurements by mathematically processing instrument-output data.

The practical side of designing with power semiconductors is covered in Sessions 5 and 16. Among the topics discussed are trends in Darlingtons, SCRs and power Schottky diodes, and the application of high-voltage power transistors to efficient switching-power supplies.

Present and future trends in communications equipment design are the theme of Session 20. Papers concentrate on improved receiver dynamic range, low-noise reception and measurement techniques.

## **Microprocessors**

Systems designers face bewildering array of hardware-software tools..... 68

## **Test & Measurement**

Microprocessors continue to improve instruments and testing concepts..... 71

## **Communications**

Innovations abound in amateur radio equipment and techniques..... 72

## **Semiconductors**

Across-the-board improvements made in a variety of power devices..... 75

## **Microwaves**

U.S. engineers take a second look at European radar and ECCM designs..... 78

# Systems designers face bewildering array of hardware-software tools

The microcomputer systems designer is today faced with a confusing array of hardware and software tools for microprocessor-systems-development. They range from small kits and evaluation boards for under a hundred dollars, up to fully developed systems, with sophisticated software and peripherals, costing in the thousands.

Just which type of hardware and software is most cost effective for a given range of applications will be discussed in Session 8, "Microprocessor Design Aids," organized and chaired by Edward Torrero, an associate editor of *ELECTRONIC DESIGN*.

Because most system logic is implemented in software rather than hardware, creating and testing the first prototype of a microcomputer system requires tools and techniques that have no parallel in hardwired logic, reports A. Scott McPhillips in his paper: "Hardware-Software Breadboards."

For microcomputer prototyping the designer must have, as a minimum, a machine that executes the software, shows him what is happening and allows him to make modifications, says McPhillips, vice president of Microcomputer Technique, Inc., Reston, VA.

This prototyping machine can be a simple system assembled from chips or small boards and provided with such bare debugging essentials as a teletypewriter and a ROM to operate it. But the lack of displays, controls and interfaces makes working with this primitive system arduous and time-consuming. At the other prototyping extreme are costly development systems, the expense of which often cannot be justified.

For testing small-volume and medium-volume production designs McPhillips recommends a middle-of-the-road approach that is based on a "standardized breadboard" Microcomputer Technique developed for several of the popular microprocessors. These breadboards, which have a variety of simple debugging controls, as well as displays, peripheral interfaces and supporting software, were developed for Cramer Electronics, a Boston distributor that markets them.

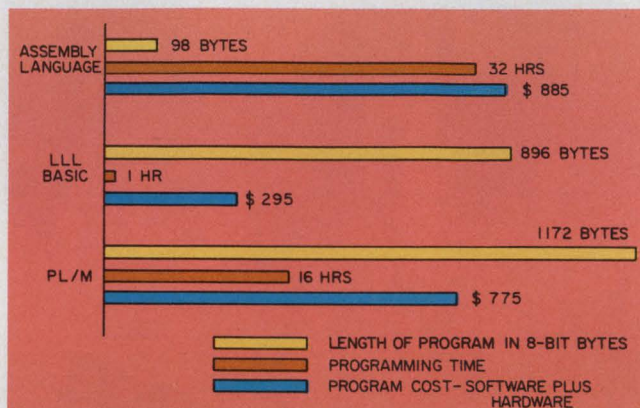

A new LLL Basic language from Lawrence Livermore Laboratory shows substantial savings when used in an 8080 benchmark program for a scientific instrument.

Effective low-cost techniques have been devised in the development of these breadboards. For example, a simple tool to get the hardware working is a plug-in 16-word memory comprised of switches. To use this, all memories are removed from the system and the switch ROM is connected so that it ignores all but the four least-significant address bits. It thus responds to any address the processor may generate.

In most microcomputer systems, the 16-word switch memory and an oscilloscope are all that are needed to test every aspect of hardware behavior, McPhillips says.

Also included, for program entry and display are a "poor man's terminal" (consisting of 16 additional switches) and a pair of seven-segment LED displays. The supporting software controls each segment of the display so that hexadecimal characters and even a question mark can be shown.

One bank of eight program switches is used to enter addresses and the program. The second bank is used to control and sequence the system software without using a teletypewriter.

"In our breadboard designs," McPhillips says, "we include LEDs on all system busses and often on inputs and outputs, too. The amount of time required to check the state of 8 or 16 points with conventional instruments is astounding compared

with the time needed for looking at an array of lights."

### Bipolars need special design aids

Design aids useful for bit-slice bipolar microprocessors are different from those used for the single-chip MOS devices because of two factors, according to David C. Wyland, author of another Session 8 paper, "Design Aids for Bipolar Microprocessors." One factor is architectural flexibility and the other is the existence of a second level of programming called "microprogramming."

"The microprogram design phase can benefit greatly from a general purpose microassembler," reports Wyland, manager of LSI applications and systems design, Raytheon Semiconductor Div., Mountain View, CA. He calls the microassembler "probably the single most important design aid for microprogram-controlled bipolar  $\mu$ Ps.

"Unit checkout can benefit from inclusion of checkout features that will interact with a microprogram display panel that allows the designer to step the microprogrammed unit through its various sequences and observe the corresponding activity."

Microprogram design consists of devising a flow chart that specifies the desired sequences. These sequences are then converted into bit patterns for ROMs containing the microprogram control. At this point in design a microcode assembler can greatly reduce the effort and error of translating the flow-chart sequences into ROM code.

Microprograms can be created by hand for a control ROM of up to 2048 bits, consisting of 256 8-bit bytes, Wyland points out. But above this size a number of problems appear that make hand-creation undesirable and the use of the general purpose microassembler almost mandatory.

The general-purpose microassembler is useful for both horizontal and vertical microprogram architectures. The horizontal microcode is characterized by wide microinstruction words of 40 to 80 bits, with many independent functions controlled directly by bits in the microinstruction. The vertical microcode is characterized by 12 to 32-bit words that are decoded to perform one or a few functions per microinstruction.

Horizontal system design results in simple, fast systems, Wyland says, because the system functions are driven directly by the ROM bits. But he cautions that horizontal design is expensive because many microprogram bits require numerous ROMs to drive each of them.

Small, high-speed systems of less than 256 words tend to be horizontal in design because relatively few chips are involved in the control-ROM section. For example, 40 lines can be controlled by five  $256 \times 8$ -byte PROM chips.

There is a tendency to add bits to the control ROM rather than to the microprogram, says Wyland, because horizontally organized systems often have up to ten 10-step microroutines. An added microprogram step here may increase operating time by 10 to 50%.

Vertical design is used to minimize the cost of the control ROM. That is, rather than use a large number of control-ROM bits for function control, a few ROM bits are decoded and the decoder outputs are used to control the system's functions.

Reducing the number of bits in the microinstruction reduces the number of chips required

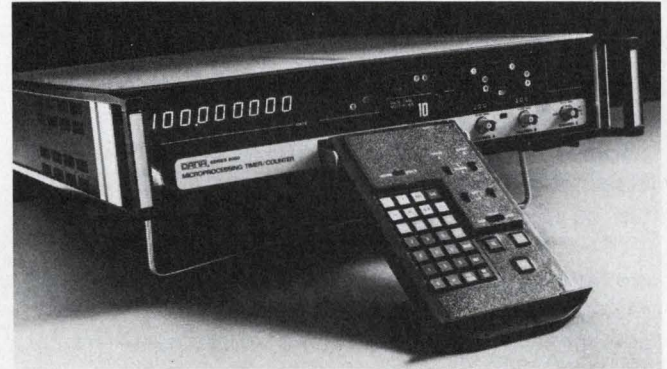

Massive application of microcomputers by 1980 is predicted for consumer and for electronic applications like this Dana 9000 microprocessor-based timer-counter.

for the control ROM. But this reduction is obtained at the expense of speed and complexity.

Large microprogram systems of 1024 words or more tend to be vertically organized, Wyland points out. These systems usually have long microcode sequences. As a result, microprogram steps are added, rather than a change in hardware, to solve design problems.

Several microassemblers have been developed for internal use by a number of companies, Wyland says.

The Rapid assembler developed by Scientific Micro Systems, Mountain View, CA, is available on the National CSS time-sharing network. It is probably the most widely used microassembler at this time. While it is well suited for vertical microprograms, Wyland cautions that it is difficult to use for horizontal microcoding.

### Which high-level language is best?

The controversy over which high-level language is best to use for microprocessors continues unabated, with several late entries into the field.

"Based on realistic cost and production levels as well as the productivity of programmers, we find that Intel's PL/M is especially good for low volumes and inexperienced programmers," reports Terry Dollhoff, director of engineering at

Microcomputer Technique and author of a Session 23 paper, "Measuring the Cost Effectiveness of Microprocessor Languages."

When production volumes of 20 units or less are expected, there is little in favor of using assembly language, Dollhoff says. But there is considerable argument for assembly language use with a production volume of over 200 units.

"If future programming costs remain constant, reduced memory costs could drive that 200-unit break point upwards. However, since both of these costs are likely to rise in the future, we feel there is an absolute upper limit of about 250 units below which PL/M is favored.

"If the PL/M compilers become more efficient, the production boundary will shift in favor of that language," Dollhoff notes. "However, because of the way PL/M compilers are constructed, significant gains in efficiency are not in the offing.

"Perhaps five years from now there will be a better suite of compilers, but there will also probably be a better choice of languages."

To study the feasibility of high-level, interactive languages for use with their microcomputers, researchers at Lawrence Livermore Laboratory, Livermore, CA, selected two languages—PL/M and Basic.

"In general, PL/M is a subset of PL-1 written by Intel for its 8-bit microprocessors," says Eugene Fisher, programming supervisor at Livermore, in his Session 23 paper, "High Level Languages in Microcomputer Automation."

"PL/M's major deficiencies for the Livermore Laboratory included the fact that it is not interpretive and therefore there is time lost during debug," Fisher notes. "Also, there is no floating point capability.

"As a result, a subset of Basic called 'LLL Basic,' which could be used in both the interpretive and compile modes, was written for Livermore under contract to Idaho University.

"Both PL/M and Livermore Basic showed significant reductions in programming time and manpower cost," Fisher points out. The benchmark program, which was an actual calculation required for a scientific instrument, showed that the LLL Basic was 16 to 32 times faster to program than either assembly language or PL/M.

"This speed was the direct result of an immediately interactive language," Fisher says. "The benchmark also indicated that compared with assembly language the high-level languages were not particularly efficient in memory use. However," he notes, "with memory costs going down and manpower costs skyrocketing, this may be a very efficient tradeoff."

Newer, high-level languages adapted to microprocessors are appearing. One of these, called FORTH, is discussed by Geoffrey Leach, Sycor, Inc., Ann Arbor, MI, in his Session 3 paper "The

## Technical session order form

Please send me the following Electro 76 technical session preprints at \$3.00 per session (average: four papers per session), plus \$1 mailing charge per complete order. I understand this order will be mailed to my address within three weeks after receipt. Offer good until Aug. 1, 1976.

Session No.	Quantity	Session No.	Quantity
1		19	
2		20	
3		21	
4		22	
5		23	
6		24	
7		25	
8		26	
9		28	
11		29	
12		30	
13		31	
16		32	
17		33	
18		34	
		Psychotronics Session	

All Electro 76 sessions (1-34) will be available on audio tape cassettes. Price is \$5.95 each, or six for \$30 (including binder). Indicate tape requests by session number and include remittance as noted.

No. \_\_\_\_\_

Total Sessions × \$3 = \$ \_\_\_\_\_

Psychotronics × \$5 = \$ \_\_\_\_\_

Tape Cassettes × \$5.95 = \$ \_\_\_\_\_

Plus \$1 Mailing Charge = \$ \_\_\_\_\_

Total Cost = \$ \_\_\_\_\_

Make check payable to Electro 76 and mail with this form to:

**Electro 76**  
**999 North Sepulveda Blvd.**  
**El Segundo, CA 90245**

Date \_\_\_\_\_

Name \_\_\_\_\_

Firm \_\_\_\_\_

Street Address \_\_\_\_\_

City, State, Zip Code \_\_\_\_\_



State of the Art in Microprocessor Software.”

“The FORTH language defies categorization,” he reports. “However, its advertised use in the development of application language appears to place it in the system-implementation category.

“These system-implementation languages,” he explains, “provide the designer with an algorithmic language that is close enough to the architecture of the target machine to permit the generation of reasonably efficient code while still being sufficiently close to the application to permit rapid coding. PL/M is such a language.

“The FORTH system appears to be a highly efficient and economical package that is relatively simple to develop and highly tailored to the needs of the end user.”

FORTH was originally developed six years ago for minicomputers, and has now been tailored for RCA's COSMAC and Digital Equipment Corporation's LSI-11. FORTH programming is described in detail in a Session 23 paper entitled: “FORTH High-Level Programming Technique on Microprocessors,” by Elizabeth D. Rather and Charles H. Moore of Forth, Inc., Manhattan Beach, CA. ■■

---

## TEST & MEASUREMENT

---

# Microprocessors continue to improve instruments and testing concepts

---

Microprocessors, microprocessors, and more microprocessors.

That's the pervasive theme at Electro this year, and the one dominating the sessions on instrumentation, testing and measurements. Papers to be presented at Electro run the gamut from design of equipment with  $\mu$ Ps, to use of equipment to test  $\mu$ Ps.

Improved measurements are, of course, a standing goal in test equipment and the obvious target of internal intelligence. By mathematically processing data, minicomputers—and  $\mu$ Ps—boost instrument power, and also let users make entirely new measurements.

In a Session 6 paper entitled “Microprocessor Controlled Calibration and Diagnostics in a DMM,” Zoltan Tarczy-Hornoch of Systron-Donner, Concord, CA, describes how a  $\mu$ P contributes to a DMM's accuracy and long-term stability:

“Among its other advantages, the  $\mu$ P permits a self-calibration feature that corrects automatically and periodically for gain and zero-offset errors in all modes and all ranges. Self-calibration can be based on internal references or, for more accuracy, on external sources.”

### Faster than a speeding bullet

A more exotic application of measurement enhancement through signal processing is outlined

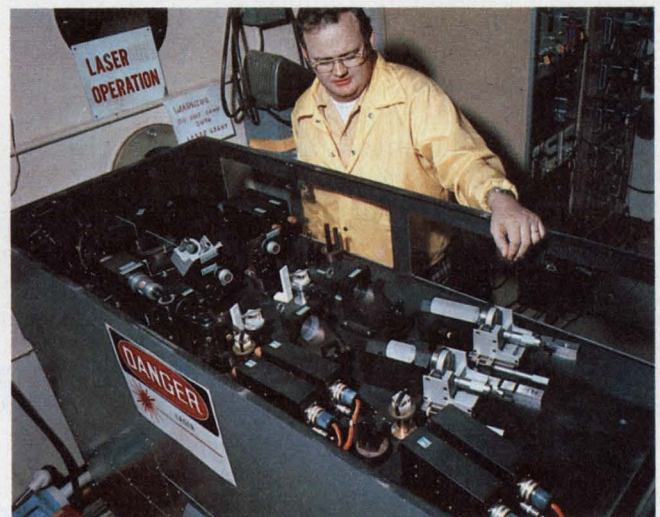

Monochromatic light detects motion of a specimen in an interferometry technique, and a digitizer/computer processes the data to produce the specimen's velocity.

in another Session 6 paper by Robert Lederer of Sandia Laboratories, Albuquerque, NM. The problem: to measure with high accuracy the velocity of objects moving at super-high speeds—bullets leaving a gun barrel, for instance, or particles from explosive blasts.

Sandia's solution: Use laser interferometry to obtain a doppler-shift analog signal, digitize the signal with a fast waveform converter, then process the data with a PDP-11/40 minicomputer

to get velocity readings. The technique provides 1% accuracy with particles moving at speeds from 0.1 to 10 mm/ $\mu$ s.

"The analysis process involves quite a bit of software" Lederer says, "but the key is the measurement of velocity with two complex waveforms that are analyzed independently and then compared to dig out the required velocity."

He continues: "Applications of the technique include seismometers, displacement measuring devices, and the like. Or you can monitor any moving target and get continuous information on its motion."

Ironically, although the  $\mu$ P allows designers to create instruments that make better tests, how to test the  $\mu$ P itself is a sticky problem yet to be solved. New techniques and new equipment are necessary, whether the aim is production testing, engineering evaluation or field service.

With the proliferation of  $\mu$ Ps, testing is of topical and urgent importance. This is reflected by two sessions—18 and 28—at Electro dealing with the problems and solutions of testing  $\mu$ Ps and  $\mu$ P/ $\mu$ C-based systems.

The headaches of  $\mu$ P testing, from the semiconductor vendor's point of view, are outlined by Y. Feng of Intel in his paper "Testing Microprocessors in the Semiconductor Manufacturing Environment."

You don't have to be a vendor, however, to benefit from Feng's information. For example, Feng derives the total number of possible CPU states in the 8080  $\mu$ P as  $2^{117}$ , an absurdly high number. To this number, Feng adds another stratospheric quantity—the possible number of memory-address switchings in a program-counter-generated Galpat test. Putting two and two together, Feng concludes: "There's no such thing as truly exhaustive testing."

The problem thus becomes one of developing tests and equipment that will provide economical testing with a desired confidence level. Feng goes on to review the three different techniques available in commercial testers which, he says, represent today's  $\mu$ P test technology.

Laboratory testing of  $\mu$ P-based systems—the subject and title of a paper by Stephen Swerling of Arthur D. Little Inc., Cambridge, MA—is another area in which available equipment is found wanting.

In Swerling's opinion, both logic analyzers and development systems fall short in testing and debugging, and what is really needed is an interactive test system—one that "talks" to both the system and the engineer.

### Requirements for an ideal system

Swerling goes on to list 15 general requirements for an ideal test system. Included in the list are such items as hexadecimal or octal display format, rather than binary; efficient means of operator input; ability to take a "snapshot" of a prototype's dynamic behavior without interfering with the prototype; and sufficient memory, computing ability and peripheral options to execute utility programs.

One person who might take exception to some of Swerling's conclusions is Hewlett-Packard's Bruce Farly, another Electro speaker. Farly's "Troubleshooting Processor Based Designs" details the contributions of logic-state analyzers to  $\mu$ P measurements.

Farly states in summary that the analyzer offers designers "a clear window into the data domain, the ability to record data transactions on either side of the I/O, and the sync signal needed to bridge the two domains of time and data." ■■

---

## COMMUNICATIONS

---

# *Innovations abound in amateur radio equipment and techniques*

New hardware and design concepts for both the amateur radio experimenter and the data-systems designer are the focus of the communications papers at Electro '76.

Three of the four papers of Session 20, "Present and Future Trends in Communications

Equipment Design," describe modern communications techniques as applied to amateur radio.

Radio "hams" are not all amateurs according to design engineer Wes Hayward of Tektronix Inc., Beaverton, OR. Since many are employed in industry, and are in the forefront of communi-

## Timetable to the technical sessions at Electro/76

<b>Tuesday May 11</b>	10 am	<b>1</b> Trends in Communications Components	<b>2</b> Developments in Optical Fiber Transmission	<b>3</b> Microprocessors: The Future Is Now	<b>4</b> Computer Communication Networks	<b>5</b> Trends in Power Devices
	2 pm	<b>6</b> New Uses of Signal Processing in Measurement	<b>7</b> Advances In Display Devices	<b>8</b> Design Aids For Microprocessors	<b>9</b> ATE Role in Field Service for PCBs	<b>10</b> Production Research and Technology
<b>Wednesday May 12</b>	10 am	<b>11</b> Engineering Management Techniques. Today and Tomorrow	<b>12</b> Effects of Noise on Man	<b>13</b> Microprocessor Applications	<b>14</b> Automatic Testing of Printed Wiring Boards	<b>15</b> Computer Technology Assessment
	2 pm	<b>16</b> Power Semiconductors in Off-Line Switching Supplies	<b>17</b> Electronic Problems in Medical Monitoring	<b>18</b> Microprocessor/ Microcomputer Testing	<b>19</b> The Synthesizer: Component, Signal Source, Complete Instrument	<b>20</b> Trends in Communications Equipment
<b>Thursday May 13</b>	10 am	<b>21</b> CAD I: Modeling Analysis, Problems	<b>22</b> Crime and Computers	<b>23</b> High-Level Microprocessor Languages	<b>24</b> Instrumentation: How Smart Should It Be?	<b>25</b> Trends in Radar Systems
	2 pm	<b>26</b> CAD II: Digital Circuit Development	<b>27</b> The Engineer After 40	<b>28</b> Designing and Debugging Microprocessor-Based System	<b>29</b> IEEE Standards 488 and 583 As Engineering Tools	<b>30</b> Radar Electronic Counter-Countermeasures
<b>Friday May 14</b>	10 am	<b>31</b> What's New in Air Traffic Control?		<b>32</b> Advanced Pocket Calculators	<b>33</b> New Memory Techniques	<b>34</b> A/D and D/A-To-Processor Interfaces

cations design, there often exists a two-way traffic in ideas, Hayward says, with industry benefiting from innovations first thought of for "ham" equipment.

In the opening paper, "Modern Trends in Communications Receiver Design—an Overview," Hayward describes current techniques being applied in the HF and low-VHF radio spectrum to design receivers of wide dynamic range. Dynamic range is a measure of how well the receiver responds to two input signals closely spaced in frequency. The larger the amplitude of these signals—before distortion harmonics set in—the better the dynamic range.

Hayward emphasizes narrow-tuning-range receivers, such as CB and "ham" radios, but says his ideas needn't be restricted to those types. His ideas apply, for example, to the design of spectrum analyzers. There is a continuing trend of sophisticated gear being built by individual experimenters for comparatively low cost, Hayward says.

"I can build a good home-made receiver for much less than I can buy one. Average noise figure in the HF range would be 5 to 6 dB, with a typical two-tone dynamic range of 95 to 100 dB, as compared with 75 to 80 dB for a typical commercial receiver."

#### Amateur radio enters a new phase

Joseph Reisert Jr., in the fourth paper at Session 20, "Low Noise VHF/UHF Receiver Design," describes how radio "hams" have now begun implementing earth-moon-earth communications at frequencies of 144, 432, 1296 and 2304 MHz.

This type of transmission uses the moon as a passive reflector to bounce signals back to distant points on earth, in much the same manner as was done by passive man-made satellites like ECHO-1, in the early days of the space program.

Using a transmitter output of less than the maximum FCC-allowed 1 kW, amateurs can now hear their own reflected signal. Reisert describes a dramatic system test in which he transmits for two seconds, stops, and then listens for his own signal, returned from its half-million-mile journey.

The breakthrough in this process came with the availability of low-cost, low-noise receivers. Although they may not be as sophisticated as those employed in long-range radar or radio astronomy, the receivers are practical and use hardware that is low in cost and easily available. That is their big advantage, Reisert says.

Reisert also describes considerations for designing receivers of minimum noise figure. He examines such basic elements of a receiver as the preamplifier, mixer, and postamplifier, and de-



Voice signals from Apollo 15 and 16 astronauts on the moon, were received by radio amateur Richard Knadle using his home-made \$42 parabolic antenna. Transmitter power on the moon was only 13 W.

scribes what steps must be taken to achieve low-noise operation of each.

Lowest noise figures in the frequencies of interest are achieved with bipolar transistors and gallium arsenide field-effect transistors, with the FETs outperforming bipolars at frequencies above 500 MHz, Reisert reports. However, because of the high cost (over a hundred dollars each) of GaAs FETs, most high-frequency amateur equipment today uses bipolar transistors. Future cost reductions should spur increased use of GaAs devices.

Below 300 MHz, silicon junction FETs perform very well. For example, a low-cost device such as the U-310 yields noise figures of 1.25 to 1.5 dB at 144 MHz. The U-310 is a silicon JFET costing under a dollar for the epoxy version. It is currently manufactured by Siliconix and National Semiconductor.

Improved techniques for receiver design, in the form of broadband, high-power matching networks, are discussed in the paper "Broadband Transmission Line Matching Networks," by Dr. Jerry Sevick of Bell Laboratories, Murray Hill, NJ.

These networks provide the following characteristics, previously unavailable in a single component:

- Broadband impedance matching over a wide range of frequencies.
- High power-handling capability.
- High efficiency.
- Fractional transformer ratios.

These features result in more flexibility for the design engineer in such situations as matching output stages to an antenna, or matching the interstages of solid-state rf power amplifiers, Sevick says.

Suppose it is necessary to match an output signal from a 50-Ω coaxial cable to a short vertical antenna whose impedance can be somewhere in the 3-to-20-Ω range. Previously, only integral-ratio transformers (4:1 is a typical ratio) were available. Such transformers would restrict the designer to antennas in the 10-to-15-Ω range.

Using a design based on a concept of short, coiled transmission lines, Sevick shows that both integer and noninteger transformers can now be fabricated. These devices also provide the very important advantages of covering a broad bandwidth (for example, 2 to 30 MHz), and of operating at high power levels (up to 1 kW).

The new transformers have efficiencies in excess of 98%. Older designs were only 93% efficient, typically, with "good" units measuring as high as 95%.

### A proliferation of data networks

Communications networks that link data-processing systems are the subject of Session 4.

A network that can connect many computers, terminals, and users—all distributed over a wide geographical area—is the subject of a paper by Stuart Wecker, a technical consultant at Digital Equipment Corp., Maynard, MA.

The network, consisting of a set of software tools known as Decnet, permits sharing of computer resources as follows:

- (1.) It allows the terminals of one system access to terminals and peripherals of other systems.
- (2.) It enables remote accessing of data files anywhere in the net. For example, this permits data files to be transferred between systems.
- (3.) It provides program sharing capability. Loadable programs can be sent from one system to another for execution, thus permitting the creation of a central program storage that is accessible by any member of the network.
- (4.) It enables the opening of a data path between programs so that processing can be done

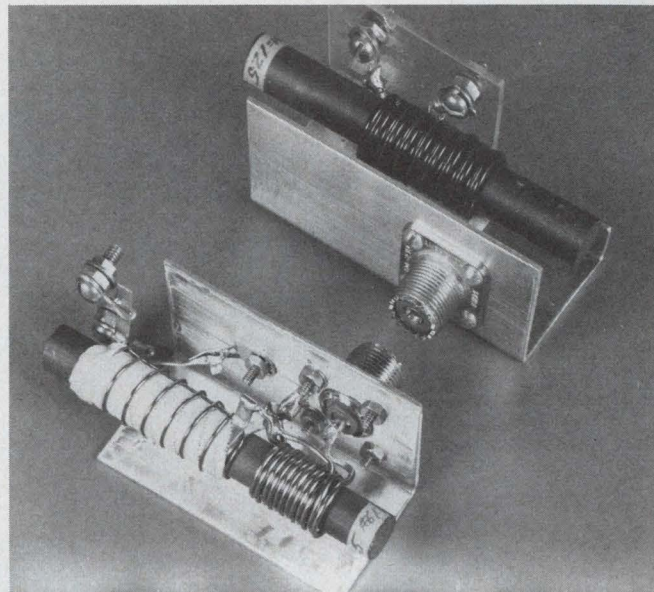

High efficiency matching transformers, designed by Jerry Sevick of Bell Labs are intended for the mf and hf bands. They can handle power up to 1 kW.

on a distributed basis. Different segments of a computing job can then be processed by different network components.

A number of potential markets for such a system are described by Wecker. These include users in industry, business, and research laboratories.

The possibility of using cable-television lines for local data distribution (within a city) is discussed in a paper by a group from Network Analysis Corp., Glen Cove, NY.

Using a data terminal in place of the usual TV set, a system can handle about 100,000 subscribers, each of whom can interact with a computer network, the authors report.

Another topic analyzed in the paper is "packet switching." This procedure, in effect, chops up a long data message into relatively small segments of from 1000 to 8000 bits in length. The packet-switching process permits transmitting each segment, or packet, separately over the most advantageous route. ■■

---

## SEMICONDUCTORS

---

# Across-the-board improvements made in a variety of power devices

---

The practical side of designing with power semiconductors, including power Darlington, SCRs, gate-turn-off SCRs and power Schottky diodes is emphasized in Sessions 5 and 16.

Power Darlington, for example, appear destined for automobile ignitions. "However, they will have to have high transient tolerance," says Gerald Owens of Prestolite, Decatur, IL, in his

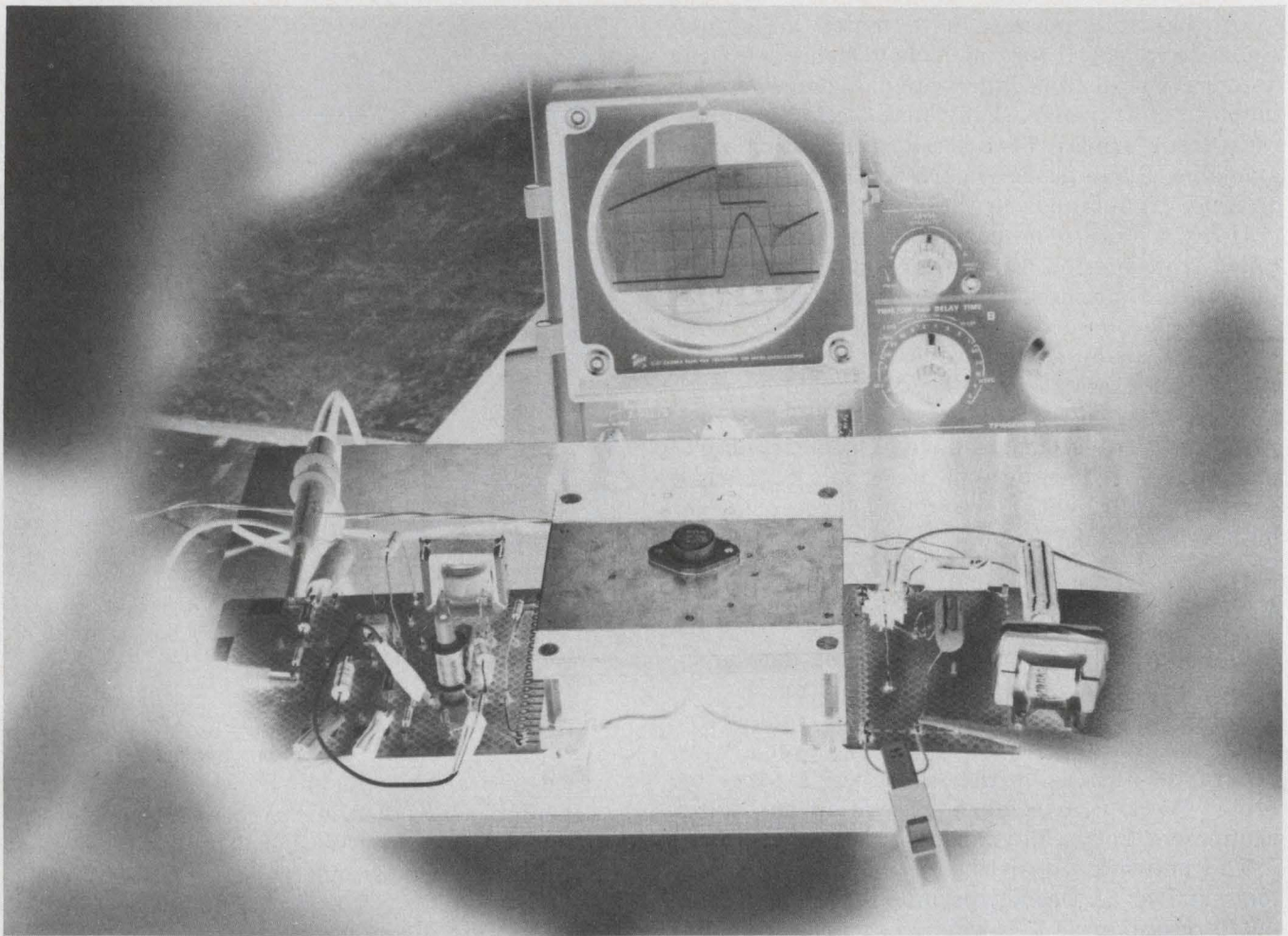

The tradeoffs between SCRs and transistors in the design of television horizontal-deflection circuits are evalu-

ated in this test setup at the RCA Solid-State Div., Somerville, NJ.

Session 5 paper entitled "High-Voltage Darlington Power Transistors in Automotive Applications." They will have to stand 400-V transients for 0.1 ms, 150 V for 1.0 ms and -75 V for 38 ms. They will also have to take 8 A of collector current, he continues. For ignition use, the collector-emitter breakdown voltage of a Darlington will have to be at least 400 V. These specs are now possible, Owens notes.

"Selecting Your High Voltage Power Transistor," a Session 5 paper by Bill Mickelopoulos from International Rectifier, El Segundo, CA, offers some guidelines on choosing these power devices.

"Selection," he says, "is complicated by the fact that although a device may be offered under the same basic family number as another device, its characteristics may differ from manufacturer to manufacturer, depending on the particular process used, size of the semiconductor chip, diffusion and passivation techniques, device geometry and other factors."

He concentrates his discussion on proper specification of the breakdown sustaining voltage; dc-current gain and saturation voltage; reverse-

biased second-breakdown energy; and unclamped, clamped and forward-biased second-breakdown energy.

"Gate-turn-off SCRs have really come of age," reports Mel Kravitz of Trio Laboratories, Plainview, NY. He describes switching-power-supply designs using GTO/SCRs that switch at 20 kHz and deliver 150 and 300 W. He also shows how to handle up to 800 V at 5 A and switch in less than 1  $\mu$ s. Kravitz feels that the GTO/SCR is unsurpassed for fast switching 400 V and higher. He notes that push-pull supplies can now be built with an input dynamic range of better than 2:1 and a regulation of at least 0.1%.

#### How to make circuits radiation tolerant

"The best way to design a linear-power-transistor circuit that is radiation-hardened, is to select high  $f_T$  transistors operating on the  $I_C$  vs  $\beta$  curve just beyond where  $\beta$  peaks. A high derating factor for  $I_C$  should not be used for linear circuits. Conversely, for digital circuits the lower the  $I_C$  the harder the circuit," note C. E. O'Neil and A. J. Chesavage in their Session 5 paper,



**Diodes and SCRs in Hockey-Puck packages** have current ratings into the thousands of amps. Mounting considerations for this type of device are covered in a Session 16 paper.

“Characteristics of Power Transistors in Neutron and Ionizing Radiation and Environments.”

“To minimize the probability of damage from high levels of photocurrent generation, external current limiting is effective. The penalties paid for current limiting are usually minor,” they point out. Neutrons are the dominant factor of permanent degradation in power transistors. From specified electrical characteristics, the best indicator of neutron tolerance has been shown to be gain-bandwidth product ( $f_T$ ).

Frequently, hardness and the safe-operating region of a power transistor conflict, particularly for inductive loads. One paradox is that neutron hardness requires a thin base, even though a thick base is harder for ionizing radiation.

Fortunately, such other geometry alterations as decreasing the base-sheet; resistivity or the emitter's strip-width can be used, say the authors, to decrease photocurrent generation without sacrificing neutron hardness. Two examples of moderately priced neutron and ionizing radiation hard transistors are the 2N5262 and the 2N5038 families.

### **Making efficient switching supplies**

“Probably the most significant factor in the development of efficient switching-power supplies that are competitively priced, has been the availability of high voltage, fast-switching power transistors such as the 2N6342-45 family,” contends Derek Chambers of the Sorensen Co., Manchester, NH, in his Session 16 paper, “Measurement and Efficient Analysis of Losses in Switching Regulators.”

The use of these and similar devices has enabled the cost of switching regulators to approach that of series-pass regulators at moderate and high-output power levels (200 W to 1 kW), Chambers says.

He lists the power-transistor characteristics that allow the design of an efficient (better than 75%) switching-power supply:

- fast switching speed (20 kHz or above),
- high collector-voltage ratings,
- large, safe operating area,
- good secondary-breakdown capability,
- low saturation voltage.

To obtain maximum switching speed and efficiency, the collectors of the switching transistors should be kept just out of saturation when conducting, according to Chambers. This mode of operation reduces storage time and minimizes its variation under different load conditions and from one device to another.

The trade-offs between SCRs and transistors in the design of horizontal-deflection circuits is the subject treated by Wally Deitz and Thomas McNulty of the RCA Solid State Div., Somerville, NJ, in their Session 16 paper, “Trade-Offs Between SCRs and Transistors in Horizontal Deflection Circuits.” They note that the main difficulty in the design of transistor deflection circuits is the base-drive circuit. In SCR designs, it is the need for commutation circuitry to turn off the SCR. Gate-turn-off SCRs can't handle the required voltages yet for this type of circuit.

Each design has certain advantages, says Deitz. Transistor circuits are easier to design, need less magnetics and take 4 to 5 W less input power. SCR circuits yield better high-voltage regulation, have more current safety margin and have better line isolation. The authors do not recommend one technique over another. They merely detail the trade-offs and leave the decision to the circuit designer.

“Power Schottky diodes are relative newcomers to the power scene,” remarks Bryan Bixby of International Rectifier, El Segundo, CA. He discusses reliability problems with these devices in his Session 16 paper.

“Although Schottky diodes are starting to find wide use they still suffer from an unexplained failure mechanism. Occasional collapses in the reverse-voltage characteristic of the devices are yet to be understood.”

Because of this phenomenon, Bixby recommends that a 24-hour burn-in be performed to eliminate at least some of the potential failures. If a device doesn't fail in the first 24 hours, there is a good chance that it never will.

If reliability is the key concern, says Bixby, conventional p-n diodes are still better.

“Mounting Considerations for High Current

Hockey-Puk SCRs and Diodes," the final paper in Session 16, is written by International Rectifier's Arthur Connolly and Sam Pollack. The paper notes that mounting Hockey-Puk packages has always been troublesome.

"The Hockey-Puk is a pressure-mounted power semiconductor in which an external force is applied to achieve the proper internal and external electrical and thermal contacts," the authors

state. "Superior heat transfer occurs because double-sided cooling results in a very low thermal impedance.

"In addition, elimination of solder joints considerably improves the ability to withstand thermal cycling." They describe a method of carefully adjusting the pressure applied as the device is mounted between a pair of heat-exchangers. ■■

---

## MICROWAVES

---

# *U.S. engineers take a second look at European radar and ECCM designs*

---

You can't design military radar without providing it with a built-in capability to defend itself from enemy electronic countermeasures. Two sessions will be held to bring you up to date on both radar design and the design of electronic counter-countermeasures: Session 25, "Trends in Modern Radar System Design," and Session 30, "Radar Electronic Counter-Countermeasures (ECCM)."

Trends in European radar technology are becoming more and more interesting to United States designers, according to Robert Hill, Naval Sea Systems Command, Washington, DC, who leads off Session 25.

"We see a firm base in automation with good 2D, and more recently 3D radar in England and Italy," he says. "There is a thorough array-technology base in the Netherlands, the recent emergence of whole-system work in West Germany, and an attempt to acquire a working phased-array radar system soon in France. A forecast of similar trends for air traffic systems, including complex adaptive systems with multi-static configurations, was made by Plessey of England."

There's been significant work in Great Britain on moving-target indication and low sidelobe antennas, Hill says. Except for Plessey, which has steadily pursued its well-automated AR-3D system, there's been less emphasis on 3D until recently. High-quality 2D systems, have been more consistent in the U.K., as have back-to-back systems and line feeds for precise control of azimuth sidelobes and stabilization at sea.



The U.S. fleet's air defense system, Aegis, developed by RCA, includes a phased-array radar, AN/SPY-1, that automatically detects and tracks multiple targets while maintaining surveillance coverage of the air.



Hill points out a number of design approaches that seem more popular in Europe than in the United States: line feeds and singly-curved reflectors (Marconi); Nyquist rate-scanning (RRE, Marconi); stainless-steel construction to prevent corrosion problems at sea (HSA); emphasis on polarization control and circular polarization as desirable features (Plessey, HSA, Telefunken, Selenia); use of hydraulic drive (Telefunken, Philips); multiple antennas on common mounts (Marconi, HSA); and an apparent pride in mechanical work.

Another European trend cited by Hill is the use of surface acoustic-wave devices in signal processing.

Europeans are more inclined to incorporate technical advances into established company product lines; in the United States, advances are allowed to accumulate until a new generation radar is built.

As for air traffic control, Hill says there seems to be a closer liaison in Europe than in the United States between what's being done for civil aviation and what's under way for the military.

### Converting solar energy to microwaves

Larger power aperture is very likely to continue as an important trend in phased-array radar, predicts Peter Kahrilas, consulting scientist at Raytheon's Missile Systems Div., Bedford, MA, in his paper, "Phased-array Radar Trends."

Phased-array technology is particularly applicable to systems requiring very large power aperture with steerable beams—for example, to convert solar energy in space to microwave energy, and then beam it to earth. The high efficiency provided by a phased array is required to make the project economically feasible.

Another trend is multifunction radar applications requiring hemispherical coverage for ground, shipborne and airborne applications, Kahrilas says.

Existing phased-array technology provides hemispherical coverage by using a pencil-beam that is electronically scanned in elevation and mechanically rotated in azimuth. For more demanding applications, by using four-planar arrays, a spherical geodesic lens, or dome-lens technology can be used.

The demand for equipment that can handle steadily increasing target densities, however, is straining the capability of most present-day radars, especially those providing hemispherical coverage.

A technical innovation is required, Kahrilas says, to create a simple and inexpensive electronic-scanning technique for multibeam hemispherical coverage.

The trend toward using solid-state components

in transmitter modules has been slow because of the resulting low-power output, the high duty-cycle continuous-wave nature of operation and the poor performance at higher-frequency bands. These undesirable characteristics limit the possible power aperture, peak power, waveform and operation-frequency selection. Technological improvement in these areas is needed, Kahrilas says.

There is a trend toward cutting the cost of all components used in phased-array radar, particularly the cost of phase shifters and their drivers, since they are a large portion of the array cost. Improvements are likely to continue in the material, design and manufacturing processes of phase shifters. One effort is to reduce costs by reducing drive power, insertion loss and size, and by increasing microwave power capacity and reliability.

### Microprocessors are making inroads

Integrated circuits are becoming widely used in phased-array radars, Kahrilas says. And as denser chips become cheaper, more sophisticated microcomputer architecture can be expected. Larger read/write memories, for example, will be available on microprocessor chips.

In phased-array radar designs, microprocessors are already replacing conventional circuits for control of system self test diagnostics, beam steering units and signal processors. High speed ICs are used to perform the FET function in signal processors.

The increasing use of ICs is shifting a phased-array radar from control by a single computer to a more economical system that contains a main computer and several microprocessors.

Over the past few years inexpensive solid-state components have been introduced to make possible the design and construction of digital signal processors only dreamed of in the past, says Charles E. Muehe, MIT, Lincoln Laboratory, Lexington, MA.

Changes have come especially fast in radar, Muehe says, where doppler filtering was usually limited to analog or digital delay-line cancellers. Now inexpensive components allow the construction in each range-azimuth resolution cell of digital filters that markedly improve the signal-to-ground clutter ratio for each target velocity.

Muehe describes a digital signal processor called the Moving Target Detector (MTD), which is designed to improve the FAA's airport surveillance radars.

In using the MTD the signal to be processed is taken from the output of the intermediate frequency preamplifier and fed through a special linear, wide-dynamic-range amplifier to the quadrature video detectors. The two quadrature video-detector outputs are converted to 10-bit digital

numbers by a-to-d converters and hence into the digital processor. The MTD contains an 8000-word input memory and about 900 ICs. A disc memory is used as a fine-grained ground-clutter map. The parts cost total is approximately \$25,000.

The MTD achieves its superior performance principally through fine-resolution linear-filtering and adaptive-thresholding techniques.

The filters have been tailored to reject ground clutter by using wide-dynamic, linear, range processing. The result is much better moving-target indication than achieved by present-day airport surveillance radars.

### Phased-array for the range?

Range-instrumentation radars of the future will have to track multiple targets simultaneously and cost less, says Josh T. Nessmith, Systems Manager, RCA Government and Commercial Systems, Missile and Surface Radar Div., Moorestown, NJ.

Phased-array radar, either with a limited scan or a full scan, offers a potential for meeting some of the future requirements of the range, Nessmith says. The phased-array presents an opportunity for direct integration of multiple tracks and the metric data associated with each track.

The question, Nessmith says, is whether a single phased-array radar would be more cost effective than an integrated group of single-target or limited-scan-array radars.

At the very outset of the design phase, the designer faces the fact that the life of the system design is at least 25 years, while the gestation period of a countermeasure is a year or two in peace time and a few weeks during war.

How to live with these conditions is discussed by Matthew F. Radford, Marconi Research Laboratories, Great Baddow, Essex, England, in "Radar ECCM—A European Approach."

The designer can't possibly know in advance the precise nature of the threats his system will be called upon to face, Radford emphasizes. He does know, however, that any fundamental weakness in his design is likely to be discovered very quickly and exploited.

The first task then, is to build a system with optimum resistance to ECM and to avoid built-in limitations that could restrict the choice of operational routines or provide openings for future ECM.

Radford cites four other problems the designer faces:

- ECM may affect his own side's defensive radars;
- Airborne ECM may reduce the sensitivity of homing and warning receivers;
- Responsive jammers may respond to each other; and

- Airborne ECM may interface with terrain-avoidance radar.

### The pros and cons of adaptive control

When confronted by jamming or chaff, Radford says, search performance can be improved by adaptive electronic control of the antenna beam. But practical methods of electronic scanning will penalize ECM resistance in other ways. For one thing, the maximum available antenna bandwidth is significantly reduced.

Transmission losses are inevitably increased by electronic scanning. A frequency-scanned antenna uses a dispersive line in which an appreciable amount of energy is stored, and this storage results in a predictable heat loss. Waveguide delay lines are the least subject to loss, according to Radford, but they are bulky. With compact folded lines, it's unlikely that a minimum additional loss of about 1 dB will be introduced.

Phased arrays have phase-shifter losses that are likely to be around 1.5 dB in a typical antenna of simple design. Losses may be higher if the design incorporates dielectric loading or lossy microstrip dipole radiators.

Taking all of these factors together, a fully adaptive phased-array antenna may have a disadvantage of as much as 10 dB on basic ECCM parameter values. The disadvantage cancels out at least part of the potential advantage of adaptive dwell time.

Radford describes some of the achievements that have been made in European radar:

- Transmitters: To permit the use of advanced, coherent-ECCM processing techniques, transmitters have been designed with unusually clean spectra. A typical high-power transmitter has intra-spectral-line noise 120 dB below the peak pulse output.

- Low-sidelobe antennas: The objective of 35-dB sidelobe protection and 30% bandwidth has been reached. The antenna can handle high power and can be adapted to provide a difference channel for monopulse operation.

- Multiple-beam antennas: A number of ways have been found to generate multiple beams without undue loss of sidelobe protection. Multiple-beam antennas are particularly effective against deception jamming, since they always observe the true jammer position.

- Data handling and control: There are families of modular digital processors that can be re-programmed or extended during the service life of the radar, thus enabling additional ECCM to be added as required.

Radford concludes that unless the application requires adaptivity for some special task, a relatively simple radar may be as cost-effective in ECM as a more complex adaptive system. ■■



## Microcomputers made easy. Easier. And easiest.

Our LSI-11, the machine on the left, makes getting into microcomputers easy.

You start with 16 bits and 4K of RAM, all ready-to-go on an 8½" x 10" board. You pay just \$634\* in 100's. You solve the tough make-or-buy problem easily. And you can use all the fully-developed software from our famous PDP-11 family.

But if you want things even easier, you can buy your LSI-11 in a box, complete with power supply and fans. It's called the PDP-11/03, it's the one in the middle, and it costs just \$2495 in single quantities.

Easiest of all, especially for complex systems development, is the PDP-11V03 on the right. It gives you a roll-around cabinet with an 8K LSI-11 in a box, an RXV-11 Dual Floppy Disc Drive and bootstrap for mass program storage, and our RT11 operating system — plus your choice of video or hard-copy keyboard terminal. It sells for a low package price of just \$10,450 in single quantities.

Of course, once you see how much the LSI-11 in these last two models can do, you can go back to the board version for your production run.

And at \$634, that's not hard to

take either.

For more info, call 800-225-9480 (Mass. 617-481-7400 ext. 6819 or 6817). Or write: Components Group, Digital Equipment Corp., One Iron Way, Marlborough, MA 01752. Canada: Digital Equipment of Canada, Ltd. Europe: 81 Route de l'Aire, 1211 Geneva 26, Tel. 42 79 50.

\*Prices apply to USA only.

**digital**  
**COMPONENTS**  
**GROUP**

# Our curve was straight.

Advanced Micro Devices announces the 100-piece price for the Am9080A and Am2901: \$21.00.  
Just like we said.

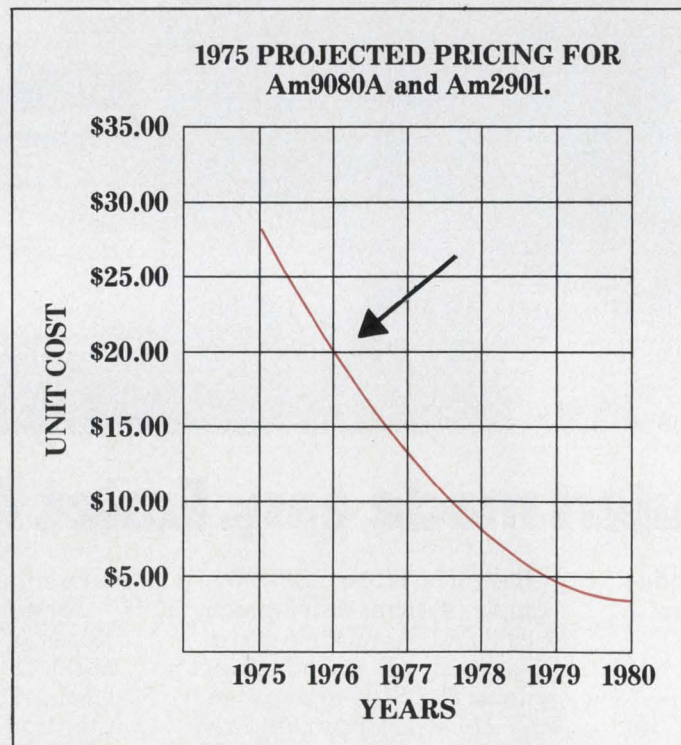

Last year, we predicted the price would be just over \$20.00. We even drew a curve. Now it's happened. And that's only the beginning. Look:

**Am9080A.** It's built with an advanced ion-implanted, n-channel, silicon-gate process that permits versions with speeds to 250 nanoseconds cycle time (one microsecond instruction time). Our low power (800mW maximum) gives you cooler running systems, less power drain and better reliability. The superior output drive (3.2mA @ 0.4V) gives increased design flexibility and improved margins.

**Am2901.** It's bipolar, for systems that rely on

high speed. It can do a 16-bit register-to-register add in just 145 nanoseconds. It has 16 working registers in a cycle-saving, two-address architecture, and is controlled by nine instruction lines that permit it to do almost anything you can think of.

**Another thing.** Advanced Micro Devices offers a full line of support circuits for either unit—support circuits that optimize your system, not compromise it.

Whether you can best use the MOS Am9080A or the bipolar Am2901, you can now do it for less. **\$21.00** in 100-piece quantities.

Just like the curve said:

### Am9080A System Circuits

AMD Part Number	Description	Availability
<b>CPU</b>		
Am9080A/-2/-1/-4	Speeds to 250 nsec 0 to 70°C	In Dist. Stock
Am9080A/-2	Speeds to 380 nsec -55 to +125°C	In Dist. Stock
<b>Static Read/Write Random Access Memories</b>		
Am9101A/B/C/D	256x4 Speeds to 250 nsec	In Dist. Stock
Am91L01A/B/C	256x4 Speeds to 300 nsec	In Dist. Stock
Am9102A/B/C/D	1Kx1 Speeds to 250 nsec	In Dist. Stock
Am91L02A/B/C	1Kx1 Speeds to 300 nsec	In Dist. Stock
Am9111A/B/C/D	256x4 Speeds to 250 nsec	In Dist. Stock
Am91L11A/B/C	256x4 Speeds to 300 nsec	In Dist. Stock
Am9112A/B/C/D	256x4 Speeds to 250 nsec	In Dist. Stock
Am91L12A/B/C	256x4 Speeds to 300 nsec	In Dist. Stock
Am9130A/B/C/E	1024x4 Speeds to 200 nsec	In Dist. Stock
Am9140A/B/C/E	4096x1 Speeds to 200 nsec	In Dist. Stock
<b>Dynamic Read/Write Random Access Memories</b>		
Am9050C/D/E	4Kx1 Speeds to 200 nsec	In Dist. Stock
Am9060C/D/E	4Kx1 Speeds to 200 nsec	In Dist. Stock
<b>Mask Programmable Read-Only Memories</b>		
Am9208/B/C/D	1Kx8 Speeds to 250 nsec	Available Now
Am9214	512x8 mask programmed Speeds to 500 nsec	Available Now
Am9216B/C	2Kx8 mask programmed Speeds to 300 nsec	Available Now
<b>Erasurable Read-Only Memories</b>		
Am9702	256x8 Speeds to 1.0 μsec	In Dist. Stock
Am1702A	256x8 Speeds to 1.0 μsec	In Dist. Stock
Am2708	1024x8 Speeds to 450 μsec	2nd Q. 1976

AMD Part Number	Description	Availability
<b>Processor System Support Circuits</b>		
Am8212	8-bit I/O Port	In Dist. Stock
Am8224	Clock Generator	In Dist. Stock
Am8228	System Controller	2nd Q. 1976
Am8216/26	Bus Transceiver	2nd Q. 1976
Am25LS138	1 of 8 Decoder	In Dist. Stock
Am9555	Programmable Peripheral Interface	2nd Q. 1976
Am9551	Serial Communications Interface	2nd Q. 1976

CPU: 9080A=480 nsec -2=380 nsec -1=320 nsec -4=250 nsec  
Mem: A=500 nsec B=400 nsec C=300 nsec D=250 nsec E=200 nsec

### Am2900 System Circuits

AMD Part Number	Description	Availability
Am2901	4-Bit Microprocessor Slice	In Dist. Stock
Am2902	Carry Lookahead Chip	In Dist. Stock
Am2905	4-Bit Transceiver For Open Collector Bus	In Dist. Stock
Am2906	4-Bit Transceiver For Open Collector Bus With Parity Generator/Checker	In Dist. Stock
Am2907	4-Bit Transceiver For Open Collector Bus With Single Data Input	In Dist. Stock
Am2909	Microprogram Sequencer	In Dist. Stock
Am2911	Minimicroprogram Sequencer	2nd Q. 1976
Am2914	8-Level Priority Interrupt	3rd Q. 1976
Am2915	4-Bit Transceiver For Three-State Bus	2nd Q. 1976
Am2916	4-Bit Transceiver For Three-State Bus With Parity Generator/Checker	2nd Q. 1976
Am2917	4-Bit Transceiver For Three-State Bus With Single Data Input	2nd Q. 1976
Am2918	1 By 2 Port Register	In Dist. Stock
Am2919	Priority Interrupt Expander	2nd Q. 1976
Am2950/51	256-Bit RAM, Open Collector Or Three-State	In Dist. Stock
Am2952	1024-Bit RAM, Open Collector	2nd Q. 1976
Am2954/55	16-Word By 4-Bit Two Address Register Stack, Open Collector or Three-State	2nd Q. 1976
Am2970/71	256 By 4 PROM's With Open Collector or Three-State Outputs	In Dist. Stock

# Advanced Microprocessors

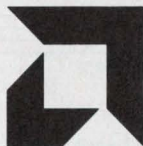

Advanced Micro Devices • 901 Thompson Place, Sunnyvale, California 94086 • Telephone (408) 732-2400

Distributed nationally by Hamilton/Avnet, Cramer and Schweber Electronics

CIRCLE NUMBER 47

### Build a compact microcomputer by starting with a $\mu$ P like the 8080 and surrounding it with peripheral LSI interfaces that can be programmed for specific jobs.

Systems based on the single-chip 8080  $\mu$ P can be built with far fewer components than has been possible until now. What makes the parts reduction possible is the availability of programmable LSI interface circuits.

These programmable I/O and peripheral devices provide the means to standardize hardware designs for system interfaces. They can be used to upgrade or replace specialized logic assemblies involving scores of conventional digital circuits.

An additional benefit of these peripheral LSI circuits: they simplify microcomputer design. Since the bus standardizes the internal interface structure, a system designer's main task reduces to that of organizing external interface and inter-

rupt structures. The complete 8080 system can be used as an interrupt-driven system in on-line computation and control applications.

#### Basic system components

The 8080 microcomputer system (MCS-80) consists of a family of n-channel MOS and Schottky-bipolar devices, and development support products (Tables 1 and 2). It is based on the 8080A CPU group, which consists of an 8080A 8-bit central processing unit, an 8224 clock generator and an 8228 system controller. The CPU can directly address up to 65,536 bytes of memory and 512 I/O ports (256 input, 256 output ports).

Bipolar timing, bus control and drive functions normally required to support the CPU are integrated into the 8224 and 8228. Major I/O

A. J. Nichols, Manager, Microcomputer Applications, Kenneth McKenzie, Manager, MCS-80 Microcomputer System, Intel, 3065 Bowers Ave., Santa Clara, CA 95051.

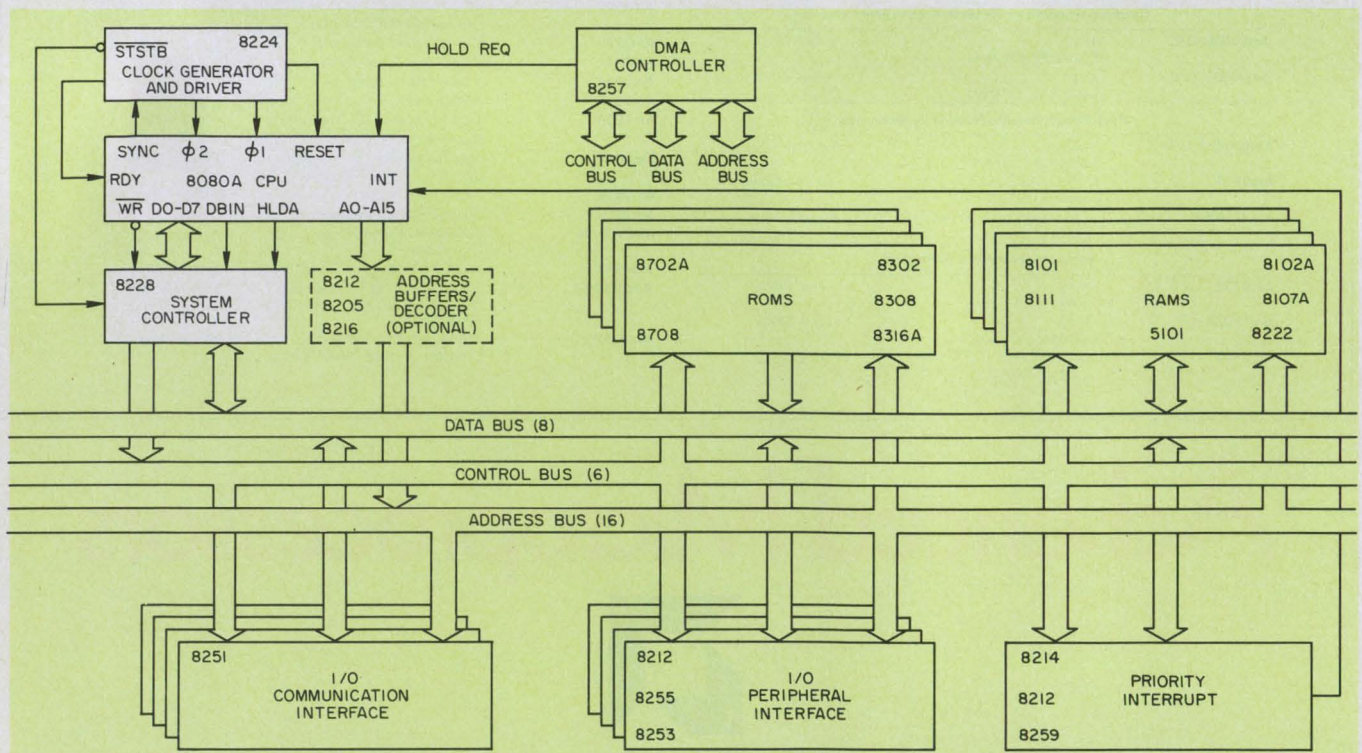

1. The 8080 microcomputer system features a modular organization, based on a bus standardized by the 8080

CPU group—the 8224 clock generator and driver, 8228 system controller and 8080A.

**Table 1. MCS-80 system components**

Function	Type	Pins	Name/specification
CPU Group	8080A	40	8-bit CPU, 2- $\mu$ s cycle
	8224	16	Clock generator
	8228/38	28	System controller
CPU Options	8080A-1	40	1.3- $\mu$ s instruction cycle
	8080A-2	40	1.5- $\mu$ s instruction cycle
	M8080A	40	2 $\mu$ s, -55 to 125 C
Input/Output	8212	24	8-bit I/O port
	8251	28	Programmable communication interface
	8255	40	Programmable peripheral interface
Peripherals	8205	16	1-of-8 binary decoder
	8214	24	Priority interrupt-control unit
	8216	16	4-bit bidirectional bus driver (50 mA), non-inverting
	8226	16	4-bit bidirectional bus driver (50 mA), inverting
	8222	22	Dynamic RAM refresh controller (for 8107B)
	8253	24	Programmable interval timer
	8257	40	Programmable DMA controller
EPROMs	8702A	24	2 k (512 $\times$ 8), 1.3- $\mu$ s access
	8708	24	8 k (1024 $\times$ 8), 450-ns access
ROMs	8302	24	2 k (512 $\times$ 8) 1- $\mu$ s access
	8308	24	8 k (1024 $\times$ 8), 450-ns access
	8316A	24	16 k (2048 $\times$ 8), 850-ns access
CMOS static RAMs (all 650-ns access)	5101	22	256 $\times$ 4, 15 nA/bit standby
	5101-3	22	256 $\times$ 4, 200 nA/bit standby
	5101L	22	256 $\times$ 4, data retained at 2 V <sub>CC</sub> , 15 nA/bit
	5101L-3	22	256 $\times$ 4, data retained at 2 V <sub>CC</sub> , 200 nA/bit
NMOS Static RAMs	8101-2	22	256 $\times$ 4, 850-ns access
	8102A-4	16	1024 $\times$ 1, 450-ns access
	8102A-6	16	1024 $\times$ 1, 650-ns access
	8111-2	18	256 $\times$ 4, 850-ns access
Dynamic RAMs	8107B	22	4 k (4096 $\times$ 1), 420-ns access
	8107B-4	22	4 k (4096 $\times$ 1), 270-ns access

Note: All access times are maximum values

**Table 2. Microcomputer-system support products**

Microcomputer Development System (MDS) and peripherals	8080 system with interrupt and DMA control, expandable memory and I/O Diskette system ROM simulator Universal PROM programmer CRT console Line printer High-speed paper-tape punch High-speed paper-tape reader Teletypewriter
ICE-80 In-Circuit Emulator	Used with MDS for in-circuit hardware/software debugging in product's own environment
MDS Resident Software Packages	System monitor supports diagnostic aids and real-time checkout; controls system and drives peripherals Macro assembler translates symbolic assembly language to machine code, provides full macro and conditional assembly Text editor supports program entry and correction; includes string search, substitution, insertion and deletion commands DOS (Diskette Operating System) supports symbolic file management for development of programs and filing of data such as diagnostic information ICE-80 supports debugging with English-language type commands ROM-SIM supports the ROM simulator (a high-speed RAM memory)
Cross-product software packages	PL/M cross compiler MAC-80 cross compiler provides full macro and conditional assembly INTERP/80 simulator supports program-execution simulation and debugging
SDK-80 System Design Kit	Contains all components and software required to assemble and operate a basic 8080 system
SBC-80/10	Single-board computer
Manuals	80 Microcomputer Systems User's Manual Intellec MDS Hardware Reference Manual Intellec MDS Operator's Manual 8080 Assembly Language Programming Manual PL/M Programming Manual MAC-80 User's Manual INTERP/80 User's Manual

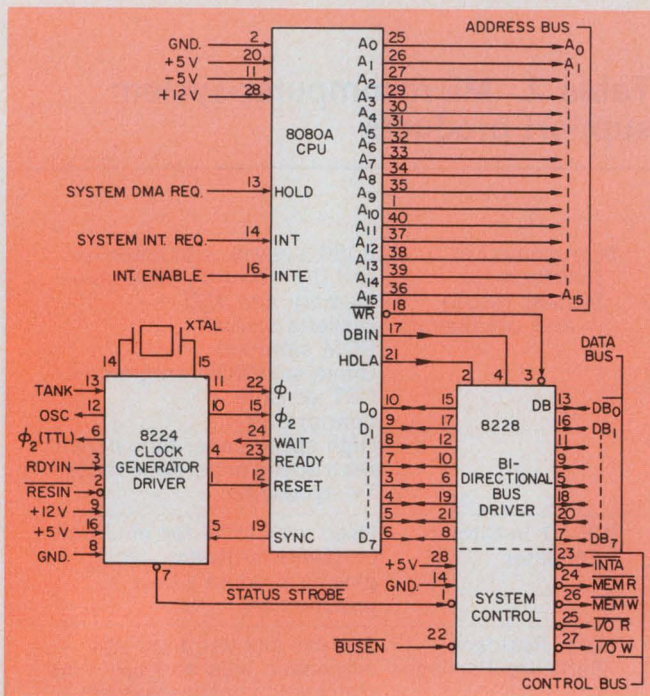

2. The CPU group connects to the address, data and control busses—the three elements of the system bus. The Interrupt Acknowledge output of the 8228 may be tied to 12 V through a 1-k $\Omega$  resistor and used as a vectored single-level interrupt control.

and peripheral units are programmable: they are both configured and controlled by software. The I/O units provide serial data and parallel I/O; the peripheral units augment the CPU group's control capability by managing multilevel interrupts, peripheral-service timings, and direct-memory access (DMA). Memory components have industry-standard configurations.

The CPU options provide typical instruction cycle times as low as 1.35  $\mu$ s in the commercial temperature range and 2  $\mu$ s in the military range (M8080A). Introduced in 1974 as the first NMOS CPU, the 8080 has become an industry standard. It now accounts for more than half of all microcomputer applications, and components are being widely second-sourced.

### Microcomputer architecture

The 8080-based microcomputer features a modular architecture (Fig. 1). The CPU group represents the only dedicated components in the  $\mu$ C (Fig. 2). The remaining subsystems—memory, I/O and peripheral control—are modular. They are constructed by use of other components in building-block fashion on the bus.

The CPU group standardizes system-bus control logic and ac timing and dc electrical characteristics. Other components interface directly with the group via the bus. Thus, the over-all design is comparable to that of a computer with standardized "mainframe" logic and modular

peripherals that plug into the bus.

The system bus consists of three groups of interconnections: A<sub>0</sub> to A<sub>15</sub>, a three-state bus used by the CPU to address memory locations and to select ports; DB<sub>0</sub> to DB<sub>7</sub>, a bidirectional, three-state bus driven by the 8228 and used for all information transfers; and the control bus. The latter includes control lines operated by the 8228, which gates selected devices on and off the data bus.

The bus is TTL compatible and is driven by the CPU group at or above TTL drive levels (1.9 mA on all 8080A outputs and typically 10 mA for the 8228). In general, bus buffers—or bi-directional driver and decoder units—are required only in large systems.

The CPU group performs the following:

- Makes all CPU inputs essentially asynchronous. Selected device operations align with CPU operations regardless of the device's operating times.

- Stabilizes the data bus to ensure the validity of transferred data.

- Sinks and sources the currents required to maintain direct component-to-bus interfacing as the system expands outward from the CPU group.

### Programmable peripherals

The key I/O and peripheral devices are these:

- 8255 programmable peripheral interface, which provides three ports (24 lines) for parallel I/O and control.

- 8251 programmable communications interface, a universal synchronous/asynchronous receiver/transmitter (USART) for serial data I/O.

- 8259 programmable interrupt controller, which allows eight levels of priority-interrupt control, expandable to 64 levels.

- 8253 programmable interval timer, which consists of three 16-bit BCD/binary counters. The circuit may be used to set system-timing delays, replacing software-timing loops.

- 8257 programmable DMA controller, which offers four channels of direct-memory-access control for bulk-data transfers between peripheral equipment and RAM.

A designer seeking to use these devices chooses control words and algorithms from sets supplied for each device. He then adds them to the initialization or service routines of the system-application program. Initialization control words, for example, define communication and control configurations of the 8255's 24 I/O lines. Algorithms govern the priorities of the interrupt levels controlled by the 8259.

Of course, since software defines the devices' functions, it can also be used to change them. One method is to use control words as replace-



# Microprocessor architecture

The nucleus of an 8080-based system is, of course, the CPU, a single-chip, 8-bit parallel processor.

In turn, an important part of the CPU is its register section, a static RAM array organized into six 16-bit registers. The array's six 8-bit general-purpose registers (they may be addressed individually or in pairs) provide single or double-precision (16-bit) operators.

Up to 64-kilobytes of memory may be directly addressed. The stack pointer allows any portion of RAM memory to be used as an external stack, so that subroutine nesting is bounded only by memory size. The stack can be used to store the contents of the program counter, flags, accumulator and all six general-purpose registers.

The arithmetic logic unit (ALU) performs arithmetic, logic and shift/rotate operations. Associated with it are an 8-bit accumulator, and 8-bit temporary accumulator, and a 5-bit flag register (zero, carry, sign, parity, auxiliary carry). Testing the auxiliary carry for decimal correction allows decimal arithmetic to be performed.

Accumulator-group instructions include arithmetic and logic operators with direct, register-indirect and immediate-addressing modes. Move, load and store-instruction groups can be used to move either 8 or 16-bits of data between memory, the six general-purpose working registers and the accumulator. In each of these cases, the same addressing mode can be used. Jump, jump conditional and computed jumps provide program branching.

Calls to and returns from subroutines can be made conditionally and unconditionally. RST (restart) provides a single-byte Call instruction for interrupt operation. This Call saves the

contents of the program counter upon completion of the current instruction and points to any of eight memory locations usable as the start of an interrupt-service routine. RST is normally initiated by the peripheral logic, which can also generate additional Call instruction bytes for vectoring to more than eight interrupt levels.

A basic instruction cycle is four states long ( $T_1$  through  $T_4$ ). For example, adding the contents of an 8-bit general-purpose register to the accumulator (ADD r) requires three states for the instruction fetch and one state for execution. Some instructions take two execution states.

A machine cycle is required for each fetch and for each memory or I/O access. Each instruction cycle must begin with a fetch, but other machine cycles may be used in succession, between the fetch and the execution state or states.

The first machine cycle of an interrupt operation resembles a fetch but does not increment the program counter. Thus, when the peripheral logic generates the Call, the program-counter contents are automatically saved. Other system-status information can also be saved in the RAM stack. The stack pointer automatically provides for retrieval of the interrupted program address upon completion of the interrupt.

A Hold input causes the CPU to complete an instruction's execution, then come to rest. Hold is generally used during DMA operations. In this case, the CPU doesn't use the bus during the last two states ( $T_4$  and  $T_5$ ), so DMA operations can overlap instruction cycles.

A Ready input inserts a Wait state (or states) after  $T_2$ . The Halt instruction stops the CPU in the next machine cycle after  $T_2$ . A Reset, Hold or Interrupt brings the CPU out of Halt.

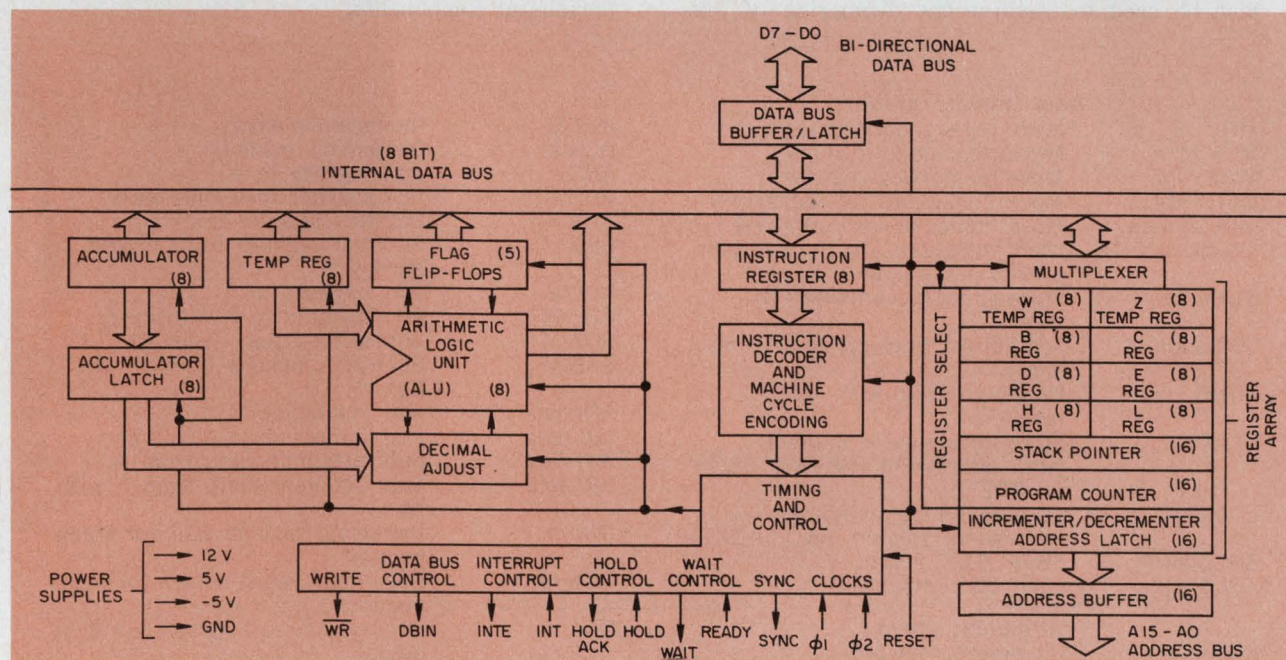

(continued on page 88)

# Instruction set and programming methods

The basic instruction set of the 8080 can be divided, for convenience, into data-transfer, arithmetic, logic and branch groups. The final division is stack, I/O and machine control (see instruction table).

The first byte of an instruction is an operation code. The op code is supplemented in many cases by one or two address or data bytes. Data stored in memory or registers may be addressed in one of four modes:

- Direct—a memory address of the data is contained in bytes 2 and 3 of the instruction;
- Register—the register or register pair containing the data is specified by the instruction;
- Register indirect—a register pair containing the data's memory address is specified by the instruction;
- Immediate—the instruction contains the data, rather than the data address.

Branch instructions specify the next instruction by containing the next instruction address (direct) or by indicating a register pair containing the next instruction address (register indirect).

Two complete sets of software packages are available to the programmer: those resident in the Intellec MDS system, and cross products (available on both computer tape and time-shared computer networks) written in ANSI-standard Fortran IV.

The cross products and resident software generate completely compatible code. Routines written with either method can be linked, emulated and debugged in the microcomputer environment with the Intellec MDS system, which can also be used to combine the debugging of pro-

```

/* BUBBLE SORT DECLARATION */
SORT PROCEDURE (N) ADDRESS
/* N = LENGTH OF A
COUNT = NR. OF SWITCHES PERFORMED TO DATE
SWITCHED = (BOOLEAN) HAVE WE DONE ANY SWITCHING YET ON THIS SCAN? */
DECLARE (N, I, SWITCHED) BYTE,
(TEMP, COUNT) ADDRESS.
SWITCHED = 1. /* SWITCHED = TRUE MEANS NOT DONE YET */
COUNT = 0.
DO WHILE SWITCHED.
SWITCHED = 0. /* BEGIN NEXT SCAN OF A */
DO I = 0 TO N-2.
IF A(I) > A(I+1) THEN
DO.
COUNT = COUNT + 1. /* FOUND A PAIR OUT OF ORDER */
SWITCHED = 1. /* SET SWITCHED = TRUE */
TEMP = A(I). /* SWITCH THEM INTO ORDER */
A(I) = A(I+1).
A(I+1) = TEMP.
END.
END.
/* HAVE NOW COMPLETED A SCAN */
END /* WHILE */
/* HAVE NOW COMPLETED A SCAN WITH NO SWITCHING */
RETURN COUNT.
END SORT.

```

A. "Bubble sort" routine written in PL/M arranges data pertaining to events according to the frequency with which individual events occur. Events occurring most frequently move to the top.

gram and hardware design.

Programs can be written with a macro assembler or PL/M compiler (PL/M is Intel's high-level programming language). The macro assemblers translate mnemonics into machine code. PL/M allows programs to be written in a natural algorithmic language and eliminates the need to allocate memory or manage register usage.

An example of a sorting routine written with PL/M appears in Fig. A. The free-form input shown is translated into 8080 object code by the compiler; the programmer can concentrate on the software design structure and system-logic requirements. Fig. B illustrates a macro-assembly approach to programming one of the peripheral components.

### Data transfer group

MOV r1, r2	Move register to register
MOV M, r	Move register to memory
MOV r, M	Move memory to register
MVI r, data	Move immediate (to register)
MVI M, data	Move immediate (to memory)
LXI rp, data 16	Load immediate (to register pair or to stack pointer)
STA addr	Store direct (accumulator to memory)
LDA addr	Load direct (memory to accumulator)
XCHG	Exchange H&L with D&E registers
STAX rp	Store accumulator indirect (with address in registers B&C or D&E)
LDAX rp	Load accumulator indirect (with address in registers B&C or D&E)
SHLD addr	Store H&L direct
LHLD addr	Load H&L direct

### Arithmetic group

INR r	Increment register
DCR r	Decrement register

INR M	Increment memory
DCR M	Decrement memory
ADD r	Add register to A
ADC r	Add register to A with carry
SUB r	Subtract register from A
SBB r	Subtract register from A with borrow
ADD M	Add memory to A
ADC M	Add memory to A with carry
SUB M	Subtract memory from A
SBB M	Subtract memory from A with borrow
ADI data	Add immediate to A
ACI data	Add immediate to A with carry
SUI data	Subtract immediate from A
SBI data	Subtract immediate from A with borrow
INX rp	Increment register pair (or stack pointer)
DCX rp	Decrement register pair (or stack pointer)
DAA	Decimal adjust A (gives two BCD digits)
DAD rp	Add B&C, D&E or H&L to H&L

```
;          MODE INSTRUCTION
;          =====
;
;          2 STOP BITS
;          PARITY DISABLED
;          8 BIT CHARACTERS
;          BAUD RATE FACTOR OF 64
;
;          COMMAND INSTRUCTION
;          =====
;
;          NO HUNT MODE
;          NOT(RTS) FORCED TO 0
;          RECEIVE ENABLED
;          DATA TERMINAL READY
;          TRANSMIT ENABLED
;
0000      3ECF      MVI      A,MODE
0002      D3FB      OUT      CNCTL ; OUTPUT MODE SET TO USART
0004      3E27      MVI      A,CMD
0006      D3FB      OUT      CNCTL ; OUTPUT COMMAND WORD TO USART

```

(a)

```
; FUNCTION: CI
; INPUTS: NONE
; OUTPUTS: A - CHARACTER FROM CONSOLE
; CALLS: NOTHING
; DESTROYS: A,F/F'S
; DESCRIPTION: CI WAITS UNTIL A CHARACTER HAS BEEN ENTERED AT THE
;              CONSOLE AND THEN RETURNS THE CHARACTER, VIA THE A
;              REGISTER, TO THE CALLING ROUTINE. THIS ROUTINE
;              IS CALLED BY THE USER VIA A JUMP TABLE IN RAM.
;
01D0      CI:

```

```
01D0      DBFB      IN      CONST ; GET STATUS OF CONSOLE
01D2      E602      ANI      RBR   ; CHECK FOR RECEIVER BUFFER READY
01D4      CAD001    JZ      CI    ; NOT YET - WAIT
01D7      DBFA      IN      CNIN  ; READY SO GET CHARACTER
01D9      C9        RET

```

(b)

B. Typical routines for the 8251 programmable communications interface are written with the 8080's macro assembler. The first routine (a) ini-

tializes the circuit. The second (b) specifies the input character, C1. Another program, similar to (b), specifies the output character.

Logic group		
ANA r	AND register with A	positive, minus, even or odd parity)
XRA r	EXCLUSIVE-OR register with A	CALL addr
ORA r	OR register with A	Ccond addr
CMP r	Compare register with A	RET
ANA M	AND memory with A	Return
XRA M	EXCLUSIVE-OR memory with A	Rcond
ORA M	OR memory with A	Return on condition specified (see above)
CMP M	Compare memory with A	RST
ANI data	AND immediate with A	Restart
XRI data	EXCLUSIVE-OR immediate with A	PCHL
ORI data	OR immediate with A	H&L to program counter
CPI data	Compare immediate with A	
RLC	Rotate A left	
RRC	Rotate A right	
RAL	Rotate A left through carry	
RAR	Rotate A right through carry	
CMA	Complement A	
STC	Set carry	
CMC	Complement carry	
Branch group		
JMP addr	Jump unconditional	
Jcond addr	Jump on condition specified (carry, no carry, zero, no zero,	

Stack, I/O and machine control group	
HLT	Halt
IN port	Input (from port to A)
OUT port	Output (from A to port)
PUSH rp	Push register pair on stack (in memory)
PUSH PSW	Push A and flags on stack
POP rp	Pop register pair off stack
POP PSW	Pop A and flags off stack
XTHL	Exchange top of stack with H&L
SPHL	Move H&L to stack pointer
EI	Enable interrupts
DI	Disable interrupts
NOP	No op

able software modules. One set of basic hardware can then be used with various peripheral equipment in different end-products.

Furthermore, operating modes can be changed "on the fly" during system operation. This feature permits dynamic changes in priority levels, thereby enhancing a system's real-time response. When the CPU determines that particular types of services become more critical than others, it can rearrange the priorities.

All units contain internal control logic and "housekeeping" functions. These reduce CPU overhead software. They enable the CPU to manage the I/O structure with acknowledgements and operating commands after receiving requests

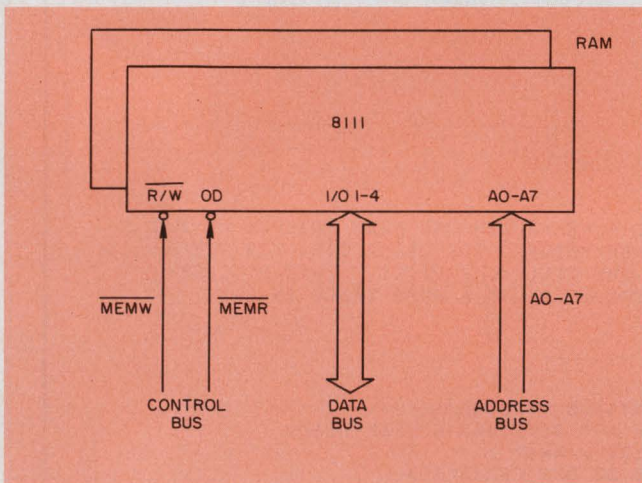

3. In a typical memory interface to the system bus, two 8111, 256 × 4-bit, static RAMs are operated in parallel to provide byte-wide data.

for service (interrupt and DMA). Thus they help the CPU perform an increased number of real-time tasks.

### Two ways to handle interrupts

All I/O devices, including the 8253 timer, can generate interrupt requests. The 8080 handles interrupts in one of two ways: vectored interrupts and Call structures. In the first case, a vector instruction (RST) "points" the program counter to the specific memory locations to be used as the starting points of service routines. RST acts as a program Call. The vector instruction is generated by an interrupt-control device, and up to eight branches can occur.

In the second case, the CPU's regular Call structure may still be used. Thus, any location in memory can be the start of a service routine and the number of interrupt levels is bounded only by memory size. Again, the interrupt-control device generates the Call instruction.

Implementing the interrupt-handling tech-

niques are these circuits:

- 8228 system controller, which generates one vector (RST 7). This provides a single-level interrupt control built into the CPU group.

- 8259 programmable interrupt controller, which generates eight Call vectors and can be cascaded for up to 64 service levels.

- 8214 priority-interrupt control unit, which is similar to the 8259, but has fixed priorities, and can be expanded from 8 to 40 levels.

The interface structure may be isolated from memory or may share the memory-address space. This gives the programmer the option of using either I/O or memory-reference instructions (that read, write or operate on data in memory) for I/O operations. Memory-reference instructions can significantly increase throughput in applications requiring frequent I/O data manipulations. Also, they allow more ports to be addressed without decoding, thereby reducing component count.

When a DMA Request is acknowledged, the 8257 takes control of the system bus. It uses the CPU Hold function to suspend CPU operation and transfer blocks of data. Hold Acknowledge tells the DMA controller to take control of the bus.

### Operations of the system bus

During each machine cycle, the CPU first addresses the device to be used in the data transfer. Then it sends to the 8228 system controller a status word defining the operation to be performed, and uses the data bus to make the transfer.

The control lines operated by the 8228 handle device input and output gating. The 8228 controls data-bus flow through its bidirectional driver. The status words are translated into specific gating signals: "write" signals MEMW and I/OW, and "read" signals MEMR, I/OR and INTA (interrupt acknowledge).

Bus timing requires that a specific peripheral device should respond to or be prepared to receive valid data within a specific "window" in the CPU cycle. The window is obtained by giving the device time to settle between addressing and gating. Adjustments for devices that have a relatively long cycle time are made with a function called Wait Request (or Ready).

The function, a special feature of the 8080, allows timing signals to be extended without seriously sacrificing CPU speed. For example, a designer can choose an inexpensive memory, one that has an access time of twice the CPU state time. However, typical instruction-cycle time increases only 25 percent. The Ready function inserts a synchronized Wait state into the cycle between addressing and gating, and increases the

cycle from four states to five. Using other methods, the clock period would be doubled, resulting in a 100% increase in cycle time.

The Ready control can be used to insert one or more Wait states into every machine cycle, or it can be used selectively to accommodate different devices. Ready control also simplifies single-step operations.

During each cycle the CPU also sends to the 8228 various gating commands (Data Bus In, Write, and Hold Acknowledge). Other commands include Interrupt Enable, which is used to permit or inhibit interrupts, and Wait, which signifies that an idling state is in progress.

### Memories needn't slow the system

Typical memory organizations and memory-to-bus connections are indicated in Fig. 3. In large memory arrays, drivers and 8205 one-of-eight decoders may be added as bus interfaces.

Access times have no effect on component-to-bus interfaces. The 8111 256 × 4-bit static RAM and 8316A 2048 × 8-bit ROM, for example, have maximum access times of 850 ns while the CPU can operate at a state time of 480 ns or less. A Wait state is simply inserted into the cycle time. If the designer decides to change to faster memory, the logic element used to activate the 8224's Ready Input is simply removed.

Available EPROMS (erasable and electrically reprogrammable PROMS) are interchangeable with the 8316A, mask-programmed ROMs. The EPROMS are 24-pin static devices with three-state, byte-wide outputs. The 8316A 16-kilobits ROM is generally used to double storage density after program development with an 8708 8-k EPROM.

The 8107B 4-k dynamic RAM may be used for large memories. An available 16-kilobyte dynamic-RAM board (Model in-481) matches CPU speed and synchronizes memory-to-CPU operations. Also, Schottky-bipolar PROMs and ROMs are available for very fast program storage.

### Organizing the system interface

The organization of I/O and peripheral devices can proceed in one of three ways: isolated or memory-mapped, or a combination of each (Fig. 4). When memory and I/O are controlled separately, up to 65,536 memory bytes and 512 input and output ports can be directly addressed.

With memory mapping, the I/O is controlled by memory-control lines and operated with memory-reference instructions. I/O shares the memory-address space, and a memory-address bit is typically used as a flag to denote that an

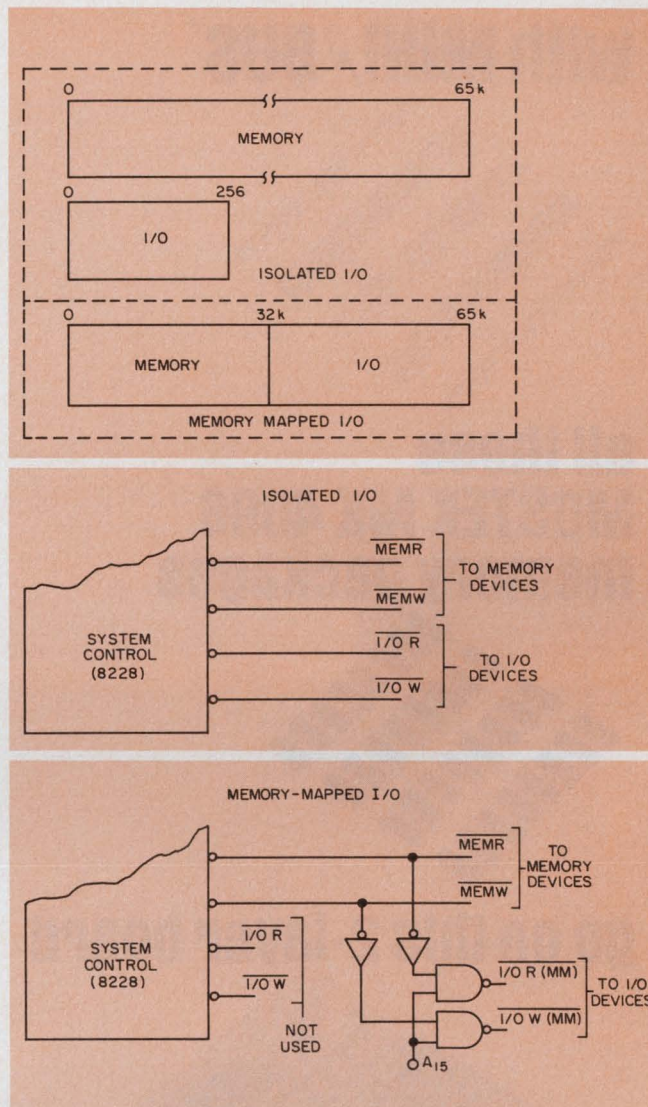

4. I/O can be organized by either an isolated or a memory-mapped method. The latter allows the use of memory-reference instructions, and employs memory-read and write control lines for I/O devices. An address bit acts as an I/O flag.

I/O operation is occurring. A combination of the two techniques is exemplified by a memory-mapped scheme for I/O devices, and isolated I/O for peripheral units.

The memory-mapped approach is often advantageous for complex structures, because memory-reference instructions offer numerous shortcuts in I/O data manipulation. Further, substantial I/O structures can be operated without address decoders.

In either case, two port-selection (or port-addressing) methods apply—linear or decoded select. With linear select, a single address bit forms an exclusive enable for a specific device, and no decoders are used. In decoded select, the address bus is decoded into exclusive enables to maximize the number of directly accessible ports.

Memory-mapped I/O with linear select makes

# with MINI-BUS<sup>®</sup>

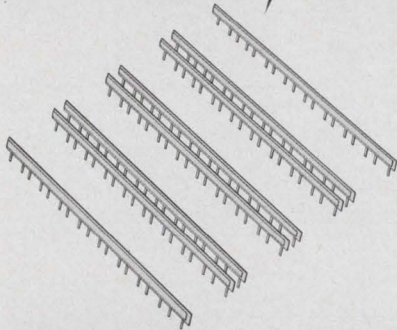

## all these MOSTEK MK 4096 memory packages

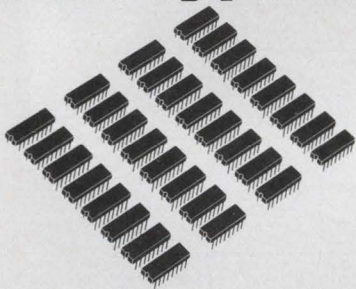

## go on this 2-layer board

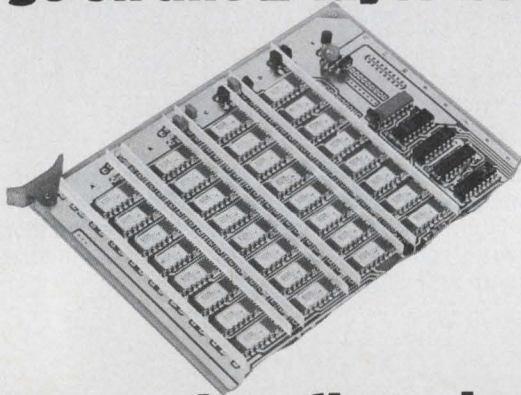

## and work as they should!

### ... and these weren't needed!

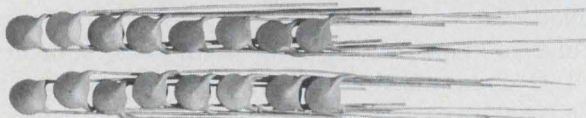

Rogers Application Note No. 1976 tells the full story of how Mini/Bus makes PCB space-saving design easier, eliminates multi-layer PCBs, drastically reduces use of de-coupling capacitors. Write or call for a copy, so you'll know what others know!

© Rogers Corporation 1976

**R<sup>®</sup>** **ROGERS CORPORATION**  
Chandler, AZ 85224 (602) 963-4584

CIRCLE NUMBER 48

up to 39 ports (up to 312 I/O lines) available without decoders. If this technique is used for I/O devices, an isolated I/O and linear-select method can still be used for peripheral devices. With decoded select, either method provides a structure of practically unlimited size.

### Design and development aids

For design prototyping, Intel supplies the SDK-80 system design kit, which contains the following:

- A basic 8080 system—8080A CPU group, two 8111 static RAMs, two 8708 EPROMs, plus the 8251 and 8255 peripheral circuits. One of the EPROMs is pre-programmed with a system monitor;
- PC board, discrete components, sockets and other hardware. The board is pre-drilled for expansion and has an area for adding wrapped-wire interconnections;
- Design and operating manuals.

Software and hardware development are supported by the Intellec MDS (microcomputer development system) and the ICE-80 in-circuit emulator subsystem. The basic MDS contains an 8080 system, with optional peripherals, and resident software.

The MDS can be used for program generation, assembly, emulation, and debugging. It can also be used as a system prototyping tool. Software includes a monitor and a disc-operating system as well as programming packages.

The ICE-80 module and its supporting software offer two unique development features:

(1) Debugging in the actual operating environment. Since ICE-80 plugs into the 8080A CPU socket on the microcomputer board, all operations of the system bus can be controlled and analyzed through the MDS console. An auxiliary connector can be used to observe the operations of external devices;

(2) Debugging can be done through the console, with readily understandable commands. Also, symbols can be used to refer to critical program labels and parameters, rather than to absolute memory locations.

An example of a system based on the 8080 is the SBC-80/10 Single Board Computer. It contains a general-purpose 8-bit microcomputer designed to be used as a plug-in component. (see "\$295  $\mu$ C-on-board Aims to Satisfy Most Requirements," this issue, p. 54). ■■

*The first article in the series appeared in the April 26 issue. The next article will discuss the F8  $\mu$ P.*

# We've improved our Mini-Mag magnetic circuit breakers.

## Broader line. Improved design. Easier to order. And more available.

New code designations,  
easy to understand  
and use in specifying  
and ordering.

New broader line of  
standard models.

New positive latching  
mechanism, greater  
repeatability, more  
positive feeling  
toggle action.

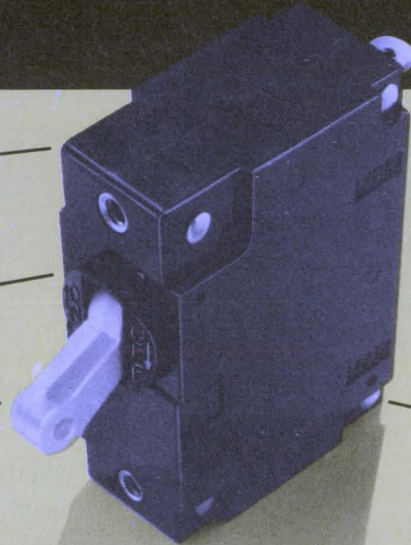

Stocked nationally by  
leading electronic  
parts distributors.

Completely  
interchangeable,  
electrically and  
physically, with  
industry models.

Mini-Mag yesterday and Mini-Mag today look alike outside. We wouldn't want to change that. Inside is where the big difference is; design changes provide greater dependability and improved performance. Latching, repeatability and toggle action have all been improved for reliable, low cost circuit protection.

And, don't overlook the intriguing possibilities for protecting semiconductor devices. Mini-Mag circuit breakers may be used to protect solid-state switches such as SCRs, triacs, power diodes, power transistors, and solid state relays. Circuit clearing time is as fast as 10 milliseconds.

Did we say the Mini-Mag is more available? You bet! One hundred authorized distributors stock Wood Electric Mini-Mag circuit breakers nationally. Sound good? Works out even better when you set up a local stocking program for delivery of exactly what

you need on a pre-arranged schedule.

Mini-Mag circuit breakers, UL and CSA Recognized, can now be specified in 330 standard distributor stock models, thousands more when you order direct from the factory.

Best of all, our new code designators give you an easier-to-use, more error free part numbering system for specifying and ordering improved Mini-Mag circuit breakers.

Contact your Potter & Brumfield sales representative, or call or write Potter & Brumfield Division AMF, Incorporated, Princeton, Indiana 47671. 812 385 5251.

*European address: Electrical Products Group,  
AMF International Limited, AMF House, Whitby Road,  
Bristol BS4 4AZ, England. Telephone: (0272) 778383,  
Telex: 449481, AMMAFOCO, BRISTL.*

**AMF**

**Potter & Brumfield**

CIRCLE NUMBER 49

## Log data under $\mu$ P control and enjoy the benefits of software flexibility. Among the advantages: reformattable interfaces and less hardware.

Consider a microprocessor-based data logger before you settle on the usual methods. The  $\mu$ P unit offers far more flexibility and less bulk than conventional loggers. With it, you can reduce component count by transferring printer interface and synchronization problems from hardware to software. Such an interface can easily accommodate printer format/font changes or implement new ideas or market trends.

The arithmetic logic unit (ALU) of the processor provides arithmetic functions—a natural addition to an upgraded data logger that, with the addition of memory (RAM), provides the desired data handling.

One intelligent data logger mates a  $\mu$ P, an a/d converter and a printer (Fig. 1) to provide the following features:

- Autoranging of the a/d converter.
- Printout of days, hours, minutes and seconds along with the a/d reading.
- Direct printer drive.
- Programmable intervals of time between printings.
- Programmable changes of the analog variable between printings.
- Calculation and storage of maximum and time of occurrence.
- Calculation and storage of minimum and time of occurrence.
- Calculation of mean.
- Presetable time.

### Which $\mu$ P is best?

Evaluation of  $\mu$ Ps for an intelligent logger centers around two important points. First, man-machine interaction requires the ability to handle BCD easily. This points to decimally based  $\mu$ Ps, often four-bit devices. Second, the time-keeping algorithm of the logger requires a  $\mu$ P with an interrupt system.

The BCD coding format is preferred for applications in which numbers are made available for human use at some point. Rather than con-

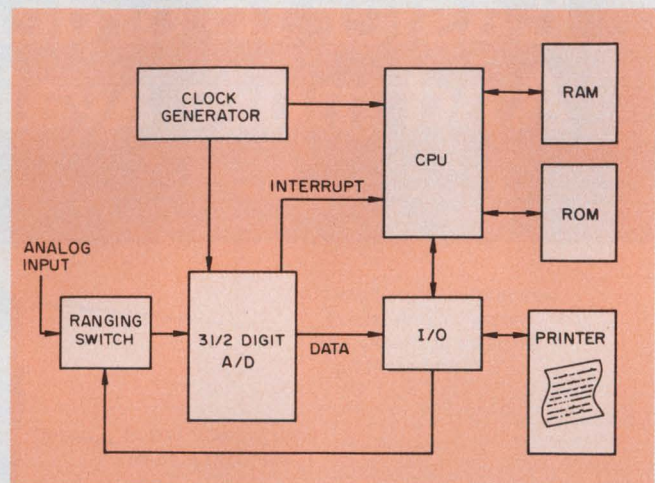

1. A smart data logger is designed around three major elements: a  $\mu$ P, an a/d converter and a printer.

verting from other coding systems to BCD then back again, it makes more programming sense to stay within a single format like BCD, and use devices that excel in handling this format.

Typical numeric printers work with decimally based characters, a set that often uses the full four-bit capability of BCD to give 16 characters: 10 decimal digits and six other characters.

Several available  $\mu$ Ps have a calculator architecture specifically designed to manipulate and store decimal digits. These  $\mu$ Ps handle decimal arithmetic with special "decimal adjust" instructions that maintain the BCD format. The four-bit  $\mu$ P is a natural for all BCD data-handling applications in which low speed is not a problem. An added bonus: four-bit  $\mu$ Ps are inexpensive.

It follows also that the a/d converter used in a  $\mu$ P-printer application should provide data in BCD—a multiplexed-output format of parallel bits/serial digits provides the easiest interface with the  $\mu$ P. This allows each four-bit BCD digit to be taken as one nibble (1/2 byte) at a four-bit input port. Digit-select outputs can mark the appropriate digits.

The fundamental blocks of the intelligent data logger are the Siliconix LD110/111 3-1/2-digit a/d converter, the Intel MCS-40 (4040  $\mu$ P) system and the Seiko EP-101 printer.



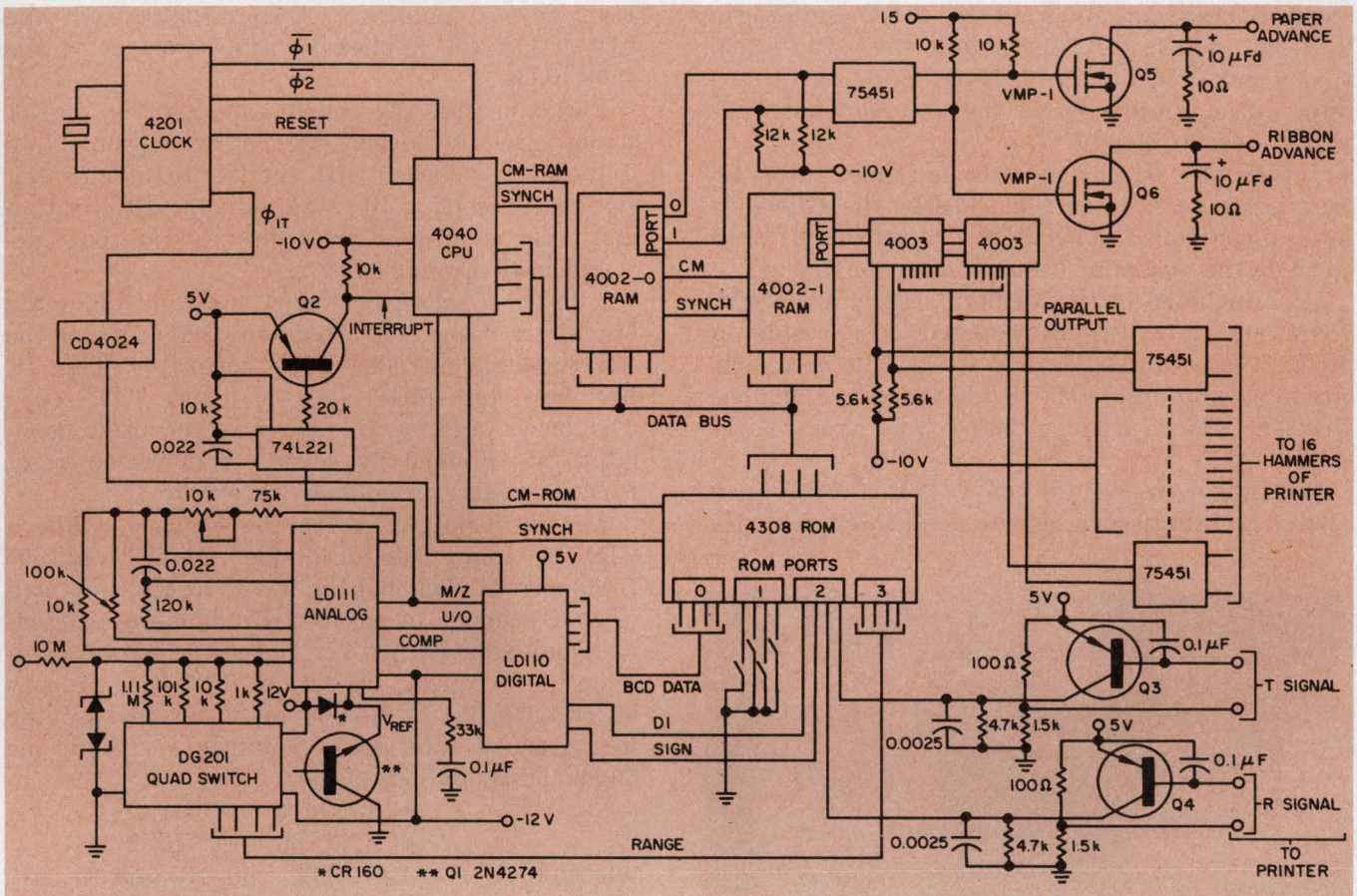

2. In the complete logger, the input signal is attenuated to 200 mV full scale, then converted to a 3-1/2-digit

word for the  $\mu$ P. Program instructions reside in the ROM, and processed data in the RAM.

The two-chip converter offers a number of outstanding features, including autozero and auto-polarity, and incorporates all of the necessary precision linear circuitry, digital housekeeping and analog switching.

The output format of the LD110, a multiplexed BCD, is useful for both display and  $\mu$ P applications. Unlike other 3-1/2-digit converters, the MSB (1/2 digit) is not brought out as a static signal on an additional pin, but is multiplexed as though it were an additional digit. This minimizes the input requirements of the  $\mu$ P system by eliminating software and an additional port.

Ideal applications for the logger are those in which slowly varying analog quantities—temperature, pollution, lighting levels, noise—must be monitored. Since high-speed conversion isn't essential, an integrating a/d is the obvious choice and errors caused by extraneous noise are minimized. In addition, the outstanding stability of the integrating converter makes it especially useful for monitoring analog quantities under adverse environments.

### No drift to worry about

The LD110/111 autozeroing system eliminates zero-offset drift over time and temperature, and

the low gain tempo of the system (typically 25 ppm/ $^{\circ}$ C) reduces full-scale drift over temperature. The very high input impedance (over 1000 M $\Omega$ ) of the LD111 eliminates source-loading errors of high-impedance transducers.

Features of the 4040 that make this  $\mu$ P a logical choice for a data logger include: (1) a four-bit decimally based ALU; (2) interrupt capability; (3) 24 working registers; (4) subroutine nesting to 7 levels; and (5) extensive hardware and software backup.

The Seiko EP-101 is representative of the electromechanical "flying" class in which printing occurs when a mechanical hammer is actuated as a character drum rotates under the paper. A history of reliable operation, clean copy and low cost make this unit an attractive choice.

Interface for the hammer drive is readily achieved since the large drive current demanded by electrically driven hammers isn't needed here. Instead, low-power solenoids release a mechanical hammer driver (a rotating ratchet). Microprocessor interface to the hammer-release solenoids is achieved through standard dual peripheral drivers (75451).

In the complete data logger, the ranging switch attenuates the monitored analog signal according to  $\mu$ P control (Fig. 2). This attenuated (properly

ranged) signal is converted to a 3-1/2-digit word, and the digitized value enters the  $\mu$ P system through the input/output (I/O) ports. An interrupt pulse originating in the a/d converter initiates pick-up of data.

Interrupts occur at precise time intervals because the converter is clocked by the MCS-40's crystal-controlled generator. The interrupts thus provide the means of keeping accurate time.

Also included in the MCS-40 system are RAM, ROM and I/O. Program instructions reside in ROM, and processed data in RAM. The I/O ports provide communication with both the a/d and the printer, which produces hard copy from RAM data.

As shown in Fig. 2, the DG201 CMOS quad switch and the associated resistor ladder comprise

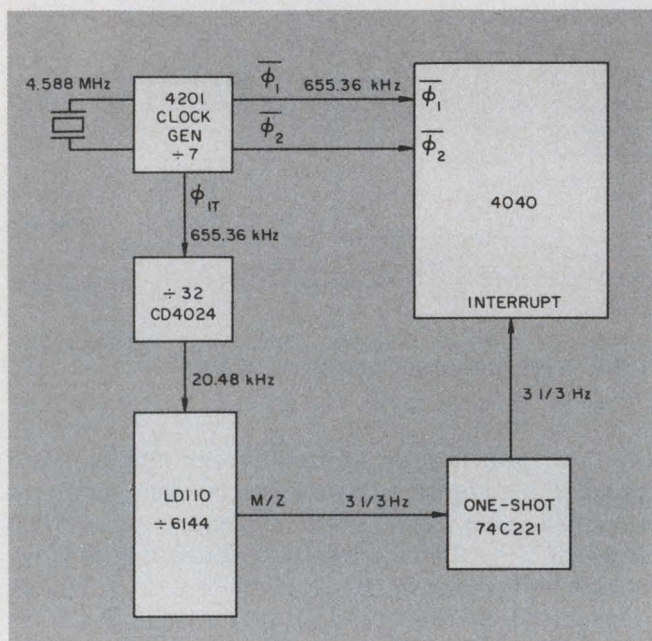

3. Timing for the  $\mu$ P and converter is derived from a crystal clock. The interrupt signal synchronizes the two major elements.

the autoranging input circuitry. The autorange switch is driven by a four-bit output port (ROM port 3).

The DG201 switch connects the appropriate range resistor to ground, thereby giving the proper input attenuation—X 10, X 100, X 1000, X 10,000—for the 2, 20, 200 and 1000-V ranges, respectively. The LD111 analog processor is programmed for exactly 200 mV full-scale, and all inputs are attenuated to this level.

### Tempco is kept down

Reference for the a/d is developed by the 2N-4274, configured as a temperature-compensated zener. The CR160 current-regulator diode properly biases this zener to give a very low tempco

(typically 20 ppm/ $^{\circ}$ C). Output data from the LD110/111 are applied to input port  $\phi$  of the 4308 ROM.

Port 1 accepts the polarity bit and the digit-1 strobe, used for overrange determination. Note that port 1 is shared with the two printer timing signals. Presetting the time during initialization and programming of print intervals are both accomplished through port 2.

Two-phase clocking functions for both the MCS-40 and the converter are derived from the 4201 crystal-controlled clock generator. This IC provides both MOS ( $\phi_1$ ,  $\phi_2$ ) and TTL ( $\phi_{1T}$ ,  $\phi_{2T}$ ) levels, and its frequency is the basic oscillator rate divided by seven. A power-on reset function is also provided by the 4201.

The MOS outputs drive the MCS-40, while a CD4024 binary counter divides the TTL output frequency of 655.36 kHz by  $2^5$  to yield an a/d clock frequency of 20.48 kHz. This rate offers many advantages; with it, the a/d provides maximum line-frequency rejection (NMRR) for both 50 and 60 Hz. It is able to do so because the measurement interval is a multiple of both the 50 and 60-Hz periods. Thus:

$$T_{\text{meas}} = \frac{2048}{f_{\text{clock}}} = \frac{N_1}{60} = \frac{N_2}{50},$$

where  $f_{\text{clock}} = 20.48$  kHz, and  $N_1$  and  $N_2$  are integers;  $N_1 = 6$ ,  $N_2 = 5$ .

(Note that the sampling period is split into two intervals: zeroing and measurement; hence the M/Z line.)

Thus only the average value of the line noise contributes errors to the reading. A second significant reason for choosing the 20.48-kHz clock frequency is that it gives 10 conversions every 3 s:

$$\text{Sampling rate} = \frac{20.48 \text{ kHz}}{6144 \text{ cycles/sample}} = \frac{10}{3} \text{ samples/s.}$$

With this sample rate—by interruption of the 4040  $\mu$ P after every sample—a timekeeping system is readily implemented. The  $\mu$ P merely counts each interruption and adds 3 to a counter for every 10 interruptions. The 3-s increment lends itself to easy turnover at 60 s (200 samples).

To interrupt, the M/Z line of the a/d triggers a 74C221 one-shot. The resulting pulse is level shifted by transistor  $Q_2$  and has a pulse width less than the minimum amount of time required to service the interrupt. The  $\mu$ P system also depends on this interrupt for proper synchronization with the a/d (Fig. 3).

With the  $\phi_1$  and  $\phi_2$  clock signals, the 4040 generates a signal every machine cycle (8 clock intervals) that synchronizes the RAMs and ROMs to the addresses that subsequently appear on the four-bit data bus ( $D_0$ ,  $D_1$ ,  $D_2$ ,  $D_3$ ). The two 320-bit RAMs each provide a four-bit output port.

Two bits of RAM port  $\phi$  actuate the printer-

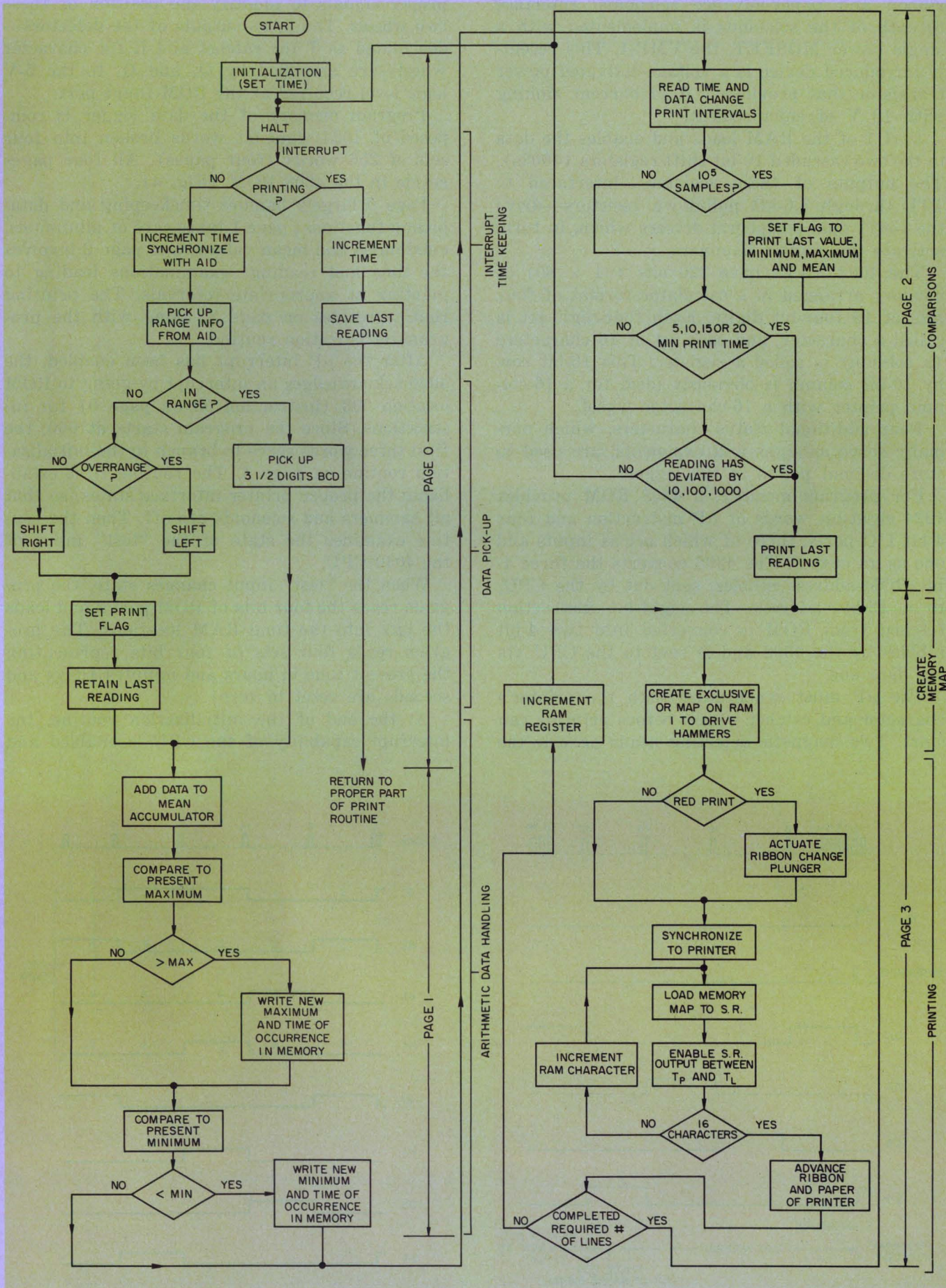

4. The logger's program resides in four ROM pages: page 0 stores housekeeping; 1 handles maximum, mini-

mum and mean values; page 2 handles comparisons. Page 3 stores printing and start-up.

ribbon and paper-advance solenoids. Interface to each of the solenoids is implemented with a single power MOSFET, the VMP-1. This recently introduced device is a voltage-activated power transistor that provides 1 A of current sinking with 10 V of enhancement.

Port 1 of the RAM loads and enables the data to the two cascaded 10-bit shift registers (4003s). The outputs of these registers—interfaced to TTL through 5.6-k $\Omega$  pull-down resistors—drive the 75471 dual peripheral drivers which, in turn, activate the printer hammers.

The 4002 RAMs have 320 bits (4  $\times$  80) of memory arranged in a calculator format of four sets of 16 four-bit digits. Each four-digit set is called a character, and each set of 16 characters (a column) is called a register. This 16-bit row by 16-bit column is obviously ideal for a 16-column printer with a 16-character wheel.

Four additional status characters, which normally serve as signs and exponents, are used to store decimal points in the logger.

For program memory, a 4308 ROM provides 1024 eight-bit words of  $\mu$ P instruction and four 4-bit I/O ports, three of which act as inputs and one as an output. The 4308 converts the three 4-bit ROM-address nibbles, sent out by the CPU, to a 12-bit address. The eight-bit instruction fetched from ROM is converted into two 4-bit nibbles by the 4308 and is sent to the CPU via the data bus.

The  $\mu$ P must synchronize with the printer's character and ratchet wheels before printing can start. Two magnetic detecting heads provide the

proper signals to identify the position of these two wheels. The pulse outputs of the detectors—designated as T for ratchet and R for character wheel—are amplified by Q<sub>3</sub> and Q<sub>4</sub> to the 5-V logic level required at the ROM input port.

Program memory of the data logger is composed of 1024 eight-bit words broken into four sets of 256 words (four pages). All four pages reside in the 4308 ROM (Fig. 4).

Page 0 largely handles timekeeping and data-pickup functions; page 1 takes care of minimums, maximums and mean values; and page 2 involves the time and reading examinations leading to printing at appropriate intervals. The printing routine resides on page 3, along with the program-initialization routine.

After the  $\mu$ P interrupt has been enabled, the 4040 acknowledges an interrupt by going to ROM location 003 (instruction 03 on page 0) for instructions. Since the program starts at 000, the first three words serve to branch to the initialization routine on page 3. The routine first establishes the proper printer-interface states, so that all hammers and solenoids are off. Then the routine examines the state of the "test" input of the 4040 CPU.

When the "test" input changes state, the program reads the four bits of ROM port 2 and loads the bits into the time RAM locations. The program reads four sets of four bits representing the present time in hours and minutes (days and seconds are reset to zero).

At the end of the initialization routine, the interrupt capability of the CPU is enabled and

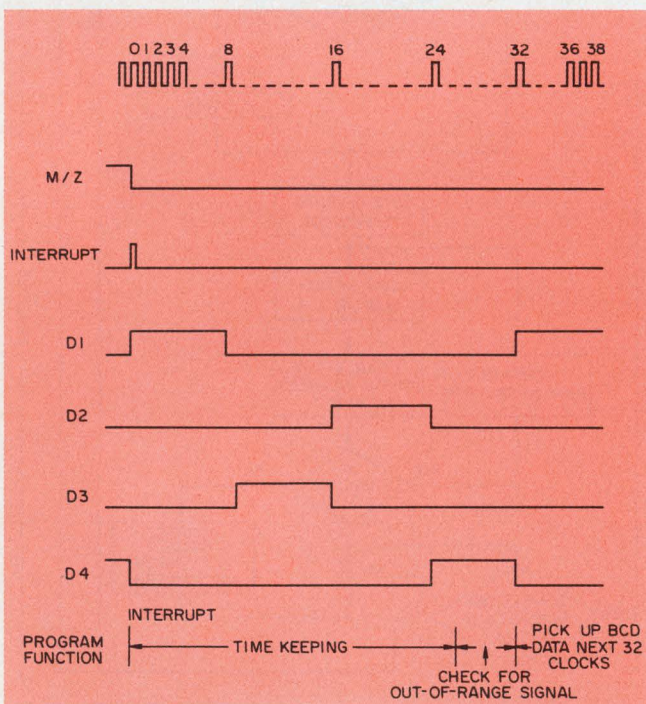

5. Interrupt timing signals for the  $\mu$ P/converter: The BCD data are read-in at the digit-1 strobe.

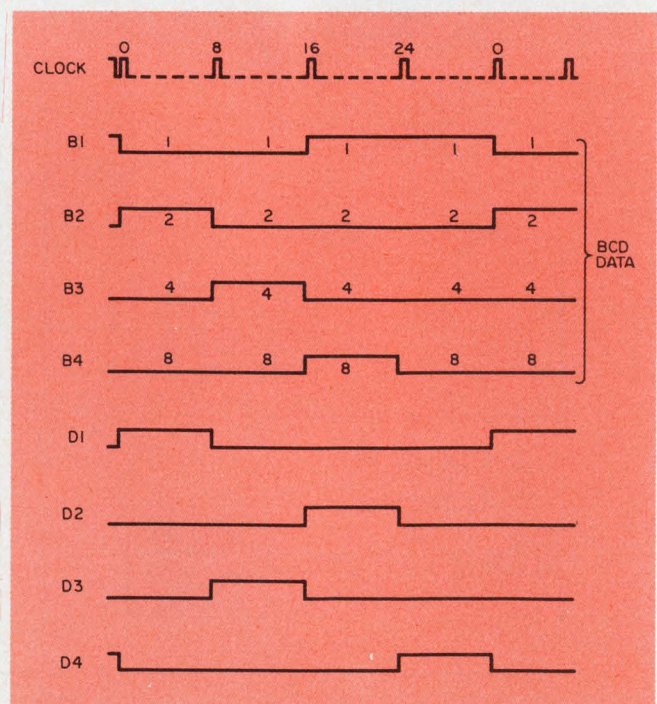

6. Output format of the LD110 a/d converter consists of parallel BCD in an interlaced scan (digits 1, 3, 2, 4).

the program goes into a print-enable examination loop. If a print flag has been set, the program goes into the print mode; otherwise, the program waits for an interrupt.

A complete a/d conversion is signalled by the interrupt pulse. The CPU program counter returns to location 003, where the conversion counter is incremented. If the interrupt doesn't occur during a printing cycle, the carry bits continue rippling through the seconds, tens of seconds, minutes, tens of minutes, hours, tens of hours, days and tens of days.

If a print cycle is interrupted, the program immediately returns to the next instruction in the printing operation.

With the completion of the time-keeping chores, the instructions lead into the pick-up of the BCD data from the a/d converter. Because of a short override interval, the output of the LD110's multiplexer may not be valid for the preceding conversion. Consequently, data pick-up is inhibited until the start of the second digit scan.

Since there are four  $\mu$ P machine cycles for every LD110 clock interval, and since the digit scan takes 32 intervals, the program takes 128 machine cycles before it looks for the data.

Prior to this sequence, however, the program examines bit four of the digit-four time slot (at ROM port 0). If this bit is a ONE—the under-range signal (count < 100)—the program will down-range the DG201 switch to increase a/d sensitivity by a factor of 10. Reading of the BCD data at the input port starts during the LD110 digit-1 strobe (Fig. 5).

The overrange condition (count > 2000) occurs on the digit-1 time slot and forces the digits low during the zeroing interval. In the program, the overrange signal causes the DG201 to up-range and decrease sensitivity by a factor of 10.

The absence of either out-of-range signal tells the program to process all four digits available at ROM port 0. The digits enter during the successive four digit times of the LD110 and are written into RAM 0, register 0, characters 0 through four.

The polarity bit, picked up during the over-range test, is converted into the proper printer character code (10 or 11 for + or -, respectively) and written into RAM.

Since the LD110 provides the digits in an interlaced scan of digits 1, 3, 2, and 4 ( $D_1 = \text{LSB}$ ), digits 2 and 3 must be exchanged in memory. The memory locations of the stored a/d and time data are given in Fig. 7. Following the data pick-up are the handling processes that establish minimum, maximum and mean.

### Calculation of data properties

The new data are first compared with the present minimum and maximum. If the absolute value is less than that of the present minimum, a new minimum and time of occurrence are written into register 1 of RAM 0. If the magnitude is greater than the present maximum, the data and time of occurrence are entered into register 2 of RAM 0.

All of the comparisons take into account the floating decimal point provided by the autoranging a/d converter. Algebraic minimums and maximums can be kept if the sign bit is considered. Then, the minimum is either a minimum positive value or a maximum negative value. The maximum is either a maximum positive value or a minimum negative value.

Mean determination follows the min/max tests. A conversion counter keeps a tabulation of conversions (interrupts). Every 100,000 conversions, or 8 h and 20 min, a new mean is determined. At this time a print flag is set (a non-zero number in index register 15) to print the mean and the minimum and maximum.

Progressing to the averaging process, the program provides the necessary left or right shifting of the new data to reflect the decimal point relationship of the two numbers.

A comparison of the mean-summations' polarity bit with that of the latest data, routes the program through either the addition or subtraction routine as necessary. A very small mean summation can give a subtraction result less than zero. This possibility is avoided by monitoring of the carry bit after each subtraction.

When 100,000 readings have been summed, the four MSDs of the mean summation are written

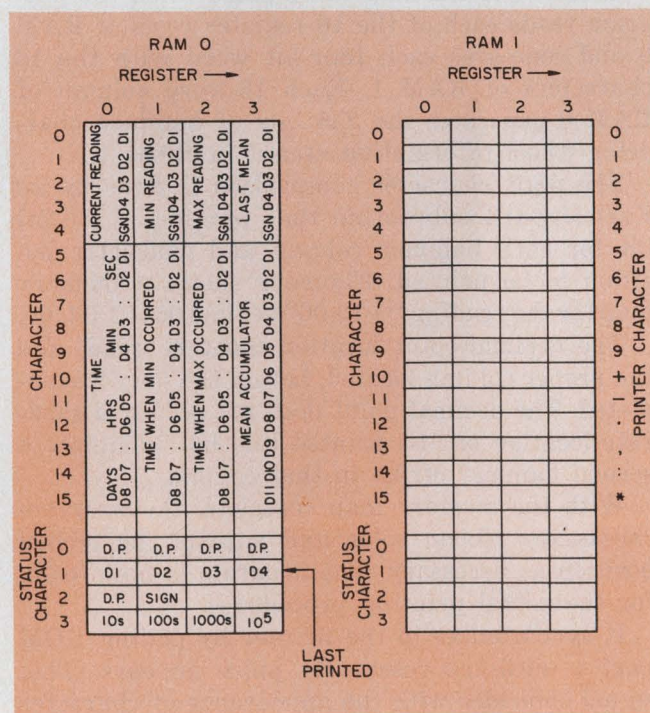

7. Memory organization of the RAM: 320 bits are arranged in four sets of 16 four-bit digits.

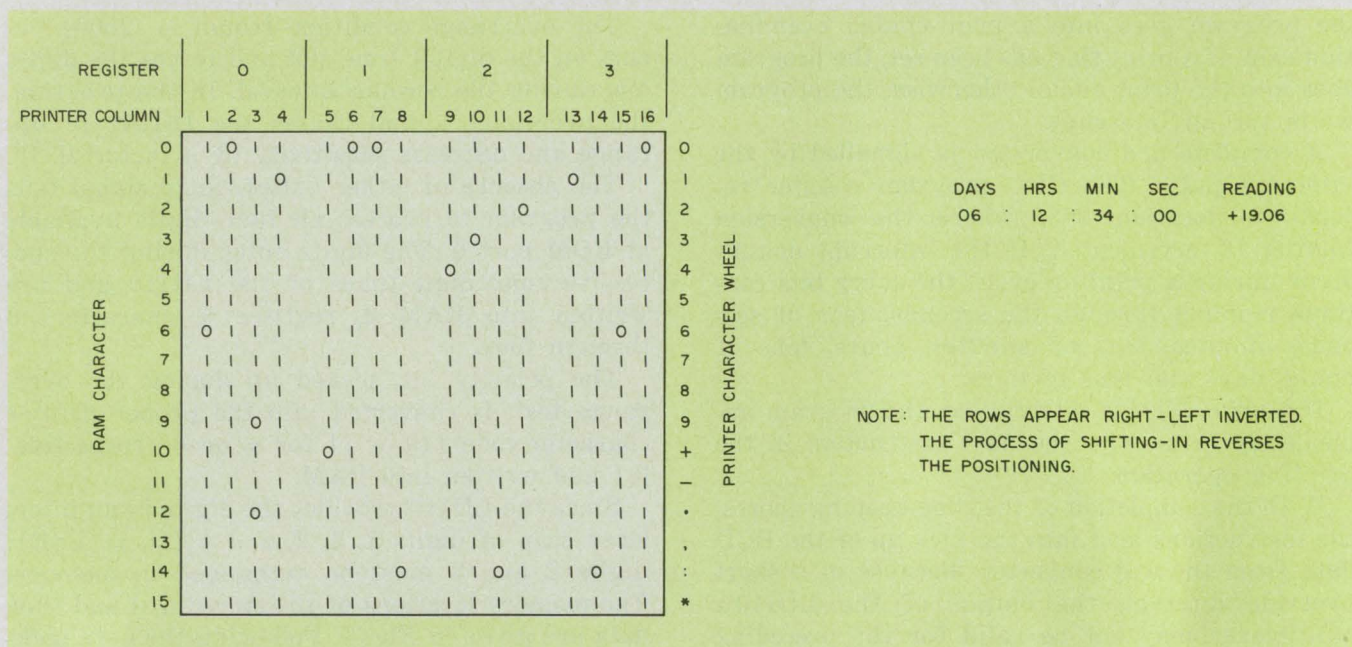

8. RAM 1 memory map designates the characters to be printed. Four 4-bit columns in the map represent the

16 printer columns, and the 16 map rows represent the 16 characters of the printer wheel.

into the mean memory location (ROM 0, register 3, characters 0 through 4) for subsequent printing. Calculation of the mean at power-of-10 intervals ( $10^5$ ) eliminates floating-point-division routines and holds the program size down.

The decision to print is based on two criteria: the present time and the change in the reading since the last printed value. The state of the four switches connected to ROM input port 2 programs this evaluation; the two MSB switches determine the time intervals between printings. An input of 00 gives a time-reading printout every 5 min; 01 prints at 10-min intervals; and 10 or 11 programs 20-min print intervals.

The two LSBs control printing when the count from the a/d varies by a specific amount from the last printed count. The logger then records the profile of a period of rapid change in the measured analog quantity. When the analog variable stabilizes, the data logger returns to time-interval printing.

The two bits that program the profiling can provide four count intervals. A 00-bit input does not allow count-interval printing; a 01-bit input gives 10-count intervals; and 10 and 11 yield intervals of 100 and 1000 counts, respectively.

In addition to the special printouts, any change in range results in a printing. Each of these non-time-interval conditions is identified by a switch to red printing.

The interrupt routine terminates after the time and data processing are completed. The program then returns to the print-enable examination loop. If a print flag was set previously (non-zero number in index register 15), the program advances to the print routine on page 3.

The printing operation can be interrupted at any time, but the interrupt service can only increment a conversion counter; the program then returns to the printing cycle.

Before any printing can be initiated, however, the program first creates a map in RAM 1 to designate the characters that must be printed. The 16 printer columns are represented by the four columns (registers 0, 1, 2, and 3) of four bits each. The 16 rows represent each character of the 16-character wheel (Fig. 8).

Creation of the map takes place when the program reads each of the 16 register rows of RAM 0 and compares each four-bit word with the 16 characters of RAM 1. Each 16-word column of RAM 0 generates the 256 bits of hammer/character wheel information stored in RAM 1.

The digit/character comparison is done by an Exclusive-OR subroutine that provides a ZERO bit for each hammer column and character position to be printed. Figure 8 shows a memory map for the reading "+19.06" at time 06:12:34:00.

The decimal-point location must be read, and the proper column located, before the map is completed. The decimal point does not occupy a separate location on the printed line but is simply a second hammer strike in that column.

With the memory map complete, the program checks for ribbon color and adjusts the ribbon position as necessary. The program is now ready for the actual printing procedure:

It synchronizes to the printer by polling ROM port 1 until the reset (R) pulse appears. This signal coincides with the appearance of character 0 under the hammers. The R pulse is also coincident with  $T_L$ , the pulse that signals that the ham-

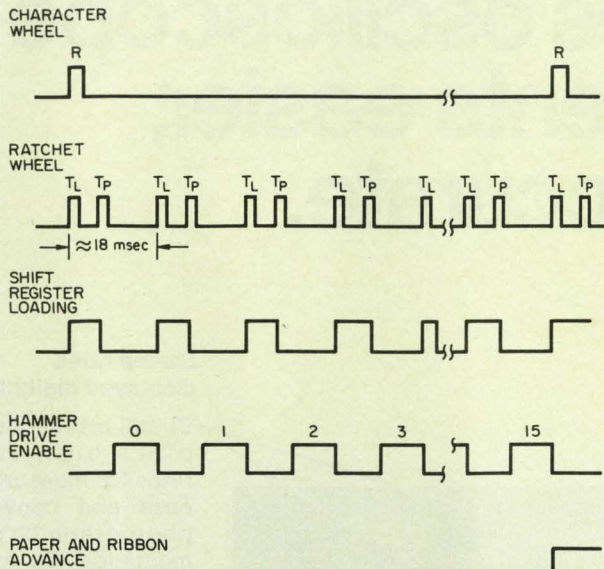

9. Timing signals for the  $\mu P$ /printer: Pulse  $T_L$  starts shift-register loading;  $T_p$  enables register outputs.

mer must be disabled: For the next 16 characters (one line), the program ignores the R signal.

As shown in Fig. 9, the shift registers are loaded following  $T_L$ . Row (character) 0 of the memory map is shifted bit-by-bit through RAM 1 output port into the two cascaded 10-bit registers. One bit of the port provides the data line, the second provides the clocking function, and the third provides the shift-register enable, whereby the internal state of the bits appears at the parallel outputs.

#### Hammer drives are enabled

After all the bits are shifted out, ROM port 1 is again polled for timing signal  $T_p$ . The 12.2- $\mu s$  machine cycle time allows the  $\mu P$  to load this data in much less than the 5 ms time between pulses. The appearance of  $T_p$  enables the shift-register outputs which, in turn, activate the 75451 hammer drivers. (A ZERO at the register output enables the hammer drive.)

The program then awaits the return of the  $T_L$  pulse. When  $T_L$  appears, the hammers are disabled, and the next row (character) of the memory map loads into the shift registers. The printed line is completed after 16 iterations and the paper and ribbon are advanced.

If more than one line is to be printed (mean output), the cycle continues on to print the mean, the minimum and its time of occurrence, and the maximum and its time of occurrence.

After exiting from the print mode, the last a/d reading enters into memory. This last printed reading is used for difference comparisons with future data. ■■

If we haven't made  
the mechanical  
filter you need yet,  
we can.

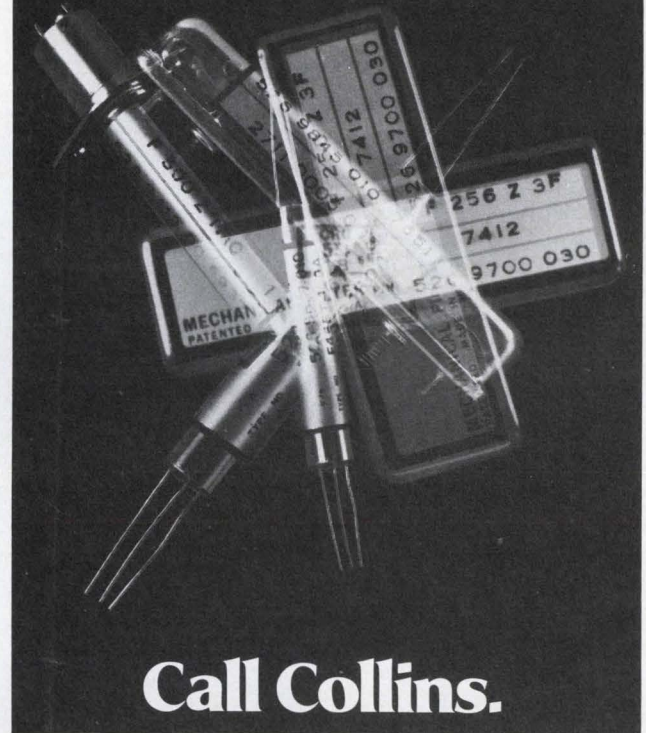

Call Collins.

The worldwide reputation of Collins' standard mechanical filters is the same today as it has been for the past two decades: high quality and reliability. Their excellent rejection of unwanted signals has been demonstrated in applications ranging from CB transceivers to missile guidance systems.

Today, as a direct result of our years of experience in these diverse applications, we have a cost-effective solution to your filtering problems readily available.

Moreover, we have the engineering know-how to create an original design concept for your custom requirements.

For information call or write: Mechanical Filters Marketing, Collins Radio Group, Rockwell International, 4311 Jamboree Road, Newport Beach, California 92663. Phone: 714/833-4632.



Rockwell International

...where science gets down to business

CIRCLE NUMBER 50

# This display makes oscilloscope timing measurements easier, faster and more accurate.

## Main sweep has two intensified zones.

Two intensified zones on the main sweep correspond to the two expanded, delayed sweeps shown below. They are quickly and independently positioned to provide a visual approximation of the  $\Delta$  time measurement.

## Two expanded sweeps.

Both intensified zones are expanded at a faster rate for better resolution and are swept alternately with the main sweep trace for a complete, powerful measurement display.  $\Delta$  time accuracy is enhanced by superimposing one trace over the other, yet they can be vertically separated for independent analysis.

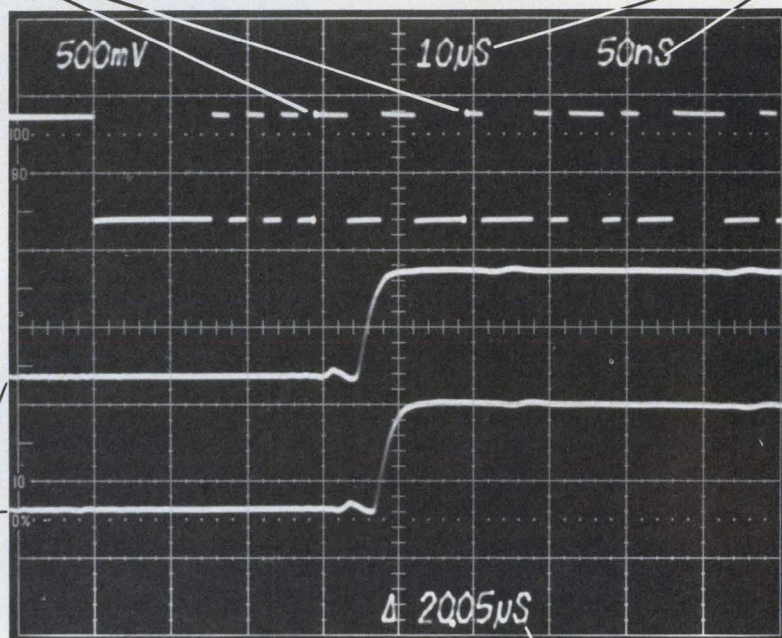

## Sweep rates displayed digitally.

Digital crt readout displays both sweep rates for measurement ease and convenient photographic documentation. To the left is the main sweep rate and to the right is the sweep rate for the two alternate (or delayed) sweeps.

## Time difference is computed and displayed digitally.

The time difference ( $\Delta$  time) between each of delayed sweeps (or intensified zones) is digitally computed and displayed directly on the crt for swift and convenient measurement. When similar points on each of the alternate delayed traces are aligned, the  $\Delta$  time readout gives you a highly accurate measurement of the time between the points.

CRT display, photographed on a 7904 oscilloscope, shown full size.

Fill out and mail to: Tektronix, Inc., P.O. Box 500, Beaverton, OR 97077

Please send me

- The new 7B80-Series brochure
- $\Delta$  time measurement application notes.
- A catalog of 7000-Series oscilloscope mainframes and plug-ins.

Please have a Tektronix Field Engineer contact me about a demonstration.

Name \_\_\_\_\_ Position \_\_\_\_\_

Company \_\_\_\_\_ Mail Sta \_\_\_\_\_

Address \_\_\_\_\_

City \_\_\_\_\_ State \_\_\_\_\_ Zip \_\_\_\_\_

Phone ( \_\_\_\_\_ ) \_\_\_\_\_



# Only these new plug-in time bases make it possible.

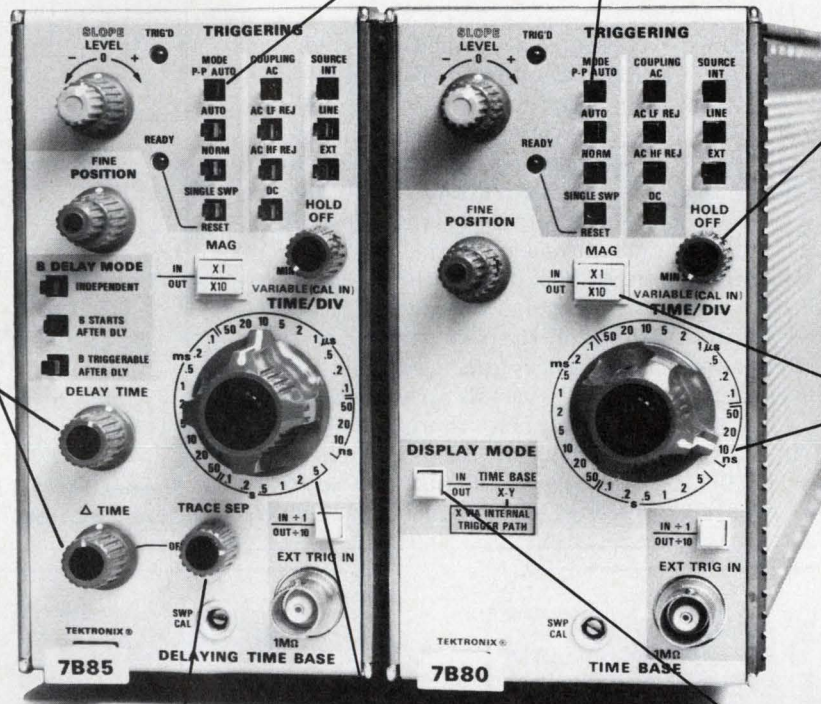

## Triggering.

Peak-to-peak automatic triggering offers a continuously triggered display regardless of changes in signal amplitude or frequency. Trigger bandwidth is 400 MHz with trigger sensitivity at least 250 mV.

## Trigger holdoff adjustable.

Variable trigger hold-off allows you to obtain stable displays on complex signals like digital data trains.

## Controls position both intensified zones.

DELAY TIME positions the first intensified zone.  $\Delta$  TIME positions the second intensified zone relative to the first. The  $\Delta$  delay time value — the time between the two intensified zones — is presented digitally on the crt.

## 7B80 sweep rates.

The alternate (delayed) sweeps can be set to any rate up to 1 ns/division on the 7B80. Naturally, other 7000 Series time bases with different performance features can be used with the 7B85 to make  $\Delta$  time delay measurements.

## Alternate traces can be separated.

TRACE SEPARATION activates the  $\Delta$  delay time mode and permits the two delayed traces to be vertically positioned with respect to each other for your most convenient display.

## 7B85 sweep rates.

Sweep rate for the main sweep can be set from 1 ns/division to 5 s/division.

## Optional X-Y mode.

For phase relationship measurements, an optional X-Y mode routes the X (horizontal) signal from an oscilloscope vertical amplifier to the horizontal sweep unit without changing input probes.

# Here's how to get more information

Your nearby Tektronix Field Engineer will be happy to show you how these new time bases combine with a 7000-Series oscilloscope mainframe and other 7000-Series plug-in instrumentation to fit your measurement needs. Just call your local Tektronix Field Office or send the coupon to Tektronix, Inc., P.O. Box 500, Beaverton, OR 97077. In Europe, Tektronix Limited, P.O. Box 36, St. Peter Port, Guernsey, Channel Islands.



**TEKTRONIX®**

committed to  
technical excellence

**The 7000 Series...more than an oscilloscope**

FOR TECHNICAL DATA CIRCLE #271  
FOR DEMONSTRATION CIRCLE #272

## Graphic-input terminal allows easy writing

A freehand-writing graphic-input terminal that has a simple, sensitive surface and that can be used with any type of stylus, has been developed. The writing surface can be covered with paper to produce hard copy.

Designed at the National Physical Laboratory, London, England, the graphic terminal consists of two orthogonal resistive strips separated by an air gap. Pressure from writing on the upper strip, which is flexible, deforms it into contact with the lower strip. Electrodes are connected across the ends of the strips so that when a

current is passed through one strip a uniform voltage gradient is produced.

The voltage at the point of contact is proportional to the position on the X-axis (see Fig.) The second strip acts as the wiper of the potentiometer formed by the first strip. To obtain the Y-coordinate of the point of contact, the functions of the two strips are interchanged by an electronic switch. If the reversals are repeated sufficiently fast, there is a continuous sampling of the X and Y coordinates of the path traced by the moving stylus. In computer sys-

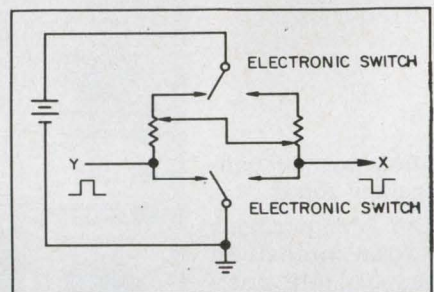
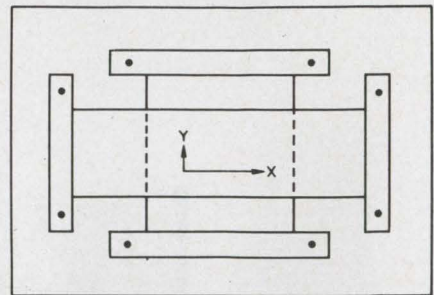

Freehand graphic terminal (top) is shown with equivalent circuit.

## POWER MINI'S FOR LOGIC OR OP AMPS



Terminal strip input/output connections on these miniature power modules eliminate the need for sockets or soldering. They mount in an area only 3.5" x 2.5". Ratings: 5 volt models to 2.5 amps,  $\pm 15$  volts to .5 amps. Other models from 1 to 75 volts, all with 3-day shipment guaranteed.



Corp., Easton, Pa. 18042 Tel: (215) 258-5441

CIRCLE NUMBER 295

## POWER FOR RELAYS AND DISPLAYS



Drive relays, lamps, small motors and similar loads with low-cost Acopian unregulated power modules. Built-in fusing protects against overloads or shorts. Series U models use terminal strip connections. Plug-in modules mount in standard octal sockets; many have adjustable outputs. Guaranteed 3-day shipment.



Corp., Easton, Pa. 18042 Tel: (215) 258-5441

CIRCLE NUMBER 296

ELECTRONIC DESIGN 10, May 10, 1976

tems an a/d converter is used to produce a binary representation of the two coordinates.

The input terminal, called Chit, is low in cost and requires only four electrical connections to the writing tablet, which is tolerant of external fields. The surface can be sealed to prevent damage. Since the operation is independent of the absolute value of the strip resistance, a wide range of operating temperatures is allowed.

## Solar cell panel adds efficiency and protection

Increased efficiency and protection for solar-cell batteries has been achieved with a new manufacturing technique developed by Mullard of London. These batteries are used for radio repeaters on mountain tops, equipment in desert regions and radio beacons at sea.

The technique consists of embedding the solar-cell array in a flat, molded panel of transparent plastic. Sunlight falling on the so-

lar cells produces electrical energy. Sunlight passes through the transparent, structural areas of the panel with low heat absorption. This minimizes the panel's over-all temperature rise and the cell's operating temperature, thus increasing efficiency.

A typical solar battery contains 34 series-connected cells, each 40-mm in diameter, embedded in a panel measuring 468 × 365 × 15 mm. The array can produce 10.7 W in sunlight.

## Improved glass may aid in IC manufacture

A new glass developed specifically for photomasking can overcome the undesirable thermal expansion of the hard glass normally used in photomasks for integrated circuits. This expansion causes a deviation in line width of 1  $\mu\text{m}/^\circ\text{C}$  rise for a 100  $\text{mm}^2$  mask.

For LSI with line widths of about six  $\mu\text{m}$  the expansion is tolerable, but it becomes a problem

with very-large-scale integration, which requires line widths of 1  $\mu\text{m}$ .

The Hoya Glass Works, Ltd. of Tokyo has produced an alumina-silicate glass that has an extremely low thermal-expansion coefficient that is not more than 0.3 microns per 100  $\text{mm}^2$ .

The glass is also three times more resistant to water penetration than current glasses and has a greater resistance to acid corrosion. As a result, etching can be performed with much greater precision and yields of very high-density ICs should be improved.

## Low-light underwater TV

A highly sensitive underwater television system that requires little if any artificial lighting has been introduced by EMI Electronics Ltd. of Middlesex, England. The silicon-intensified tube used in the camera is said to be some 2500 times more sensitive than a standard vidicon tube.

# BENCHTOP POWER ...FROM \$99



Reliable yet low-cost power supplies for circuit development and component evaluation. Single, dual and triple output models. Ratings from 0-7 to 0-50 volts. All have adjustable current limiting, coarse and fine voltage adjustments and two meters. They may be stacked to conserve bench space. Regulation,  $\pm 0.01\%$  or 2 mv. Ripple, 0.25 mv rms.

**Acopian**

Corp., Easton, Pa. 18042 Tel: (215) 258-5441

CIRCLE NUMBER 297

# GUARANTEED 3 DAY SHIPMENT

## ACOPIAN

### POWER SUPPLY CATALOG 1976-1977

Every power module listed in the Acopian 48-page catalog is shipped within 3 days of order. Guaranteed! Miniaturized supplies, narrow profile and plug-in modules, premium performance models, and a wide choice of other types are described in detail. Ask for your copy.

**Acopian**

Corp., Easton, Pa. 18042 Tel: (215) 258-5441

CIRCLE NUMBER 298

## CMOS analog switches can precisely control an op-amp's gain

CMOS analog switches, when used in the proper circuit, can accurately control the gain of precision instrument amplifiers (Fig. 1). CMOS switches are inexpensive and consume very little power, but have fairly high ON resistances,  $r_{ON}$ , which typically range from 100 to 300  $\Omega$ . The proper use of a CD4052 as a dual-channel multiplexer can overcome this limitation.

Resistors  $R_1$  to  $R_4$  form a precision network that is ratio-matched to obtain the desired accuracy. Op-amp  $A_1$  operates as an inverting amplifier whose gain to point X is  $(R_f + r_{ON})/R_i$ . However, at point Y the amplifier gain is accu-

rately defined by  $R_f/R_i$ . Note that  $r_{ON}$  has no effect on the gain to point Y.

Since the CD4052 can handle input-voltage swings of  $+V_s$  to  $-V_s$ , the clamp network,  $R_5$  and  $D_1$  to  $D_4$ , is designed to clamp node X to these limits.

The design provides four decades of gain or attenuation depending upon the value of  $R_i$ . For gain, set  $R_i$  equal to  $R_1$ ; for attenuation, set  $R_i$  equal to  $R_T$ . (See the table in Fig. 1.)

Gordon L. Wong, Project Engineer, Data Tech, Div. of Penril Corp., 2700 S. Fairview Ave., Santa Ana, CA 92704. CIRCLE No. 311

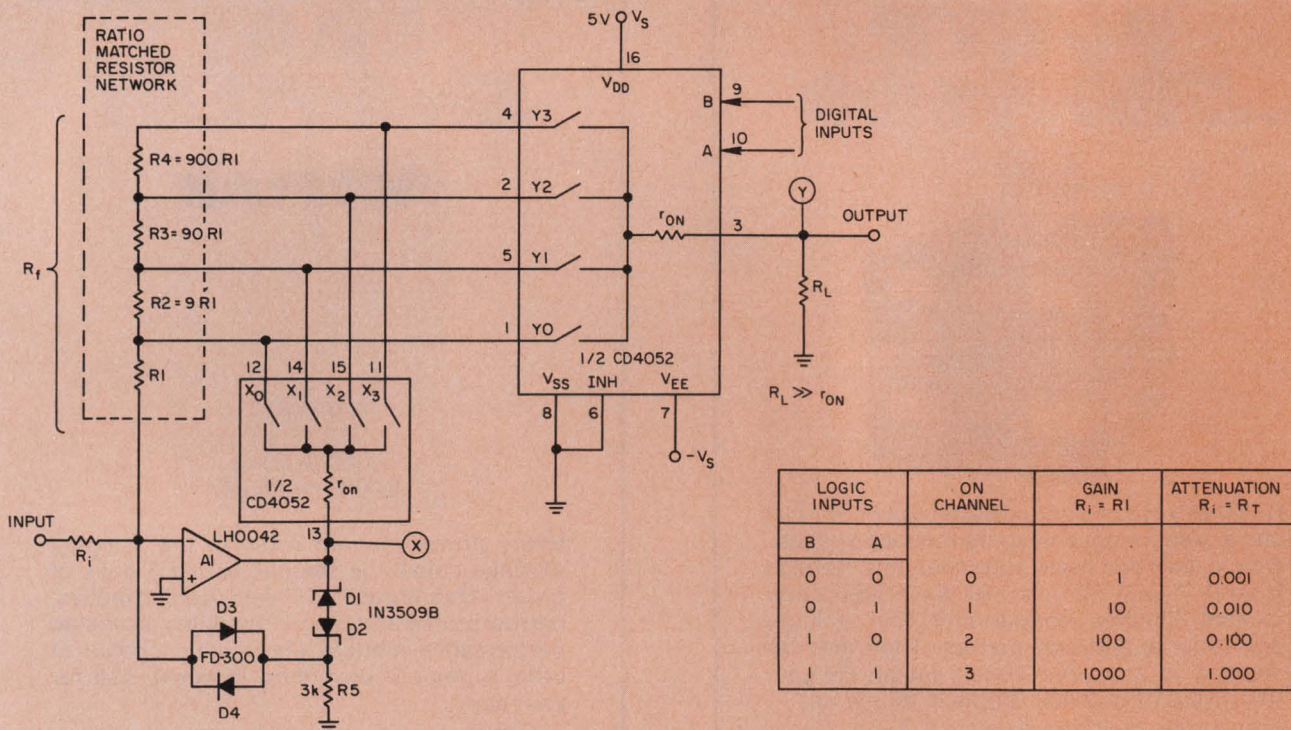

1. By use of a dual-channel CMOS multiplexer, an amplifier's gain can be accurately defined as  $R_f/R_i$ ,

independently of the ON resistance,  $r_{ON}$ , of the multiplexer.

Our modular dc supplies have always been UGLY™ because we're designers, not stylists.

But we may have outdone ourselves with our new SOLV-15.

Like all our other single and multiple-output dc supplies, our 15-watt SOLV-15 delivers its full rated output all the way up to +55°C. And its standard features include: a choice of 16 voltages from 5-24V, currents from 3-0.75A; ±0.1% regulation, ripple-and-noise; foldback current limiting; and a 1-year warranty.

But even with all this, it still looked stark.

So we took a stab at making it more attractive by getting it UL-listed and adding sense protection (free), reverse diode protection (free) and a fixed OVP (free). We wrapped it all up in a new low-profile package that uses the same mounting holes as the supplies you're probably using now.

And then priced it all a couple of bucks under the nearest competition (\$23.50, 100-pieces).

We just figured that since it was so UGLY, it was really going to have to deliver.



©Elpac Electronics, Inc.

CIRCLE NUMBER 53

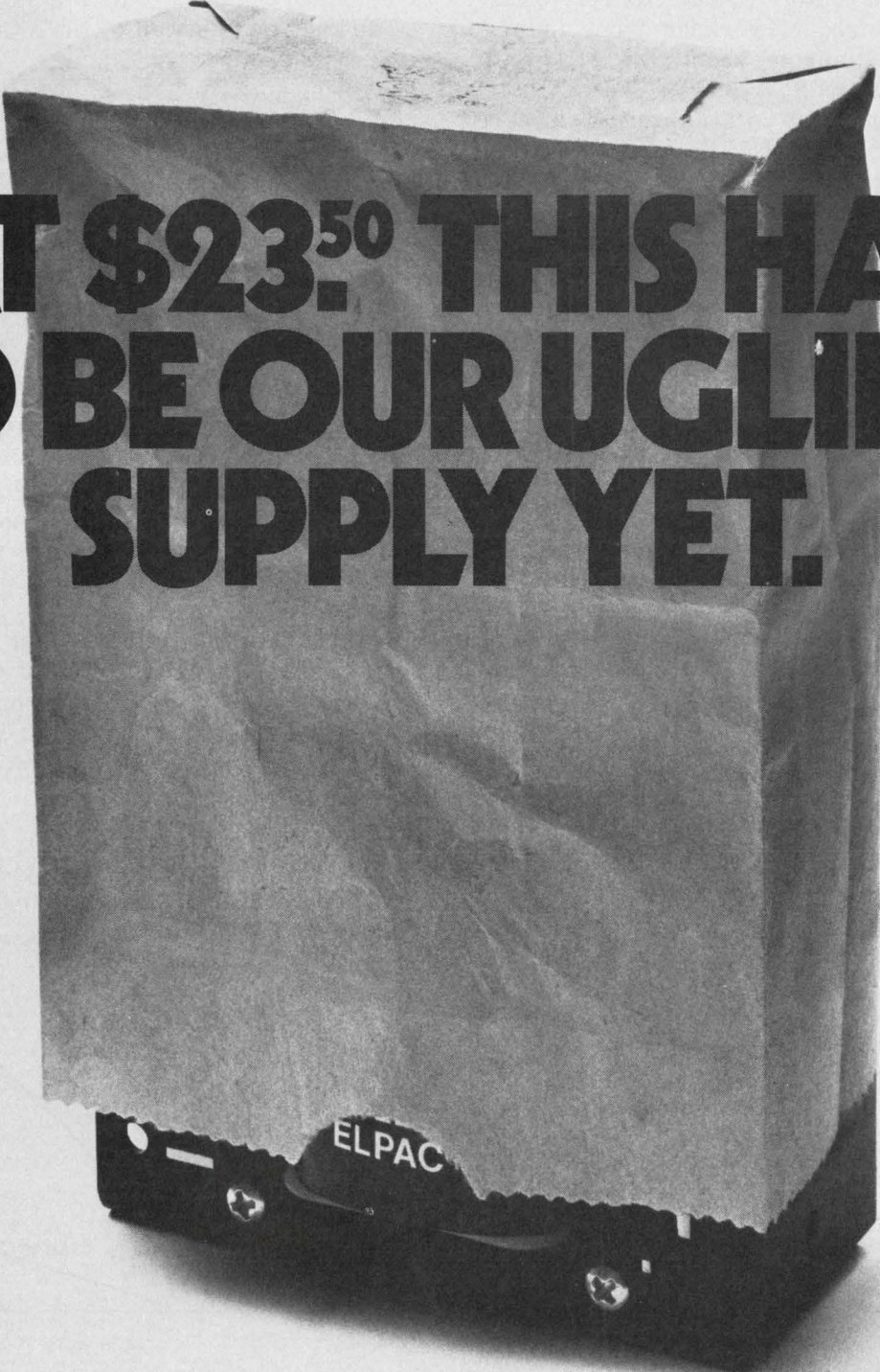

**AT \$23.<sup>50</sup> THIS HAS  
TO BE OUR UGLIEST  
SUPPLY YET.**

**Elaxon: the ugliest dc supplies on earth.**

Get UGLY at Cramer, Newark, MIL-COMM, QPL and Utronics. Or call 714/979-4440.

# Control a VCO's start and stop phases with a squelch input signal

A voltage-controlled oscillator (VCO) can be built with a squelch feature that can start and stop the oscillations with a predetermined phase.

Built with five standard ECL gates and two discrete transistors, it was originally designed for phased-locked-loop operation at frequencies of about 10 to 15 MHz (Fig. 1). But with the proper timing capacitor, C, the control voltage,  $V_x$ , can cover a frequency range from audio to vhf. The upper limit is about 128 MHz with  $C = 5.1$  pF and  $R_1 = R_2 = 300 \Omega$ . Type MC10105 gates, which don't have internal output load resistors, are used; otherwise the VCO's frequency range is narrowed.

Two npn transistors form a constant-current source controlled by the input voltage,  $V_x$ , to charge and discharge the timing capacitor, C. Gates  $G_1$  and  $G_2$  form a bistable latch, and gates  $G_3$  and  $G_4$  "sense" the voltage across capacitor C. Gate  $G_5$  can open the feedback loop by inhibiting  $G_3$  and  $G_4$ .

To help in examining the circuit, assume that the squelch input is HIGH, that output  $\overline{Q_1}$  is LOW and that  $\overline{Q_2}$  is HIGH.

With  $\overline{Q_1}$  HIGH, the charge in capacitor C is gradually changed by the constant current,  $I_2$ , until the voltage at  $Q_2$  becomes equal to the gate's ECL threshold level. Then the output of  $G_4$  becomes HIGH and reverses the state of the latch,  $G_1/G_2$ . Note that one of the output emitter followers is always reverse biased.

Now  $\overline{Q_1}$  is HIGH,  $\overline{Q_2}$  is LOW and the voltage at  $Q_1$  becomes

$$2 V_H - V_{th} = -2 \times 0.9 \text{ V} + 1.3 \text{ V} = -0.5 \text{ V}.$$

Voltage  $V_H$  is the ECL HIGH output level and  $V_{th}$  is the ECL input threshold voltage. The next transition occurs after an interval,

$$t_1 = \frac{2}{I_1} C (V_H - V_{th}),$$

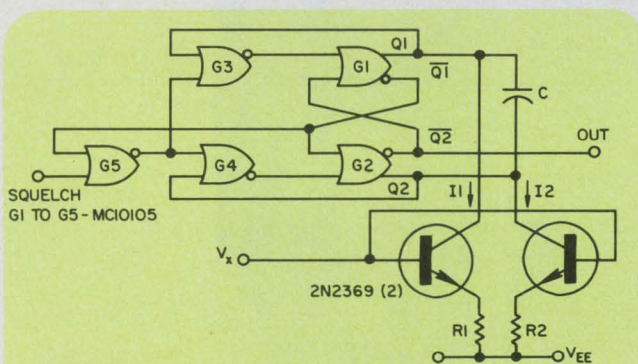

1. The squelch input on this VCO can stop and start the oscillations with a predetermined phase.

and the transition that follows occurs after an interval

$$t_2 = \frac{2}{I_2} C (V_H - V_{th}).$$

The oscillation frequency then is

$$f = \frac{1}{t_1 + t_2} = \frac{1}{2 \left( \frac{1}{I_1} + \frac{1}{I_2} \right) (V_H - V_{th}) C}.$$

The transfer function of the VCO therefore is

$$\frac{\Delta f}{\Delta V_x} = \frac{1}{2 C (R_1 + R_2) (V_H - V_{th})} = \frac{1.25}{(R_1 + R_2) C}.$$

Of course to obtain symmetrical output waveforms,  $R_1$  and  $R_2$  must be equal.

If the squelch input is set LOW,  $G_3$  and  $G_4$  are inhibited as soon as  $\overline{Q_1}$  also goes LOW. The oscillations stop, but in a known state—with  $\overline{Q_1}$  LOW and  $\overline{Q_2}$  HIGH. And when the squelch input is made HIGH again, the first oscillation transition occurs after the time interval

$$t = \frac{C}{I_1} (2 V_H - V_L - V_{th}),$$

where  $V_L$  is the ECL LOW output level. In this manner, the oscillation start phase is defined by the rising edge of the squelch signal.

Plots of frequency vs input voltage are shown on Fig. 2 for  $C = 62$  and  $510$  pF. For best linearity the control voltage,  $V_x$ , should be restricted between  $-1$  and  $-3$  V.

Tests on the circuit showed that for a temperature change from 0 to 80 C, the frequency change was 2.3% at nominal output of 12 MHz when the control voltage is  $-2$  V. Spectrum analyzer measurements showed that output jitter at 12 MHz was 15 ps.

*Todor Bodurov, Senior Engineer, Linear Circuit Development Dept., Memorex Corp., San Tomas at Central Expressway, Santa Clara, CA 95052.*

CIRCLE NO. 312

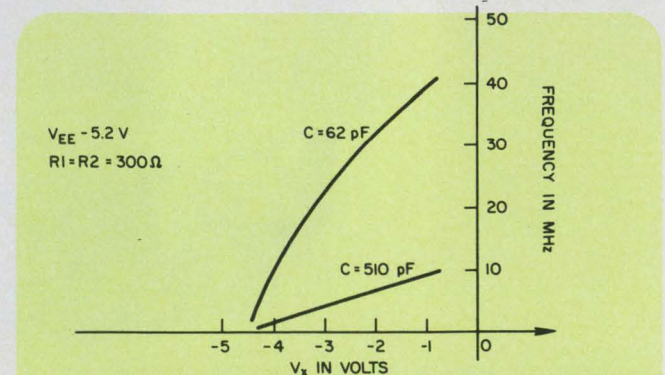

2. Best linearity of frequency control is obtained when  $V_x$  is kept between  $-1$  and  $-3$  V.

# PMI-The $\mu$ P DAC Store.

When you go shopping for D/A Converters, please swing by PMI. Ever since we opened our doors six years ago, we've been working hard to spice up our shelves with the widest line of  $\mu$ P-compatible monolithic DACs in the industry. 6-, 7-, 8-, 9-, and 10-bit DACs. Current or voltage outputs. Internal or external references. Routine MIL-STD 883A Level B processing, with Level A available. Guaranteed specs over full MIL Temp range. PMI pioneered monolithic DACs. It's only natural to find more here than anywhere.

And if DACs are new to you, lean on PMI's experience. We've helped designers and project managers put dependable PMI monolithic DACs to work in the most unusual spots. How can we help you with your microprocessor?

Also, our price list, DAC data sheets and App. Notes are yours for the asking. Ask your distributor or call your local rep.



Precision Monolithics Incorporated  
1500 Space Park Drive, Santa Clara, CA 95050  
(408) 246-9222. TWX 910-338-0528.  
Cable MONO.

CIRCLE NUMBER 54

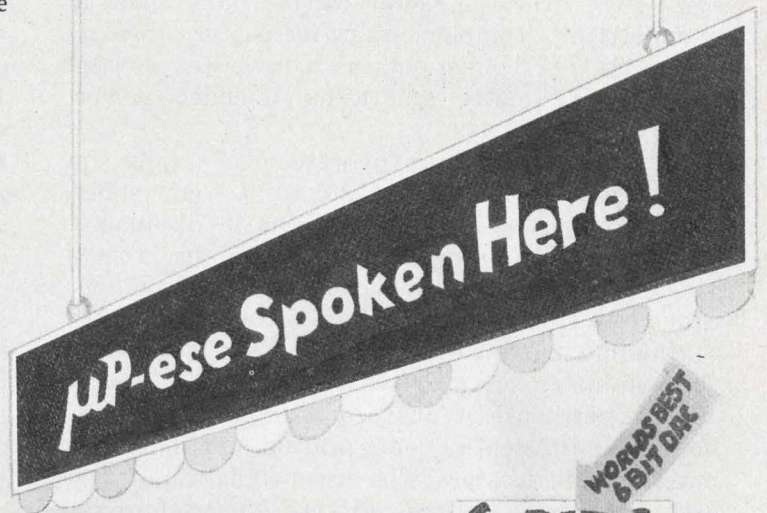

WORLD'S BEST  
6 BIT DAC

**6 BITS** Vout  
INTERNAL REF.  
from **\$9.25**

**10 BITS** Vout  
INTERNAL/EXTERNAL  
REF. FROM  
**\$10.00**

**8 BITS** Vout  
INTERNAL/EXTERNAL  
REF  
from **\$10.00**

**8 BITS** I out  
EXTERNAL REF.  
from **\$3.95**

**8 BITS** I OUT  
INTERNAL REF.  
FROM  
**\$9.95**

more  
**SOLD!**  
MORE MONOLITHIC  
DAC'S SOLD THAN  
BIG MAC'S (almost)



**10 BITS**  
**9 BITS**  
**8 BITS**  
DAC-02's from **\$15.00**  
**7 BITS**

# Efficient switching controller drives low-power dc servo motor

A high-performance switching controller for a low-power dc servo motor can be built using a symmetrical complementary-transistor bridge (Fig. 1). The bridge acts as a reversing switch between the motor and a single-ended power supply.

Since the transistors operate either fully on or completely off—except during a very short transition period—much less heat is dissipated than in linear-amplifier circuits. Damping is provided by the circuit's inherent dynamic braking. Since either maximum or zero voltage is applied to the motor, dynamic response is faster than that of linear servo drives.

The circuit uses a dual input-amplifier IC in a nonlinear differential configuration and four output driver transistors. The error-signal input has a common-mode voltage,  $(V_1 + V_2)/2$ , approximately equal to  $V_c/2$ . Bias levels,  $V_B \cong R_1 V_c/2 (R_1 + R_2)$ , which appear across resistors  $R_1$  and  $R_2$ , establish an amplifier dead zone. When the absolute value of the error signal  $|V_1 - V_2|$  is less than  $V_B$ , a voltage slightly less than  $V_c$  appears across both the amplifier outputs; thus, no

base current flows in transistors  $Q_1$  and  $Q_3$ . However, sufficient base current flows via zeners  $Z_2$  and  $Z_4$  into the bases of transistors  $Q_1$  and  $Q_2$  to saturate them. The motor, with the help of diodes  $D_1$  and  $D_2$ , is thereby clamped to ground for dynamic braking.

When  $(V_1 - V_2) > V_B$ , the output of  $IC_{1-1}$  is almost equal to  $V_c$ , while the output of  $IC_{1-2}$  is close to ground. Consequently,  $Q_1$  and  $Q_4$  are cut off, and  $Q_2$  and  $Q_3$  are saturated on.

Similarly, when  $(V_2 - V_1) > V_B$ ,  $Q_2$  and  $Q_3$  are cut off, and  $Q_1$  and  $Q_4$  are on. Thus the transistors act as a reversing switch controlled by the voltage difference across the input terminals.

The breakdown values of zeners  $Z_1$  through  $Z_4$  are chosen somewhat larger than  $V_c/2$  to ensure an all-off state between current reversals to the motor. Otherwise, catastrophic failure can occur if both transistors of either pair  $Q_1$  and  $Q_2$  or pair  $Q_3$  and  $Q_4$ , conduct at the same time.

*Max Fishman, Member of the Technical Staff, The Israel Electro-Optical Industry Ltd., P.O. Box 1165, Rehovot 76110, Israel. CIRCLE NO. 313*

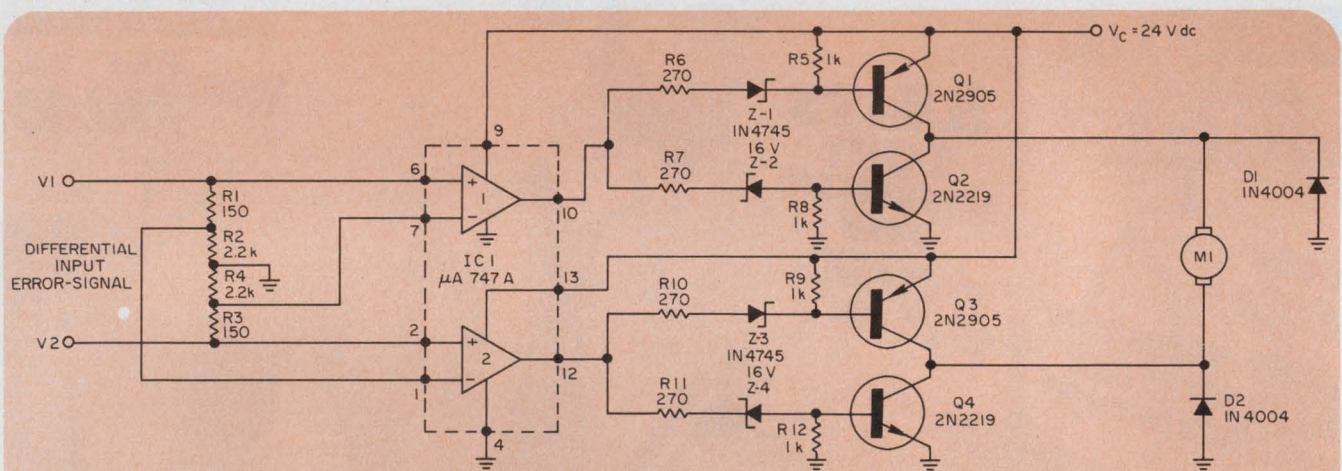

**A complementary-transistor bridge provides voltage reversal from a single-polarity supply to drive a**

**servo motor. The circuit provides dynamic braking for error signals below a preset bias level.**

## IFD Winner of January 5, 1976

**E. R. Fisher**, Electronics Engineering Dept., Lawrence Livermore Laboratory, University of California, P.O. Box 808, Livermore, CA 94550. His idea "Expand a System's Memory Capacity without Mounting Hardware and Board Space" has been voted the Most Valuable of Issue Award.

**Vote for the Best Idea in this issue** by circling the number for your selection on the Reader Service Card at the back of this issue.

**SEND US YOUR IDEAS FOR DESIGN.** You may win a grand total of \$1050 (cash)! Here's how. Submit your IFD describing a new or important circuit or design technique, the clever use of a new component or test equipment, packaging tips, cost-saving ideas to our Ideas for Design editor. Ideas can only be considered for publication if they are submitted exclusively to ELECTRONIC DESIGN. You will receive \$20 for each published idea, \$30 more if it is voted best of issue by our readers. The best-of-issue winners become eligible for the Idea of the Year award of \$1000.



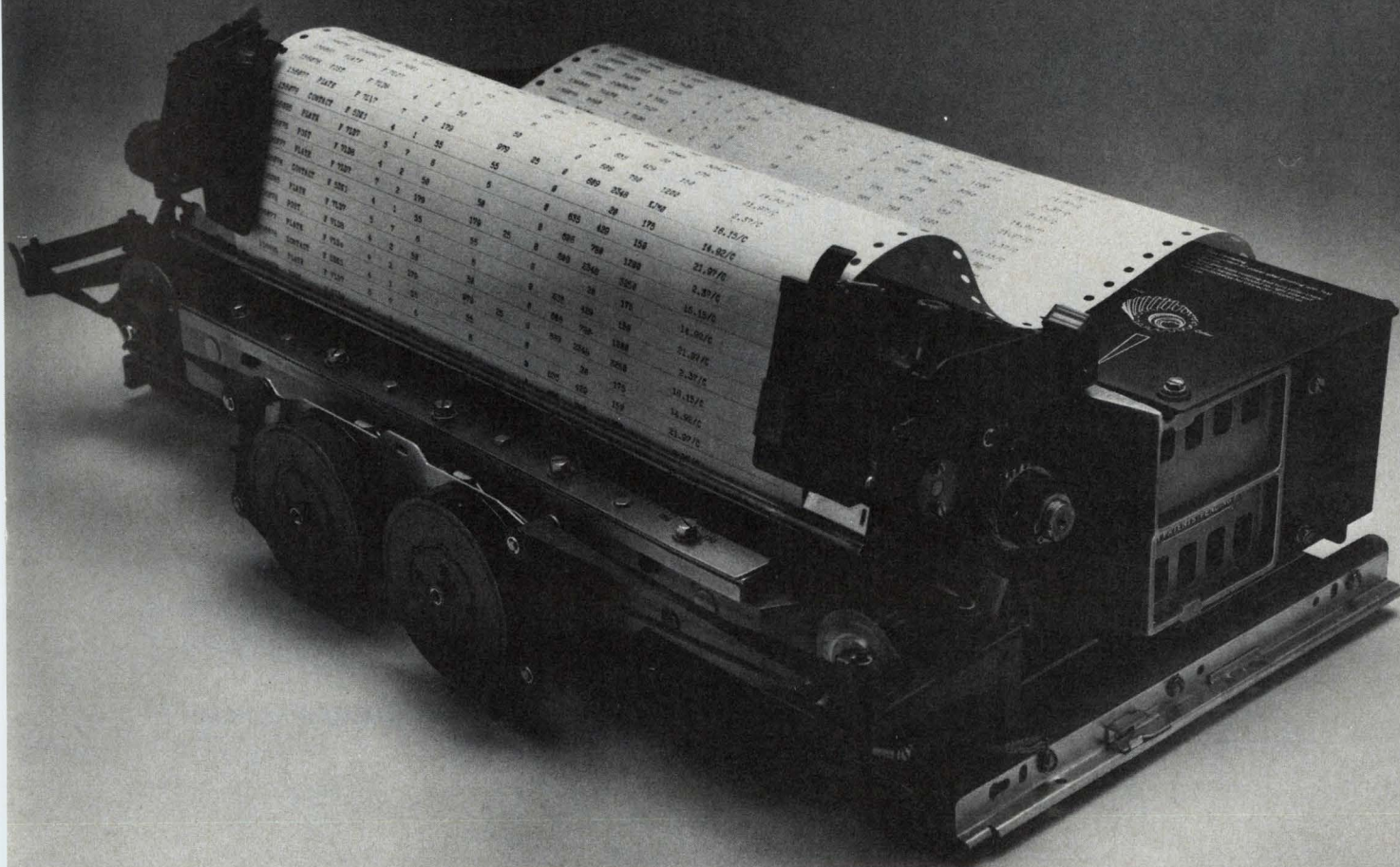

## 132 columns. Over 300 lines per minute. Under \$2000.\*

In printers, it's not just a question of how much they cost, but one of how much you get for your money. And on a price/performance basis, nothing even comes close to the Teletype® model 40 OEM printer.

Besides getting a 132-column, heavy-duty impact printer that delivers over 300 lpm for less than \$2000, you also get a printer with outstanding flexibility and reliability.

The big reason behind the model 40's price/performance advantage over the competition is our unique design. Even though it operates at speeds over 300 lpm, wear and tear is less than you'd find in a conventional printer operating at a much slower speed. Fewer moving parts and solid-state components add up to increased reliability and reduced maintenance.

We'd be ahead if we just stopped there, but the model 40 also offers you a number of other features. Like a choice of character sets, operator-adjustable form width and form length, parity error indication, and a built-in self-test feature, just to name a few.

For complete information, please contact our Sales Headquarters at: 5555 Touhy Ave., Skokie, Ill. 60076. Or call Terminal Central at: (312) 982-2000.



**The Teletype model 40 OEM printer.  
Nothing even comes close.**

# Arrow-M Amber Relays eliminate costly hand soldering.

Only Arrow-M manufactures gas-filled plastic sealed relays, proven to have top reliability over a long life. They're applicable from very low level to high capacity contact loads and maintain highly stable contact resistance, even after long use.

Now here's the really big news: by using Arrow-M Amber Relays on your PC board and using automatic wave soldering, you can substantially reduce your labor costs. And since Arrow-M Amber Relays cost less than sealed metal can relays, the savings are even greater.

Arrow-M Amber Relays. When you want maximum reliability *and* maximum savings. And only Arrow-M makes them.

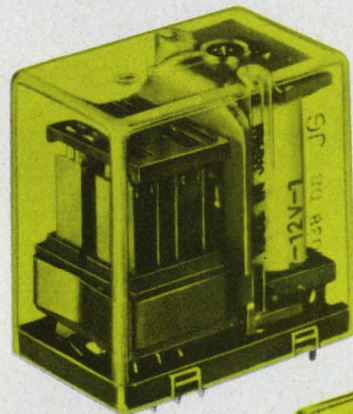

Type KE

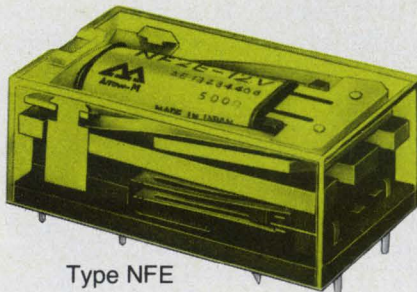

Type NFE

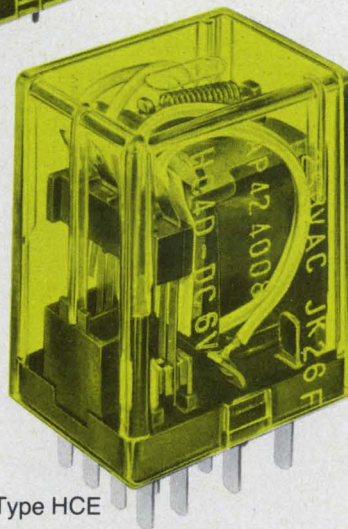

Type HCE

**Relays for  
advanced technology.**

For more information on exact specifications of our Amber Relays, write or call your nearest Arrow-M office.

**Arrow-M Corporation**  
250 Sheffield St.  
Mountainside, N.J. 07092  
(201) 232-4260

*Western Office:*  
22010 South Wilmington Ave.  
Suites 300 & 301  
Carson, California 90745  
(213) 775-3512

#1A

CIRCLE NUMBER 56

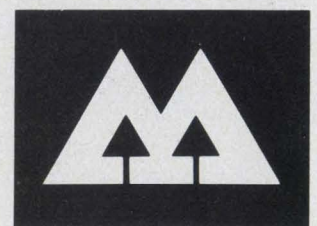

**Arrow-M**

Member of Matsushita Group

ELECTRONIC DESIGN 10, May 10, 1976

# Data terminal features low-cost, programmable character set

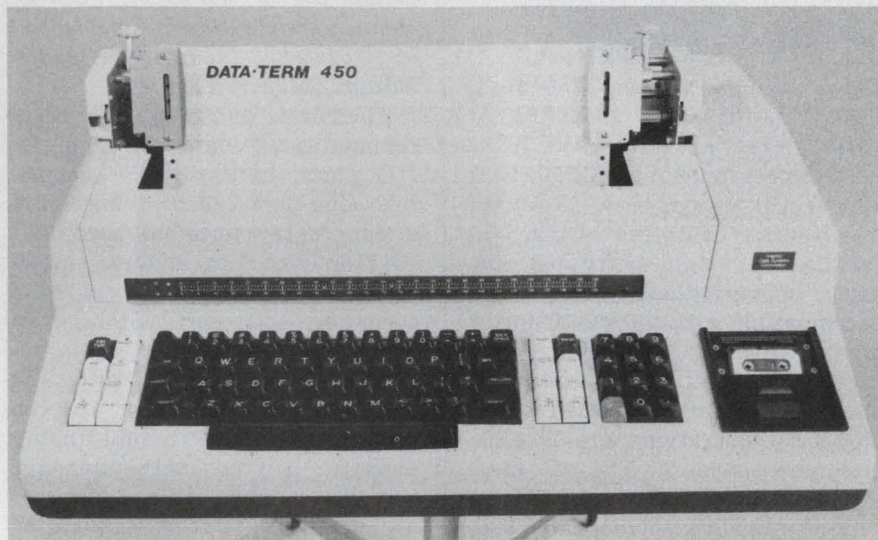

*Intertec Data Systems Corp., 1851 Interstate 85 S., Charlotte, NC 28208. (704) 377-0300. See text.*

A low-cost data terminal, the Data-Term 450, can be programmed to print any character set desired. It boasts a cost of only \$1300 in single units for the basic terminal.

The system as supplied prints the standard 96-character ASCII set. In addition, engineering symbols or foreign characters may be printed under keyboard or program control.

To program up to 16 additional special characters, the user punches a sequence of keys that define each point on the 7 × 7 dot matrix forming every character. This information is stored inside the terminal, and the character may then be called by a simpler sequence of keystrokes or through external control.

Unused ASCII codes may also be used to recall special, previously programmed characters. For instance, ASCII codes of lower-case alphanumeric characters can be interpreted by the terminal as pre-programmed special characters.

Programmed characters may be single or double width, which allows flexibility in font layout. One

disadvantage of the user-programmed character set is that the user-defined characters cannot be stored in the terminal when power is shut off. They may, however, be transferred to cassette tape.

The terminal's printer uses an impact mechanism onto ordinary paper, so special thermal paper is not required. Print width is 132 columns, and speed is 45 chars/s. Options include higher speeds of 60, 120 and 180 chars/s.

The keyboard is similar to an IBM Selectric, has tactile feedback, and has an additional 30-key alphanumeric keypad with dual function keys.

Communication to the outside world is through a standard RS-232C interface, Bell 113A data set, or an acoustic coupler. When using the latter two methods there is a built-in 3-s delay before the unit will send or receive information. This delay eliminates initial hook-up noise. Transmission speed is switch-selectable from 75 to 1200 baud.

Intercette, a built-in tape micro-cassette, is also available on the Data-Term 450. A second Intercette tape unit may be added as an external peripheral for dual tape requirements. 25,000 characters

may be stored on one tape cassette. The built-in drive adds \$700 to terminal cost.

The terminal is internally controlled by an 8080 microprocessor. The internal RAM that does house-keeping functions and stores the programmed characters contains 16,000 bytes. Various high level software packages loaded from the Intercette tape system may be run if additional optional memory is added.

Other standard features: horizontal and vertical tabs, variable form control and terminal weight of 45 lb. The unit consumes 225 W when printing; otherwise it takes 75 W.

*Booth No. 2807-2811*

*Circle No. 304*

## Word generator reacts to external inputs

*Interface Technology, 852 N. Cummings Rd., Covina, CA 91724. (213) 966-1718. \$5985; 10-12 wks.*

The Model RS-432 data and timing generator can change its output depending upon external conditions. Under microprocessor control, the unit can generate data contingent on special inputs such as levels, pulses or sense switches. It generates data continuously or intermittently. The RS-432 also generates serial or parallel data of specified period or from selected blocks of memory. Simultaneously with the data, all control and timing signals required by the unit under test are available. The RS-432 is completely self-contained, requiring no external clocks or dc power. The basic unit allows the user to configure program memory and word memory to suit the specific application. Memory modules for the program memory are provided in 64 and 256-word blocks.

*Booth No. 2417 Circle No. 305*

### Matrix printer produces little acoustic noise

Tally Corp., 8301 S. 180th St., Kent, WA 98031. (206) 251-5644. \$2575; 90 days.

The Model 1200 dot matrix serial printer features a new low-noise cover for exceptionally quiet operation. The unit prints 132 columns at 120 char/s. The Model 1200 uses a stepper-motor print-head advancement and microprocessor controlled electronics. Other features include dual tractor engagement above and below the print line for positive paper advancement and positioning, and snap-in ribbon cartridge for easy ribbon replacement. Slew speed is 10 in./s. The Model 1200 prints an original plus four carbon copies and handles form widths from 4 to 15 in. Specifications include 6-lines/in., 10-char/in. and a 64 character ASCII set.

Booth No. 2217 Circle No. 306

### Programmable unit offers 100 steps



Texas Instruments, P.O. Box 5012, MS 84, Dallas, TX 75222. (214) 238-2481. \$179.95; stock.

Key programmable SR-56 is a 100-step, 10-memory calculator with an algebraic operating system featuring left-to-right entry and nine levels of parentheses. The SR-56 is compatible with the PC-100 print cradle, which allows complete tracing and printout of any calculator operation. Over 25 scientific and statistical operations are possible from the keyboard. The two looping capabilities and four levels of subroutines allow sophisticated programming.

CIRCLE NO. 307

### Floppy disc transfers data via RS-232C

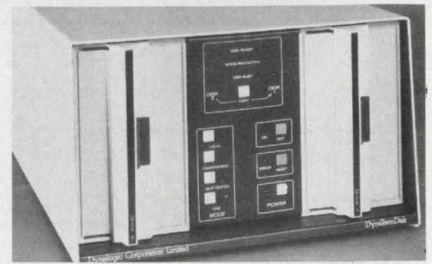

Dynalogic Corporation Ltd., 141 Bentley Ave., Ottawa, Canada K2E 6T7 (613) 226-1383. 7002A: \$3950; Editor: \$495; 30 days.

The Series 7002A DynaTermDisk communicates data through two I/O ports, both RS-232C compatible. One port can be connected to a data entry terminal such as a CRT or hard copy printer, and the other port connected to a mini-computer I/O port. Storage capacity is 630 kilo-bytes on two diskettes. The unit can also automatically copy and verify the contents of one diskette onto another diskette. An optional editor feature is available, which allows the user to edit data from the data entry terminal.

CIRCLE NO. 308

## Problem:

You need a highly-styled instrument case with a custom look now.

## Solution:

The Bud ShowCase or TR Series. Either one fits the bill and they're standard instrument cases available at your Bud Distributor now.

Both the ShowCase and TR Series give you portability, versatility. The ShowCase (right) comes in ten sizes. Two color combinations. Front and rear panels, plus bail are included at no additional cost. The TR Series (left) comes in four sizes. Two color combinations in Nextel suede finish. Handle doubles as tilting bail. Front panel and handle/bail included. **YOUR PROBLEM IS SOLVED!**

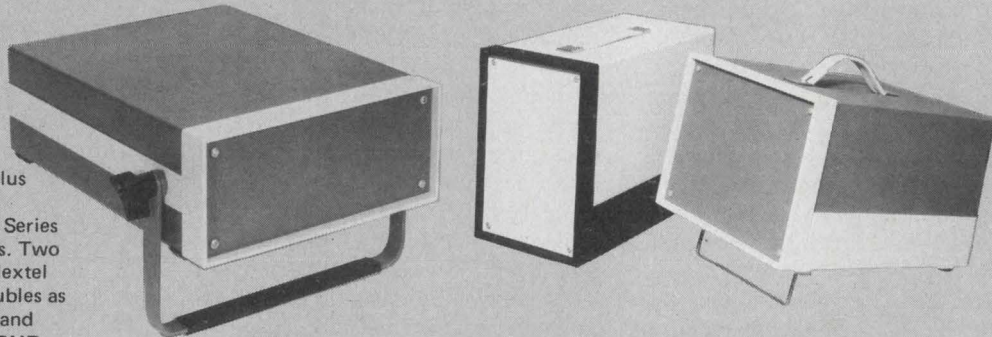

## Call toll free:

(800) 321-1764 for more facts. In Ohio, (800) 362-2265.

# BUD

BUD RADIO, INC.  
Willoughby, Ohio 44094

# WHY LOOK FURTHER.

## NEED A HIGH PERFORMANCE, DEPENDABLE, AND ECONOMICAL DATA MODEM FOR A SPECIFIC APPLICATION?



THE PSH 96A — an asynchronous modem for short haul transmission of digital data at rates up to 9600 bps half/full duplex over non-loaded cable pairs.



THE 48/MULTI — an eight-phase half/full duplex synchronous modem providing high performance at 4800 bps over basic 3002 unconditioned lines.



THE 313B — an FSK full duplex modem providing asynchronous 0 to 300 bps operation over the dial network.

If you do, remember that Penril's complete and versatile product line features a rugged, well-designed, and reliable data modem for almost every data communications situation.

For example, Penril manufactures modems for asynchronous and synchronous short haul transmission at speeds up to 1,000,000 bps — another model for multi-point applications at 4800 bps — and others for asynchronous operation from 0 to 300 bps.

In addition to these models, Penril produces an asynchronous FSK data modem operating at up to 1200 bps over dial lines or 1800 bps over dedicated lines. Or there is Penril's serial asynchronous modem for half duplex operation to 1200 bps with reverse channels of 5 bps or 150 bps. And Penril provides a model series operating at 2400 bps half/full duplex over two or four-wire dedicated or dial networks.

**WHATEVER THE PURPOSE AND DESIGN REQUIREMENTS, PENRIL HAS THE MODEM.**

For complete product information write or call

**Penril** Data  
**Corp.** Communications  
Division

5520 RANDOLPH ROAD • ROCKVILLE, MARYLAND 20852

301/881-8151



**UNBELIEVABLE!!!!**  
**The Intecolor® 8001**  
 A Complete 8 COLOR  
 Intelligent CRT  
 Terminal  
**\$1,995\***

**"Complete" Means**

- 8080 CPU • 25 Line x 80 Character/Line • 4Kx8 RAM • PROM Software
- Sockets for UV Erasable PROM • 19" Shadow Mask Color CR Tube
- RS232 I/O • Sockets for 64 Special Graphics • Selectable Baud Rates to 9600 Baud • Single Package • 8 Color Monitor • ASCII Set
- Keyboard • Bell • Manual

And you also get the Intecolor® 8001 9 sector Convergence System for ease of set up (3-5 minutes) and stability.

**Additional Options Available:**

- Roll • Additional RAM to 32K • 48 Line x 80 Characters/Line • Light Pens
- Limited Graphics Mode • Background Color • Special Graphic Characters
- Games

\*OEM quantity 100 (OEM Unit Price \$2,495.)

**ISC WILL MAKE A BELIEVER OUT OF YOU!**



**Intelligent Systems Corp.®** 4376 Ridgeway Drive, Duluth, Georgia 30136  
 Telephone (404) 449-5961

CIRCLE NUMBER 58

**DATA PROCESSING**

**Calculator prints and is programmable**

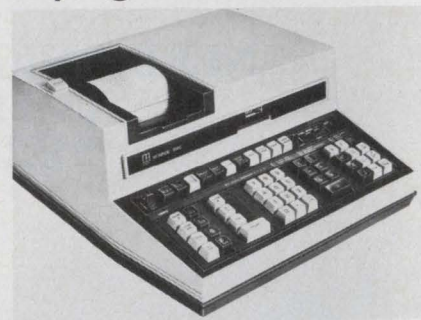

Monroe, The American Rd., Morris Plains, NJ 07950. (201) 540-7300. \$3240; 30 days.

The Monroe Model 1880 programmable printing calculator combines the features of a scientific calculator and portable computer with I/O capability. The heart of this system is a user-microprogrammable microprocessor, plus 7 k bytes of ROM operating system for hi-level instructions and 1.5 k bytes of working storage. This microprocessor subsystem is complemented by a keyboard for input, a 21-column printer for output and a magnetic card reader/writer for offline program and data storage. All of this is packaged in a desktop unit the size of a typewriter. Weight is only 22-1/2 lb. Keyboard operation is simple and straightforward, following algebraic rules of equation solving and includes two-level nesting of arithmetic operations. By single key-stroke operations, 27 mathematical functions are provided. The 1880 offers optional user-definable keys which allow the user to address up to three programs or subroutines with one key depression. The 1880 calculator also offers user access to more than 230 microprogramming instructions for implementing an operating system and I/O control. I/O communication is via a serial bus or via an 8-bit parallel input. The calculator also allows byte or word transfer, DMA and interrupts. The unit provides 1024 program steps with main memory expansion in 1024-byte increments to a total of 4096. The programming flexibility of the Model 1860 is further enhanced by symbolic and indirect addressing techniques.

Booth No. 2309, 11, 13

Circle No. 309

**Better...  
 ...across  
 the  
 board.**



Our PLP-550 logic probe is internally programmed to select C-MOS, HTL, TTL/DTL logic.

Stretch memory catches single,

short pulses you can't see.

Unique three lamp system gives you duty cycle information you'd otherwise need a scope to see.

Next time out, take the Kurz-Kasch PLP-550 with you... and leave your scope back at the shop. Soon to be available are single and dual family probes in the same rugged, functionally designed package.

Call or write.....



**Kurz-Kasch, Inc.**  
 Electronics Division,

1501 Webster Street, P.O. Box 1246, Dayton, Ohio 45401 (513) 223-8161

CIRCLE NUMBER 59

# Bicentennial Issue

Electronic Design 4

200 YEARS OF PROGRESS

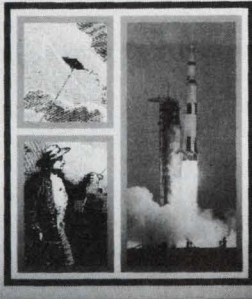

**\$4**

JUST

**SUPPLY LIMITED**

We've saved a limited number of copies of the unique 254-page February 16th Bicentennial issue of *Electronic Design*. It traces the historic and technological developments of the electronics industry from the Colonial period to today.

In a message from the White House published in the Bicentennial issue, President Ford commends the issue as "a special part" of our nation's 200th anniversary.

If you'd like an extra copy as a memento of this historic event, we'll be happy to provide it at \$4.

Hurry! When the supply runs out you'll have to wait another hundred years for anything like it!

## Bicentennial Issue Electronic Design

Hayden Publishing Company, Inc.  
50 Essex St., Rochelle Park, N.J. 07662

Please send me \_\_\_\_\_ copy (copies) of *Electronic Design's* February 16 Bicentennial issue at \$4 each. I enclose my check for \_\_\_\_\_.

Name \_\_\_\_\_

Title \_\_\_\_\_

Company \_\_\_\_\_

Address \_\_\_\_\_

# Dialight sees a need:

(Need: The widest choice for your every application.)

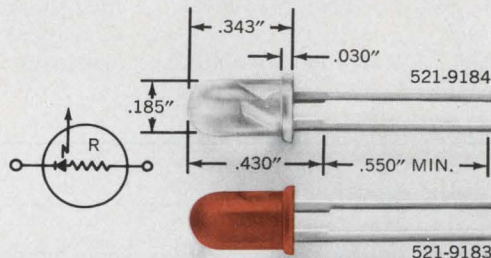

Available in red or clear LED packages with or without a built-in current limiting resistor. Red LED is also made without resistor. Suitable for circuit status indication, alpha-numeric displays and visual indicators. Features long wire-wrappable leads. IC compatible with solid state reliability. High luminous intensity, low power consumption, low cost.

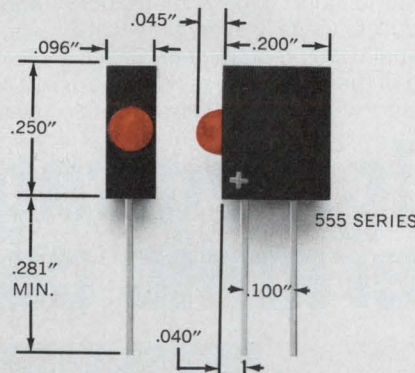

LED logic state fault indicators available in 14 models with voltage ratings from 1.7 to 14. Suitable for dense packaging on printed circuit boards—up to 10 units to the inch—IC compatible. With built-in series resistor. Polarity identified. Low power consumption.



Dialight, the company with the widest choice in switches, LEDs, indicator lights and readouts, looks for needs . . . your needs . . . and then they develop solutions for your every application. No other company offers you one-stop shopping in all these product areas. And no other company has more experience in the visual display field. Dialight helps you do more with these products than any other company in the business, because we are specialists that have done more with them. Talk to the specialists at Dialight first. You won't have to talk to anyone else. Send for your free new copy of Dialight's current catalog.

## DIALIGHT

Dialight, A North American Philips Company  
203 Harrison Place, Brooklyn, N. Y. 11237  
(212) 497-7600

# See Dialight.

CIRCLE NUMBER 60

## DATA PROCESSING

### Disc unit mates with Data General computers

EMM Computer Products Div., Dept 1000, 1015 Timothy Dr., San Jose, CA 95133. (213) 644-9881. \$4995; stock.

The Model EMM 1000 disc subsystem replaces or augments the

floppy-disc units on Data General and equivalent computers. The subsystem has a 3-megabyte capacity and consists of one to four disc drives and one controller. The disc drive uses a moveable head with a fixed disc, and the controller consists of a single board that plugs into the computer. The EMM 1000 is transparent to Data General's operating systems.

CIRCLE NO. 310

### A/d converter card connects to LSI-11

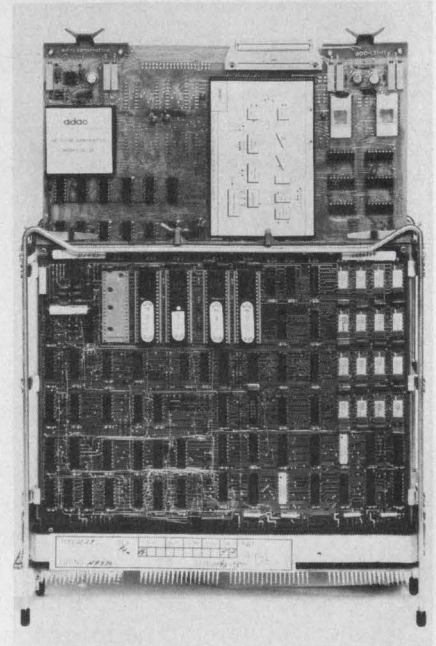

Adac Corp., 118 Cummings Park, Woburn, MA 01801. (617) 935-6668. \$895 (16 ch); \$1185 (64 ch).

The Model 600-LSI-11 is designed as a companion peripheral for the DEC LSI-11 series of low cost 16-bit microcomputers. The multiplexed 12-bit a/d converter system has 16 to 64 channels and is built on a quad size (8-1/2 x 10 in.) DEC-style PC board. The multiplexer of the Model 600-LSI-11 can be connected either single-ended or differentially, and can operate either in a sequential mode or for random access. Four jumper-selectable ranges of analog gain are provided. The system throughput rate is 50 kHz. The card plugs directly into the LSI-11 backplane and derives its power from the same +5 V that powers the computer. A dc/dc converter is included to provide noise-free power to the analog circuitry. A program interrupt interface is also included to allow efficient operation of this peripheral. An optional software programmable gain amplifier allows the computer to select one of four gain settings for any of the input channels over a 10 to 1 range. Included with this option is an automatic zeroing feature that prevents offset drifts even at the highest gain. Provision is also made for two 12-bit d/a converters to provide analog output capability.

Booth No. 1203 Circle No. 320

Experience can't be bought at any price and with over 30 years in the design and manufacture of high voltage ceramic capacitors, Murata has experience that's unsurpassed in the field. This experience has made Murata the world's largest producer of high voltage ceramic capacitors and generated a reputation for quality and performance second to none. What's more, our line covers virtually every high voltage application requirement. Check some of the brief features listed below and we're sure you'll want to

know more. Our complete information package is yours for the asking. Write or call today.

**DH, DHL, DHG Types. For Power Supplies and Power Distribution Systems:** 10-30 KVDC WV. 40, 50 & 60 KVDC WV also in DH. 500-5,000 pF. Z5V, Y5P & N4700 Temp. Char. Epoxy Resin Encapsulation.

**DHR Type. For Color TV Doublers and Triplers:** 500-1,000 pF. 10, 12 and 15 KVDC WV. Z5P & N4700 Temp. Char. Extremely Low Noise Level. (Higher Capacities are also available.)

## high voltage ceramic capacitors

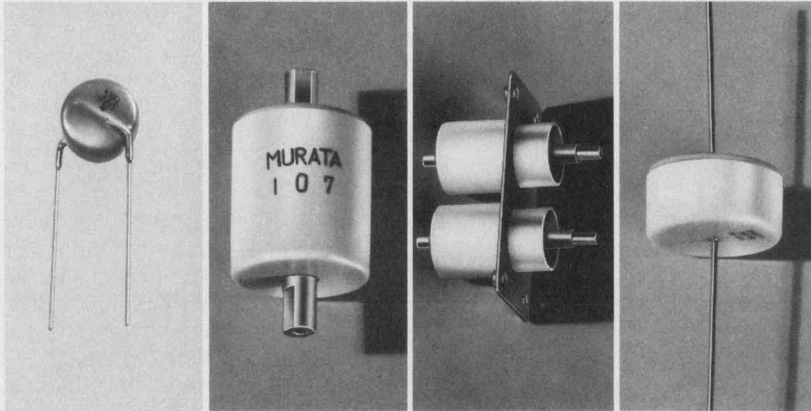

experience makes the difference

Rockmart, Georgia 30153  
Phone: 404-684-7821  
TWX: 810-766-1340  
Telex: 54-2999

**muRata**  
CORPORATION  
OF AMERICA

CIRCLE NUMBER 62



# Compare!

CATHODE RAY  
TUBES FOR  
DATA DISPLAY  
TERMINALS

BURROUGHS  
NEW LOW COST  
SELF-SCAN II  
240-CHARACTER PANEL  
FOR DATA DISPLAY  
TERMINALS



Burroughs' new, low-cost SELF-SCAN II 240-character displays offer many features compared with CRT terminal displays. Contrast and readability are better than ever under all conditions. Characters are jitter- and flicker-free bright neon-orange color, with no fuzziness or loss of linearity at the edges of the display. An all-new manufacturing process has significantly reduced cost, weight, size, and has improved reliability. And, the SELF-SCAN II panel's 40-character line is compatible with popular software. Graphics can also be displayed using additional drivers.

Other significant advantages include easy interface to micro-processors, thin cross-section, small overall size, and rugged construction for long service life under all operating conditions.

Terminal space saved with SS II

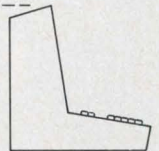

Give your data terminals a bright new outlook; call or write for complete information. Burroughs Corporation, Electronic Components Division, P.O. Box 1226, Plainfield, New Jersey 07061. Telephone (201) 757-5000.

You can **see** the difference

**Burroughs**



## PACKAGING & MATERIALS

### Connector designed for mass termination



3M Co., P.O. Box 33600, St. Paul, MN 55133. (612) 733-1590.

Versatile new male connectors available in two configurations for mass termination applications feature 0.025-in. square pins, with mounting flanges for rack-and-panel applications, and without flanges for midspanning. Manufactured in a variety of sizes from 10 to 50 contacts, they are compatible with Scotchflex-brand socket connectors. Applications include use as a T-tap from a cable bus, a splice connector or an I/O interface. The plastic-connector housing is a glass-reinforced polyester material with a UL flammability rating of 94 V-O. Cables on 0.050-in. conductor centers are available for use with all connectors.

Booth No. 2424 Circle No. 321

### Microscope projects for easy viewing

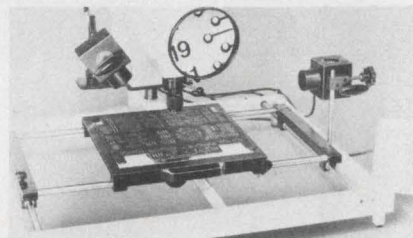

Aikenwood Co., 223 Forest Ave., Palo Alto, CA 94301. (415) 326-2151. From \$3600.

The Visomet-300 projects a high-resolution image on a ground glass screen, enabling the operator to sit at a comfortable viewing distance and eliminating the fatigue associated with bending over a conventional microscope. The new instrument accommodates flat samples sized up to 20 by 25 in. on its large floating stage, which runs on ball bearings. The magnified image is presented without reversal. A shade eliminates the possibility of stray reflections on the fine-grain viewing screen. Standard magnifications from 5x to 30x are available.

Booth No. 2614 Circle No. 322

### Mylar legends applied to keycaps

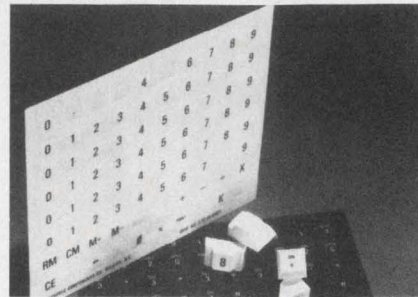

Stackpole Components Co., P.O. Box 14466, Raleigh, NC 27610. (919) 828-6201.

Engraving legends on keycaps is a serious economic problem for low-volume users. However, characters printed on sheets of pressure-sensitive Mylar can be applied to Stackpole caps. Because the Mylar characters are recessed into the caps, they can't be peeled off unintentionally. For reprogramming, the Mylar can be removed and new legends applied. Mylar keycaps may be specified for keyswitches LO PRO 5, LO PRO 20, their high-profile equivalents or for custom keyswitches.

Booth No. 2424 Circle No. 323

## DIP REED RELAYS 35 MODELS

Your choice of:

- SPST, DPST & SPDT dry reed contacts, 3 to 10 watts.
- SPST mercury wetted reed contacts, 28 watts.
- 5 to 24 VDC coils, 4, 8, or 14 terminals. TTL compatible.
- Optional clamping diodes and electrostatic shielding.

Available from distributors. Or contact us today.

26477 N. Golden Valley Road • Saugus, Calif. 91350  
(805) 252-8330 • (213) 788-7292 • TWX 910-336-1556

## ELEC-TROL, INC.

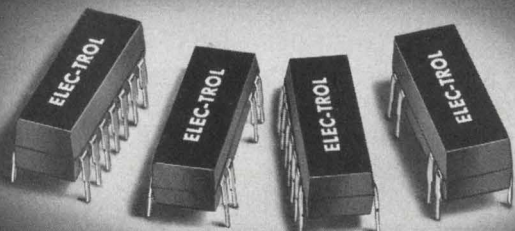

eem

CIRCLE NUMBER 64

## REED RELAYS TO FIT YOUR SPECS... AND BUDGET

Our **Open-Line** reed relays will give you high performance at remarkably low cost if you have no critical environmental factors to worry about.

Our **Encased-Line** is epoxy sealed to meet extreme environmental and handling conditions.

**Both offer** top performance; choice of Form A, B, or C dry reed contacts; Form A mercury wetted reed contacts; up to 6 poles; coil voltages 5 to 48 Vdc; either .1" or .15" terminal spacing; optional electrostatic or magnetic shielding.

Available from distributors. Or contact us today.

26477 North Golden Valley Road • Saugus, Calif. 91350  
(805) 252-8330 • (213) 788-7292 • TWX 910-336-1556

## ELEC-TROL, INC.

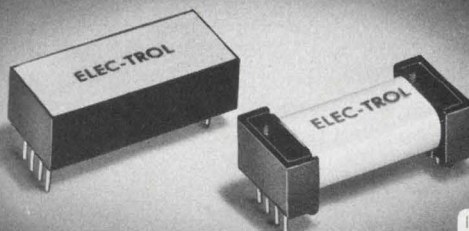

eem

CIRCLE NUMBER 65

# 5-Volt, 10-AMP Power Supply

The Model HE237 Power Supply offers the design engineer, for the first time, a low cost, highly efficient alternative to the size, weight, and heat generation problems normally associated with series-pass regulated supplies. Using state-of-the-art switching techniques and CMOS logic, the HE237 achieves 75% efficiency, at a full load of 10 amps.

The HE237 has the "footprint" and mounting dimensions of the Lambda package size "B" supplies—a feature that allows the engineer to experiment with high efficiency techniques in exist-

ing designs. In new designs, the engineer can take advantage of the HE237's small size (6½" x 4½" x 1½") and light weight, (1.7 lbs).

The highly reliable HE237 Power Supply is short-circuit proof, contains over-voltage protection, and is backed by a full two year warranty.

Finally, the HE237 offers the design engineer considerable savings. It is available in both 115 and 230 VAC input models for just \$195...quantity, one.

 **Computer Products, inc.**

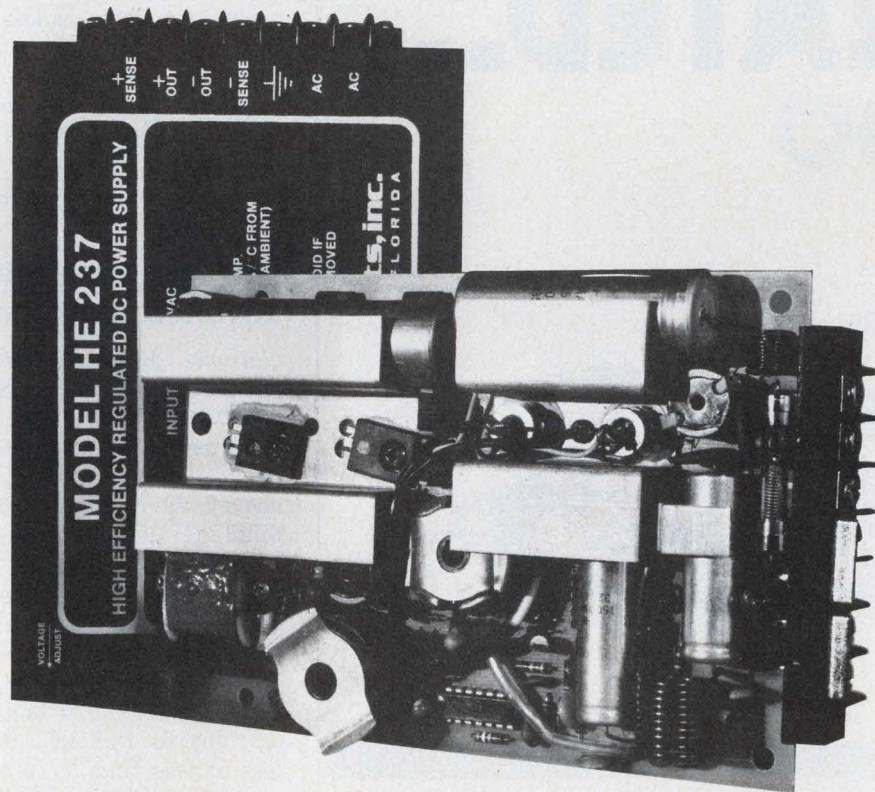

1400 NW 70 Street, Fort Lauderdale, Florida 33309 • (305) 974-5500, TWX (510) 956-9895.

Distributors: Los Angeles 213-877-5518 / Albuquerque 505-255-2440

CIRCLE NUMBER 66

# High Efficiency

## PACKAGING & MATERIALS

### Insert makes it easy to screw into sheets

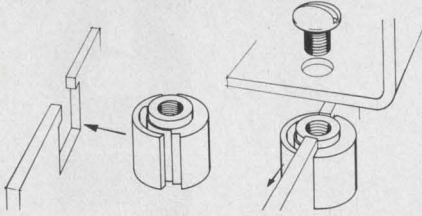

Southco Inc., Brinton Lake Rd., Concordville, PA 19331. (215) 459-4000.

The new Southco, FI, sheet-edge insert snaps into a prepunched notch in a thin sheet and remains in place, held by a spring leg that locks behind the panel. This makes it easy to screw into the edge of a sheet without the need for flanges or riveted brackets.

Booth No. 1228-30 Circle No. 324

### Card-edge connector uses zero insertion force

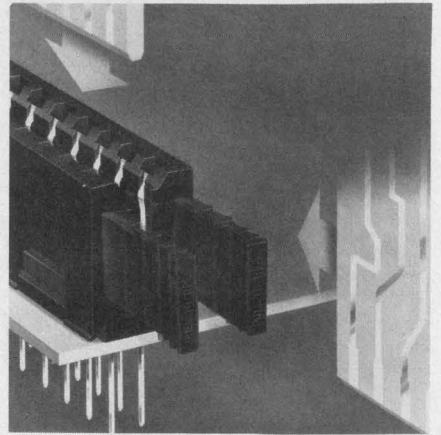

Amp Inc., Harrisburg, PA 17105. (717) 564-0101.

Requiring a minimum of 0.5-in. mounting width, new zero-insertion-force connectors accept PC boards inserted from either the top or the side for high-density packaging applications. Designed for use with double-sided or multilayer boards from 0.054 to 0.071-in. thick, the connectors are available with up to 280 contacts (140 dual-contact positions) on 0.125 × 0.125-in. spacing. Actuating mechanisms include lever-operated cam and push-pull slides. The activating mechanism requires less than 0.450-in. linear travel to establish electrical contact. When opened, the contacts are withdrawn behind internal housing barriers for protection during PC-board insertion.

Booth No. 1532-34 Circle No. 325

## electrocube capacitors

...are now offered in miniature AC rated models, of metallized polypropylene and with foil, in 135 VAC and 270 VAC versions with ratings to 10 mfd. Smaller than existing units, this may be the only 270 VAC dry capacitor available. And these can also be used for DC applications, to 200 VDC with 135 VAC units and to 400 VDC with 270 VAC capacitors. Get more data on these new components...write or call Electrocube, 1710 So. Del Mar Ave., San Gabriel, CA 91776; (213) 573-3300.

FREE...data file on request

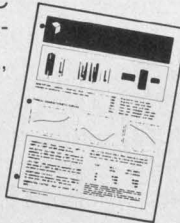

# AC RATED... DC, TOO

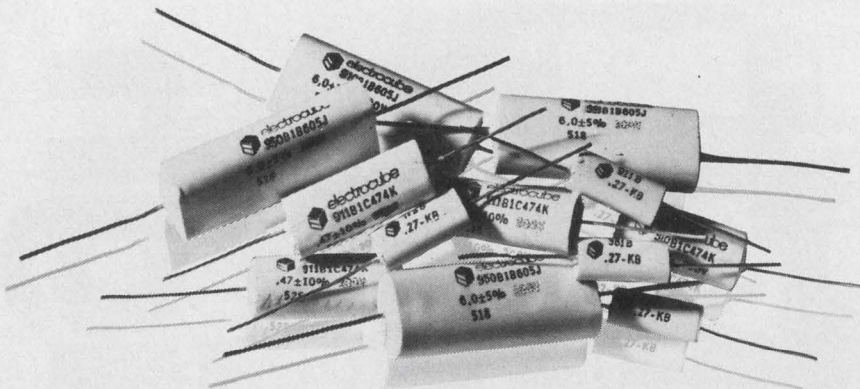

### Two new magnetic alloys advance Xformer design

National Magnetics Corp., 13607 Pumice St., Santa Fe Springs, CA 90670. (213) 921-7517.

Cobisil, a newly developed cobalt-iron alloy, achieves a 40-to-52% energy savings and can be used to 22 kG. Its size and weight yields a reduction up to 30% and is the answer to lighter-and-smaller transformer designs, according to National Magnetics. Nicosil is a newly developed nickel alloy that attains a 75% flux density for operations to 13.8 kG. Its ultra-low loss of less than 1/10 that of conventional silicon steel fills the needs of high-frequency transformer and switching/inductor applications to 70 kHz.

Booth No. 2814 Circle No. 326

...also available in REEL PACKAGING.

CIRCLE NUMBER 67

# introducing

## THE NEW WESTON AUTORANGING PORTABLE DMM

The best buy ever in a portable digital multimeter

**ONLY  
\$195**

Performance, quality, reliability and price. The new Weston Model 6000 is a total value package and the best buy ever in a portable digital multimeter. Just check these performance and convenience features:

### Autoranging—plus factor in a portable

The simplicity, speed and accuracy of automatic ranging is a big advantage in a low cost portable digital multimeter. And in the Model 6000, it's available for the five standard measurement functions . . . AC/DC Volts, AC/DC Amps, Resistance. . . in 26 broad ranges. . . with full overload protection. Zero adjustment for all ranges is built-in . . . automatically.

A bonus feature is a 10 Amp AC/DC current range . . . not usually available in digital instruments. And a special "Hold" input jack provides a convenient memory retention capability for remote measurements.

### Superior performance in a portable

Even in a low priced portable, Weston quality proves itself. The high performance capability of the Model 6000 is typified by an accuracy of 0.35%, with resolution of 100  $\mu$ v, 1  $\mu$ a and 0.1 ohm.

### Large, easy-to-read-anywhere display

Even in bright sunlight, it's easy to read the large 0.5" high LCD 3½ digit display. Alternate

blinking of the LCD's provides an over-range indication that prevents erroneous readings. And minus polarity is measured and displayed automatically without reversing leads.

### Low power operation

Power source for the Model 6000 is two inexpensive, easily available 9V transistor batteries. Long battery life is assured by special circuits designed by Weston for low power drain. And when the batteries do run low, the LCD display blinks to tell you.

### Small and lightweight . . . but rugged

The Model 6000 portable is small in size and weighs less than two pounds. The rugged glass-filled Lexan® case can withstand tough treatment. A combination carry handle/display cover/tilt stand makes it convenient and practical for field or bench use.

® Trademark, General Electric Co.

### Weston service back-up

The Model 6000 is backed-up with the Weston total service commitment. Complete full year warranty, with service available at any of Weston's domestic or foreign service centers. Another plus factor for a low priced portable DMM.

The new Weston Model 6000 Autoranging Portable DMM doesn't scrimp on performance, quality or reliability . . . it just brings them to you at a better price.

MODEL 6000  
A field type multimeter with  
bench instrument performance



See the Model 6000 at any Weston Distributor. Or, write direct to Weston for additional information.

Weston Instruments, Inc., 614 Frelinghuysen Ave., Newark, N.J. 07114

Canada: 1480 Dundas Highway, Mississauga, Ontario  
Europe: Ingolstadter Str. 67a 8 Munchen 46, W. Germany

**WESTON**®  
WESTON  
Schlumberger

### Tool organizer holds many tools

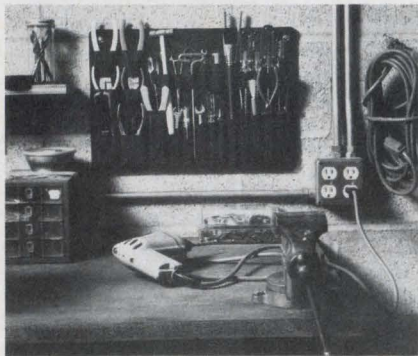

Platt Luggage Inc., 2301 S. Prairie Ave., Chicago, IL 60616. (312) 225-6670. \$12.75 (1-5).

Platt pallet, molded of tough urethane, can hold a large selection of small tools. Put up over a work bench, it keeps tools out of the grit and grime of tool boxes. The organizer is molded in one piece; no stitches, seams, flaps or rivets form any of the pockets. It's unconditionally guaranteed for 5 yr.

CIRCLE NO. 327

### Power cables suppress rfi to 45 GHz

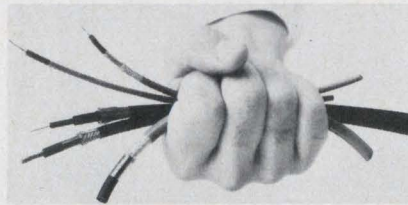

Capcon Inc., 147 W. 25th St., New York, NY 10001. (212) 243-6275.

Lossyline power conductors and cables provide rfi suppression of more than 100 dB. Unwanted noise to 45 GHz is absorbed and dissipated by a lossy medium that surrounds the central conductor. In microwave ovens, the cable has been used to counteract radiation leakage when carrying 50 A at 6000 to 50,000 working volts. Cables come with standard current ratings of 1 through 100 A and standard voltage ratings of 125, 250, 440 or 550 V ac or dc at frequencies of 25, 50, 60, 400 or 1000 Hz. Operating temperature ranges from -55 to 250 C. High-voltage ratings to 100,000 V are available for transmission cabling.

CIRCLE NO. 328

### Precision rf connector for low loss and VSWR

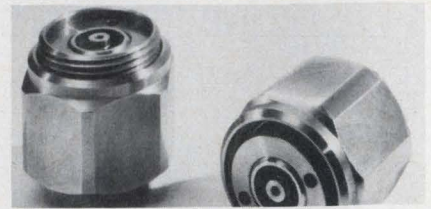

Weinschel Engineering, 1 Weinschel Rd., Gaithersburg, MD 20760. (301) 948-3434. \$75 (unit qty); stock to 60 days.

The Model 1565 precision 7-mm rf connector for use to 18 GHz is specially designed for applications where insertion-loss and VSWR-repeatability are of primary importance. It meets all requirements of IEEE STD 287, Design 2, and will mate nondestructively with other 7-mm connectors that conform to the interface dimensions of the standard. The unit features front-end replaceable mating contacts; life under normal use is 5000 matings. Replacement contacts, relatively inexpensive compared with the price of a connector, greatly extend connector life.

CIRCLE NO. 329

# World's first 4-channel compact...



Dimensions (h x w x d) 154 x 316 x 410 mm. Weight just 9.6 kg.

## Blank socket panels accept $\mu$ Ps

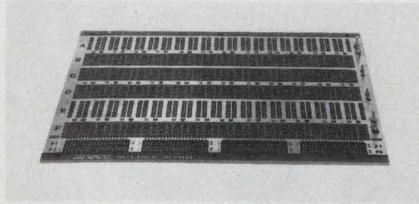

Data Numerics Inc., 141-A Central Ave., Farmingdale, NY 11735. (516) 293-6600. See text.

Three new blank socket panels accept microprocessors and DIP components. Model DL-8-90, an 8 x 8-1/2-in. board with three 40-pin input/output connectors, costs \$45; Model DL-8-120, 8 x 11 in. with four 40-pin connectors, costs \$60; and Model DL-8-180, 8 x 16 in. with six 40-pin connectors, costs \$77. All three models are available with double the number of I/O connectors at extra cost. The boards accept any 14-to-40-pin configuration, and because of modular design, can be updated for newer, higher-density elements. Data Numerics will mount any socket configuration at extra cost.

CIRCLE NO. 330

## Wide selection given in repair systems

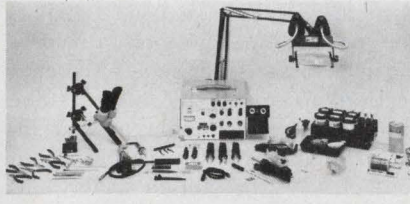

Pace Inc., 9329 Fraser St., Silver Spring, MD 20910. (301) 587-1696. See text.

A complete line of systems for the repair, rework, maintenance and salvage of electronic assemblies offers a wide choice of functional capabilities. Pace systems allow the repair of damaged or missing runs, terminals, plated-through holes, replating of damaged or worn connectors, miniature machining to repair or modify circuits, high-strength reflow soldering, accurate component forming or the removal of conforma coatings and any component. The systems range from a basic Ped-a-Vac desoldering system at \$195, to a completely equipped repair/manufacturing center for \$5300.

Booth No. 1112-14 Circle No. 331

## Thick-film printer handles big substrates

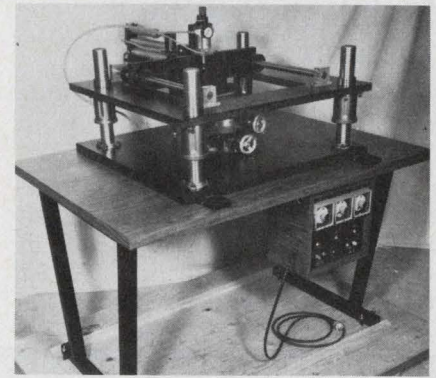

Aremco Products, Inc., P.O. Box 429, Ossining, NY 10562. (914) 762-0685. \$7990; 4 wks.

A special wide-area screen printer can print on 10 x 10-in. substrates. The printer uses a four-post die-set design and is mounted on a Formica-top console. Substrates of green-ceramic tape or glass for display work can be screened with this equipment. The registration between substrates and screen is guaranteed at 0.0003 in. The machine can operate up to 1200 cycles/h.

CIRCLE NO. 332

# ...with amazing triggering facilities

There's never been a spec. like this before.

- four 50 MHz channels plus
- two differentials (simultaneous display if needed) plus
- fully independent triggering of main and delayed time bases meaning
- main time base triggering on any of the four channels + composite + external + line and
- delayed triggering on any four channels plus composite.
- Moreover it all comes in a compact 9,6 kg construction.

So now you can display just about anything, for example a magnified view of any delayed section of a signal even when it is not directly related to the main time reference!

### Easier to use too

One look at the PM 3244's front panel tells you everything. Controls are logically grouped and positioned to fall naturally to hand. So you study the screen and not the 'scope.

One look inside will tell you how it's done - with a Philips technique

called cold switching. This means that the actual switching is performed on the boards with simple DC signals from the controls. The removal of mechanical connections eliminates layout and electrical design restraints, which in turn allows the PC boards to be designed for optimum layouts at all frequencies and for all facilities. Reliability is therefore greater, both mechanically and electrically, and servicing is made easier.

Another Philips development gives you remarkable low 29 W consumption which eliminates the need for ventilation fans and holes. It also boosts reliability and allows the PM 3244 to work from a battery pack as well as just about any voltage/frequency combination. So the world's first 4-channel compact lives up to its name. Going anywhere that 4 channels are needed. Which in today's digital world means just about everywhere.

Find out more by contacting Philips or utilize our toll free HOT LINE number 800 645-3043. New York State residents call (516) 921-8880 collect.

**Philips Test & Measuring Instruments, Inc.**  
A NORTH AMERICAN PHILIPS COMPANY

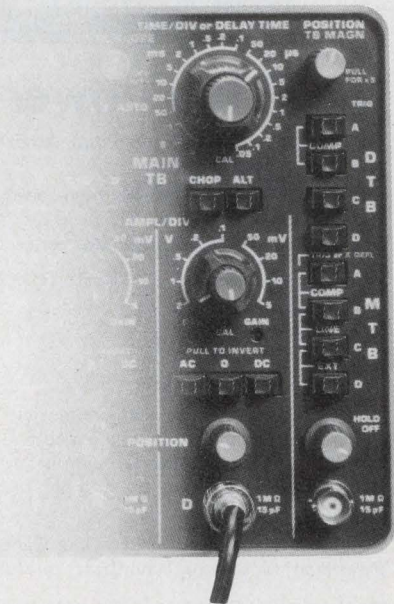

In the United States:  
400 Crossways Park Drive  
Woodbury, New York 11797  
(516) 921-8880

In Canada:  
6 Leswyn Road  
Toronto, Ontario Canada M6A1K2  
(416) 789-7188



# PHILIPS

CIRCLE NUMBER 69

## Stainless-steel tools vacuum solder

Consell, 463 Payne Dr., Cheshire, CT 06410. (203) 272-6837. Mini-Mini: \$9 (unit qty); stock.

A series of three tools will remove solder from printed-circuit boards by vacuum action. One of these, the Mini-Mini, is suited for the finest PC-board repair and re-

work. The 6.25-in. tool is constructed of stainless steel except for the Teflon tip. The other tools, the Mini and Maxi, are used for bigger jobs. To use the tools, a soldering iron first is applied to the connection to melt the solder. The plunger on the tool is pushed in, and the suction tip is placed in contact with the molten solder puddle. The trigger button is depressed, creating a high vacuum, which then sucks up the solder.

CIRCLE NO. 333

## Offset marker machine imprints products

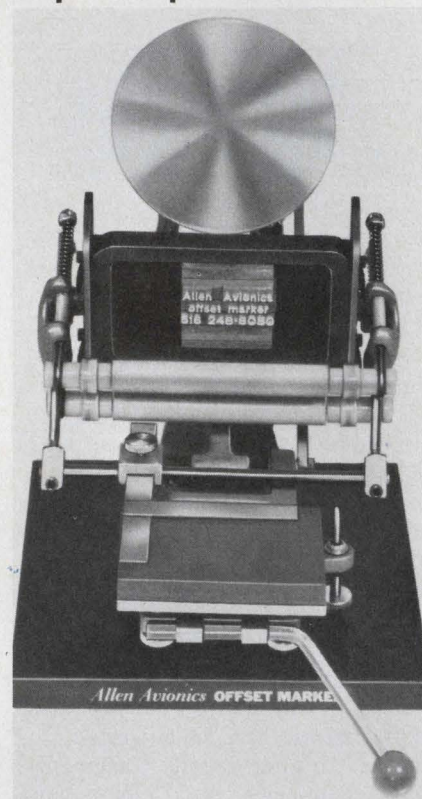

Allen Avionics Inc., 224 E. 2nd St., Mineola, NY 11501. (516) 248-8080. \$275: manual model; 6 wks.

A complete line of offset marking machines including manual and air-operated models provides permanent product identification. An important feature is the ability to change copy quickly. Any novice can learn its operation quickly. The manual model weighs only 13 lb. Air-operated units come with hand or foot controls and automatic cycling.

Booth No. 1527 Circle No. 334

## 100x Speed Improvement FROM YOUR MINI . . . or more!

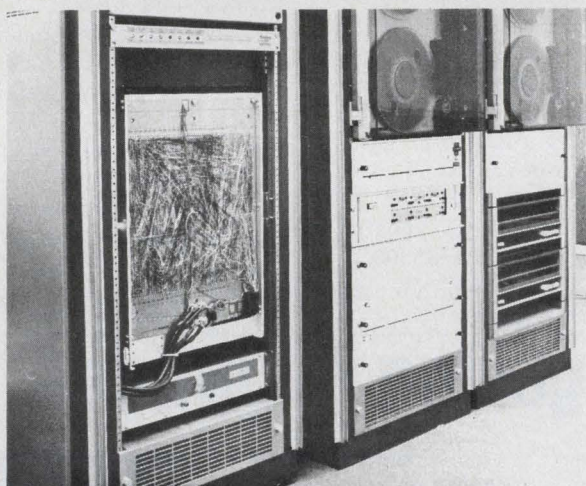

## Need The Power of a 7600?

Add our AP-120B Floating-Point Array Processor to your system — and leave the software and formatting to us.

The AP-120B is an extremely high-speed peripheral processor. It produces a 38-bit floating-point addition AND a 38-bit floating-point multiplication every 167ns! That's 12,000,000 multiply/adds per second!

### MORE SOPHISTICATED OPERATION?

Vector Multiply	.75 usec per data point
Vector Divide	1.67 usec per data point
Vector Square Root	1.83 usec per data point
1024 real FFT	2.50 msec

The AP-120B comes with extensive software: Cross Assembler, Executive, Simulator, Diagnostics, an algorithm Library of over 80 routines and is easily programmable for custom operations.

PRICES START FROM \$39,050 INCLUDING HOST SOFTWARE AND INTERFACE.

Interfaces available for DEC, Data General, Texas Instruments, Hewlett-Packard, Raytheon, Modcomp, Data Craft, Interdata, SEL, Varian and others.

### Delivery is 60 days

- Installations world wide.
- We service what we make.

For information  
CALL TOLL FREE

**800-547-1885**

SEE US AT NCC BOOTH #2629 AND  
E.A.E.G., THE HAGUE, BOOTH #43

**floating  
point  
systems**  
incorporated

10520 SW Cascade Blvd., Portland, Oregon 97223  
Phone: (503) 620-1980 TELEX: 360470 FLOATPOINT PTL

CIRCLE NUMBER 70

## Temp test chamber spans—100 to 350 F

Thermotron Corp., Kollen Park Dr., Holland, MI 49423. (616) 392-1492. From \$1645; stock.

The Mini-Max series of temperature test chambers is available with capacities from 1.2 ft<sup>3</sup> to 32 ft<sup>3</sup>. The chambers operate over a temperature range of -100 to +350 F (-7 to 177 C). The controller sensitivity is ±0.25 F. Chambers are available in 220 V, 60 Hz single phase and in 220 V, 60 Hz, 3-phase models.

CIRCLE NO. 335



# NEW Simpson® 360 SERIES 2 DIGITAL VOM



**GREAT  
NEW FEATURES  
NEW LOW PRICE \$257.**

Simpson 360 Series 2 Digital Volt-Ohm Milliammeter is a compact 3½ digit instrument for field and bench use in electronic and electrical maintenance, production, and laboratory. It offers high performance and value never before possible in a medium-priced digital VOM.

- Large bright 0.43" 3½ digit non-blinking auto-polarity LED display.
- Exclusive MOS-LSI circuitry, specially designed for Simpson gives high stability and reliability, immunity to noise, low power drain and permits compact design at low cost.
- Calibrated zero-center analog display gives quick indications for nulling, peaking, scanning trends.
- 29 most needed ranges including 2 "Low-power" ohms ranges.
- High accuracy.  $\pm(0.25\%$  of reading + 1 digit) on DC voltage ranges. Resolves 100  $\mu$ V, 10 nA (DC), 100 nA (AC), and 0.1 $\Omega$ .

**360-2 Digital VOM** supplied with test leads, AC charger/adaptor and instruction manual (less batteries).

**\$257.00**

**Accessories available.**

ORDER FROM YOUR ELECTRONICS / ELECTRICAL DISTRIBUTOR OR WRITE FOR BULLETIN T832



**SIMPSON ELECTRIC COMPANY**  
853 Dundee Ave., Elgin, Ill. 60120 • (312) 697-2260  
TELEX: 72-2416 • CABLE: SIMELCO

IN CANADA: Bach-Simpson, Ltd., London, Ontario  
IN ENGLAND: Bach-Simpson (U.K.) Ltd., Wadebridge, Cornwall  
IN INDIA: Rottonsha-Simpson Private, Ltd., Vikhroli, Bombay



# Stay current with small lamp data from General Electric. It's free.

Check these 6 halogen cycle lamps  
GE has added to its low-voltage line.

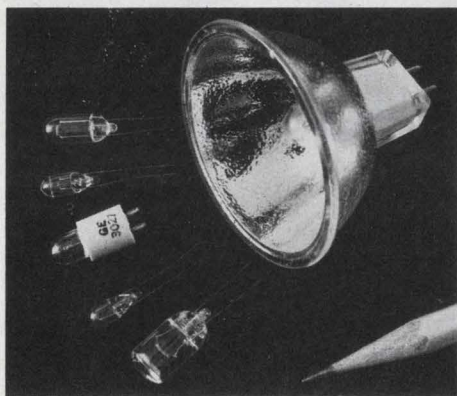

General Electric now offers over 27 halogen cycle lamps that pack high light output in small packages. (In addition, GE offers 8 sealed beam halogen lamps primarily for aircraft applications.) Bulb diameters range from  $\frac{3}{8}$ " to  $\frac{1}{2}$ ". Lengths from .520" to 2.25". Voltages from 3.5 to 28. O.V. And candlepower from 2.15 cd up to 250 cd.

They're ideal for you if you're designing applications such as optical systems, instrumentation, illuminators, fiber optics, card readers, displays and aircraft navigation. A variety of terminals are offered.

For updated technical information circle the number below or write GE for Bulletin #3-5357.

## These GE wedge base miniature lamps offer you savings in time, money and space.

These lamps are ideal for applications such as indicators, markers and general illumination where space is at a premium. Their wedge-based construction makes them easy to insert and remove. They don't require bulky, complicated sockets. And because the filament is always positioned the same in relation to the base, you get consistent illumination from lamp to lamp.

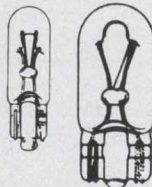

You can choose from over 25 types of GE wedge base lamps. Voltages range from 6.3 V to 28 V. Candlepower from 0.03 to 12 cd. Bulb sizes range from subminiature at 6mm to a heavy-duty bulb at 15mm.

To send for updated wedge base lamp technical information, circle number below or write GE for Bulletin #3-5259.

## These three free GE catalogs include important data changes that could affect your present design. Send for yours today.

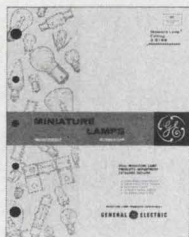

#3-5169

June '75 Miniature lamp catalog features 40 pages and 500 data changes for complete 500-lamp line.



#3-6252R1

Feb. '75 Sub-miniature lamp catalog features 24 pages and 91 changes for more than 210 lamps.

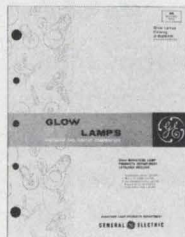

#3-6254R

Dec. '74 Glow Lamp catalog features 8 pages and 50 changes for 83 Glow Lamp Indicator and Circuit Component lamps.

For up-to-date technical information on any of these items write: General Electric Company, Miniature Lamp Products Department #3382-L, Nela Park, Cleveland, Ohio 44112.

GENERAL  ELECTRIC

CIRCLE NUMBER 72

## MICROWAVES & LASERS

### 32-way divider/combiner covers 3.4-4.2 GHz

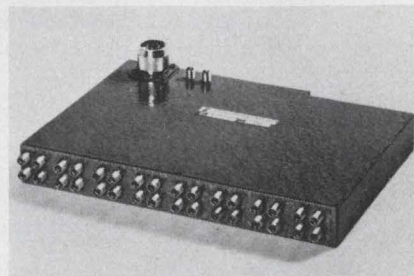

Sage Laboratories, 3 Huron Dr., Natick, MA 01760. (617) 653-0844. \$1500; 60 days.

The FP279 series of 32-way power divider/combiners is exemplified by a 3.4-to-4.2-GHz model that specifies a return loss of 19 dB minimum and insertion loss of 17.5 dB maximum. Output balance is  $\pm 0.5$  dB. Isolation between outputs is 18 dB minimum. The unit employs a type N input connector and type SMA connectors for all output ports. The Model FP279 measures  $8 \times 5.5 \times 1$  in.

Booth No. 1732-1734

Circle No. 336

### Synthesized sig gen spans 2 to 18 GHz

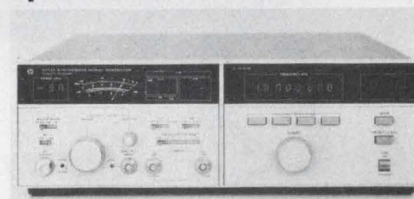

Hewlett-Packard, 1501 Page Mill Rd., Palo Alto, CA 94304. (415) 493-1501. \$26,000; June.

A synthesized microwave signal generator, the Model 8672A, covers the 2-to-18-GHz frequency range in one solid-state package measuring only 5-1/4-in. high. The new unit offers AM/FM and calibrated output. It has a frequency resolution of 1 to 3 kHz over the frequency range. Frequency stability is better than  $\pm 5$  in  $10^{10}$  parts per day with the internal frequency standard. Spurious signals are more than 70 dB below the carrier at 6 GHz, more than 60 dB down at 18 GHz.

Booth No. 2201-2210

Circle No. 337

# Totally TTL-compatible shift registers.

To make sure we're speaking the same language, let's define total TTL compatibility:

1. You need only one power supply (+5V).
2. I/O logic and clock levels are directly TTL compatible (eliminates -12V supplies).
3. On-chip clock generators—TTL input.

## New MOS shift registers from Synertek:

Totally TTL-compatible N-channel ion implanted silicon gate static registers.									
Synertek Part No.	2533	2833	2833A	2833B	2833C	2534	2534A	2535	2535A
Description	1K x 1 1.5 MHz	1K x 1 2.0 MHz	1K x 1 3.0 MHz	1K x 1 4.0 MHz	1K x 1 5.0 MHz	512 x 2 1.5 MHz	512 x 2 3.0 MHz	480 x 2 1.5 MHz	480 x 2 3.0 MHz
Directly Replaces	SIG & AM 2533 NAT 5058	AM 2833 TI 3133	AM 2833 TI 3133	FSC 3355	Only from Synertek	SIG 2527	SIG 2527	SIG 2529	SIG 2529
Benefit	50% less power. Eliminates negative power supply.					Double density, lower cost.			

We want you to start looking to Synertek for a whole line of TTL-compatible—**totally compatible**—MOS parts. Looking for 2K dynamic shift registers, for instance? We've got 'em (sorry, but you will need one little resistor). 1K static RAMs? We've got 'em, to 150 ns! 4K and 16K ROMs? 8-bit microprocessors? They're all here and all totally TTL-compatible.

There are a lot of MOS houses. But the guys who are really making the technology **work for you** work here.

Get our new short form catalog from Jack Balletto at Synertek, 3050 Coronado Drive, Santa Clara, CA 95051. (408) 241-4300. TWX: 910-338-0135.

 **Totally  
TTL-compatible  
shift registers.  
Synertek**

# a little A-300 goes a long way.



In high frequency transmission. RF power generation for industrial and research processes. RFI/EMI and general laboratory applications, too.

The Model A-300 is a totally solid state power amplifier, covering the frequency range of 0.3 to 35MHz with a gain of 55dB. Capable of delivering 300 watts of linear Class A power and up to 500 watts in the CW and pulse mode, the A-300 is the ultimate in reliability.

Although the unit is perfectly matched to a 50 ohm load, it will deliver its full output power to any load (from an open to a short circuit) without oscillation or damage.

Complete with power supply, RF output meter and rack mount, the A-300 weighs a mere 89 pounds and operates from ordinary single phase power.

High power portability goes a long way for \$5350.

For further information or a demonstration, contact ENI, 3000 Winton Road South, Rochester, New York 14623. Call 716-473-6900 or TELEX 97-8283 ENIROC

**ENI**  
The World's Leader  
in Solid State  
Power Amplifiers

SEE  
Electronic Design's  
**GOLD BOOK**  
FOR COMPLETE  
PURCHASING  
INFORMATION

CIRCLE NUMBER 74

## MICROWAVES & LASERS

### 4-way divider/combiner accepts 100 mW/port

Sage Laboratories, 3 Huron Dr., Natick, MA 01760. (617) 653-0844. \$325; 60 days.

A four-way matched power divider/combiner, the FP1372, covers the 3.7-to-4.2-GHz frequency range with an insertion loss of less than 0.3 dB and VSWR of less than 1.2:1. Isolation between outputs is greater than 20 dB. In combiner applications, the input power rating is 100 mW per port.

Booth No. 1732-1734

Circle No. 338

### Small WG isolator covers 26 to 40 GHz

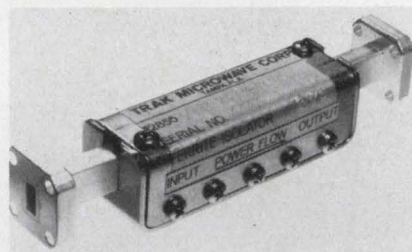

Trak Microwave, 4726 Eisenhower Blvd., Tampa, FL 33614. (813) 884-1411. \$425; 10 days.

A small, compact 26-to-40-GHz waveguide isolator, the Model 2571-1810, measures only 4-1/8 x 55/64 x 13/16 in. and weighs just 5.5 oz. Isolation is 23 dB minimum with an insertion loss of 1.2 dB maximum. Flanges are UG-599/U.

CIRCLE NO. 339

### 1-15-GHz detector avoids bias circuitry

Omni Spectra, 21 Continental Blvd., Merrimack, NH 03054. (603) 424-4111. \$175 (1-9); 90 days.

The Model 20751 Schottky detector doesn't require the power supply and associated circuitry usually needed to establish a bias level. The zero-bias 20751 detects cw or square wave, pulse or frequency-modulated signals over the range of 1 to 15 GHz. With some performance degradation, the unit can also be used up to 18 GHz. The detector measures 1.35 in. in length.

Booth No. 2813 Circle No. 340

## New ideas from a new source for flat cable and connectors

The source: Alpha Wire, one of the oldest full-line wire and cable manufacturers.

Our cable is compatible (matches all flat cable connectors designed for 0.050 in. conductor spacing). It has excellent teardown characteristics, is ultra-flexible, and UL listed. Exclusive footage indicator on the reel shows how much cable is left.

Our complete line of connectors (female sockets, headers, DIPs and PCBs) also offer some new ideas:

Microetched Offset Tines grip conductor securely and prevent conductor damage. (Burs and sharp edges removed.)

Eliminates Waste assembler can correct mistakes if he makes a bad crimp.

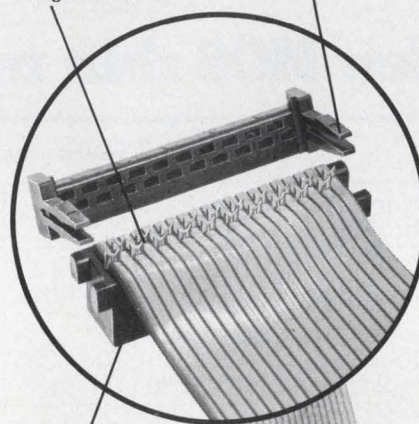

Positive Contact self-cleaning dual cantilever contacts provide 2 wiping surfaces for reliable, repeatable terminations.

Universal Bench Press crimps all connectors. Eliminates need for separate adapters.

Allows Denser Wiring unique design allows cable to remain within profile of the connector.

**alpha**

Alpha Wire Corp.  
711 Lidgerwood Ave.,  
Elizabeth, N.J. 07207  
(201) 925-8000

CIRCLE NUMBER 75

## 4-8 GHz FET amp has 6-dB NF

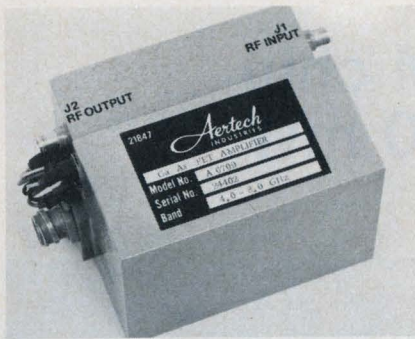

Aertech Industries, 825 Steward Dr., Sunnyvale, CA 94086. (408) 732-0880. Under \$4000; 69 to 75 days.

A 4-to-8-GHz GaAs FET thin-film amplifier, the Model A6709, offers 28-dB gain, 6-dB noise figure and +10-dBm power output. A 19-dB-gain version is available in the Model A6713. Both models have either a low dc voltage bias or an optional 115-V-ac power supply.

CIRCLE NO. 341

## Low-loss couplers have directivities to 30 dB

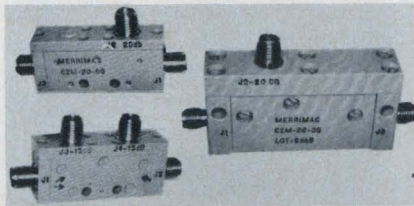

Merrimac Industries, 41 Fairfield Pl., West Caldwell, NJ 07006. (201) 228-3890. \$120 to \$140; 30 days.

A family of stripline directional couplers, the C2M-G and C2-G Series, combines high directivity with low loss. The C2M-G Series includes more than 20 standard models covering bands in the 1-to-18-GHz frequency range, and the C2-G Series includes more than eight standard models covering bands in the 500-MHz-to-12.4-GHz range. Models in both series are available with 6, 10, 20, and 30-dB coupling values. A typical model, the C2M-20-1.5G, has the following specs: frequency range of 1 to 2 GHz, nominal coupling of  $20 \pm 1$  dB, frequency deviation of  $\pm 0.75$  dB, maximum VSWR of 1.20:1, insertion loss of 0.25 dB (over coupling loss), forward power of 50 W and reverse power of 20 W.

CIRCLE NO. 342

## Radiation meter covers 0.3-to-18-GHz range

General Microwave, 155 Marine St., Farmingdale, NY 11735. (516) 694-3600. \$750.

A precision battery-operated power-density meter—the Model 3—responds uniformly to potentially hazardous nonionizing energy radiating or leaking from rf and microwave sources from any direc-

tion over the frequency range of 0.3 to 18.0 GHz. The meter has three 10-dB power ranges with full scale readings of 2, 20, and 200 mW/cm<sup>2</sup>; isotropy of  $\pm 0.05$  dB; calibration accuracy of  $\pm 0.5$  dB; and a recorder output jack. The sensing probe can be mounted directly on the meter, or through an extension cable that allows remote operation.

CIRCLE NO. 343

# The inside story of the amazing new \$31 Compact 1.

Take a close look.

Beneath the handsome exterior of Zero's new VIP Compact 1 you'll find a feature you've never found on a \$31\* instrument enclosure before. Those rugged steel and aluminum panels are hiding a removable chassis. Which means you can now easily build up your equipment on the free chassis, and then simply re-assemble the enclosure around it.

A result of thorough design, Compact 1 delivers an amazing new level of quality, strength, efficiency and economy. If these are your requirements for a small instrument enclosure, you've found what you've been looking for. We're ready to ship any of the twelve standard sizes to you within two weeks.

Write for your free catalog today.

\*From \$30.80 to \$38.65 in quantities of 50.



The Final Touch

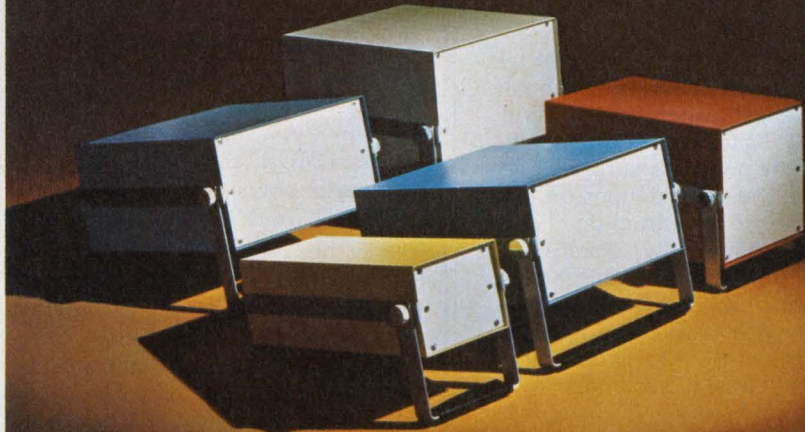

ZERO MANUFACTURING CO.  
Burbank, CA 213/846-4191 · Monson, MA 413/267-5561 · Clearwater, FL 813/531-8991

CALL ME, I'M INTERESTED CIRCLE #76

FOR MAIL CATALOG CIRCLE #77

**Grayhill  
brings all  
PC terminals  
out  
one side**

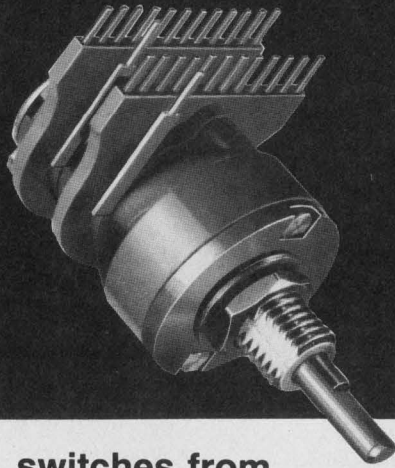

**switches from  
logic levels up to  
1/4 amp**

- 1/2 inch switches with 10 or 12 positions—1 or 2 poles per deck—1 to 12 decks.
- Designed for wave-soldering process—resists flux contamination
- Enclosed construction at price levels as low as or lower than open wafer switches.

Here's a new Grayhill miniature switch specifically designed for the small loads—and the specialized mounting techniques—of low voltage circuitry. Probably the smallest switch you can find with all PC terminals in the same plane, the switch is surprisingly small in the price dimension too... for enclosed construction and Grayhill quality. For more information on this new member of the Grayhill Series 71 family, write for Bulletin #236... and consult EEM for information on other Grayhill switches.



561 Hillgrove Avenue • LaGrange, Illinois 60525  
(312) 354-1040

CIRCLE NUMBER 78

INTEGRATED CIRCUITS

**Three-digit DVM chip  
requires only 30 mW**

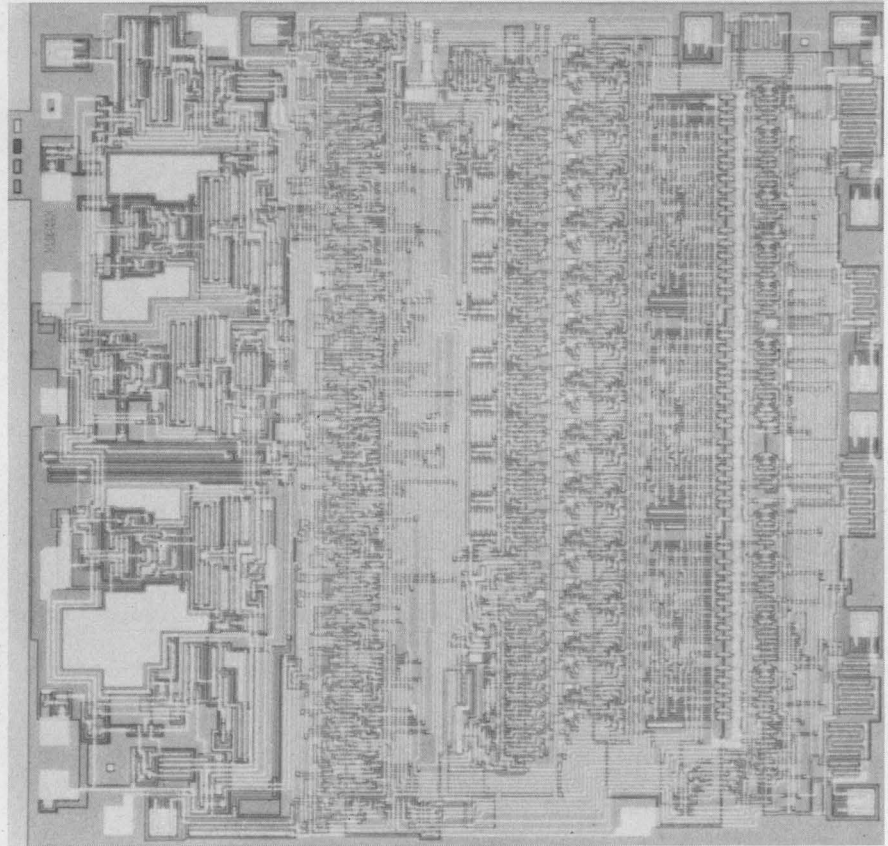

*Siliconix, 2201 Laurelwood Rd., Santa Clara, CA 95054. (408) 246-8000. P&A: See text.*

By combining low-power CMOS technology with proven quantized-charge feedback techniques, Siliconix has produced the LD130—the first monolithic DVM circuit in an 18-pin DIP. Analog as well as digital functions are included on a single CMOS chip that typically dissipates only 30 mW. When the LD130 is used with a display, decoder, power supply, reference source and several external capacitors it forms a complete 3-digit DVM.

The LD130 provides multiplexed BCD outputs that can drive one standard TTL load each. Overrange and underrange signals from the chip can assist in applications that require autoranging. As an additional feature, the display

blinks when the input is overrange.

A signal from the chip is also available to operate a polarity indicator in a display. Interdigit blanking has been incorporated on the chip to permit interfacing with gas-discharge type displays. Four npn transistors drive the three digits and sign, and a BCD-to-seven-segment or other type of decoder must be used to decode the BCD for display driving.

Four internally compensated CMOS op amps and a comparator are included in the LD130. The signal-conditioning part of the LD130 has a 1000-M $\Omega$  input impedance and typically a 4-pA input-bias current. The input range is  $\pm 999$  mV full scale and the unit is designed to operate from  $\pm 5$ -V power supplies.

The on-chip clock requires only one timing capacitor of about 2.5

nF to establish a sampling rate of 10 samples per second. Two other capacitors of about  $0.1 \mu\text{F}$  are required for integrating the measured voltage and storing error voltages. All three capacitors may be inexpensive disc ceramics.

The LD130 uses a single, positive 2-V ground-based reference, that could be generated by a current-limiting diode and a cermet potentiometer—or merely by the wiper of a potentiometer across a zener diode, since the input impedance at the reference terminal is  $1000 \text{ M}\Omega$ .

The DVM chip performs an auto-zero function prior to each measurement cycle. The BCD reading from the previous measurement cycle is transferred into latches for the output multiplexer at the start of each auto-zero cycle. The algorithm automatically deals with inputs of either polarity.

Price of the LD130 is \$12.50 in single units, and drops to \$8 in 1000-unit lots. Delivery is from stock.

CIRCLE NO. 301

## V/f/v converter works through 5 decades

*Intech, 1220 Coleman Ave., Santa Clara, CA 95050. (408) 244-0500. \$15 to \$20; stock.*

A monolithic voltage-to-frequency-to-voltage converter, the Model A-8400, provides a simple, virtually adjustment-free component for data encoding and decoding applications. Packaged in a special 14-pin DIP, the IC uses an improved charge-balancing technique that combines high linearity over five decades along with inherent monotonicity. As a v/f converter, the A-8400 has an input voltage (current) range of 0 to 10 V (0 to 1 mA). The proportional full-scale frequency output through the 100-kHz band is established with an external resistor and capacitor. In the f/v mode, the time constant of the output integrator can be externally varied. Conversion linearity is within  $\pm 0.05\%$  at 100-kHz full-scale and  $\pm 0.01\%$  at 10 kHz. Temperature stability is typically  $\pm 50 \text{ ppm}/^\circ\text{C}$  and power-supply range is  $\pm 12$  to  $\pm 17 \text{ V}$ .

CIRCLE NO. 344

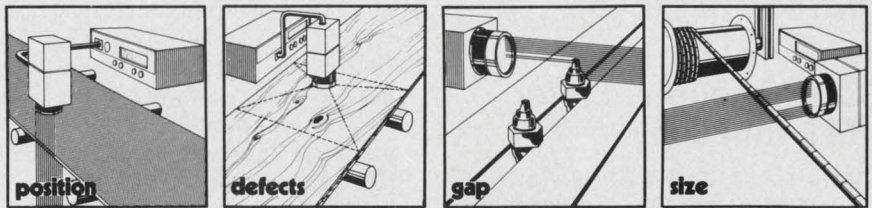

# SOLID STATE IMAGE SENSING.

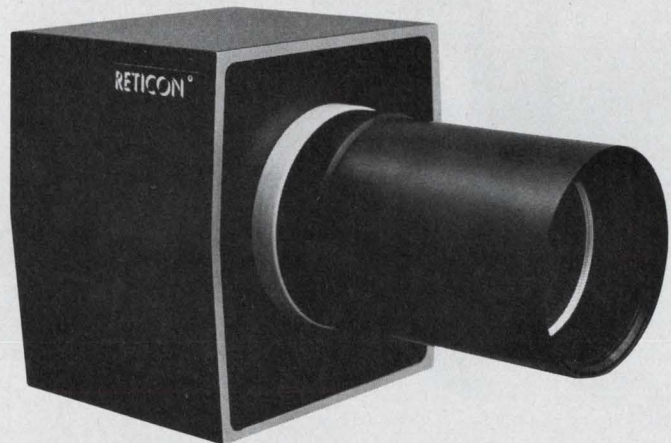

## UNDER \$700.

RETICON cameras can be found doing complex non-contact measurement and inspection jobs in practically every industry. They are used to measure hot-rolled steel, inspect glass bottles, size bolts and rivets, check packaged goods, monitor print quality and a lot more.

Our new LC64P camera makes this advanced technology now cost-effective in such simple applications as edge and width monitoring of sheets and mass produced parts.

This camera provides you with a variable-threshold, computer-compatible digital output as well as analog video with 200:1 dynamic range. It is housed in a rugged 3.5" x 3.75" x 3.5" sealed aluminum casting for reliable operation in extreme industrial environments. It requires less than 2 watts from a  $\pm 15\text{V}$  power supply and includes a choice of 5 different lenses. The camera is compatible with RETICON's RS600 series processors which provide automatic categorizing of parts, high/low limits, analog outputs for feedback in process control and direct measurement readout.

## RETICON®

910 Benicia Avenue  
Sunnyvale, California 94086  
(408) 738-4266 • TWX: 910-339-9343

## INTEGRATED CIRCUITS

### CMOS counters offer TTL functions

Motorola, 3501 Ed Bluestein Blvd., Austin, TX 78721. (512) 928-2600. \$1.35 to \$2.03 (100-999); stock.

Four CMOS circuits are synchronous programmable four-bit counters. The MC14160B and 162B are decade counters, offering asynchro-

nous or synchronous clear, respectively. The other two, the MC1416B and 163B, are four-bit hexadecimal units with the same respective options. The CMOS parts are functionally equivalent to the 74160 through 163 TTL counters and feature internal look-ahead and carry output. The counters operate from 3-to-18-V supplies and can drive a low-power Schottky-TTL load.

CIRCLE NO. 345

### Sonar system comes on a chip

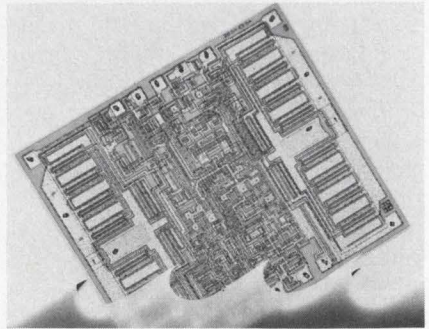

National Semiconductor, 2900 Semiconductor Dr., Santa Clara, CA 95051. (408) 732-5000. \$12 (100); stock.

A single IC, known as the LM-1812 transceiver, contains all the elements needed in a sonar system. The new circuit consists of a 12-W ultrasonic transmitter and a selective receiver that includes a 10-W display driver. Further the package requires no heat sink. Operating from a 12-V battery, the LM1812 transmits pulses of about 200 kHz for about 800  $\mu$ s through an external transducer. Between pulses, the receiver listens for an echo and drives a display with the resulting signal.

CIRCLE NO. 346

### THOUSANDS OF OPTION COMBINATIONS IN ACCURACY . . . GAIN . . . AND BANDWIDTH IN NEWPORT'S WIDEBAND DC DIFFERENTIAL AMPLIFIERS - FROM \$160

Newport amplifiers and transducer conditioners are valuable for any application where extremely precise low noise wideband signals exist. They are ideal for thermocouples, load cells, DC excited strain gages and other low level sources. Outputs are useful for DAS, recording galvanometers, oscillographs, recorders and digital voltmeters. Newport's companion 80A transducer conditioner features tri-current excitation which eliminates lead wire effects from single active arm measurements.

Characteristics	Model 50A	Model 55A	Model 60A	Model 70A
300V CMR		X		X
10V CMR	X		X	
Gains from 1 to 3300	X	X		
Gains from .01 to 5000			X	X
133 dB rejection at 60 Hz cm	X	X	X	X
0.4 $\mu$ V/ $^{\circ}$ C input drift	X	X	X	X
50 megohm input impedance	X	X	X	X
0.005% non-linearity	X	X	X	X
4 pole (24 dB/octave) fixed active filter	X	X		
6 pole (36 dB/octave) switchable active filter			X	X
Continuous plus commutated output	X	X		
Dual continuous plus commutated output			X	X

Newport Laboratories, Inc.  
630 E. Young St.  
Santa Ana, CA 92705  
Call Collect: (714) 540-4686  
In Netherlands, Call:  
Amsterdam (20) 45-20-52

# NEWPORT

"See us at Electro '76 Booth #2211"

CIRCLE NUMBER 80

### Chopper-stabilized amp has 0.1 $\mu$ V/ $^{\circ}$ C drift

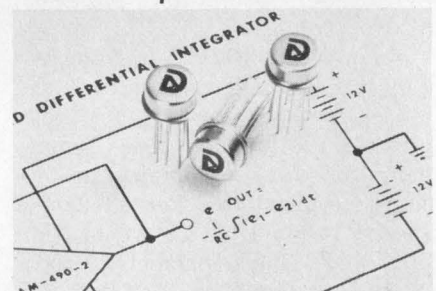

Datel Systems, 1020 Turnpike St., Canton, MA 02021. (617) 828-8000. \$39 to \$49 (1-9); stock.

Monolithic chopper-stabilized amplifiers offer inverting, noninverting and differential modes of operation. The Model AM-490-2 series has input offset errors as low as 0.1  $\mu$ V/ $^{\circ}$ C and 1 pA/ $^{\circ}$ C and comes in a hermetically sealed, 8-pin TO-99 package. Dc common-mode rejection is 160 dB, and supplies can range from  $\pm$ 12 to  $\pm$ 20 V dc. Maximum quiescent current is 5 mA. Warmup time to rated accuracy is only 200 ms.

CIRCLE NO. 347



## Speed custom designs with CMOS masterslice

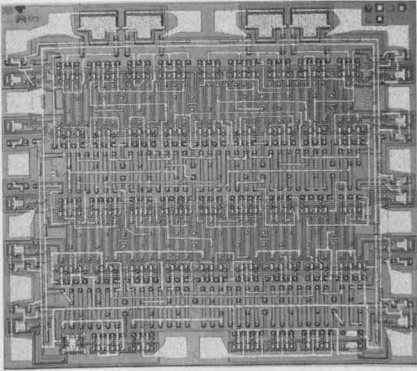

International Microcircuits, Inc., 3000 Lawrence Expressway, Santa Clara, CA 95051. (408) 735-9370.

The latest entry in a family of masterslice custom CMOS chips—the MasterMOS-S—contains the following: 106 complementary pairs of MOS transistors, along with 10 output-buffer circuits, four high-current n-channel drivers, and 18 interface pads ready to be interconnected for each custom application. Like other members of the family, the MasterMOS-S chip can cut costs and reduce development time for custom circuits of moderate complexity. Typical development charges for a custom CMOS circuit using MasterMOS-S are less than \$3000, and typical production prices range from \$3.50 to \$2.40, depending on quantity.

CIRCLE NO. 348

## ICs interface logic with inductive loads

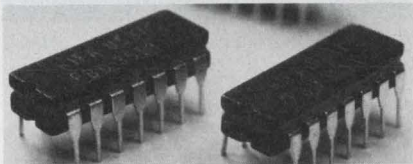

Rifa, Fack S-161 11 Bromma, Sweden. \$1.35 to \$1.80 (100).

Bipolar driver circuits allow interfacing between 5-V logic and inductive loads. The PBD 3513, a dual driver in a 14-pin ceramic package, has TTL-compatible inputs and can also be fed from relay contacts in 12-V systems. The circuit is designed for 5-to-12-V supplies and can sink 300 mA. The PBD 3520, in a metal TO-99 package, can handle voltages down to -56 V. The TTL-compatible circuit sinks 150 mA with a logic ZERO input.

CIRCLE NO. 349

Disc has made it easy for the OEM using optical encoders in small quantities to realize costs in the same low range as the big users—like under \$100.00.

We've maintained the same high order of resolution, accuracy, and reliability found in our more expensive units for this new EC series. "EC," obviously, is our economy model, but it could also stand for exceptional capabilities. Here's what you get for your \$99 (much less in quantity):

- LED source
- 20 to 1024 pulses/revolution
- Differential electronics
- Square wave output
- $\pm 2.5$  minutes accuracy
- Solar cell light sensors
- Instrument bearings
- $\frac{1}{4}$ " shaft for interfacing

Translated into benefits, these features mean the Disc EC ROTASWITCH® Encoder gives you superior performance, a long service life, and a unit cost you just can't touch.

That's the model EC 81. It has a single channel output. If you need dual channel, we also offer the EC 82 at \$125.00 in single quantities. It too plummets to well under \$100.00 in quantity.

A new spec sheet is just off the press—write or call for your copy. Immediate questions can be answered by calling 714/979-5300.

Disc Instruments, Inc., 102 East Baker Street, Costa Mesa, CA 92626.



# THE PRICE OF OPTICAL ENCODERS JUST PLUMMETED.



CIRCLE NUMBER 81

# 1 Relay Miss every 2-Billion Cycles

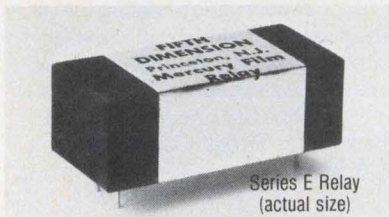

Series E Relay  
(actual size)

**We tested 129 of our new Series E Relays at loads from dry circuits to 3 Amps. After 35-billion operations, only 10 single-cycle misses were monitored.**

#### Series E Relays offer:

- Indefinite life
- No contact bounce
- Operation in all positions
- Contacts stable to  $\pm 0.015$  ohms over life
- Reliability at dry circuit or power loads
- Self-healing contacts
- Hermetically sealed contacts
- 1250V rms contact breakdown
- Low cost



LC2 Switch Capsule  
(actual size)

Series E Relay uses a rugged LC2 welded capsule rather than a fragile glass reed switch. This patented design holds a film of mercury securely to the metal walls of the capsule. With every operation, the mercury film renews the switch contacts. You get the reliability of mercury relays, but with complete freedom of mounting orientation. LC2 welded capsule reliability is proven by hundreds-of-thousands of units in the field, as well as billions of cycles under stringent laboratory conditions.

Send for a FREE SAMPLE of the LC2 welded capsule on your letterhead. Circle the reader service card number for Series E Relay information.

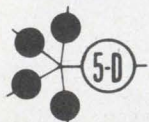

**Fifth Dimension, Inc.**

P.O. Box 483  
Princeton, N.J. 08540  
Tel: (609) 452-1200

CIRCLE NUMBER 82

## INTEGRATED CIRCUITS

### 1-k MOS RAMs can replace bipolar types

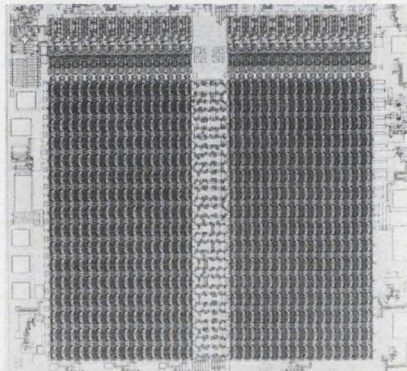

Intel, 3065 Bowers Ave., Santa Clara, CA 95050. (408) 246-7501. \$12.70 to \$18.30 (100-999).

The first MOS equivalents of 1024-bit bipolar RAMs are low-voltage, silicon-gate, n-channel units—the 2115 and 2125 family. The new static RAMs can operate as fast as their bipolar counterparts, at the same supply level of 5 V and same logic levels. However, the new memories reduce power dissipation by 35% or more. The 2115 and 2125 are pin-for-pin replacements of the 93415 and 93425 1024-bit bipolar RAMs, introduced by Fairchild and currently the most widely used bipolar RAMs. All are fully decoded, 16-pin designs. The 2115 and 93415 have an open-collector output, and the 2125 and 93425 have a three-state output. Two speed grades and a low-power version are available. The 2115-2 and 2125-2 have a maximum access time of 70 ns, the same as standard bipolar versions. The 2115 and 2125 have a maximum access of 95 ns. The 2115L and 2125L versions feature maximum current of 65 mA with an access time of 95 ns.

CIRCLE NO. 350

### 16-k ROM has 450-ns access

General Instrument, Microelectronics Group, 600 W. John St., Hicksville, NY 11802. (516) 733-3306. \$19.50 (1000); 8 wks.

A 16-k bit static ROM—a RO-3-8316B—operates from a single 5-V supply and features an access time of only 450 ns. The fully static device offers TTL compatibility and a 2-k  $\times$  8-bit organization.

CIRCLE NO. 351

### ICs select TV channels

Plessey Semiconductors, 1674 McGaw Ave., Santa Ana, CA 92705. (714) 540-9979. \$3.50 (100).

Two sensing ICs for TV-channel selection can be driven directly from two-terminal touch plates, eliminating the need for conventional pushbuttons. The ML231B and ML232B both offer six-channel selection, direct neon drive, low-impedance drive to the tuning Varicap, and they operate from a 33-V Varicap supply. The ML231B has an additional output that goes high with no channel selected, while the ML232B has an additional input for channel-by-channel step advance. Both circuits require a maximum input current of just 1 mA, a maximum supply current of 5.5 mA, and operate over the 0-to-65-C temperature range.

CIRCLE NO. 352

### 3-terminal regulator outputs 1.5 A at 37 V

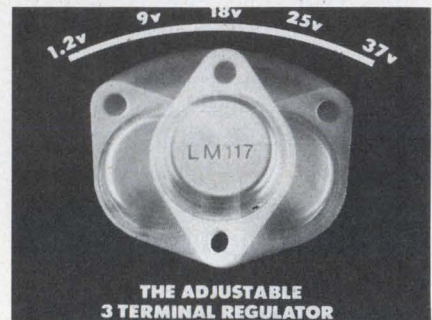

THE ADJUSTABLE  
3 TERMINAL REGULATOR

National Semiconductor, 2900 Semiconductor Dr., Santa Clara, CA 95051. (408) 732-5000. \$3.00 to \$11.00 (100).

An adjustable three-terminal IC regulator, the LM117, provides over 1.5 A of output current at any output voltage from 1.2 V to over 37 V. Packaged in standard transistor power packages, the LM117 has a line regulation of typically only 0.01%/V and load regulation of 0.1% for a 1.5-A change. Ripple rejection of 80 dB can be obtained at any output voltage. Also, full overload protection is included on the chip. Output current is limited to about 2.3 A. Thermal overload protection limits power dissipation should die temperature exceed 170 C.

CIRCLE NO. 353

# New Low Price

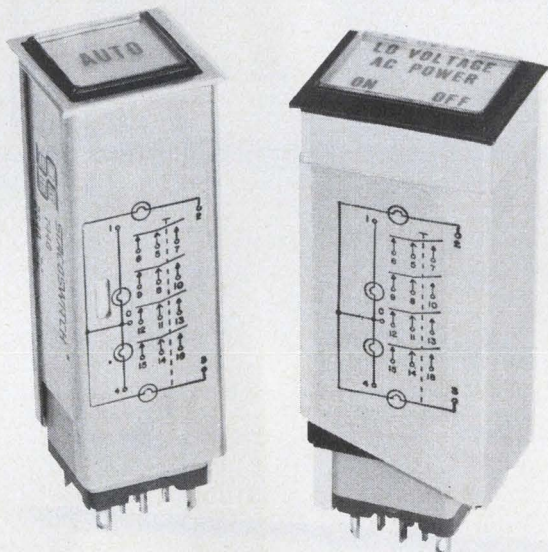

Dependable, proven, Series 2S/2R 4-lamp illuminated pushbutton switches and indicators. The price? \$8.95 for 2PDT and \$9.90 for 4PDT in 1-9 quantities. In larger quantities the price is even lower. Price includes switch and pushbutton with choice of 84 standard display options. At this price you just can't get a better deal on a dependable 4-lamp switch.

Premium grade materials used throughout. Original military design built to industrial/commercial requirements. This rugged switch is inexpensive, but it certainly is not cheap. It will give you long trouble-free service life... 50,000 plus cycle life.

The Series 2S/2R offers wide flexibility with switching capability from 10 micro-amps to 5 amps. Choice of momentary or alternate switch action. Matching 4-lamp indicator at equally low price. Designed for easy installation with relamping from front of panel without use of tools. Write today for General Catalog giving complete description and specifications. When you think switch... think Stacoswitch.



1139 BAKER STREET, COSTA MESA, CALIF. 92626  
(714) 549-3041 TWX: 910/595-1507

Other STACO Company products: Custom Transformers, STACO, INCORPORATED, Richmond, Indiana; Variable Transformers, STACO, INCORPORATED, Dayton, Ohio.

CIRCLE NUMBER 83

ELECTRONIC DESIGN 10, May 10, 1976

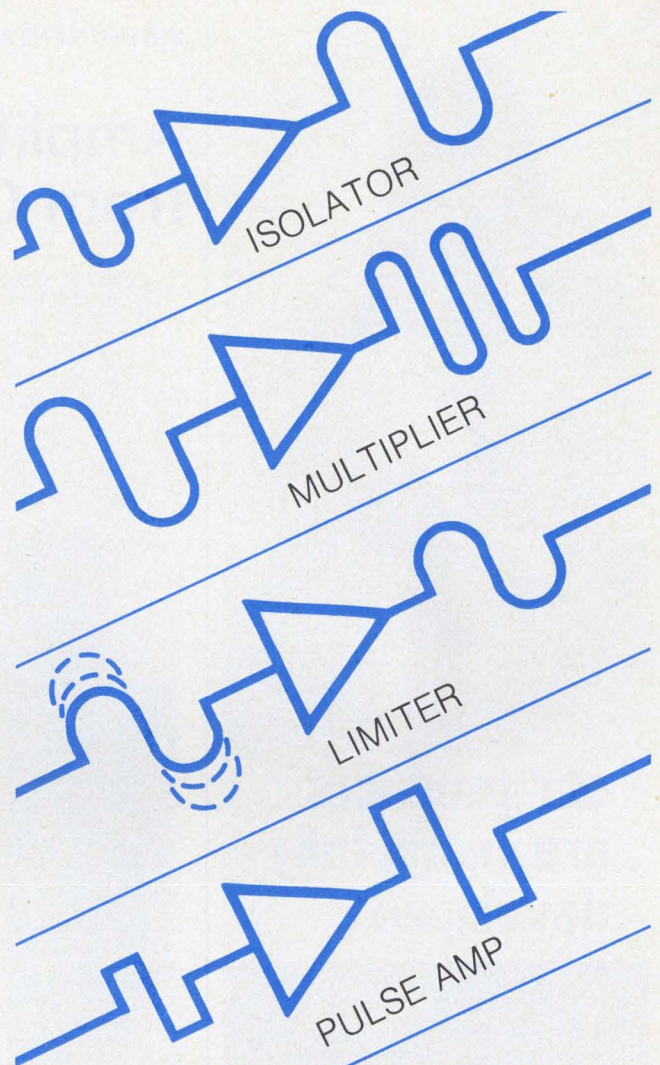

## FROM A SINGLE LOW COST\* AMPLIFIER

Model	Frequency Response (MHz)	Gain (dB)	Flatness (dB)	Noise Figure (dB)	VSWR	Input Power
	Min.	Min.	Typ.	Typ.	In & Out	VDC Current mA
GPD-401	5-400	13	±1.0	4.5	2.0	15 10
GPD-402	5-400	13	±1.0	6.0	2.0	15 24
GPD-403	5-400	9	±1.0	7.5	2.0	24 65

Weight, 1.0 Gram

\* PRICED AS LOW AS \$18  
DELIVERY FROM STOCK



**Avantek**

write or call for applications literature and data sheets  
3175 Bowers Avenue, Santa Clara CA 95051 (408) 249-0700

\*In quantities of 50-99 or as low as \$27 in quantities of 1-9.

CIRCLE NUMBER 84



**our products  
are more fully  
developed...**

Standard Condenser capacitors are indeed fully developed to produce the optimum in performance and durability. Standard is in one business only, the design and manufacture of the world's finest capacitors. We have designed and delivered thousands of specialized capacitors for industry. In fact, what you think of as "special" may be among the many designs already available from stock at Standard. However, if you require capacitors of unusual shape, size, value and material, our engineering department will help you design and produce them to your exact specifications at stock prices. For immediate action, send us a sketch and complete details.

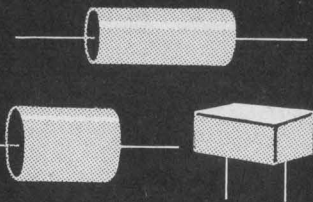

Write or phone for catalog and details.

**Standard**

**CONDENSER CORPORATION**

Dept. ED-5 1065 West Addison Street  
Chicago, Illinois 60613 • (312) 327-5440

CIRCLE NUMBER 85

**INSTRUMENTATION**

# Amplifiers deliver flat output from 0.15 to 300 MHz



*Electronic Navigation Industries, 3000 Winton Rd. S, Rochester, NY 14623. (716) 473-6900. See text.*

One amplifier that takes the place of several: That's the benefit you get with ENI's new family of wideband Class A power amplifiers, the 400A series.

The series' flat gain characteristic of  $\pm 1.5$  dB, or better, over the wide bandwidth of 150 kHz to 300 MHz—coupled with a choice of three power levels (3, 10 and 40 W)—encompasses an extensive range of applications. Thus you can avoid annoying bandswitching over several units, and you can probably save money as well.

Four models comprise the series at present, two with 3-W outputs (403LA, 400AP), one with 10 W (411LA), and the last with 40 W (440LA). Two or four units of any model can be combined to provide even higher power without affecting the other specs.

What do you trade off to get

the wide band and other features? Not much. The ENI amplifier series delivers linear power to any load from an open to a short, and it's unconditionally stable. No matter what the mismatch, the 400A won't oscillate or burn out.

Harmonic distortion of all models is better than 25 dB down (at outputs slightly below rated power—check the spec sheets), and even better at reduced power. Noise figure is 9 or 10 dB, depending on the model.

Nominal gain of the 3-W models is 37 dB; those of the 10 and 40-W units are 40 and 45 dB, respectively. Input/output impedance of all models is 50  $\Omega$ ; input VSWR is 1.4 or 1.6 max, depending on the model; output VSWR stays below 2.3.

Prices of the 403LA, 411LA and 440LA are \$795, \$1725 and \$3990, respectively. The 400AP costs \$575. Delivery time is 30 days.

CIRCLE NO. 302

# New Hi-Temp Thermostat

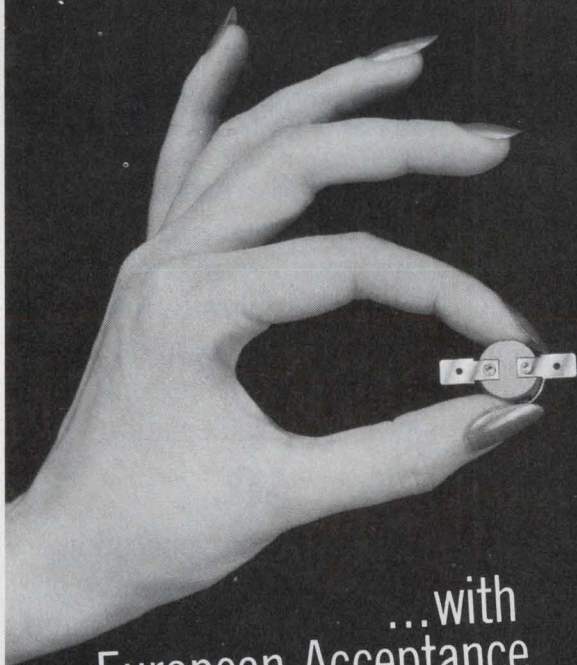

...with  
European Acceptance

Ideal for a variety of high temperature applications! Elmwood's new snap-action RC thermostats include a glass-bonded mica (ceramo-plastic) base that allows set points to 550°F (290°C). The patented metal sleeve insert and rivet construction permit listings by European agencies as well as U.L. and C.S.A. The RC's are SPST, pre-set, tamperproof, and available with mountings, terminals and brackets to suit. Want more? Call or write Elmwood Sensors, Inc., 1659 Elmwood Ave., Cranston, R. I. 02907. Phone 401/781-6500. European Div., Elmwood Sensors Ltd., North Shields, England.

## ELMWOOD SENSORS

CIRCLE NUMBER 145

ELECTRONIC DESIGN 10, May 10, 1976

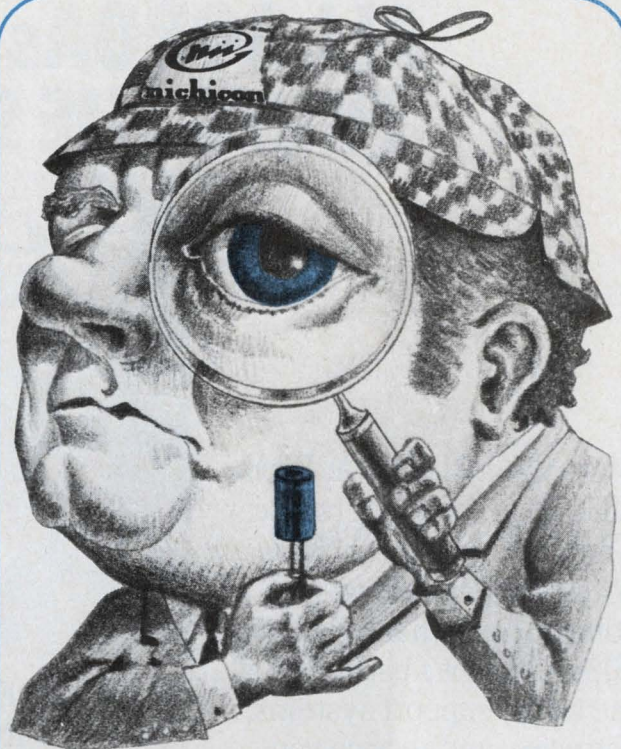

Check the operating temperature range. Make sure it's from  $-40^{\circ}\text{C}$  to  $+85^{\circ}\text{C}$ . Check the capacitance and tolerance. I ask you, how many **axial and radial miniature aluminum electrolytic capacitors** can a person inspect? Check the leakage current and the dissipation factor. Double check the low temperature characteristics. Study the life test results. Check and eliminate any units not living up to Nichicon shelf life test requirements. Sometimes I ask myself, "Hawkeye, is it worth it?" But after all, it's my work that assures reliability and that's what helps to **keep your world turned on**. So grab a sheet of your letterhead and write for your free catalog today.

NLA SERIES—CAPACITANCE CHANGE vs. TEMPERATURE

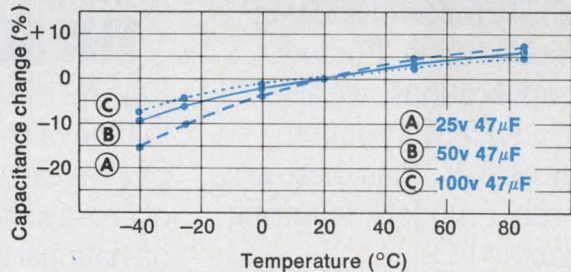

**Production items include:** electrolytic capacitors • ceramic capacitors • computer grade electrolytics • film capacitors • oil filled capacitors—without P.C.B.'s • metallized paper capacitors • wax paper capacitors • mica capacitors

nichicon

6435 N. Proesel, Chicago, Ill. 60645 • (312) 679-6530  
40 Orville Dr., Bohemia, N.Y. 11716 • (516) 567-2994  
Division NICHICON CAPACITOR LTD., Kyoto, Japan

CIRCLE NUMBER 146

139

# ALL 8080As DON'T COME FROM THE SAME PLACE.



Meet the  $\mu$ PD8080A. From NEC Microcomputers, Inc. The microprocessor that's both fully software and pin compatible with Intel's new 8080A. And it's backed by all the chips, support systems, software, and service you need to make it into a complete microcomputer system — the  $\mu$ COM-8.

## THE CHIPS.

We start with not one, but four 8080-type microprocessors.

At the top of the line is the  $\mu$ PD8080A. It gives you everything their 8080A does, plus extras like full BCD capability for both addition and subtraction. For low-cost applications, we also have a 1.25 MHz option — the 8080A-E. Plus there are two other models, featuring improved I/O.

In addition, we can give you the best in RAMs, ROMs, and PROMs, includ-

ing the only Electrically Alterable PROM with the speed to match the processor.

## THE SUPPORT SYSTEMS.

We offer both a full-scale microcomputer — the PDA-80 — for software development and hardware emulation; *and* a microcomputer-on-a-board — the EVAKIT — for evaluation purposes.

## THE SOFTWARE.

For the PDA-80 we have a full line of resident software. Or, we can give you a full line of cross software, available on national timesharing services or installed on your own computer system. This includes our unique Macro

Maintenance Program (MMP) for storing common macros and sub-routines for use with our Macro Assembler.

## AND THE SERVICE.

The  $\mu$ COM-8 package also includes complete documentation, an ever-expanding library of Applications Notes, and a responsive, in-depth applications engineering service, available nationwide.

## SO...

Whatever your application or your needs — first source or second source, large volume or small, chips or complete systems — take a look at everything *our* 8080A gives you.

You really can't afford not to.

NEC Microcomputers, Inc., Five Militia Drive, Lexington, Mass. 02173, 617-862-6410.

# NEC microcomputers, inc.

## WHERE TO BUY IT.

### REPS

#### East

Trionic Assoc.  
Great Neck, NY  
516/466-2300

C.H. Newson  
Philadelphia, PA  
215/248-3377

Harrisburg  
717/233-8576  
Baltimore  
301/825-0001

Perrott Assoc.  
Orlando, FL  
305/275-1132  
Largo, FL  
813/585-3327  
Ft. Lauderdale, FL  
305/792-2211

Wolffs Sales Serv.  
Raleigh, NC  
919/781-0164

Space Eng. Sales  
Huntsville, AL  
205/837-6060

#### Central

McFadden Sales  
Columbus, OH  
614/221-3363

Bitronics Sales Co.  
Minneapolis, MN  
612/835-7744

RF Specialists  
Park Ridge, IL  
312/698-2044

Merino Sales Co.  
Dallas, TX  
214/233-6002

R.C. Nordstrom  
Lathrup Village, MI  
313/559-7373  
Benton Harbor, MI  
616/429-8560

#### West

Mike Duffy Assoc.  
Denver, CO  
303/934-7392

Tri-Tronix  
Albuquerque, NM  
505/265-8409  
Bellevue, WA  
206/454-0940

Summit Sales  
Scottsdale, AZ  
602/994-4587

E.C.M.  
Woodland Hills, CA  
213/340-1745  
El Toro, CA  
714/830-3939  
San Diego, CA  
714/295-6122

Trident Assoc.  
Mountain View, CA  
415/967-7031

### Canada

R.F.Q. Ltd.  
Toronto, ONT  
416/626-1445  
Montreal, QUE  
514/626-8324

### DISTRIBUTORS

Harvey Elect.  
Lexington, MA  
617/861-9200  
Norwalk, CT  
203/853-1515  
Fairfield, NJ  
201/227-0515  
Woodbury, NY  
516/921-8700

Intermark Elect.  
Seattle, WA  
206/767-3160  
Santa Ana, CA  
714/540-1322  
213/436-5275  
San Diego, CA  
714/279-5200  
714/453-9005  
Sunnyvale, CA  
408/738-1111

## INSTRUMENTATION

### DMM promises rock-steady performance



Dana Laboratories, 2401 Campus Dr., Irvine, CA 92713. (714) 833-1234. \$549; 30 days.

Model 4600 4-1/2-digit DMM is said to provide accuracies equal to that of many 5-1/2-digit DVMs. It combines this accuracy with full autoranging over each of its five functions and high six-month stability. Other specs include NMR of 80 dB, 10,000-M $\Omega$  input impedance, and optional BCD output or battery-powered operation. The five functions are: ac and dc volts (10  $\mu$ V to 1000 V), ohms (10 m $\Omega$  to 20,000 k $\Omega$ ), dc and ac current (10 nA to 2 A). The dc accuracy of the 4600 is within 0.01% rdg  $\pm$ 1 digit for six months and is maintained over 20 to 30 C and up to 80% relative humidity.

Booth No. 2710 Circle No. 354

### IC tester programs with magnetic cards

Hewlett-Packard, 1501 Page Mill Rd., Palo Alto, CA 94304. (415) 493-1501. 16 pins, \$9000; 24 pins, \$11,000.

Just insert a preprogrammed magnetic card into the slot of the 5045A IC tester, and the unit will do the rest. Dc parametric and functional tests are performed on a wide variety of logic families and functions up to 16 pins (24 pins optional). Diagnostic tests are run, and a thermal printout tells the user the type of failure, pins failed, voltage/current analysis of failed pins and other data. Test patterns can be generated by algorithmic techniques or by storing a truth table in memory.

Booth No. 2201-10 Circle No. 355



... so I said .. OK, show me a switching power supply with the brains to perform reliably in my environment, where others have failed

... and **TODD** did.

TODD'S SW SERIES FEATURES:

- High efficiency. Greater than 75%.
- Most reliable.
- Complete range of outputs thru 48V and currents to 120 Amps.
- Lowest price.
- Full 5 year warranty.

Start getting your moneys worth. Write or call for complete information today.

TODD PRODUCTS CORP.

123 Milbar Blvd., Farmingdale, N.Y. 11735. (516) 293-3440.

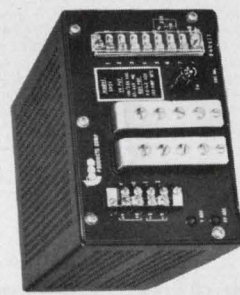

CIRCLE NUMBER 87

**NEC microcomputers, inc.**

**PROFESSIONAL  
DISCOUNT  
PRICES  
AVAILABLE ON**

**Texas  
Instruments  
Engineering  
Calculators**

**PHONE TOLL-FREE  
800-638-8906**

FOR THE CURRENT LOW DISCOUNT PRICE  
OF THE LATEST MODEL TEXAS  
INSTRUMENTS CALCULATOR OF  
YOUR CHOICE

**Texas Instruments SR-52**



Programming power from Texas Instruments. Easy hand held programming for scientists, engineers, students — anyone who works with advanced mathematics. Check these features: 224 program locations, 20 addressable memory registers, 23 pre-programmed key functions, indirect addressing, permanent program storage on magnetic cards.

**Texas Instruments SR-56**



More power from Texas Instruments. Hand held key programmable calculator. 100 program steps, 5 program levels (up to 4 levels of subroutine may be defined). Easy single step editing. Main features include 26 preprogrammed key functions, 10 addressable memory registers, algebraic logic and 9 levels of parentheses.

**PC-100** Lock down printer; for a hard copy of your results; step by step listing of programs, or "debugging" programs. The PC-100 printer may be used with the SR-56 or SR-52.

**OTHER MODELS AVAILABLE**

SR-50A, SR-51A, TI 2550II, TI 2500II, TI 5100

**ALL THE FAMOUS  
TEXAS INSTRUMENTS  
ELECTRONIC CALCULATORS  
ARE AVAILABLE AT DISCOUNT PRICES**

Mail and phone orders accepted. Master Charge and BankAmericard accepted. Add \$2.50 per unit for shipping and handling. Maryland residents add 4% sales tax.

Use our toll free phone: **800-638-8906** (Maryland residents phone: **(301) 340-7200**) to order or for current discount quotations on the leading brands of electronic calculators: Texas Instruments, Hewlett-Packard, Rockwell, Ricoh, Kingspoint, Corvus, Novus, and many more.

**THE GUARANTEE**

**10 day money back trial.** If you are not completely satisfied you may return the Texas Instruments calculator you order within 10 days for a cash refund or charge cancellation. In addition Texas Instruments Inc. and Capital Calculator Co. Inc. warrant each calculator for a period of one year against defective parts and workmanship.

**Capital Calculator Company**

**701 East Gude Drive  
Rockville, Maryland 20850**

CIRCLE NUMBER 88

**INSTRUMENTATION**

**OEM recorder module  
meets UL544 specs**

*MFE Corp., Keewaydin Dr., Salem, NH 03079. (603) 893-1921. \$430; stock.*

M2-AHAUL single-channel recorder is recognized under the component program of Underwriters Lab. Inc. (UL544). The OEM recorder module is a completely self-contained, lightweight instrument. The inkless, heated-stylus method of recording provides a clear, high-resolution trace that will not smudge or fade.

*Booth No. 2420-2422*

*Circle No. 358*

**Indicators come in host  
of sizes and ranges**

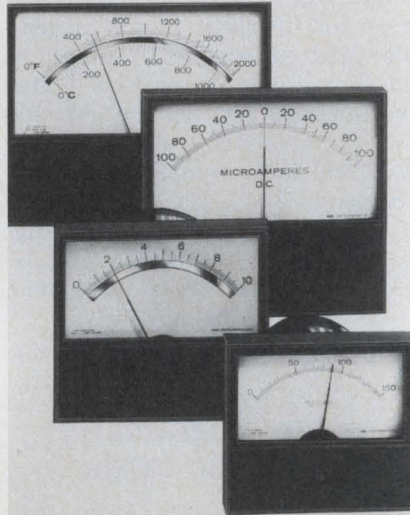

*LFE Process Control Div., 1601 Trapelo Rd., Waltham, MA 02154. (617) 890-2000. From \$22.50.*

Serie 7000 analog panel instruments offer distinctive style and functional flexibility in four sizes: 2-1/2, 3-1/2, 4-1/2, and 5-1/2 in. The three-way choice of mounting (front, bezel and lens), the front-panel decorator plates, and the slide-out scales allow a maximum selection from inventory. Taut-band mechanisms and 1% tracking are standard in many ranges. Series 7000 is available in ac and dc current and voltage ranges, as well as thermocouple temperature indicators and VU meters.

*Booth No. 2502, 04 Circle No. 359*

**Here's all you  
need for  
computer/  
process  
interface!**

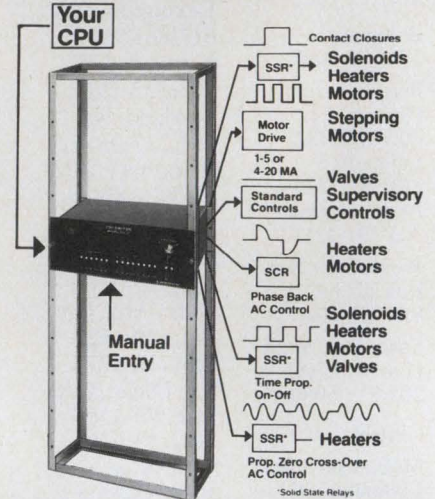

**UNI-DRIVER**, the one *stand-alone* interface between your computer and *all* commonly used final control elements. It maintains process control at the last command level, even with the computer shut down, and provides "back up" manual control.

**Mix or match** any combination of control cards to drive contactors, heaters, motors, pumps, power controllers, valves, set points, motor speeds, solenoids, shutters, louvers, fans, lamps, stepping motors, you call the shots. Up to 64 proportional outputs or 512 on-off outputs per Uni-Driver.

**Eliminate** a rack full of "black boxes!" Call collect (612) 941-3300 and ask for UNI-DRIVER! Also, ask about ANA-PLEXER. That's our combination Mux & A/D converter for sampling process control signals of almost any analog transducer or sensor. Directly interfaces with your CPU without external I/O.

184

Direct Digital Control Division  
**RESEARCH INC**  
BOX 24064 MINNEAPOLIS, MINNESOTA USA 55424  
PHONE (612) 941-3300

CIRCLE NUMBER 89

ELECTRONIC DESIGN 10, May 10, 1976



# NEW APPROACH TO LOW LEVEL DATA ACQUISITION

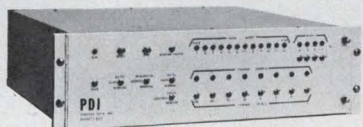

Phoenix Data's new 8000 Series

Phoenix Data's floating point 8000 Series data acquisition system features adaptability to virtually any analog input signal currently in use—offering automatic or programmed gain selection with 11 binary ranges from  $\pm 10$  millivolts to  $\pm 10.24$  volts full scale. The data word (12 binary bits) is combined with the range data (4 binary bits) for a 16 bit output word in the automatic ranging mode. The system will resolve input changes of 5 microvolts on the  $\pm 10$  millivolt range for an overall analog dynamic range of 132 db.

#### FEATURES:

- ADC resolution of 12 binary bits.
- 11 binary gain ranges.
- $\pm 10$  mv to  $\pm 10.24$ V input ranges.
- Solid state MOSFET multiplexing.
- Thruput rates from 1 to 20 KHz.
- Auto or programmable gains.
- Up to 128 channels per chassis.
- System accuracy of .05% of reading.
- System T.C.:  $0.001\% \text{FSR} \pm 1\mu$  volt RTI/ $^{\circ}\text{C}$ .

If it's stability, accuracy, speed, or all-around quality you need in Data Conversion, contact Ron Brunnemer, director of marketing, or the representative in your area.



## PHOENIX DATA, INC.

3384 W. OSBORN RD. PHOENIX, AZ 85017  
Ph. (602) 278-8528, TWX 910-951-1364

CIRCLE NUMBER 90  
ELECTRONIC DESIGN 10, May 10, 1976

## Freq synthesizer expands to 48 channels

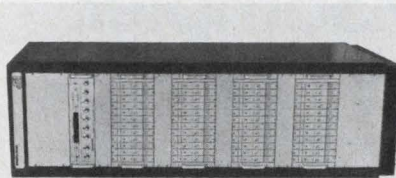

Rockland Systems, 230 W. Nyack Rd., West Nyack, NY 10994. (914) 623-6666. \$27,500 (12 channels); 120 days.

System 51 provides up to 48 channels of spectrally pure and highly stable frequencies from dc to 3 MHz with 1-Hz resolution throughout the range. High speed programming ( $5 \mu\text{s}$ ) is accomplished while maintaining amplitude and phase continuity. The system is self-contained in its own forced-air-cooled rack and consists of the Model 5196 controller, Model 5112 mainframe, and Model 5101 synthesizer channels. Outputs include: 1) sine wave, 1-V rms,  $50\text{-}\Omega$  source impedance; 2) square wave, TTL level, 30-TTL load capability; 3) square wave, TTL level, complementary, 30-TTL load capability.

Booth No. 2520 Circle No. 360

## Memory tester cycles in 100 ns

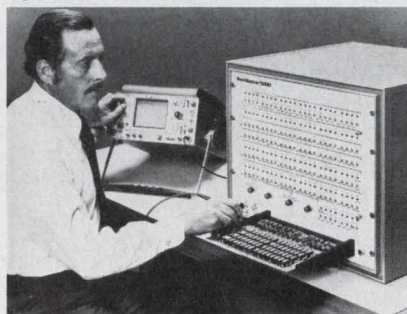

Technology Marketing, 3170 Red Hill Ave., Costa Mesa, CA 92626. (714) 979-1100. Start at \$17,000; 12 wks.

Series 5000 semiconductor memory and LSI tester is said to be the first to offer 100-ns cycle time for all test patterns. The tester features specialized processors with either a ROM or an optional RAM for program storage. The RAM option provides maximum flexibility to alter test programs. Seven configurations offer a variety of choices.

Booth No. 1326 Circle No. 361

## LASER MARKED UHF/MICROWAVE CHIP CAPACITOR KITS



ACTUAL SIZE  
55 MIL CUBE

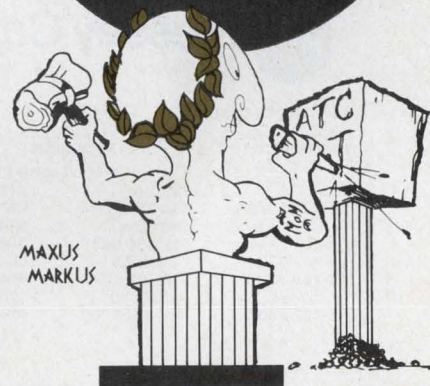

MAXUS  
MARKUS

## DESIGN VALUE KITS:

40 MARKED POPULAR VALUES  
IMMEDIATELY AVAILABLE IN  
KITS OR SEPARATELY.

BUY ANY DESIGN VALUE KIT  
OF 100 ATC 100 LOW LOSS  
PORCELAIN CHIP CAPACITORS  
FOR \$77.00.



MINI MARKUS

"SEE US AT BOOTH A114 AT ELECTRO '76"  
Just circle the number below  
for more information on ATC's  
new laser marked chip capacitor  
kits.

## american technical ceramics

ONE NORDEN LANE,  
HUNTINGTON STATION, N.Y. 11746  
(516) 271-9600 • TWX 510-226-6993

CIRCLE NUMBER 91

# The Plessey Sampler.

Just \$15.00, and you can sample 18 values between 0.001  $\mu$ F and 1.0  $\mu$ F, 100V to 1,000V, from our broad range of metallized film capacitors manufactured in California. It's just enough to give you a taste for Plessey quality and performance. And show you how the simplicity of our minibox design fits right into your packaging requirements. Compact. Non-burning. With no lead forming or cutting required to simplify PC board assembly. They're ideal for flow soldering. And in production quantities, you'll find that they fit right into your budget as well.

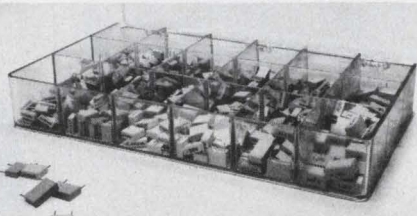

Call the Plessey Distributor nearest you, or contact Plessey Capacitors directly. For only \$15.00, you'll receive our Series 160 Minibox Capacitor Sampler containing over 300 pieces to assist with your design requirements.



## Plessey Capacitors

5334 Sterling Center Drive, Westlake Village, California 91361 (213) 889-4120

**J.V. ELECTRONICS**  
EAST HAVEN  
203-469-2321

**HI-REL**  
LOS ANGELES  
213-774-8200

**CAPACITOR SALES**  
SAN FRANCISCO  
415-964-8880

**ELECTRO SONIC**  
TORONTO  
416-494-1666

### HALL-MARK ELECTRONICS CORP.

ATLANTA  
800-633-2918  
AUSTIN  
512-837-2814  
BALTIMORE  
301-265-8500  
CHICAGO  
312-437-8800

DALLAS  
214-231-6111  
DAYTON  
513-294-0437  
HOUSTON  
713-781-6100  
HUNTSVILLE  
205-837-8700

KANSAS CITY  
913-888-4747  
MIAMI  
305-971-9280  
MILWAUKEE  
414-476-1270  
MINNEAPOLIS  
612-884-9056

NEW YORK  
516-273-0030  
ORLANDO  
305-855-4020  
PHILADELPHIA  
215-355-7300  
RALEIGH  
919-832-4465

ST. LOUIS  
314-291-5350  
TULSA  
918-835-8458  
WICHITA  
316-682-2073

CIRCLE NUMBER 92

## PM MAGNETIC SHIELDS

**Immediate Delivery- For Over 90% Of Current Photomultiplier Tube Types**

These high permeability AD-MU magnetic shields are fully hydrogen annealed, ready for use. Already tooled—no tooling cost.

For your special application or specific environment, our Problem Solving Magnetic Shielding Specialists can either modify a stock shield, or custom design a shield to your exact requirement.

18 pages of advanced shielding techniques and components. Also 4-Page Reprint from Electronic Design. Yours for the asking.



## AD-VANCE MAGNETICS, INC.

226 E. SEVENTH ST., ROCHESTER, IND. 46975  
(219) 223-3158 TWX 810 290 0294

Our 3rd Decade of Magnetic Shielding Leadership



CIRCLE NUMBER 93

## INSTRUMENTATION

### Six options expand scope of digital scope

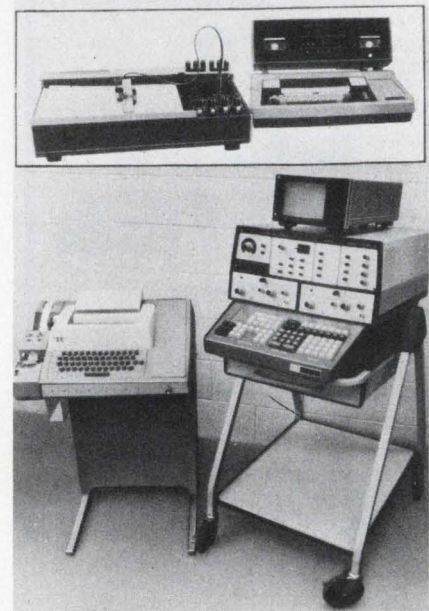

Norland Instruments, Norland Dr., Fort Atkinson, WI 53538. (414) 563-8456.

Six new options for use with the NI 2001 programmable calculating oscilloscope extend the application and interfacing of the unit in digital data acquisition and reduction. Included are a serial asynchronous digital I/O, a file option, an X-Y plotter option, a computer link option, an 8-bit parallel digital I/O and a 12-bit DAC output.

Booth No. 2608-2610

Circle No. 362

### Instruments keep eye on process functions

Doric Scientific, 3883 Ruffin Rd., San Diego, CA 92123. (714) 565-4415. Start at \$299; 60 days.

Series 400A digital trendicators are for monitoring process functions—such as temperature, pressure, and voltage—from thermocouples, RTDs, current transmitters and other low-voltage transducers. They are available with resolutions of  $\pm 0.01$  degree for temperature, to  $\pm 0.01\%$  for current, and to  $\pm 1 \mu$ V for voltage readings, in nine thermocouple ranges, two platinum RTD ranges, two current transmitter ranges and four voltage ranges.

Booth No. 2601-2603

Circle No. 363

# Get more for your money!

## Use This New 3/8" Square Cermet Trimmer From Allen-Bradley

Our new TYPE E trimmer is a high performer with a realistic price. It has some important advantages: • Immersion seal is tested in 85°C water (not 50° or 70°). • Temperature characteristic is 100 PPM/°C for stability. • Multifingered contact for excellent adjustability. • \$0.49 each—1000 piece price. For more information call your A-B distributor or write for Publication 5219.

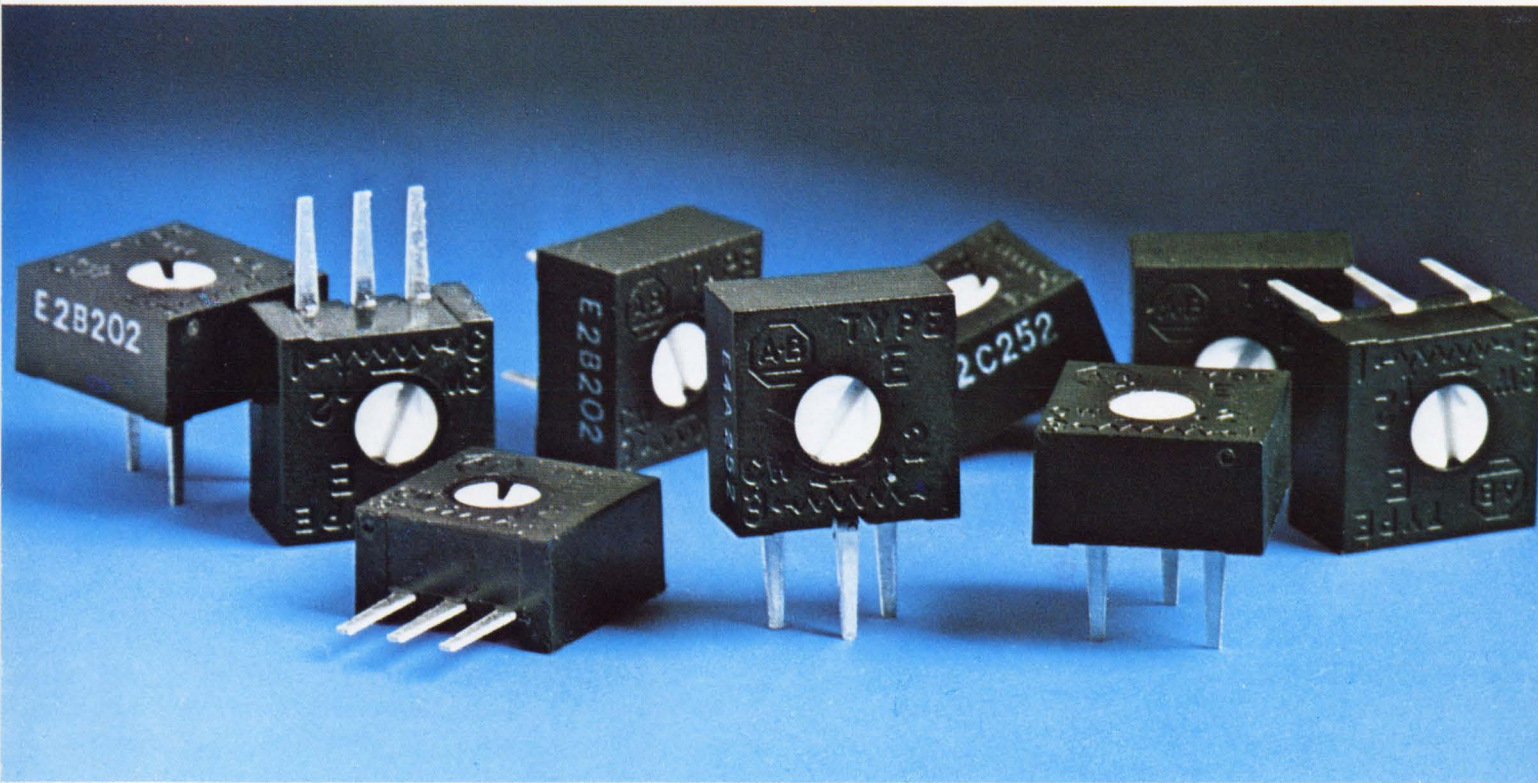
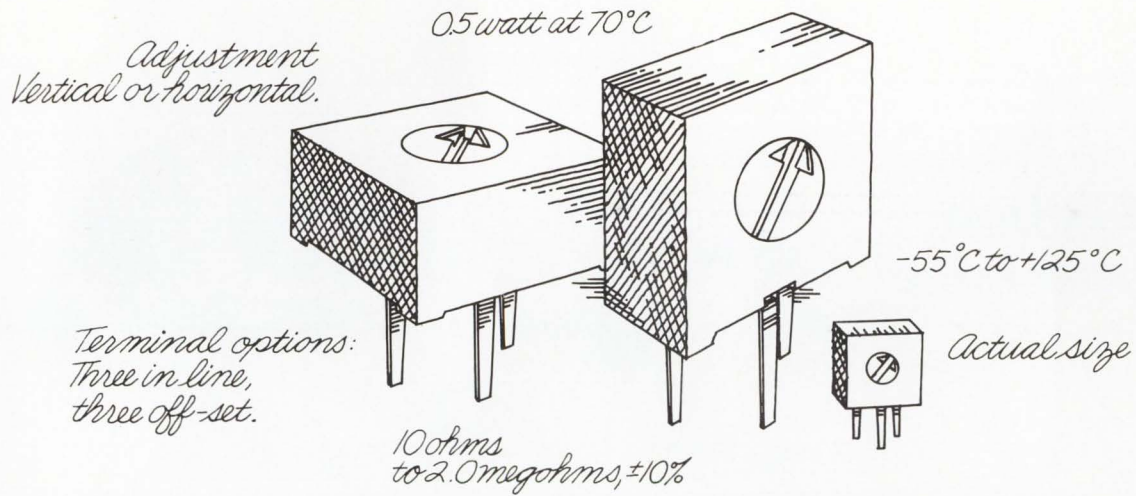

## Quality in the best tradition.



**ALLEN-BRADLEY**

Electronics Division  
Milwaukee, Wisconsin 53204

EC108

CIRCLE NUMBER 141

New from Centralab...

# CERBON™ TRIMMER RESISTORS

**Affordable Stability...**  
**300% More**  
**Stable Than Carbon...**  
**at a Carbon**  
**Trimmer Price!**



**Why pay more?** With Centralab's new CERBON trimmers you get stability approaching cermet and at carbon prices... As little as 28¢ in distributor 1,000 quantities; as low as 10¢ in high volume orders.

**The secret of CERBON superior performance?** A totally new thick film resistor element, which combines both potentiometer and conventional thick film technologies, *plus* a heat stable ceramic substrate, *plus* a dual-tine contact spring, *plus* "Fluxgard" protection from dust and wave soldering contaminants. In short, a totally balanced electromechanical system.

**Look at these benefits:**

- TCR less than  $-400$  ppm/°C.
- CRV less than 2% of maximum resistance.
- Rotational life exceeds 500 cycles.
- Adjustability (typical)  $-0.05\%$  of total voltage.
- High overload capability—

1 watt at 25°C ambient for 1,000 hours exhibits less than 2% cumulative resistance change. • Maximum stability in humid environment — Resistors exposed to an atmosphere of 40°C at 95% relative humidity for 300 hours return within four hours to  $+2.5\%$  of their initial readings.

CERBON trimmers are offered in a resistance range of 1 K ohm to 1 megohm with a choice of standard PC terminal configurations. They fit universally accepted circuit board mounting patterns. And they're ready now for fast delivery in any quantity.

Write for complete technical data on Centralab's new CERBON trimmer resistors. Or call (915) 799-3961 for a free evaluation sample. Move up to CERBON and save!

**AVAILABLE CIRCUIT OPTIONS**

Thanks to their ceramic substrate, Centralab CERBON trimmers permit a variety of screen printed circuit options. Here are three typical circuits:

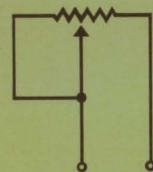

**TERMINAL SHORTING**

One of five electrical termination options available.

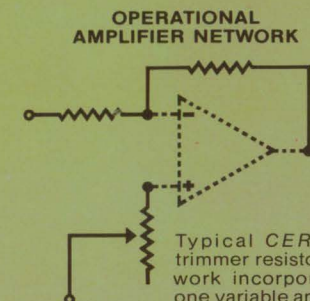

**OPERATIONAL AMPLIFIER NETWORK**

Typical CERBON trimmer resistor network incorporating one variable and two fixed resistors on dual substrate configuration.

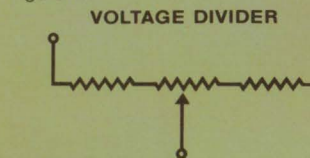

**VOLTAGE DIVIDER**

Fixed and variable resistors can be ratio matched for precise values and to insure temperature tracking. Eliminates need for costly discrete resistor selection.



Knob colors available in white, blue, red and green for ease in assembly operations.



**CENTRALAB**  
Electronics Division  
GLOBE-UNION INC.

7158 MERCHANT AVENUE  
EL PASO, TEXAS 79915



Made like a fine watch

## Inspired design... meticulous craftsmanship in a very low cost, very low profile relay

**The Guardian 1475 relay:** Engineered to work like clockwork in your most demanding single pole or double pole high density packaging applications. It switches currents from dry circuit right on up to 5 amps that could weld contacts on other small relays and reeds. All because of design features like these (indicated on the above illustration):

(A) Convoluted stationary contacts with built-in wipe because of (B) armature with off-center fulcrum. (C) .031" diameter terminal pins on .1" grid spacing for PC boards are molded into base with reinforced bosses around thick center section of pins. May be deformed without affecting adjustment. (D) Sealed thermoset glass-filled polyester housing and cover. (E) Built-in bosses provide air space between board and base for better heat dissipation. Plus U/L recognition... and more:

Sealed to shrug off 650°F wave soldering or immersion in cleaning solvents. Sealed to keep contamination outside—where it can't foul contacts. Fast acting, with typical attract time of 3.5 ms; release time, 2.2 ms at up to 50 operations per second. With contact bounce of less than 1 ms on N.O. contact. Shock and vibration resistant. Typical mechanical life of 100 million operations.

**Each relay's performance and reliability are proven by nine—yes, nine!—individual tests.** (Operation at normal, specified pick up and release voltages; time delay limits on attract and release; contact resistance limits; contact gap and pressure; and ground test.) The nine testing sequences are automatic on every relay. A single failure? Automatic rejection. To the scrap pile.

Ask your Guardian Angel for this free 48-page handbook and catalog.



This mark indicates recognition under the component program of Underwriters Laboratories, Inc.



# GUARDIAN®

GUARDIAN ELECTRIC MANUFACTURING CO. • 1572 West Carroll Ave., Chicago, Illinois 60607 • 312/243-1100

CIRCLE NUMBER 342

MAIL TO:

# Electronic Design

P.O. BOX 13803, PHILADELPHIA, PA. 19101

FREE SUBSCRIPTION APPLICATION

Do you wish to receive (continue to receive)

ELECTRONIC DESIGN?  Yes  No

Signature: Does not obligate me or my company

I wish to receive (do not wish to receive) other solicitations.  Yes  No

ALL SUBSCRIBERS: Please fill out completely, the name and address portion, even if the information on your label is the same. (For prompt, accurate processing remember to affix label in the space provided above.) Do not use periods, commas etc.

To qualify please answer all questions carefully. Independent consultants must attach business card.

MR.  MS.

Area Code	Office Telephone
-----------	------------------

1st Initial	2nd Initial	Last Name	Title
Company Name (Do not abbreviate if possible)		Division	
Parent Company (if subsidiary) (Do not abbreviate if possible)			
Department		Internal Mail Code	
Company Street Address or P.O. Box No.			
Company City		State/Country	Zip Code/Postal Code
Home Address			
Home City		State/Country	Zip Code/Postal Code

**8 Products you specify or authorize purchase of:**  
*(Check all codes that apply.)*

<input type="checkbox"/> 1 Resistors and Capacitors	<input type="checkbox"/> 12 Computer Peripherals
<input type="checkbox"/> 2 Connectors	<input type="checkbox"/> 13 Computer Components
<input type="checkbox"/> 3 Switches and Relays	<input type="checkbox"/> 14 Cabinets and Enclosures
<input type="checkbox"/> 4 Function Modules: Op Amps, Converters, etc.	<input type="checkbox"/> 15 Panel Meters, Analog or Digital
<input type="checkbox"/> 5 Potentiometers	<input type="checkbox"/> 16 Readout and Display Devices
<input type="checkbox"/> 6 Test and Measurement Equipment	<input type="checkbox"/> 17 Rotating Components
<input type="checkbox"/> 7 Computers, Medium and Large	<input type="checkbox"/> 18 Cooling Products
<input type="checkbox"/> 8 Electronic Power Supplies	<input type="checkbox"/> 19 Printed Circuits
<input type="checkbox"/> 9 ICs and Semiconductors	<input type="checkbox"/> 20 Calculators
<input type="checkbox"/> 10 Microwave Devices	<input type="checkbox"/> 21 Indicators including LEDs
<input type="checkbox"/> 11 Minicomputers	<input type="checkbox"/> 22 Materials, Potting and Stripping
	<input type="checkbox"/> 23 Communications Equipment

**7** Please write in box total number (other than self) to be served by this subscription at this address and list individuals and their titles below. If no other person is served please indicate "0" in the box at left.

Name (Please Print)	Title

**9** Do you specify or buy through distributors?  
 YES  NO

**10 Minicomputers at this address:**

	Model	Qty.	Model	Qty.
3	Cincinnati Milacron			
C	Computer Automation			
D	Control Data			
E	Data General			
F	Digital Equipment			
I	General Automation			
K	Hewlett Packard			
M	Honeywell			
O	IBM			
N	Interdata			
7	Microdata			
	Modular Computer			
	ROLM			
V	Systems Engineering Labs			
9	Texas Instruments			
x	Varian			
	Other			

**1** Title: (Insert letter)

A President	J Project Engineer
B Vice President	K Senior Engineer
C Vice President of Engineering	L Group Leader
D Technical Director	M Dept. Head
E Chief Engineer	N MTS
F Principal Engineer	O Engineer
G Research Director	P Consultant
H Section Head	R Scientist
	S Physicist

**2** Your principal job function: (Insert code)

- General and Corporate Management
- Design and Development Engineering (circuits, components, equipment systems)
- Engineering Services (evaluation, quality control, reliability, standards, test)
- Basic Research
- Manufacturing and Production
- Engineering Assistants (draftsman, lab assistant, technician)
- Purchasing and Procurement
- Marketing including Sales
- Other Personnel (explain)

**3** Plant  Your own work

The primary end product (or service performed) at your plant, and the product (or service) that is your own work. (Insert code in each box even if the same)

A	A Large Computers
B	B Mini-Computers
C	C Computer Peripheral Equipment
D	D Data Processing Systems (Systems Integration)
T	T Office and Business Machines
E	E Test, Measurement and Instrumentation Equipment
F	F Communications Systems and Equipment
H	H Navigation and Guidance Systems and Equipment
J	J Consumer Entertainment Electronic Equipment
G	G Consumer Electronic Appliances
N	N Other Consumer Electronics
K	K Industrial Controls, Systems and Equipment
L	L Components and Sub Assemblies
M	M Materials and Hardware
Q	Q Aircraft, Missiles, Space and Ground Support Equipment
P	P Oceanography and Support Equipment
R	R Medical Electronics
U	U Industrial Companies within the OEM incorporating Electronic Equipment in their end product, not elsewhere classified
V	V Independent Research, Test and Design Laboratory and Consultant. (Only if you are not connected with a manufacturing company.)
X	X Government Agency and Military
2	2 Industrial Companies using and/or incorporating any Electronic products in their manufacturing, research or development activities.
1	1 Commercial Users of Electronic Equipment
3	3 Distributor
4	4 School, University or Library
5	5 Other (explain)

**4** Your design function: (Insert each letter that applies)

A I do electronic design or development engineering work  
 B I supervise electronic design or development engineering work  
 C I set standards for, or evaluate electronic design components, systems and materials

**5** Your principal responsibility: (Insert code)

1 Management other than Engineering	3 Engineering
2 Engineering Management	

**6** Please estimate: (Insert letter)

The number of electronic engineers at this address:  
 (A) 1 (B) 2-5 (C) 6-19 (D) 20-49 (E) 50-99  
 (F) 100-249 (G) 250-499 (H) 500-999 (J) Over 1000

This questionnaire conforms to the guidelines of the Business Publication Audit of circulation for eliciting comparable data. The publisher reserves the right to serve only those individuals who qualify for a free subscription.

**ELECTRONIC DESIGN** is sent free to qualified engineers and engineering managers doing work, supervising design or setting the standards in the United States and Western Europe.

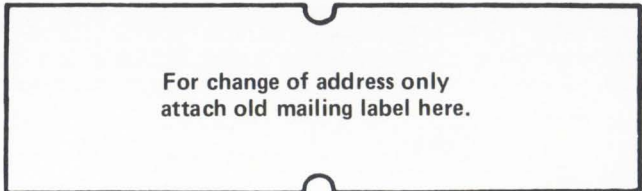

Use this form for Change of Address or New Subscription Only.

## Two units measure L: One digital, one analog



Boonton Electronics, Rte. 287 at Smith Rd., Parsippany, NJ 07054. (201) 887-5110. \$1050 (62A); 2 wks.

Two new Model 62 series inductance meters provide two-terminal, series-inductance measurements at 1 MHz with low test current. The analog Model 62A has full-scale manual ranges of 1 to 3000  $\mu$ H in a 1-3-10 sequence; the digital 62AD has four decade ranges, manually selected or autoranged, from 2 to 2000  $\mu$ H full scale. Basic accuracies are  $\pm(0.5\%$  rdg + 0.5% fs) for analog and  $\pm(0.5\%$  rdg + 0.2% fs) for digital display. Booth No. 2301-2303

Circle No. 364

## Compact rf sweepers join modular test line

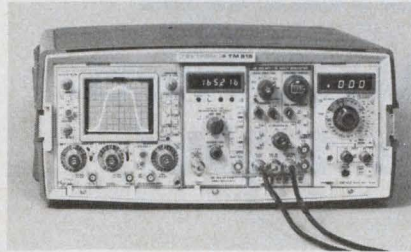

Tektronix, P.O. Box 500, Beaverton, OR 97077. (503) 644-0161. \$1400; stock.

SW 503 (50- $\Omega$ ) and the SW 503 option 1 (75  $\Omega$ ) rf sweep generators are compact units designed to operate in the company's TM 500 series power module. Both units cover a frequency range of 1 to 400 MHz, have a variable sweep rate, step attenuator, 20-dB vernier attenuator, and a crystal-controlled marker generator that provides comb type markers at 1, 10 and 50 MHz.

Booth No. 2801-2810

Circle No. 365

## Spectrum analyzer shows 72-dB range



Kay Elemetrics, 12 Maple Ave., Pine Brook, NJ 07058. (201) 227-2000. \$2585.

1-to-300-MHz spectrum analyzer features a spurious-free 72-dB dynamic range with phase-locked 1-kHz resolution. Internal calibration for frequency and amplitude is included. The P9040 is available with power supply for independent use with any oscilloscope. Input signal sensitivity is -100 dBm for the 50- $\Omega$  version and -50 dBmV for the 75- $\Omega$ .

Booth No. 2316-2318

Circle No. 366

## MICROPAC

LOW-COST OFF-THE-SHELF  
HYBRID VOLTAGE  
REGULATORS

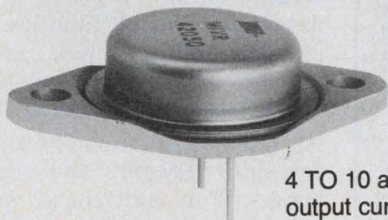

4 TO 10 amp  
output current

- 5 to 36 fixed voltage range
- Positive & Negative voltages
- 120 Watts power dissipation
- Internal short circuit protection
- External components not required
- Standard TO-3 Package
- Available from stock
- Economically priced

CUSTOM PRODUCTS ALSO AVAILABLE  
WRITE FOR OUR FREE FACILITIES BROCHURE



**MICROPAC INDUSTRIES, INC.**

905 E. WALNUT ST. GARLAND, TEXAS 75040 Tel. 214-272-3571  
TWX 910-860-5186

CIRCLE NUMBER 94

ELECTRONIC DESIGN 10, May 10, 1976

## MICROPROCESSOR SERIES NO. 1

### OUR EASIEST-TO-USE 2650: NOW MULTI-SOURCED.

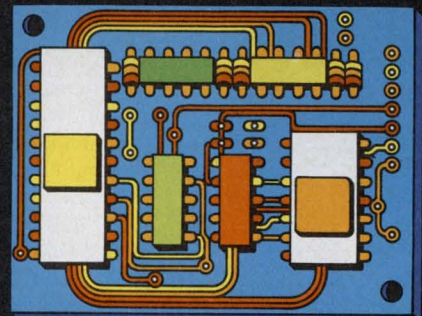

All the 2650's you need, in stock at Signetics, authorized distributors, Advanced Memory Systems (AMS) and Philips, too.

Clip coupon to letterhead. Or call (408) 739-7700, Ext. 2982/3. Please rush me my FREE 2650 Short Form Catalog.

Name \_\_\_\_\_ Title \_\_\_\_\_

Tel. \_\_\_\_\_ M.S. \_\_\_\_\_

811 E. ARQUES, SUNNYVALE, CA. 94086

THINK  
**signetics  $\mu$ P**  
a subsidiary of U.S. Philips Corporation

CIRCLE NUMBER 95

145

# Encapsulated Power Supplies Easy to use 1-10W

Same Day Shipment

Call 1-800-327-8983 Toll free



**Computer Products, inc.**

g3

CIRCLE NUMBER 96

## INSTRUMENTATION

### Function gens deliver 'high-voltage' outputs

*Interstate Electronics, 707 E. Vermont Ave., P.O. Box 3117, Anaheim, CA 92803. (714) 772-2811. Model F44, \$595; F47, \$675.*

Series 40 function generator is said to be the first with sweep markers and high-voltage output. Two generators deliver an output to 40 V, open circuit, and produce waveforms from 0.004 Hz to 4 MHz. Model F44 provides linear sweep capability, and Model F47 adds logarithmic/linear sweep and operator-controlled step-frequency calibration between main dial frequency settings. Both multifunction generators also feature frequency markers. Additionally, the selection of waveforms offered on both models includes bipolar and unipolar, positive and negative, variable-width pulses down to 120 ns, all with offset control.

*Booth No. 2320-2322*

*Circle No. 367*

## The Servo-Tek World of DC Servomotors



Wide range of permanent-magnet dc models available.

Servo-Tek's Permanent-Magnet DC Servomotors are precision made to give highly reliable performance. Their stability, high output-to-size ratio and speed range from 0-10,000 rpm with output torques to 2.0 oz-in make them ideal as prime movers in servomechanisms. Diameter 1.135 in. lengths up to 3.253 in. A unique field structure of Alnico VI results in minimized cogging (slot lock), a prerequisite to optimum servo performance. Models are available with a variety of operating voltages and with various mountings and integral gearing. Moderately priced with quantity discounts.

FREE CATALOG of rotating components available.

Be Selective,  
Turn To...

**SERVO-TEK®**  
PRODUCTS COMPANY

1086 Goffle Road, Hawthorne, NJ 07506 · 201-427-3100

Servo-Tek of California, Inc.

8155 Van Nuys Blvd., Van Nuys, CA 91402 · 213-786-0690

**SERVO-TEK**  
ALL AMERICAN  
ENGINEERED

CIRCLE NUMBER 97

### Pulse generators drive MOS circuits

*E-H Research Labs, 515 11th St., Box 1289, Oakland, CA 94604. (415) 834-3030. Approx. \$600.*

Model G725 MOS driver is the latest in the company's Generation 70 series of pulse generators. The G725 is ideal for use as a clock or data driver for all families of MOS circuits. Internal clock rates from 1 Hz to 10 MHz and widths from 50 ns to 500 ms allow the G725 to be used as a single-phase driver for shift registers and other logic arrays. For multiphase operation, the two buffered trigger outputs allow several G725s to be combined while maintaining phase relationships. Two remote-probe units for normal and complementary output allow the G725's output to be connected directly to a wafer probe, test fixture, or test circuit. The probe will drive a capacitive load of 100 pF with a rise time of 1 ns/V. Average output current is limited to 20 mA for probe protection.

*Booth No. 2302-2312*

*Circle No. 368*



## Scope probes snap apart

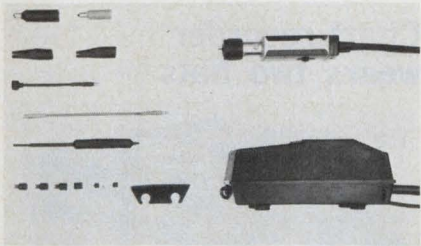

Tektronix, P.O. Box 500, Beaverton, OR 97077. (503) 644-0161. 01, \$30; 05, \$60; 08, \$45; stock.

A new modular concept divides scope probes into three parts (probe heads, cables, and connectors/compensation boxes) that snap together, making maintenance and repair less expensive, faster and much easier. The P6101, P6105 and P6108 are modular, miniature, general-purpose probes. The P6101 is a 1X, 1-M $\Omega$  probe, P6105 is a 10X, 10-M $\Omega$  probe; and the P6108 is a 10X, 10-M $\Omega$  probe when used with a 1-M $\Omega$  input scope.

Booth No. 2801-2810

Circle No. 369

## X-Y recorder makes spectral curves

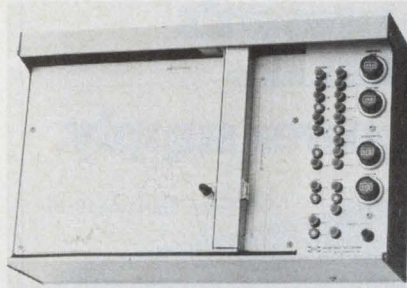

Pacific Measurements, 470 San Antonio Rd., Palo Alto, CA 94306. (415) 494-2900. \$1920; stock-30 days.

Model 1044 response recorder works with the 1038 measurement system to make permanent high-definition response curves on special calibrated 8-1/2 x 11-in. paper. The 1038 system measures swept-frequency gain, insertion loss, and return loss in either one or two channels over the frequency range from 1 MHz to above 40 GHz. The 1038 also analyzes spectrum content from 1 to 20 GHz.

Booth No. 2820 Circle No. 370

## Scope, DMM and counter get together



Vu-Data Corp., 7170 Convoy Ct., San Diego, CA 92111. (714) 279-6572. \$1250; 30 days.

Model PS915/975 is the only test instrument that includes a digital multimeter (DMM), a frequency counter and an oscilloscope packaged together in a single unit with all three measuring devices possessing their own dedicated displays. All three can be used simultaneously or independently. Model PS915 mini-scope is a 20-MHz, triggered sweep, single-trace scope. Vertical sensitivity is 10 mV/div. Model 975 DMM-counter is a 3-1/2-digit, autoranging meter (ac volts, dc volts, and k $\Omega$ ), as well as a 4-digit, 20-MHz frequency counter.

Booth No. 2707 Circle No. 371

If you need

# DIGITAL CLOCKS

look to

## Chrono-log

for

the features you need at off-the-shelf prices. LED, NIXIE® or BCD displays. Time ranges from milliseconds to years. Outputs can be parallel and or serial BCD, modulated carrier, level shift or video. DC, AC or internal battery operation. "Naked" cards for OEM's.

For Digital Clocks, Time Code Generators and Readers, write or call Chrono-log Corp., 2 West Park Road, Havertown, Pa. 19083 Phone: (215) 853-1130

**CHRONO-LOG CORPORATION**

CIRCLE NUMBER 98

ELECTRONIC DESIGN 10, May 10, 1976

MICROPROCESSOR SERIES NO. 2

# 2650 DEVELOPMENT HARDWARE FOR ALL COST/CAPABILITY LEVELS.

Here now:

- PC1001 Prototyping Card
- PC2000 4K Byte RAM Card
- DS2000 Demo Base with P.S.
- PC3000 Smart Typewriter Democard
- KT9000 Prototyping Kit

More Soon!

Clip to your letterhead. Send me the Short Form Catalog including the foregoing data sheets.

Name \_\_\_\_\_ Title \_\_\_\_\_

Tel. \_\_\_\_\_ M.S. \_\_\_\_\_

811 E. ARQUES, SUNNYVALE, CA. 94086

THINK **SYNOPTICS**  $\mu$ P

a subsidiary of U.S. Philips Corporation

CIRCLE NUMBER 99

**33% more power to the people.**

**Power/Mate presents  
Econo/Mate II.**

**The open frame power supply.**

Now Power/Mate brings you 33% more power in the same package size with the second generation of our Econo/Mate series.

The size is the same, the basic components are the same for easy interchangeability. But that's where the similarity ends.

Econo/Mate II adds features like dual AC primary and a plug-in IC regulator for improved regulation.

And Econo/Mate II is tough. Computer design, quality control, and Power/Mate's experience helps insure 100,000 hr. MTBF even at this higher power output.

But for all its features, Econo/Mate II is still, most of all, economical.

We wouldn't call it Econo/Mate if it wasn't.

Econo/Mate II is in stock, ready for delivery. Send for our free brochure.

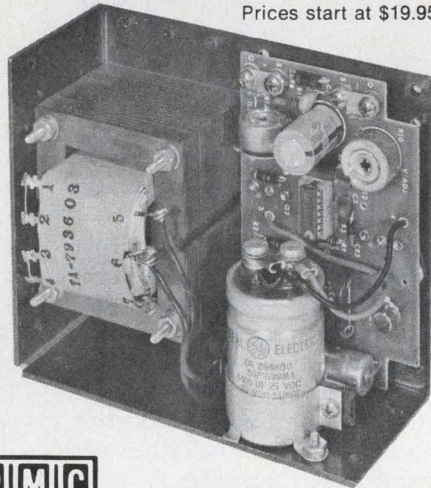

Prices start at \$19.95.



**POWER/MATE CORP.**

World's largest manufacturer of quality power supplies.

514 South River Street/Hackensack, N.J. 07601/Phone (201) 343-6294 TWX 710-990-5023

CIRCLE NUMBER 101

## IMC FAN FACTS

**Here's a fan with high performance for low-profile cooling**

The IMC PeWee Boxer fan delivers the highest available air flow for any unit of its size—up to 36 cubic feet of air per minute. The answer for cooling radio transmitters, tape decks, power supplies, 3" high relay rack panels etc. Well built for long life—varied designs. Literature on request! For immediate service please call Fred Taylor, Sales Manager at (603) 332-5300 or write.



60/50 HZ AIRMOVER



Our 25th Anniversary

**IMC MAGNETICS CORP.**

NEW HAMPSHIRE DIVISION

ROUTE 16B, ROCHESTER, NEW HAMPSHIRE 03867

CIRCLE NUMBER 102

## INSTRUMENTATION

**Chart recorder wears two hats**

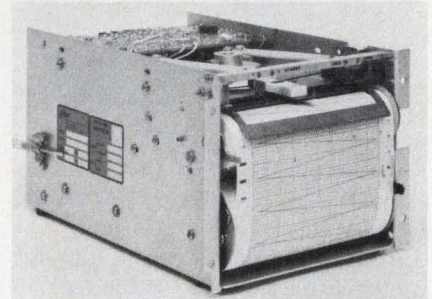

Gulton Industries, Gulton Industrial Park, East Greenwich, RI 02818. (401) 884-6800. About \$290.

Rustrak Model 500 series of servo chart recorders is available as both an OEM unit and as a laboratory recorder. A wide selection of sensitivities, chart speeds, and custom OEM packaging features are available. Calibrated chart width is 100 mm, and writing is accomplished by an easily changed fiber-tip cartridge, positioned by a null balance, potentiometric rotary servo motor. Sensitivity is 0 to 100 mV dc full scale with other sensitivities available.

Booth No. 2507-2509

Circle No. 372

**Calibrator offers remote or keyboard control**

United Systems Corp., 918 Woodley Rd., Dayton, OH 45403. (513) 254-6251. 3210, \$1795; 3220, \$1595.

Two precision calibrators join the company's HT Series (High Technology) instrumentation line. Model 3210 keyboard controlled unit and Model 3220 programmable unit are designed to function as both constant-voltage and constant-current sources. Model 3210 has a keyboard unit that replaces front-panel controls and permits operation from remote locations by semiautomatic testing systems. Model 3220 is designed for fully automatic systems and can be programmed to accept TTL BCD logic or other codes. Both models can supply precise voltage to  $\pm 200$  V and current to  $\pm 200$  mA.

Booth No. 2506, 2508

Circle No. 373

## Scope camera takes the pain out of printmaking

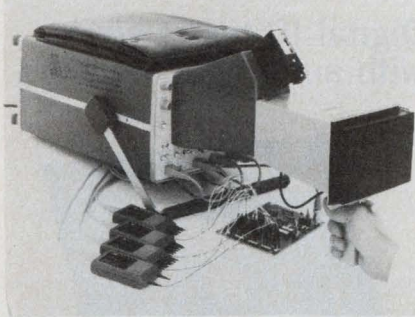

Hewlett-Packard, 1501 Page Mill Rd., Palo Alto, CA 94304. (415) 493-1501. \$250; 2-6 wks.

Model 124A is an inexpensive, easy-to-use oscilloscope camera. To use the 124A, place the camera hood over the scope bezel—no adapters needed—and press the trigger. The camera is prefocused and framed without adjustments. The f-stop is fixed, as is the shutter speed. An electronic flash, powered by two AA batteries, provides graticule illumination if the scope lacks it.

Booth No. 2201-2210

Circle No. 374

## Backplane tester handles 16,000 points



Teradyne, 183 Essex St., Boston, MA 02111. (617) 482-2700. \$15,000; 20 wks.

N123 is a bench-top tester for performing continuity tests on backplanes with up to 16,000 points, although it is usually most economical for units with fewer than about 5000 points. The self-contained unit includes a CRT display, a magnetic-tape-cartridge unit and a strip printer. The N123 is capable of self-learning an interconnection scheme and will find all wiring errors in a single pass.

Booth No. 1117-1124

Circle No. 375

## Scope offers built-in digitally delayed base

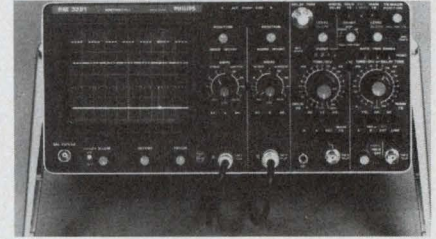

Philips Test & Measuring Instruments, 400 Crossways Park Dr., Woodbury, NY 11797. (516) 921-8880. \$2495; June.

A digitally delayed time base that enables accurate location of events in pulse trains is a key feature of the PM3261 oscilloscope. Other specs include: 120-MHz bandwidth, 3-ns rise time vertical amplifiers; main and delayed time bases with 5 ns/div maximum sweep speeds; clear front-panel design giving proven ease of operation; high-speed, high-sensitivity triggering beyond 200 MHz; and 20-lb weight, making the unit highly portable.

Booth No. 1033, 1037

1134, 1136

Circle No. 376

# KNOB KNOW-HOW

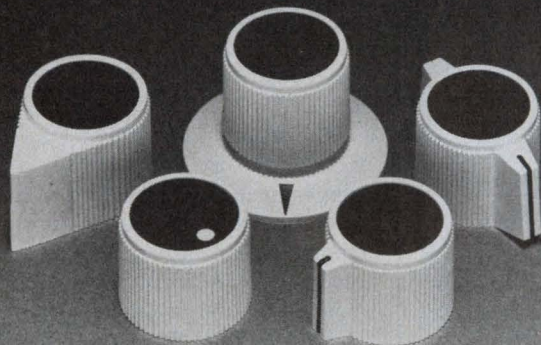

We know how to build quality and attractive styling into our knobs & dials. We've been doing it for more than 30 years.

**ROGAN CORPORATION**

Telephone (312) 498-2300  
3455 Woodhead Drive, Northbrook, Illinois 60062

CIRCLE NUMBER 103

ELECTRONIC DESIGN 10, May 10, 1976

MICROPROCESSOR SERIES NO. 3

## 2650 HIGHER LEVEL LANGUAGE SPEEDS YOUR DEVELOPMENT.



Available:  
(A) PL $\mu$ S  
Compiler for  
16- & 32-bit  
computers and on  
Time-share. (B) 16-  
& 32-bit Assemblers  
and Simulators.

Clip to letterhead.  
Send me quickly the 2650 Short  
Form Catalog including data  
sheets on the foregoing software.

Name  Title

Tel.  M.S.

811 E. ARQUES, SUNNYVALE, CA. 94086

THINK  
**Signetics  $\mu$ P**  
a subsidiary of U.S. Philips Corporation

CIRCLE NUMBER 104

149

## INSTRUMENTATION

### Digital IC tester works with automatic handlers

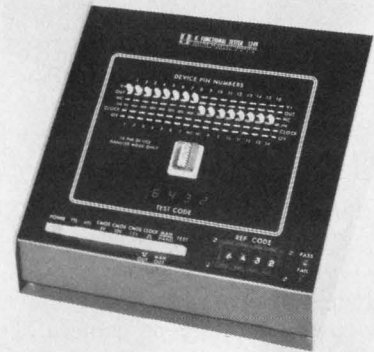

*Electro Scientific, 13900 N.W. Science Park Dr., Portland, OR 97229. (503) 646-4141. \$1195; stock-90 days.*

Model 1249 digital IC functional tester interfaces with automatic DIP handlers and offers selectable test voltages. The unit checks ICs in the DTL, TTL, HTL, and CMOS families without requiring a comparison device. A built-in test code comparator checks the test result against a preset nominal and signals the handler. A special feature is the selection of test voltages for CMOS devices. Three levels are offered: 5, 10 and 15 V.  
*Booth No. 2406     Circle No. 377*

### Digital scope stores signals

*Nicolet Instrument, 5225 Verona Rd., Madison, WI 53711. (608) 271-3333. \$6200 to \$7200; 90 days.*

The second generation EXPLORER digital oscilloscope uses an a/d converter to digitize the input signal and store it in a solid-state memory. The stored signal is then reconstructed through d/a conversion on the cathode ray tube (CRT). Since the signal is stored in memory, the waveform can be manipulated during or after recording for closer examination. Bandwidth is dc to 5 MHz (with 94A plug-in). Memory is 4096, 12-bit words, which can be used in halves or quarters for measurement, display or readout to peripherals.

*Booth No. 2414-2416*

*Circle No. 378*

## Data Display: YOUR Way



Ann Arbor makes over 1000 standard RO and KSR display terminal models. Alphanumeric. Graphics. Or both.

We also thrive on *tough* CRT display applications. Unique character sets. Unusual graphics. Difficult interfacing. Custom keyboards. Special packaging. You name it.

Standard or custom, *every* terminal produced is based on a field-proven Ann Arbor engineering concept. DESIGN III desktop terminals to complement any office decor. Compact, rugged Series 200 modular terminals that defy industrial environments. Or barebones board sets for OEMs who prefer to roll their own.

Many companies sell CRT terminals. But Ann Arbor sells creative solutions to CRT display problems, as well.

Probably at lower cost than anyone else in the business.

Contact us at 6107 Jackson Road, Ann Arbor, MI 48103. Tel: 313-769-0926 or TWX: 810-223-6033. Or see our catalog in EEM, Volume One.

**ANN ARBOR**  
TERMINALS, INC

*... creating new ways to communicate*

CIRCLE NUMBER 105



## Everything in Fail-Proof Digital Printers.



Used by the world's leaders including Anadex, Digitec, Doric, Esterline, etc.

Whatever your hard-copy need—alpha-numeric/digital printout; multi-copy; multi-color; ordinary calculator paper/pressure-sensitive tape; card, label, fan-folded forms, sales slip,—one of our 12 basic field-proven impact printers will suit you perfectly.

Products of Shinshu-Seiki, world-famous for a decade of reliability. Choose up to 21 columns, up to 42 characters/column, 3.4 lines/sec printing speed. Lowest sample prices. Phone Floyd Makstein, VP/Marketing or write . . .



**C. Itoh Electronics, inc.**  
SYSTEMS & COMPONENTS DIVISION  
280 Park Avenue, New York, NY 10017  
(212) 573-9466. Telex: WUD 12-5059

CIRCLE NUMBER 106

COMPONENTS

Multiple switches in DIP have 2 to 10 poles

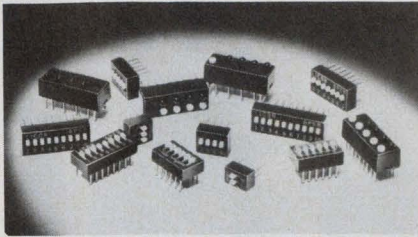

Licon, 6615 Irving Park Rd., Chicago, IL 60634. (312) 282-4040. From \$1.37 (1000-up); stock to 6 wks.

A slide-detent latching switch prevents accidental actuation and provides quick visual indication of open and closed positions. The switches are housed in DIPs and are available in 2 to 10 poles. The package measures 0.28 in. high and has a terminal spacing of 0.1 x 0.2 in. for PC board insertion. Optional snap-on dust covers are available.

Booth No. 1615-1617

Circle No. 379

Trimming capacitors fit tiny hybrids

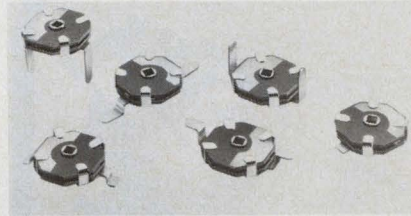

Johanson Manufacturing Corp., 400 Rockaway Valley Rd., Boonton, NJ 07005. (201) 334-2676. \$1.95 (1000 up); 2 wks.

The Johanson 9410 series trimming capacitors are now available in a variety of mounting configurations including stripline, strip-line-offset, PC and bottom-tuning types. Their small size, only 0.2-in. square and 0.045-in. thick, allow applications in tiny hybrid circuits such as in electronic-watch, crystal-oscillator and uhf-microwave applications. Capacitance values range from 1.0 to 4.5 and 7 to 45 pF and working voltages up to 250 V dc.

Booth No. 1236

Circle No. 380

Slide switches made without metal shells

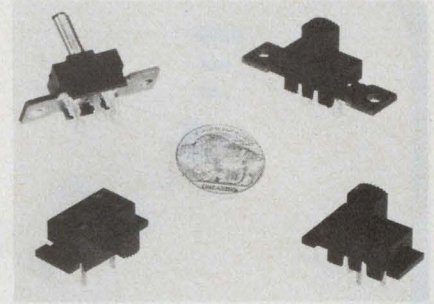

AMF Inc., UID Electronics Div., 4105 Pembroke Rd., Hollywood, FL 33021. (305) 981-1211. \$0.055 (OEM qty).

New shell-less sliding-contact switches, the SL series, offer less weight—50% of the weight of most slide switches is in the shell. The shell has been eliminated. Safety also is increased—the absence of a conductive shell is inherently electrically safer. Average mechanical life is 100,000 operations, and UL and CSA-rated switches are tested for 6000 operations.

Booth No. 1613

Circle No. 381

The Revolutionary  
**PowerDIP™**  
AC & DC  
**SOLID-STATE  
RELAYS\***

- Operate Directly from CMOS (500 µa control sensitivity)
- TTL/DTL Compatible (7 milliamp control current std. models)
- Switches up to 4 amps without heat sinking
- Fits standard 16 pin DIP sockets
- "Lockout" feature prevents false triggering by transient pulses



\*Patent Pending



and...  
**Less than \$3.00  
in Quantity**

**THETA-J RELAYS, INC.**

2 Linden Street • Reading, MA 01867  
(617) 942-0390

CIRCLE NUMBER 107

ELECTRONIC DESIGN 10, May 10, 1976

MICROPROCESSOR SERIES NO. 4  
**2650 SUPPORT CKTS  
ARE ALL  
MULTI-SOURCED.**

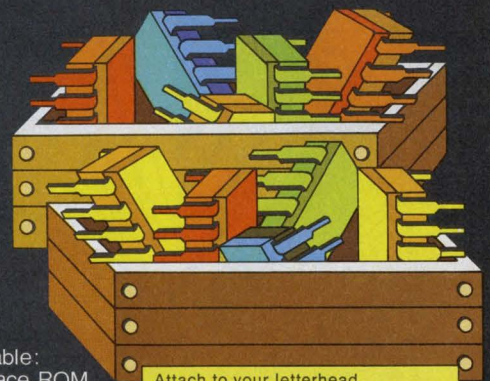

Available:  
interface, ROM,  
RAM, PROMs/  
EROMs. Coming:  
PPI, PCI, A-D  
Converters, SDLC.  
Specials from  
AMS, too.

Attach to your letterhead.  
Put me on your reservation list for  
the first mailing on upcoming 2650  
Interfacing Circuits.

Name \_\_\_\_\_ Title \_\_\_\_\_

Tel. \_\_\_\_\_ M.S. \_\_\_\_\_

811 E. ARQUES, SUNNYVALE, CA. 94086

**THINK**  
**Signetics µP**  
a subsidiary of U.S. Philips Corporation

CIRCLE NUMBER 108

COMPONENTS

Pressure transducers handle 10,000 psig

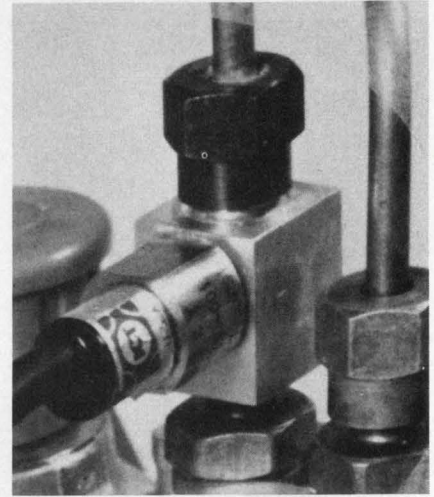

I. C. Transducers, Inc., 1750 Junction Ave., San Jose, CA 95112. (408) 998-8720. \$95 (1 to 9); stock.

The Series 750 solid-state pressure transducers are designed for very high pressure applications. It is claimed to be able to handle more than  $5 \times 10^9$  pressure pulses of 0 to 10,000 psig at 2400 pulses/min. A variation of the 750, the Series 900, features a flush-mounted diaphragm for measuring high frequency pressure phenomena. Outputs of the two series of transducers are 0-to-100-mV full scale. Other specifications include a repeatability of 0.05% FS, an excitation of 12 or 24 V ac; an over-pressure range of 200% and an operating temperature range of -40 to +250 F.

Booth No. 2601-2603

Circle No. 382

Chip capacitor adjustable 1 to 55 pF

Vitramon North America, P.O. Box 544, Bridgeport, CT 06601. (203) 268-6261.

A new version of the Vee Cal adjustable/fixed chip capacitor enables NPO parts users to add or subtract capacitance by connecting adjustment points, while retaining the integrity and stability of a fixed capacitor. The new VC2A has adjustment points on the top plane over a capacitance range of 1 to 55 pF in 0.5-pF steps. The chip measures  $0.12 \times 0.10$  in.

Booth No. 2424

Circle No. 383

## A New High in Stability

Centre Engineering has met the challenge of providing ultra-high reliable sub-miniature ceramic capacitors for the space programs. Now, design engineers in the tele-communications, computer and instrumentation industries can have ceramic capacitors in high volume for low cost applications, using the same processes and manufacturing techniques from Centre Engineering.

Ceramic capacitors are available in 40 various formulations with a capacity range of 1pf to 10mfd. For applications requiring large volume, low cost ceramic capacitors consider Centre Engineering. Catalog available upon request.

**CENTRE ENGINEERING**  
2820 E. COLLEGE AVE., STATE COLLEGE, PA. 16801  
814-237-0321 - TWX 510-691-2634

CIRCLE NUMBER 109

With *Vector* Cards, It's Easy To

# PICK A WINNER!

FROM OVER 100 "Off-the-Shelf" MODELS  
Plus Matching Terminals

LIKE OUR **NEW** 4066 SERIES LOGIC CARD

Model 4066-4, 4 1/2" x 6 1/2"  
For Wire Wrapping  
Has 3 Bus Planes  
Holds Up to 34 DIPs

3682-2  
3474  
3662  
3677-2  
838A

SPECIALS AVAILABLE

FOR MORE VECTOR EEM  
Vol. 1 pp. 100-103  
Vol. 2 pp. 358-363  
1058-1061  
GOLD BOOK Vol. 2 pp. 383,412

Send For New Data Sheets NOW

**Vector** ELECTRONIC COMPANY, INC.  
12460 Gladstone Avenue, Sylmar CA 91342  
(213) 365-9661 TWX 910-496-1539 37974

CIRCLE NUMBER 110

## PCB rotary switches come in many heights

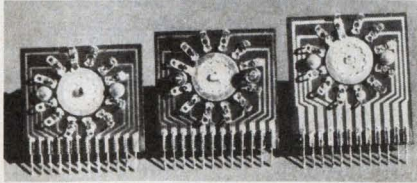

Standard Grigsby, Inc., 920 Rathbone Ave., Aurora, IL 60507. (312) 897-8417.

A line of PC-board rotary switches for perpendicular mounting includes the SM-PCB Series in profile heights of 0.625, 0.742 and 0.875 in. However, where space and height are a prime consideration, any variable in height between 0.625 minimum and 0.742-in. standard may be specified. The SK-PCB series is a slightly larger, lower-cost switch and is available in a mounting height of 0.875 in. All the switches are available as single or multideck assemblies and with levers. Circuit components can be added to individual switches to provide a complete switching system. Many options are available.

CIRCLE NO. 384

## Solid-state relays protected for shorts

Heinemann Electric Co., Magnetic Dr., Trenton, NJ 08602. (609) 882-4800. \$14.50 (100-up); stock.

A new line of solid-state relays, presently rated to 10 A at 120 and 250 V ac, is optically isolated, operates with an extended control-voltage range from 3 to 32 V dc and is TTL, DTL and MOS-logic compatible. To prolong life and increase reliability, the relays contain a built-in snubber network to protect against high dv/dt; fused output triacs protect against short circuits. Their operating range is -40 to 100 C with either zero-voltage or nonzero-voltage switching models. Actuation time is 9-ms max in the zero-voltage switching model, and 2-ms max in the nonzero-switching model. Release time is 8.3-ms max in both configurations. Isolation resistance is at least  $10^9 \Omega$ . The relays can handle a one-cycle nonrepetitive peak surge of 1000% of the relay's current rating.

Booth No. 2119

Circle No. 385

## 50- $\Omega$ attenuators fit BNC connectors

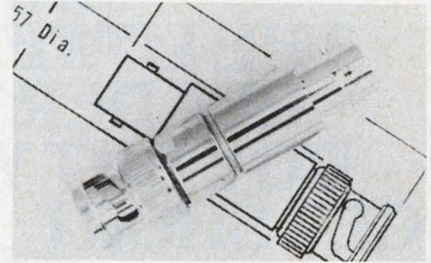

ITT Pomona Electronics, 1500 E. 9th St., P.O. Box 2767, Pomona, CA 91766. (714) 623-3463. \$24.95 (unit qty); 2 wk.

A BNC 50- $\Omega$  attenuator, Model 4108, for use with pulse, microwave or uhf instruments, has a female BNC on one end and male on the other. It has a nontarnish finish, Teflon insulation and gold-plated contacts. It is 1.97-in. long and 0.57 in. in diameter. Five different versions provide attenuation of 3, 6, 10, 14 or 20 dB. Attenuation tolerances run from  $\pm 0.4$  dB up to 1 GHz for the 3-dB unit;  $\pm 0.9$  dB to 8 GHz for the 20-dB unit.

Booth No. 1525

Circle No. 386

### NEW TENNEY Microprocessor Programmer

Here is a completely new, convenient way to control an environmental test chamber: tamper-proof microprocessor programmer does it the easy way. Replacing older types such as cam or punched tape devices, it is accurate, automatic and makes programming as simple as pushing buttons.

- Temperature and humidity set points • Transient time between set points • Dwell time at set points • Remote events • Auto shut down
- Competitively priced • May be retro-fit to existing equipment • Digital display of program

**Tenney**  
ENGINEERING, INC.

1090 Springfield Rd., Union, New Jersey 07083  
(201) 686-7870 • (212) 962-0332

746

Visit us at ELECTRO '76 Booth 1204  
CIRCLE NUMBER 111

MICROPROCESSOR SERIES NO. 5

## 2650 CRASHPROOF DEVELOPMENT SYSTEM: TWIN WITH DUAL FLOPPY DISKS.

TestWare INstrument (TWIN) lets you develop software and hardware together in an actual environment.

Clip to letterhead. Mail now. Please send me 2650 Short Form Catalog full data on TWIN.

Name _____	Title _____
Tel. _____	M.S. _____

811 E. ARQUES, SUNNYVALE, CA. 94086

**THINK**  
**SYNOPTICS  $\mu$ P**  
a subsidiary of U.S. Philips Corporation

CIRCLE NUMBER 112

# SAM<sup>®</sup> IS THE LOWEST PRICED READER YOU CAN BUY. BUT YOU DON'T GET SHORT CHANGED.

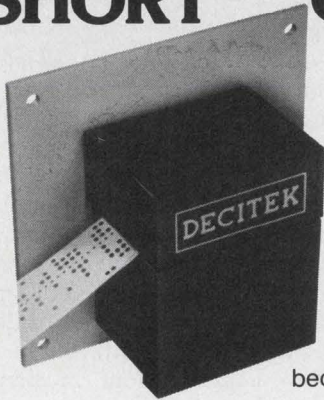

You could spend a lot more for a tape reader and still not get all of SAM'S quality features. SAM clips along at 300 cps, has our sure-footed dual sprocket drive and our state-of-the-art fiber optic light source and photo transistor read head. We can make SAM do all this *and* save you money because we do things differently.



This is the plain, brown wrapper SAM comes in.

The more you know about punched tape equipment, the better you read us.

## DECITEK

250 CHANDLER STREET, WORCESTER, MASSACHUSETTS 01602, U.S.A. (617) 798-8731

CIRCLE NUMBER 113

## MODULES & SUBASSEMBLIES

### Programmable display driver handles 8 colors

*Kinetic Systems, Maryknoll Dr., Lockport, IL 60441. (815) 838-0005, \$3850; stock.*

A complete programmable color display system (less the CRT display) is housed in two 2-unit width CAMAC modules. The Model 3232 system is a character oriented module set that generates an eight-color display on any red-blue-green, 525 line, raster scan CRT monitor. The system can handle a maximum of 2048 characters and inputs are available for a joystick, pushbuttons or a trackball to move the cursor. Each character can be any of the eight possible colors as can the space between characters.

Booth No. 2214-2216

Circle No. 387

### Data-acquisition system expands to 256 channels

*Micro Networks, 324 Clark St., Worcester, MA 01606. (617) 852-5400. See text.*

The MN7002 data-acquisition subsystem handles 16 single-ended analog channels or eight differential. The subsystem contains the multiplexer, sample-and-hold amplifier, control logic and 12-bit a/d converter on a 2.75 x 4.5-in. circuit card. Expansion of the system is possible up to a maximum of 256 channels. Each channel input has an impedance of 100 M $\Omega$ , minimum and can handle  $\pm 10$ -V common-mode. The over-all system linearity over the full 0-to-70-C operating range is within  $\pm 1$  LSB. Absolute accuracy of the system is  $\pm 0.5\%$  of full scale range, including zero error over the full range and the CMRR is 72 dB, minimum, for dc-to-1-kHz inputs. Crosstalk between channels is 80 dB (for a 1-kHz signal and adjacent off and on channels). Data can go through the system at a 40-kHz rate when the MN7002 operates in an overlap mode (new channel addressed while a/d converter is performing conversion on previous data). Price of the MN7002 starts at \$495 for 1 to 24 units. A MIL-temperature version—the MN7002H—is also available for \$865.

Booth No. 2005 Circle No. 388

## Balco

DIVISION

Capacitors for  
Time Circuits  
Delay Lines  
R. C. Oscillators  
Integrators

- Smallest Size
- Exceptional Performance
- Low Cost
- Fast Delivery
- Long Term Stability

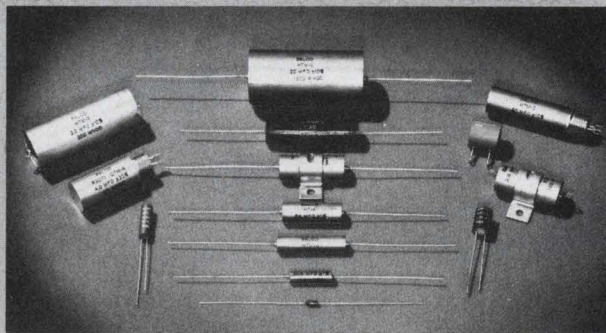

featuring Clear and Metalized Teflon<sup>®</sup> types.

	Extended Foil (RTWGX)	Metalized Film (RTWGMX)
Capacitance Range ( $\mu$ F)	0.0005 to 2.0	0.05 to 4.0
Working Voltage (Vdc)	50 to 600	50 to 600
Temperature Coefficient	$\pm 1.5\%$	$-90$ PPM/ $^{\circ}$ C $\pm 40$
DF at 25 $^{\circ}$ C and 1 kHz (%)	0.05	0.1
Operating Temperature Range ( $^{\circ}$ C)	$-55$ to $+175$	$-55$ to $+175$
Dielectric Absorption (%)	$<0.05$	$<0.05$
IR (Ohms)	$>1 \times 10^{12}$	$>1 \times 10^{11}$

Contact Custom for capacitors to suit your applications. Write for Brochure



**CUSTOM ELECTRONICS, Inc.**  
Balco Division  
4 Browne Street, Oneonta, N.Y. 13820  
Ph: 607-432-3880 TWX: 510-241-8292

CIRCLE NUMBER 114



## Programmable amps use 3-bit digital control

Preston Scientific, 805 E. Cerritos Ave., Anaheim, CA 92805. (714) 776-6400. See text.

Wideband programmable-gain amplifiers permit a 16-to-1 range of digitally selectable gain settings. The GMD-PG programmable amplifiers can be set to any of five pre-established gain levels of 1, 2, 4, 8 and 16. The GMD-PG requires a 3-bit digital control while the GMD-AGC has automatic gain ranging and a 3-bit digital output code for data logging. Gain accuracy for either unit is  $\pm 0.01\%$  and the gain stability is  $\pm 0.01\%$ . Both amplifiers have a gain tempo of 10 ppm/ $^{\circ}\text{C}$  and a linearity of  $\pm 0.01\%$ . Also, both amplifiers have a 20  $\mu\text{s}$  settling time for the output to reach within 0.01% of its final value after a gain change and only 10  $\mu\text{s}$  if there is no gain change. The GMD-PG costs \$395 and the GMD-AGC \$1045. Delivery of either model (with an a/d conversion system) is 10 to 12 weeks.

Booth No. 2304, 06, 08, 10, 12

Circle No. 389

## Thumbwheel switch includes counter/timer

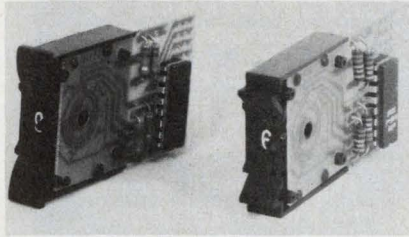

International Microtronics, 4016 E. Tennessee St., Tucson, AZ 85714. (602) 748-7900. \$7.50 (TTL); \$9.50 (CMOS); stock to 2 wks.

A counter-timer switch consists of a thumbwheel switch with a decade counter (SN7490 or MM74C90) built-in. It accepts a train of pulses and when the counter's content equals the number displayed on the thumbwheel switch an "equal" output is generated. Any number of switches can be cascaded to form a multi-decade counter-timer. The units have provisions for clock-in, reset, carry, equal-out and preset. Both front (SF) and rear (SR) mount models are available with either TTL or CMOS compatible logic.

CIRCLE NO. 390

## Synchro-to-BCD modules offer scale adjust

Computer Conversions, 6 Dunton Ct., East Northport, NY 11731. (516) 261-3300. \$375 (large qty.); 4 wks.

A series of three or four-decade, synchro-to-BCD-converter modules is available with a choice of scale factor. The modules measure  $2.6 \times 3.1 \times 0.82$  in. and are designed for PC board mounting. They convert synchro or resolver inputs of 11.8 or 90 V, 400 Hz or 90 V, 60 Hz into three or four-decade BCD data, representing angle with an accuracy of  $\pm 6$  or  $\pm 30$  minutes of arc. Unipolar and bipolar ( $\pm 180^{\circ}$ ) models are available. The converters have isolated reference and synchro inputs and an optional zero-offset adjustment. The digital outputs are DTL/TTL compatible and bidirectional input data are accepted. Model SBC40 requires a 26 or 115-V, 400-Hz ac reference input, +15 V dc at 40 mA and +5 V dc at 600 mA, max. Operating temperature ranges are 0 to +70 C or -55 to +85 C.

CIRCLE NO. 391

# SP-G10, H-10 SPEEDEX RECORDER

3 different power supplies available!!



G10...one pen  
H10...two pen

### FEATURES

1. High sensitivity. Switchable from 0.5mV/250mm full scale to 500V in 12 steps.
2. 3 different power supplies.
  - a) Internal battery
  - b) AC power line (110, 220V 50/60Hz)
  - c) External 12V power supply
3. Easy to operate.
4. Durable plastic potentiometer.
5. All solid-state circuitry.
6. Pulse motor chart feed also permits chart feed by external pulse. Chart can be freely wound and un-wound.

• Please write us on your letterhead for detailed information.

**Riken Denshi Co., Ltd.**

5-5-2, Yutenji, Meguro-ku, Tokyo, Japan. TEL: 711-6656 TELEX: 0246-8107

CIRCLE NUMBER 115

ELECTRONIC DESIGN 10, May 10, 1976

MICROPROCESSOR SERIES NO. 6

## 2650. APPS ENGINEERS: IN STOCK NOW.

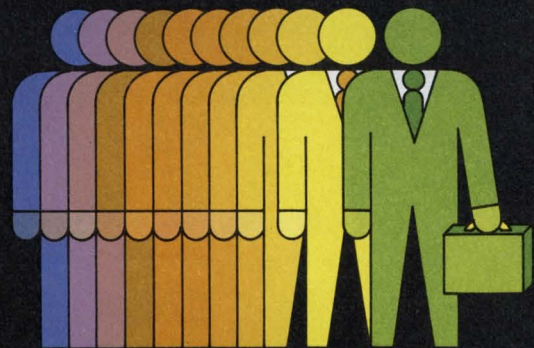

Dozens of people to support systems, hardware, testware, devices in USA and Europe. More coming.

Attach to your letterhead. Mail. Send me the list of 2650 Applications Engineers with addresses & phone numbers.

Name \_\_\_\_\_ Title \_\_\_\_\_

Tel. \_\_\_\_\_ M.S. \_\_\_\_\_

811 E. ARQUES, SUNNYVALE, CA. 94086

THINK

# Signetics $\mu\text{P}$

a subsidiary of U.S. Philips Corporation

CIRCLE NUMBER 116

155

## Understand Noise and Vibration Better:

# MAGNIFY SPECTRUM DETAIL

with EXPANDABLE Real-time FFT Analyzer Mini-Ubiq 440A with first built-in translator

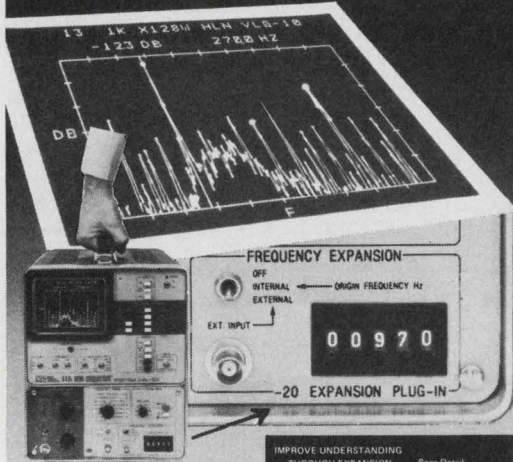

New Expansion Plug-in (-2 Option) magnifies frequency spectrum detail up to 400:1 by separating closely spaced frequency peaks with resolution as fine as .125 Hz; expands 20 kHz coverage to 100 kHz. Any one analysis band—50 Hz, 100 Hz, 500 Hz, 1 kHz, or 2 kHz—can be positioned in 10-Hz steps to 100 kHz. Extra plug-in cards provide any of the other ranges.

Mini-Ubiquitous® annotated display "remembers" control settings for complete Polaroid photo records (also plots). Time function is viewed and plotted providing transient recorder capability.

Nicolet Instrument Ltd.  
80A Emscote Road  
Warwick, Warwickshire, Gr.Br.  
Tel: Warwick (0926) 44451.  
Telex: 851311135

Nicolet Instrument GmbH  
605 Offenbach am Main  
Goerdelerstrasse 48, W.Ger.  
Tel: 0611/852028  
Telex: 8414185411

**NSC NICOLET SCIENTIFIC CORP**  
(formerly Federal Scientific)

245 Livingston Street, Northvale, NJ 07647. Tel: (201) 767-7100. Telex: 710-991-9619.

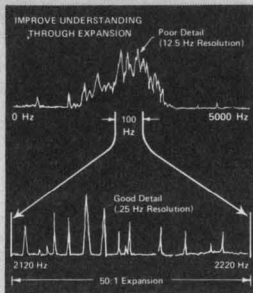

CIRCLE NO. 392

Send Lit. only, circle 261. For Demo, circle 262.

## Two-Tone SSB RF Test Set

Model 315 combines two Model 925 RF Signal Generators having "Signallock" with a Model 210 Signal Combiner, resulting in a two-tone test set with unsurpassed stability from 50 kHz to 80 MHz. Signal level of each tone or combined tones is adjustable from 0.1  $\mu$ v to 2 volts with  $\pm 10$  Hz stability. Signal spacing is from 100 Hz to almost 80 MHz. Intermodulation distortion is 60 dB down at full output; better at lower outputs. Write or call today for complete specifications and pricing.

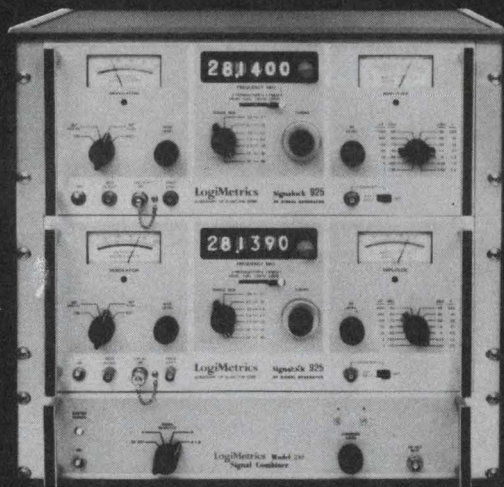

**LogiMetrics**

121-03 Dupont Street, Plainview, New York, 11803. (516) 681-4700/TWX: 510-221-1833  
RF Signal Generators, Frequency Synthesizers, Traveling Wave Tube Amplifiers

CIRCLE NUMBER 118

## MODULES & SUBASSEMBLIES

### Log amp accepts bipolar input signals

Burr-Brown, International Airport Industrial Park, Tucson, AZ 85734. (602) 294-1434. 100-up prices; \$26 (4127J); \$31 (4127K); stock.

The 4127 hybrid log amp accepts input signals of either polarity. It has a wide dynamic range—up to six decades of current and four decades of voltage. The unit is available with initial accuracies (log conformity) of 0.5% full scale (4127K) or 1% full scale (4127J). It operates over an ambient temperature range of  $-10$  to  $+70$  C and is housed in a ceramic DIP that measures only  $1.4 \times 0.8 \times 0.25$  in.

### MIL-spec converters offer wide choice

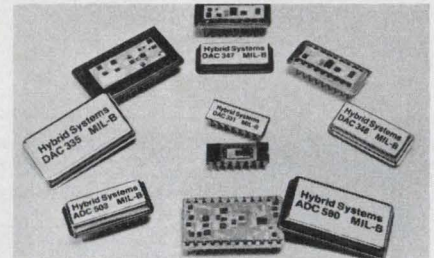

Hybrid Systems, Crosby Dr., Bedford Research Dr., Bedford, MA 01730. (617) 275-1570. From \$49 (1 to 9); stock to 8 wks.

A family of over 20 hybrid data conversion devices is designed to meet full MIL-STD-883 specifications. Included are general-purpose d/a converters, multiplying a/d converters, sample/hold amplifiers and multiplexers. Converter resolution ranges from 8 through 12 bits. All of the converters are processed to class B or C requirements of MIL-Standard 38510. The family includes: 8, 10 and 12-bit multiplying DACs (DA331 and 348 series); 10 and 12-bit general-purpose DACs (DAC335 series); 10 and 12-bit low-power DACs (DAC347 series); 8, 10 and 12-bit successive-approximation a/d converters (ADC503 and 580 series); a fast sample-and-hold amplifier (SH702); and an 8-channel analog multiplexer (MUX202).

Booth No. 1523 Circle No. 393

## DISCRETE SEMICONDUCTORS

### LED indicators offer versatile mounting

Data Display Products, 5428 W. 104 St., Los Angeles, CA 90045. (213) 641-1232. \$0.79 (1000 up); stock to 4 wks.

Packaged for vertical or horizontal viewing, the PCV-200 and PCH-200 series of LED indicators are available with T-1-3/4 cases and clear-tinted or diffused encapsulation. Three colors are available, of which only the red can be purchased with built-in resistors for 5-V applications. For applications that require a smaller package, the PCX125 series of LEDs is available, in T-1 diffused cases. In addition, other types, such as the PCL units, have an elongated horizontal package for greater mounting stability, while the PCO series has a horizontal package with offset, bent terminals. All diodes in these series are rated at 50 mcd at 20 mA (typical red, with clear-tinted encapsulation).

Booth No. 2119-21 Circle No. 510

### SCR power modules deliver 110 A at 1200 V

Gentron Corp., 6667 N. Sidney Pl., Milwaukee, WI 53209. (414) 351-1660. \$50 (100-up); 3 to 4 wks.

The 5100 series of Powertherm power control modules handles 1200 V at 110 A. Two basic circuits are available: an anti-parallel SCR circuit, and SCR and diode arrangements. The modules have a thermal resistance of 0.4 C/W, maximum.

CIRCLE NO. 511

### Germanium transistors handle currents to 35 A

Germanium Power Devices, P.O. Box 65, Shawsheen Village Station, Andover, MA 01810. (617) 475-5982. See text.

The 2N1520 and 2N1521 pnp germanium transistors can handle 35 A at up to 80 V. The devices are housed in TO-36 packages and cost from \$3 to \$5, depending upon quantity. Delivery is four weeks.

CIRCLE NO. 512

### LED lamps can replace T-1-3/4 incandescents

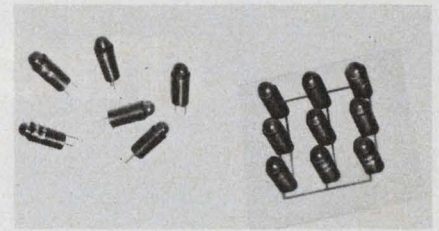

Dialight, 203 Harrison Pl., Brooklyn, NY 11237. (212) 497-7600. For 1000-up quantities: \$0.54 (without resistor); \$0.69 (with resistor); stock.

Developed as a direct replacement for the T-1-3/4 incandescent lamp, the series 549 Bi-Pin LEDs come in two models. One has an integral resistor for direct use at 5 V and 16 mA, and the other, a 1.7-V unit, requires an external series resistor that makes possible a wide range of operating voltages and currents. Pins are molded into the black plastic case, which has a flat for indexing to establish correct polarity. Terminations are 0.025-in.-square leads with gold plating.

CIRCLE NO. 513

#### ABSOLUTELY

the world's most accurate rulings using vacuum deposit chrome, etch and fill or emulsion processes. They're produced on the world's largest 1 micro inch numerically controlled ruling engine with interferometric feedback controls. Need precision scales, grids, slits, reticles, Ronchis numbers, letters, circles, dots, or nickel mesh? We stock many items for immediate delivery. Send for brochure No. 38-36.

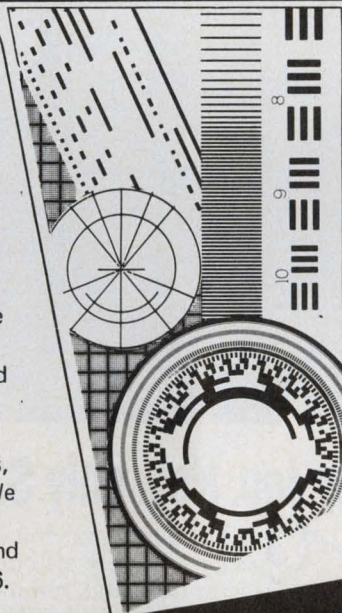

**SCALES RULINGS RETICLES & GRIDS FROM THE WORLDS LEADING SCALE MAKERS.**

**MICRO-LINE**  
DIVISION OF  
**BAUSCH & LOMB**

JAMESTOWN, NY 14701 716/488-1958

CIRCLE NUMBER 119

MICROPROCESSOR SERIES NO. 7  
**BY SEPTEMBER  
THE 2650 IS OVER  
30% FASTER.**

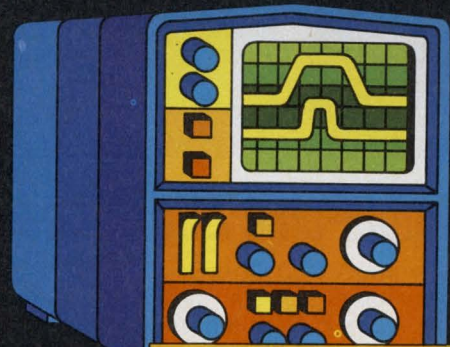

Your system's features can be extended with the speedier 2650. Current 2650 software will apply.

Clip to your letterhead. Put me on your reservation list for the first mailing of the faster 2650 data sheet.

Name \_\_\_\_\_ Title \_\_\_\_\_

Tel. \_\_\_\_\_ M.S. \_\_\_\_\_

811 E. ARQUES, SUNNYVALE, CA. 94086

THINK

**Signetics  $\mu$ P**  
a subsidiary of U.S. Philips Corporation

CIRCLE NUMBER 120

# The easiest-to-use microprocessor

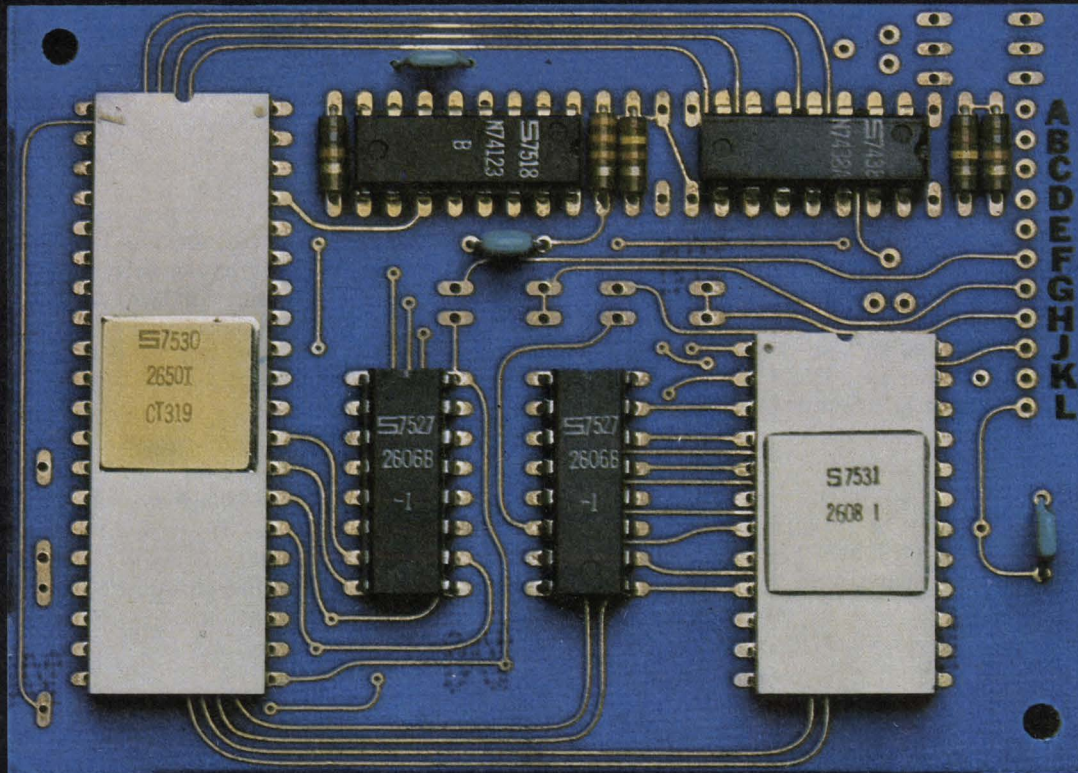

(Photograph approximately 2x actual size.)

## The single-chip 2650 is easiest-to-buy, too. Now only \$21.50 (100-up).

Full support of customer and product is the key to ease of development with the 2650. Applications engineers in the U.S. and abroad are at your beck and call at every stage. Software for almost anyone's requirements and machines. Development hardware is versatile and inexpensive. All circuits are multi-sourced.

**Flow Chart: How to travel safely and quickly from spec sheet to your  $\mu$ C.**

- 1 Applications Engineers — in the field now, more coming. Specific assistance to you is available around the USA, and in Belgium, Holland, Germany, France, Sweden, Britain, Italy, etc.
- 2 Multi-sourced 2650 — available in any quantity from Signetics, at the unprecedented low price of \$21.50. Also available from AMS and Philips, and from Signetics' authorized distributors.

- 3 Development Software — includes the PL  $\mu$ S, an extremely efficient High Level Language (compiler) that reduces programming effort and cuts development time. ANSI standard Fortran IV executes on most machines without alteration. 2650AS1000/1100 Assembler and 2650SM1000/1100 Simulator are available in both 32- and 16-bit, on GE and NCSS time-sharing.

- 4 Multi-sourced Support Circuits — You'll need MOS and/or Bipolar Memories, Interface and Logic. Signetics has *everything* for a complete system. Back up any item from other sources. Coming soon from Signetics are: Programmable Peripheral Interface and Communications Interface, A-D Converters, Synchronous Data Link Controller, 16k NMOS & Bipolar ROMs, 4k & 8k NMOS EROMs, and 8k Bipolar PROMs.

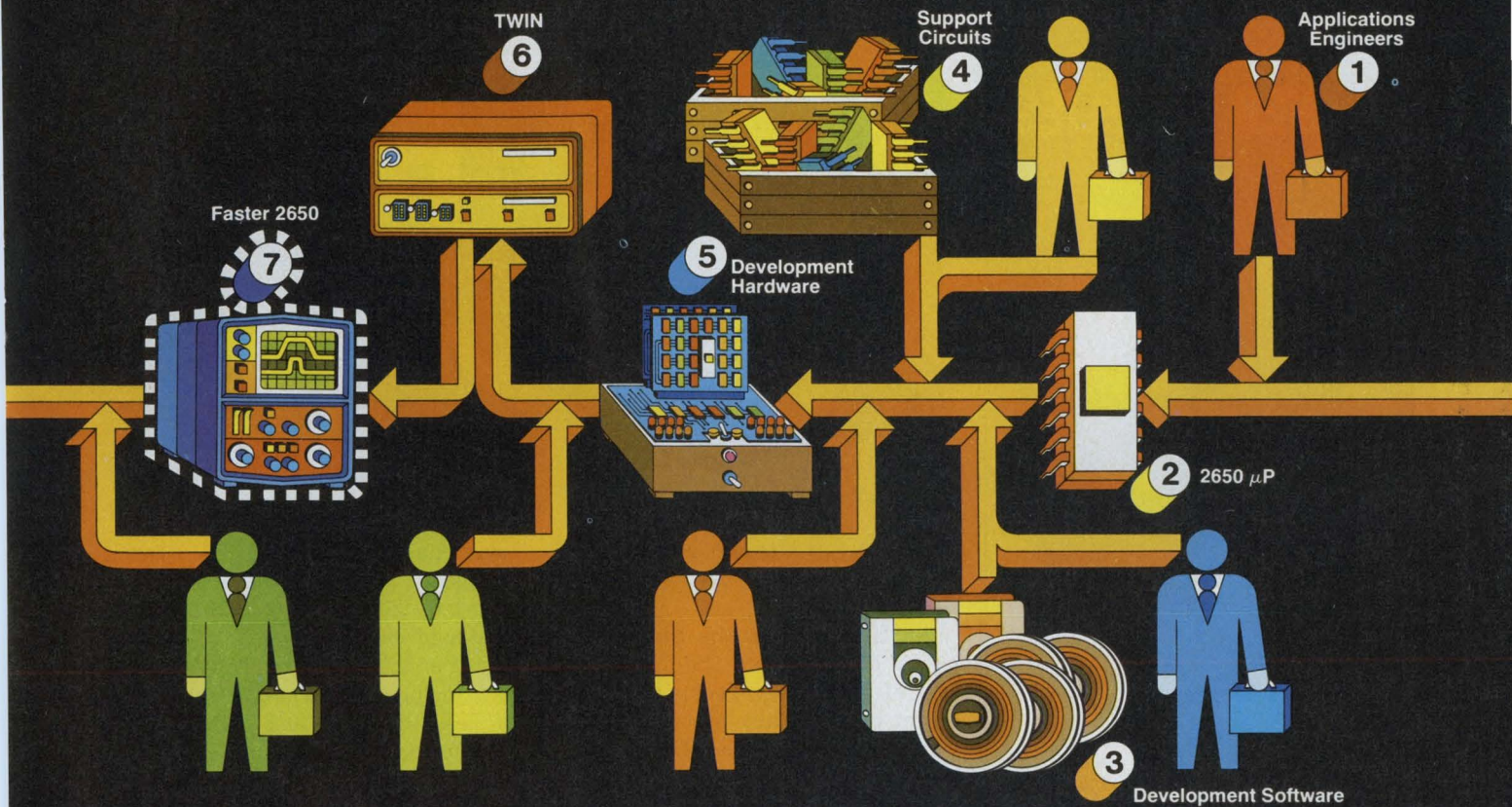

# makes the easiest-to-develop microcomputer.

**5** Development Hardware — Design/develop/prototype with a variety of cost/capability levels of hardware support. Including prototyping cards and kits, smart typewriter demo card, 4k-byte RAM card, and more. Applications help if you need it.

**6** TWIN With Floppy Disks — “crashproofs” your system checkout. With DOS, Resident Assembler, and Text Editor. You develop programs and circuits together in an actual system environment with TWICE (*TestWare In Circuit Emulator*). PROM programming, too.

**7** Over 30% Faster 2650 — By the time you’ve proven out your  $\mu\text{C}$ , you’ll have available a faster 2650 if you want it. Uses the same software. For still higher speeds, call Signetics Bipolar Microprocessor Marketing about our 2650 emulator using 3000 series  $\mu\text{P}$ .

You go from gleam-in-your-eye to proven prototype in less time for less cost, and the  $\mu\text{C}$  you develop is easier and cheaper to produce in quantity, when you start with the 2650. Start now by mailing the coupon.

Attach this to your letterhead for fast response.

Send me complete 2650 short form catalog.

Have a Field Applications Engineer call me for appointment.

My need is:  immediate  6 months  information only

My application is \_\_\_\_\_

Name \_\_\_\_\_ Title \_\_\_\_\_

Telephone \_\_\_\_\_ Mail Stop \_\_\_\_\_

THINK **Signetics  $\mu\text{P}$**   
a subsidiary of U.S. Philips Corporation

811 E. Arques Ave., Sunnyvale, Ca. 94086

# JOIN THE REVOLUTION AGAINST CUSTOM POWER SUPPLIES



Now is the time to put an end to high cost custom power supplies . . . and the long lead times they require. Join the Arnold Magnetics "Design-As-You-Order" revolution. Choose from over 1200 miniaturized off-the-shelf input and output submodules to meet your specific needs. Save time, save space, save money . . . and get outstanding performance.

- Single or dual inputs: 115-220 VAC, 47-500 Hz, 12, 18, 48, 115, 150 VDC.
- Multiple isolated and regulated DC outputs from 4.2 to 300 VDC.
- Line & load regulation to 0.1%.
- Up to 800 watts per output.
- Efficiencies to 85%.
- Completed units provided in tested and encapsulated, conduction cooled packages.

Phone or write for your "Declaration Of Non-Dependence" (our new Catalog and Specification Form) on custom power supplies . . . join the revolution today!



## ARNOLD MAGNETICS CORPORATION

11520 W. Jefferson Blvd.  
Culver City, Ca. 90230 ● (213) 870-7014

CIRCLE NUMBER 122

## POWER SOURCES

# Ac source regulates output as both line and load change

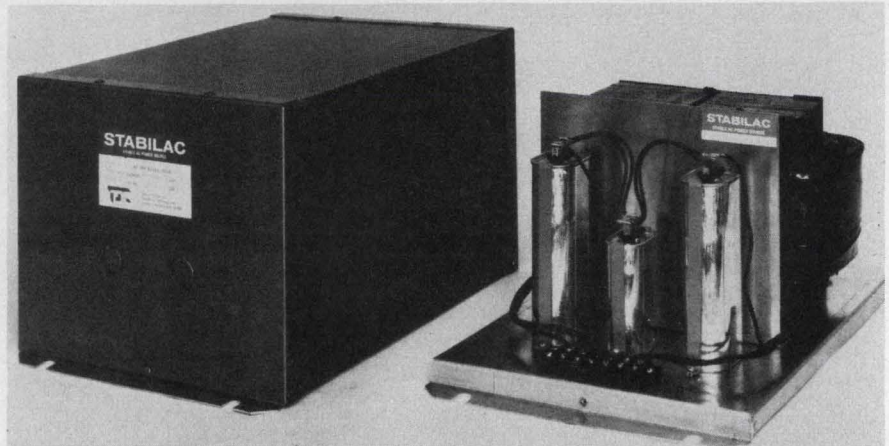

TDC Div., Whitcomb Ave., Littleton, MA 01460. (617) 456-3374. See text.

At first glance, the Stabilac ac power source, from the TDC division of Frequency Technology Inc., might look like any other constant-voltage transformer (CVT). But look further:

The Stabilac delivers up to 50 kVA. The CVT can't.

The Stabilac gives good regulation under simultaneous line and load variations. The CVT doesn't.

The Stabilac isolates the load from the line and suppresses input spikes. Not the CVT.

And if these aren't enough, the Stabilac is said to be 20 to 40% smaller, lighter and less expensive than a CVT of equal power rating. Surprisingly, the Stabilac is passive; it uses no electronic feedback or SCRs to maintain the output voltage.

How well does it regulate? Output stays within  $\pm 2\frac{1}{2}\%$  from no load to full load with a simultaneous line-voltage change of  $\pm 15\%$ . If the line remains constant, a no-load-to-full-load swing affects the output by  $-3\%$ . Or, with constant load and input variations of  $\pm 10\%$  or  $-20\%$ , regulation is  $\pm 1\frac{1}{2}\%$ . Note: these are all typical figures.

You also get some regulation during short-term (15 min or less) overloads. The voltage drop during

overload ranges from 6% (for a 1/2-load to 150% full-load variation) to 25% for 1/2-load to 250% full-load change.

Other key specs of TDC's Stabilac include a harmonic distortion of less than 5% and efficiency of better than 80% at full load. (Another version offers a square-wave output for subsequent rectification.)

Although the Stabilac's spec sheet doesn't list a figure for isolation or fully characterize the noise-suppression capabilities, it does state that "over 95% of a 500-V spike superimposed on a 230-V line will be filtered out."

Both single and three-phase models are available, in ratings ranging from 0.25 kVA to 50 kVA (1  $\phi$ ), and 6 to 150 kVA (3  $\phi$ ). Primary and load voltages are 120, 240 or 480 V, depending on the model. Some units offer more than one output winding.

Typical weights and prices are as follows: In the single-phase Stabilacs, which are of open construction, the 0.5-kVA model weighs 18 lb and sells for \$155; the 20-kVA unit weighs-in at 470 lb and costs \$1740.

The 3- $\phi$  models come in a metal cabinet. Representative weights range from 235 lb for 6 kVA to 1500 lb for 60 kVA. Prices are \$1330 and \$5190, respectively.

CIRCLE NO. 303

## New! Model 640 Low Cost\* Loader Reads 350 Characters per Second

All solid state photo-electronic components.  
Reads all standard 5,6,7 or 8 level tapes.  
Smooth, quiet, AC drive.

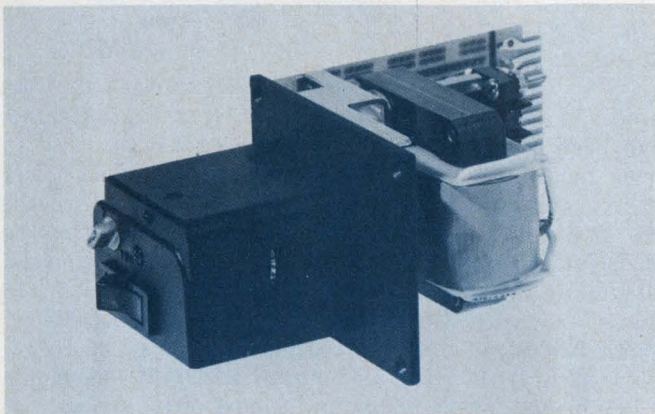

Provides reliable, high speed data entry. Data amplifiers and "character ready" output available for CMOS or TTL interfaces. Fanfold box available.

The Model 640 is the newest addition to the Addmaster line of quality paper tape equipment.

\*only \$151! (1-49 units; substantial quantity discounts available.

Addmaster Corporation, 416 Junipero Serra Drive, San Gabriel, California 91776. Telephone: (213) 285-1121.

CIRCLE NUMBER 123

# GROWING PAINS?

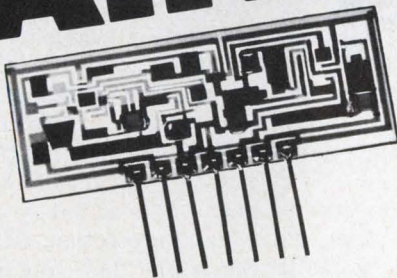

Consider shrinking your product instead of increasing the size of your facility. Converting to hybrids can improve efficiency, reliability and cost. Let us tell you how.



**NORTH MICROSYSTEMS**  
DIVISION OF NORTH ELECTRIC  
A UNITED TELECOM COMPANY

1150 N. W. 70 ST. FORT LAUDERDALE, FLA. 33309  
PHONE (305) 974-5400 — TWX 510 - 956-9897

CIRCLE NUMBER 124

ELECTRONIC DESIGN 10, May 10, 1976



## Nurl-Loc<sup>®</sup> ...4-way problem solver

**Warp** ... only the patented Nurl-Loc<sup>®</sup> design, with 500% more gripping surface, eliminates panel warp by spreading stress.

**Spin** ... gear-locking action guaranteed not to rotate during wrapping.

**Tear** ... replace terminals up to 3 times without tearing or crazing panel.

**Snap** ... no brittle pins to break. Accurate true position without pin straightening.

Interested? Call Allan Klepper (401) 769-3800 or contact Electronic Molding Corp., 96 Mill Street, Woonsocket, Rhode Island 02895.

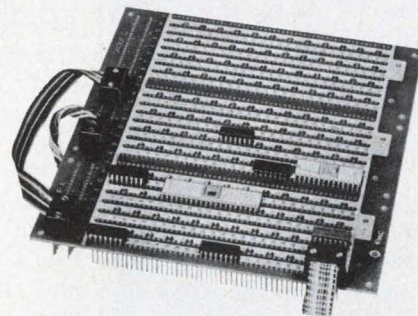

**EMC**  
Interconnection Specialists

CIRCLE NUMBER 125



now you have  
a choice!

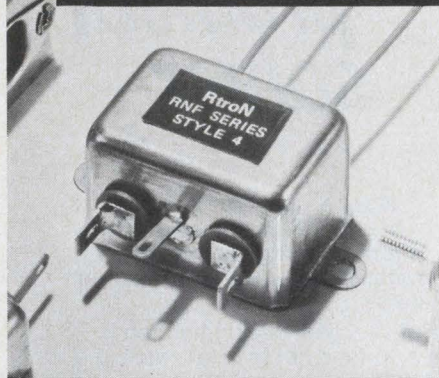

## RFI/EMI FILTERS

For Data Processing,  
Industrial Control and  
Instrument Application

Rtron's RNF Type Filters represent three series of the most widely used, low cost filters available. Over 100 combinations of current and case style to choose from. "L" Series - low cost for general applications to combat line to ground noise. "P" Series - for suppression of line to line as well as line to ground interference. "T" Series - most effective for low impedance load applications. All types are U.L. Recognized and meet C.S.A. requirements. Rated at 115/250 VAC. Low leakage current insures safety.

For complete catalog and  
details, write:

**Rtron** Corporation  
P.O. Box 743, Skokie, Illinois 60076  
(312) 679-7180

CIRCLE NUMBER 126

## POWER SOURCES

### Converters come in various configurations

*Bikor Corp., 1228 253rd St., Harbor City, CA 90710. (213) 325-2820. Price starts at \$127.00; stock to 3 wks.*

Three new families of power supplies are being unveiled by the company. DDU Series consists of 48 models and are dc-to-dc unregulated converters for voltage transformation and isolation. Input and output voltages available are 12, 24, 48 and 110 V dc with a choice of 48 through 220 W of output. Ripple is 0.5% max. DDR Series consists of 136 models of dc-to-dc regulated converters, and the ADR Series of 34 models of ac-to-dc regulated converters. Both series offer linear or switching regulators with 0.2% regulation and 0.3% max ripple. Single through four-output models are standard. Input voltages available are 12, 24, 48 and 110 V dc and 115 V ac, 50 to 400 Hz. Outputs range from 5 through 250 V dc with up to 180 W per output. Over-voltage protection is optional.

*Booth No. 2515 Circle No. 514*

### Dual-output units deliver up to 120 W

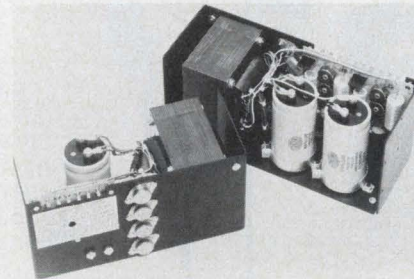

*Abbott Transistor Labs, 1224 Anderson Ave., Fort Lee, NJ 07024. (201) 224-6900. \$62 to \$119; stock.*

This OEM "LC" series converts 115 V ac, 47 to 420 Hz to dual outputs of 5, 12, 15, 24, 28,  $\pm 12$ ,  $\pm 15$  V dc. These models can deliver 15, 30, or 60 W per output. Line and load regulation are less than 0.1%, and ripple is 10 mV rms, 30 mV pk-pk. Full output power is available up to 50 C with no derating, forced-air cooling, or heat sinking needed.

*Booth No. 2112 Circle No. 515*

### Frequency converters shrink in size

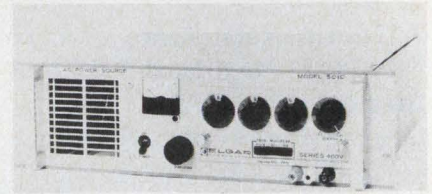

*Elgar, 8225 Mercury Ct., San Diego, CA 92111. (714) 565-1155. Model 501, \$1050; 4 wks.*

The new "C" series of ac power sources is said to be one-third the size and one-half the weight of the company's conventional ac sources. Typical "C" series specs are 115 V ac or 230 V ac, 50 or 60-Hz input; 115, 230 or 26 V ac, 45-Hz-to-10-kHz output with 0.5% harmonic distortion. Model 501C is rated at 500 VA, is 5.25 x 19 x 17 in. in measurements and weighs 60 lb.

*Booth No. 2713 Circle No. 516*

### Supplies aim at floppy-disc drives

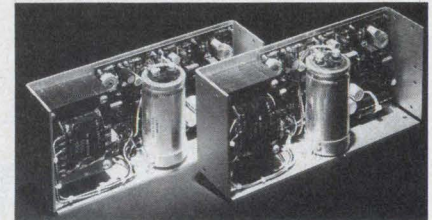

*Power-One, 531 Dawson Dr., Camarillo, CA 93010. (805) 484-2806. \$120; stock-2 wks.*

This new series is designed to power floppy-disc drive systems, including controller/formatter circuitry, from manufacturers such as Perteq, Diablo, CDC, Shugart, etc. First to be offered in the series is Model CP-162, a triple-output unit capable of powering two individual systems simultaneously. Outputs are 24 V at 5 A, 5 V at 3 A, and -5 V at 0.6 A, all with over-voltage protection. Of special interest is the 24-V regulator, capable of delivering up to 6-A output current for 500 ms upon initial system power-up. Following power-up, 5 A is available on a steady-state basis. Standard features include 115/230 V ac input, built-in overload and overvoltage protection,  $\pm 0.05\%$  regulation, and remote sensing. Maximum ripple is 1.5 mV pk-pk, and transient response is specified at 30  $\mu$ s for a 50% load change.

*Booth No. 1619 Circle No. 517*



# The IMSAI 8080.

## A commercial yet personally affordable computer.

If you thought you could never afford a computer at home, think again. The IMSAI 8080 is built for rugged industrial performance. Yet its prices are competitive with Altair's hobbyist kit. Fully assembled, the 8080 is \$931. Unassembled, it's \$599.

The IMSAI 8080 is made for commercial users, and it looks it. Inside and out. The cabinet is attractive, heavy gauge aluminum. The heavy duty lucite front panel has an extra 8 program controlled LED's. It plugs directly into the Mother Board without a wire harness. And rugged commercial grade paddle switches are backed up by reliable debouncing circuits.

The system is optionally expandable to a substantial system with 22 slots in a single printed circuit board. And the durable card cage is

made of commercial-grade anodized aluminum.

The IMSAI 8080 power supply produces a true 28 amp current, enough to power a full system. You can expand to a powerful system with 64K of software protectable memory plus an intelligent floppy disk controller. You can add an audio tape cassette input device, a printer plus a video terminal and a teletype. And these peripherals will function with an 8-level priority interrupt system. BASIC software is available in 4K, 8K and 12K.

Get a complete illustrated brochure describing the IMSAI 8080, options, peripherals, software, prices and specifications. Send one dollar to cover handling to IMS. The IMSAI 8080. From the same technology that developed the HYPERCUBE Computer architecture and Intelligent Disk systems.

Dealer inquiries invited.

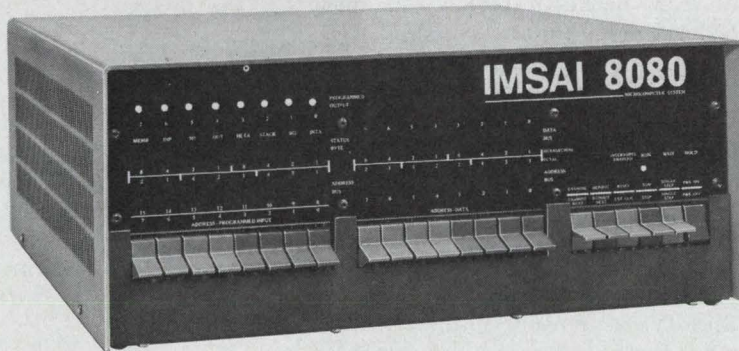

# IMS

**IMS Associates, Inc.**  
14860 Wicks Boulevard  
San Leandro, CA 94577  
(415) 483-2093

Dept. ED-5

CIRCLE NUMBER 127

## QUICK-CONNECT BLOCKS

*With Infinite  
Design  
Possibilities*

There's an Underwriters Terminal Block for virtually any design requirement you have or can conceive.

No other line offers a wider selection of blocks and variations of in-block circuitry. Any number of terminations. Wide choice of configurations. Most are UL recognized and CSA certified. Blocks in kit form, too. Also special designs and hot-stamped coded blocks.

*Request bulletin.*

## Underwriters Safety Device Company

7300 W. Wilson Ave., Chicago, Ill., 60656 • 312-867-4600

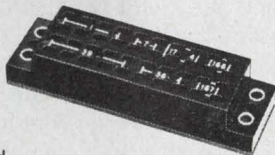
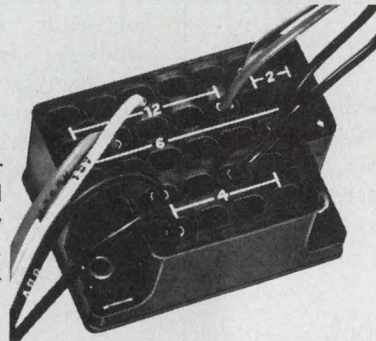

## NEW CATALOG! POWER ROTARY SWITCHES



- Complete line of switches for Industrial Control Applications
- 17 basic switch models
- Ratings from 10A to 200A . . . from 240V to 600V
- Up to 75 poles! up to 16 positions!
- Myriad of standard & optional features

*Request Catalog E-4*

**ELECTRO SWITCH**  
Weymouth, Massachusetts 02188

Telephone: 617/335/5200 • TWX: 710/388/0377

CIRCLE NUMBER 128

ELECTRONIC DESIGN 10, May 10, 1976

CIRCLE NUMBER 129

163

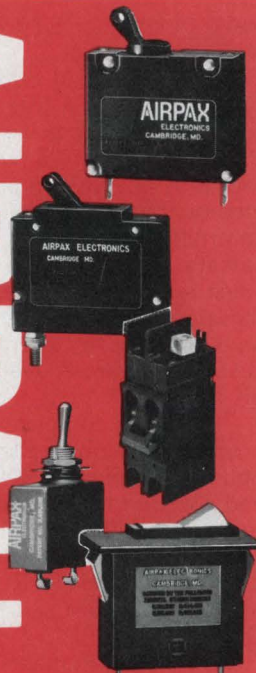
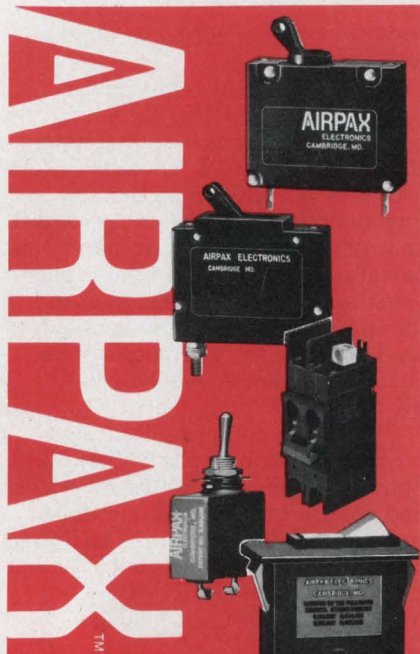

## THE CIRCUIT BREAKERS THAT PUT THE PRO IN PROTECTION

It takes a real pro to produce circuit breakers with the built-in quality, service, and reliability of Airpax breakers. That's why they are the acknowledged standards in the protection of computer systems, military, industrial, and consumer electronic equipment.

Unaffected by temperature extremes (as is the case with fuses and thermal breakers), Airpax electromechanical circuit breakers are available in a wide variety of sizes, styles, voltage and current ratings to suit nearly any OEM application.



Get the full story of these pros of the protection field. Send today for the Airpax Short Form Catalog 2013.

# AIRPAX™

**AIRPAX ELECTRONICS  
CAMBRIDGE DIVISION**

Cambridge, Maryland 21613  
Circuit Breakers, Switches,  
Glass/Ceramic-to-Metal Seals

*Other Airpax Divisions:*

CONTROLS DIVISION, Ft. Lauderdale, Fla.  
Instruments for Industry  
AMERICAN DATA, Huntsville, Alabama  
TV Products

CIRCLE NUMBER 130

## Application Notes

### Logic state analyzers

Two application notes describe the Model 1600A logic-state analyzer map-display capabilities. Hewlett-Packard, Palo Alto, CA

CIRCLE NO. 518

### Display power supplies

Power-supply configurations for driving Beckman planar gas discharge displays are covered in a six-page note. Illustrated are basic designs of dc converters. Beckman Instruments, Information Displays Operations, Scottsdale, AZ

CIRCLE NO. 519

### Pulse transformers

"Taking the Confusion Out of Specifying Power Transformers" puts forth some cost-performance guidelines derived from practical design and manufacturing experience. Ingot Electronics, Chicago, IL

CIRCLE NO. 520

### Rectifiers

An application note describes the use of rectifiers in security systems. General Instrument, Semiconductor Products Group, Hicksville, NY

CIRCLE NO. 521

### Solid-state handbook

"Handbook for Applying Solid State Hall Effect Sensors," an 84-page book, contains an illustrated section on actual "application assistance." The handbook devotes chapters to describing the Hall effect, sensor variations, magnetic considerations, electrical interfacing and other solid-state sensing technologies. Appendixes on terminology, Hall-effect theory and basic magnetics complete the book. For a copy, write on company letterhead to Sales Promotion Manager, Micro Switch, 11 W. Spring St., Freeport, IL 61032

INQUIRE DIRECT

## Evaluation Samples

### Charting, graphic tapes

Charting and graphic art tapes come in solid colors, lines, patterns, solid and Benday point size rules and decorative borders. Circle the number for a free full size roll of Formaline tape and a 16-page catalog, which shows each tape in actual width, color and pattern. Graphic Products.

CIRCLE NO. 522

### Strip terminals

Strip terminals and application tooling include plain or pretinned brass rings, spades, locking spades, quick disconnects and splices for wire sizes from 10 to 24 AWG. Terminal presses or applicators also are offered. Hoffman Industrial Products.

CIRCLE NO. 523

### Ring tongue terminals

Heavy duty ring tongue terminals are made of 0.05-in.-thick electrolytically refined copper. The terminals come in #16 to 12 AWG sizes in nylon insulated, vinyl insulated and noninsulated types. Six stud sizes from #6 to 3/8 in. are offered in each type. Panduit Corp.

CIRCLE NO. 524

### Single-position header

Discrete components, resistors, capacitors, diodes, etc., can be mounted on 0.3-in. centers with this single-position header. It can be plugged into any DIP socket. Its high-forked spring-tempered brass contact permits easy attachment of components. Aries Electronics.

CIRCLE NO. 525

### Adhesive sheets

Double-sided pressure-sensitive adhesive sheets mount anywhere quickly, cleanly and permanently. The sheets come in 18 × 24-in. and 24 × 36-in. sizes. Ulano Graphic Arts Supplies.

CIRCLE NO. 526

# Just A Step Above The Rest

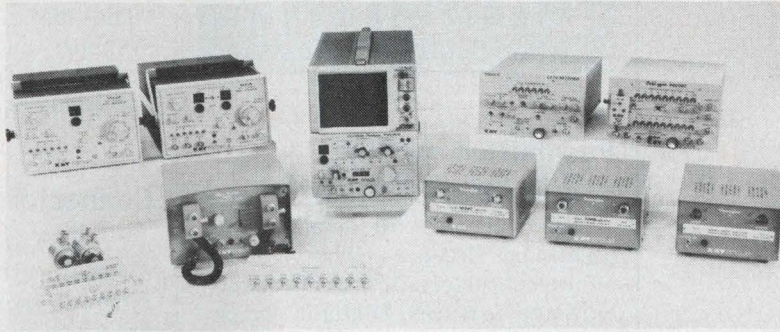

Actually the best step — Attenuators that is —

Now New Performance Engineered in-line and rotary attenuators for the lowest VSWR insertion loss, operating up to 4000 MHz in 50, 75, and 90 ohms.

## ALSO

New Half Rack Sweep Generators featuring a range of 1 to 1500 MHz in just TWO bands:

- Band 1 — 1 to 900 MHz sweep width
- Band 2 — 800 to 1500 MHz with 700 MHz sweep width

New Spectrum Analyzer (9040) with a dynamic range of 72 dB, phase lock, 1 KHz resolution, frequency and level calibration, and manual/automatic filter control.

**KAY** Elemetrics Corp.

Pinebrook, N.J. 07058

See Us at Booths 2517 and 2519 Electro '76

CIRCLE NUMBER 131

## introducing . . . the SERIES 108 ASSEMBLY TESTER

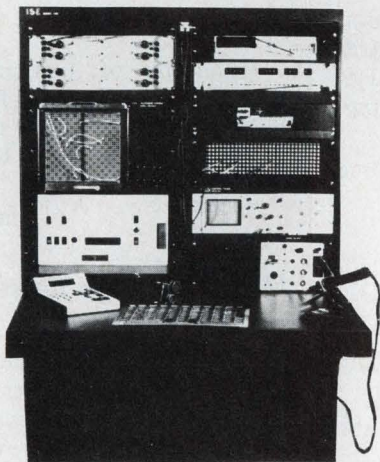

. . . a programmable compact test and repair station for DIGITAL and ANALOG cards and modular assemblies . . .

WRITE FOR A COMPLETE CATALOG:

**INDUSTRIES SUPPORT ELECTRONICS, INC.**

811 S. 2nd STREET  
RONKONKOMA, NEW YORK 11779  
PHONE (516) 585-2112

CIRCLE NUMBER 132

# NEW! CURTIS<sup>®</sup> CHAMP TWIN SCREW

## THERMOPLASTIC TERMINAL BLOCKS

*bends, twists...only twin-screw  
unbreakable, closed-back  
terminal block available.*



Write for free  
engineering  
specs.

# CURTIS INDUSTRIES, INC.

8000 West Tower Avenue, Milwaukee, WI. 53223  
Call (414) 354-1500 for the name of a representative or  
distributor near you. In Canada: A.C. Simmonds & Sons, LTD, Willowdale, Ontario.

1874

CIRCLE NUMBER 133

# Sudden Service on Small Quantities!

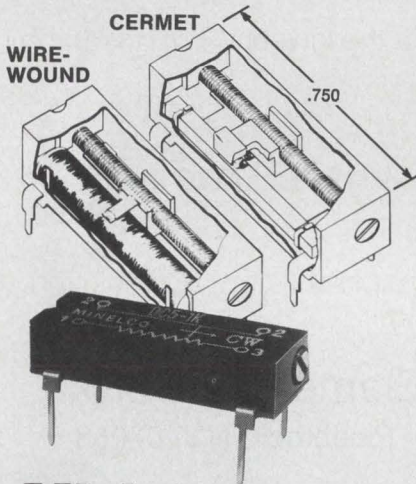

## Miniature DIP Trimmers

- Cermet or Wirewound Models
- Manual or Automatic insertion . . . single or multiple load magazines
- Sealed against humidity, liquids, potting and soldering compounds
- Oper. Temp. Range  $-55^{\circ}\text{C}$  to  $+125^{\circ}\text{C}$
- T.C. 50 ppm/ $^{\circ}\text{C}$  on Wirewound  
100 ppm/ $^{\circ}\text{C}$  on Cermet
- Standard Resis. Range 10 ohms to 2 megs.
- Multi-element precious metal wiper contact for increased reliability and low noise
- Stand-offs for efficient board cleaning
- Low industrial pricing

### PROTOTYPES

available on phone or letterhead request

### MINELCO Div. General Time

135 South Main St., Thomaston, Conn. 06787  
Phone 203-283-8261

A  TALLEY INDUSTRIES COMPANY

...from **Minelco**

CIRCLE NUMBER 134

## New Literature

### Pushbutton switches

Illuminated pushbutton switches—the 554 series—are detailed in an eight-page brochure. The brochure offers characteristics, performance data and features. Dialight, Brooklyn, NY

CIRCLE NO. 527

### Relays

A 32-page "Relay Engineering Manual" provides information on features, performance data, contact configurations and switching capabilities of more than 40 electromechanical relay models. Deltrol Controls, Milwaukee, WI

CIRCLE NO. 528

### Sockets

IC lamp, transistor, zero-force LSI and closed-entry LSI socket information, drawings and specifications are included in a six-page brochure. Molex, Lisle, IL

CIRCLE NO. 529

### Electronic hardware

Specifications, photos and diagrams illustrate electronic hardware shown in a 24-page catalog. Jan Hardware Manufacturing, Long Island City, NY

CIRCLE NO. 530

### Electrolytic capacitors

Subminiature aluminum electrolytic capacitors are highlighted in an eight-page catalog. General Instrument, Semiconductor Products Div., Hicksville, NY

CIRCLE NO. 531

### Circular connectors

Miniature circular connectors are shown in a 12-page catalog. Details include contact arrangements, shell material, shell finish, test voltages and information on hermetic versions of the connectors. ITT Cannon Electric, Santa Ana, CA

CIRCLE NO. 532

### Neon lasers

A 24-page laser catalog includes a selection guide, laser accessories, "The Making of a Laser," laser systems, and ordering, warranty and service information. Metrologic Instruments, Bellmawr, NJ

CIRCLE NO. 533

### Connectors

Contact arrangements and accessories for the DSX series of rectangular rack and panel connectors are given in a 16-page catalog. P.S. It's all in French. Radiall, 93116—Rosny Sous Bois, France.

CIRCLE NO. 534

### Timing instruments

Detailed features and specifications on six state-of-the-art timing instruments, offered in standard form along with available options, are provided in a 10-page brochure. Moxon, Irvine, CA

CIRCLE NO. 535

### Liquid-crystal displays

A reliability report on liquid-crystal displays gives initial reliability data demonstrating the inherent design capability of LCDs under standard and accelerated test conditions. RCA, Somerville, NJ

CIRCLE NO. 536

### Knobs

Hundreds of instrument knob designs as well as a full line of mechanical knobs are featured in a 20-page catalog. Kurz-Kasch, Wilmington, OH

CIRCLE NO. 537

### Metal package newsletter

The *Tekinformer*, a four-page house organ, is designed to keep its readership abreast of the latest developments in metal packages for hybrid microelectronics. Tekform Products, Anaheim, CA

CIRCLE NO. 538

### Graphics display terminal

Features of interactive computer graphics display terminals are covered in an eight-page booklet. Hughes Industrial Products, Carlsbad, CA

CIRCLE NO. 539

# "I've purchased \$50,000

# worth of products through the GOLD BOOK"



**M.G. Stickler, P.E.**  
General Manager  
Computer Engineering Division  
Pentamation Enterprises, Inc.

"The GOLD BOOK provides a convenient comparison of products from multiple sources, as well as vendor phone numbers," writes M.G. Stickler, P.E., General Manager, Computer Engineering Division, Pentamation Enterprises, Inc.

Mr. Stickler is involved with design, production, installation, and maintenance of minicomputer and microcomputer systems for his Bethlehem, Pa., Computer Facilities Management firm.

"I find the GOLD BOOK extremely useful...I've probably used it about 70 times, and as a result, we've purchased \$10,000 worth of power supplies, \$2,000 in keyboards, \$30,000 in microcomputers — about \$50,000 to date."

This is the GOLD BOOK in action. This is the GOLD BOOK working for you. (The GOLD BOOK goes essentially to *Electronic Design's* audience of known specifiers.)

Mr. Stickler, like 78,000 engineers, engineering managers, purchasing agents and distributors throughout the U.S.A. (plus 13,000 overseas) has his own personal copy of the GOLD BOOK. He uses it to specify and buy products.

## **THIS IS ELECTRONIC DESIGN'S AUDIENCE WORKING FOR YOU!**

### **Electronic Design / GOLD BOOK**

**HAYDEN PUBLISHING COMPANY, INC.**

50 Essex Street, Rochelle Park, New Jersey 07662. Tel: 201-843-0550

Sabor presents  
the  
**SONY**<sup>®</sup>  
Instrumentation  
Cassette Recorder



The SONY FRC-1402 provides 4 FM data channels with a frequency response of DC to 625 Hz. S/N ratio is 45dB (rms) minimum. Tape speed is 1-7/8 ips with recording time up to 45 minutes.

Price is \$1990.

12597 Crenshaw Blvd.  
Hawthorne, CA 90250  
(213) 644-8689

**Sabor corporation**

CIRCLE NO. 136

**classified ads**

**PATENTS FOR LICENSE**

3,691,557 Microwave Object Identification Using Labels—AVI, MOI, Industrial and Materials ID, 3,790,939 Real Time High Resolution, Reconnaissance, Surveillance, Ground Mapping, 3,798,644 Beam Crossing Speed Measurement—Vector Velocity Measurement, 3,858,203 Real Time Synthetic Aperture—Optical Point-of-Sales, Postal Mail and Stock Certificate Bar Code Reader, 3,896,435 Collision Avoidance—Intruder Detection—Electronic Surveillance—Proximity Warning—Object Detection. Also signal processors, Signal Integrating System, Digital Matched Filter and Correlator. Principals only.

**RCS ASSOCIATES, INC.**  
1603 Danbury Drive, Claremont, CA 91711

**CRAMOLIN — Antioxidizing Lubricant**  
"The Less used — the better it works!"

For all metal electrical contacts and connections. Reduce contact resistance. Restore electronic system performance. Protect against corrosive atmospheres. Will not harm plastics. Safe. Liquid or aerosol. Tech. data, Engineers Kit Available.

**Caig Laboratories, Inc.**  
P.O. Box 64, Escondido, Ca., 92025

**Electronic Design**

ELECTRONIC DESIGN's function is:

- To aid progress in the electronics manufacturing industry by promoting good design.
- To give the electronic design engineer concepts and ideas that make his job easier and more productive.
- To provide a central source of timely electronics information.
- To promote communication among members of the electronics engineering community.

**Want a subscription?** ELECTRONIC DESIGN is sent free to qualified engineers and engineering managers doing design work, supervising design or setting standards in the United States and Western Europe. For a free subscription, use the application form bound in the magazine. If none is included, write to us direct for an application form.

If you do not qualify, you may take out a paid subscription for \$30 a year in the U.S.A., \$40 a year elsewhere. Single copies are \$1.50 each.

**If you change your address,** send us an old mailing label and your new address; there is generally a postcard for this bound in the magazine. You will have to requalify to continue receiving ELECTRONIC DESIGN free.

**The accuracy policy** of ELECTRONIC DESIGN is:

- To make diligent efforts to ensure the accuracy of editorial matter.
- To publish prompt corrections whenever inaccuracies are brought to our attention. Corrections appear in "Across the Desk."
- To encourage our readers as responsible members of our business community to report to us misleading or fraudulent advertising.
- To refuse any advertisement deemed to be misleading or fraudulent.

Microfilm copies are available of complete volumes of ELECTRONIC DESIGN at \$19 per volume, beginning with Volume 1, 1952 through Volume 20. Reprints of individual articles may be obtained for \$3.00 each, prepaid (\$.50 for each additional copy of the same article) no matter how long the article. For further details and to place orders, contact the Customer Services Department, University Microfilms, 300 North Zeeb Road, Ann Arbor, Michigan 48106 telephone (313) 761-4700.

**Want to contact us?** If you have any comments or wish to submit a manuscript or article outline, address your correspondence to:

Editor  
ELECTRONIC DESIGN  
50 Essex Street  
Rochelle Park, N.J. 07662

Step-by-step coverage of  
defense radar system  
design . . .

**INTRODUCTION  
TO  
DEFENSE  
RADAR  
SYSTEMS  
ENGINEERING**

**James N. Constant**

This all-inclusive handbook covers virtually every facet of radar technology that must be mastered in order to design a complete defense radar system. In fact, it concludes with a *step-by-step procedure for specifying and designing a complete radar system for a given application.* Separate chapters cover target characteristics; radar detection; radar receivers; radar system error model; flight of a ballistic missile; ballistic reentry trajectories; trajectory prediction; radar data processing; reflector antennas; and array antennas. Order your 15-day examination copy today! #9194, 344 pages, cloth, illustrated, \$22.95



**15-DAY FREE EXAMINATION!**



Hayden Book Company, Inc.  
50 Essex Street  
Rochelle Park, N.J. 07662

- Please send me my copy of INTRODUCTION TO DEFENSE RADAR SYSTEMS ENGINEERING to read and use for 15 days. At the end of that time, I'll send a check or money order for \$22.95, plus postage and handling, or return the book and owe absolutely nothing.
- I want to save money! I have enclosed full amount. Publisher pays postage and handling. I get a complete 15-day money-back guarantee.

Name \_\_\_\_\_  
Firm \_\_\_\_\_  
Address \_\_\_\_\_  
City/State/Zip \_\_\_\_\_

76-15

Advertisements of booklets, brochures, catalogs and data sheets. To order use Reader-Service Card (Advertisement)

## Advertising Sales Staff

Tom W. Carr, Sales Director  
Jean Bunfield, Sales Coordinator

## Rochelle Park, NJ 07662

Robert W. Gascoigne  
Daniel J. Rowland  
Thomas P. Barth  
George Mortimer  
Stan Tessler  
50 Essex St.  
(201) 843-0550  
TWX: 710-990-5071

## Philadelphia

Thomas P. Barth  
(201) 843-0550

## Boston 02178

Gene Pritchard  
P.O. Box 379  
Belmont, MA 02178  
(617) 489-2340

## Chicago 60611

Thomas P. Kavooras  
Berry Connor, Jr.  
200 East Ontario  
(312) 337-0588

## Cleveland

Thomas P. Kavooras  
(312) 337-0588

## Los Angeles 90045

Stanley I. Ehrenclou  
Burt Underwood  
Neil Canavin  
8939 Sepulveda Blvd.  
(213) 641-6544

## Texas

Burt Underwood  
(213) 641-6544

## San Francisco

Robert A. Lukas  
3579 Cambridge Lane  
Mountain View, CA 94040  
(415) 965-2636

## London

Constance McKinley  
50 Essex St.  
Rochelle Park, N.J. 07662  
Phone: (201) 843-0550

## Amsterdam, Tokyo, Seoul

Sanders, B. V.  
Raadhuisstraat 24  
Graft-De Ryp, Holland  
Phone: 02997-1303  
Telegrams: Euradteam-Amsterdam

## Haruki Hirayama

Electronic Media Service  
5th Floor, Lila Bldg.,  
4-9-8 Roppongi  
Minato-ku, Tokyo, Japan  
Phone: 402-4556  
Cable: Electronicmedia, Tokyo

## Mr. O-kyu Park, President

Dongbo Intl Corp.—  
World Marketing  
C.P.O. Box 4010  
Seoul, Korea  
Tel. 76-3910/3911  
Cable: DONGBO SEOUL  
Telex: EBKOREA K27286

## GIANT FREE CATALOG

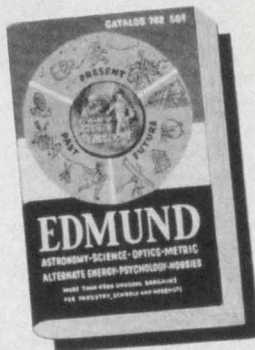

New 172-page catalog! Packed with 1,000's of hard-to-find buys in Optics, Science, Electronics. Loaded with optical, scientific, electronic equipment available from stock. Rare surplus buys. Many "one-of-a-kinds". Ingenious scientific tools. Components galore: lenses, prisms, wedges, mirrors, mounts, accessories. 100's of instruments: pollution test equipment, lasers, comparators, magnifiers, microscopes, projectors, telescopes, binoculars, photo attachments, alternate energy sources. Shop, save by mail! Request free Catalog "DA".

## Edmund Scientific Co.

America's Largest Science-Optics-Electronics Mart  
300 Edscorp Bldg., Barrington, New Jersey 08007 (609) 547-3488

CIRCLE NO. 171

## FFT Analyzer Provides Instant Results; Allows Continuous Viewing and Editing



Designed for operation by engineers rather than computer experts, the "DSP" Digital Signal Processor is portable and provides instant, Real Time answers for 12 distinct signal-analysis functions. It conditions and analyzes two signals, correlates their mutual properties, and displays results in a broad variety of forms and formats. Real Time operation is to 25 kHz. By means of a "joystick"-controlled cursor, data is traced for instant, calibrated 6-digit LED readout of frequency, amplitude, time and phase. Accepts analog waveforms or digital data for 57 analysis ranges from 10 Hz to 150 kHz with resolution narrow as 0.01 Hz. Averages up to 4096 ensembles. Throughput over 300,000 words/sec.

CIRCLE NO. 172

## Spectral Dynamics Corporation

P.O. Box 671, San Diego, CA 92112  
(714) 565-8211

Are you using the #1 training courses in electricity & electronics?

## BASIC ELECTRICITY and BASIC ELECTRONICS

By Van Valkenburgh, Nooger & Neville, Inc.



Derived from the COMMON-CORE Training Program initially developed for the U.S. Navy, these unique texts are now about to enter their third decade of use in schools, industries, and communication utilities. They continue to be exemplary training texts in their subjects. Carefully integrated illustrations comprise almost half the course material. These perform a remarkable job of visualizing complex theory and applications. Readers are able to grasp essential concepts right away without having to wade through pages of wordy explanation. Thorough, comprehensive coverage. Available in separate paperbacks or one cloth volume. Write for FREE brochure.

CIRCLE NO. 173

## Hayden Book Company

50 Essex St. Rochelle Pk, N.J. 07662

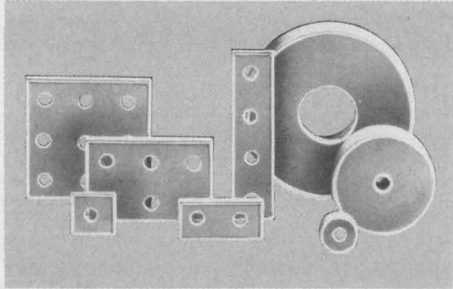

**CIRCLE & MULTI-FEED-THRU CAPACITORS**, available in a wide range of sizes and configurations, with NPO, BX, Z5U and Y5V characteristics. For use as feed-through elements, where volume efficiency of capacitance performance is required. Applications also include filter networks, pulse and logic circuitry, and signal bypass to ground elements in broadband circuits. Available in configurations suited to customer needs. Johanson/Dielectrics, Inc., Box 6456, Burbank, CA 91510 (213) 848-4465.

CIRCLE/MULTI-FEED CAPACITORS 201

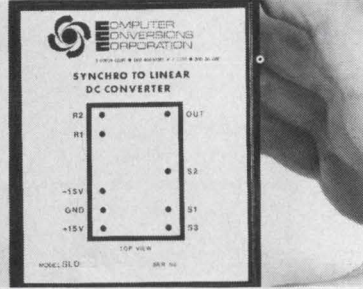

**Synchro to Linear DC Converter**: Infinite Resolution. Full ( $\pm 180^\circ$ ) or Limited Angle DC Output ( $\pm 90^\circ$ ),  $\pm 6$  or  $\pm 15$  minute accuracy at input rates up to  $1440^\circ/\text{sec.}$ , 60 or 400 Hz input. Custom Output scaling available. Module  $2.6'' \times 3.1'' \times .82''$  H. Price from \$350 in quantity. Other CCC products are Synchro to Digital, Digital or DC to Synchro Converters, Solid State C. T.'s or CDX's, and Absolute Encoders. Send for Free Catalog & Application Notes. Computer Conversions Corp., East Northport, N.Y. 11731 (516) 261-3300. 204

SYNCHRO TO LINEAR DC CONVERTER



**STURDILITE ELECTRONIC WORK STATIONS** designed to meet exacting requirements for electronic testing, production and assembly. Electrical outlets available in almost any quantity and in convenient locations. Free catalog. Also, free planning service is available. Angle Steel Div., Kewaunee Scientific Equipment Corporation, Plainwell, Mich. 49080 Phone (616) 685-6831

TECHNICAL WORK STATIONS 207



**Solid State Digital Power Line Monitor** is ideally suited for use with power generation equipment, computer systems, control panel installation labs where power sources must be monitored for assuring test equipment accuracies. Four models available. From \$129 ea. Electro Industries, P.O. Box 3542, No. New Hyde Park, N.Y. 11040. (516) 621-6652

POWER LINE MONITOR 202



**ELECTRONIC DESIGN: BICENTENNIAL ISSUE** This historic 254-page issue traces the developments of the electronics industry from the Colonial period to today. Has received both Presidential commendation and official recognition by the American Revolution Bicentennial Administration. Supply limited. Send check for \$4 each to: Bicentennial Issue, Electronic Design, 50 Essex St., Rochelle Park, NJ 07662.

HISTORIC MEMENTO



**MODULAR DC/DC CONVERTERS** offer 5 and 10 W dual output and 15 W single output with eff. from 55 to 68%. Regulation is 5 mv. Dual units allow rated power from one output. L/C filtering on both input and output for low noise. (1-9) from \$78.60. B. H. INDUSTRIES, 5784 Venice Bl., Los Angeles, CA 90019 (213) 937-4763.

MODULAR DC/DC CONVERTERS 208

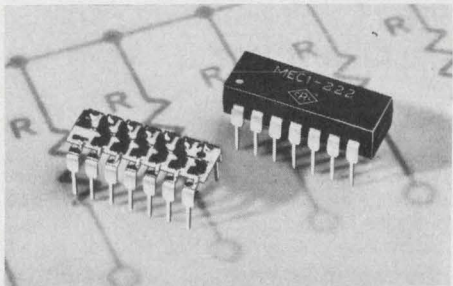

**DUAL-IN-LINE, RESISTOR NETWORKS** for such typical applications as pull-up and pull-down networks or line terminators. • 7 or 13 resistors, 14 pin • 8 or 15 resistors, 16 pin • Resistor values: 100 ohm to 10K ohm. • TCR:  $\pm 200\text{ppm}/^\circ\text{C}$  • Thick film resistor tolerance:  $\pm 2\%$ . All are available for off-the-shelf delivery from over 200 Centralab Distributors. For the name of your local Distributor call 414-228-2911.

RESISTOR NETWORKS 203



**Pocket-Size Slide-Switch Resistance Substitution Unit**  
• Over 11 million ohm values  
• Only \$58  
This aluminum-housed unit is unique in its small size. Half-watt, 1% accuracy resistors provide a range from 1 to 11,111,110 ohms, in one-ohm steps. Designed with three binding posts—one to ground case. Phipps & Bird, P.O. Box 27324, Richmond, Va. 23261 (804) 264-2858

RESISTANCE SUBSTITUTION UNIT 206

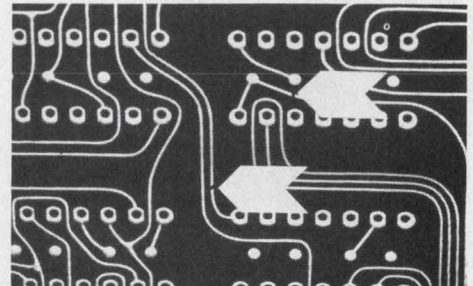

**ID/INSPECTION ARROWS** Identify problem and action areas at a glance with colorful pressure sensitive arrows. Use for inspection, QC, flagging, repair identification, assembly drawings and instructions. Permanently affix or reposition. Die cut from paper or vinyl tape. Won't fade, dry out, or lift. Standard and fluorescent colors in  $1/4''$ ,  $3/8''$ , and  $3/4''$  lengths. From \$2.40/M in 5-49M qty. Webtek Corporation, 4326 W. Pico Blvd., Los Angeles, CA 90019.

ID/INSPECTION ARROWS 209



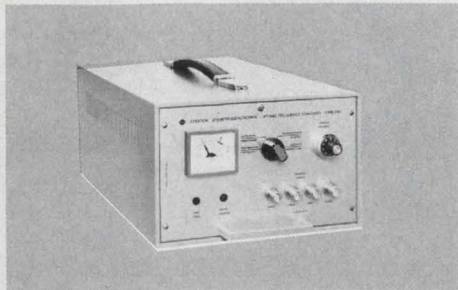

**Atomic Frequency Standard Model FRT** for Lab/Field. Output 10-5-1 0.1 MHz, Short Term Stability  $<1 \times 10^{-11}$   $\tau = 1s$ ,  $<1 \times 10^{-12}$   $\tau = 100s$ . Drift typ  $1 \times 10^{-11}$ /M. Coupled with Receiver-Controller EFR. Sync to Standard Freq. absolute freq parts in  $10^{12}$ . Efratom Calif., Inc., 3303 Harbor Blvd., E1, Costa Mesa, Ca. 92626 (714-556-1620)

ATOMIC FREQUENCY STANDARD 210

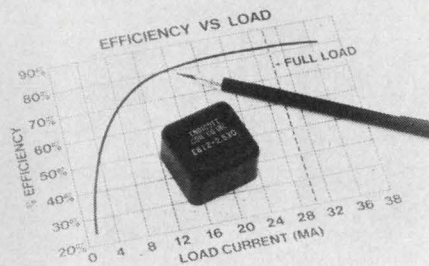

**Activate gas discharge readouts!** DC-to-DC power supplies convert low DC line voltages of 5, 9, 12 or 15 volts to nominal 200 and 250 volt DC levels required to run gas discharge information displays. Ideal for battery powered applications! Both regulated and unregulated. Ask about our custom power supplies, too! Free literature. Endicott Coil Co., Inc., 31 Charlotte Street, Binghamton, N.Y. 13905. (607) 797-1263

POWER SUPPLY 213

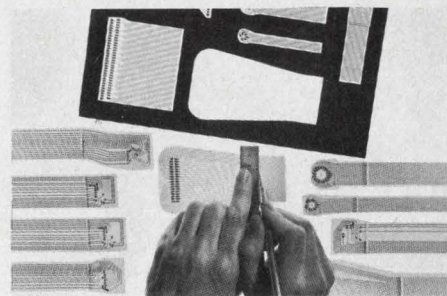

**PROTOTYPE YOUR OWN FLEXIBLE CIRCUITS** Exacto knife, soldering iron, plus our kit make all circuits shown—and more! Kit includes sheet of 1 oz. copper conductors on 1 mil polyimide film, plus matching sheets with about 15 connector patterns. 100's of combinations possible. . . . Easy instructions, parts list, dimensional drawings included. Flexible Circuit Kit, \$25 from stock. Rogers Corporation, Chandler, AZ 85224 (602) 963-4584.

FLEXIBLE CIRCUITS KIT 216

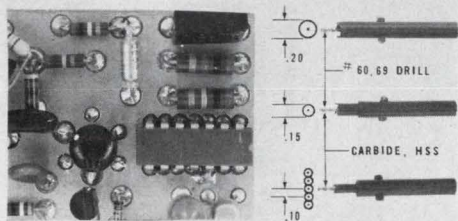

**Enjoy Increased Productivity, quality, decreased costs, improved circuit board construction techniques—made possible by EMPLOYEES using ISOLATED-PAD-DRILL-MILLS.** Particularly valuable for modification of existing boards—component changes, re-locations, additions, improved by-passing, etc., or professional, instrument useable breadboards that duplicate parts layout of production boards. Immediate delivery IP6003C, \$27.50/set of 3. AFS-Tools, P.O. 354, Cupertino, Ca. 95014. 408-252-4219.

DRILL MILLS 211

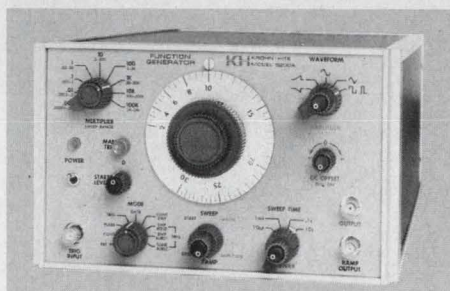

**Krohn-Hite Model 5200A** provides sine, square & triangle waveforms and ramps over a 0.002Hz to 3 MHz range plus an independent linear sawtooth over a 0.1Hz to 100KHz range. 9 modes including continuous waveform & sawtooth, fixed frequency bursts, frequency sweeps or pulses. Features unique protection circuit to guard main output against accidentally applied voltages. 1000:1 Internal Sweep. VCO 1000:1—Price \$595. Delivery 4 wks. ARO. Krohn-Hite Corp. Avon Indust. Pk, Avon, MA 02322. (617) 580-1660.

2 GENERATORS IN 1 214



**PACE BENCH-TOP REPAIR CENTERS** for simplified Rework/Repair of electronic assemblies. Permits: controlled desoldering for solder joint removal . . . abrading, milling, drilling, grinding and cutting for circuit board repair . . . removal of conformal coatings . . . reflow soldering . . . accurate component forming . . . component salvage . . . repair of damaged plated-thru holes and terminals . . . replating of damaged/worn connectors or contacts. From \$895. PACE INC., 9329 Fraser St., Silver Springs, Md. 20910 (301) 587-1696

REPAIR CENTERS 217



**MINIATURE FILTERS** for Highpass, Lowpass, Bandpass and Band Reject signal conditioning applications are described in the new catalog. Flat passbands and sharp cutoffs are featured. Specify any frequency from sub-audio to UHF. TT Electronics, Inc., 2214 Barry Ave., Los Angeles 90064. (213) 478-8224

MINIATURE FILTERS 212

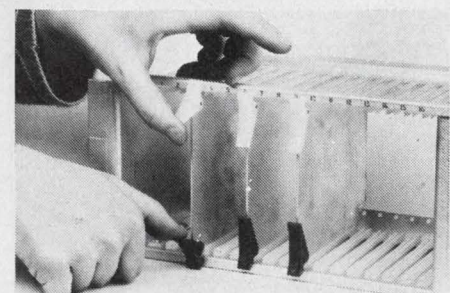

**FREE SAMPLES** of low-cost Electro-Flex card guides and ejectors. Guides in 3", 4", 6" and 8 1/2" lengths have built-in bow to aid card retention. Ejectors feature longer sure-grip handle for greater strength, improved leverage and damage-free extraction; stainless roll pins included. Both in UL-approved nylon. Card rack and complete metal fabricating literature also available. Electro-Space Fabricators, Topton, Pa. 19562. (215) 682-7181.

CARD GUIDES - EJECTORS 215

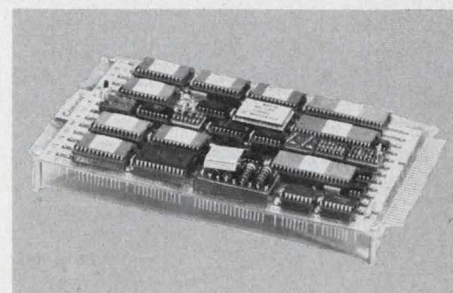

**MICROPROCESSOR BOARD FOR MOTOROLA M6800 EVALUATION CHIP SET.** \$197.50 from CAMBION distributors. Pre-wired board saves hours interconnecting M6800 evaluation kit. Wire-Wrap® tool and precut wires for circuit changes included plus circuitry and components to interface with teletype machine, pre-wired sockets for three more MC6810L, connections for 12 more IC's, instructions and hardware. Cambridge Thermionic Corp., 445 Concord Ave., Cambridge, MA 02138.

MICROPROCESSOR BOARD 218

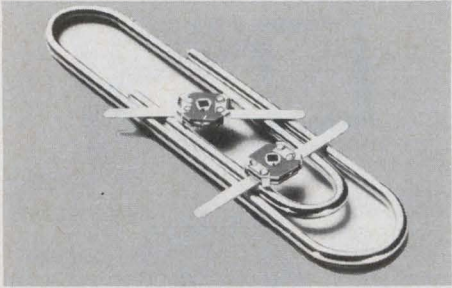

**Thin-Trim variable capacitors** provide a reliable means of adjusting capacitance without abrasive trimming or interchange of fixed capacitors. Series 9401 has high Q's and a range of capacitance values from 0.2-0.6 pf to 3.0-12.0 pf and 250 WVDC working voltage. Johanson Manufacturing Corporation, Boonton, New Jersey (201) 334-2676.

THIN-TRIM CAPACITORS

181



**SYNCHRO TO BCD CONVERTERS:** 3 or 4 decade, unipolar or bipolar output, adjustable scale factor,  $\pm 6$  or  $\pm 30$  minute accuracy, 60 or 400 Hz input, zero offset adjustment, module 2.6 x 3.1 x .82" H. Unit Price from \$395 ea. Other CCC products are Synchro to Digital or DC, Digital or DC to Synchro Converters, Solid State C. T.'s or CDX's, and Absolute Encoders. Send for Free Catalog & Application Notes. Computer Conversions Corp., East Northport, N.Y. 11731 (516) 261-3300.

SYNCHRO TO DIGITAL

184

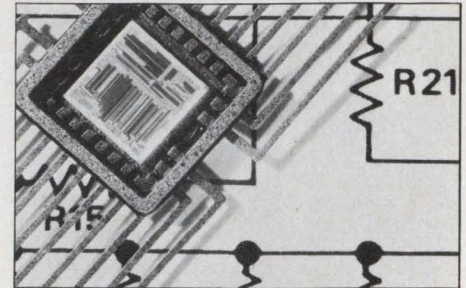

**Hi-Rel 12 Bit Ladder Network:** Added to the industry's most complete standard ladder network product line is the AD850/U/F/883. The ladder is a 12 bit binary current network for user configured avionics systems where minimum space, weight and reliability are important. Accuracy is  $\frac{1}{2}$ LSB of 12 bits. Price is \$50.00 in 100's. Analog Devices, Norwood, Mass. 02062 617-329-4700.

HI-REL 12 BIT LADDER NETWORK

187

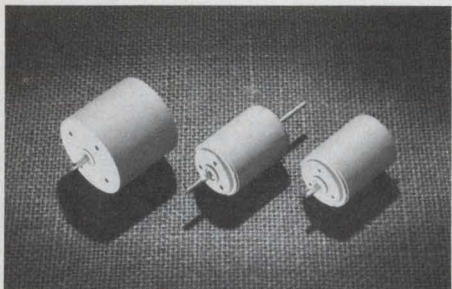

**MINIATURE IRONLESS ROTOR DC MOTORS** offer efficiencies to 80%, low inertia, rapid response and high starting torque. 24 and 12 VDC models available. Motor time constants are 17 and 23 MS respectively. Rotor torque is 100 and 50 gcm and starting torque 600 and 230 gcm, respectively. 12 VDC units can be ordered with either a single or extended double shaft. Tach versions also available. For reel and capstan drives, chart and pen drives, etc. North American Philips Controls Corp., Cheshire, Conn. 06410. (203) 272-0301.

IRONLESS ROTOR

182

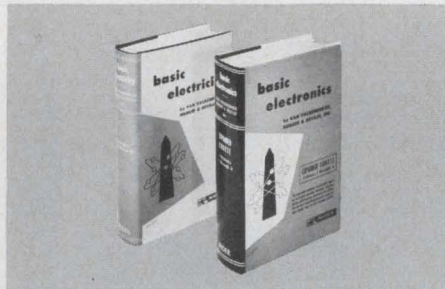

**Basic Electricity & Basic Electronics** by Van Valkenburgh, Nooger & Neville, Inc. Derived from the COMMON-CORE Training Program initially developed for the U.S. Navy. Thorough, comprehensive coverage. Available in separate paperbacks or cloth volume. Write for FREE brochure. Hayden Book Co., Inc., 50 Essex St., Rochelle Pk, N.J. 07662 (201) 843-0550.

TRAINING TEXT

185

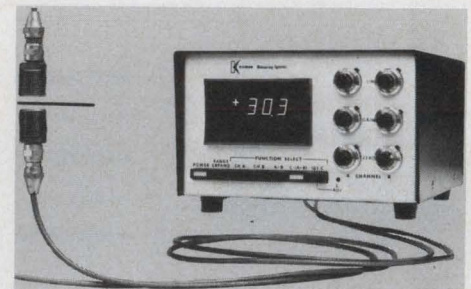

**New Electronic Gage, Easy To Use. Thickness, Alignment . . . diameter or deviation measurements, concentricity, orbit tracing, etc.** Accuracy up to  $\pm$  micro-inches ( $\pm$  0.001 inch), resolution <10 microinches. Utilizes non-contacting inductive measuring techniques—unaffected by oil, grease, or water. Replaces LVDT, air gage, dial indicator, micrometer, \$1,995. Ask for information on KD-2602-2S. Kaman Sciences Corporation, P.O. Box 7463, Colorado Springs, Colorado 80933. (303) 599-1500

ELECTRONIC GAGE

188

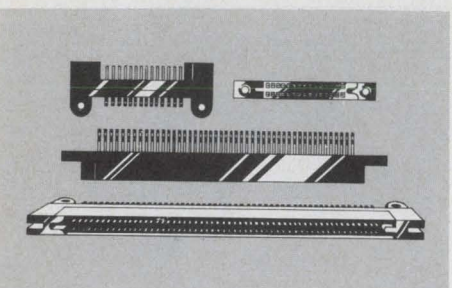

**The AMP Box Connector** is ideal for systems with up to several hundred contacts. It features an innovative "box" contact design that accepts square, rectangular, round, or formed channel pins. Available in many pin and receptacle configurations and with external keying. From the people who offer technical assistance at its best: AMP Incorporated, Harrisburg, PA (717) 564-0100.

AMP BOX CONNECTOR

183

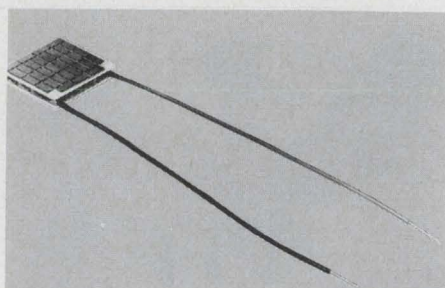

**THERMOELECTRIC MODULE**, a remarkable value for only \$20 (ppd.), can be used in water coolers, small refrigerators, hot and cold temperature sources, spot cooling for electronic components and other applications. Operates at 3.5 VDC, 8.5 amps,  $\Delta T$  Max at  $Q_c$  Zero is 60°C,  $T_h$  is 50°C,  $Q_c$  Max. at  $\Delta T$  Zero is 19 watts, Max. Op. temp is 100°C. Price includes Thermoelectric handbook. CAMBION, 445 Concord Avenue, Cambridge, MA 02138.

THERMOELECTRIC MODULE

186

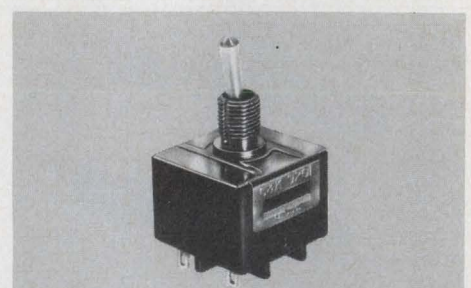

**Model 9201 Power Switch**, miniature DPDT toggle is designed to meet international dimensional/electrical specs. Electric life: 25,000 make-and-break cycles at full load. Contact rating: 6 amps with resistive load @ 120 VAC or 28 VDC. Free Engineering Sample on request. C&K Components, Inc., 103 Morse St., Watertown, MA 02172, (617) 962-0800.

POWER SWITCH

189



**A Software Library**, developed and maintained by users to provide access to the programming efforts of other handheld, programmable calculator users. Viola Grange invites your programs. Contributors receive free the volume in which they are published. Vol 1 is a source containing practical formulae, skillful programming, and imaginative treks into mathematics and engineering. Published quarterly. \$6. The Viola Grange, Rt. 2, Box 965, Estacada, OR 97023

APPLICATIONS PROGRAMS 190

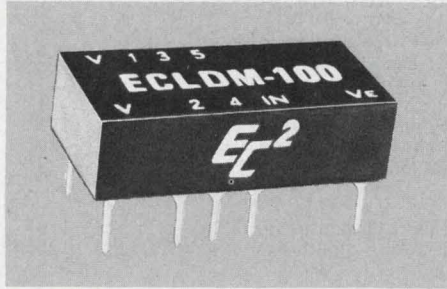

**EC's new ECL compatible Logic Delay Module** features ECL input and outputs; 16-pin DIP package (.250 high); precise delays from 25ns to 250ns; and with 20% taps—each isolated with 70 ECL dc. fan-out capacity. Engineered Components Company, P.O. Box Y, San Luis Obispo, CA 93406 (805) 544-3800.

ECL LOGIC DELAY MODULE 193

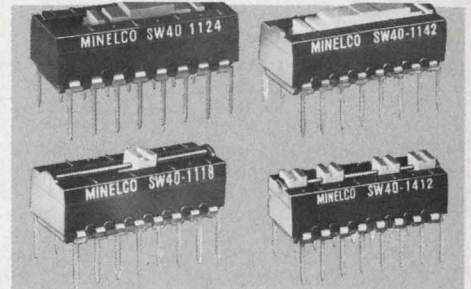

**New Multi-Slide, Multi Circuit DIP Switches** . . . wide variety of switching combinations. Freq. Range Sel. test pt. monitoring, select on test, atten. level selection, program addressing, cross pt. switching, 2 poles, 4 posit., 4 poles, 2 posit.; 1 pole, 8 posit.; 4 poles 2 posit. (var.) True "break-before-make"; spring-loaded double bearing detent; gold/nickel contact plating; self-cleaning wiping action for consistent performance. Minelco Div., Gen. Time, 135 S. Main St., Thomaston, CT 06787 (203) 283-8261

DIP SWITCHES 196



**The Model 1000 Directional Wattmeter** is an accurate and portable insertion RF wattmeter using plug-in detectors and quick-change RF connectors, which measure forward & reflected CW power. The Model 1000 features a large scale, easily read meter movement. Standard ranges are 5 watts to 10,000 watts; frequency range is 2 to 1,000 MHz. TUCKER ELECTRONICS CO., PO BOX 1050, GARLAND, TEXAS 75040 (800) 527-4642 (In Texas Call (214) 348-8800)

RF WATTMETER 191



**Resident COBOL compiler system** for the 8080 microprocessor. Runs on any 16K RAM system. With a few exceptions, the level of COBOL offered (relative to ANSI X3.23-1974) is: nucleus level 2, table handling level 2, sequential, relative and indexed I-O level 1, and sort-merge level 1. Reference manual \$6. Also available: complete disk operating system including a powerful job control language, an assembler, a text editor, a debugging system, file utility routines. Mini-Software Inc., Box 7438, Alexandria, VA 22307.

COBOL COMPILER 194

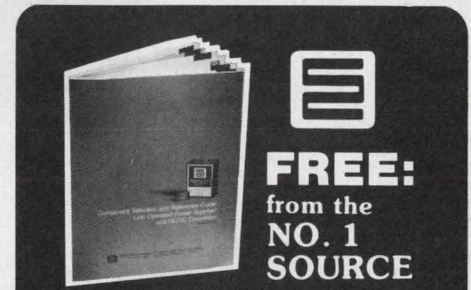

**Power Supply and DC/DC Converter Catalog**

**Application Information**

- Power Supplies
- DC/DC Converters
- Microprocessor Supply
- Pricing
- Specifications
- Discounts

SEMICONDUCTOR CIRCUITS, INC.  
306 RIVER STREET • HAVERHILL, MASSACHUSETTS 01830  
TEL. (617) 373-9104

CONVERTER CATALOG 197

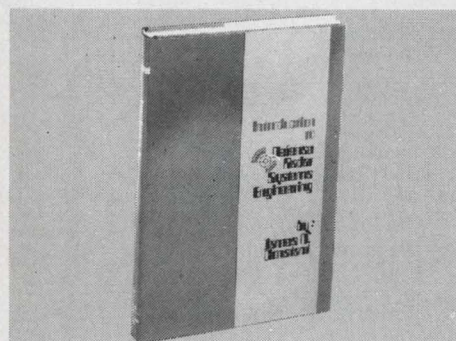

**Introduction To Defense Radar Systems Engineering.** Excellent introduction and practical reference to radar systems design and applications. #9194, 260 pp., \$22.95. Circle the Info Retrieval No. to order 15-day exam copy. When billed, remit or return book with no obligation. Hayden Book Co., 50 Essex St., Rochelle Park, N.J. 07662

RADAR SYSTEMS 192

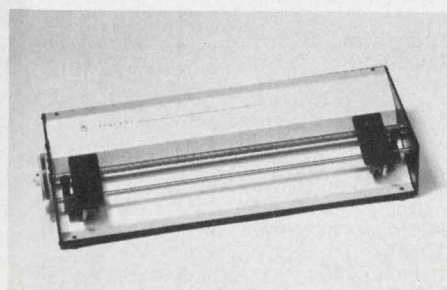

**A FORMS FEED TRACTOR** slewing at 37 lps with 140 in/oz of torque. Electronic vernier adj. sets TOP OF FORM: quarter, single & double line feed in forward or reverse are standard. Options of PERF. SKIP, PAPER FEED TIME OUT, END OF FORM SENSING & SELECTABLE TOP OF FORM are available. The design assures operating simplicity, long life and trouble free performance in heavy duty operation. TRAKTEX 45 Ryegate Terr. Monroe, Ct. 06468 203-261-9011

FORMS FEED TRACTOR 195

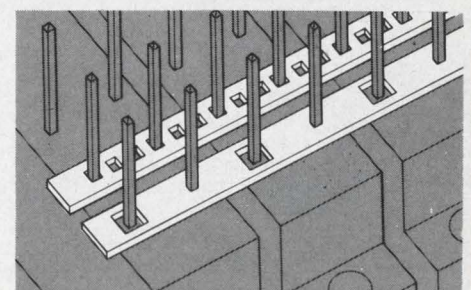

**STRIP/BUS BY ROGERS.** Low Cost Bussing Systems; easy installation, reliable solder joints; greater pin exposure. Write or call for details. Rogers Corporation, Rogers, CT 06263. Phone (203) 774-9605.

STRIP/BUS 198

# Advertiser's Index

Advertiser	Page	Advertiser	Page	Advertiser	Page
ACDC Electronics, Inc.	64	Elxon Power Systems	107	North American Philips Controls Corp.	10, 172
AFS Tools	171	Elmwood Sensors, Inc.	139	North Microsystems Division of North Electric	161
AMP, Incorporated	20, 21, 172	Endicott Coil Co., Inc.	171	Oak Industries, Inc.	175
Acopian Corp.	104, 105	Engineered Components Company	173	Pace, Inc.	171
Ad-Vance Magnetics, Inc.	144	Erie Technological Products, Inc.	41	Penril Corp., Data Communications Division	115
Addmaster Corporation	161	Exact Electronics, Inc.	64G	Philips Industries, Test and Measuring Instruments Dept.	124, 125
Advanced Micro Devices	82, 83			Phipps & Bird, Inc.	170
Airpax Electronics, Cambridge Division	164	Fifth Dimension Inc.	136	Phoenix Data, Inc.	143
Allen Bradley Co.	144A	Floating Point Systems, Inc.	126	Plessey Capacitors	144
Alpha Wire Corp.	130			Potter & Brumfield, Division of AMF, Incorporated	93
American Microsystems, Inc.	8, 9	GenRad	23	Power/Mate Corp.	148
American Technical Ceramics	143	General Electric Company, Miniature Lamp Products Department	128	Precision Monolithics, Incorporated	109
Analog Devices, Inc.	19, 172	General Electric Company, Semiconductor Products Department	43	Pro-Log Corporation	30
Angle Steel/Division of Kewaunee Scientific Equipment Co.	170	*Germanium Power Devices	117		
Ann Arbor Terminals, Inc.	150	Gold Book, The	64F, 167	RCA Solid State	Cover IV
Arnold Magnetics Corp.	160	*Gold Book, The	104, 105	RCL Electronics, Inc.	40
Arrow-M Corp.	112	Grayhill, Inc.	132	Raytheon Company, Industrial Components Operation	18
Avantek, Inc.	137	Guardian Electric Manufacturing Company	144C	Research, Inc.	142
				Reticon	133
B & H Industries	170	Harris Semiconductor, A Division of Harris Corporation	26	Riken Denshi Co., Ltd.	155
Biomation	12, 13	Hayden Book Company, Inc.	64H, 168, 169, 172, 173	Rockwell International	101
Bourns, Inc., Trimpot Products Division	Cover II	Hewlett-Packard	22, 50	Rogan Corporation	149
Bud Radio, Inc.	114	Honeywell Test Instruments Division	25	Rogers Corporation	92, 171, 173
Burroughs Corporation	119			Rtron Corporation	162
C & K Components	172	IMC Magnetics Corporation	148	Sabor Corporation	168
CTS Corporation	Cover III	IMS Associates, Inc.	163	Sangamo Electric Company	51
Cambion	172	ISE Electronics Corporation	60	Semiconductor Circuits, Inc.	173
Cambridge Thermionic Corporation	171	IIT Cannon, A Division of International Telephone and Telegraph Corporation	52	Servo-Tek Products Company	146
Capitol Calculator Company	142	Illuminated Products Co.	7	Signetics Corporation	145, 147, 149, 151, 153, 155, 157, 158, 159
CELCO (Constantine Engineering Laboratories Company)	15	Indiana General	64A	Simpson Electric Company	127
Centre Engineering	152	Industries Support Electronics	165	*Sodeco SAIA SA	140
Centralab, The Electronics Division of Globe-Union, Inc.	144B	Infotek Systems	175	Spectral Dynamics Corporation	169
Centralab Distributors	170	Intel Corporation	64B-C	Spectrol Electronics Corporation	57
Chrono-Log Corp.	147	Intelligent Systems Inc.	116	Sprague Electric Company	14
Computer Conversions Corp.	170, 172	Itoh Electronics, Inc., C.	150	Stacoswitch, A Staco Inc. Company	137
Computer Products, Inc.	121, 146			Standard Condenser Corporation	138
Constantine Engineering Laboratories Company, (CELCO)	15	Johanson Manufacturing Corp.	6, 172	Stanford Applied Engineering, Inc.	11
Continental Specialties Corporation	32	Johanson/Dielectrics, Inc.	170	Synertek	129
Curtis Industries, Inc.	165				
Custom Electronics, Inc.	154	Kaman Sciences Corp.	172	TT Electronics, Inc.	171
Cutler-Hammer, Specialty Products Division	65	Kay Elemetrics Corp.	165	TRW Power Semiconductors, an Electronic Components Division of TRW, Inc.	31
		Krohn-Hite Corporation	171	Tektronix, Inc.	4, 5, 49, 55, 102, 103
Data Display Products	46	Kurz-Kasch, Inc.	116	Teletype Corporation	111
Data I/O	61			Tenney Engineering, Inc.	153
Data Precision Corporation	62	LFE Corporation	35	Theta-J Relays, Inc.	151
Data Tech, A Division of Penril Corp.	16, 17	LogiMetrics	156	Todd Products Co.	141
Decitek, A Division of Jamesbury Corp.	154			Traktex	173
Delco Electronics, Division of General Motors	44, 45	Magnecraft Electric Company	39	Tucker Electronics Co.	173
Dialight, A North American Philips Company	117	Marconi Instruments, Division of Marconi Electronics Inc.	64E		
Digital Equipment Corporation, Components Group	81	Micro-Line, Division of Bausch & Lomb	157	U. S. Capacitor Corporation	33
Disc Instruments, Inc.	135	Micropac Industries, Inc.	145	Underwriters' Safety Device Company	163
		Minelco Division/General Time Corp.	166, 173		
EECO	29	Mini-Circuits Laboratory, A Division of Scientific Components Corp.	2	Vector Electronic Co., Inc.	152
EMM Semi, A Division of Electronic Memories & Magnetics Corporation	24	Mini-Software, Inc.	173	Viola Grange, The	173
Edmund Scientific Company	169	MuRata Corporation of America	118	Viking Industries, Inc.	64D
Efratom California, Inc.	171			Vishay Resistive Systems Group	37
Elec-Trol, Inc.	120, 175	NEC Microcomputers, Inc.	140, 141		
Electro Industries	170	National Semiconductor Corporation	58, 59	Wavetek San Diego, Inc.	1
Electro Space Fabricators, Inc.	171	Newport Laboratories, Inc.	134	Webtek Corporation	170
Electro Switch Corp.	163	Nichicon Corporation	139	Weston Instruments, Inc.	123
Electrocube Corp.	122	Nicolet Scientific Corp.	156		
Electronic Design	64F, 144D, 117, 170			Zero Manufacturing Co.	131
Electronic Molding Corporation	161				
Electronic Navigation Industries	130				

\*Advertisers in non-U.S. edition

# OAK SOLENOIDS

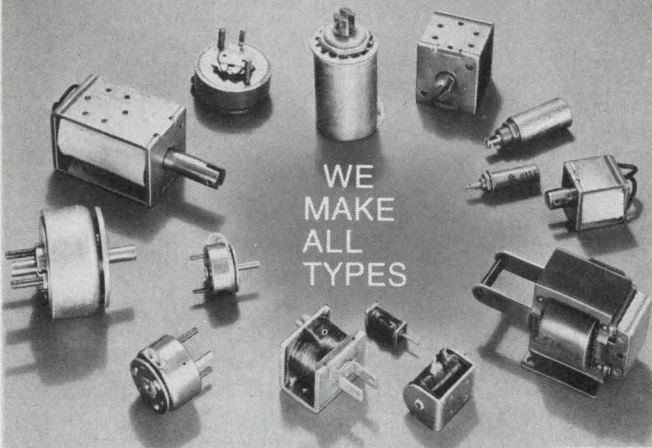

WE  
MAKE  
ALL  
TYPES

**Rotary  
C-Frame  
Box Frame  
Laminated  
Tubular  
Flat-pack**

Now you can look to one source for your solenoid requirements and for unbiased advice on the type best suited to your needs... because Oak builds them all. Call toll free 800-435-6106 for price and delivery information or write for technical bulletins describing the complete Oak line of solenoid products.

**OAK Industries Inc.**  
SWITCH DIVISION / CRYSTAL LAKE, ILLINOIS 60014

CIRCLE NUMBER 137

## SOLID STATE RELAYS WITH SOMETHING EXTRA

From Elec-Trol, a complete line of 3 to 45 Amp, 120 to 480 VAC output, AC or DC input Solid State Relays, and custom designs to meet your needs. All feature: **Zero Crossover Switching** to eliminate RF noise and load current or voltage surges. **Photo Isolation between Input & Output.** **Input Current Limiter** on all DC models prevents relay closure by input transients & increases LED life. **Built-in Snubber Network in Output** prevents uncontrolled operation due to load-line transients. **IC Compatibility and Reverse Polarity Protection** on all DC models. Call or write for complete information today.

26477 N. Golden Valley Road • Saugus, Calif. 91350  
(805) 252-8330 • (213) 788-7292 • TWX 910-336-1556

**ELEC-TROL, INC.**

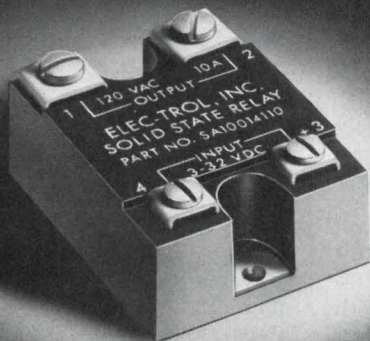

eem

CIRCLE NUMBER 138

ELECTRONIC DESIGN 10, May 10, 1976

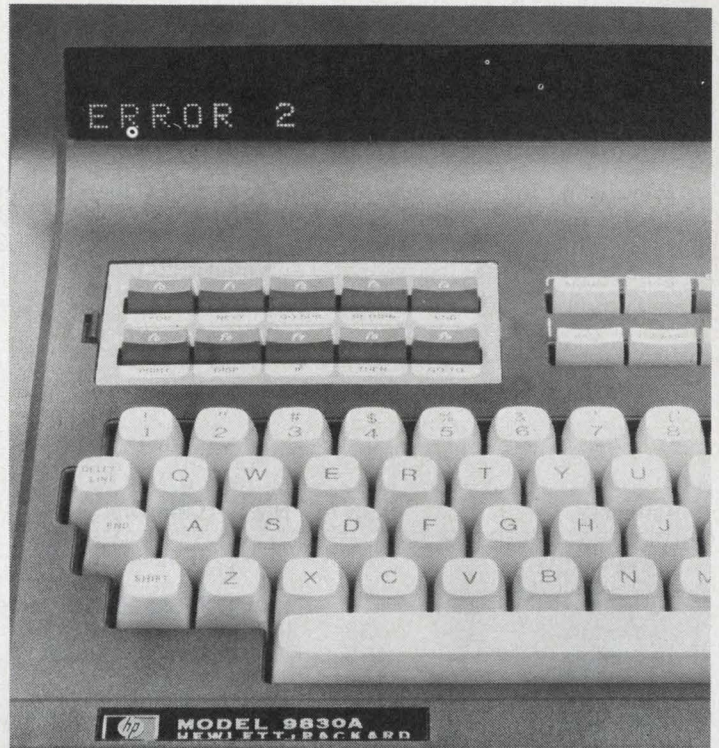

## HP 9830A\* users... forget memory overflow problems

With our EM-30 Extended Memory System, you'll eliminate the need to redesign programs because of memory overflow.

Make it easy for yourself... an EM-30 gives you these important features:

- **economic expansion** of your HP 9830A\* read/write memory to 32K bytes
- the ability to **easily work** with large arrays of data without peripheral storage
- **full compatibility** with all software, peripherals and HP ROM options
- easy installation in minutes—the EM-30 is a direct plug-in replacement for HP memory.

**NEW! Powerful ROMs on the way.** A RUN FAST command will greatly accelerate program execution. And a LIST ALL command permits listing of all programs. These capabilities will be conditionally available to buyers of EM-30 memory systems.

**As low as \$4230 for 32K.** Expand a fully loaded 15K-byte 9830 to 32K for only \$4230. By adding the EM-30, your HP 9830A\* will give you minicomputer memory capacity with desk-top convenience. And you'll get the same high quality and reliability you'd expect from an HP product.

**Introductory Offer.** Send us a list of your ROMs, options and peripherals, we'll send you a cassette with a collection of appropriate commercial programs. And we'll add your name to a growing list of 9830 users interested in exchanging programs and techniques.

For more information, call us collect at (213) 966-7431. Or write Infotek Systems, 733 E. Edna Place, Covina, Ca. 91723.

\*a product of The Hewlett-Packard Company



**Infotek Systems**

CIRCLE NUMBER 139

175

# Product Index

**Information Retrieval Service.** New Products, Evaluation Samples (ES), Design Aids (DA), Application Notes (AN), and New Literature (NL) in this issue are listed here with page and Information Retrieval numbers. Reader requests will be promptly processed by computer and mailed to the manufacturer within three days.

Category	Page	IRN	Category	Page	IRN	Category	Page	IRN
<b>Components</b>			transistors	117	60	microprocessors	159	121
CRT displays	15	11	<b>Integrated Circuits</b>			programmer kits	53	502
capacitors	6	4	amplifier	134	347	single-board $\mu$ C	54	503
capacitors	33	251	CMOS, custom	135	348	<b>Microwaves &amp; Lasers</b>		
capacitors	138	85	cameras	133	79	attenuators	165	131
capacitors	144	92	channel selector	136	352	isolator	130	339
capacitors	152	109	converter	133	344	radiation meter	131	343
capacitors	154	114	counters	134	345	signal generator	128	337
ceramic capacitors	118	62	IC, DVM	132	301	<b>Modules &amp; Subassemblies</b>		
cermet trimmers	144A	141	interface	135	349	amplifier	137	84
circuit breakers	93	49	PROMs	26	20	amplifier, log	156	392
circuit breakers	164	130	RAM, 4-k	24	18	amp, programmable	155	389
displays	60	41	RAMs, 1-k	136	350	converters, MIL	156	393
filter	101	50	ROM	136	351	converters, synchro	155	391
filters	162	126	regulator	136	353	driver, display	154	387
lamps	128	72	shift registers	107	53	high rel hybrids	18	13
passive components	14	151	sonar system	134	346	hybrid circuits	161	123
relay	144C	143	$\mu$ P DAC	109	54	regulators, HV	145	94
relays	39	28	<b>Instrumentation</b>			switch, counter/timer	155	390
relays	112	56	amplifier	134	80	system, data-acq.	154	388
relays	136	82	backplane tester	149	375	<b>Packaging &amp; Materials</b>		
relays, reed	120	64	bridges	23	17	bus boards	92	48
relays, reed	120	65	chamber, test	153	111	connector, card-edge	122	325
relays, solid-state	151	107	DMM	62	274	connectors	52	37
relays, solid-state	161	124	DPM	19	14	connectors	120	321
servometers, dc	146	97	digital clocks	147	98	enclosures	131	76
stepper motor	10	7	digital VOM	127	71	fans	148	102
switches	40	29	function generator	49	241	knobs	149	103
switches	65	45	IC tester	141	355	legends, keycap	120	323
switches & indicators	137	83	logic probe	32	24	logic cards	152	110
switches, rotary	163	129	logic state analyzer	50	35	magnetic shields, PM	144	93
switches, thumbwheel	21	15	logic trigger	22	16	packaging hardware	11	8
trimmer resistors	144B	142	oscilloscope	103	271	scales	157	119
trimmers	57	39	oscilloscope	149	376	socket cards	29	21
trimmers	11	282	panel meters	35	26	solder remover	126	333
trimmers	11	283	power amplifier	130	74	terminal blocks	163	128
trimmers, DIP	166	134	rf sweep generator	145	365	terminal blocks	165	138
<b>Data Processing</b>			recorder	155	115	terminals, PC	132	78
a/d converter card	118	320	recorder, linescan	25	19	tool organizer	124	327
CRT terminal	116	58	recorder/reproducer	51	36	<b>Power Sources</b>		
calculator	114	307	scope camera	149	374	ac power source	160	303
calculators	142	88	scope probes	147	369	ac power source	162	516
cassette recorder	168	136	test set	156	118	dc/dc converters	162	514
computer interface	142	89	<b>Microprocessor Design</b>			dc supplies	129	73
data-acq. system	143	90	board	56	504	floppy-disc supply	162	517
data modems	115	57	component tester	56	505	open-frame supply	162	515
digital printers	150	106	ECL processor	53	501	power supplies	64	44
display terminals	150	105	microcomputers	17	12	power supplies	105	295
PROM programmer	30	22	microprocessors	145	95	power supplies	121	66
printer	111	55	microprocessors	147	99	power supplies	122	67
tape reader	154	113	microprocessors	149	104	power supplies	146	96
<b>Discrete Semiconductors</b>			microprocessors	151	108	power supplies	148	101
indicators	117	61	microprocessors	153	112	power supplies	160	122
indicators, LED	157	510	microprocessors	155	116	power supply	141	87
lamps, LED	157	513	microprocessors	157	120			
transistors	9	6						



## New multiturn trimmer... in low profile design.

From the trimmer specialists at CTS comes the new "low .250" profile"... "low cost" Series 186 cermet trimmer. A *double value* in 17-turn  $\frac{3}{4}$ " rectilinear design.

Add to that the low  $\pm 100$  ppm/ $^{\circ}$ C standard TC, multipaddle contractor, clutch stops, reliable-stable CTS cermet resistance element and power rating to  $\frac{3}{4}$  watt @ 25 $^{\circ}$ C... and you have one super trimmer value!

It's available in two popular pin configurations — .100" and .200" offset side-to-side spacing.

Enjoy greater economy in data processing, communications, instrument or equipment applications by specifying the new CTS Series 186 cermet trimmer. For complete information write **CTS OF WEST LIBERTY, INC.**, 6800 County Road 189, P.O. Box 266, West Liberty, Ohio 43357. Phone (513) 465-3030.

**CTS CORPORATION**

Elkhart, Indiana

A world leader in cermet and variable resistor technology.



CIRCLE NUMBER 283

What's new in solid state . . .

# Announcing the 1-chip COSMAC CPU and the 4-chip CMOS system.

Now, a CMOS system that really delivers the promise of the microprocessor. It's the expanded RCA 1800 family with CDP1802, our new one-chip COSMAC CPU. And it gives you an unsurpassed combination of flexibility, performance and cost effectiveness.

This cost effectiveness starts with price: \$23.50 for the CDP1802CD in 100-piece quantities. But there's more to it.

Simple COSMAC architecture lowers memory costs because of 1-byte instructions and internal address pointers. It also reduces I/O costs. Plus design and learning costs.

Then you have the familiar CMOS savings. Single power supply. Single-phase clock. Less cooling and other equipment, thanks to low power and high tolerances.

For all these reasons, we believe no other microprocessor matches the RCA 1800 for system cost effectiveness. What's more, you can get the whole system from us: CPU, ROM, RAM, I/O. Everything you need including complete design support. From the first house in CMOS.

For more information, contact your local RCA Solid State distributor. Or RCA.

Write: RCA Solid State, Box 3200, Somerville, NJ 08876; Ste. Anne de Bellevue H9X 3L3, Canada; Sunbury-on-Thames, U.K.; Fuji Bldg., Tokyo, Japan.

- COSMAC ARCHITECTURE
- DESIGN AIDS
- SUPPORT CIRCUITS
- CMOS FEATURES
- DESIGN EASE
- HIGH SPEED
- LOW PRICE

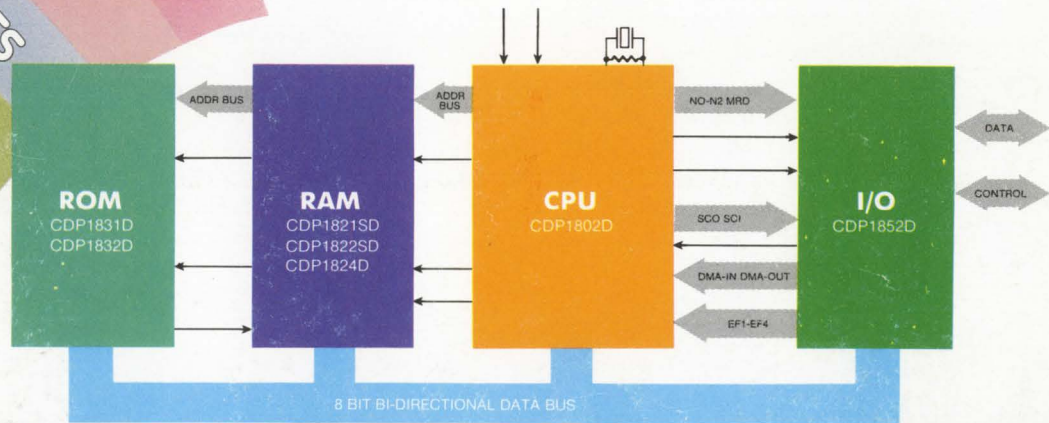

CIRCLE NUMBER 284

# RCA

RCA 1800. The full spectrum in one low cost system.