

CHILTON'S **THE**  
**ELECTRONIC**  
**ENGINEER**

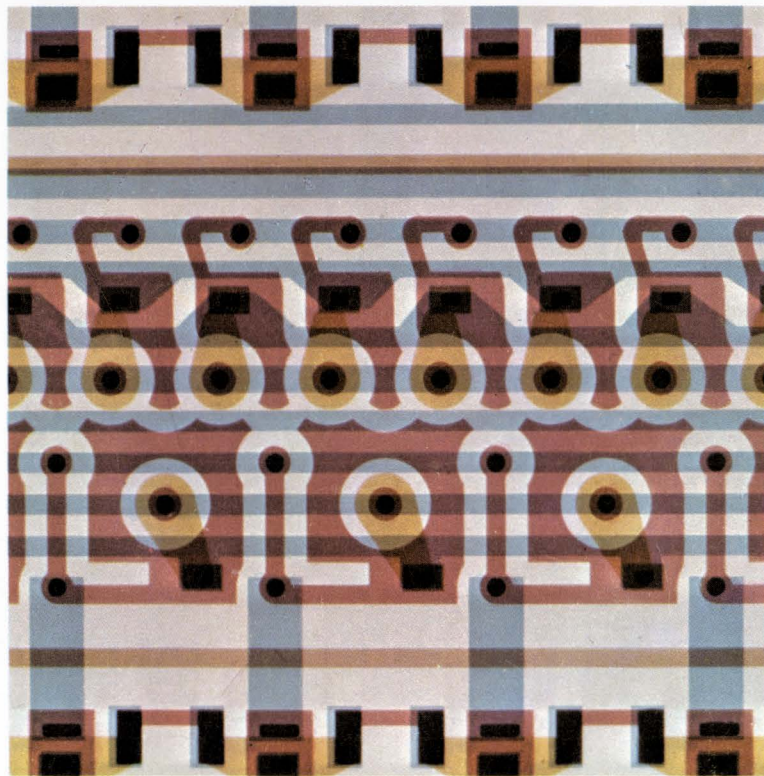

Functional integration—a step closer to molecular electronics? p. 32

**Does anyone care about your future? p. 42**

**Modern analog multipliers p. 75**

**Designing wide range multivibrators p. 83**

**Course on MOS ICs, part 3 p. 61**

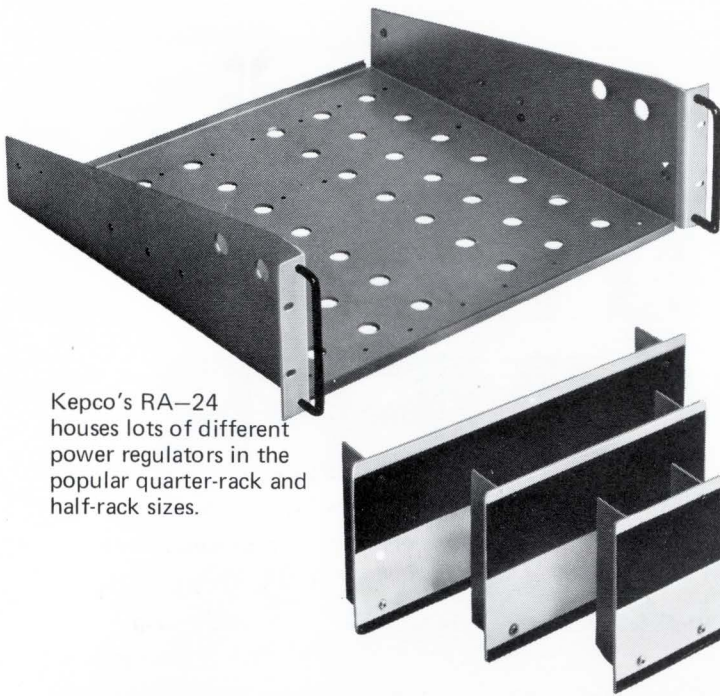

Kepeco's RA-24 houses lots of different power regulators in the popular quarter-rack and half-rack sizes.

# KEPCO

## 4-in-a-RACK

### POWER SUPPLY MOUNTING SYSTEM



The Kepeco 4-in-a-rack hardware system offers a flexible means for combining various sized power units in standard rack dimensions.

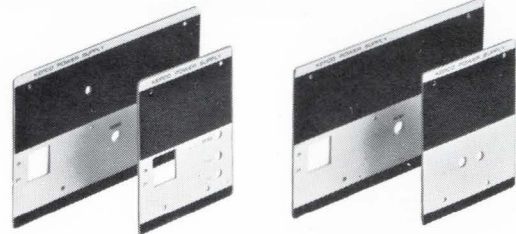

Panel adapters make easy the assembly of power modules into custom multioutput combinations.

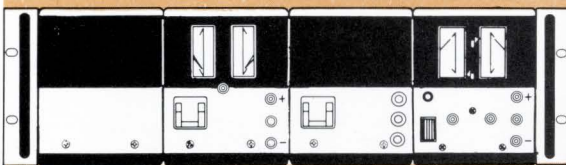

**CPS/JQE** Kepeco's extensive JQE and CPS inventory provides 36 different voltage regulating power supplies in models from 6 volts to 100 volts, 1 ampere to 90 amperes, in quarter-rack, half-rack and full-rack sizes. A precision I-C regulating amplifier delivers 0.0005% line, 0.005% load regulation. All models are fully programmable and are available in fast-programming models also.

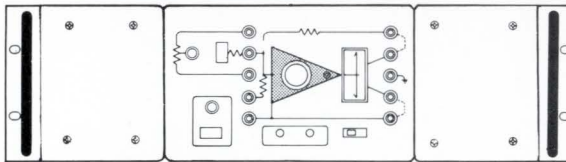

**BOP** The unique Bipolar Operational Power Amplifier/Power Supply provides four quadrant operation with outputs of + to -36 volts and + to -72 volts at  $\pm 1.5$  amperes and  $\pm 5$  amperes. The BOP's will deliver full output modulated from d-c to 20 kHz. The front panel of the metered models is a complete operational patch board with summing inputs and adjustable feedback.

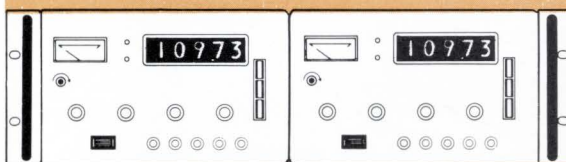

**PVS** This low-cost, 4½ digit calibrator features 0.02% absolute display accuracy with 0.0005% line and 0.001% load regulation (0-1 ampere). The readout is a clear, easy-to-read digital display from 0.0000 volts to 100.00 volts in three factor-of-ten ranges.

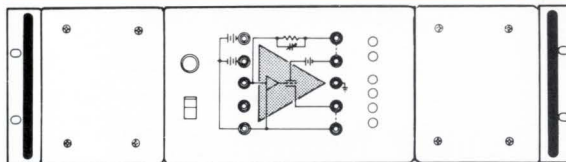

**OPS (Hybrid)** Three of the highest voltage op-amps going! 0-500 volts/40 mA, 0-1000V/20 mA, 0-2000V/10 mA. All feature Kepeco's operational patch panel making input and feedback connections easy. Gain  $> 0.5 \times 10^6$  V/V; slewing rate  $> 1V/\mu\text{sec}$ .

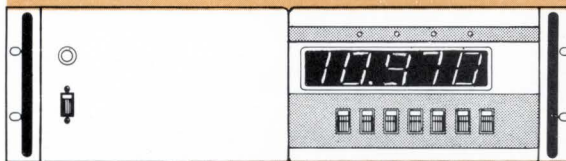

**DPD/DPR** A digital programming system offering a 3½ digit, 4½ digit or 5½ digit computer interface for any of the JQE, CPS, BOP, OPS and many other Kepeco supplies. Serial or parallel input formats with keyboard input too.

NOW YOU CAN RACK UP POWER AND SUPPORT EQUIPMENT SIMPLY AND EASILY IN A FLEXIBLE MOUNTING SYSTEM. FOR SPECIFICATIONS AND APPLICATIONS NOTES - WRITE DEPARTMENT DG-19

# KEPCO®

KEPCO, INC. • 131-38 SANFORD AVENUE • FLUSHING, N.Y. 11352 • (212) 461-7000 • TWX # 710-582-2631 • Cable: KEPCOPOWER NEWYORK

Circle 1 on Inquiry Card

**For proven performance...small size...moderate cost...**

## order **METFILM<sup>®</sup> 'E'** **ORANGE DROP<sup>®</sup>** **CAPACITORS**

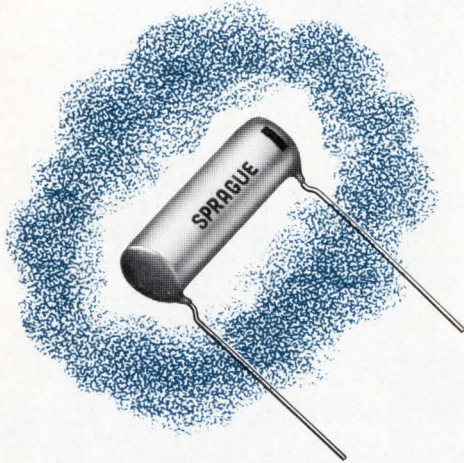

INFORMATION RETRIEVAL NO. 4

- Space-saving metallized PETP polyester-film capacitors with excellent capacitance stability, high insulation resistance
- Capacitor sections assembled under controlled atmospheric conditions and protected against moisture by a wax-free conformal coating of epoxy
- Radial leads, straight or crimped, for mounting on printed wiring boards
- Voltage ratings, 100 thru 600 volts d-c
- Operating temperature range, -55 C to +85 C
- Request Engineering Bulletin 2040

45C-9159

**For low-cost capacitors to cope with corona...**

## use **HIGH-VOLTAGE** **TELECAP<sup>®</sup> DIFILM<sup>®</sup>** **CAPACITORS**

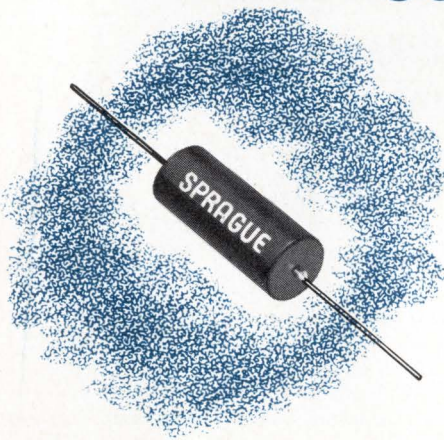

INFORMATION RETRIEVAL NO. 5

- Expressly designed to minimize corona effects in high voltage circuits
- Well suited for oscilloscopes, power supplies of electronic precipitators, electrostatic copying machines, and similar devices
- Series-wound paper/PETP-polyester film dielectric section provides higher ripple voltage capability than conventional extended-foil construction
- Thick-walled pre-molded phenolic case prevents oil seepage
- Voltage ratings: 3000 thru 10,000 volts d-c
- Request Engineering Bulletin 2011

45C-9160

For Engineering Bulletins as noted above, write to:  
Technical Literature Service, Sprague Electric Co., 233  
Marshall Street, North Adams, Massachusetts 01247



'Sprague' and '®' are registered trademarks of the Sprague Electric Co.

**THE BROAD-LINE PRODUCER OF ELECTRONIC PARTS**

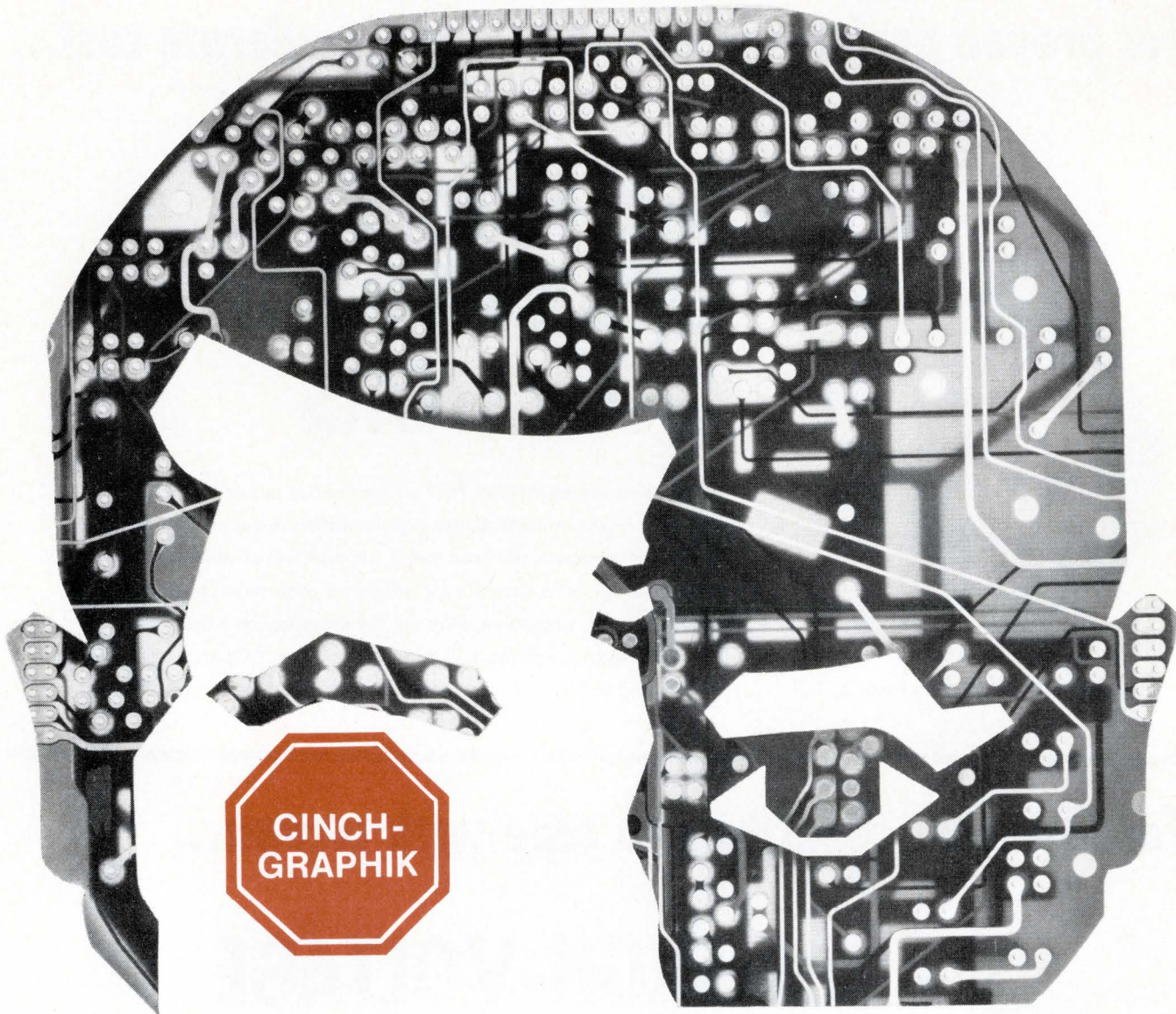

## **your multilayer man for volume production**

Twenty million boards a year make Cinch-Graphik the world's largest independent producer of printed circuits. The industry's most advanced equipment, including an exclusive, 6-ton, 28 foot multilayer camera is housed in a 125,000 square foot plant that has capacity for additional volume production.

For information on how Cinch-Graphik can produce precision boards in volume, for you, contact your Cinch—Sales District Office or Cinch-Graphik, 200 South Turnbull Canyon Road, City of Industry, California 91744, Telephone, (213) 333-1201.

**CINCH-GRAPHIK**  
DIVISION OF UNITED-CARR

CINCH MANUFACTURING, CINCH-GRAPHIK, CINCH-MONADNOCK AND CINCH-NULINE DIVISIONS OF UNITED-CARR INC., A SUBSIDIARY OF TRW INC.

CG-7008

Editorial . . . . .	9
It happened last month . . . . .	10
Up-to-date . . . . .	12
Forefront . . . . .	17
Western Column . . . . .	25
Bay Soundings . . . . .	29
Speak up . . . . .	37
Calendar . . . . .	40
Careers . . . . .	42
Welcome . . . . .	46
Courses . . . . .	50
Seminars . . . . .	51
Design Features . . . . .	75
IC Ideas . . . . .	87
Abstracts . . . . .	95
New Product Feature . . . . .	98
Microworld New Products . . . . .	106
Lab New Products . . . . .	116
Systems New Products . . . . .	118
New Products . . . . .	120
Literature . . . . .	131
Books . . . . .	142
Ad Index . . . . .	143
Product Index . . . . .	144

**Copy is "spotted" with fiber optics 12**

Light spots passing through fiber optic bundles are the heart of a new facsimile transmitter.

**MOS integrated circuits . . . part three 61**

This issue includes the Third installment of a six-part course on integrated circuits made with metal-oxide semiconductors (MOS).

**Interfacing MOS and bipolar logic 62**

These circuits can help you ease the communication problem between MOS and bipolar.

By Tom Reynolds

**MOS arrays in a data terminal 67**

MOS and data terminals—here's why one company thinks they are a winning combination.

By Richard Perrin

**MOS shift registers in arithmetic operations 71**

Here's how the new generation of desk calculators uses MOS.

By Jack Irwin

**Modern techniques of analog multiplication 75**

Multiplier differences in construction and performance mean a wider choice for you.

By Tom Cate

**Variable frequency multivibrator has wide range 83**

With this circuit you can get wide frequency range with variable frequency capabilities. Exact component values can be easily calculated with the given formulas.

By R. J. Surprenant

**IC Ideas 87**

- Low frequency, sine wave crystal oscillator . . . . .by Richard S. Baggett
- Op amp makes unique one-shot . . . . .by Maxwell Strange
- TTL compatible lamp driver . . . . .by Hal Koester
- Zero input impedance preamp . . . . .by Albert E. Hayes
- One-shot triggers on both edges of input . . . . .by Ken Erickson
- Op amp phase shifter for 0 or 180° . . . . .by Irwin Cohen

**Low-frequency sweepers beat their way upstream 98**

**Latch on to phase-locked loops 102**

The first monolithic, phase-locked-loop ICs are here. A big system on a little chip, each package holds all the components of the classical loop: phase comparator, error amplifier, lowpass filter, and VCO.

**COVER**

Electrical integration—introduced by Barrie Gilbert of Tektronix at the ISSCC—substantially reduces the area taken by ICs. The cover shows a 6 x 9-mil region with three stages of one decade of a 4-decade counter with memory and d-a conversion. The pear-shaped regions are buried layers that couple collectors of npn drivers to bases of pnp transistors. Story on page 32.

# now available... **7** INNOVATIVE APPLICATIONS OF INTEGRATED CIRCUITS TO COMMUNICATIONS

In response to popular demand, we are making available the proceedings of the recent seminar and workshop on the "APPLICATIONS OF INTEGRATED CIRCUITS TO COMMUNICATIONS" which was sponsored by *The Electronic Engineer*.

Moderated by J. Lightsey Wallace of the Atlantic Research Corporation, the seminar included a series of papers which included 7 innovative approaches to practical applications of the new families of ICs to communications and consumer products.

The papers cover the following 7 subjects:

### AGC—It's the Old Dynamic-Range With Good Signal-to-Noise Trick

Jack MacIntosh  
Tom Mills  
Fairchild Semiconductor

### The Phase-Locked Loop

Arthur Fury  
Signetics Corp.

### AM/FM Receivers with ICs

Ronald W. Lutz  
Sprague Electric Co.

### Large-scale Integration of TV Circuits

S. Gertzis  
Amperex Electronic Corp.

### Applications of a Low-Power Operational Transconductance Amplifier (OTA) IC Array in Communications Systems

H. A. Wittinger  
RCA Electronic Components

### Integration of Complex Functions

Ted Hanna  
National Semiconductor Corp.

### Modulation, RF/IF Amplification, and Multiplexing

Roy Hejhall  
Motorola Semiconductor Products, Inc.

These innovative and practical approaches have attracted so much attention in the technical community that they are now being made available to those who were unable to attend the seminar. Your copy is available now. To get it send the coupon below with your check or money order for \$6.00 to *The Electronic Engineer*. Your copy will be forwarded to you by return mail.

Yes, I want \_\_\_\_\_ copy(ies) of the papers on the "APPLICATIONS OF INTEGRATED CIRCUITS TO COMMUNICATIONS." My check in the amount of \$\_\_\_\_\_ for \_\_\_\_\_ copy(ies) is enclosed. Send to me at the following address:

Make check or money order payable to Communications ICs  
The Electronic Engineer Magazine  
Chestnut & 56th Streets, Phila., Pa. 19139 E-4

Name \_\_\_\_\_ Title \_\_\_\_\_  
Company \_\_\_\_\_ Division \_\_\_\_\_  
Street \_\_\_\_\_  
City \_\_\_\_\_ State \_\_\_\_\_ Zip \_\_\_\_\_

K. Robert Brink, *Publisher*

Alberto Socolovsky, *Editor*

John E. Hickey, Jr., *Managing Editor*

Smedley B. Ruth, *Associate Editor*

Sheldon Edelman, *Western Editor S.F.*

Stephen A. Thompson, *Western Editor L.A.*

Arthur J. Boyle, *Technical Editor*

John McNichol, *Assistant Editor*

Dr. O. M. Salati, *Consultant*

Anne Axe, *Editorial Assistant*

Alice C. Bach, *Editorial Assistant*

Lynda Rothstein, *Editorial Assistant*

Deborah P. Wilkins, *Editorial Assistant*

Mae Moyer, *Editorial Reader Service*

Andrew Mittelbrunn, *Chilton Art Director*

Phaue Featherston, *Artist*

George Baker, *Washington News Bureau*  
Neil Regeimbal,

Chilton   

Executive and Editorial Offices:  
One Decker Square, Bala-Cynwyd, Pa. 19004  
Tel. (215) SH 8-2000

Address Mail to: 56th & Chestnut Sts.  
Philadelphia, Pa. 19139

Western Offices:  
Stephen A. Thompson, 1543 W. Olympic Blvd., Los Angeles,  
Calif. 90015  
Tel. (213) DU 7-1271

Sheldon Z. Edelman, 199 First St. Rm. 335  
Los Altos, Calif. 94022  
Tel. (415) 941-6655

Chilton Officers & Directors: Chairman of the Board: G. C. Buzby; President: R. E. McKenna; Financial Vice-President: S. Appleby; Senior Vice-Presidents: J. Kofron, L. King; Publishing Vice-Presidents: C. W. Hevner, W. A. Barbour, R. H. Groves, K. Robert Brink; Treasurer: James Miades; Secretary: J. A. Montgomery, Jr.; Other Directors: T. J. Casper, S. H. Collmann, R. Rimbach, Jr., J. P. Kushnerick, R. O. Nelson; Asst. Secretary: I. C. Holloway.

Monthly publication of Chilton Company, Chestnut & 56th Sts., Phila., Pa. 19139. (Area Code 215) SHerwood 8-2000. Controlled circulation postage paid at Philadelphia, Pa. \$1 a copy. Subscription rates U. S. and U. S. Possessions: 1 yr. \$12.00; 2 yrs. \$20.00. Canada 1 year \$14.00; 2 yrs. \$25.00. All other countries 1 yr. \$20.00; 2 yrs. \$35.00. © Chilton Company 1970. Title Reg. U.S. Patent Office. Reproduction or reprinting prohibited except by written authorization.

The Chilton Electronics and Instrumentation Group •  
The Electronic Engineer ■ Instruments and Control  
Systems ■ Instrument & Apparatus News ■ Medical  
Electronics News ■ Electronic Component News

# Unitek Bonders Stack Up Best

Build your bonding line with the source that's proven best in the field... take UNITEK

In case after case of tough on-line comparison testing, more leading firms take UNITEK because they've proved that when the chips are down you get the Best Chance for the Best Choice... here's why... flexibility, repeatability, and service in-depth.

First, you get wider work-choice options. Each UNITEK bonder is built for production-versatility... handles all package types by simply interchanging optional accessories. Single units, rack-feed or automatic strip-feed handling of conventional packages... hybrids, too, all available on virtually every bonder. Take exactly the options you need now... add later when you need to... the closest thing yet to custom making your production line.

Pinpoint repeatability is another very big reason. Prototype work or line work, it's guaranteed by exclusive rugged, durable UNITEK construction, perfect process controllability and ultra-simple operation. Training and maintenance stay low... rates and yields stay up... lot-run after lot-run.

Third... service... expert guidance you can count on; after you specify as well as before. Your

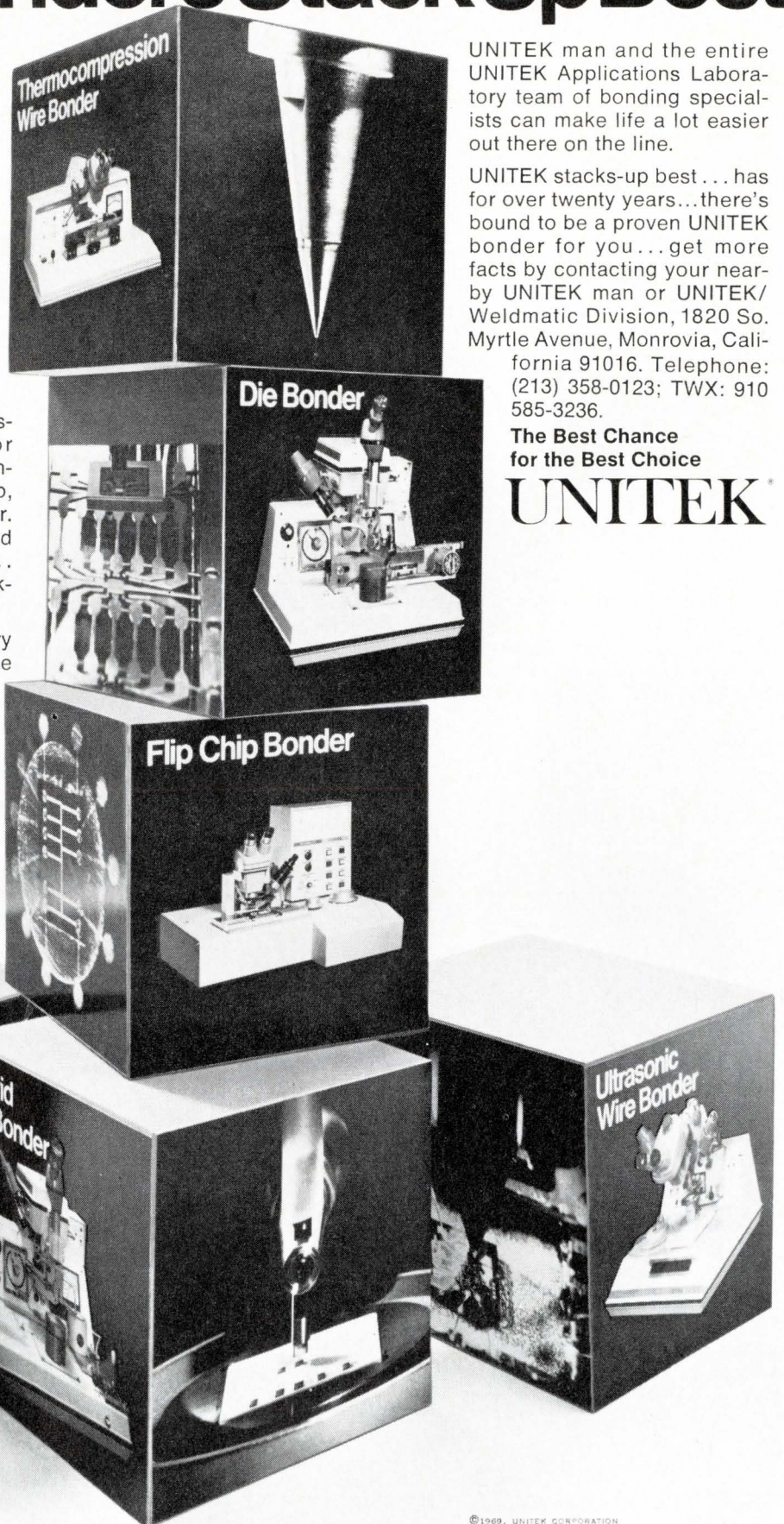

UNITEK man and the entire UNITEK Applications Laboratory team of bonding specialists can make life a lot easier out there on the line.

UNITEK stacks-up best... has for over twenty years... there's bound to be a proven UNITEK bonder for you... get more facts by contacting your nearby UNITEK man or UNITEK/Weldmatic Division, 1820 So. Myrtle Avenue, Monrovia, California 91016. Telephone: (213) 358-0123; TWX: 910 585-3236.

The Best Chance  
for the Best Choice  
**UNITEK**

©1969, UNITEK CORPORATION

# Why the bankers gave us the money:

From left: W. Jerry Sanders III, President and Chairman of the Board. D. John Carey, Managing Director of Complex Digital Operations. Sven E. Simonsen, Director of Engineering, Complex Digital Operations. Frank T. Botte, Director of Development, Analog Operations. James N. Giles, Director of Engineering, Analog Operations. Edwin J. Turney, Director of Sales and Administration. Jack F. Gifford, Director of Marketing and Business Development. R. Lawrence Stenger, Managing Director, Analog Operations.





At a time when credit couldn't get any tighter without twanging, when the semiconductor industry needed another bunch of hotshots like you need a power failure, a new company got the Bank of America, Schröder Rockefeller, The Capital Group, Inc. and Donaldson, Lufkin & Jenrette to give it enough cash, enough credit, enough commitment to make the new company a serious marketing factor before its first anniversary.

This is what we told them:

## 1. We are hotshots.

If you have to call us names, that's as good as any other.

As individuals and as a growing team, the members of this company invented circuits, processes and markets. Each has had a serious technical or marketing position with a major semiconductor firm. Each has his own commitment to excellence.

Let's face it: That's why we got together.

## 2. We know what we're doing.

We're in the large chip MSI and LIC business. Period. No jelly beans. No 10,000-gate freaks. Only the tough-to-make, easy-to-utilize mainstream circuits.

We selected the best people in the business to build (to our specifications) a processing facility that was optimized for the precise, complimentary process control requirements of complex, high performance digital and linear integrated circuits.

We decided to make only one quality of circuit: mil spec reliability or better. By this concentration of technical resources, we're able to get yields that let us sell circuits which meet the most stringent military

reliability requirements and the equally stringent pricing requirements of the commercial market.

And it feels so good, we're going to keep it up.

Oh, yes. Out of our checkered pasts we remembered that there was a kind of annoying difference between employees and owners. So we fixed it. Every employee here is an owner. (As a matter of fact, every owner is an employee except for the bankers.)

## 3. We know who you are.

You're in the fastest-growing part of the market; probably the computer and peripheral equipment business.

You've been had by experts, so you're ready to listen when we say:

**We'll never announce a product that isn't in high volume production, in-house qualified through documented electrical and mechanical life testing, 100% stress tested to MIL STD 883 and in inventory.**

The other reason we got the money is that we told the bankers we'd introduce complete product lines—digital and linear—for sale in volume before we are a year old.

And we will.

# Advanced Micro Devices Inc.

901 Thompson Place, Sunnyvale, California 94086  
Established May 1, 1969

Advanced Micro Devices has perfected the production technology of complex, mainstream digital and linear monolithic circuits. 

# Play Sierra's "Pick-A-Signal-Generator" Game

Place an X in each square describing a feature you think desirable. Playing time: 15 seconds.



<p>Selection of units offering variable frequency coverage (in MHz) of 50-200, 200-500, 500-1000, 1000-1800, and 1800-2500.</p>	<p>Front-panel metering of grid and cathode current.</p>		
<p>Maximum power output from 70 watts (at 400 MHz) to 15 watts (at 2500 MHz)</p>	<p>Logging scale for accurate frequency resetting.</p>	<p>All-solid-state circuitry (save for final output tube, which takes only a few minutes to replace).</p>	<p>Monitor output 35 dB down from main signal.</p>
<p>Front-panel metering of power output.</p>	<p>Built-in capability for CW, internal and external square wave, and pulse-modulated outputs.</p>	<p>Automatic protection against no-load conditions.</p>	<p>Compact—<math>6\frac{3}{4} \times 10 \times 18\frac{1}{2}</math> inches (23 inches with optional 220-volt transformer).</p>

**A potentially profitable pastime for players who make a serious living of testing and calibrating VHF, UHF, and microwave power-measuring equipment.**

We could have called the game Monopoly, but somebody else already had it. After all, we are the only company with a monopoly so far on high-power signal generators having all the features above.

So we'll call our game "Sierra." Sort of fits.

The rules are simple. All you do is check off those features that would appeal to you in a commercial line of high-power signal generators. Begin when ready.

For complete information telling why Sierra's "Pick-A-Signal-Generator" game can make you a winner—and isn't a game to us — write Philco-Ford Corporation, Sierra Electronic Operation, 3885 Bohannon Drive, Menlo Park, California 94025. Or call (415) 322-7222, extension 329.

**PHILCO** 

THE BETTER IDEA PEOPLE IN INSTRUMENTATION

The Electronic Engineer • April 1970

## Electronic isolationism by default

The lights of the New York Coliseum were still warm after this year's IEEE Show, and the equipment exhibited still in transit back to its manufacturers, when the *Salon International des Composants Electroniques*—the largest electronic components show in Europe—opened its doors this month in Paris. About one fifth of the component manufacturers that exhibit in Paris are American, hoping that their excellent product will capture a portion of the fast rising demand for components in Europe. But, will they?

There is no question that new components, such as new medium-scale integrated circuits, high density miniature connectors, new resistive compositions for hybrid circuits and the latest methods to wire computer back panels will always attract the attention of foreign electronic engineers, as long as they remain unchallenged outside the U.S. But, what about the transistors, diodes, capacitors, resistors, connectors and even some of the popular integrated circuits that actually account for the bulk of the expanding market? Will they be able to compete with those made in Europe and Japan on the basis of quality or even price? Or, as is becoming more evident, will government regulations determine their fate?

Richard Simpson, Deputy Assistant Secretary of Commerce, feels that U.S. components need the backing of a strong national standards institute if they are going to penetrate international markets. Such an institute would be in a position to interface with those agencies that control the qualifications of electronic components in their countries. In France, for example, this activity is coordinated by the *Bureau d'Homologation* of the *Comité de Coordination des Télécommunications (CCT)*—an agency of the French Government.

The charter of this agency looks like a combination of the involvement of the EIA, RETMA, and the DoD with electronic components. The specs that *CCT* writes are technically comparable and for the most part based on MIL specs. The types of semiconductors the *Bureau d'Homologation* approves are mostly 1N and 2N numbers. Its *CCQ (Contrôle Centralisé de Qualité)*—a sample testing of electrical parameters, coupled with standards for production testing—is similar to the quality control implemented by many U.S. manufacturers, although it is less stringent (and less expensive) than the requirements for a QPL.

The difference, then, is one of authority. The DoD writes MIL specs in this country but they do not apply to non-military equipment. The EIA committees approve types, but cannot enforce them. And neither can the central standards institute, ANSI (American National Standards Institute), which recently had to drop the initials "US" from its name to avoid conveying the impression that it had government backing. The French *CCT*, on the other hand, is a government agency and nobody questions its right to speak for the French at international transactions.

The institute Mr. Simpson proposes, then, should be a government agency, and the Department of Commerce should sponsor it, instead of merely propose it. Otherwise we will fall back into electronic isolationism for failing to face the challenge of a worldwide market. The manufacturers of these components need the help of our government, and international trade is indeed the proper arena where government can help. American components that are not competitive in price and quality won't make it abroad anyway. But those that are, need someone to back them up. Not just someone who can attest for their quality, but someone with teeth.

*Alberto Socolovsky*  
Editor

# IT HAPPENED LAST MONTH . . .

The editors of THE ELECTRONIC ENGINEER have sifted through the various technical and significant happenings of the past month and selected the items that would be of the most interest or use to you.

**Plastic that behaves like a metal . . .** The first offspring of a new generation of high temperature plastics has been sired by the Carborundum Company. Named Ekonol, it is a sprayable polymer, resistant to over 600°F, self-lubricating, solvent resistant, and has good thermal conductivity and low thermal expansion. The development of Ekonol grew out of a need for high-temperature polymers for abrasive systems. It is said to be the first polymer that can be plasma-sprayed, as well as formed by high speed metallurgical techniques. Its stiffness is about twice that of other polymers, and it will be available in powder form and basic shapes. Applications include use in high-temperature electrical and electronic parts.

**New for information transmission . . .** Hard copy, 8½ x 11 facsimile can now be transmitted over ordinary telephone lines in 50 seconds or less and, in many cases, at a cost less than that of a special delivery letter. Comfax and ComputerPix Corps. have developed two systems for transmission of hard copy and a third for microfilm, microfiche, and microform. This faster speed over telephone lines is possible because of three new electronic devices, for which patents have been issued. The key to the system is an unusual variable-velocity scanner, which, in effect, "skips" bright space and transmits only opaque, informational material. It works fast enough to verify signatures in less than 20 seconds. Comfax and ComputerPix are located at 770 Lexington Ave., New York, N.Y. 10021.

**Microwave entries . . .** Come summer, look for Fairchild Microwave and Optoelectronics to market power transistors for 1- to 2-GHz operation at power levels to, and perhaps beyond, 10 W. The same house will also show low-noise amplifier types with very high gain bandwidth product. Siliconix Inc. also has joined the game via acquisition of key personnel from Microwave Associates (West) who chose not to accompany its semiconductor division when it moved from Sunnyvale back to Burlington, Mass. Siliconix will shortly market L-band FETs, a binary (two distinct capacitance states) varactor, a snap varactor for pulse shaping, and a number of Schottky-diode devices.

**Portable CRT terminal . . .** Logiport/I, Logitron Inc.'s first product, is said by the company to be the industry's first portable CRT terminal. It weighs 25 pounds, includes an alphanumeric keyboard and an integral acoustic coupler. As portable as a stereo, it can provide most of the operating features of larger, high priced console

terminals. The unit is directly interchangeable with a teletype, and doesn't require re-programming on any system. Its design includes a semiconductor memory, a MOS character generator, and a 5 x 7 in. cathode-ray tube display. The display provides sixteen 32-character lines for a total of 512 characters. Logiport/I has been priced at under \$3,000 by the Cambridge, Mass. firm.

**Proton-bombarded photodiodes . . .** The Lincoln Lab of MIT has produced photovoltaic detectors of indium-antimonide by bombarding p-InSb with protons. Proton bombardment forms an n-type layer, 1 μm thick, with an n-p junction of high quality. The interest in n-p diodes of InSb (and on other III-V compounds such as GaAs) stems from their excellent photovoltaic properties. For example, the black body detectivity of the diodes made by Lincoln Lab is  $> 10^{10}$  Hz<sup>1/2</sup>cm/W in the infrared, from 2 to 6 μm. Since n-p diodes of InSb cannot be diffused, and p-n diodes of the same material suffer from surface-state problems, proton bombardment opens the possibility of a reliable production method for such diodes.

**The Air Force needs you . . .** The Air Force Systems Command has closed its area scientific and technical liaison offices (STLO's). But the Air Force Technical Objective Document (TOD) Program will be continued. They invite industry to participate in this program. Through the TOD program, the Air Force communicates with academic, scientific, and industrial research & development organizations. Each document contains technical objectives describing existing or anticipated Air Force requirements. USAF welcomes the ideas, initiatives, and proposals of industry that can help them meet the diversified technological challenges of today and tomorrow. For additional information address the following: Attn: TOD Program, Rome Air Development Ctr., Griffiss AFB, N.Y. 13440.

**Global communications market . . .** Robert W. Sarnoff, Chairman and President of RCA, has called for the creation of a global common market of communications that would transcend narrow national interests. He warned that failure to act promptly on a common communications policy could result in chaos and cost nations all over the world at least \$100 billion a year, over the next decade, in unrealized national development, unfulfilled opportunities in business and trade, and unsatisfied social needs. As an example, Sarnoff cited the failure so far to develop a unified global approach to satellite communications.

# WHY WAIT FOR MICA?

**KEMET® Flat-Kap capacitors with Parylene are smaller, more stable, offer better performance... and they're available now!**

Is the long lead time on mica from India holding up shipments of capacitors for your production line? And do the thick slittings that are necessary with this natural product force you to use a large, high voltage capacitor that will only see nine volts in your circuit? Well, your waiting and wasting days are all over now.

KEMET Flat-Kap capacitors are smaller because Parylene is a very thin, ultra-pure plastic film that can be deposited on high purity aluminum foil. They're more stable because of vacuum impregnation of a solid dielectric. And, they're available now, when you need them, because all the raw materials used are produced here in the United States.

Performance? Just make a quick comparison of an  $0.01 \mu F \pm 1\%$  mica capacitor with a Parylene Film Flat-Kap.



	MICA	FLAT-KAP
Size (Max. Dimension)	.830 x .920 x .450	.310 x .515 x .140
Volume	0.34 in <sup>3</sup>	.022 in <sup>3</sup>
T.C. ppm/°C	0 to + 70	0 ± 50
Stability (typical long-term)	0.1%	0.2%
D.F.	0.2%	0.3%
IR	100,000 Meg.	100,000 Meg.
Cure Material	Dipped Phenolic	Molded Epoxy
Specification	MIL-C-5	MIL-C-5514

So why wait for mica when Flat-Kaps are now available in capacitance ranges from 0.001 to  $0.22 \mu F$  at 50 V DC, with radial or axial leads for easy replacement on your substrate? See your local Union Carbide Representative for complete information.

## COMPONENTS DEPARTMENT

P.O. Box 5928, Greenville, South Carolina 29606. Tel.: (803) 963-7421 TWX: 810-287-2536

Circle 13 on Inquiry Card



THE DISCOVERY COMPANY

## Copy is "spotted" with fiber optics

Light spots passing through fiber optic bundles are the heart of a new facsimile transmitter.

A facsimile transmitter that relies on fiber optics for continuous scanning of copy has been developed at ITT Research Institute for the U.S. Army Electronics Command. An endless belt moves the copy through the scanner, beneath a fiber-optic scanning bar. Over-sized or folded copy, such as maps and copy of varying thickness, runs through without skewing.

Two prototypes differing basically only in size, were delivered to the Army. Maximum scanning width is 8.5 in. for the smaller transmitter and 18.625 in. for the larger model.

The scanning bar is made of three parallel rows of fiber-optic glass fibers positioned side by side. The center row of fibers illuminates the copy by transmitting light to it from an incandescent source. The other two rows collect light reflected from the copy. Copy passes beneath the bar at a distance of 0.003 in. (75  $\mu\text{m}$ ) from the ends of the fibers.

The opposite ends of the row of illuminating fibers are gathered into a circular array (fig. 1), formed around a stationary cylinder. (The cylinder's circumference is equal to the length of the scanning bar.) Light from a small bulb is focused into the end of a single crank-shaped rotating fiber which distributes the light sequentially into the ends of the circular array fibers, one fiber at a time. These fibers convey the light to the copy.

The sequential order of the illuminating fibers is preserved in the circular array. Therefore, when the crank-shaped fiber is rotated three times/second, an illumination spot moves across the copy three times/second. With each traverse the copy is advanced 2 in./min. (The scanner can go at a much faster rate, but the phone lines cannot handle the data at higher speeds.)

Light reflected from the copy is collected by the two rows of fibers flanking the illumination row. These fibers lead to a detector, where the optical signal is converted to an electronic signal by a photodiode. The resulting signal is modulated and amplified for transmission over phone lines at 2400 Hz.

Fig. 2: Facsimile scanner using fiber optics can handle any length of copy for transmission over phone lines.

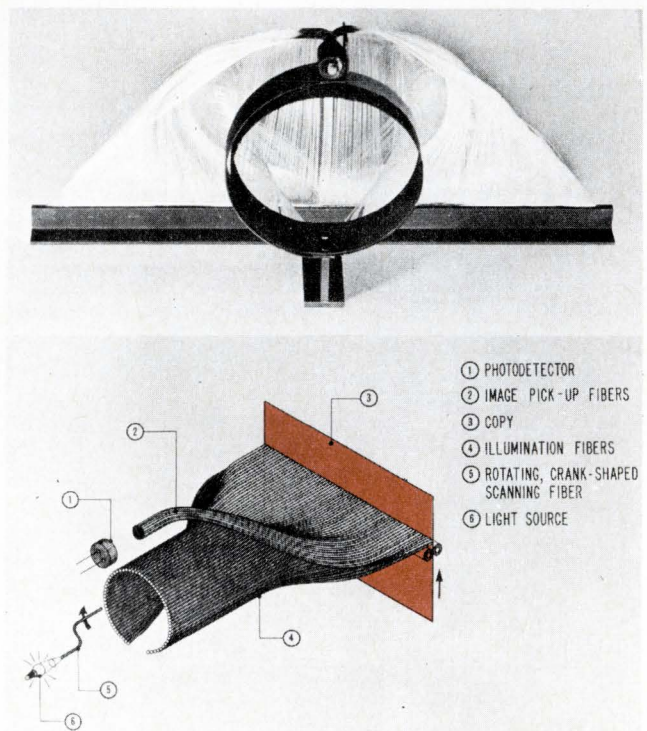
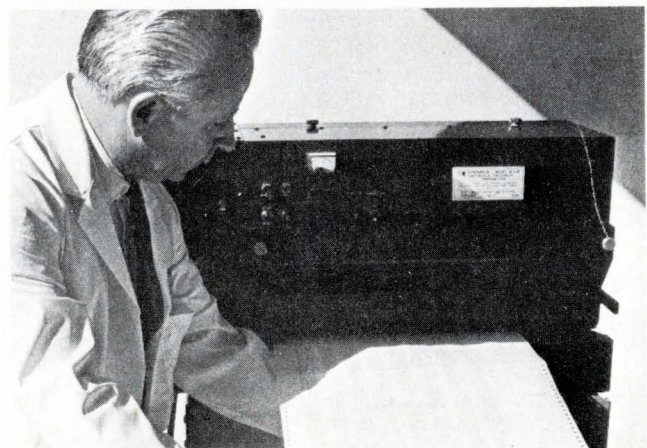

Fig. 1: Sketch and photograph shows fiber optic bundle used in new facsimile scanner. Light is passed through a rotating fiber (5) to individual fibers of the circle (4) to the copy to be transmitted. Reflected light is picked up by "light receivers" (2) and converted to electrical signals.



# Local one-stop shopping for linear ferrites. Only from Ferroxcube.

Only Ferroxcube gives you nationwide ferrite Stocking Centers for fast local off-the-shelf delivery. These Centers are loaded with the industry's broadest line of linear ferrites. Pot cores, toroids, E,U, and I cores, H-cores, shielding beads and RF chokes in an unmatched variety of sizes and materials.

This stock includes our money-saving new ready-coated toroids ... among them our 3E3 type with

permeability of 12,500, the highest on the market.

In short, we give you the widest selection and stock it closest to you. With this unique one-stop shopping, you can turn a design or production crisis into a picnic. Just check the bottom of this ad

for Stocking Center locations.

And remember, these are Ferroxcube ferrites. Made to the tightest tolerances in the business by the oldest, largest supplier of linear ferrites.

Write now for complete technical literature on Ferroxcube linear ferrites, and take your pick. We'll make your shopping cart go like a Ferrari.

**Ferroxcube**   
Saugerties, New York

A NORTH AMERICAN PHILIPS COMPANY



**STOCKING CENTERS:** Burbank, Calif.—(213) 849-6631; Chicago—(312) 832-0450; Dallas—Gillett Industries, (214) 363-0107; Needham Heights, Mass.—(617) 449-1406; New York—Kahgan Sales, (516) 538-2300; Philadelphia—Eastern Components, (215) 927-6262; San Francisco—Wm. J. Purdy Corp., (415) 347-7701; Woodstock, N.Y.—Elna Ferrite Labs, (914) 679-2497; Toronto, Ont.—Philips Electron Devices, Ltd., (416) 425-5161.

**SALES OFFICES:** Atlanta—Cartwright & Bean, (404) 237-2273; Baltimore—Eastern Components, (301) 322-1412; Cedar Rapids—Thomas & Modricin, (319) 377-6261; Denver—Wm. J. Purdy Corp., (303) 794-4283; Huntsville, Ala.—Cartwright & Bean, (205) 852-7670; Hyde Park, N.Y.—R. P. Kennedy Co., (914) 229-2269; Kansas City—Thomas & Modricin, (913) 432-2131; Minneapolis—(612) 920-1830; No. Miami Beach—Cartwright & Bean, (305) 945-2962; Orlando—Cartwright & Bean, (305) 425-8284; Phoenix—(602) 264-3129; Rochester, N.Y.—R. P. Kennedy Co., (716) 271-6322; Saugerties, N.Y.—(914) 246-2811; St. Louis—Thomas & Modricin, (314) 338-6446.

Decimals: Autopoint and scientific notation.

Automatic entry of  $e$  and  $\pi$ .

Ten directly addressable  
storage registers

Programming: Up to  
128 steps. Conditional  
branching and  
automatic entry of  
programs with card reader.



Model 1655. Size: 13" x 13½" x 6½".

**Announcing an important breakthrough for engineers and scientists. Calculators based on the latest MOS/LSI technology. In both printing and display models. Available in over 350 cities coast to coast. Supported by more than 3,300**



Dynamic range:  $10^{-99}$  to  $10^{+99}$



Automatic special functions:  
 $a^x$ ,  $\text{Log}_{10}/\text{Log}_e$ , SIN/COS,  
 $\text{SIN}^{-1}/\text{COS}^{-1}$ ,  $x!$ ,  $\frac{1}{x}$ ,  
Radians to Degrees,  
Single key  $\Sigma x$ ,  $\Sigma x^2$ , N,  
Rectangular to Polar Conversion.

Just plug in  
and put it to work.

Weight: Twelve pounds.

**sales and service technicians.  
Monroe men who know everything  
there is to know about calculators.  
Because calculators are our only business.  
That's how we got our name.  
Monroe. The Calculator Company**

A DIVISION OF LITTON INDUSTRIES

550 Central Avenue, Orange, New Jersey 07050

Circle 15 on Inquiry Card

## Higher frequency GaAs transistor

From the Zurich laboratory of IBM's Research Division comes a new gallium arsenide (GaAs) transistor with a maximum gain of more than 3 dB at 17 GHz. Extrapolation of data indicates that the maximum oscillation frequency may be as high as 30 GHz—2.5 times higher than comparable figures for current models.

The new transistor is referred to as MESFET (MEtal Semiconductor Field Effect Transistor). It uses a Schottky barrier gate, rather than the more familiar insulated gate. A rectifying contact is established directly at the metal-semiconductor's surface.

To achieve microwave frequencies, the gate is only  $1\ \mu\text{m}$  wide. This was made possible by combining contact masking and projection masking techniques. In the final stages, the mask is projected through a high-resolution microscope lens onto the photoresist. The transistor's gate is circular,  $1\ \mu\text{m}$  wide and  $200\ \mu\text{m}$  in circumference, completely surrounding a circular drain. This is, in effect, equivalent to four gates, each  $50\ \mu\text{m}$  long, connected in parallel, and results in a reduction in gate resistance.

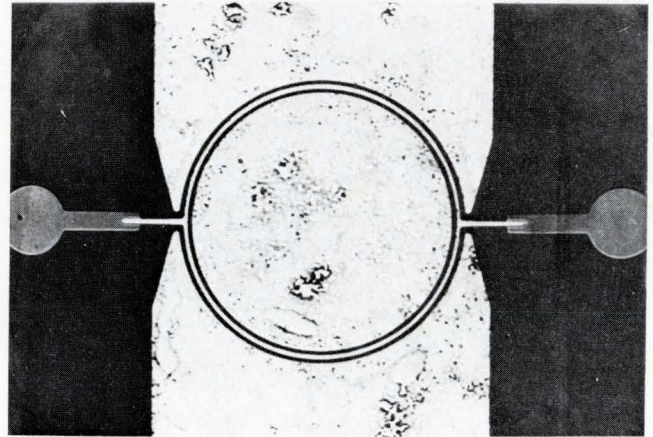

A chromium-nickel-gold sandwich forms the gate. Source and drain are made of gold and gold-tellurium alloy, anchored to the GaAs by a chromium-nickel layer. Testing reveals a drain saturation voltage of 2.5 V at zero gate voltage. Drain saturation current is 38 mA, static transconductance, 65 mA/V mm. Work on the device is continuing at IBM in Zurich.

## Different leak test for ICs

There's a new way to gross-leak test ICs. Sylvania, Woburn, Mass., uses a perfluorinated fluid to do it. The liquid, called Fluorinert, is made by 3M and replaces the use of glycerine, ethylene, hot oil, and other less sensitive and less reliable substances.

Sylvania uses two forms of Fluorinert with different temperature levels. First, they pressurize the low boiling-point liquid (FC-78), in which the ICs are immersed, at 90 psig for three hours. After a delay of not more than one hour, the circuits are then immersed in a container of higher temperature Fluorinert (FC-40) at  $125^\circ$  for the leak detection. No more than ten circuits are examined at one time by the operator. FC-78 has a boiling point of  $50^\circ\text{C}$ ; the slightest amount of it trapped inside a leaking package will readily vaporize in the hot FC-40 Fluorinert, which has a boiling point of  $155^\circ\text{C}$ . If the package leaks, a string of bubbles is easily seen.

While the general method of using a low boiling-point liquid and then placing the package to be checked into a higher boiling-point liquid is not new, this is the first time that inert liquids have been used for this purpose by a volume manufacturer of ICs.



IC receiving a gross-leak test using an inert liquid.



TRIG FUNCTION GENERATORS

Accuracy is the major design variable of trigonometric lookup tables built with MOS read-only memories. Only a few ROMs are needed for most practical applications, but accuracy can be made to increase very rapidly with memory capacity if interpolation techniques are used.

For instance, without interpolation a single 1024-bit ROM can store 128 angular increments and generate an 8-bit output that will be better than 99.9% of the handbook value (Table 1).

ADDRESS	DEGREES	BINARY OUTPUT	DECIMAL SINE
0	0	.00000000	0.000
1	0.7	.00000011	0.012
2	1.4	.00000110	0.023
3	2.1	.00001001	0.035
.	.	.	.
.	.	.	.
127	89.3	.11111111	0.996

TABLE 1. MM422BM/MM522BM Sine Function Generator

If one simply cascaded ROMs to improve input resolution and output accuracy for a high-accuracy trig solution ( $X = \sin \theta$ ) as in Figure 1, large numbers of ROMs might be needed. This 24-ROM system stores 2048 12-bit values of  $\sin x$  (or other trig functions), giving angular resolution of 1 part in  $2^{11}$  (0.05%) and output accuracy of 1 part in  $2^{12}$  (0.024%). The system in Figure 2 has the same resolution and is accurate to the limit of its 12 output bits (0.024%), which makes it just as good. But it only requires four 1024-bit ROMs and three 4-bit TTL full adders, so it only costs about one-fifth as much as the more obvious solution of Figure 1.

Instead of producing  $x = \sin \theta$ , the Figure 2 system divides the angle into two parts and implements the equation

$$\begin{aligned}
 x = \sin \theta &= \sin (M + L) \\
 &= \sin M \cos L + \cos M \sin L
 \end{aligned}$$

It can be programmed for any angular range. Assume the range is 0 to 90 degrees and let M be the 8 most significant bits of  $\theta$  and L be the 3 least significant bits of  $\theta$  ( $\theta$  being the 11-bit input angular increments, equal to  $90^\circ/2048$ , or 0.044 deg.) as in Table 2.

With an 8-bit address, the three 256x4 ROMs will give the 12-bit value of  $\sin M$  at increments of  $M = 90^\circ/2^8$ , or 0.352 deg. The  $\cos L$  can only vary between 1 and 0.99998. So we assume  $\cos L = 1$  and store values of  $\sin M$  at 0.352 deg. resolution

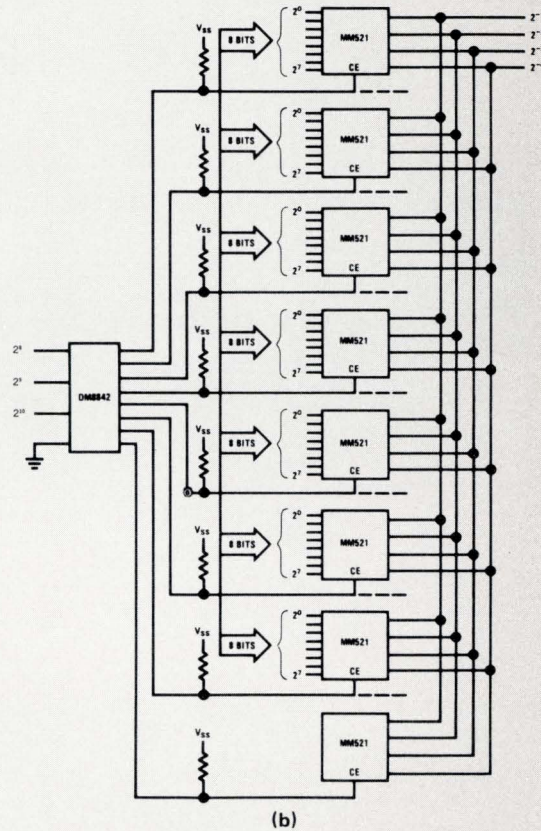
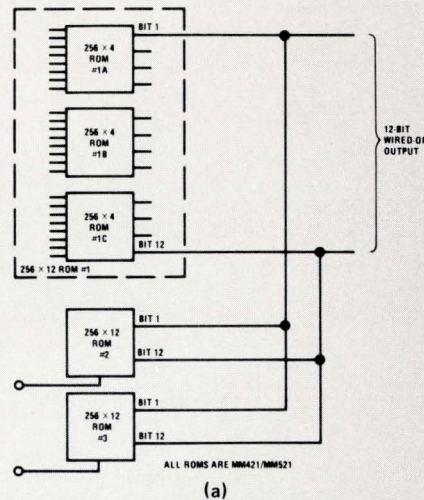

FIGURE 1. Conventional 2048-Increment Sine Table Uses 24 ROMs

in the top three ROMs, reducing the equation to  $\sin \theta = \sin M + \cos M \sin L$

Values of the second term are stored in the fourth ROM. The maximum value of the second term in the above equation can only be  $\cos M \sin L = 0.00539$  where  $\cos M_{max} = 1$ ,  $\sin L_{max} = 0.00539$ . This is the maximum value to be added to  $\sin M$  above. Only the five least significant bits

of a 12-bit output are needed to form the maximum output, so an MM522 is used in its 128x8 configuration.

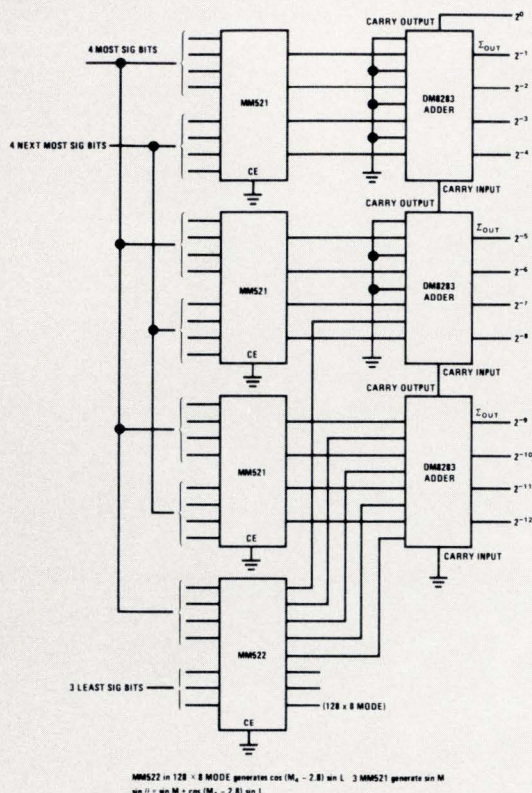

FIGURE 2. Four-ROM Lookup Table Generates 2048 Values of Sin x by Interpolation Technique.

Let the 4 most significant bits of M be called  $M_4$  and the angle at these increments be  $X_m = 90^\circ / 2^4 = 5.63$  deg. Sin L (the 3 least significant bits of  $\theta$ ) has the same maximum as before and  $\cos M_4$  has a maximum of  $\cos 5.63$  deg. = 0.99517, and continuing as follows:

$$\begin{aligned} \cos(11.26) &= 0.98076 \\ \cos(16.89) &= 0.95686 \\ \cos(84.37) &= 0.09810 \end{aligned}$$

through the 16 increments of  $M_4$ . Now

$$\sin \theta = \sin M + \cos M_4 \sin L$$

and the appropriate  $\cos M \sin L$  values are stored in the fourth ROM. In effect, we have divided the  $0^\circ$  to  $90^\circ$  sine curve into 16 slope sectors with  $M_4$ , each sector into 16 subsections with M, and each subsection into 8 interpolation segments with L.

Since we are using an approximation, accuracy is not quite as good as the Figure 1 system. The additional error term is  $\cos L$ , assumed 1 but actually is a variable between 1 and 0.99998. At every eighth increment, L is zero, making  $\cos M$

ADDRESS	M			L
	$M_4$			
0				0
1				1
2				1 0
3				1 1
4				1 0 0
5				1 0 1
6				1 1 0
7				1 1 1
8				1 0 0 0
9				1 0 0 1
16			1 0	0 0 0
32			1 0 0	0 0 0
64			1 0 0 0	0 0 0
128		1	0 0 0 0	0 0 0
256		1 0	0 0 0 0	0 0 0
512		1 0 0	0 0 0 0	0 0 0
1024		1 0 0 0	0 0 0 0	0 0 0
2048-1	1	1 1 1	1 1 1 1	1 1 1

TABLE 2. Programming of 2048-Increment Sine Table

$\sin L=0$ , and  $\sin x = \sin M$  to 12-bit accuracy. Then the error rises to a limit of near 0.002% at every eighth increment where L is 0.352–0.044. This error can be halved by adjusting the fourth ROM's output so that

$$\sin \theta = \sin M + \cos(M - 2.81^\circ) \sin L$$

If five ROMs are used—four MM521's and all eight outputs of the MM522—15-bit accuracy can be achieved, and thus improving the accuracy by a factor of eight. The resolution could also be smaller, of course, if the angular range were smaller as in an application involving a sensor with a limited field of view. Variations of the system could be used to space the increments irregularly to compensate for sensor nonlinearities, to improve accuracy in specific angular ranges.

This example has a binary fraction output, like the sine function generator in Table 1. For instance, the 8-bit output at the 64th increment representing  $\sin x = \sin 45^\circ$  is 10110101. This equals  $1 \times 2^{-1} + 0 \times 2^{-2} + 1 \times 2^{-3} + 1 \times 2^{-4} + 0 \times 2^{-5} + 1 \times 2^{-6} + 0 \times 2^{-7} + 1 \times 2^{-8}$ , which reduces to 181/256 or 0.7070. Handbooks give the four-place sine of  $45^\circ$  as 0.7071, so at this increment the output is accurate to approximately 0.01%. This table, the MM422BM/MM522BM, is used in fast Fourier transform, radar, and other signal-processing applications.

Other standard tables that are available off the shelf include an arctan generator, several code generators (EBCDIC to ASCII, BCD to Selectric, and Selectric to BCD) and ASCII-addressed character generators for electronic, electrical and electromechanical display and printout systems. All interface with TTL logic and operate off 12-volt power supplies. Write for data sheets, or use one of our programming tables to jot down any special input-output logic functions you need.

**National Semiconductor Corporation**

2900 Semiconductor Drive, Santa Clara, California 95051  
(408) 732-5000 / TWX (910) 339-9240



1-70 PRINTED IN U.S.A.

# FOREFRONT

The EE Forefront is a graphical representation of the practical state of the art. You will find here the most advanced components and instruments in their class, classified by the parameter in which they excel.

### A word of caution

Keep in mind the tradeoffs, since any parameter can

be improved at the expense of others. If there is no figure-of-merit available, we either include other significant parameters of the same products, or we provide additional bar graphs for the same products.

Do not use these charts to specify. Get complete specifications first, directly from the manufacturers.

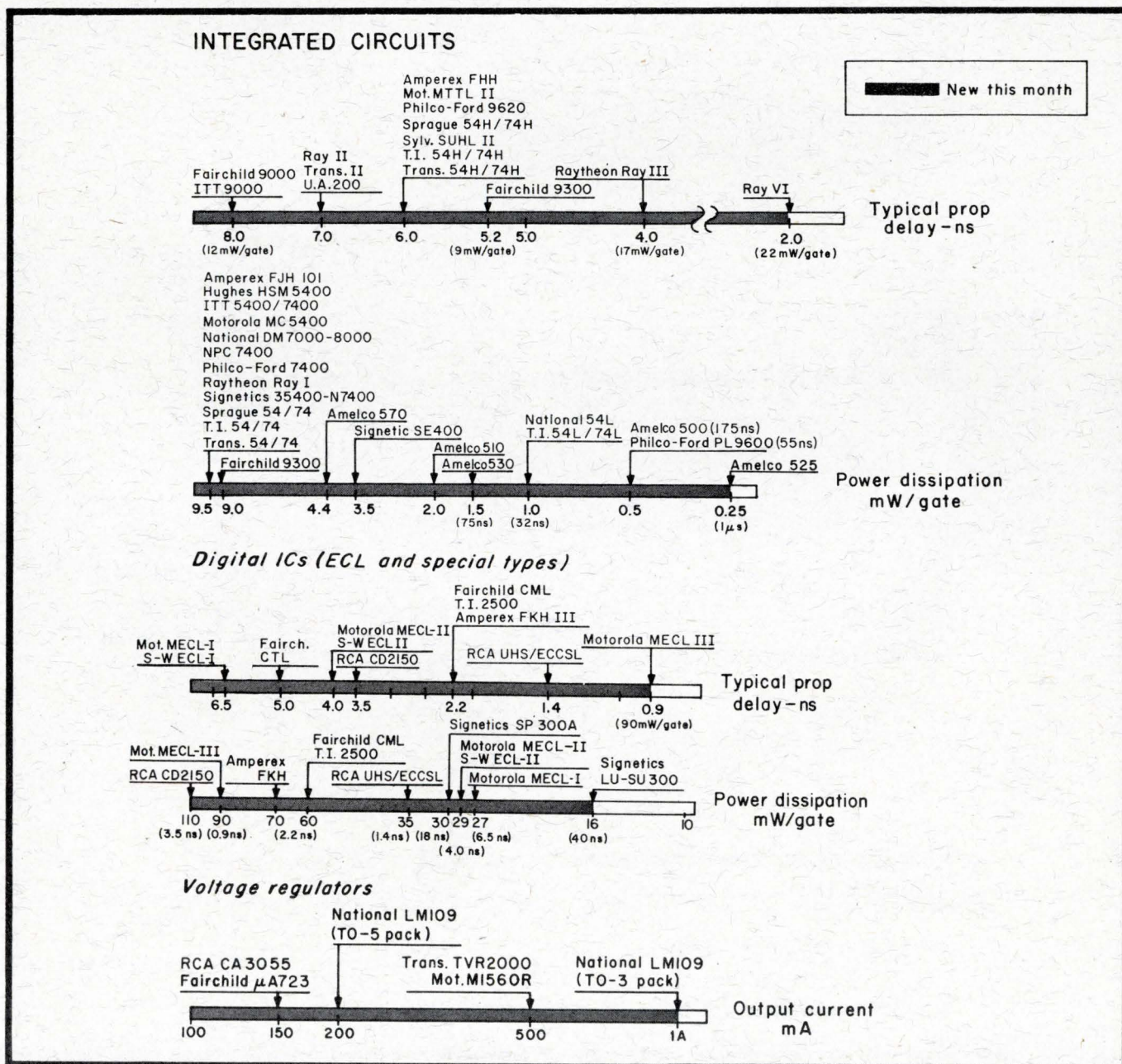

**SEMICONDUCTORS**

*Silicon power transistors (npn)*

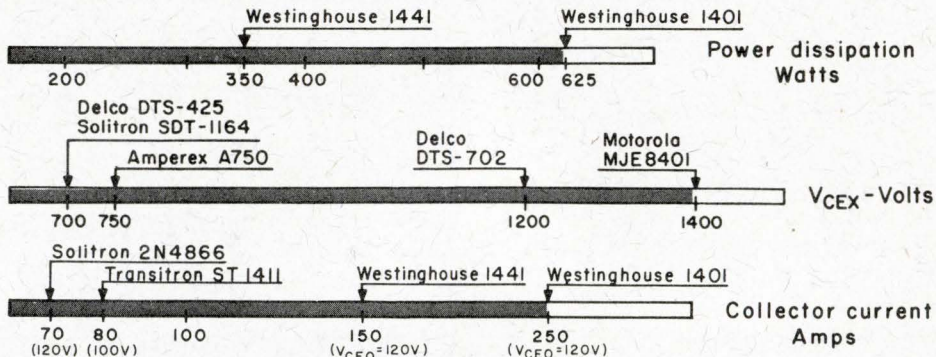

*Dual bipolar transistors*

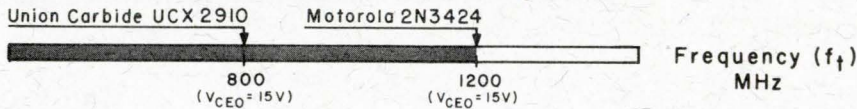

*Thyristors*

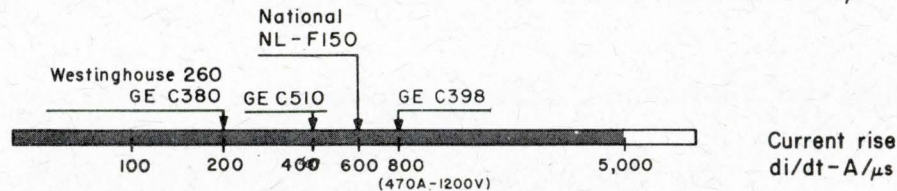
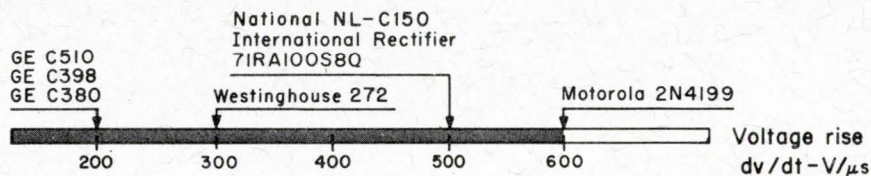
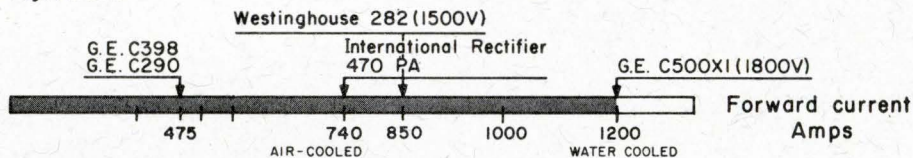

*Microwave semiconductors (low noise)*

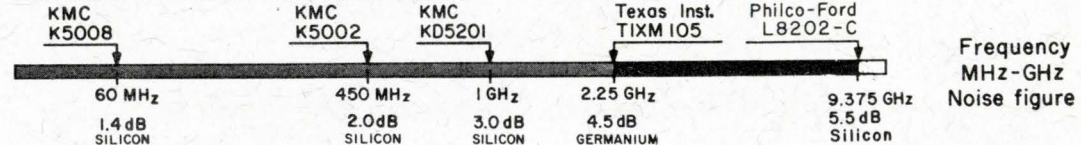

*Microwave semiconductors (power)*

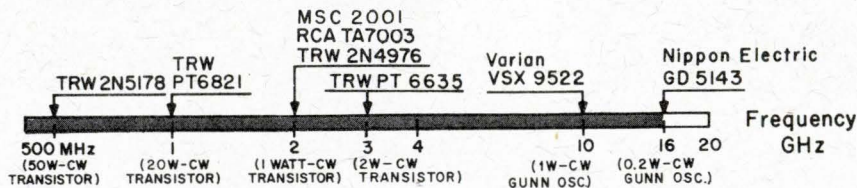

*Microwave multiplier diodes*

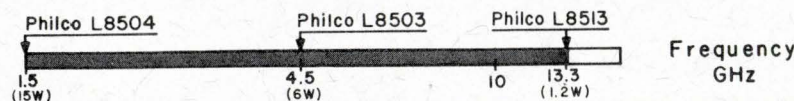



**Behind this disguise  
are 1001 ways to  
build a more precise  
timing circuit at  
no extra cost**

The ZC 1001 Series

**PUT**

PROGRAMMABLE UNIJUNCTION TRANSISTOR

**Typical Unitrode reliability  
in a hermetically-sealed  
package suitable for  
military use at only  
90¢ each in lots of 100.**

■ Functionally equivalent to standard unijunction transistors with the advantage that external resistors can be used to program  $\eta$ ,  $R_{BB}$ ,  $I_p$ , and  $I_v$ , depending on the designer's needs.

■ Completely planar passivated, hermetically sealed TO18 type package.

■ Even long time-delay designs are more precise, because the PUT's low guaranteed  $I_p$  of 150 nA allows use of larger timing resistors and smaller capacitors.

■ For pulse and timing circuits, SCR trigger circuits, relaxation oscillators, and sensing circuits.

IN STOCK, READY TO DELIVER NOW • SEND FOR YOUR FREE SAMPLES AND CIRCUIT DESIGN GUIDE

*For fast action call Pete Jenner collect . . . today!*

From the  
SSPI Product  
Group



A product of the wide ranging semi-conductor technology of

**UNITRODE**

580 Pleasant St., Watertown, Massachusetts 02172 • (617) 926-0404

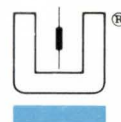

# TI's quiet revolution in TTL/MSI

**SN54/74180**  
8-Bit Parity Generator/Checker

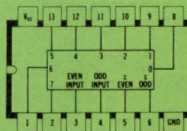

**SN54/74151**  
8-Bit Data Selector

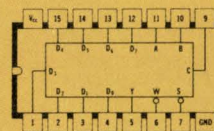

**SN54/74152**  
8-Bit Data Selector

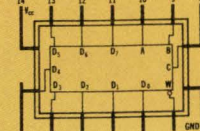

**SN54/74150**  
16-Bit Data Selector

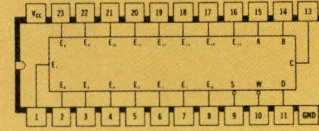

**SN54/74153**  
Dual 4-to-1-line Data Selector

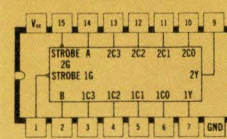

**SN54/7490**  
Decade Counter

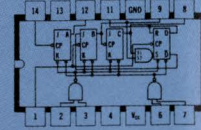

**SN54/7477**  
Quad Bistable Latch

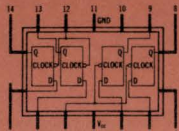

**SN54/7475**  
Quad Bistable Latch

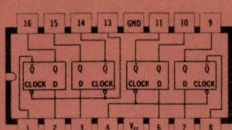

**SN54/7481**  
16-Bit Random-Access Memory

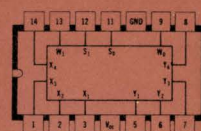

**SN54/7492**  
Divide-by-12 Counter

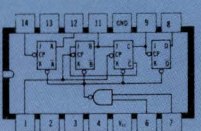

**SN54/7493**  
4-Bit Binary Counter

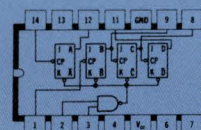

**SN54/74192** Synchronous  
Up/Down Decade Counter

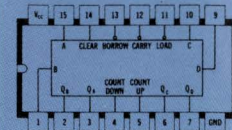

**SN54/7484**  
16-Bit Random-Access Memory

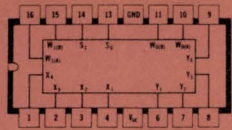

**SN7488**  
256-Bit Read-Only Memory

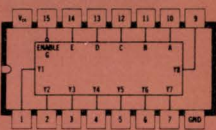

**SN54/74100**  
Dual Quad Bistable Latch

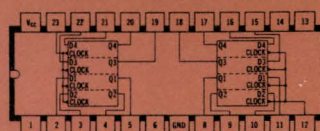

**SN54/74L93**  
4-Bit Binary Counter

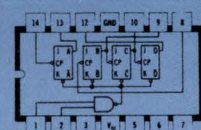

**SN54/74193** Synchronous  
Up/Down Binary Counter

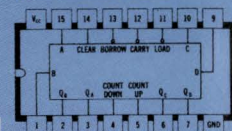

**SN54/74L95**  
4-Bit Universal Shift Register

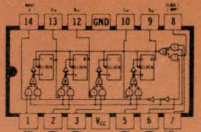

**SN54/7496** 5-Bit Shift  
Register (Dual Parallel-In, Out)

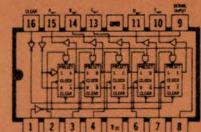

**SN54/7491A**  
8-Bit Shift Register

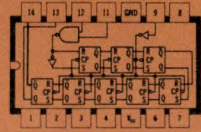

**SN74141**  
BCD-to-Decimal Decoder/Driver

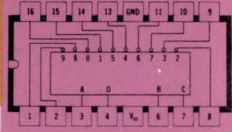

**SN54/7494** 4-Bit Shift  
Register (Parallel-In, Serial-Out)

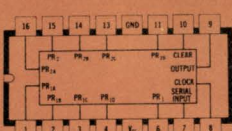

**SN54/7495**  
4-Bit Universal Shift Register

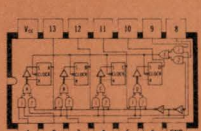

**SN54/74L91**  
8-Bit Shift Register

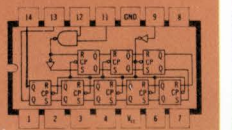

**SN54/74L98**  
4-Bit Data Selector/Storage Register

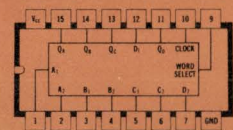

**SN54/74L99**  
4-Bit Universal Shift Register

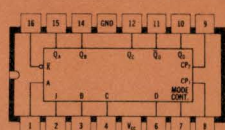

**SN54/7442**  
BCD-to-Decimal Decoder

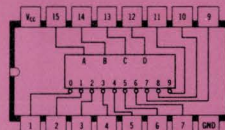

**SN54/7443**  
Excess-3-to-Decimal Decoder

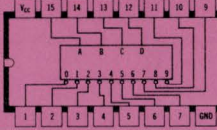

**SN54/7444**  
Excess-3-Gray-to-Decimal Decoder

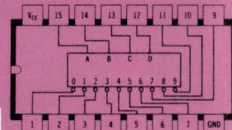

**SN54/7480**  
Gated Full Adder

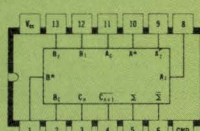

**SN54/7482**  
2-Bit Binary Full Adder

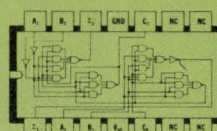

**SN54/7483**  
4-Bit Binary Full Adder

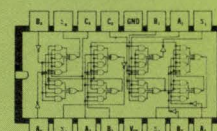

**SN54/7445/145**  
BCD-to-Decimal Decoders/Drivers

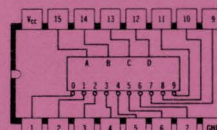

**SN54/74154**  
4-to-16-line Decoder/Demultiplexer



**SN54/7486** Quad  
2-Input Exclusive-OR Element

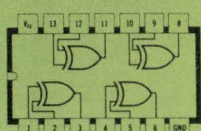

**SN54/74L86** Quad  
2-Input Exclusive-OR Element

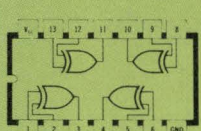

**SN54/74H87**  
4-Bit True/Complement Element

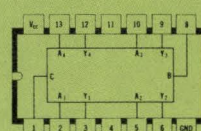

**SN54/7446/47**  
BCD-to-7-Segment Decoders/Drivers

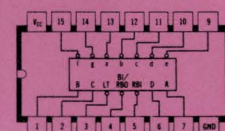

**SN54/7448**  
BCD-to-7-Segment Decoder/Driver

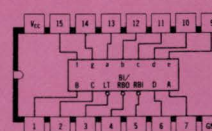

**SN54/7449**  
BCD-to-7-Segment Decoder/Driver

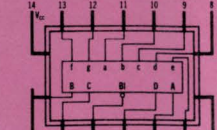

**SN54/74L85**  
4-Bit Magnitude Comparator

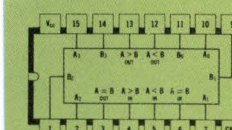

**SN54/74182** Look-Ahead  
for Arithmetic Logic Unit

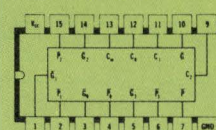

**SN54/74H183**  
Dual Carry-Save Full Adder

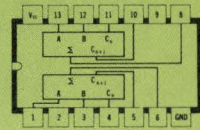

**SN54/74181** 4-Bit Arithmetic Logic Unit  
(ALU)/Function Generator

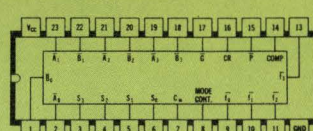

**SN54/74155/156** Dual  
2-to-4-line Decoders/Demultiplexers

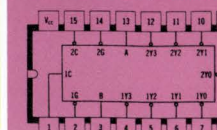



# Take a realistic look at MSI. Compare the choice of functions. Compare circuit complexity. Compare availability. Compare price.

(Then you'll know why more of TI's 54/74 MSI  
is second-sourced by second sourcers.)

Start your comparison with the left-hand page.

**FACT:** You see that TI lays 48 separate, distinct MSI functions on the line—your broadest choice by far. **4 data selectors/multiplexers, 13 decoders, 6 memories/latches, 8 shift registers, a parity generator, 6 counters and 10 arithmetic elements.**

No numbers game this. We're talking basics—not every variation made possible by a choice of two temperature ranges and three package styles.

**FACT:** More complexity—more performance—is packed into Series 54/74 MSI packages. The average com-

plexity of TI's MSI line is more than 30 gates—an order of magnitude higher than competitive TTL/SSI lines. So when you want **all** the benefits of MSI, come to where not only the choice is wider but also the overall complexity is greater.

**FACT:** Availability is unequalled. Huge in-house inventories (averaging more than 100,000 MSI parts) are maintained in all packages—plastic and ceramic DIP and flat pack—and in both temperature ranges.

**FACT:** Prices are low. TI has been committed to MSI price leadership since we introduced the first one in 1967. We've made more MSI than

anyone... and it's manufacturing know-how and high yields that keep TI costs, and prices, consistently low.

**Make yours a tough comparison** on us and our competition. For facts on our availability and prices, call your TI salesman or authorized TI Distributor. To compare choice and complexity, get the 184-page supplement to our TTL catalog. It'll bring you up-to-date on our 48 MSI functions. Circle 186 on the Reader Service Card or write Texas Instruments Incorporated, P.O. Box 5012, M. S. 308, Dallas, Texas 75222. That's where the quiet MSI revolution is going on.



**TEXAS INSTRUMENTS**  
INCORPORATED

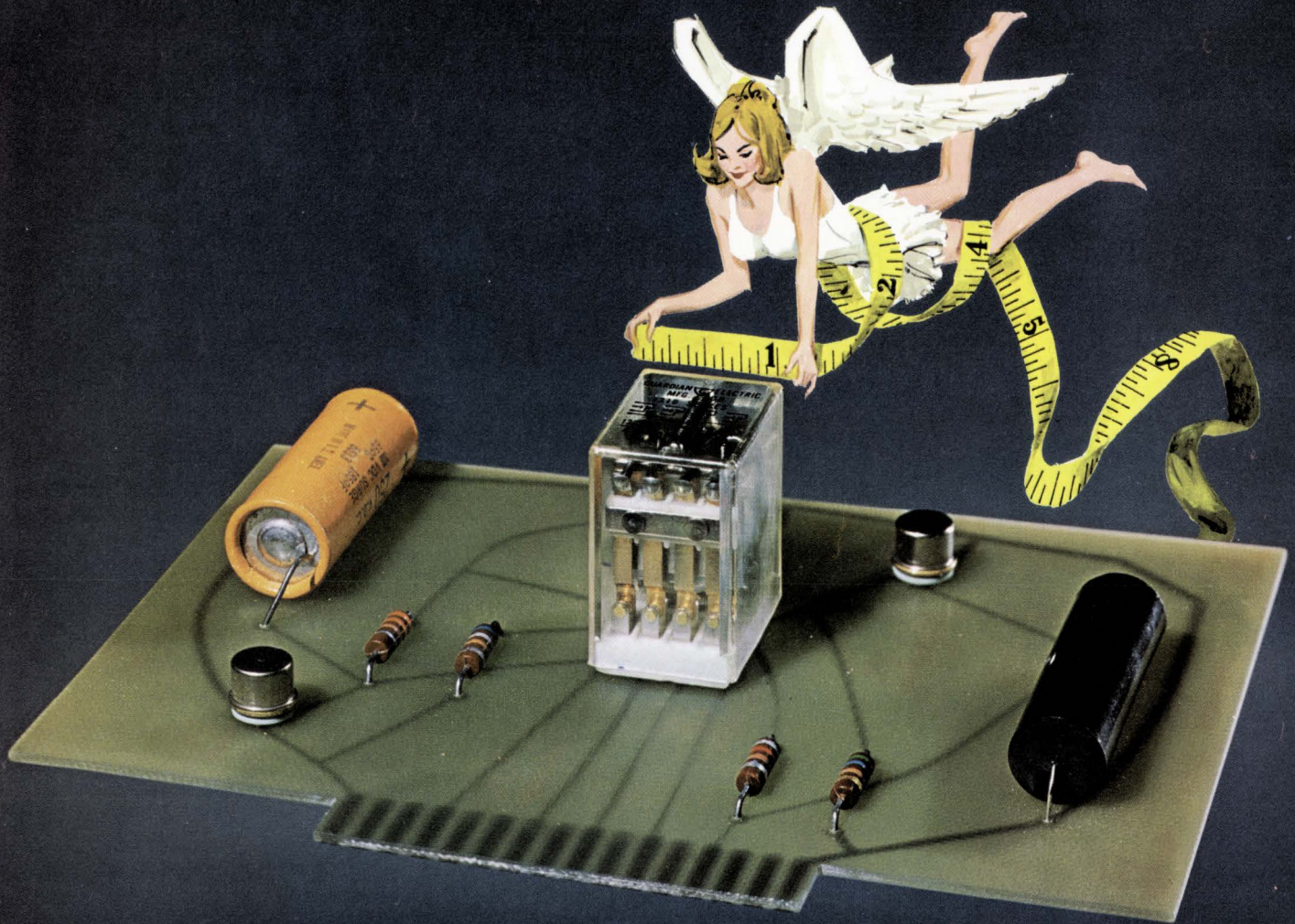

# Trust your Guardian Angel

for the newest 4PDT—5amp miniature relay

Give us a cubic inch on your printed circuit board . . . and we'll fill it with a plug-in relay. The logical relay for logic systems, computers, business machines—any application requiring maximum endurance and reliability in minimum space. Our new 1310, 4PDT-5 amp miniature relay is just a little more than one cubic inch in size, with inductive load contact rating of  $\frac{1}{8}$  hp @ 120V 60 Hz. But the small size doesn't limit its mechanical life of 100 million operations DC, 50 million AC. Minimum!



The miniature size doesn't limit its versatility, either. It's available with a choice of solder lug, quick connect .110, or printed circuit terminals—sockets for "plug-in" installation available with PC or solder lug. Other features like AC and DC versions, the Lexan dust enclosure that's standard, plus U/L and CSA recognition make this relay the answer to an engineer's prayers. (And all this time you didn't really believe you had a Guardian Angel!)



**GUARDIAN<sup>®</sup>  
ELECTRIC**

MANUFACTURING COMPANY • 1550 West Carroll Avenue, Chicago, Illinois 60607  
Circle 18 on Inquiry Card



COMPLETE APPLICATION DATA  
is yours for the asking.  
Send for Bulletin B5-1.

**Water, water, everywhere . . .**

The recent American Management Association's briefing on Oceanology drew about 150 concerned participants to San Diego to confer about management of the coastal zone. The biggest problem, they agreed, was setting up management of resources, with science assigned a secondary role. The major flaw in this consensus is that lack of scientific knowledge is the limiting factor in starting programs.

Study after study has recommended that the ground rules for coastal zone management be that the burden be assumed by the states and federally funded research should be carried out in those coastal labs that are associated with universities. The predictable result has been a tremendous fragmentation of effort with no major thrust. Federal funds have been scarce and are not expected to increase in the next five years. All the talk is about managing future programs, according to California Congressman Bob Wilson.

Countering this concept, North Carolina's Gov. Scott kicked the ball right back into the federal field by contending that Washington must acknowledge its responsibility for the managing of problems that cut across so many political boundaries. Many desired an organization with a cabinet-level head to pull things together, thinking in terms of either a new, NASA-like agency, or a reshuffling of the Department of the Interior. However, the fact remains that there is still no "big-science" in oceanology.

**Areas of opportunity**

Mounting pressure for pollution control may break this deadlock and also create opportunities for entrepreneurial technical firms. (Already, California has set fines of up to \$6000 a day for even the "threat of pollution.") Whatever local funds are made available for waste disposal, it is quite likely the share received by a particular industry will not be enough to offset added costs. These and other factors combine to make previously unfeasible ideas, such as recycling processes, now very attractive. By recycling everything, extracting by-products from production waste, and returning resources—air, water—"as was," the company removes itself from the problem area and salvages hitherto discarded products. Adoption of such methods would create demands for

"recycle engineers" and monitoring and control systems.

Large centralized systems can be used to monitor geographic areas. Industries can profit by working with local authorities to define needs and produce desired equipment. Tying in with local universities is another way to get a share of both existing knowledge in the field and matching government funds. Basin control has the virtue of processing a commodity—water—whose value greatly exceeds costs of analytical and control equipment.

No one knows objectively what quality level to regain, so good baseline programs are needed. The Santa Barbara blowout illustrates this problem. Although some claim that the channel is cleaner than ever, I observed that the dredging operation is sucking up oil-soaked sand that has drifted several miles into the harbor, spewing black fluid onto the beach. Swimming at beaches up to thirty miles away, I still get an oil film on my skin. Clearly, different baselines are being used.

The oil companies, which have 12-\$14-billion invested in offshore operations, have the technology to support work in the ocean, and are the largest single market for goods, were represented only in the audience. Ignoring companies so intimately connected with the coastal zone is analogous to calling a meeting of all computer manufacturers—except IBM.

**How about the engineer?**

A week later, Senator Packwood of Oregon spoke on "Allocation of Priorities" at the Winter Convention on Aerospace and Electronics Systems in Los Angeles. He stated that Congress is of a mind to spend much more on non-defense items, such as ecology. He forecast science and engineering playing a larger role in the fields of air and water pollution. Afterwards, I asked Senator Packwood if there would be enough high-engineering content in these emerging areas to absorb the numbers displaced in defense jobs. Although he said he had not previously thought about it, he guessed the answer would be no—the decisions in those areas seem more fiscal than technical.

Steven A. Thompson, Western Editor

# Aces for the Bridge Game

**1.5 Ampere  
Single-Phase  
Silicon Bridges  
50 Thru 600 PRV**

Immediately available from authorized General Instrument Distributors

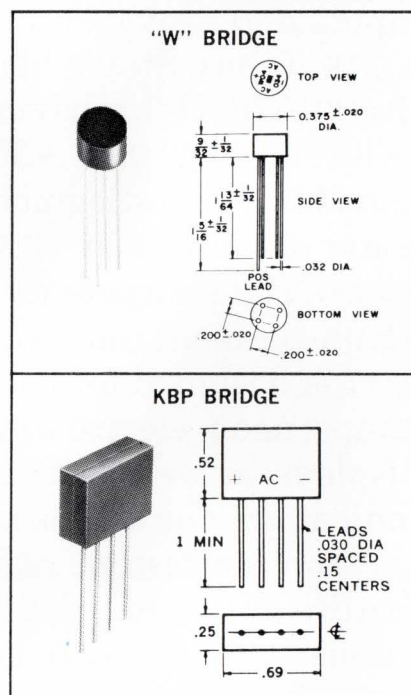

PRV	TYPE	1-99	100-999	1000
50	W005 KBP005	\$ .88	\$ .60	\$ .51
200	W02 KBP02	.93	.62	.53
400	W04 KBP04	.98	.65	.56
600	W06 KBP06	1.03	.69	.58

ALSO AVAILABLE: 3, 5 and 10 Ampere Single-Phase Bridges and 5 and 10 Ampere Three-Phase Bridges.

Write for General Instrument's "Full House" Condensed Catalog and detail bulletins to: General Instrument Corporation, Semiconductor Assembly Division, 65 Gouverneur Street, Newark, N.J. 07104



# To make Decoders that can drive every major display device,

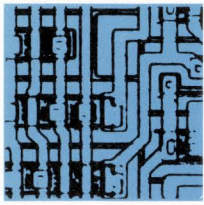

Three Fairchild MSI decoder/drivers cover the requirements of every major military and industrial display device on the market. The 9315. The 9317. And the brand new 9327. Each device has a built-in driver stage—an important feature that means smaller, lower-cost systems with higher reliability.

**NIXIE**—The 9315 One-of-Ten Decoder/Driver accepts decimal inputs and provides ten mutually exclusive outputs which directly drive NIXIE\* tubes. Stable high-voltage output characteristics also make the 9315 ideal for driving relays, lamps and similar devices.

**SEVEN-SEGMENT**—Fairchild's 9317 and 9327 Seven-Segment Decoder/Drivers convert 4 inputs in 8421 BCD code into appropriate outputs for driving seven-segment numerical displays. The 9317 is designed for use with incandescent lamps, neon, electroluminescent and CRT displays, as well as light emitting diode indicators. The 9327 is used for DIGIVAC S/G\*\* vacuum fluorescent readouts. Both devices feature automatic ripple blanking, lamp intensity modulation, lamp test facility, and blanking output. Outputs are disabled by codes in excess of binary 9. Flags are removed on the 6 and 9, which reduces the number of ambiguous states.

\*NIXIE is a registered Trademark of Burroughs Corporation.  
\*\*DIGIVAC S/G is a registered Trademark of Wagner Electric Corporation.

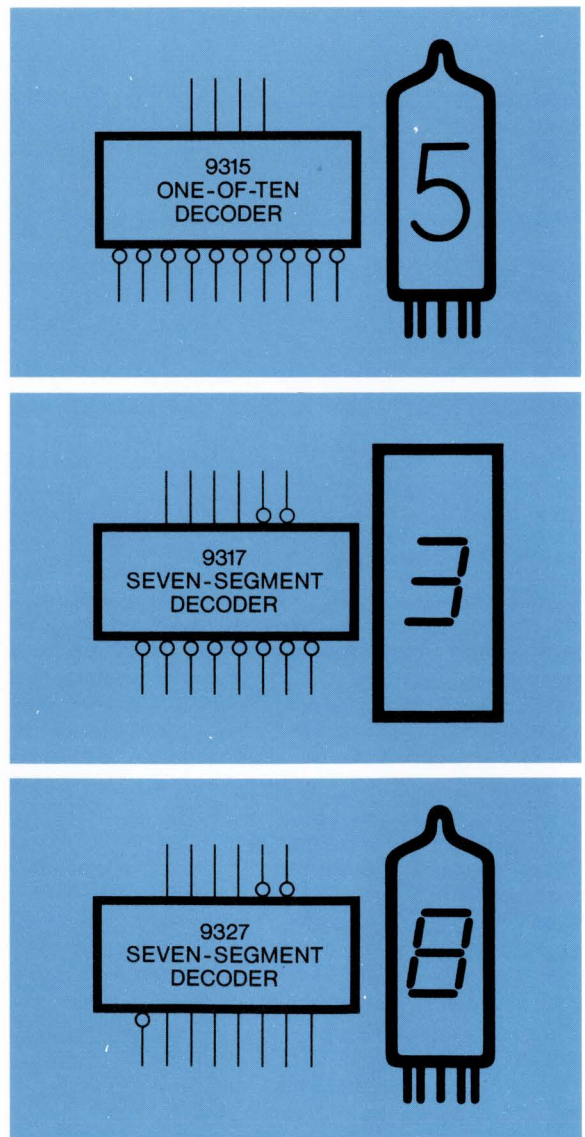

To order these Decoder/Drivers, call your Fairchild Distributor or ask for:

PART NUMBER	PACKAGE	TEMPERATURE RANGE	(1-24)	PRICE (25-99)	(100-999)
U4L931551X	Flat	-55°C to +125°C	\$22.00	\$17.60	\$14.65
U4L931559X	Flat	0°C to + 75°C	11.00	8.80	7.30
U6B931551X	DIP	-55°C to +125°C	20.00	16.00	13.30
U6B931559X	DIP	0°C to + 75°C	10.00	8.00	6.65
U4L9317513	Flat	-55°C to +125°C	28.00	22.40	18.70
U4L9317593	Flat	0°C to + 75°C	14.00	11.20	9.35
U7B9317513	DIP	-55°C to +125°C	25.40	20.30	17.00
U7B9317593	DIP	0°C to + 75°C	12.70	10.15	8.50
U4L9327591	Flat	0°C to + 75°C	13.05	10.50	8.80
U7B9327591	DIP	0°C to + 75°C	11.90	9.55	8.00

# you have to get serious about MSI family planning.

We put together a family plan by taking systems apart. All kinds of digital systems. Thousands of them.

First we looked for functional categories. We found them. Time after time, in a clear and recurrent pattern, seven basic categories popped up: Registers. Decoders and demultiplexers. Counters. Multiplexers. Encoders. Operators. Latches.

Inside each of the seven categories, we sifted by application. We wanted to design the minimum number of devices that could do the maximum number of things. That's why, for example, Fairchild MSI registers can be used in storage, in shifting, in counting and in conversion applications. And you'll find this sort of versatility throughout our entire MSI line.

Finally, we studied ancillary logic requirements and packed, wherever possible, our MSI devices with input and output decoding, buffering and complementing functions. That's why Fairchild MSI reduces—in many cases eliminates—the need for additional logic packages.

The Fairchild MSI family plan. A new approach to MSI that's as old as the industrial revolution.

It started with functional simplicity, extended through multi-use component parts, and concluded with a sharp reduction in add-ons.

Simplicity. Versatility. Compatibility.

Available now. In military or industrial temperature ranges. In hermetic DIPs and Flatpaks. From any Fairchild Distributor.

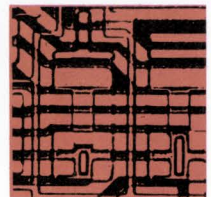

**OPERATORS**  
9304 — Dual Full Adder/Parity Generator



**LATCHES**  
9308 — Dual 4-Bit Latch  
9314 — Quad Latch



**REGISTERS**  
9300 — 4-Bit Shift Register  
9328 — Dual 8-Bit Shift Register

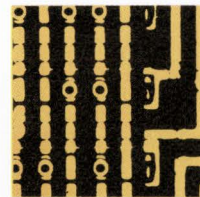

**MULTIPLEXERS**  
9309 — Dual 4-Input Digital Multiplexer  
9312 — 8-Input Digital Multiplexer

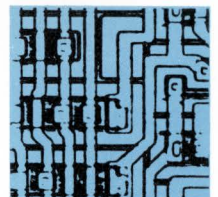

**DECODERS AND DEMULTIPLEXERS**  
9301 — One-Of-Ten Decoder  
9315 — One-Of-Ten Decoder/Driver  
9307 — Seven-Segment Decoder  
9311 — One-Of-16 Decoder  
9317 — Seven-Segment Decoder/Driver  
9327 — Seven-Segment Decoder/Driver

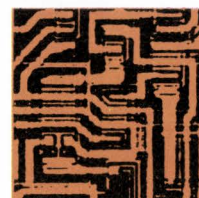

**COUNTERS**  
9306 — Decade Up/Down Counter  
9310 — Decade Counter  
9316 — Hexidecimal Counter

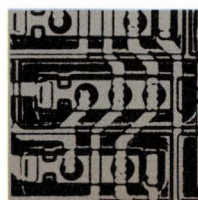

**ENCODERS**  
9318 — Priority 8-Input Encoder

**FAIRCHILD**  
SEMICONDUCTOR

FAIRCHILD SEMICONDUCTOR A Division of Fairchild Camera and Instrument Corporation Mountain View, California 94040, (415) 962-5011 TWX: 910-379-6435

# Is the 901 counter-timer just too good to be true?



# NO!

## It was...but it's not any more!

Last year, when we introduced the Model 901, we were years ahead of the industry. Here was the first state-of-the-art universal counter-timer that could count directly to 200 MHz without a plug-in, and—with a plug-in—could go right on counting into the gigahertz range. What's more we offered it at the unheard of low price of only \$2475—about \$250 to \$1000 below the nearest competition!

It wasn't long before we knew we had a tiger by the tail. Here was a dream instrument with all the universal counting and measuring functions built into the standard main frame...with gate times of 1  $\mu$ s to 100 sec instead of to just 10 sec...with a TIM with a resolution of 10 nsec instead of 100...with an input sensitivity of 10 mV instead of the usual 50 or 100...with 9-decade readout instead of just 8...and with remote control available as an optional extra. With all that going for us we had just one problem: how to get into volume production fast enough to meet demand.

Now cut to 1970. The industry still hasn't caught up with the Model 901, but our production has caught up with demand. You can now buy this state-of-the-art instrument *right off the shelf* for the same low price. What's more, for only \$825 extra, you can also have the Model 931 Heterodyne Converter plug-in that extends the 901 frequency range up to 1.3 GHz.

*But why dream on? Why wait to catch up to the times? The 901 is a reality today. For the full facts, circle the reader service card.*

COMPUTER MEASUREMENTS



A DIVISION OF NEWELL INDUSTRIES

12970 Bradley/San Fernando, Calif. 91342/(213) 367-2161/TWX 910-496-1487

The large room was well-filled. The listeners were attentive. The man of the hour was Stanford Ovshinsky, inventor of the Ovonic switch,\* and possibly the most widely known name in the amorphous materials field.

Ovshinsky was speaking at a recent meeting of the San Francisco chapter of the IEEE Group on Electron Devices. He speaks somewhat defensively, perhaps because of past adverse publicity. While many post-talk questioners were sincere, a few seemed more interested in downgrading the work—Ovshinsky handled them well.

The opinion of many semiconductor workers is that Ovshinsky does seem to have an honest device, but one which should have been at its present development five or ten years back. Today, these people argue, such devices are lost in our sophisticated, high-density, silicon technology.

Ovshinsky counters such arguments, and also answers the question, "But what can you *do* with it?", by saying that there is no basic dichotomy between his amorphous technology and that of silicon: we should simply mesh them and use the better aspects of each to achieve functions not available through crystalline devices alone.

Memories, for example. Ovshinsky showed a non-volatile, read/write/erase, 256-bit array. It uses both conventional silicon techniques and amorphous technology to give an electrically alterable ROM. He called it a "read-mostly" memory because the array has a fast—20 to 50 ns—read time, but a much slower write time.

Ovshinsky's company Energy Conversion Devices, Inc., builds a threshold switch and an optical switch. We've heard about the threshold switch for some time now. According to Ovshinsky, it holds one of two states indefinitely. The optical switch uses laser energy to bring about optical changes in the company's thin-film material, and may have applications in mass-storage memories, printing systems, and displays.

Stanford Ovshinsky feels that Ovonic should indeed fit a niche and contribute to technology. However, only time will tell.

\*The Ovonic switch is based on the Ovshinsky effect—majority carrier transport in polycrystalline semiconductors. These materials are interesting primarily for their radiation resistance, and also for their low cost.

*Sheldon Edelman*  
Western Editor—San Francisco

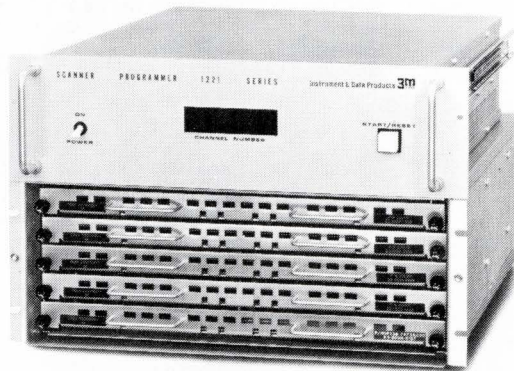

## OUR GUARDED SCANNER IS STANDARD

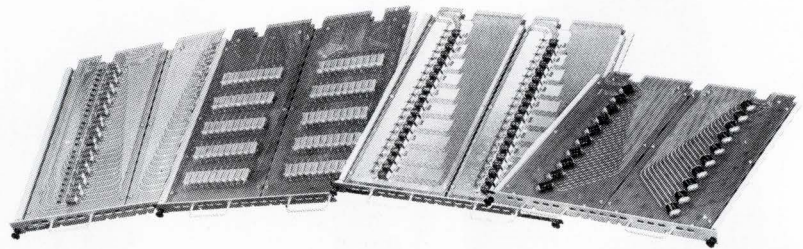

## OUR MODULES MAKE IT CUSTOM

A complete line of "off-the-shelf" modules make it possible to configure the 3383/1221 Guarded Reed Relay Scanner for single wire, two wire, and switched shield three and six wire switching.

Up to 10,000 input channels with an optional "multiplex output option" provides the capability of routing any input to any of ten outputs.

Programming registers are designed for interface with T<sup>2</sup>L logic levels in Binary Coded Decimal format for applications in Automatic Test Equipment, Data Acquisition Systems and other computer controlled systems.

Guarding techniques used in the 3383/1221 provide high system CMR. Plug in switching modules may be withdrawn from the chassis front eliminating troublesome cable service loops. High packing density with 400, 3 wire channels in 12¼ inches conserves costly enclosure space.

For more detailed information, ask for our brochure on the 3383/1221 Series Scanner.

**Instrument & Data Products** **3M** COMPANY  
300 SO. LEWIS RD., CAMARILLO, CALIF. 93010 • TEL. (805) 482-1911 • TWX 510 866-7099

# There's something in everything we

## HDR Series Connectors

High density pin and socket connectors. Available in nine sizes—12 to 106 contact positions on .100" grid. Size 20 contacts for wire size ranges 20-30 AWG. Posted contacts available for wrap type or TERMINAL-POINT★ point-to-point wiring devices. Also available with crimp, snap in contacts applicable at speeds to 4000 terminations per hour.

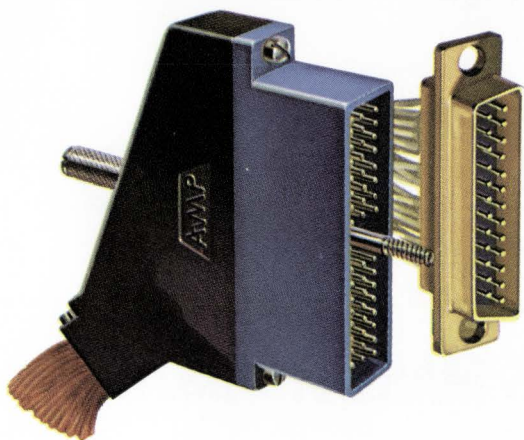

## ARINC Type Connectors

In both sealed and unsealed versions. Fully intermateable with all connectors designed to the specification. Other features include: higher specified dielectric performance, greater contact stability, front serviceable keying, and faster contact application. Up to 1200 complete wire terminations with the AMP-O-MATIC★ Stripper Crimper machine. Crimp configuration conforms to MS-3191 or MS-3108 and meet the specification of MIL-C-81659.

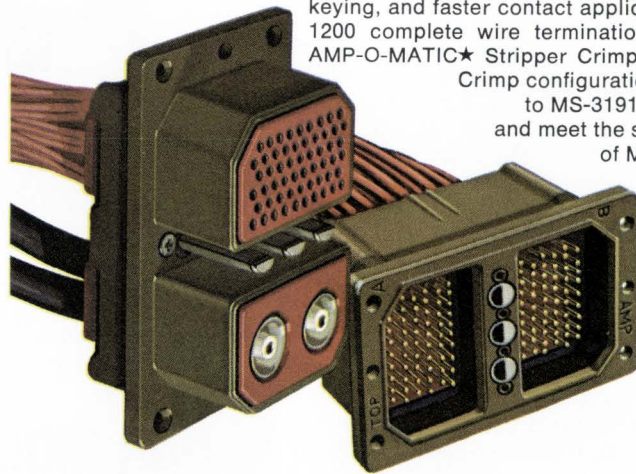

## High Density Printed Circuit Connectors

Easily hand-mated, two piece printed circuit connectors featuring self-aligning contacts. Available in .075" and .100" centers. Low insertion and withdrawal forces, yet highly resistant to humidity, shock, vibration, and other adverse environmental conditions. Unique elliptical spring construction of socket for four-point redundant contact. Can be soldered, wrapped or welded. Individual contacts are removable even after connector is mounted.

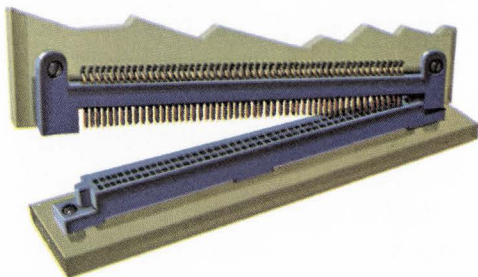

## Flexible Flat Cable Connectors

AMP's Flexible Flat Cable connector is specially designed to match the cable's characteristics and requirements. Available in 9 to 33 circuits. Unique high-speed automated machinery crimps contacts to cable at rates up to 5000 per hour. Contacts snap into housing for cable-to-cable, cable-to-board, and cable-to-round wire connections. High reliability, low installed costs through automated tooling.

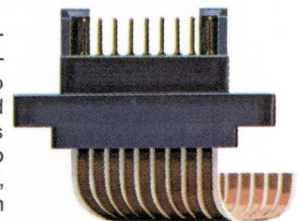

## Coaxial Connectors

Full line of COAXICON★ connectors includes standard, miniature and subminiature types. All are fully crimpable. Industry's first automated process for termination of subminiature types produces a fully crimped terminal in approximately 20 seconds. Low VSWR and reduced noise level. Inner contact stability. See-through port for easy inspection. Available for all standard cable sizes. AMP's matched tool and terminal concept assures uniform reliability. Cuts rejects to absolute minimum.

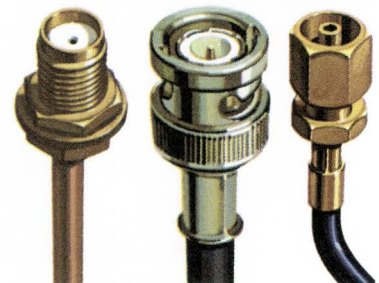

## Micro-Connectors

Ideal for all micro-system packaging. AMP design spiral spring construction assures redundant contact and maintains reliability under severe conditions. Stamped and formed chevron shaped receptacle and mating pin contact are spaced in housing in either .050" or .025" centers. Connectors can be "stacked" without loss of critical contact spacing. Circuit contact tines are pre-solder coated and need only reflow and plug in.

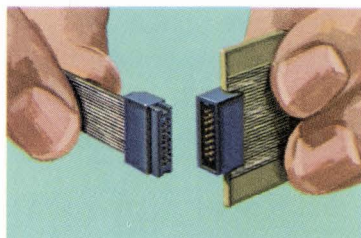



# standard make for black boxes

From input to output, every connection we make for a black box (and we make them all) takes into account avionics standards for space, weight, modularity, reliability and maintainability. Our technology is aimed at making things smaller, lighter, stackable, reliable and easily maintainable. And the proof of our capability is on wings everywhere in the world—in business aircraft, military planes of every type and the jumbo jets.

Whatever the need—communications, navigation, radar . . . airborne electronic systems of all kinds . . . AMP's first packaging requirement in any black box is reliability. And we offer application tooling and techniques that make it available at the lowest applied cost.

For more complete details or ideas to fit your black box design requirements write:

**Industrial Division**

**AMP Incorporated, Harrisburg, Pa. 17105**



**AMP**  
INCORPORATED

★A trademark of AMP Incorporated.

# Electrical integration— a step closer to molecular electronics?

At ISSCC, Barrie Gilbert of Tektronix introduced an IC that is electrically—in addition to geometrically—integrated

Just about the time when monolithic integrated circuits were born, Dr. Arthur R. Von Hippel and a group of his coworkers at MIT wrote a book on 'molecular science,' where they analyzed those components that function, thanks to their molecular properties, as opposed to their macroscopic ones.

There are several outstanding examples of the application of molecular science to electronics, such as crystals, piezoelectric transducers, ferroelectrics, ferromagnetics and, more recently, the bulk-effect microwave semiconductors. Molecular electronics was the driving force behind, but never quite materialized in integrated circuits, even though Dr. Von Hippel pointed out in his book that transistors and diodes were the best under-

stood representatives of molecular engineering in semiconductors.

Since the introduction of Planar<sup>®</sup> technology, the industry has followed a pragmatic approach that consists of arranging integrated components mostly for geometrical—rather than electrical—reasons. You can verify this by looking (with a microscope) on the surface of a chip. With a trained eye, you can still recognize the individual components and follow their metallic connections as on a circuit diagram. The only exceptions are the 'lateral' pnp transistors used to obtain complementary pairs, whose junctions occur on a vertical plane in order to take advantage of the electrical

*(continues on p. 34)*

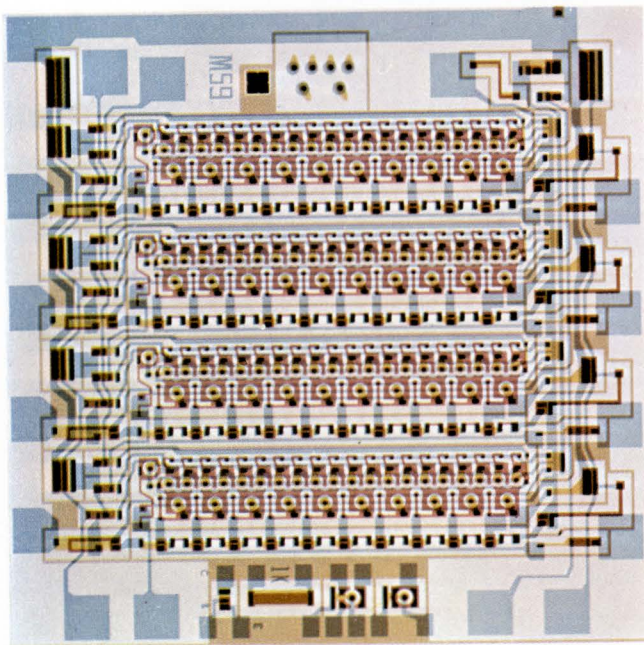

**Electrical integration.** This is the 60x60-mil chip, and part of the schematics of the four-decade counter with buffer memory and d-a output converter. The photomicrograph that appears on the cover of this issue shows a detail of a portion of one of the stripes containing one counter and memory. In that portion, the space occupied by each component is only 2.6 square mils. The square-cornered resistors in the schematic diagram indicate parasitic coupling of the npn collectors to the bases of the multiple-collector pnp trans-

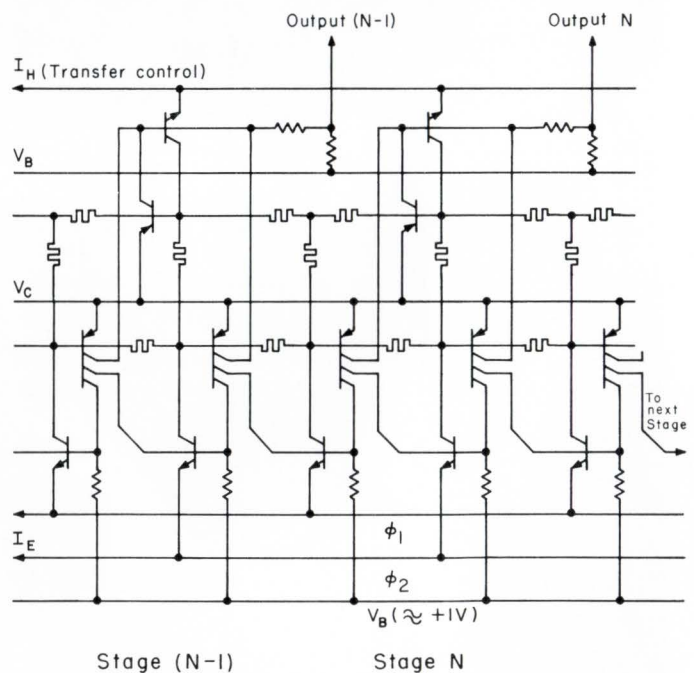

istors. This coupling occurs because collectors and bases are in a common n-type epitaxy, but it does not affect the operation of the counter. For example, if the npn transistor connected to clock line  $\phi_1$  on stage (N-1) is on, all the pnp bases will receive some of its current, the amount diminishing with their distance to the active collector. But the second collector of the pnp contributes some current to the base of the npn connected to  $\phi_2$ . Therefore, when  $\phi_2$  comes on, only this transistor will turn on.

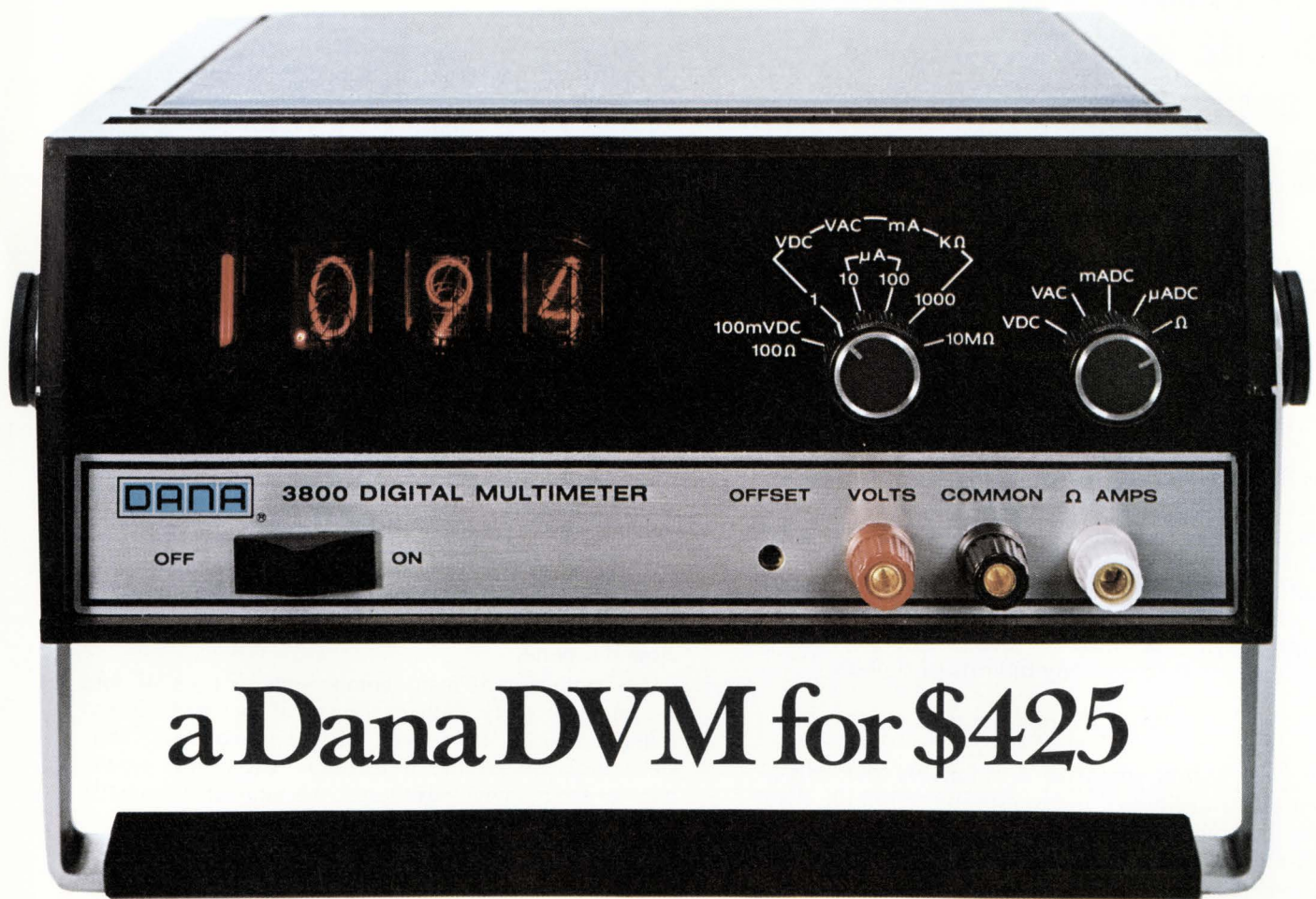

## a Dana DVM for \$425

**Designed and developed by the same people who build our \$6,000 instrument...and our \$5,000 instrument... and our four, three, two and one thousand dollar instruments. No wonder it's so good.**

Dana's new 3800 is the most accurate 3-digit DVM on the market. But it's more than a DVM. It's a full multimeter that will measure dc volts, ac volts, ohms, and dc current — with even a BCD option available. Superimposed power line hum is rejected by 1,000 times. It's so stable that it will run for over 6 months without calibration. So insensitive to temperature and humidity that you can use it anywhere without affecting performance, and its case is made of Cylolac<sup>®</sup>, the same rugged material used in professional football helmets.

Our reputation rides on the 3800. Just as it rides on every other DVM we make... for use on the bench and in systems; militarized models; 4- and 5-digit; from \$350 to over \$8000. There's a lot more to the Dana story, and to the 3800, so write for it. We'll also tell you how you can qualify for a free trial.

**Dc & ohms only:  
\$350.00**



**DANA<sup>®</sup>**

Dana Laboratories, Inc.  
2401 Campus Drive, Irvine, California 92664

Cylolac is a registered trademark of Borg-Warner Corp.

# FOR ELECTRONIC ENGINEERS ON THE WAY UP... A Course in PROJECT MANAGEMENT

This *Project Management* course appeared originally in *The Electronic Engineer* and was devised for the engineer who wants to grow in his job and to help assure this the course was developed in collaboration with Booz, Allen and Hamilton, one of the largest management consulting firms in the world. Their experience includes the development of project plans and control systems for over 1,000 projects involving the expenditure of many billions of dollars.

## What it does for you

*Project Management* is a relatively new discipline in the field of management sciences. And the course emphasizes the methods used to reach an objective while remaining within the prescribed product specifications, budget and schedule. It also helps the individual electronic engineer or manager to increase his personal skills, sharpen his capability and broaden his understanding of project management problems, both large and small. *And, it shows you how to achieve certain specified results at a particular point in time.* It can make you more valuable to your employer.

The 5 part course costs just \$4.00 and includes a test paper for your use. All those passing the examination will receive a Certificate of Completion that is suitable for framing. Why not put this course to work for you now? Fill out and mail the coupon below. Your course will be sent to you promptly. Send your order to *The Electronic Engineer*, Chestnut and 56th Streets Philadelphia, Pennsylvania 19139.

E-4

Yes, I want to take advantage of your *Project Management* course. Send me \_\_\_ complete course(s) for only \$4.00 each. Check, cash or money order is enclosed. Send the course to:

Name \_\_\_\_\_

Address \_\_\_\_\_ Company \_\_\_\_\_

City \_\_\_\_\_ State \_\_\_\_\_ Zip \_\_\_\_\_

Send me special quantity prices

(continues from p. 32)

properties of the diffusions laid out for the npn transistors. In other words, they are electrically—not just geometrically—integrated.

Now electrical integration has made new advances. During the last International Solid State Circuits Conference in Philadelphia, Barrie Gilbert\* of Tektronix described a new integrated circuit he developed for Tektronix's new 7000 line of oscilloscopes.

The IC, a four-decade counter with buffer memory and digital-to-analog output conversion, appears on page 32 and on the cover of this issue. Even though the layout looks interesting but not unusual, a closer look reveals that it is difficult to identify individual components. In addition, its component density is almost unbelievable—320 transistors and 215 resistors on an area of 36 x 36 mils, or 380,000 components per square inch. This density compares well with that achieved with "minimum geometry" MOS transistors in a read-only memory, and is about an order of magnitude more dense than that of TTL counters.

## How it's done

By combining as many components as possible into a common epitaxy, Gilbert eliminated the need for isolation diffusions, thus saving all the space these diffusions take around the transistors. From this results another space saving advantage: the number of metallic interconnections is substantially reduced, and with them the number of holes for metal-silicon contacts.

Some of the bit lines become buried in the silicon along transistor bases, or run along buried silicon bus bars diffused under the epitaxy. In addition, the resistivity of the epitaxy produces parasitic resistors. Under these conditions, the designers had to take into account several semiconductor mechanisms—not only injection and collection of minority carriers, but also modulation of majority carriers and local field control.

Since the semiconductor effects are three-dimensional, the masks for electrically integrated circuits are more difficult to design than those of conventional ICs. "In designing super-integrated circuits," as Gilbert calls them, "the contribution of our mask designer, Rick Roskopf, was as important as that of the circuit designer."

\*This is not the first time Barrie Gilbert has made news at the ISSCC. Two years ago he described an analog multiplier which became the ancestor to most of the commercial four-quadrant multipliers now in the market.

<sup>1</sup>*Molecular science and molecular engineering* Dr. Arthur R. Von Hippel, J. Wiley & Sons New York 1959.

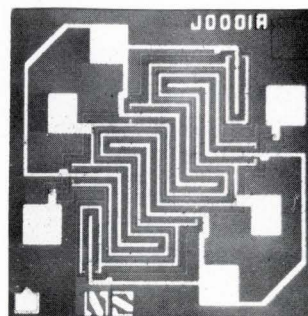

**Thermal integration.** A dual junction-field-effect-transistor (JFET) by National Semiconductor Corp., is a simple example of another dimension in integration: thermal integration. The FETS are interleaved in a chip to match their characteristics by design, rather than by selection. (Photo of FM3954 dual-JFETS.)

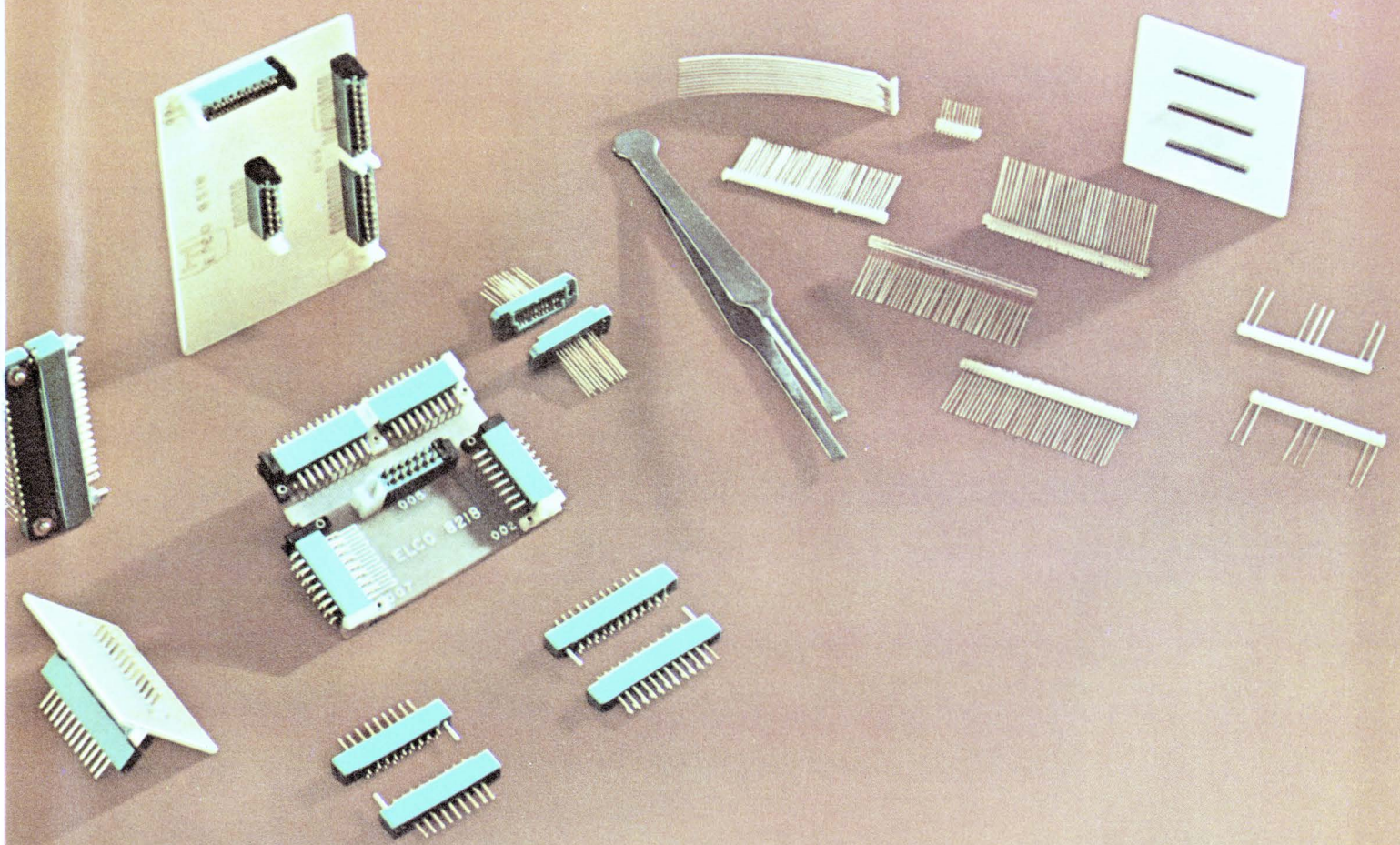

# Miniature, subminiature connectors, yes.

## Miniature, subminiature contacts, no.

Microelectronics can give you a pain in the tweezers. You have to be perfect. And you have to be perfect in places so small that a flea would have trouble scratching his back.

Actually, the electronics part isn't too hard, what with piezoelectric this's and thin-film that's to work with.

But, inevitably, there comes the day when all the this's and that's have to be put together. It's a problem. Mechanically. Electrically.

You don't want to put a big fat plug on a skinny little mini-circuit.

So you need miniature or subminiature connectors. Those we have. By the catalogfull.

But you sure don't need undernourished contacts. You need all the strength you can get, all the contact area you can get, all the hang-togetherness you can get.

Those we give you. Every miniature in our catalog is made with our patented Varicon™ contacts (you probably already know about them). Our newer sub-miniatures are made with Bi/Con™ contacts (which

is sketched at the left).

See the four mating surfaces?

Four mating surfaces, coined so that they're exceptionally hard and smooth.

Four mating surfaces, held together snugly by the spring-like action of the design. And by the innate characteristics of the phosphor-bronze.

Four mating surfaces, strengthened by a reinforcing web.

Four mating surfaces, on a contact that floats in its insulator to make sure that the four mating surfaces mate.

No comparably sized contact can match the Bi/Con's dimensional, electrical, and mechanical characteristics.

And no subminiature contact can match the Bi/Con's incredibly low price, either.

For more information, write, wire, call or TWX us for our Microelectronics catalog.

Elco Corporation, Willow Grove, Pa. 19090.  
(215) 659-7000. TWX 510-665-5573.

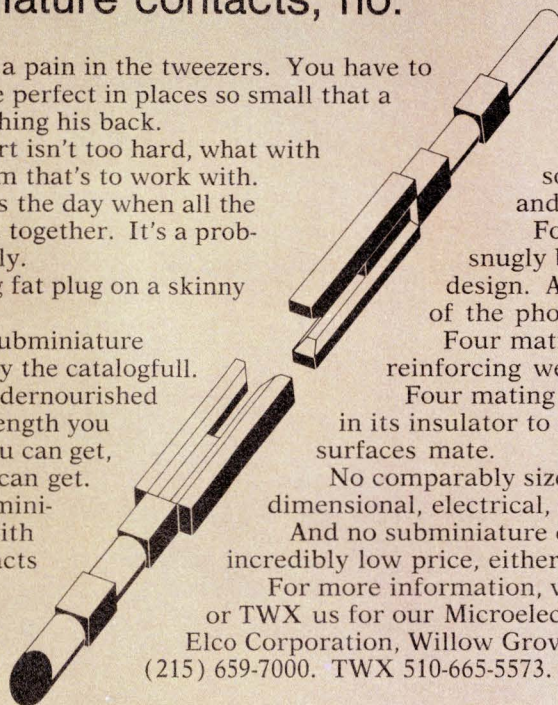

**ELCO** Varicon® miniatures  
Bi/Con® subminiatures

See us at NEPCON Central Booth 215

*Introducing Potter & Brumfield's unique*

# dual thin-line dry reed relays

An entirely new magnetic structure makes possible an exceptionally low seated height of only 0.275 inch for high density board packaging. Circuit boards employing JDT relays may be spaced on 0.5 inch centers.

This design minimizes magnetic flux dispersion, resulting in a very efficient magnetic circuit. This decreases coil power requirements and often permits direct operation of JDT relays in low-power semi-conductor logic circuits. An interfacing amplifier may be eliminated in many applications.

Terminals are similar to those on IC packages, permitting spot testing on either side of a circuit board. The dual in-line terminals on 0.1 inch centers simplify circuit board design. The reed switches are rated at 10 watts maximum resistive (50V or 0.5A DC maximum) switching.

A solid state time delay circuit may be incorporated in this small package. Or a Darlington amplifier can be included to compensate for low current applications. However, the number of available poles for switching is reduced by the addition of either of these circuits.

The JDT is completely encapsulated in epoxy, giving protection against environmental contamination. The Series is presently available in many combinations of Forms of A, B and C.



Get full information today by calling your local P&B representative or call direct to Potter & Brumfield Division of American Machine & Foundry Company, Princeton, Indiana. 812-385-5251.

Mounted height  
is only 0.275"

Power requirements:  
only 75mw per pole

Combinations of Forms  
A, B and C are available

Single Lot Prices:  
JDT 4000 Series (4-pole) \$ 7.65  
JDT 8000 Series (8-pole) \$12.95  
Quantity discounts apply.

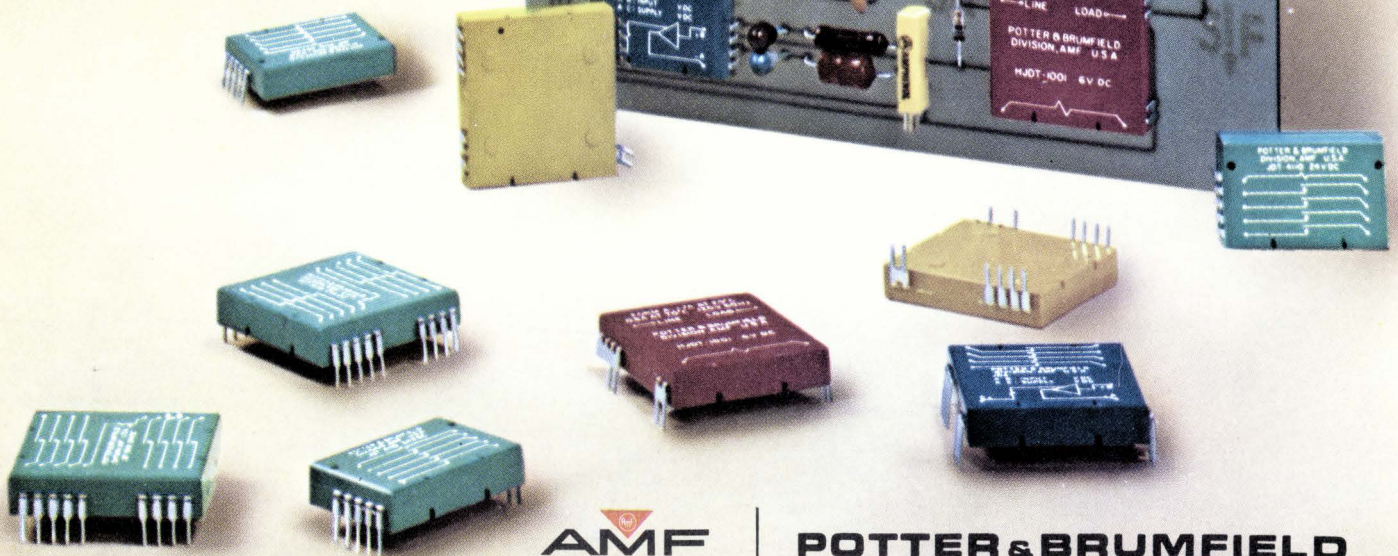
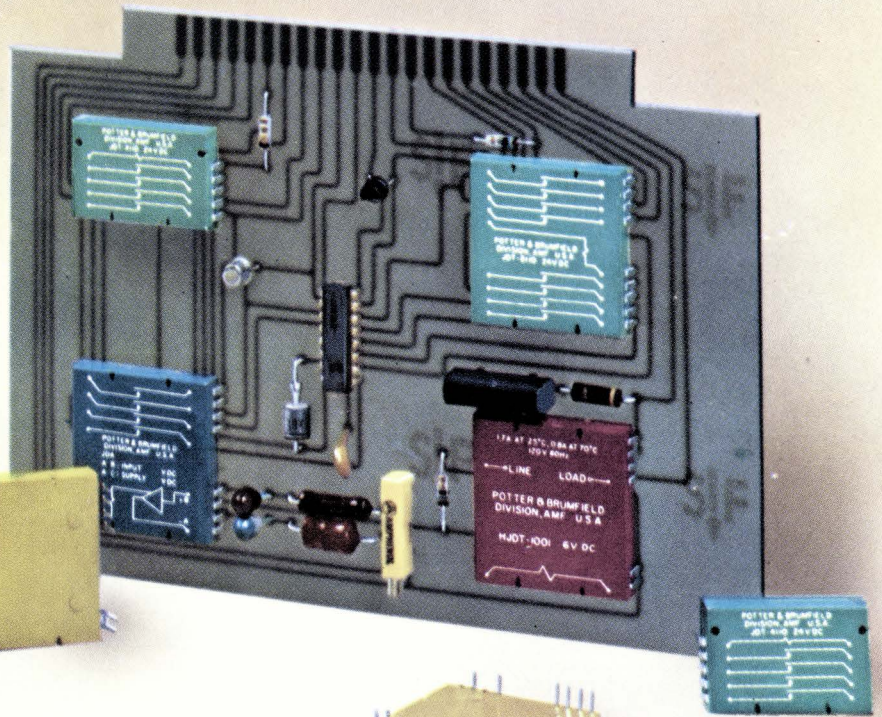

**AMF**

**POTTER & BRUMFIELD**

## SPEAK UP

### The involved engineer

Sir:

True, Engineers are loners. True, they lack identity as a professional group. True, they lack cohesiveness. In general, I must agree with these views of Rocco F. Ficchi in his article "The engineer is a loner" [*The Electronic Engineer*, April 1969, p. 25]. This probably describes some engineers. But no group can be fully described by a treatment of a "typical engineer." We need to consider the broad spectrum, and in defense of those who are not loners—who *are* involved—I'm writing this opinion.

*A new "Pro" engineer*—We're all familiar with the state qualified professional engineer. I propose that there's another type of "pro" engineer . . . in industry . . . without a shingle to hang out. He's a pro for his company, for his industry and for his community. Obviously he's not a loner. This man is important and influential.

*The company "Pro"*—Just who is this company "pro" engineer. He's an engineer who works at staying on top of his job—especially if it's a new expanding concept such as thick and thin films in microelectronics. He follows new concepts, new techniques and equipment. He has found that to do his job he cannot merely rely on his basic engineering education. He finds continuing education important—essential—so he can understand how the company functions, how to sell his ideas and work with people. Of course, he may further develop very technical abilities too. Sometimes he writes articles which reflect not only his own stature but his company's too . . . to answer important industry problems. He's alert on the job—consciously seeking patentable ideas. True, there are professional societies which issue publications and sponsor symposia. The "pro" engineer not only looks to these for information but actively seeks personal involvement in professional societies. Here the degree of involvement is regulated only by his own interest and available time. He is not content with the status quo.

*The "Pro" as a community servant*—It's inevitable that this "pro," by his very attitude, will project himself into his community. By being constantly alert to his industrial environment, he becomes concerned about the forces

(Continued on following page)

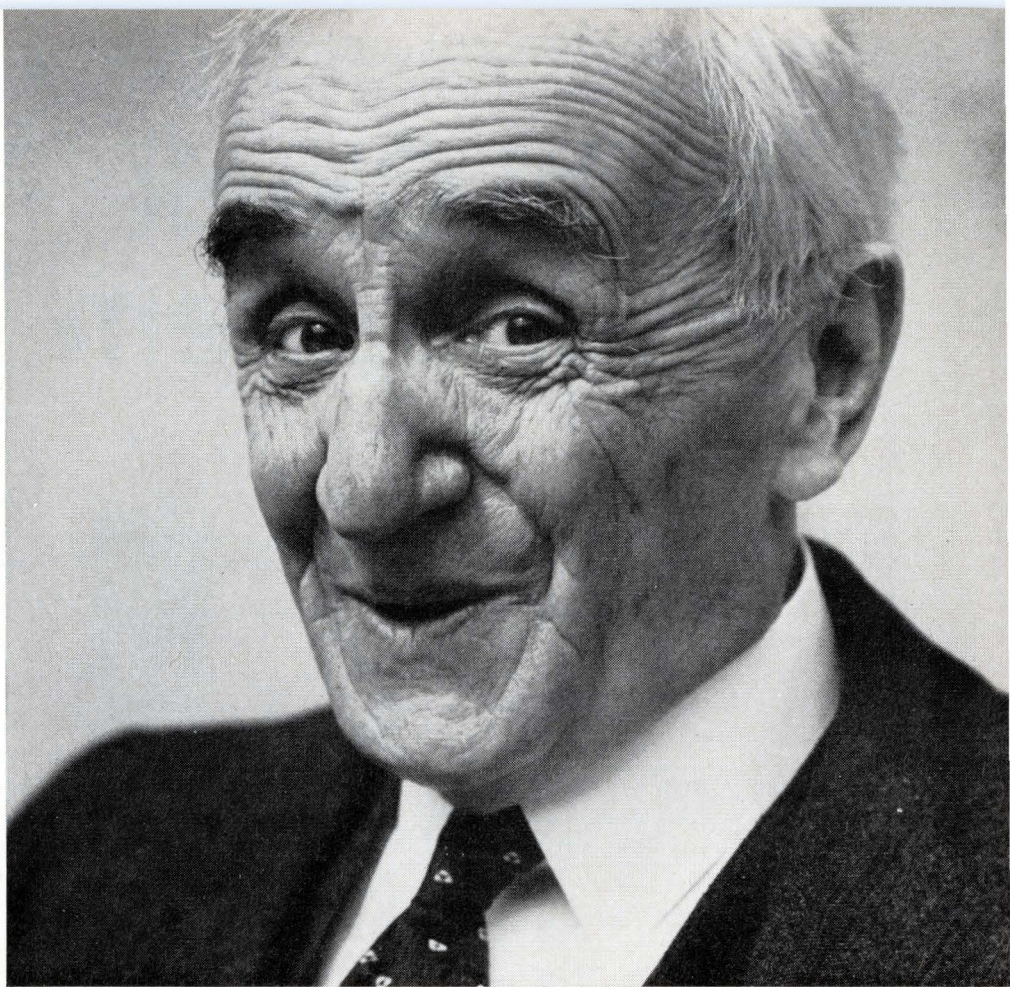

## Scanbe lights my fire.

Let me tell you why. Scanbe has a new version of their DI PAK® packaging system. They call it the "Swinger." It has hinged panels that swing out and lock into position. And that's nice because I'm tired of breaking my fingers trying to change a wire or a DIP. What's more, each panel has up to 720 14-pin or 576 16-pin DIP color coded Wire Wrap\* sockets in one vertical or horizontal drawer. That's not all. If you other young bucks would like a complete software and wire wrapping service, Scanbe can make your from/to wire lists swing too. Write for further information.

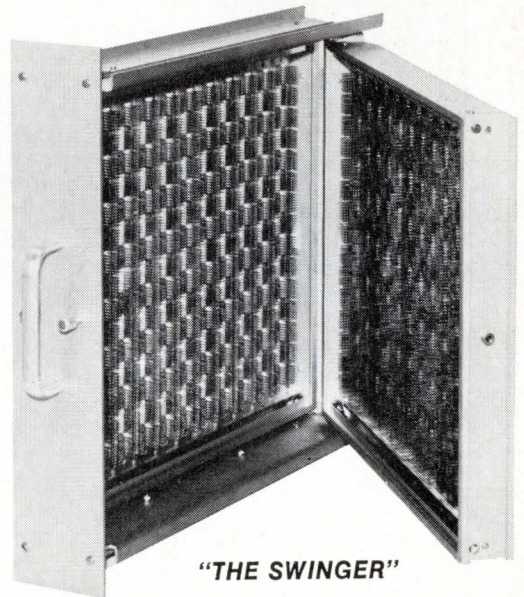

"THE SWINGER"

\*Registered trademark of Gardner Denver Company



MANUFACTURING CORP.  
A CANOGA COMPANY

3445 Fletcher Ave. • El Monte, CA 91731 • (213) 579-2300/686-1202 • TWX: 910-587-3437

# MOS Clock Driver System

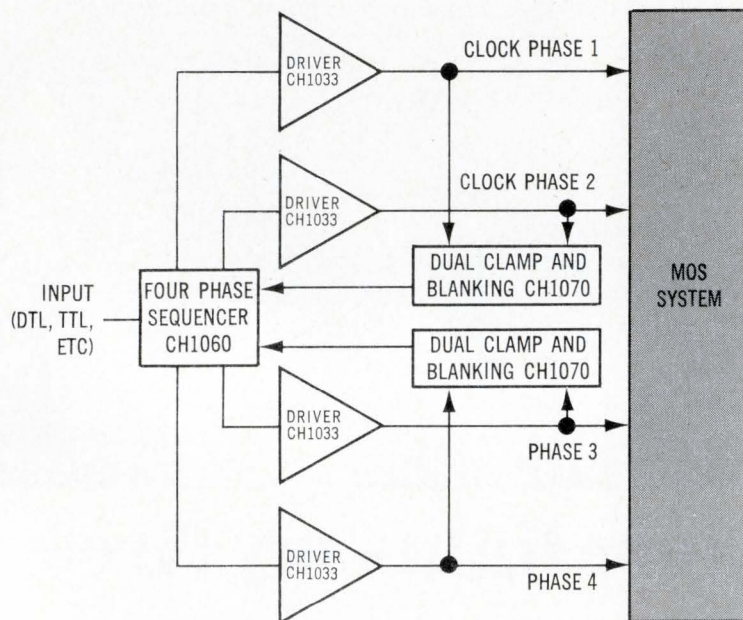

The four phase system shown uses a CH1060 FOUR PHASE SEQUENCER, four CH1033 HIGH SPEED CLOCK DRIVERS and two CH1070 DUAL CLAMP AND BLANKING CIRCUITS.

The SEQUENCER generates four clocks from a single input which minimizes package count. Sequencers can be interconnected to provide 1, 2, 3, 4 or more phases.

The HIGH SPEED CLOCK DRIVER swings  $-27V$  into  $600\text{ pf}$  in 20 nanoseconds, thereby reducing power consumption at high frequencies.

Other output swings are attainable, including  $+5V$  to  $-15V$ ,  $+13V$  to  $-13V$  and  $+13V$  to  $0V$ . Contact us for details.

CLAMP AND BLANKING CIRCUITS eliminate overshoot and capacitively coupled crosstalk which can produce unreliable MOS operation. They also prevent clock overlap. The amount of non-overlap can be externally adjusted.

We also have data communication circuits, teletype interface circuits, lamp and relay drivers, and a circuit development capability for your custom requirements.

## OFF-THE-SHELF HYBRID CIRCUITS FROM



660 National Avenue, Mountain View, California 94040, (415) 969-9433

## SPEAK UP

(continued from page 37)

acting on it and his community. He is active in local professional society chapters. He will become involved in youth programs such as Little League, art, Scouts and PTA because he's a family man. He becomes a worker—rather than a watcher—in his church. He becomes interested — he's active openly and behind the scenes on minority issues. He works in service clubs such as Lions—in government by participating in a political party or a Chamber of Commerce Congressional Action Committee.

The point is that the "pro" engineer carries his professional talents into all his activities. He uses his understanding of organization, planning, economics, costing and working with people. One of his best attributes is his practical approach to problems. He becomes important in his community.

There are many engineers who are "pros." They have a very positive attitude toward their job and their company. They find it only natural to extend themselves and their talents to meet community needs. Thus, there are many engineers who are not only aware, but actively work on contemporary problems.

Ronald P. Anjard  
Sr. Engineer  
Delco Radio Div.  
General Motors  
Kokomo, Indiana

### Don't bring back the transistor radio

Sir:

I fully subscribe to the implications of the editorial in the December 1969 issue of **The Electronic Engineer**.

Leon W. Zelby  
Director  
School of Electrical Engineering  
College of Engineering  
The University of Oklahoma

### Minding our business

Sir:

War is not right. But Communism is worse. I do not support the moratorium because it encourages the Communists to continue fighting and prolong the negotiations.

E. G. Price  
Senior Systems Design Engineer  
Leach Controls  
Azusa, California

Letters to the editor are published at the discretion of the magazine. Please say so if you do not want to be quoted. Signed letters have preference over anonymous ones.



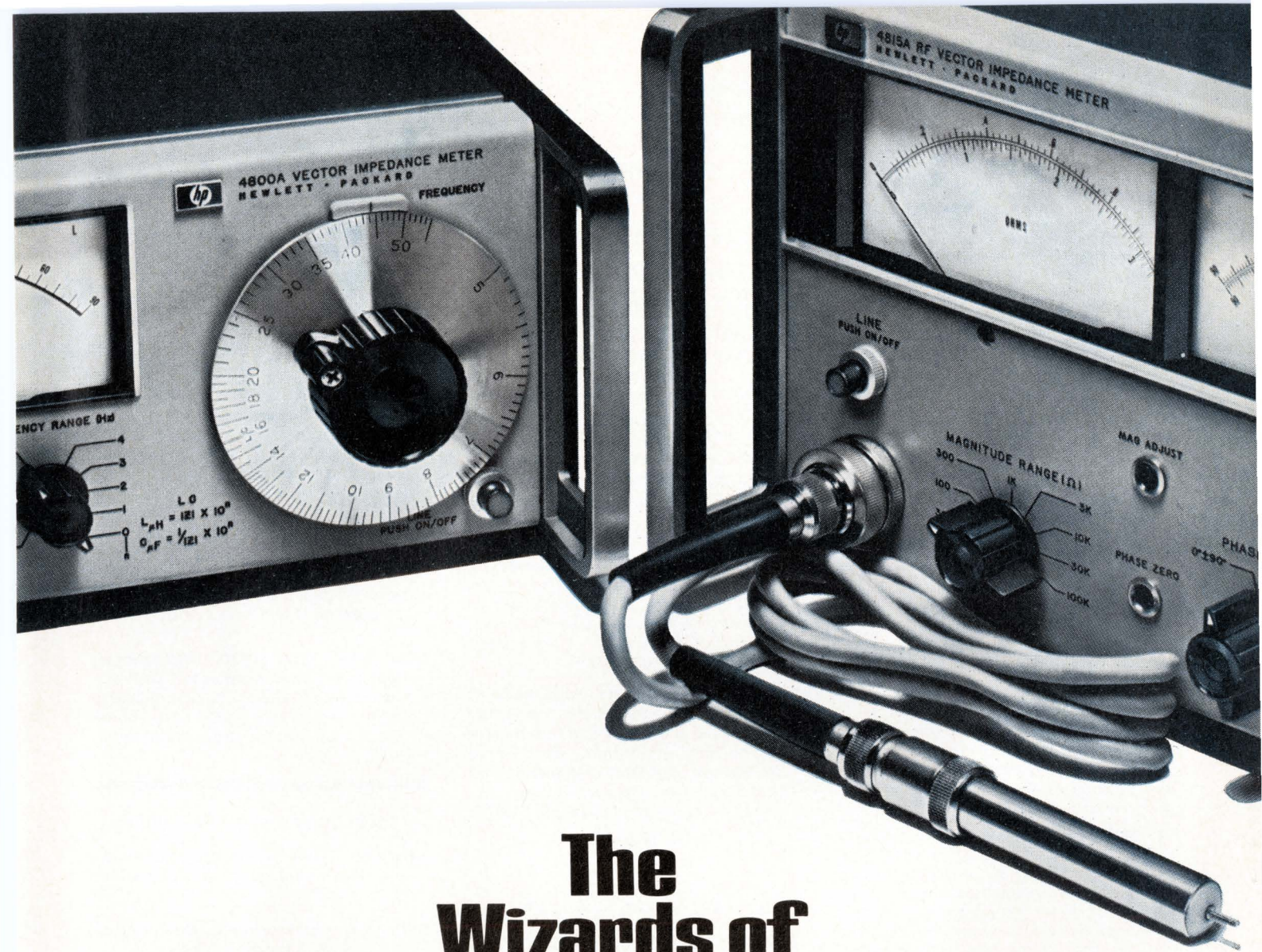

# The Wizards of $\theta Z$

Like magic . . . vector impedance instruments read out complex impedance in an instant.

With the HP impedance meters, measurements involving impedance magnitude,  $Z$ , and phase angle,  $\theta$ , no longer require tedious test procedures. These measurements are now as easy to make as voltage readings. No nulling . . . no balancing . . . no calculations to make. The wizardry of these HP instruments provides direct readout of  $Z$  (in ohms) and  $\theta$  (in degrees) over a continuous frequency range.

**HP 4800A Vector Impedance Meter** covers the 5 Hz to 500 kHz range. You set the frequency, select

the impedance range and read:  $Z$  from 1 ohm to 10 Megohms, and  $\theta$  from  $-90^\circ$  to  $+90^\circ$ . \$1650.

**HP 4815A RF Vector Impedance Meter** covers 500 kHz to 108 MHz. Measures, via a probe, active or passive circuits directly in their normal operating environment.  $Z$  from 1 ohm to 100 K ohms;  $\theta$  from  $0^\circ$  to  $360^\circ$ . \$2650.

Application Note 86 describes many applications of the 4800A and the 4815A Vector Impedance Meters including the measurement of  $Z$ ,  $R$ ,  $L$ , and  $C$ . For your copy and complete specifications, contact your local Hewlett-Packard field engineer or write: Hewlett-Packard, Green Pond Road, Rockaway, New Jersey 07866. In Europe: 1217 Meyrin-Geneva, Switzerland.

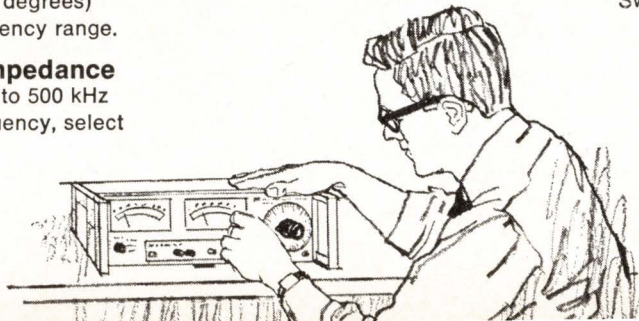

HEWLETT **hp** PACKARD  
IMPEDANCE INSTRUMENTS

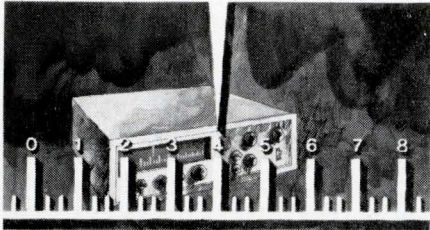

# Rent- a Test

Are the instruments in your lab the latest and most accurate available? Do you have all the equipment necessary to handle peak work loads? Does it provide enough versatility to take care of special requirements? Are you able to keep it in use during a respectable portion of the 8-hour day?

If you hesitated before answering yes, maybe you should think about putting RENTAL to the test. R.E.I. gives you a wide choice of the latest equipment, precision-calibrated and in perfect working condition. You can have as much as you need, when you need it, and you can keep it only as long as you need it.

R.E.I. can give you the fastest service, the widest selection and the lowest rates of any rental firm in the country. One of our inventory centers is located near you, wherever you are, for instant delivery. Let us tell you more about the many advantages of renting vs. buying. Send today for your free copy of the new R.E.I. Instrument Rental Handbook.

Amplifiers	Filters	Power Supplies
Analyzers	Generators	Recorders
Attenuators	Meters	Sources
Bridges	Oscillators	Stroboscopes
Cameras	Oscilloscopes	Synthesizers
Counters	Plug-In Units	Test Chambers
Detectors	Generator/Synchronizer	

## INSTANT INSTRUMENTS FROM THESE INVENTORY CENTERS:

**Waltham, Mass. 02154**  
69 Hickory Drive  
(617) 891-7610—Telex 923472

**Anaheim, Calif. 92801**  
159 East Freedom Ave.  
(714) 879-0561—Telex 655473

**Gaithersburg, Md. 20760**  
16600 Oakmont Ave.  
(301) 948-0620—Telex 898446

**Rosemont, Ill. 60018**  
5607 Pearl St.  
(312) 671-2464—Telex 726488

**Ft. Lauderdale, Fla. 33308**  
4808 N.E. 10th Ave.  
(305) 771-3500—Telex 51-4467

MORE INVENTORY CENTERS COMING SOON



# Rental Electronics inc.

A PEPSICO LEASING COMPANY

Circle 30 on Inquiry Card

## CALENDAR

### APRIL

5	6	7	8	9	10	11
12	13	14	15	16	17	18
19	20	21	22	23	24	25
26	27	28	29	30		

**Apr. 16-17: Conf. on Semiconductor Packaging in the 70's**, Park Sheraton, New York City. Addtl. Info.—George J. Fischer, Director of Conf., Polytechnic Institute of Brooklyn, 333 Jay St., Brooklyn, N.Y.

**Apr. 22-24: Southwestern IEEE Conference & Exhibition (SWIEECCO)**, Memorial Auditorium, Dallas, Texas. Addtl. Info.—A. P. Sage, Inst. of Tech., SMU, Dallas, Texas 75222.

**Apr. 27-30: IEEE Nat'l Telemetry Conference**, Los Angeles Hilton Hotel, Los Angeles, Calif. Addtl. Info.—Ray W. Sanders General Chairman, NTC/70, Computer Transmission Corp., Los Angeles, Calif.

**Apr. 28-29: 18th Annual National Relay Conf.**, Oklahoma State University campus in the Theatre of the Student Union Bldg. Addtl. Info.—Dr. Monroe W. Kriegal, Director, Engineering and Industrial Ext., Oklahoma State University, Stillwater, Oklahoma 74074.

### MAY

				1	2
3	4	5	6	7	8
9	10	11	12	13	14
15	16	17	18	19	20
21	22	23	24	25	26
27	28	29	30	31	

**May 4-7: International Conference on ION Implantation**, North American Rockwell Science Center, Thousand Oaks, Calif. Addtl. Info.—AFCLR (CRWG/Sven Roosild), L. G. Hanscome Field, Bedford, Mass. 01730.

**May 5-7: Spring Joint Computer Conf.**, Convention Hall, Atlantic City, N.J. Addtl. Info.—AFIPS Hdqs. 210 Summit Ave., Montvale, N.J. 07645.

**May 11-13: NEW Show**, Hilton Hotel, Chicago, Ill. Addtl. Info.—Show Office, 100 South Wacker Drive, Chicago, Ill. 60606.

**May 11-13: 24th Annual Technical Conf. and Exhibit of American Society for Quality Control**, Pittsburgh Hilton Hotel, Pittsburgh. Addtl. Info.—Robert W. Shearman, American Society for Quality Control, 161 West Wisconsin Ave., Milwaukee, Wis. 53203.

**May 19-21: IEEE Packaging Industry Technical Conf.**, Cherry Hill Inn, Cherry Hill, N.J. Addtl. Info.—IEEE, Inc., 345 East 47th St., New York, N.Y. 10017.

### JUNE

7	8	9	10	11	12	13
14	15	16	17	18	19	20
21	22	23	24	25	26	27
28	29	30				

**June 2-5: Conf. on Precision Electromagnetic Measurements**, Nat'l Bureau of Standards, Boulder, Colo. Addtl. Info.—G. M. R. Winkler, U. S. Naval Observatory, Washington, D.C. 20390.

**June 8-9: Chicago Spring Conf.**, Marriott Motor Hotel, Chicago, Ill. Addtl. Info.—Tucker Matzek, Warwick Electronics, Inc., 7300 N. Lehigh Ave., Chicago, Ill. 60648.

**June 8-10: IEEE 1970 International Conf. on Communications**, San Francisco Hilton Hotel, San Francisco, Calif. Addtl. Info.—ICC 70, Suite 2210, 701 Welch Rd., Palo Alto, Calif. 94304.

### '70 Conference Highlights

**WESCON** — Western Electronic Show and Convention, Aug. 25-28; Los Angeles, Calif.

**NEC**—National Electronics Conference, Oct. 26-28; Chicago, Illinois.

**NEREM**—Northeast Electronics Research Engineering Meeting, Nov. 4-6; Boston, Mass.

### Call for Papers

**Jan. 12-14: 1971 Annual Symp. on Reliability**, Sheraton Park Hotel, Washington, D.C. Deadline for submission of the paper title and an abstract of not less than 250 or more than 800 words is May 1, 1970. Send ten copies to J. W. Thomas, Program Chairman, Annual Symp. on Reliability, Vitro Labs., 14000 Georgia Ave., Silver Spring, Md. 20910.

**Jan. 19-21: Computer Designer's Conference & Exhibition**, Anaheim Convention Ctr., Calif. Submit your abstract, in triplicate, (300 to 500 words) by June 1 to: Technical Papers Committee, Computer Designer's Conference, 222 West Adams, Chicago, Ill. 60606. The completed paper, ready for publication, will be due on Dec. 1, 1970. The **Electronic Engineer** magazine is an associate sponsor of the Computer Designer's Conference.

**FAIRCHILD**

# Wanted: Catalysts.

Technical knowledge can be absorbed, administrative ability can be learned, but without the ability of one man to demand and get the utmost from other men's knowledge and skills little can be accomplished. This catalytic ability is the unique mark of a successful technical manager at Fairchild.

Working within a framework of unusual authority, he is personally responsible for the realization of a complex development product — on time, within cost and to customer specifications. He is a technical realist whose tools are the diverse talents of professional specialists.

He is a new breed of entrepreneur, operating with near-autonomy in Fairchild's flexible corporate structure, designed around the technological interrelationship of semiconductors, controls, graphics, systems, optics, microwaves, display devices, ordnance devices, reconnaissance systems and electrometrics.

To those who possess sound knowledge in their discipline and an alertness to the practical economics of technical management, we offer the opportunity to explore the full import and rewarding potential of a career with Fairchild. Write to Michael F. Hawkins,

Fairchild Camera and Instrument Corporation, 464 Ellis Street, Mountain View, California 94040.  
An equal opportunity employer.

# Is anybody out there?

**The IEEE meeting in Cleveland promised fireworks, but someone forgot to bring matches.**

By **John McNichol**, Assistant Editor

The past five years have seen the disappearance of some 230,000 jobs in the space program alone and the end seems not in sight. In 1969, around 119,000 people in the aerospace industry were laid off; the projection for this year is 300,000. In places like Cape Kennedy, Huntsville, Philadelphia, Los Angeles, and Seattle, these numbers are translated into the reality of layoffs, forced early retirements, housing, losses, unemployment lines, family moves, lost pension rights, and bitter feelings. So it should be no surprise to find that the man at the Chicken Delight counter, the man selling insurance, or even the man bagging your groceries is an electronic engineer caught in a situation he neither desires nor controls.

## Gunfight at the OK corral

This situation is complicated by such factors as a reported median earning level for plumbers \$10,000 higher than that of engineers, engineers functioning at non-professional levels, skyrocketing rates of technical obsolescence, and a pervasive feeling that something is basically wrong. All of which raises the question used as the theme of February's IEEE meeting in Cleveland: "What are you going to do for me in the 70's, IEEE?" Organized by Herbert H. Heller, chairman of IEEE's Cleveland Section, as a panel discussion, it featured Dr. F. Karl Willenbrock, past president of the IEEE; Milton

F. Lunch, general counsel of the National Society of Professional Engineers (NSPE); Dr. Wilhelm H. von Aulock, chairman of Bell Labs' Conference of Professional Technical Personnel (CPTP); and Harold J. Ammond, executive secretary of the RCA-Camden area Association of Scientists and Professional Engineering Personnel (ASPEP). Taped for TV and sound, and covered by members of the trade press and other technical societies, it would be the definitive meeting of the year—a forum with representatives of the classic engineering society, an engineering lobbying society, a sounding board organization, and an engineering union. Chairman Heller provided the point of departure: "After years of study before and after graduation, in an era when technology was king, a growing number of members of engineering associations—such as IEEE, ASME, and ASCE—found salary levels, retirement programs, and current job security elusive goals. Non-engineering associations, such as trade and teacher's unions, meanwhile secured these goals for *their* members."

It was Students' Night, and some 200 students and engineers filed into Case-Western Reserve University's Schmitt Auditorium that cold night hoping to see sparks fly; instead, they listened to recitations of the facts, figures, and viewpoints of the four different associations. For all its promise, the meeting, chaired by Cleveland IEEE program chairman Dr. O. K. Mawardi, never got on track. A member of the audience described it as sounding "like representatives of four religions in de-



Refereed by Dr. O. K. Mawardi, Cleveland IEEE program chairman (at the podium), and organized by Herbert H. Heller, Cleveland Section chairman, the "What are you going to do for me in the 70's, IEEE?" program brought representatives of the classic engineering society (IEEE), a lobbying engineering society (NSPE), a sounding board organization (CPTP), and an engineering union (ASPEP) together. Pictured here beside Dr. Mawardi are from left:

Dr. Wilhelm H. von Aulock, recently resigned chairman of Bell Labs' Conference of Professional Technical Personnel; Dr. F. Karl Willenbrock, past president of the IEEE; Milton F. Lunch, general counsel of the National Society of Professional Engineers; and Harold J. Ammond, executive secretary of the RCA-Camden area Association of Scientists and Professional Engineering Personnel (Photographs by Richard Sirow).

### What is a Sounding Board organization?

Neither fish nor fowl, the Sounding Board organization occupies a unique position in any listing of engineering associations. Organized at only two companies [Bell Telephone Laboratories—Conference of Professional Technical Personnel, Inc. (CPTP); and General Electric—General Electric Engineers Council (GEEC)], the sounding board is a voluntary association of employees which has a one way pipeline to upper management. This one-way pipeline carries information obtained in a continuing dialogue with members and other fellow employees on such matters as employee utilization, compensation, and welfare.

Classified by the Taft-Hartley Act as a labor organization, uncertified by the NLRB, unrecognized by management, and constrained by their own constitution, the sounding board organization exists in a limbo-like world with some disquieting problems, according to Dr. Wilhelm von Aulock, recently resigned chairman of the CPTP. Among these disadvantages are:

- Uncertain legal position. They are labor organi-

zations but are unable to take advantage of the Taft-Hartley Act.

- Inability to establish two-way communication with upper management.
- Impossibility of ascertaining success of efforts.
- The ease with which upper management can hinder the group by ignoring it.

However, Dr. von Aulock contends that there are some significant advantages, depending on the type of company and attitudes of upper management, such as:

- A simple and efficient communication channel to upper management and a good clearinghouse for information for engineers.
- Possibility of success when dealing with "enlightened and progressive" management.
- A low budget. Typical dues are \$8.00 a year.
- In interactions with upper management, an atmosphere of cooperation and mutual respect is vital. "There is little room for militancy," according to von Aulock.



**Dr. F. Karl Willenbrock:** "The IEEE is superb at forming committees; they can do it at the drop of a hat."

**Milton F. Lunch:** "Everybody knows engineers are professionals, except engineers."

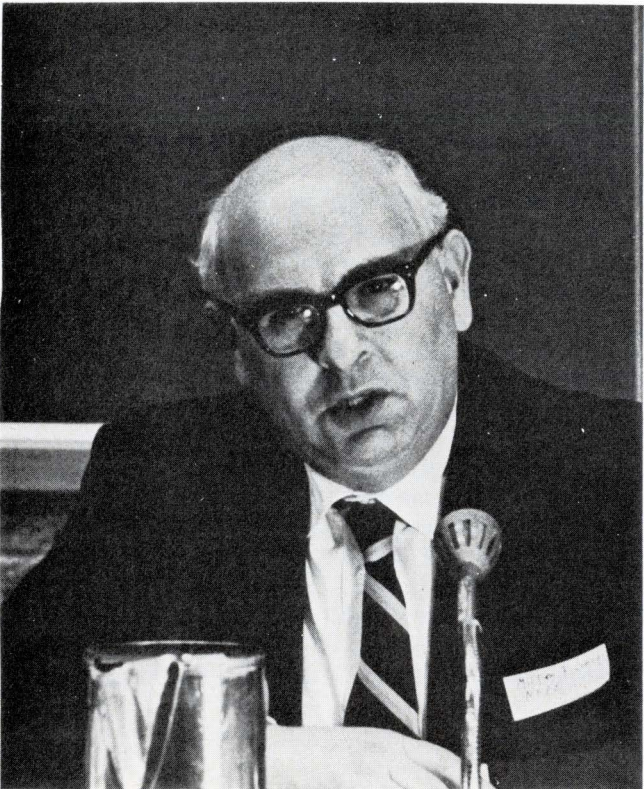

bate, each painting his religion as the best." Neither the panelists, the audience, nor the referee could seem to define, let alone come to grips with, the underlying problems that had brought everyone together.

Before the question and answer session, each panelist offered a sort of capsule position statement on his organization. ASPEP's Harold Ammond, noting that membership in his 1400-man union is voluntary, stressed that the only real lever a non-union engineer has when a situation distresses him is to leave the job. He also touched upon the founding of CESO (Council of Engineers and Scientists Organization), an international federation that may be a step toward professional union-unity. Milton Lunch of NSPE pointed out that his organization seeks to embrace nearly every interest of the engineer, with the exception of technical matters. This, he said, means promoting the professional, social, and economic welfare of engineers in such matters as salary, pensions, ethics, trade secrets, etc. Dr. F. Karl Willenbrock reiterated that the 160,000-member IEEE is interested in maintaining its traditional role of disseminating technical information "quickly and accurately." And finally, Dr. Wilhelm von Aulock developed the case for and against the Sounding Board organization (see box).

#### Ring around the rosie

Following these introductory remarks came the questions. They ranged over such matters as encouragement of more students to enter the profession, the image of the engineer, codes of ethics, salary levels, the problem of who represents the engineer, and portable vested pensions. Unanimity of opinion was most in evidence on the last topic, seemingly the only hard issue developed all evening. Willenbrock's position was that a portable pension program "would do more to make the engineer a real professional than anything else." Other worthwhile comments were presented:

- "If an engineer is not backed up or protected by a group such as a union, a code of ethics is meaningful only when it agrees with company objectives. If they disagree, the company-supported policy will win. It is no accident, I think, that the criticism of automobile industry came from a lawyer, not an engineer." (von Aulock.)

- "Unions are ill-suited to meet the needs of engineering employees." (Lunch.)

- "One characteristic of the IEEE is that it includes technicians, students, engineers, and people from all phases of management. If it would change to become more concerned with economic welfare, it would lose this diversity." (Willenbrock.)

- "Engineers' salaries are set by supply and demand." (Lunch.)

- "Not only IEEE, but other engineering societies, including EJC (Engineers' Joint Council), are actively recruiting new engineers. EJC is seeking \$500,000 to encourage the entrance of new engineers into the profession. And this week, thousands are being laid off. You better get some control or you'll be working for nothing. I know engineers laid off last July who are still

looking for jobs because they want to stay in the same area." (Ammond.)

- "It would be a serious mistake to do what the AMA did and control the number of students going into a profession. As a result our country, which has a high standard of living, has a low standard of health care compared to other countries. The same thing could happen in engineering." (Willenbrock.)

- "You should think seriously of requiring a four-year liberal arts course before the engineering training." (Lunch.)

- "An indication of psychic income is the rate of turnover of professional employees." (von Aulock.)

- Everybody knows engineers are professionals, except engineers." (Lunch.)

- "In answer to the question what the NSPE specifically does for the professional, social, and economic welfare of the individual employee at RCA, Lockheed, GE, or Westinghouse, it doesn't do anything. It tries to enhance the whole profession; it is not geared to the individual." (Lunch.)

As trenchant as these remarks are, they also indicate the shotgun approach to the problems that prevailed throughout the session, an approach that attempted to deal with too wide-ranging an area.

#### The positive side

Although Joseph Fitzgerald, a member of the Cleveland Section, felt that the forum's title had a selfish

sound and that many are satisfied with the IEEE, the evening disappointed part of the audience and some of the panelists. The IEEE answered no large questions, except to state that it would continue to educate and communicate with the engineer on technical matters in the best way possible, unless the membership expressed a desire for change. A member of the audience asked Dr. Willenbrock if the IEEE intended to form a committee to investigate some of the areas that had been discussed that night. He retorted that "the IEEE is superb at forming committees; they can do it at the drop of a hat." However, he did say that he would like members to send him their views, in concrete terms, on problems and/or proposals dealing with issues vital to engineers. **The Electronic Engineer** will be pleased to forward all such comments to Dr. Willenbrock. Problems of planning, failures of execution, and unfulfilled expectations aside, certain factors surrounding the meeting do offer a measure of promise. That the meeting took place, that such a title had been chosen, that four men representing a large and important element of the profession had come and talked, and that Karl Willenbrock took an inventory of the hard-core problems facing his membership are all to the credit of the organizers and participants. A single meeting will not produce the changes that are needed, but it may be indicative of a new and long-delayed move toward providing the engineer with a professional security and stability that he now lacks. The rest is up to you.



WE WANT OUR NAME ON THE TIP OF YOUR TONGUE!

**Scotchpar** 3M  
BRAND POLYESTER FILM COMPANY

# This new digital clock is systems oriented

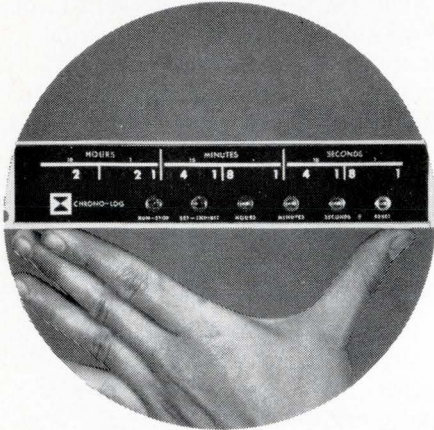

For systems requiring a digital output of time and date, Chrono-log offers the Series 30,000 Integrated Circuit Digital Clock, systems oriented because . . .

**IT MEETS EXACT SYSTEM NEEDS** — choose from standardized options such as BCD or NIXIE display, outputs of hours-minutes-seconds or other time formats, addition of month-and-day or day-of-year calendars, parallel or serial (or both) output gating, standard or expanded operating temperature range . . . and many more.

**IT SAVES SYSTEM SPACE** — measures only 1¾ in. high, 8¾ deep and half-rack wide.

**IT CUTS SYSTEM COST**—basic clock costs less than electromechanical or discrete-component models. Also, use of standardized options assures the features you want (over 7,500 combinations available) at off-the-shelf prices.

Uses for Chrono-log Digital Clocks include real time and elapsed time inputs for data logging, data transmission, data processing, time display, telemetry and digital printout systems.

For complete information write Chrono-log Corp., 2583 West Chester Pike, Broomall, Pa. 19008 or call (215) 356-6771.



Circle 32 on Inquiry Card

## WELCOME

This column welcomes new companies or new divisions in the electronics industry.

### The chips are down!

The formation of Semiconductor Electronic Memories Inc. in June of 1969 introduced a dynamic new member to the field of MSI/LSI technology. Because of its automated assembly techniques, the company promises a random access memory which will be competitive in price to core memory systems.

To be more exact, SEMI will be introducing a family of eight random access memory systems this month. The systems range from 128 words x 8 bits to 1024 words x 9 bits and are fabricated using bipolar semiconductor chips. But what's really important is that the company, instead of using wire bonding, flips the chips and assembles them using a controlled collapse, reflow solder method which significantly lowers the cost.

And these systems have other notable features as well. Their cycle times, for instance, are 200 ns with a power consumption of ½ mW/bit. The advantage here is obvious when you consider that the cycle time of core memory systems is usually 2 µs, and the power consumption of an equivalent size system is ten times that of the new systems. Also, the packing density of the new systems is 500 bits/in.<sup>2</sup>, double that achieved by core systems in this size range.

The leaders behind this challenging new firm are Mr. William R. Arnold, president of the company, and Mr. T. W. Hart Jr., manager of product development. Both had been independently involved in the semiconductor memory business before, Arnold as assistant to the director of product reliability at IBM's component division, and Hart as manager of IC memory products at Motorola. Mr. Trude C. Taylor, chairman of the board at Electronic Memories and Magnetics Inc., arranged financial support through his company for their endeavor.

Experience in the field is a major contribution of all the members of the managerial staff. Dr. A. H. Mones, serving as vice president of technology, was co-inventor of IBM's solid logic technology process. Mr. F. H. Kost, vice president of engineering, directed development programs in IC test system design at IBM. And Mr. Don Winstead serves as vice president of marketing, having previously held the same position at Signetics.

Mr. Winstead reminds us that SEMI, although funded by Electronic

Memories and Magnetics Inc., is a separate corporation. "We have completed construction of both our \$1 million semiconductor operations facility and our modular operations facility in Phoenix, Ariz." Initial product deliveries are expected to commence towards the middle of the year.

Circle 499 on Inquiry Card

### Components outlet

The Semiconductor Assembly Division of General Instrument Corp., located in Newark, N.J., is emphasizing silicon bridge assemblies. More specifically, the new division is taking semiconductors manufactured by its "big daddy" and utilizing them in assemblies of all kinds. Formed one year ago, the Semiconductor Assembly Div. is presently offering a range of high voltage selenium and silicon rectifiers (puck, cartridge, and block types) which have been designed for use in X-ray equipment, radar ovens, precipitators, and oscilloscopes. A range of standard modules, as well as assemblies and custom designs are available, depending on the customer's request.

According to a spokesman for the new division, "competition in this sphere is great. However, by knowing semiconductor devices as well as we do, and because we can work in chip form and assemble the chips into master assemblies, we feel we have the competitive edge."

A solid-state voltage multiplier for color TVs is also being offered by the Semiconductor Assembly Div. Designed to replace the high voltage rectifier tube in the horizontal deflection circuit, the voltage regulator tube, and the selenium focus rectifier, the multiplier's cost is presently the same as these three components, but is expected to drop as production increases. The solid-state device delivers 25,000 V to the picture tube without radiation, which is its advantage over the vacuum tube design. Another salient characteristic of the multiplier is a high-frequency silicon diode module that is capable of handling high overload currents. Other key features include greater reliability, lower power dissipation, modularization, and the possibility of a more compact horizontal deflection circuit. The device supplies 25 kV at 2.5 mA. Regulation is better than 6% from no load to full load from a voltage input of 8.3 kV.

Circle 500 on Inquiry Card



# Our past can forecast your **FUTURE.**



You may be interested, as many of us are, in checking your daily horoscope. However, past accomplishments are usually due to individual talents, rather than to a zodiac reading.

Link Engineers have devoted their time to going about the business of being first—first in advanced electronics technology. Our Advanced Technology personnel developed the Spacecraft Television Ground Data Handling System which reproduced every photograph of the moon's surface resulting from the Ranger, Mariner and Surveyor missions. Our Transportation Products group is chartered to work in four technical fields concerning transportation—traffic control, railroad and rapid transit, cargo and container identification and aircraft ground control. Our Ordnance personnel have produced eleven systems for the Apollo mission alone, while also contributing heavily to Saturn

and other projects. Beyond these achievements, Link engineered the Lunar Module Mission and Apollo Mission flight simulators—used to train the people who extended man's parameters to the surface of the moon.

Quality and superiority in advanced products comes first with Link. That's where you come in. Opportunity is unlimited. And, the San Francisco Peninsula embodies all the excitement of the California way of life for you and your family. Forward your inquiry to Mr. Richard Nadzam, 1105 Kern Avenue, Sunnyvale, California 94086. We are an equal opportunity employer.

**SINGER**  
LINK DIVISION

**Circuit Design Engineers, Logic Design Engineers, Digital Test Engineers, Systems Engineers, Electronic Sales Engineers, Scientific Programmers, Digital Technicians.**

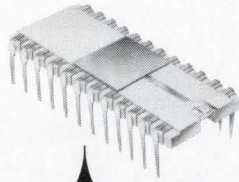

**one-package**

---

**ATOS  
counter  
display  
drivers**

**available in production quantities**

# General Instrument's new one-package MTOS counter display drivers replace conventional counter decoding and driving systems requiring at least 3 packages

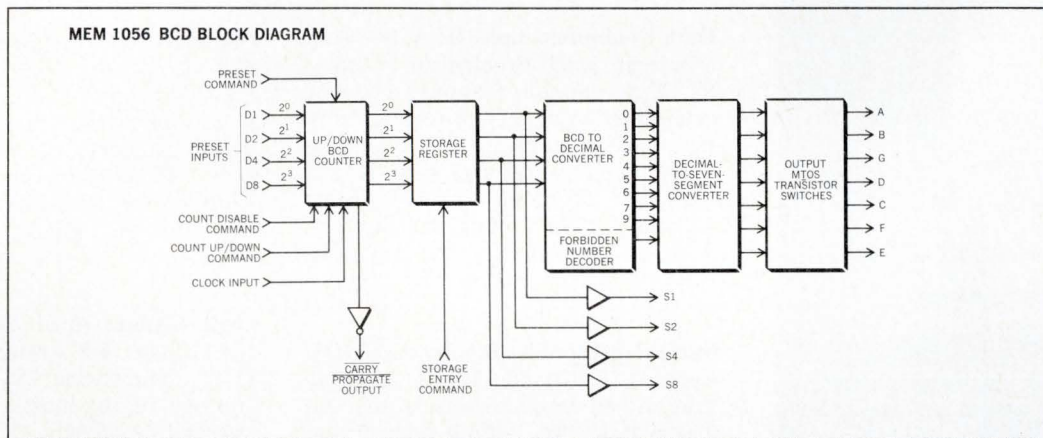
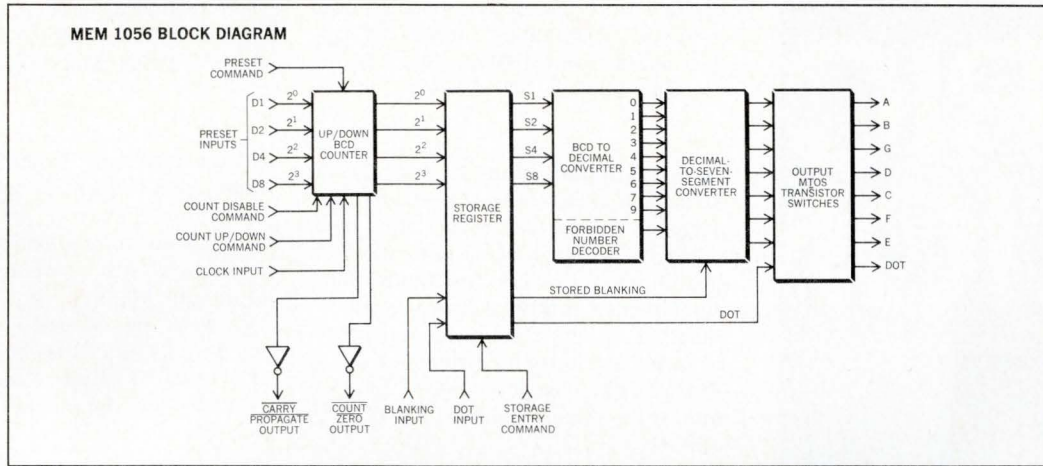

It takes only one MTOS MEM 1056 in one 24 lead dual in-line package to drive a seven segment fluorescent readout tube such as the DIGIVAC® S/G.

Conventional IC counter decoder and driving systems require at least 3 packages to do the same job.

The elimination of the need for all but this single package means lower installation costs, lower PC board costs, less assembly and test time and, of course, higher reliability.

The MEM 1056 is an MTOS monolithic integrated circuit designed primarily to operate in conjunction with a seven segment fluorescent readout tube for displaying numeric information. It contains a one decade up-down BCD counter, a storage register, a BCD-to-seven segment decoding matrix and display drivers. The device features:

- Direct Display Drive Capability
- Low Power Consumption
- Count Zero Indication
- Decimal Point Indication
- False Code Indication
- Blanking Input

The up-down counter sections of the chips can be cascaded to form synchronous counting chains. Also, by utilizing external elements, asynchronous, one-megacycle, up-down counting can be achieved irrespective of the number of counter stages cascaded.

The description and features of the MEM 1056 BCD are basically the same as those of the MEM 1056 except that the BCD version has four BCD outputs.

Both the MEM 1056 and MEM 1056 BCDs are available from your authorized General Instrument Distributor. For full information write General Instrument Corporation, Dept. 56, 600 West John St., Hicksville, L. I., N. Y. 11802. (In Europe, write to General Instrument Europe S.P.A., Piazza Amendola 9, 20149 Milano, Italy; in the U.K., to General Instrument U.K., Ltd., Stonefield Way, Victoria Rd., South Ruislip, Middlesex, England.)

\*DIGIVAC is a registered trademark of Wagner Electric Corporation



GENERAL INSTRUMENT CORPORATION • 600 WEST JOHN STREET, HICKSVILLE, L. I., NEW YORK

# WAFER FABRICATION

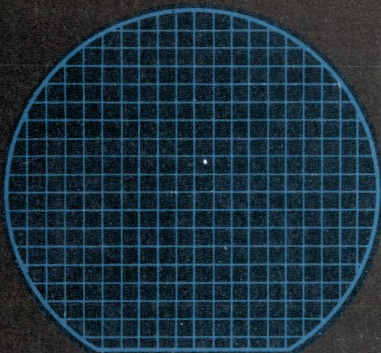

## FROM YOUR MOS/LSI DESIGNS

The formula for low cost MOS/LSI is where you reassume design responsibility and Cartesian takes care of wafer fabrication. Costs? Less than you think . . . \$1,000 buys you ten, two-inch MOS/LSI wafers from your plates . . . fabricated under tight process control and using proven technology. Fringe benefits: Simple purchase order procurement, protection of proprietary information, and 2 to 3 weeks delivery. Cartesian also makes exceptional masks: Fewer defects, tight registration and close line width tolerances . . . we have the equipment and organized skills to deliver masks that meet spec first time out. CARTESIAN, INC., 10432 North Tantau, Cupertino, Calif. 95014. Telephone (408) 257-0481.

 **CARTESIAN**

Circle 35 on Inquiry Card

## COURSES

**Parametric Design of Digital Filters:** April 13-16, Boston; \$275. To provide the basic mathematical design procedures and techniques for realizing digital filter transfer functions and digital representations of continuous systems. Technology Service Corp., 225 Santa Monica Blvd., Santa Monica, Cal. 90401.

**Data Communications I:** April 14-15, Montreal; \$165. For those with experience in the design of batch-type, data-processing systems who want an introduction to data communications, fundamental technical concepts, equipment and services, message control concepts and software principles. ACM Professional Development, 1133 Avenue of the Americas, New York, N.Y. 10036.

**Data Communications II:** April 16-17, Montreal; \$165. Problems of planning for data communications including determination of service requirements, selection of hardware to fit applications, building adequate controls and evaluation of proposals and software packages. ACM Professional Development, 1133 Avenue of the Americas, New York, N.Y. 10036.

**Integrated Circuits, Bipolar and MOS:** April 20-22, Atlanta; May 11-13, New York; \$295. Emphasizes selection and specification of circuit types and identifies design limitations of digital and linear ICs; recognition of differences between ICs and their discrete counterparts. RCA, Institute for Professional Development, Box 962, Clark, N.J. 07066.

**Printed Circuit Technology:** April 20-23, Cleveland; \$345. Designed to give an overview of the technology involved in the design, fabrication, assembly and production of PC boards. Sylvania, 63 Second St., Waltham, Mass. 02154.

**Digital Communications:** April 20-24, Chicago; \$395. Develops the practical design criteria of digital communication hardware. Various modulation techniques and optimum coding schemes are presented with practical applications of information theory in the field. RCA, Institute for Professional Development, Box 962, Clark, N.J. 07066.

**Integrated Circuit Technology:** April 21-23, Chicago; \$290. To provide necessary information on spec sheet evaluation, cost-reduction methods, state-of-the-art devices and circuit design techniques for greater efficiency and reliability. Sylvania, 63 Second St., Waltham, Mass. 02154.

**Microelectronic Soldering and Brazing:** April 27-28, Boston; \$175. Details the behavior of materials as related to microelectronics in order to analyze the methods of obtaining optimum bonding conditions. Emphasis will be placed on prebonding operations and the bonding process. Technical Forum Assoc. Inc., 545 Technology Sq., Cambridge, Mass. 02139.

**Digital Systems Engineering:** April 27-May 1, Wash., D.C.; \$390. Digital design principles and interfacing techniques involving such subjects as sampling theory, A-D and D-A conversion and modern encoders. RCA, Institute for Professional Development, Box 962, Clark, N.J. 07066.

**Logic Design:** April 27-May 1, Syracuse; May 4-8, Minneapolis; May 11-15, Huntsville; \$395. To learn selection of the most straightforward, practical approach to digital circuit design. Currently available numerical and graphical design methods will be illustrated to increase logic design effectiveness. RCA, Institute for Professional Development, Box 962, Clark, N.J. 07066.

**Solid State Parameters and Models:** May 12-13, Madison; \$100. To present the latest state-of-the-art in the techniques of gathering parameter and model data preparatory to computer design. David P. Hartmann, Univ. of Wisconsin, 432 N. Lake St., Madison, Wis. 53706.

**Data Communications Systems:** May 13-15, Washington, \$250. Orients the potential user in system design aspects, hardware considerations and software organization and implementation. Institute for Advanced Technology, Control Data Corp., 5272 River Rd., Washington, D.C. 20016.

**YES!**  
**NORTRONICS**  
 will show these  
 and other  
**IBM-compatible**

**DIGITAL  
 HEADS\***

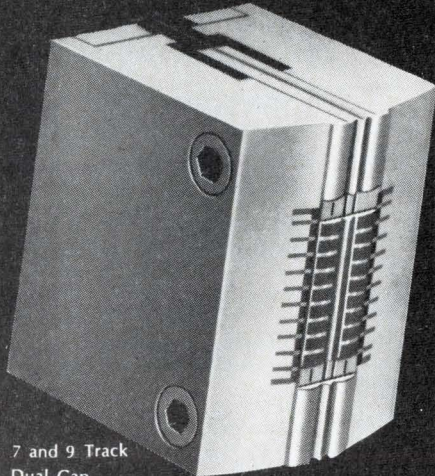

7 and 9 Track  
 Dual Gap  
 READ AFTER WRITE

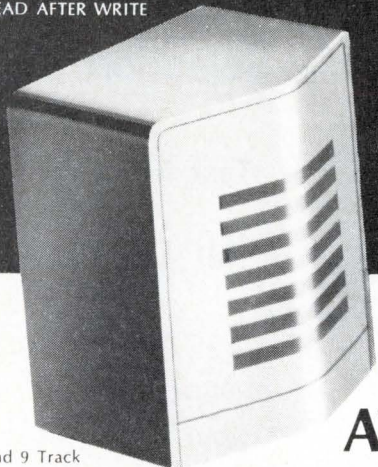

7 and 9 Track  
 Single Gap  
 READ/WRITE

**AT  
 SJCC**

**BOOTH 50010**

See them there or write for specs!

\*Card Reader and Mini-Digital Heads too...  
 From The World's Leader In Magnetic Recording Heads.

 **Nortronics**  
 COMPANY, INC.  
 8101 Tenth Avenue North  
 Minneapolis, Minnesota 55427  
 (612) 545-0401

Circle 36 on Inquiry Card

**PRODUCT SEMINARS**

This column lists product seminars that electronic companies offer to users of their products.

**Vacuum Technology:** April 13-15, Palo Alto; \$195. Thin-film deposition by sputtering and evaporation and surface research (Auger spectroscopy) are the fields you'll become familiar with at this seminar. You'll also receive background information on vacuum instrumentation and techniques. Varian, 611 Hansen Way, Palo Alto, Cal. 94303.

Circle 493 on Inquiry Card

**Operator's Seminar:** April 14-17, Canton. Machine characteristics, capabilities and limitations are taught to you as you receive background information on the operating techniques of Instron testing equipment. Instron Corp., 2500 Washington St., Canton, Mass. 02021.

Circle 494 on Inquiry Card

**Maintenance Seminar:** April 27-May 1, Canton. As you work with Instron testing equipment you will learn practical applications, troubleshooting, service and preventive maintenance techniques. Instron Corp., 2500 Washington St., Canton, Mass. 02021.

Circle 495 on Inquiry Card

**Operation and Maintenance 1912 Visicorder:** May 4-8, Denver, \$180. Using basic knowledge of electronics and solid-state devices, and repair experience on correlated instrumentation, you'll be well prepared to learn the operation, calibration and maintenance of this sophisticated recording instrument. Honeywell Inc., Test Instrument Div., Box 5227, Denver, Colo. 80217.

Circle 496 on Inquiry Card

**General Instrument Seminar:** May 4-15, North Wales; \$100. You'll become directly involved in discussions and workshop experiences on both measurement and control of such regulated process variables as temperature, pressure, flow, pH and conductivity. Leeds & Northrup, North Wales, Pa. 19454.

Circle 497 on Inquiry Card

**Application of Instruments and Instrument Systems to Dynamic Analysis:** May 11, New York City area. The purpose of this seminar is to help you get the best mileage from your SDC instruments and systems. Spectral Dynamics Corp., Box 671, San Diego, Cal. 92112.

Circle 498 on Inquiry Card

**MASK  
 MAKING**

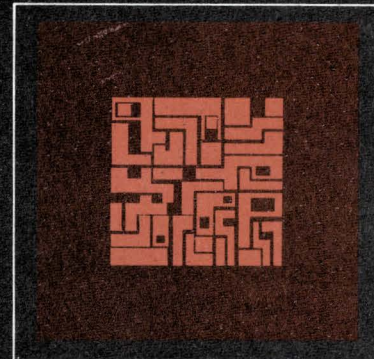

**WITH OUR LASER  
 INTERFEROMETER**

Cartesian's laser interferometer-controlled photo-repeater provides exceptional masks through precision stepping. **ENVIRONMENT:** Class 100 laminar flow. Stable, proven processing technology. **FIT:**  $\pm 0.03$  mil from mask-to-mask at the master level over 95% of patterns (encompasses registration, chip size differential, and chip rotation). **LINE WIDTH TOLERANCE:** Held to 0.03 mil or 10% of line width, whichever is less. **DEFECTS:** Fewer than 10 defects/in<sup>2</sup>. Defined as any clear irregularity in dark area or dark irregularity in clear area whose largest dimension is greater than 0.1 mil. **RESULTS:** We take time from the beginning to plan mask-making thoroughly, ensuring delivery of masks that are right the first time out. Contact the company that has the equipment, organized skills and common sense to do your job right. **CARTESIAN, INC.**, 10432 North Tantau, Cupertino, Calif. 95014. Telephone (408) 257-0481.

 **CAR  
 TESIAN**

Circle 37 on Inquiry Card

# UNIVERSAL IC PACKAGING PANEL

INCREASES FLEXIBILITY  
IN PROTOTYPING  
PRODUCTION AND  
FIELD SERVICE

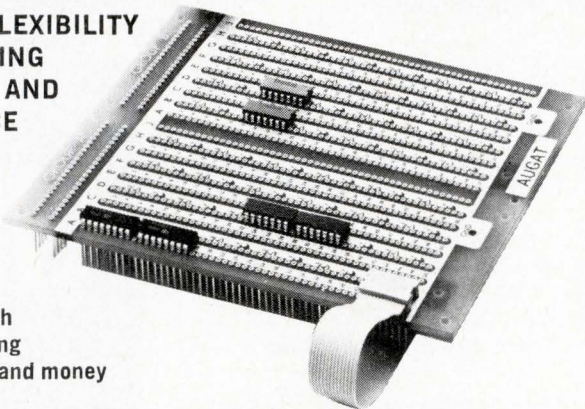

U Series panel with  
point to point wiring  
saves time, space and money

- Available in multiples of 9 row sections up to 54 rows.
- Each 9 row section accepts 3 plugs for interfacing or input-output connections.
- Accepts 14, 16, 24 and 36 lead Dual-in-Line integrated circuits.
- Double sided board with power and ground planes connected to additional wire wrap terminations outside of contact row.
- Wire wrap terminations with tri-level connection length.

Request complete I. C. folder.

**AUGAT**  
INC.

Tel: 617-222-2202  
39 Perry Ave., Attleboro, Mass. 02703

Circle 38 on Inquiry Card

Here is your  
copy of a brand new  
reference chart  
sponsored by



Guide  
to

**POWER SUPPLY  
Selection**

Tear it out, 

**NOW**

... and  
mount it on  
your wall

If the chart has been  
removed, Circle Num-  
ber 41 on the Inquiry  
Card for a copy.

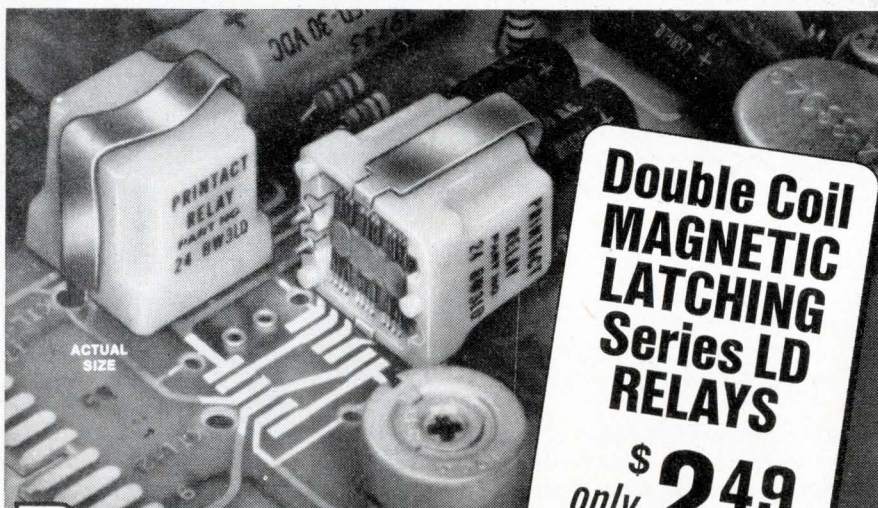

**Printact**<sup>®</sup>

**Plugs into your PC board... mates with plated conductors**

Where memory without power is a requirement in the design of control circuitry, the use of the "LD" relay results in a compact-low cost module. Reliability is assured by the unique design which includes, as standard, many features not generally available in commercial relays.

Encapsulated coil, bifurcated gold or palladium contacts, low thermal EMF, plug-in without sockets or soldering, low bounce and chatter, series-break switching eliminates pig-

tails, permanent magnet avoids return spring and mechanical linkage—all of which assures continuous performance for many millions of cycles.

Available with 6, 12 or 24 VDC 1 watt coil (AC operation with series diode) in 2, 3 and 4 pole configuration. Series break swingers permit each pair of fixed contacts to be etched with common (Form C) or isolated (Form A plus Form B) switching between make and break circuits.

For data write or call 212-EX 2-4800.

Printact Relay Division, Executone, Inc., Box 1430, Long Island City, N.Y. 11101

**Double Coil  
MAGNETIC  
LATCHING  
Series LD  
RELAYS**  
only \$ **249** EACH  
(IN LOTS OF 5,000)

# MOS Course—Part 3

## Applications of MOS circuits

Interfacing MOS and bipolar logic p. 62

MOS arrays in a data terminal p. 67

MOS shift registers in arithmetic operations p. 71

So far, our course on MOS integrated circuits has described the making of the devices (part 1) and combining them to form circuits (part 2). This month, we will look into some applications for these circuits.

### Interfacing MOS and bipolar logic

Most applications of MOS circuits are in systems that also use bipolar devices. Part 1 of the course touched upon a few of the problems associated with this mating. Attempts to make the two more compatible have given birth to several types of MOS devices with low-threshold voltages. However, these low-threshold devices are only a partial solution to the problems of interface, as is illustrated by the use of MOS circuits in the construction of shift registers, one of their most popular applications. An MOS shift register presents two different kinds of loads to the bipolar logic driving it. Besides the normal logic input, the register must be supplied with a clock (or clocks), presenting an entirely different interfacing problem. The first part of this month's MOS course is devoted to ways of combining MOS and bipolar. On page 62, you will find a discussion of just what the problems at the interface are. More importantly, you will also find circuits to help you solve these problems. The article includes methods of interfacing MOS with all of the popular bipolar logic families. Because of the popularity of TTL in today's systems, special attention is devoted to the TTL/MOS interface.

### MOS in data terminals

Many optimistic predictions have been made about the future of MOS. Up to now, the figures have been a bit disappointing—for a variety of reasons. But things are beginning to change; more and more devices are becoming available and an increasing number of companies are committing themselves to MOS.

One of the first companies to make such a commitment—Viatron Computer Systems—supplies the second part of this month's course. Viatron, with their System 21, is one of the largest users of MOS ICs in the United States. The article shows you how they make substantial use of MOS arrays in the System 21 data terminal. This is hardware being built today.

### Arithmetic operations with MOS

This segment, mainly covering desk calculators, rounds out the April MOS course. MOS and calculators have not always been a happy combination. The example of the Victor calculator, one of the first attempts to use MOS in a piece of commercial equipment, readily springs to mind. But the main fault in this project was trying too much too soon; calculators are a natural application for MOS. Since the paramount concerns are size and cost, the ballgame belongs to MOS. While MOS circuits cannot compete with bipolars in speed, they can certainly pack more function in a given area.

## MOS course—Part 3

# Interfacing MOS and bipolar logic

These circuits can help you ease the communication problem between MOS and bipolar.

By **Tom Reynolds**, Applications Engineering  
Motorola Semiconductor Products Inc.

Logic circuits that use MOS devices operate with a variety of power supply voltages and a wide range of logic swings. With limited exceptions, neither the input/output levels nor the power supply voltages match those of the popular bipolar logic families.

Because of the variety of MOS operating levels, a number of different circuits are needed to interface bipolar and MOS logic. However, a few generalizations are possible. Most MOS circuits operate with widely spaced power supply potentials and with logic levels that are relatively close to the high and low power supplies.

### The MOS gate

The typical MOS gate is electrically a capacitor. It draws essentially no current in either the high or low state. Changing the level, however, is equivalent to charging or discharging a capacitor—generally through a moderately high resistance.

The basic requirements for operating a MOS logic input are an adequate voltage swing at the appropriate levels and sufficient current capability to drive the capacitance at the required speed.

The circuit for a particular translation requirement depends on the MOS devices employed, the bipolar family driving it, and the relative values of both the bipolar and MOS power supplies. In order to define specific translation circuits, you must consider the requirements of the particular MOS device. A suitable example is the Motorola MC1150, a one-of-eight MOS multiplex switch. This device requires a logic swing of approximately 10 V making it incompatible with the four most common forms of bipolar logic—DTL, TTL, RTL, and ECL. (The logic swing for these families ranges from the 0.85 V of ECL to somewhat more than 3 V for DTL and TTL.)

The key translating circuit parameter is the potential of the MOS circuit substrate (commonly labelled  $V_{SS}$ ). The MOS devices switch at a threshold voltage that is determined by the gate potential relative to the substrate. In the case of our example, an input tran-



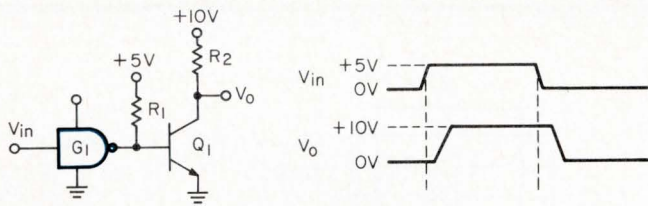

**A TTL or DTL to MOS buffer for a substrate voltage of +10V.** The bipolar gate ( $G_1$ ) can be any TTL gate with open collector output or DTL gate with passive pull-up. Typical values of  $R_1$  and  $R_2$  are 10 K $\Omega$  and 3 K $\Omega$  respectively. If  $G_1$  is an active pull-up TTL gate, resistor  $R_1$  should be eliminated.

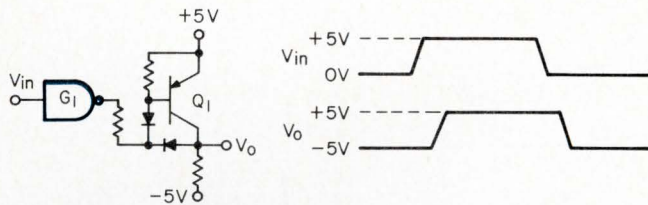

**This circuit is useful when the MOS substrate is at +5 V.** It can be driven by any TTL or DTL gate. The diodes prevent the saturation of  $Q_1$  and reduce the turn-off time. The use of these diodes is optional and depends upon the speed required from the translator.

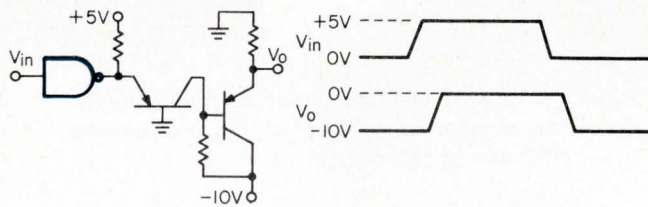

**This translator can be used when the MOS substrate is at system ground.**  $G_1$  can be any DTL gate with a passive pull-up or a TTL gate with an open-collector output.

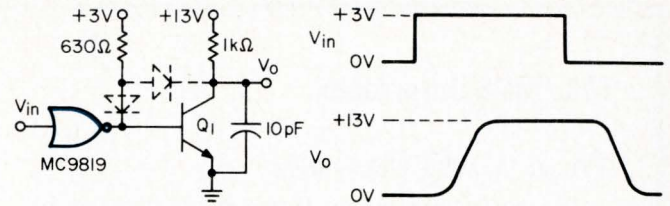
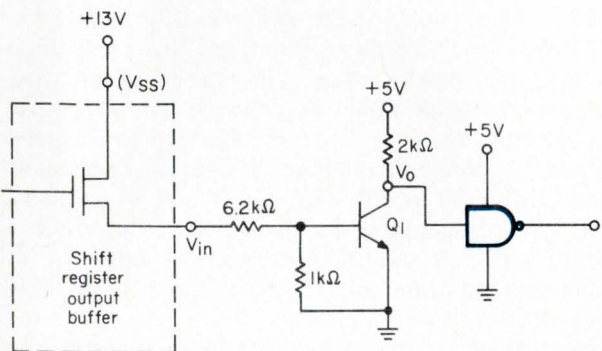
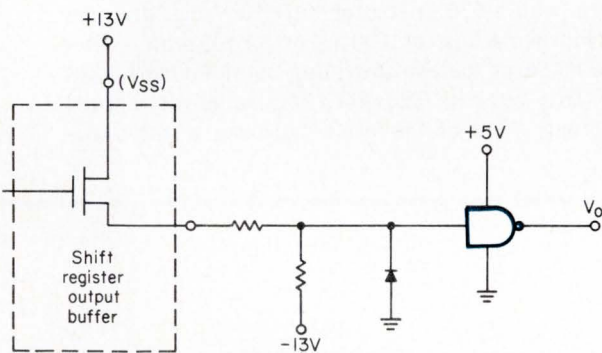

**A RTL to MOS buffer.** The RTL expander has an open-collector input. You can use the diodes shown with dotted lines to reduce the storage time of  $Q_1$ , by keeping it out of saturation. This technique is most significant for transistors whose storage times are  $> 60$  ns such as the 2N2222. Because of the transistor's inherent high speed, the diodes do not appreciably improve the performance of transistors such as the 2N3508. By replacing the RTL gate with a TTL gate having an open-collector, and changing the 3 V to 5 V, the circuit will convert TTL logic levels to MOS levels.

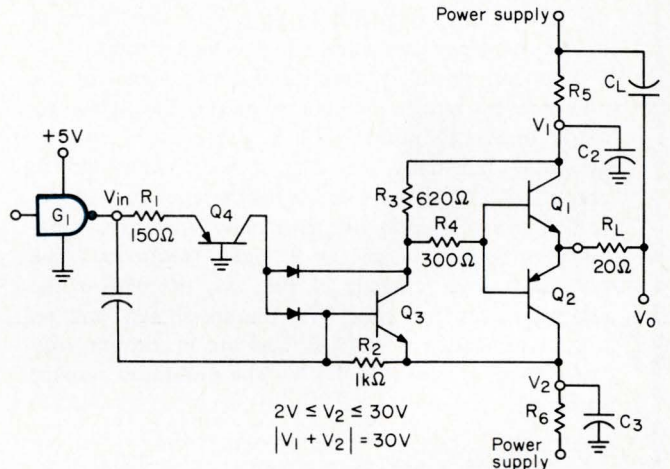

**A clock pulse driver for a MOS shift register.** The gate  $G_1$  must provide an active pull-up to produce the desired delay time and fall time ( $t_f$ ) in the output waveform. Transistor  $Q_1$  acts as a switched current source and provides current drive to  $Q_3$ . Since  $Q_1$  is never saturated, it produces little time delay. The diodes keep  $Q_3$  out of saturation and reduce the turn-off time of  $Q_3$ , if fast diodes are used. Capacitor  $C_1$  couples the voltage transitions at the output of  $G_1$  to the base of  $Q_3$ . This coupling also helps to decrease the turn off time of  $Q_3$ . Because of the voltage level shifting provided by  $Q_1$  and  $Q_3$   $V_1$  and  $-V_2$  can cover a wide range of values.

For normal operation,  $V_1$  is equal to the substrate voltage. The most common substrate voltages used are 0 V, +5 V, and +13 V. Typically,  $-V_2$  is about 26 V below  $V_1$ . The clock-driver shown can handle any of these three substrate voltage conditions while still interfacing with TTL/DTL, 0 to +5 V-logic signals. The clock line must be held within 2 V of the substrate voltage between clock pulses. This driver meets this requirement since  $Q_1$  pulls up the capacitive load to one  $V_{BE}$  drop below  $V_1$ . In the other direction, the load is charged to a voltage equal to two diode drops above  $-V_2$  since the  $V_{CE}$  of  $Q_3$  is held to a diode voltage drop.

Transistors  $Q_1$  and  $Q_2$  form a complementary emitter follower pair. Using the emitter-follower configuration to drive large capacitive loads can produce stability problems. With a large enough capacitive load, the real part of the input impedance to an emitter-follower can become negative at high frequencies. If the source impedance of the source driving the emitter-follower is small, the real part of the total impedance at the emitter-follower input can remain negative. This results in ringing type oscillations during voltage transitions at the emitter-follower input. Resistor  $R_4$  in the clock pulse driver provides for additional series resistance between the collector of  $Q_3$  and the base of  $Q_2$ . This eliminates the possibility of oscillation when  $Q_2$  is charging  $C_1$  to  $-V_2$ .

When driving large capacitive loads, the  $V_1$  and  $-V_2$  power supplies are required to deliver fairly large transient currents. If the lead lengths from the power supplies to the clock pulse driver are long, or if the capability of the power supplies is somewhat deficient at these peak current loads, use of the decoupling networks, consisting of  $R_5$ ,  $R_6$ ,  $G_2$  and  $C_3$  is strongly recommended to prevent large voltage spikes on the power supply lines.

## TTL/MOS Interfaces

### TTL as a MOS clock driver

The guaranteed output levels of TTL circuits are  $< 0.4$  V and  $> 2.4$  V. On the other hand, MOS single phase clock inputs require levels more negative than  $-9$  V and less negative than  $-2$  V. Therefore, it is necessary both to amplify the signal and to shift levels at the TTL-MOS clock interface.

Applying a positive voltage (called  $V_{SS}$ ) to the substrate of the MOS circuit accomplishes the level shifting. Normally, all voltages in a MOS circuit are referenced to the substrate potential. While  $V_{SS}$  does not have to be connected to ground, it does have to be the most positive voltage in the MOS circuit.

You can passively amplify the TTL signal at the interface by returning the TTL output through a resistor to a minimum  $+10$  V (referenced to TTL ground). Normally, the TTL output would go to about  $+3.5$  V at the 1 level; it now goes to  $+10$  V.

The size of the resistor determines the drive capability measured in pF at a given frequency. The normal 0 level current of the TTL determines the minimum resistor size. The circuit shown has an output resistance of  $4.17 \Omega$  and the maximum voltage allowed across it is  $0.4$  V. The minimum resistor value is:

$$\frac{R_x}{4.17} = \frac{9.6}{0.4} \quad R_x = \frac{9.6 \times 4.17}{0.4} = 100 \Omega$$

The power dissipated in the TTL device is only  $19$  mW,  $+20$  mW at  $1$  MHz for discharging the line capacitances. The resistor dissipates approximately  $\frac{1}{2}$  W. The resistor gives a rise time of  $100$  ns when driving  $400$  pF or  $50$  ns when driving  $200$  pF. The  $100$  ns rise time is adequate when operating at  $800$  kHz or less. The realizable clock drive capacity in terms of number of circuits depends to some extent on the capacitance of the interconnecting wiring. When less drive capacity is required, the resistor

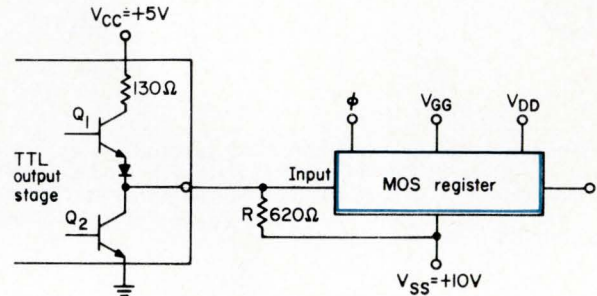
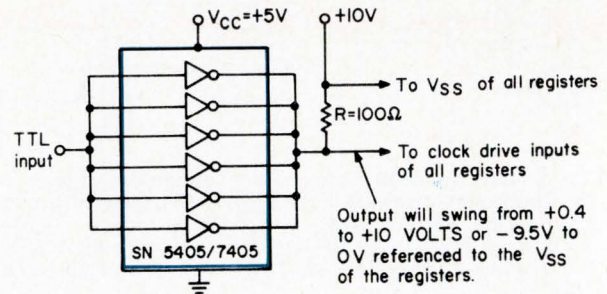

value is increased and the power appropriately reduced the number of sections of the hex inverter used could also be reduced.

### TTL to MOS interface

TTL circuits can provide data and control signals to MOS circuits in the same manner that they supply single phase clock drive. A standard  $54/74$  single output with a  $620 \Omega$  resistor to  $+10$  V can drive  $64$  pF with a risetime of  $100$  ns or  $32$  pF with a risetime of  $50$  ns thereby providing considerable fanout into MOS circuits. The  $54L/74L$  series of circuits have only  $1/10$  of this drive capacity, so their use-

sistor is off when the gate potential (relative to the substrate), is less negative than  $-2$  V and is on when the gate potential is more negative than  $-10$  V relative to the substrate. As a result, the circuit configuration used for a logic level translator depends on the voltage applied to the substrate ( $V_{SS}$ ) of the MOS device.

### MOS shift registers

Among the most popular applications of MOS circuits are shift registers. Widely used as a temporary information storage media, the typical MOS shift register presents two kinds of loads to the driving circuitry. One load is the data input, which is essentially a MOS gate load. In addition to this conventional MOS load, the typical shift register also requires one or more clock

inputs that impose stringent driving requirements. To investigate the problems of interfacing MOS shift registers with bipolar logic, consider the requirements of the MC1141, a triple,  $66$ -bit, dynamic shift register.

The logic levels of this register are not compatible with TTL, DTL, or RTL levels. The type of circuit used to translate between bipolar logic levels and MOS logic levels depends upon the voltage connected to the MOS substrate. A common method of operating the shift register is with the substrate at  $+13$  V and  $V_{DD}$  at  $0$  V. In this type of operation the clock pulse 0 level is between  $11$  and  $13$  V and a 1 is between  $-6$  and  $-14$  V. For the data input, the logic 0 is between  $11$  and  $13$  V and the logic 1 is between  $0$  and  $1$  V.

Operation of our dynamic shift register requires two

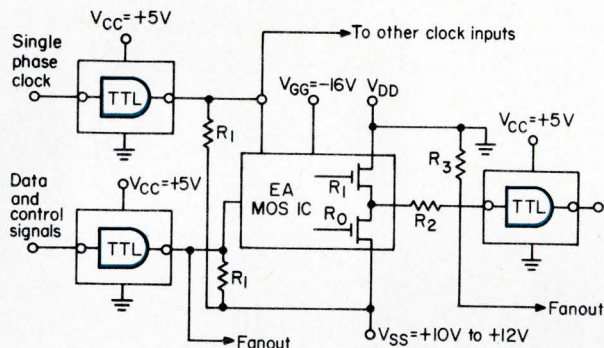
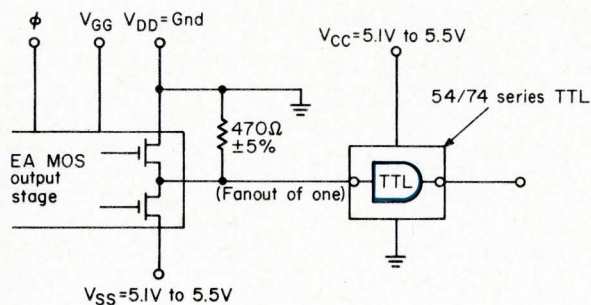

fulness for this purpose is limited to low speed applications. The standard 54/74 output driving MOS takes the form shown below.

Tests show that the voltage across  $R$  remains below 0.001 V as the +10 V is raised to approximately +18.5 V. The TTL leakage at this higher voltage increases rapidly with applied voltage but the process is non-destructive, and repeatable as the voltage is reduced. The conduction is not due to leakage through  $Q_2$  but rather, the current path is through the diode and the base of  $Q_1$ . All of the 54/74 series circuits use this circuit except the ones with open collectors (good to +28 V) and the

buffer. The buffer (5440/7440) output does not have the diode, and tests on that circuit show that a gradual leakage starts at about +10 V. The buffer is, therefore, not recommended for this application.

### MOS to TTL interface—Method 1

In this method,  $V_{SS}$  of all MOS circuits and  $V_{CC}$  of the output TTL circuits are supplied with +5 V. Driving a standard 54/74 circuit requires an effective resistance to ground of 250  $\Omega$ . Therefore, most MOS circuits need an external parallel load resistor. Generally, the nominal value of this resistor is 500  $\Omega$ . This in parallel with the worst case MOS 1 level output impedance of 500  $\Omega$  gives the required 250  $\Omega$ . If the value of this resistor is too low, the TTL 1 level noise margin is reduced. While this method has the advantages of fewer parts and lower power than Method 2, which follows, it has the disadvantage that the +5 V output signal cannot subsequently be used to drive other MOS circuits without an active level change.

### MOS to TTL interface—Method 2

With this method, outputs are compatible with inputs so that signals may flow through any combination of MOS and TTL circuits without active level shifting. The basic biasing scheme is shown below.

When certain MOS outputs drive other MOS circuits in this system,  $V_{DD}$  for those outputs may be connected to  $V_{GG}$ . Because the 1 level output impedance is nominally 2000  $\Omega$  when  $V_{DD} = -27$  V, this is not the best solution for 3 MHz operation, unless the output capacitance load is reduced. A better alternative raises  $V_{SS}$  to +12 V min. and keeps  $V_{DD}$  grounded. When operating at 3 MHz into 54/74 loads, the +12 V should be regulated as the power dissipation in multiple output circuits could become objectionable.

(Contributed by Electronic Arrays Inc., Mountain View, Calif.)

clock signals which are denoted by  $\phi_1$  and  $\phi_2$ . The rise and fall times of these clock signals must be less than 100 ns and the minimum clock pulse width is 230 ns. The clock frequency must be between 10 kHz and 1 MHz.

The clock pulse driver must be capable of producing voltage swings of about 26 V on a capacitive load in less than 100 ns. The typical capacitance of either clock line is 80 pF. So, for systems using a large number of dynamic shift registers, the capacitive load of the clock line can be quite large.

The task of translating from MOS to bipolar levels can be far simpler if the MOS substrate is at a potential that is more positive than the bipolar ground. A simple resistive divider between the output buffer of the shift

register and a negative potential can accomplish this translation. This simple network provides the nominal high and low input values required to drive TTL or DTL logic.

For applications that require not only reducing the logic swing of the MOS circuit, but also level shifting, the problem is analogous to that of bipolars driving MOS and circuits similar to those shown in Figs. 1 and 2 can be modified to provide the proper levels.

INFORMATION RETRIEVAL  
Integrated circuits, Computers and  
peripherals, digital design

Got masks, need parts?  
Send masks. Get parts. Two weeks.

**NORTEC**   
ELECTRONICS CORPORATION  
3697 TAHOE WAY, SANTA CLARA  
CALIFORNIA 95051 (408) 732-2204

INSTANT  
LSI

High or low  $V_{gst}$  same low price, same  
instant turnaround

## MOS course—Part 3

# MOS arrays in a data terminal

**MOS and data terminals—here's why one company thinks they are a winning combination.**

**By Richard Perrin**, Mgr. MOS IC Development,  
Viatron Computer Systems Corp., Bedford, Mass.

The control center of Viatron's System 21 uses MOS logic and storage elements that allow the input and output of data through a combination of channels. The system has a main memory that is capable of storing five 80-character records (where a character is the standard 8-bit ASCII code).

The three basic elements of the memory are the five storage areas, the memory control, and the memory timing. Interfacing with the memory are two other subsystems—a video display and a microprocessor. Among its functions, the microprocessor supplies data to the memory and commands the memory to perform various operations. Two independent data outputs are provided from the memory: one to the microprocessor and the other to the display. Since they are independent, neither subsystem is interrupted by the other. In this way, the display can request data transfers from the memory regardless of what the microprocessor is doing with it.

### Record storage

The storage area for each record contains 80 characters of 8 bits each. The storage is character-organized so that the entire 8 bits of each character are operated on in parallel. Hence, there are eight, 80-bit shift registers for each record of storage. These registers are dynamic and normally recirculate the data.

The outputs of a record are wire-ORed to the corresponding outputs of the other four records, requiring that the output have a disconnect buffer that goes to a high impedance when the record is not selected. The

buffer then allows the outputs of another record that has been selected to drive the line. The wire-OR connection is used because it requires five times less pins than a straight circuit-OR method.

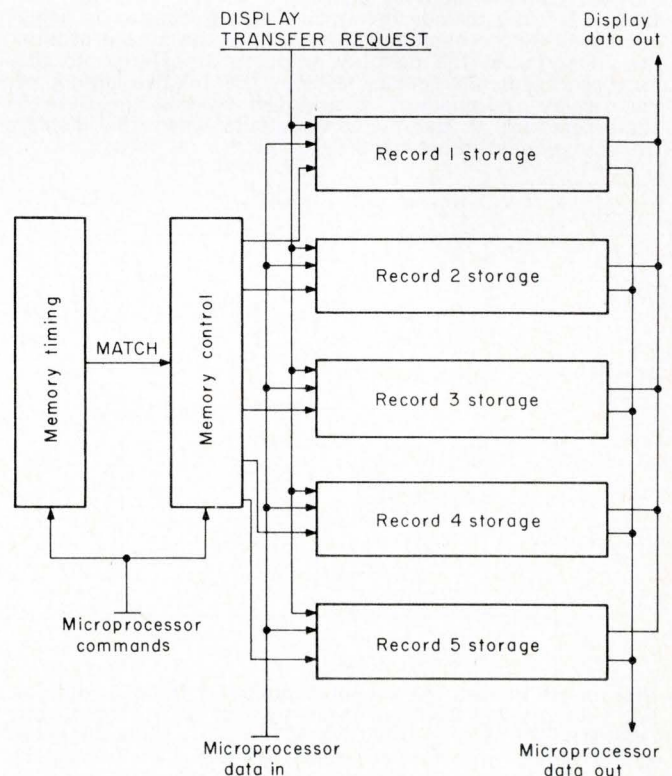

Block diagram of the memory

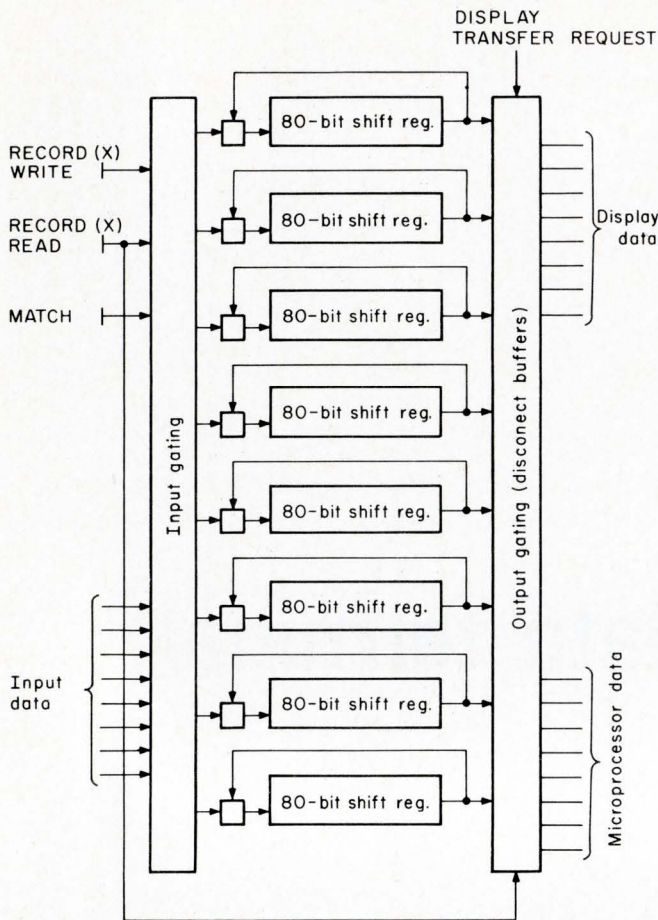

**Storage for one record.** To write in the memory, the RECORD (X) WRITE command is activated to the desired record. When the MATCH becomes active, the correct location is at the output of the shift register. At this time, the input gating breaks the recirculation path and inserts the input data character in the shift register. Only one character is written in the memory and the recirculation path is restored.

To read the memory, the OUTPUT GATING is enabled and the recirculating data is presented at the outputs. The MATCH is used to indicate which memory location is being addressed by the microprocessor and, at the time it occurs, the character at the memory output is transferred to the microprocessor. In similar fashion, the relative timing of the display and memory is arranged so that the desired characters are at the memory outputs when the display transfer request is activated.

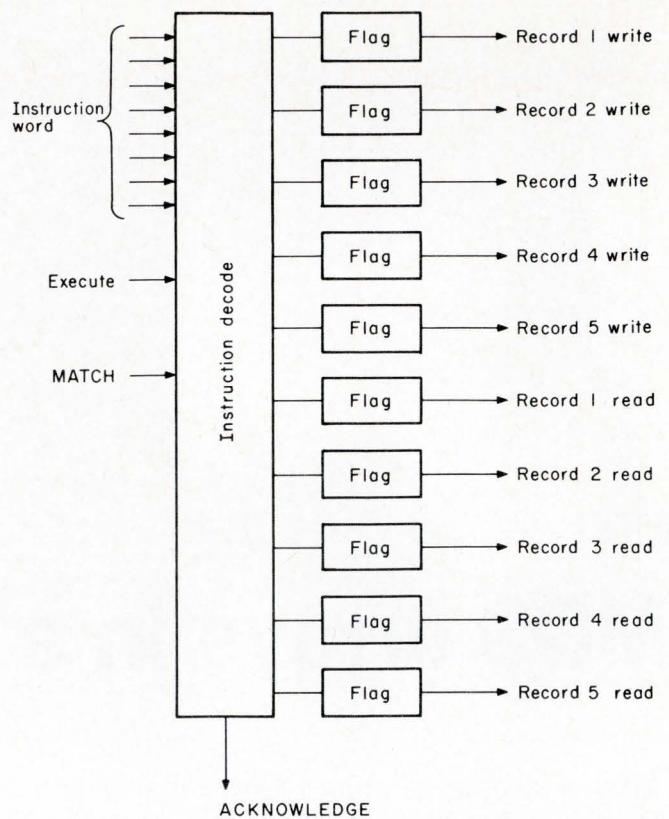

The memory control decodes the read and write commands. When a read or write is performed, the microprocessor goes into an idle state until it receives an ACKNOWLEDGE from the memory indicating the completion of the operation. The memory control generates the ACKNOWLEDGE when it receives the MATCH signal during a read or write. The memory control can also erase a record by simultaneously commanding a read and write to the selected record. It does this for two MATCH signals to guarantee that the entire record is erased and then sends an ACKNOWLEDGE to the microprocessor.

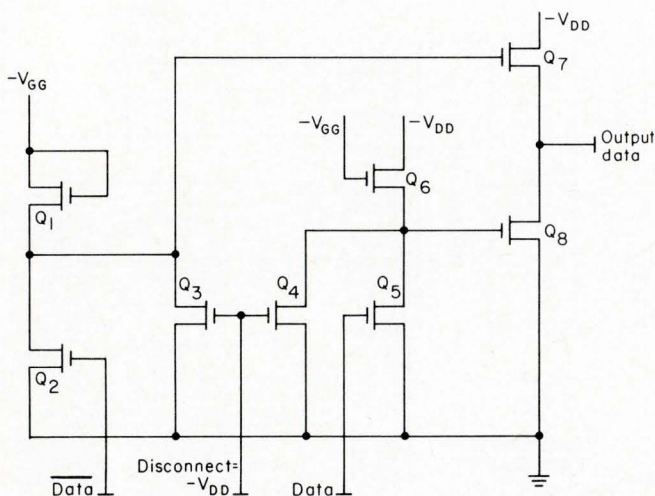

**Disconnect buffer.** The circuit contains eight MOS devices and requires the following three signals: DATA, DATA, and DISCONNECT. Setting DISCONNECT to  $-V_{DD}$  holds the gates of the output transistors at ground and forces the transistors to an off condition. To transfer data, DISCONNECT is set to ground.

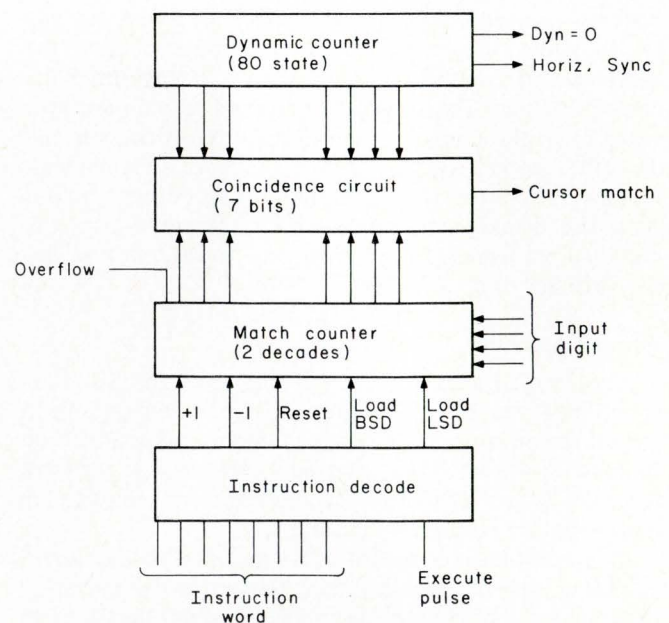

The memory timing section.

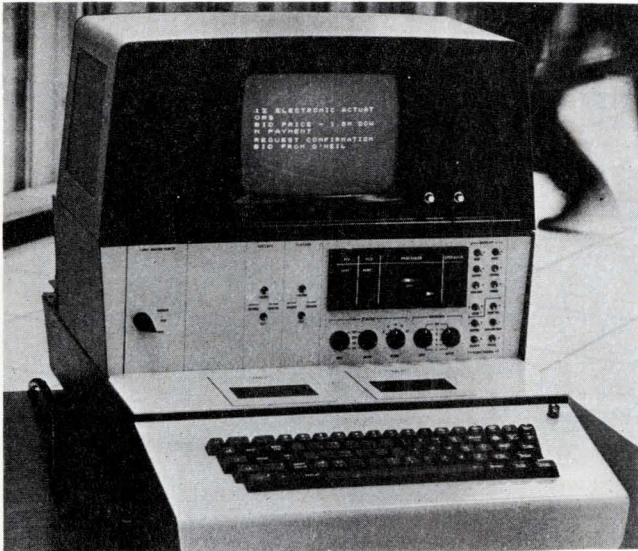

Data management terminal for Vaitron's System 21.

### Memory control and timing

The microprocessor commands the memory to perform certain basic operations. The two areas that accept the commands are the memory control and the memory timing. An 8-bit instruction word indicates the operation and the microprocessor generates an execute pulse to initiate the command. The memory control decodes the read and write commands to the desired record. A complete recirculation cycle of the memory takes approximately five execution cycles.

The memory timing contains the address location counters. The dynamic counter is an 80-state BCD device that continuously counts at the memory shift rate. When it passes through the zero state, it automatically defines address location zero. A match counter maintains the current location that is being addressed. When the contents of the match counter equal the contents of the dynamic counter, a match is generated to indicate that the output of the memory storage registers has the desired location. The microprocessor controls the location it wishes to address by operating on the match counter. The basic operations are add 1 (forward space), subtract 1 (back space), reset to all 0's (similar to carriage return) and load a particular number (as in an index). This loading is done in two steps, one to load the least significant digit and the next to load the most significant digit. The digits are BCD and the match counter counts in BCD. The counter has an overflow indication that is used to prevent the system from accepting additional characters (beyond the standard record length of 80) if the operator tries to enter them.

The memory is partitioned in two separate ways. The first, a  $2\phi$  design approach, uses the following arrays: one memory control, one memory timing, and twenty dual 80-bit storage registers. The second partitioning uses  $4\phi$  logic and reduces the number of arrays to the following: one memory storage and timing and five arrays of eight, 80-bit storage registers.

**INFORMATION RETRIEVAL**  
Computers and peripherals, Digital design,  
Integrated circuits.

# Short-run and Prototype PC Boards?

**CMMC can make them for you in as  
little as seven days...**

Starting from scratch, Chemical Micro Milling Company can produce your short-run and prototype PC boards for you with a turn around time as low as seven days. CMMC's centrally-located PC board facility is geared to create high quality short-run and prototype, high density, single and double-sided boards with plated through holes.

CMMC can etch *all* metals (not just copper!) and offers a full range of plating—copper, nickel, gold and tinnillate. Full facilities are also provided for flushing of circuitry.

Let CMMC—Chemical Micro Milling Company—bid on your next short-run or prototype PC board job. You'll save time. You'll save money. Call CMMC collect for full details.



# IMOS:

**[THE INDUSTRY'S FIRST ION-IMPLANTED MOS DEVICES]**

Because our MOS integrated circuits are ion-implanted, they can handle 20 MHz data. And they're pin compatible with P-channel MOS.

Ion-implantation gives them ultimate automatic gate registration without process complications.

Example: our HDSR2164

dual 64-bit TTL compatible shift register. It's loaded with Tomorrow features. Like greater than 10 MHz operation. Low clock capacitance (typically, 25pf) and low power dissipation (typically 0.1 mW per bit per MHz at operating frequencies over 10 MHz). And it's priced at \$24.95 per unit in quantities over 100 pieces.

For literature, data sheets, and name of nearest distributor, please write: Hughes MOS Division, 500 Superior Avenue, Newport Beach, CA 92663.

**HUGHES**

HUGHES AIRCRAFT COMPANY  
MOS DIVISION

## HUGHES STANDARD MOSINC DEVICES

### COUNTERS

HCTR0107: Reversible Decade Counter with Seven-Segment Decoder and Drivers @ \$12.50  
HCTR0507: Seven Stage Binary Counter, 7 Outputs, @ \$7.00  
HCTR0201: RST Flip-Flop @ \$1.65  
HCTR0102: Commercial/Entertainment Binary Divider @ \$0.80

### STATIC SHIFT REGISTERS

HSSR2016: Dual-16 Bit @ \$5.95  
HSSR2064: Dual-64 Bit @ \$16.00

### DYNAMIC SHIFT REGISTERS

HDSR3066: Triple-66 Bit @ \$17.50  
HDSR4064: Quad-64 Bit @ \$23.50

### ION-IMPLANTED MOS (IMOS) SHIFT REGISTERS

HDSR2164: 10 MHz/ Dual-64 Bit Dynamic Shift Register @ \$24.95  
LISR0064: 20 MHz/ 64 Bit Dynamic Shift Register @ \$35.00 (1 up)

### MULTIPLEXERS

HMUX1756: 4 Bit D-to-A Converter @ \$39.80  
HMUX1784: 4 Bit D-to-A Converter @ \$39.80  
HMUX2542: Dual 2-Bit Commutator @ \$29.95  
HMUX2641: 4-Bit Commutator @ \$29.95

### LOGIC ELEMENTS

HLOG2304: Triple 3, Dual 2 NOR Gates @ \$4.00  
HLOG2306: Dual J-K Flip-Flop @ \$4.00

### MULTIPLES

HMUL1444: General Purpose Quad @ \$10.25  
HMUL1445: General Purpose Quad @ \$14.75  
HMUL1884: Quad Dual-Switch @ \$16.25  
HMUL2661: Six-Channel Switch @ \$15.75

### DUALS

HDSW8550: High Level Switch @ \$5.60  
HDIG8551: Amplifier @ \$7.45

### DISCRETES

HDGP1000: General Purpose Switch @ \$0.70  
HDGP1001: General Purpose 30-ohm Switch @ \$0.80  
HDIG1030: General Purpose @ \$3.10  
HDIG1886: Electrometer @ \$3.55  
HDSW2106: Low-Resistance, 20-ohm Switch @ \$4.40  
HDSW3005: General Purpose Low-Leakage Switch @ \$3.30  
HDSW8318: General Purpose Switch @ \$2.75  
HDSW8348: General Purpose 50-ohm Switch @ \$4.10

### SUBSYSTEMS

HSUB0525: TV Sync Circuit @ \$15.00  
HSUB5021: Differential Digital Analyzer @ \$18.00

### COMPLEMENTARY MOS

LCOS4007: Dual Complementary Pair plus Inverter @ \$20.00 (1 up)

Note: All prices for 100 and over quantities except as noted.

### SAMPLE KITS

#1 Electrometers @ \$9.75 each  
#2 Switches @ \$21.90 each  
#3 Multiplexers @ \$149.75 each  
#4 Counters @ \$33.56 each



## MOS course—Part 3

# MOS shift registers in arithmetic operations

Here's how the new generation of desk calculators uses MOS.

**By Jack Irwin,** Application Manager  
National Semiconductor Corp., Santa Clara, Calif.

Although this article emphasizes desk calculators, the basic techniques can be applied to other equipment such as accounting machines, data terminals, billing equipment, and some types of test instruments. All of these applications have a characteristically slow operating speed due to an interface with an operator or some mechanical device.

The adder and the memory are the two major areas of a desk calculator that are most affected by the slower speed. For example, the adder in a computer must be a high speed, multiple bit, parallel adder; compare this to the calculator, which at worst case operates on a digit (4 bits) with correction.

The memory for the typical computer relies on random access of at least several thousand words. On the other hand, the calculator uses relatively few words of sequential access storage. While the basic data flow may vary between different types of calculators (and related systems), the sequential flow is typical and is based on economics.

The functions that a calculator performs on its data fall into the three general categories: data modification, movement, and comparison.

Data modification includes producing the sum or difference of two variables, incrementing or decrementing, and clearing (or setting to zero). One part of finding the sum or difference is detecting when a carry is gen-

erated and then correcting those digits affected by the carry. The data movement operations are left and right shifts, insertion of new data, register to register transfers, and output to some device(s).

### The storage device and its effects

With the exception of a few machines that used core storage, most of the early desk calculators used delay line storage. Characteristically, while a delay line is economical in terms of cost/bit, its ability to extract the data is very limited and expensive.

Because of this, machines using delay lines for storage tend to use both a bit- and digit-serial structure for the data. In many cases the data would be interlaced on a bit or digit basis. This forced the system designed to store the bit or digit of one argument until the other was present. During arithmetic operations, two options were possible: to correct the digit and not deposit it in the register until the next cycle, or to go back through the data, correcting any digits that required correction.

With the first use of MOS registers, the penalty for more access to the data was drastically reduced. Since the introduction of bipolar compatible MOS devices, the configuration of the register area and the adder/subtractor circuit has been optimized to take advantage of this easy access.

This freedom of access may lead in two directions. First, the data could be stored digit-serial, bit-parallel. (In order to compare this with other configurations, we

A digit-serial, bit-parallel configuration of 3 arguments, each of which is 16 digits. This approach offers high-speed operation, but with the cost of increased hardware.

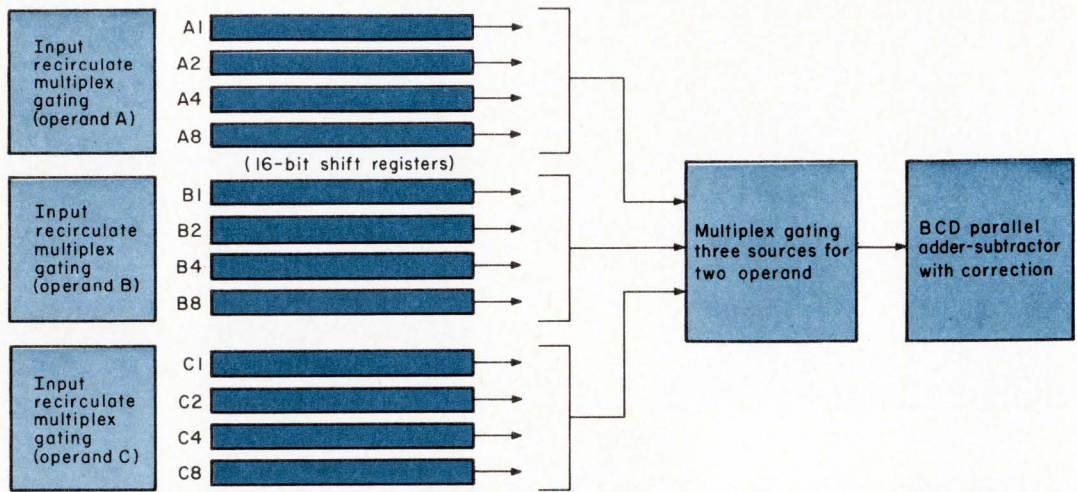

shall use an example of three arguments of 16 digits each.) Because the bits are in parallel, this approach has the advantage of relatively high speed operation. For the 16-digit example, it requires only 16 clock pulses (cycles) to complete an operation.

In this parallel configuration the adder/subtractor must be fast enough to find the proper sum and correct it if necessary. With the data flow gating and complementing circuit, this amounts to four or five levels of logic. At nominal MOS operating speeds, TTL devices such as the DM8000 series gate easily to meet this requirement. Use of more complex devices such as the DM8283 adder could reduce the number of packages.

Performing the addition in parallel has the advantage of making all data immediately available for the correction. With the corrected value available, the proper result may be placed back in the register within one bit time.

The significant disadvantage of the bit parallel ap-

proach is that it requires more hardware in all areas. For example, the parallel adder is much more expensive to implement than the serial version.

The other method of using the data access of MOS registers is to use the bit-serial, digit-serial configuration. This configuration has the advantage of fewer data control nodes than the parallel structure. It can also use the more efficient (cost/bit) 64 or dual 64-bit registers.

The adder/subtractor is affected most by this change in configuration. Significantly it requires only two full adders as opposed to seven in the parallel configuration. Other considerations aside, the reduction in the number of full adders is the major benefit, because of the cost factor.

A factor in the design of a bit serial BCD (or Excess 3) adder is that at no time is the complete number simultaneously available to test for correction. The only recourse is to either store the need for carry/correction information, or, more commonly, to store the result in

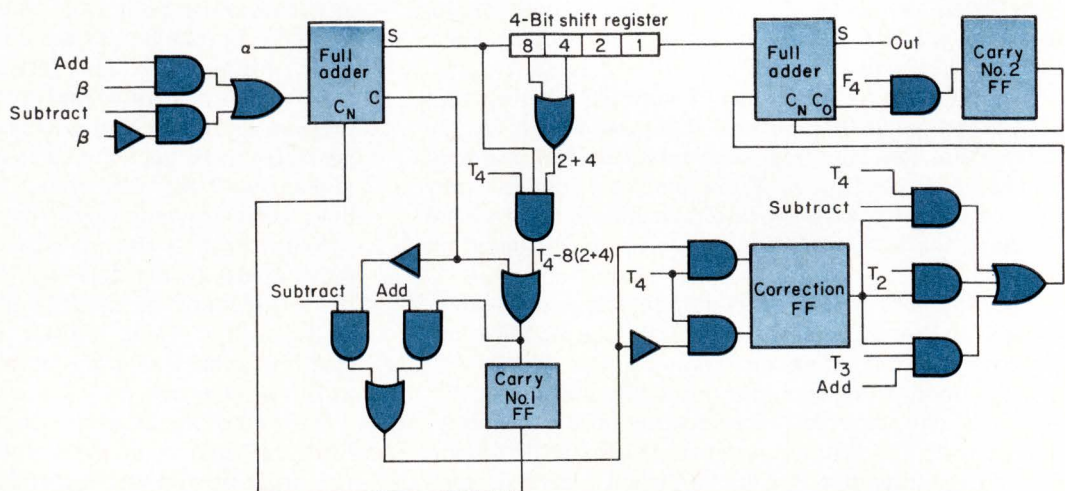

A bit-serial adder/subtractor. This circuit requires only two full adders. Conversely, the adder/subtractor for a bit-parallel configuration uses seven full adders.

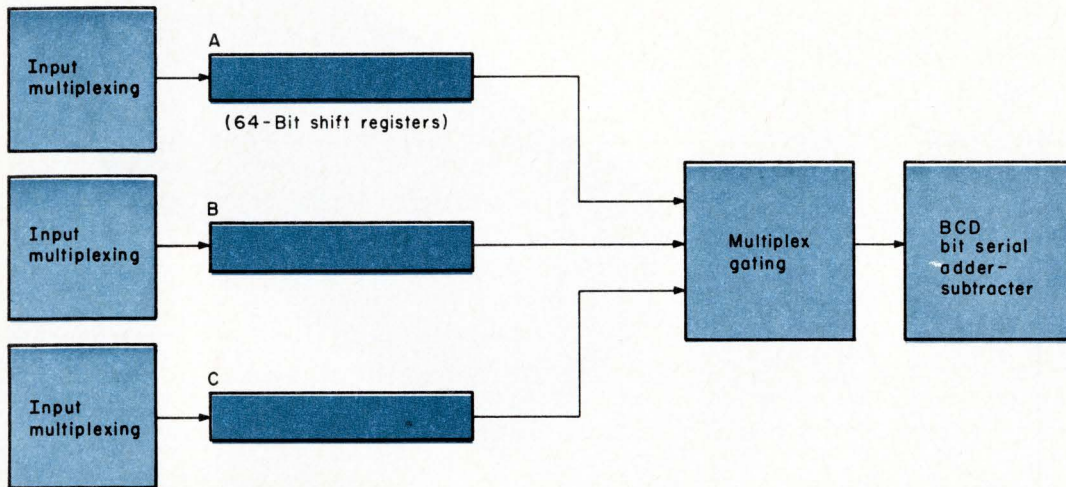

The bit-serial, digit-serial arrangement reduces hardware count.

a 4-bit shift register. This temporary storage serves two purposes: the result may be examined during the fourth bit time of a digit to ascertain the need for correction/carry; and the result during the next digit time is corrected by adding or subtracting six under the control of the correction flip-flop.

The temporary storage of the data has an important side effect. The temporary storage is a 4-bit (1 digit) delay. Hence the result is delayed or shifted with respect to the original arguments.

One of the easier methods of realigning the data is to provide the additional clock pulses to the register after the sum or difference has been generated. Since the shift is relative to the data in the other registers, we must provide clock pulses to the result register but not to the others in the system. Unfortunately, a system using separate clock drives to various registers is not as economical as one with a common clock drive because of the cost of the additional clock drivers.

There are two ways of avoiding the use of the multiple clock drive. One method of realigning the result register to the remainder of the system is to shift all of the other registers through the same or a similar delay. Then the complete system is realigned.

The other method of using common clocks and performing the delayed correction shortens the path length of the addition cycle. You can do this by either inserting the data into the register 4 bits late or extracting the data from the operand register 4 bits early. Data flow is selected from the proper registers and gated into the serial adder. Four bits later the corrected result is ready to be inserted into the result register at its properly aligned position.

**INFORMATION RETRIEVAL**  
Integrated circuits, Digital  
design, Computers & peripherals

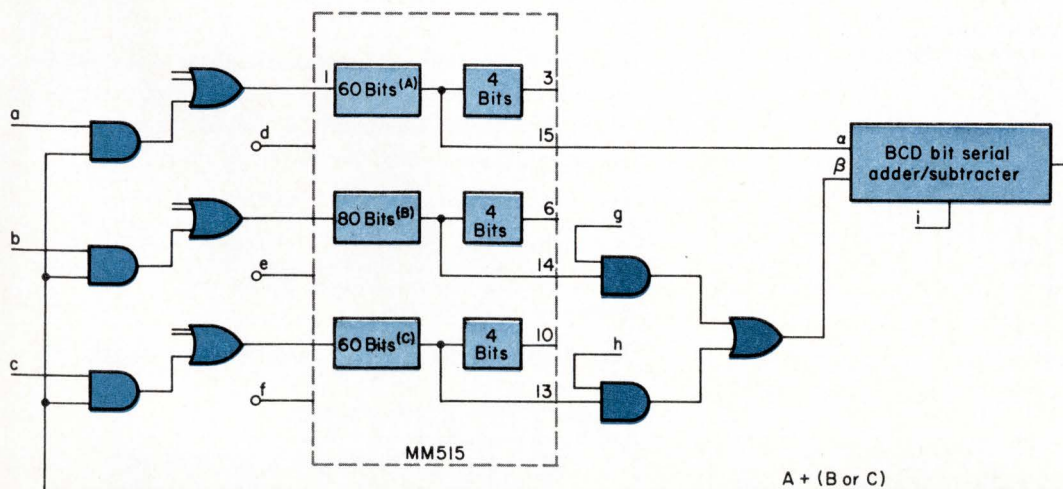

**BCD arithmetic functions** using a register with an early extraction tap. Such a register is designed to realign data using a common clock system. In this example some of the data flow gating for the adder and the input to the registers has been shown.

# SOLVE YOUR D/A

## INTERFACE PROBLEMS

NEW PHILBRICK NEXUS MODEL 4850 PROVIDES THE VERSATILITY TO SOLVE YOUR CONVERTER INTERFACING PROBLEMS.

**Three Mode Integrator** Model 4850 is a multi-purpose module with reset, integrate, and hold operation modes that may be controlled by external digital signals applied to two internal mode command comparators. The input command levels to these comparators is directly compatible to DTL and TTL logic levels. Provisions have been made for elevating the reference input above common or interchanging inputs for inversed logic commands. The comparators control FET electronic switches that provide excellent "feedthrough" characteristics and eliminate the need for cumbersome relays in your system. Combined with excellent stability, the Model 4850 has the versatile performance necessary to solve those converter interfacing problems.

#### Electrical Specifications

Low Hold Decay Rate	— 30 $\mu$ V/S with $C_f = 1\mu$ F
Wide Feedback Capacitor Range	— 0.001 $\mu$ F to 10 $\mu$ F
Command Logic Input Step Level	— $\pm 0.35$ V to $\pm 5$ V
Low Switching Jump	— $\pm 20\mu$ V with $C_f = 1\mu$ F
Low Feedthrough Voltage	— $\pm 40\mu$ V
Low Aperture Time	— 800ns
Temperature Coefficient	— 20 $\mu$ V/ $^{\circ}$ C
Overload Recovery Time	— 35 $\mu$ s

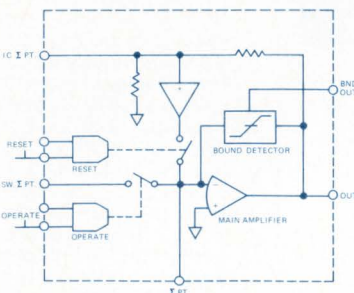

Contact us for a copy of Model 4850 Applications Guide.

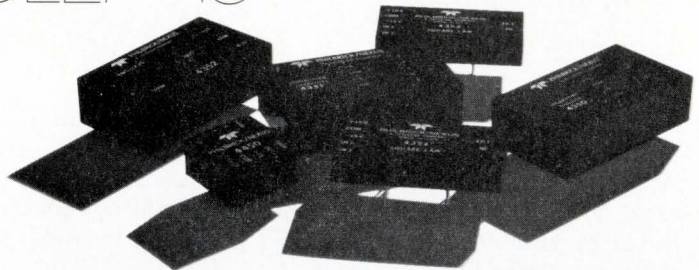
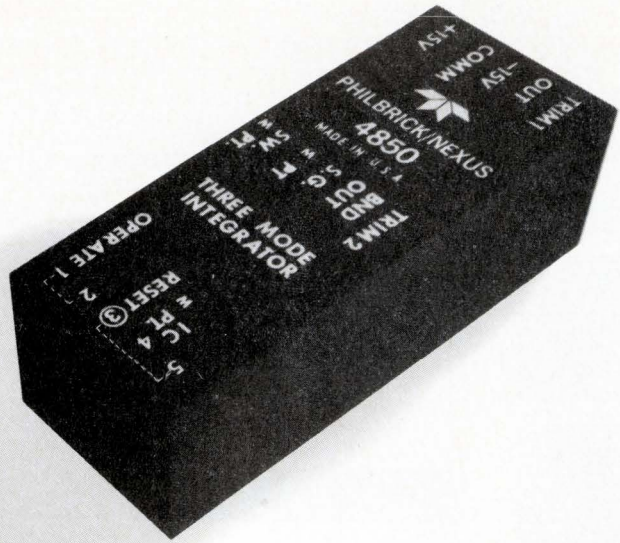

For other specialized applications try these Philbrick Nexus non-linear function modules.

**Square Law Elements** Models 4353 and 4354 are temperature-compensated, straight-line approximation, ten-section diode function fitters with break points adjusted to fit a square law relationship.

**Temperature Compensated Logarithmic Operators** Models 4350 and 4351 are complete modules providing an output voltage proportional to the log or antilog of the input signal, without a requirement for external amplifiers or components.

**Average-RMS-Vector Operator** Model 4352 is a small, encapsulated unit designed to find the average value of an input signal, Y; find the RMS value of an input signal, X; or perform the operation  $\sqrt{X^2 + Y^2}$  on the input signals X and Y.

**Multiplier-Continuous Function Operator** Model 4450 is a true four-quadrant multiplier whose output represents the instantaneous product of the two input signals, with no limitations as to the polarity of the input signals.

For further information on any of these Philbrick Nexus products, call your local Philbrick Nexus field representative, or write today for your free copy of the new 1970 Philbrick Nexus Catalog, Teledyne Philbrick Nexus, 67 Allied Drive at Route 128, Dedham, Massachusetts 02026, U.S.A. Telephone (617) 329-1600

**No. 1 should do more . . . you expect us to.**

**TELEDYNE  
PHILBRICK NEXUS**

# Modern techniques of analog multiplication

**Multiplier differences in construction and performance mean a wider choice for you.**

By Tom Cate, Burr-Brown Research Corp., Tucson, Arizona.

As performance improves and prices tumble, analog multiplier modules grow more popular. Reduced costs have been obtained through new design approaches and low-cost IC op amps. However, each new design technique has its benefits and limitations, making choice of the right multiplier for your application more difficult than ever. The behavior of different multipliers having the same accuracy specification may vary in a particular circuit. The user will find a knowledge of the principles behind multiplier design helpful in choosing the best one for his application.

Because it is impossible to consider all multiplier design techniques in one article, our discussion will be limited to commercially available, modular, low-cost amplifiers.

## "Quarter-square" method with diode-shaping nets

The quarter-square technique has been used for many years, particularly in general-purpose analog computers. Although partially displaced by new designs, it still offers advantages where accuracies of  $\pm 0.5\%$  or better are needed with signal frequencies in the range of dc to 100 kHz. The advent of high-performance, low-cost IC op amps has renewed interest in the technique but, requiring more components, it remains inherently more expensive than some of the newer techniques.

Quarter-square multiplication is based on the algebraic identity

$$XY = \frac{1}{4} [(X + Y)^2 - (X - Y)^2]$$

One-quarter of the difference of the two squares equals the product  $XY$ ; hence the name, "quarter-square" multiplier. As a rule, the quarter-square multiplier ac-

cepts a range of  $\pm 10$  V on the  $X$  and  $Y$  inputs and has an output range of  $\pm 10$  V. To simplify their task, engineers normally design a circuit that takes absolute values of the  $(X+Y)/2$  and  $(X-Y)/2$  terms before squaring, so the actual equation is

$$E_o = \frac{XY}{10} = \frac{1}{10} \left[ \left| \frac{X+Y}{2} \right|^2 - \left| \frac{X-Y}{2} \right|^2 \right]$$

Generally, the error pattern will be "lumpy" as shown in fig. 2. In general-purpose analog computing, this lumpiness is usually not important. However, it is significant in communications or telemetry applications where multipliers often function as modulators. The error pattern of quarter-square multipliers tends to generate more high-frequency harmonic error than other types, so if inter-modulation distortion, ac null suppression, or harmonic distortion are critical, the effects of inherent lumpiness or incremental nonlinearity of the errors should be considered.

A possible advantage of the quarter-square technique is good frequency response, only depending upon the squaring network stray capacitance and the operational amplifier frequency response. Diode breakpoint drift may be partially compensated for by deliberately making the breakpoint reference voltage drift in the opposite direction. Varying interconnections between the internal operational amplifiers and the squaring modules of a quarter-square device provide other operations such as division, square-root, etc.

## "Variable-transductance" method using transistors

The term "variable-transductance" is applied to multipliers that vary the transductance of a transistor by

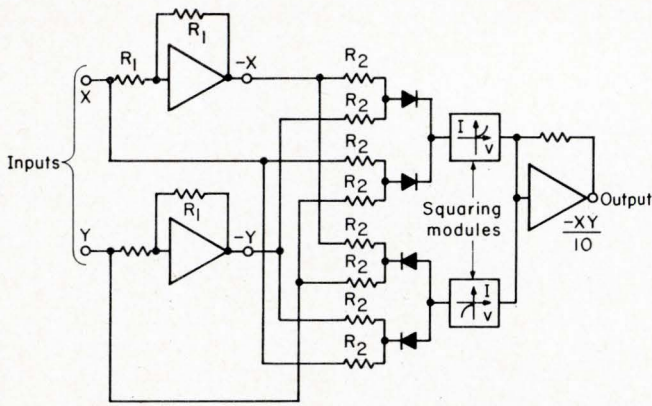

**Fig. 1. Quarter-square multiplier.** Three operational amplifiers and two one-quadrant squaring circuits will perform complete four-quadrant multiplication if connected as shown. Two of the op amps do the summing and the diodes perform the absolute value operation. The squaring modules consist of diode-shaping networks that contain a number of biased diodes. Each multiplier contains two squaring circuits—one for + and one for - input voltages.

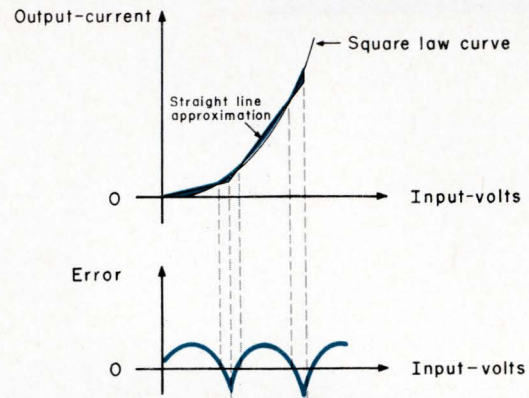

**Fig. 2. The output of the squaring networks** in fig. 1 is a current that forms a straight-line approximation to the square of the input voltage. Since diodes do not have sharp breakpoints, the approximation can be better than straight-line. Even so, about ten diode breakpoints are needed for  $\pm 0.25\%$  accuracy and fifteen for  $\pm 0.1\%$  accuracy.

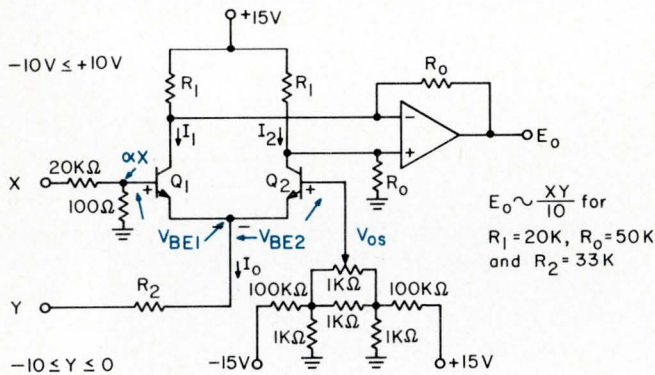

**Fig. 3. Basic variable-transconductance multiplier.** If we make the simplifying assumption that the transistor current gains are infinite, then the base currents will be zero. The collector current and emitter-base current will be equal, and the voltage across the base-to-emitter junction will be related to the collector current by the equation

$$I_C = I_S e^{\frac{q V_{BE}}{KT}}$$

where  $I_C$  is the collector current and  $V_{BE}$  is the base-to-emitter voltage. Differentiating this equation, we find that the transconductance of  $Q1$  and  $Q2$  in fig. 3 is

$$\frac{\Delta I_1}{\Delta V_{BE1}} = \frac{q}{KT} I_1 \text{ and } \frac{\Delta I_2}{\Delta V_{BE2}} = \frac{q}{KT} I_2.$$

modulating the emitter current. This technique is becoming more widespread, and is used in most new modular amplifiers costing less than \$100. The term "variable-transconductance" has been broadly applied to different multipliers of widely varying capabilities, causing confusion about what constitutes a "variable-transconductance" multiplier.

The following discussion is not rigorous, but should provide an understanding of the principles behind this type of multiplier. These types all depend upon the forward-biased semiconductor junction-diode expression

$$I_F = I_S e^{\frac{q V_F}{m KT}}, \text{ or } V_F = \frac{m KT}{q} \log \frac{I_F}{I_S}$$

where:

- $I_F$  = forward conduction current
- $I_S$  = reverse saturation current
- $V_F$  = voltage across the junction
- $q$  = charge on the electron
- $m$  = constant
- $T$  = absolute temperature

Also,  $I_o = I_1 + I_2$ .  $Kt/q$  is approximately 26-mV for silicon transistors at room temperature. If the transistors are matched, then  $I_1 \approx I_2$  and  $V_{BE1} \approx V_{BE2}$  with the input at  $X = 0$ . As the  $X$  input varies, the  $V_{BE}$ 's vary incrementally such that the incremental current variations are

$$\Delta I_1 = \frac{q}{KT} \frac{I_o}{2} \Delta V_{BE1} \text{ and } \Delta I_2 = \frac{q}{KT} \frac{I_o}{2} \Delta V_{BE2}$$

$$\Delta I_1 - \Delta I_2 = \frac{q}{2 KT} I_o (\Delta V_{BE1} - \Delta V_{BE2})$$

If  $X$  is divided down to the millivolt range by factor  $\alpha$ , and the offset voltage  $V_{os}$  is adjusted for zero differential output with  $X = 0$ , then  $\alpha X = \Delta V_{BE1} - \Delta V_{BE2}$ , so

$$\Delta I_1 - \Delta I_2 = \frac{q}{2 KT} I_o \alpha X.$$

If  $R_2$  is large, then the  $Y$  input will be essentially a current source and  $I_o \approx -\beta Y$ , where  $\beta$  is a scaling constant. The differential output current is converted to a single-ended output voltage by the op amp. The feedback resistors  $R_o$  set the output gain such that

$$E_o = -R_o (\Delta I_1 - \Delta I_2).$$

Combining equations, the output is

$$E_o = \frac{R_o q \beta \alpha}{2 KT} XY, \text{ where } -10 \leq X \leq +10 \text{ and } -10 \leq Y \leq 0.$$

The gains are usually adjusted by varying  $R_o$ ,  $\beta$ , and  $\alpha$ , such that  $R_o q \beta / 2 KT$  is one-tenth at 25°C. This will make the output  $XY/10$ .

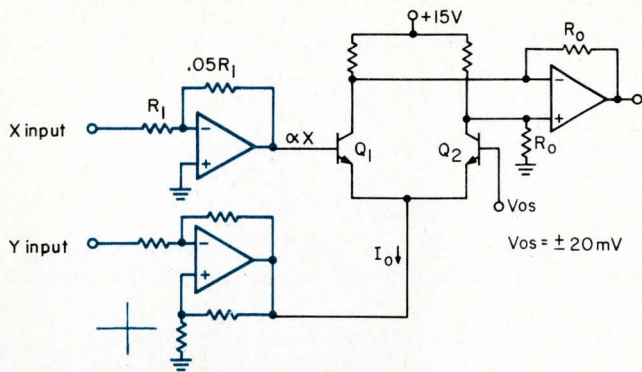

**Fig. 4. An improved version variable-transconductance multiplier.** The easiest way to improve the basic method is to add op amps to both inputs. The  $X$ -input op amp is connected for precise attenuation of the input signal and to provide high input impedance and a low driving impedance to the base of  $Q1$ . The  $Y$ -input op amp is connected as a precise current source. The improved circuit is still very temperature-dependent.

This equation is not theoretically exact; more importantly, the magnitudes of  $mK/q$  and  $I_s$  vary from unit to unit in commercially available semiconductors. Two of the many ways to exploit the semiconductor junction equation will be discussed in detail. A simple variable-transconductance multiplier is shown in fig. 3. This basic configuration is suitable for modulator applications requiring accuracies of 3 to 10%. Several limitations prevent the basic circuit from being used as a general-purpose multiplier:

a. Because the  $Y$ -input must be negative, extra circuitry must be added to obtain four-quadrant operation.

b. The emitter resistor  $R_2$  must be small enough to put the transistor into a favorable operation region, yet large enough to make the  $Y$ -input a true current source. Adding a transistor or op amp voltage-to-current conversion circuit on the  $Y$ -input will improve the performance.

c. The  $X$ -input may vary  $\pm 10$  V, but the transconductance relationship is only valid over a range of about  $\pm 20$  mV at the base of  $Q1$ . The  $X$ -input must be divided down considerably, so the circuit is very sensitive to offset variations.

d. The output is very temperature-dependent. Even with matched transistors, there is a  $1/T$  term in the denominator of the gain equation. The temperature-dependence of the offset is even more important. For best linearity, the  $X$ -input should be divided down as much as possible ( $\alpha$  must be small). But then the gain must be larger to obtain the same output ( $R_0$  must be large). Increasing  $R_0$  makes the circuit more sensitive to  $V_{BE}$  mismatch and to temperature gradients. A few millivolts between the transistors can cause volts of change at the output.

e. The assumptions of infinite transistor gain, exponential voltage/current relationship, perfectly matched transistors, and an ideal op amp are only approximations. Even with a constant temperature and a good op amp, it still remains difficult to obtain  $\pm 2\%$  accuracy. Although the basic variable-transconductance technique is adequate for simple modulation needs where

## Choosing the right multiplier

These techniques of multiplying are radically different; each has its own advantages and disadvantages. Once the principles are understood, the designer can take advantage of the strengths, avoid the limitations, and choose the best type of multiplier for his use. Let's look at some typical applications:

a. **Modulator for cathode-ray-tube display.** Speed and linearity are the most important factors in this type of circuit. Lumpiness (or ripple) of a quarter-square multiplier output would cause the CRT spot to "wobble." An averaging-type multiplier would be too slow, so some sort of variable-transconductance multiplier should be used.

b. **High-speed analog computer.** Accuracy and speed are usually required, so a fast quarter-square unit will probably be the best choice.

c. **Average power computer in instrumentation system.** If both inputs are very low frequency and the multiplier output is being read on a meter or chart recorder, an averaging-type multiplier should be best. Accuracy and cost are commonly the most important factors in instrumentation applications.

d. **Gain-control in autopilot system.** Large aircraft are basically low-pass filters themselves, so an averaging-type multiplier would be best. However, if the gain-control must control the stability of a system with rapid response, then a variable-transconductance type is more appropriate.

e. **Amplitude-modulator of carrier signal.** Suppressed-carrier modulation requires good ac null suppression and good frequency response. Good linearity and low distortion over a wide dynamic range are also important. A variable-transconductance type should be the best unit for this application.

offset isn't critical, it must be refined to make a general-purpose multiplier.

## Advanced variable-transconductance multiplier

The inherent limitations of the basic variable-transconductance method may be eased by devising a current-controlled, temperature-compensated version\* (fig. 5). This approach improves performance, but still depends upon the semiconductor-junction equation. It provides true four-quadrant multiplication with no inherent temperature drift. Since current ratio modulation performs the multiplication, these multipliers can be designed for high-frequency operation.

Although superior to the basic technique, this method is more complex. First, the voltage inputs must be converted to differential-output current sources. Then the signals are processed by three transistor pairs that must be matched and must also follow the desired semiconductor junction equation. The emitter bulk resistance is a particularly large source of error. This can be minimized by adding extra components. In addition, the bias voltage and bias current sources must be carefully designed. In particular, the bias currents  $I_B$  and  $I_E$  must be well regulated.

\*This basic approach was first published by Barrie Gilbert of Tektronix in the December, 1968 issue of the IEEE "Journal of Solid State Circuits."

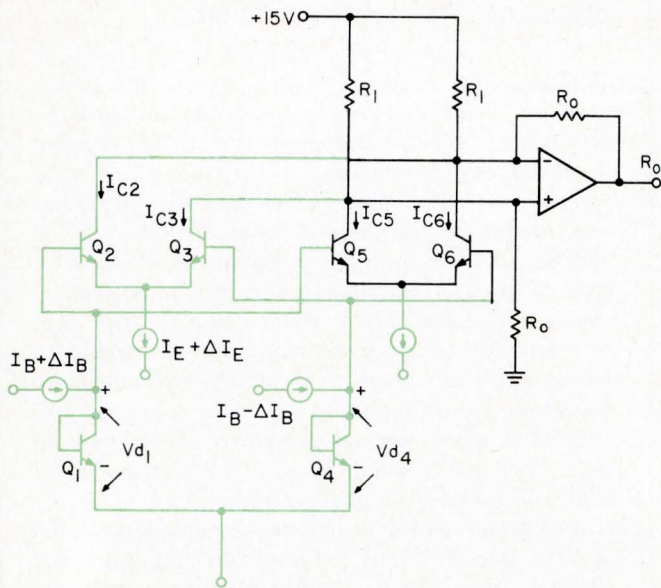

**Fig. 5. Advanced variable-transconductance multiplier.** (Circuit changes are on the colored portion of the diagram.) To simplify the analysis, assume that the input voltages  $X$  and  $Y$  have been converted to currents such that

$$\Delta I_B = K_B \frac{X}{2} \text{ and } \Delta I_E = K_E \frac{Y}{2}.$$

Also, assume that all transistor gains are infinite, all transistors are matched, and that the semiconductor junction equation is

$$V_{BE} = \frac{mKT}{q} \log \frac{I_C}{I_S}.$$

$Q1$  and  $Q4$  are connected in a diode configuration, making the collector currents  $I_B + \Delta I_B$  and  $I_B - \Delta I_B$ , respectively. Writing the emitter-voltage loop equation around  $Q1$ ,  $Q2$ ,  $Q3$  and  $Q4$ ;

$$\begin{aligned} V_{d1} - V_{BE2} + V_{BE3} - V_{d4} &= 0 \\ \frac{mKT}{q} \log \left( \frac{I_B + \Delta I_B}{I_S} \right) - \frac{mKT}{q} \log \frac{I_{C2}}{I_S} \\ + \frac{mKT}{q} \log \frac{I_{C3}}{I_S} - \frac{mKT}{q} \log \left( \frac{I_B - \Delta I_B}{I_S} \right) &= 0 \\ \log \left( \frac{I_B + \Delta I_B}{I_B - \Delta I_B} \right) &= \log \frac{I_{C2}}{I_{C3}}. \end{aligned}$$

Use of unmatched transistors and a straightforward application of the basic principles can produce accuracies of  $\pm 10$  to  $\pm 5\%$ . Very careful transistor matching and compensation of the more significant error sources can achieve accuracies of better than  $\pm 0.5\%$ .

Since matching is important, monolithic integrated circuit techniques are often used to produce the essential elements. Presently, accuracies in the range of 0.5 to 2% with economical yields are difficult to achieve. As this type of multiplier grows more popular, the accuracy may further improve through additional error-compensating circuitry or new design techniques.

### Averaging methods

"Triangle-averaging" and "pulse-height/width" multipliers all have oscillators that create high-frequency

This indicates a current ratio relationship of

$$\frac{I_B + \Delta I_B}{I_B - \Delta I_B} = \frac{I_{C2}}{I_{C3}}.$$

Similarly for the  $Q1$ ,  $Q5$ ,  $Q6$ , and  $Q4$  loop:

$$\frac{I_B + \Delta I_B}{I_B - \Delta I_B} = \frac{I_{C5}}{I_{C6}}.$$

Since the base current is negligible, the sum of the collector currents for each pair will be the total emitter current for each pair.

$$I_{C2} + I_{C3} = I_E + \Delta I_E \text{ and } I_{C5} + I_{C6} = I_E - \Delta I_E.$$

As with the basic variable-transconductance multiplier, an operational amplifier is used to convert the differential output current into a single-ended output voltage. The differential output current is given by

$$\Delta I_o = I_{C3} + I_{C5} - I_{C6} - I_{C2}.$$

The output voltage  $E_o$  is  $-R_o \Delta I_o$ . To obtain the output in terms of the inputs  $\Delta I_B$  and  $\Delta I_E$ , first put the collector currents  $I_{C3}$ ,  $I_{C5}$ ,  $I_{C6}$ , and  $I_{C2}$  in terms of the inputs:

$$\begin{aligned} I_{C3} &= \left( \frac{I_B - \Delta I_B}{2 I_B} \right) (I_E + \Delta I_E) \\ I_{C5} &= \left( \frac{I_B + \Delta I_B}{2 I_B} \right) (I_E - \Delta I_E) \\ I_{C6} &= \left( \frac{I_B - \Delta I_B}{2 I_B} \right) (I_E - \Delta I_E) \\ I_{C2} &= \left( \frac{I_B + \Delta I_B}{2 I_B} \right) (I_E + \Delta I_E). \end{aligned}$$

Substituting these results into the expression for  $\Delta I_o$  results in

$$\Delta I_o = \frac{2 \Delta I_B \Delta I_E}{I_B}.$$

Since  $E_o$  is  $R_o \Delta I_o$ , the output voltage will be

$$E_o = \frac{2 R_o}{I_B} \Delta I_B \Delta I_E.$$

The incremental current,  $\Delta I_B$ , is proportional to the  $X$ -input ( $\Delta I_B = K_B X/2$ ) and  $\Delta I_E$  is proportional to the  $Y$ -input ( $\Delta I_E = K_E Y/2$ ), so

$$E_o = \frac{R_o K_B K_E}{2 I_B} XY.$$

The constants  $R_o$ ,  $K_A$ ,  $K_E$ , and  $I_B$  are normally chosen such that

$$E_o = \frac{XY}{10}.$$

waveforms. The oscillator output is modulated in amplitude by one input, and along the time-axis by the other input.

The average value of the area under the curve thus produced is designed to be proportional to the desired product. Low-pass filtering at the output integrates the modulated wavetrain and extracts the desired average dc value. The oscillator must have a frequency several decades above the highest frequency component of  $X$  and  $Y$ . Multipliers that use the averaging principle are relatively slow, but accuracies from  $\pm 0.1$  to  $\pm 0.5\%$  can be obtained from a wide variety of models commercially available at moderate prices. Two of these are discussed in figs. 6 and 7.

Used mainly in instrumentation circuitry in which two low-frequency signals are to be multiplied, averaging-type multipliers combine good accuracy with low cost.



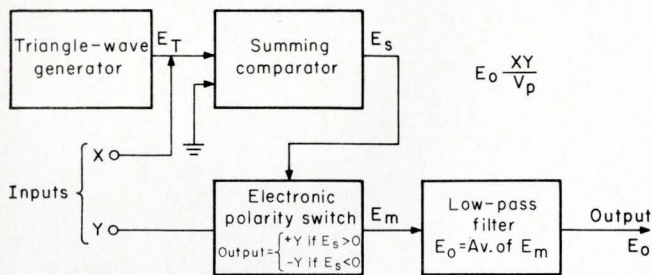
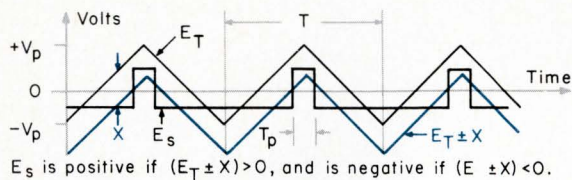

**Fig. 6. Block diagram of a typical pulse-height/width multiplier.** The pulse width,  $T_p$ , is proportional to the input  $X$  according to

$$T_p = \frac{T}{2} + \frac{X}{2V_p} T.$$

where  $T$  is the period of the triangle wave, and  $V_p$  is its amplitude out of the triangle generator.  $X$  and  $E_T$  are

summed and compared to zero. As  $X$  varies from  $-V_p$  to  $+V_p$ , the pulse width  $T_p$  varies from zero to  $T$ . The effect of this is to modulate the width of  $T_p$ . At  $X = 0$ , the pulse width is  $T/2$  and  $E_S$  is a symmetrical square wave. The Electronic Polarity Switch is gated by  $E_S$  and has an output amplitude proportional to input  $Y$ . The dc average of the modulated waveform ( $E_m$ ) is given by

$$\begin{aligned} (E_m)_{Avg.} &= \frac{1}{T} \int_0^T E_m dt \\ &= \frac{1}{T} \left[ \int_0^{T_p} Y dt + \int_{T_p}^T (-Y) dt \right] \\ &= \frac{1}{T} [Y T_p - Y (T - T_p)] \\ &= \frac{1}{T} (2Y T_p - Y T). \end{aligned}$$

Substituting the expression for  $T_p$  into the equation for  $(E_m)_{Avg.}$  leads to

$$(E_m)_{Avg.} = \frac{1}{T} \left[ (2Y) \left( \frac{T}{2} + \frac{X}{2V_p} T \right) - YT \right] = \frac{XY}{V_p}.$$

Usually,  $V_p$  is set equal to 10-V. Notice that the amplitude stability of the triangle wave is very important, but the frequency stability is not.

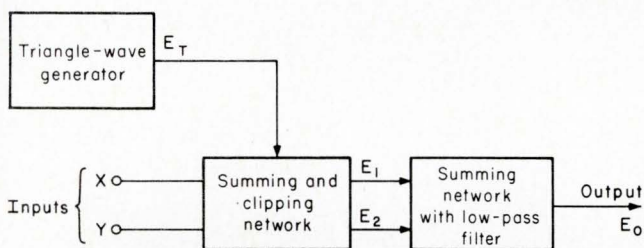

**Fig. 7. Triangle averaging multiplier.** As with the pulse-height/width type, a high-frequency triangle-wave is generated. This time the triangle wave is combined with the input signals and rectified. The details are cumbersome and will not be shown; however, two waveforms ( $E_1$  and  $E_2$ ) are created whose average values are:

$$\begin{aligned} (E_1)_{Avg.} &= \frac{2V_p^2 + \frac{1}{8}(X - Y)^2}{4V_p} \\ (E_2)_{Avg.} &= \frac{-2V_p^2 - \frac{1}{8}(X + Y)^2}{4V_p} \end{aligned}$$

Summing  $E_1$  and  $E_2$  at a gain of four provides an output of

$$E_o = \frac{-XY}{2V_p}.$$

$V_p$  is usually made equal to 5 V. As with the pulse-height/width type, amplitude stability of the triangle wave is crucial but the frequency stability is not.

The noise specification and the cutoff frequency of the low-pass filter should be checked, in view of the inevitable compromise between faster response and lower noise. The high-frequency ac ripple at the output seldom causes any difficulty if the multiplier is used in a low-pass system, but capacitively coupling the output of an averaging-type multiplier into a system can cause problems.

### Future trends

Currently, the quarter-square technique offers a combination of good accuracy with moderate-to-high speed. Although quarter-square units remain the best choice for many applications, they will be gradually displaced by variable-transconductance and averaging units.

The transconductance of a semiconductor junction is the principle behind a variety of recently developed

multipliers. (Unfortunately, the nomenclature is muddled, and different circuits have been given the same name.) A judicious blend of monolithic, hybrid, and discrete techniques should enable manufacturers to further improve accuracies and lower the cost of "variable-transconductance" type multipliers.

Multipliers based on averaging a modulated carrier combine good accuracy with low to moderate prices. Their most significant limitations are ac noise at the output and slow speed. Most averaging multipliers use several operational amplifiers internally. As higher quality, less expensive IC operational amplifiers become available, performance will improve and costs drop.

**INFORMATION RETRIEVAL**  
Circuit design, Data processing, Computers

# Feel Free To Flex

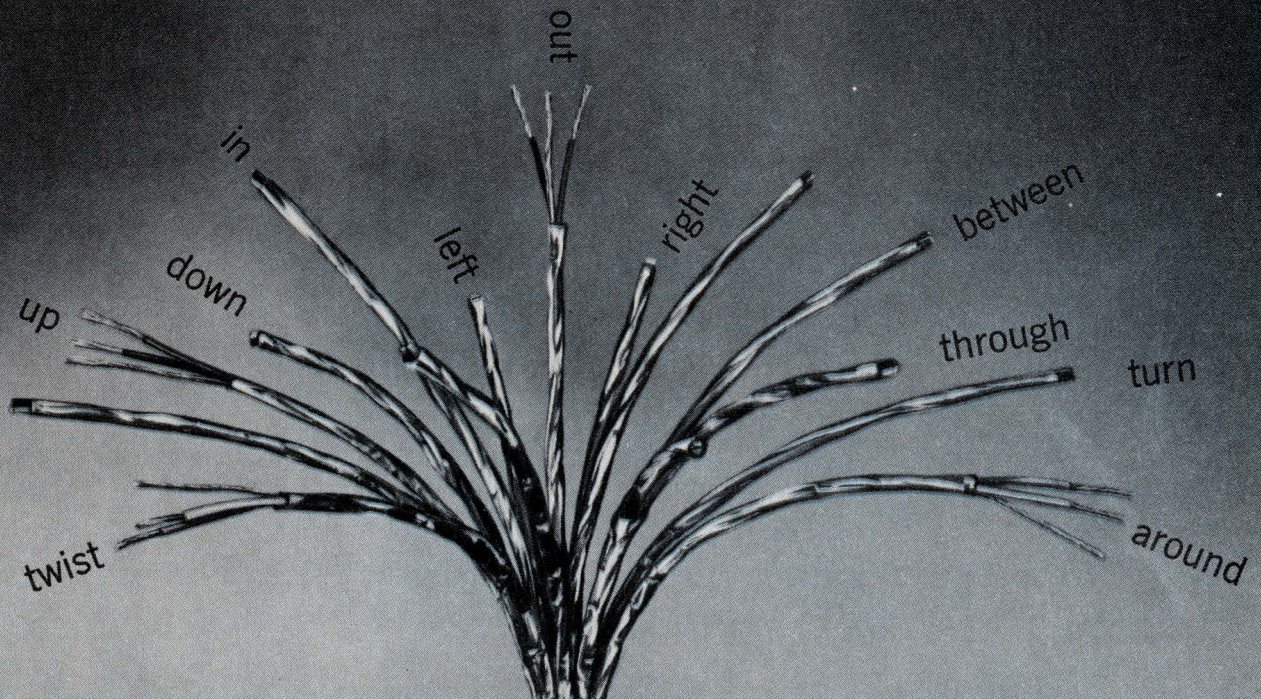

Yes, we know . . . we used to recommend Beldfoil Shielded Cable only for fixed applications. We were too modest. Extended testing proves Beldfoil, even after repeated flexing, provides more physical shield coverage than braided wire or spiral wrapped (served) shields. And greater shield effectiveness. □ Beldfoil is a layer of aluminum foil bonded to a tough polyester film (for insulation and added strength). A Belden invention. We apply it in different ways for different applications. We can even form a unique shield that's like a continuous aluminum tube. This we call ISO-Shield™. □ When new (or in fixed applications) Beldfoil ISO-Shield is extremely effective in limiting crosstalk or interference . . . whether from outside sources or between shielded elements in the same cable. □ Under frequent flexing minor separations may occur in the foil. But special Beldfoil construction features prevent performance from becoming seriously affected. We do, however, recommend that you tell us if cable flexing is to be extreme. We have special designs available to meet severe flexing requirements. □ Beldfoil makes possible a small, lightweight cable that terminates easily and is modest in

price. Your Belden distributor stocks or can quickly obtain just about any size or type you need . . . from single conductor audio and sound cable up to data cable having 27 individually shielded pairs (more pairs available on special order). Ask him for the latest "Belden Electronic Wire and Cable Catalog." Or for technical information, contact Belden Corporation, P. O. Box 5070-A, Chicago, Illinois 60680; phone (312) 378-1000.

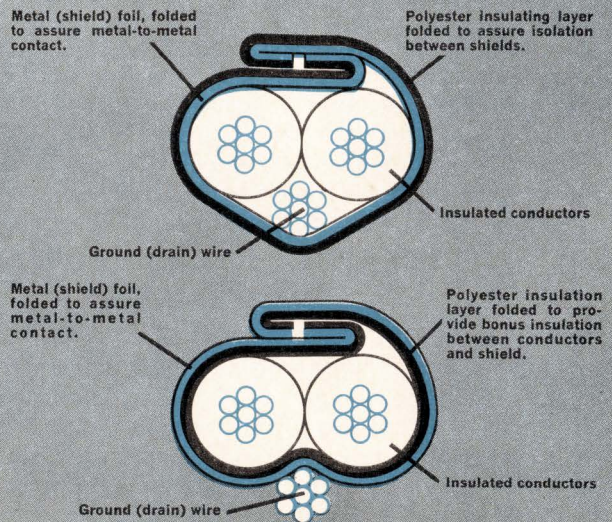

# Beldfoil<sup>®</sup> Shielded Cable

-shield effectiveness remains outstanding

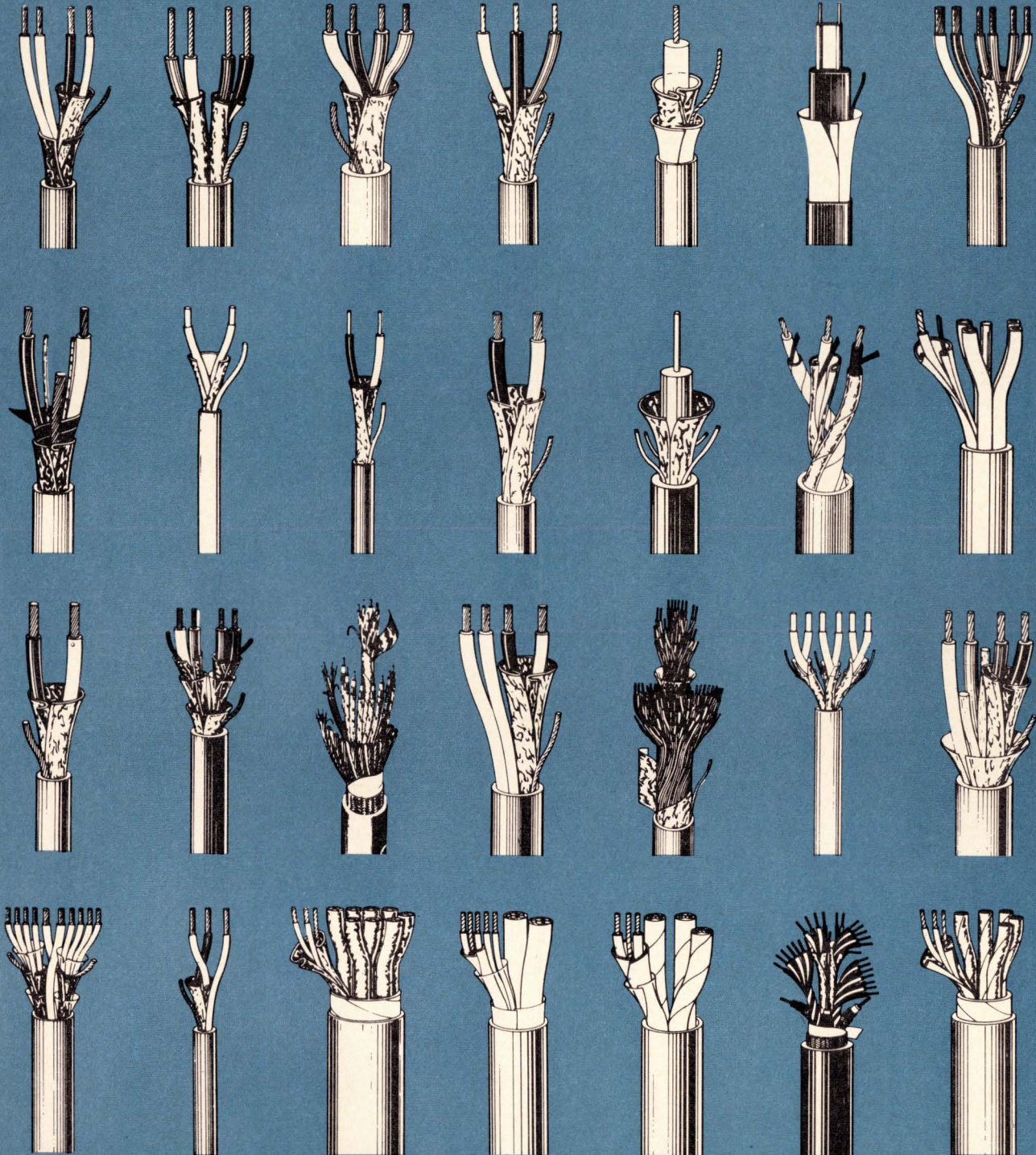

**BELDEN** 

8-5-9 A

*new ideas for moving electrical energy*

Whether you want a wave analyzer or a spectrum analyzer, the ambidextrous HP 3590A does the job. This flexibility is achieved through the use of automatic amplitude ranging, electronic frequency sweeping, and linear or log X-Y outputs for graphic display.

But this dual capability is only the start of the HP 3590A's measuring ability. Add to this versatility the >85 dB dynamic range, highly selective bandwidths, ac and dc programmability, and a frequency range of 20 Hz to 620 kHz. The sum of all these improvements is increased performance and accuracy at speeds previously unattainable. Why settle for

less? With the HP 3590A, you get the measurements you want—when you want them—faster and easier.

To provide the additional advantages of a special balanced input with selectable terminating impedances of 75, 135, 150, and 600  $\Omega$ —the new HP 3591A selective voltmeter is now available. Multiply this highly useful input capability by the fact that the 3591A is calibrated to indicate properly in either dB or dBm regardless of the terminating impedance selected. One result—an analyzer capable of making noise and level measurements on balanced voice frequency circuits, or on carrier systems up to 120 channels. And this example is only one of the many applications of an instrument designed with you in mind.

The 3590A mainframe is \$3200. The 3591A mainframe is \$3350. Three plug-ins are available: 3592A low cost slave and program unit when used in second 3590A, \$80; 3593A with 3-digit mechanical display, \$1100; 3594A with 5-digit electronic counter frequency display, \$1600.

To get complete information on either the HP 3590A or the HP 3591A, call your local HP field engineer. Or, write to Hewlett-Packard, Palo Alto, California 94304. Europe: 1217 Meyrin-Geneva, Switzerland.

099/6

## Wave Analyzer or Spectrum Analyzer? The HP 3590A is both!

HEWLETT  PACKARD  
SIGNAL ANALYZERS

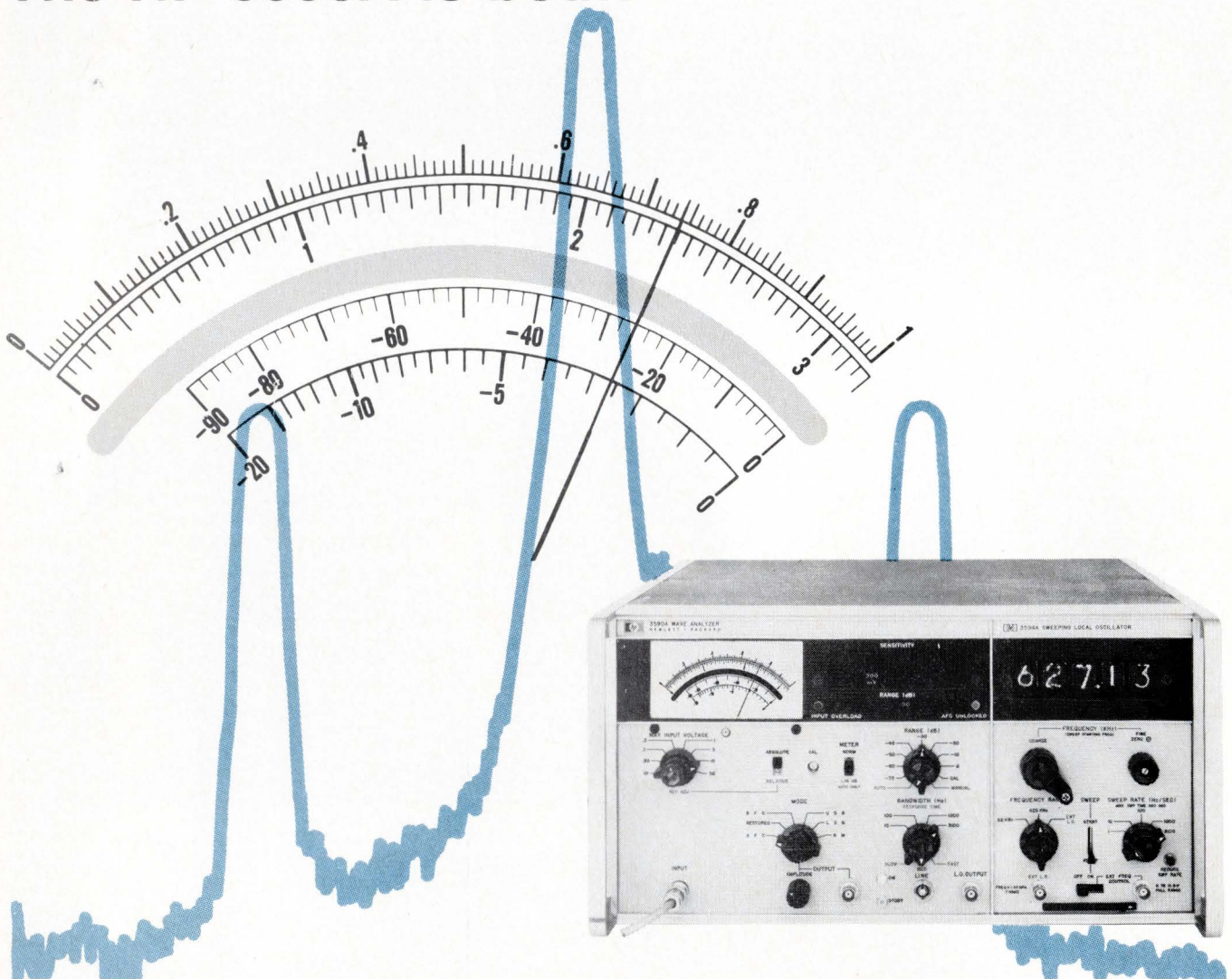

# Variable frequency multivibrator has wide range

With this circuit you can get wide frequency range with variable frequency capabilities. Exact component values can be easily calculated with the given formulas.

**R. J. Surprenant**, Scientist, LTV Research Center, Anaheim, Calif.

Variable frequency square wave oscillators, such as the astable multivibrator, have important applications where precise frequency tuning and/or a wide frequency range are needed. Normal methods for achieving these circuits require additional active components and control voltages or have very limited frequency ranges. This article describes a circuit that overcomes both of these disadvantages. Design formulas are included here for determining component values for various applications.

Variable-frequency astable multivibrators can be designed using either voltage control or resistance control. Voltage-controlled circuits, such as the one shown in Fig. 1 require active components (Q3 and Q4) as well as a voltage source,  $V_{in}$ . In addition, for low values of supply voltage,  $V_s$ , the frequency spread between  $f_{max}$  and  $f_{min}$  is restricted by the useful range of  $V_{in}$ .

The conventional resistance-controlled multivibrator is shown in Fig. 2. This circuit requires no active control components. However, its  $f_{min}$  to  $f_{max}$  frequency range is severely limited due to the collector-to-base feedback path that results from connecting the  $R_b$ 's to  $R$ . To prevent Q1 from turning itself off after it has been turned on,  $R_b$  must be greater than  $R$ . Now, the expression for the period of oscillation  $T$  for this circuit is,

$$T = \frac{2 R_b (R_b + 2R)}{R_b + R} C \ln \left( 2 + \frac{R}{R_b} \right) \quad (1)$$

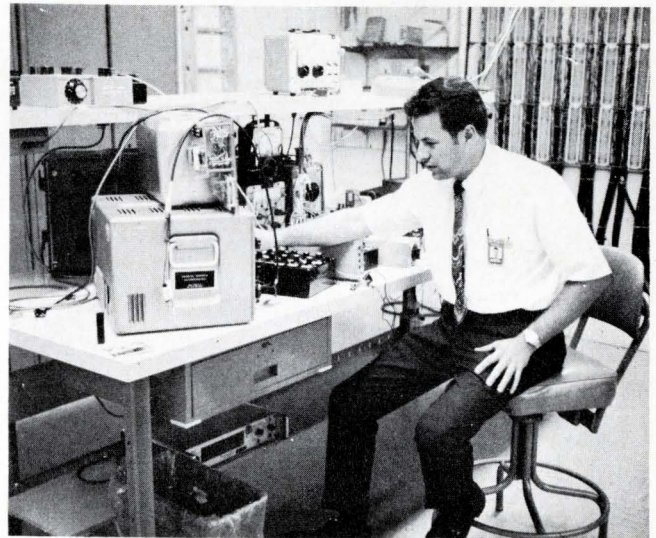

The minimum period occurs when  $R = 0$

$$T_{min} = \frac{2R_b (R_b)}{R_b} C \ln 2 = 2R_b C \ln 2 \quad (2)$$

The maximum allowable period occurs when  $R = R_b$

$$T_{max} < \frac{2R_b (R_b + 2R_b)}{2R_b} C \ln (2 + 1)$$

$$T_{max} < 3R_b C \ln 3$$



$$\left. \frac{T_{max}}{T_{min}} \right|_{max} = 0.3 \beta_{min}$$

A typical  $\beta_{min}$  would be 40 giving a useful frequency range of 12 as opposed to the 2.3 range of the unmodified circuit.

### Component design formulas

You can use the following set of design formulas to find the component values for the multivibrator.

1. Choose an  $R_1$  such that the  $\beta_{min}$  of Q1 and Q2 at  $I_c = \frac{R_s}{R_1}$  is a maximum.
2. For a given  $T_{min}$  or  $T_{max}$ , choose the other such that

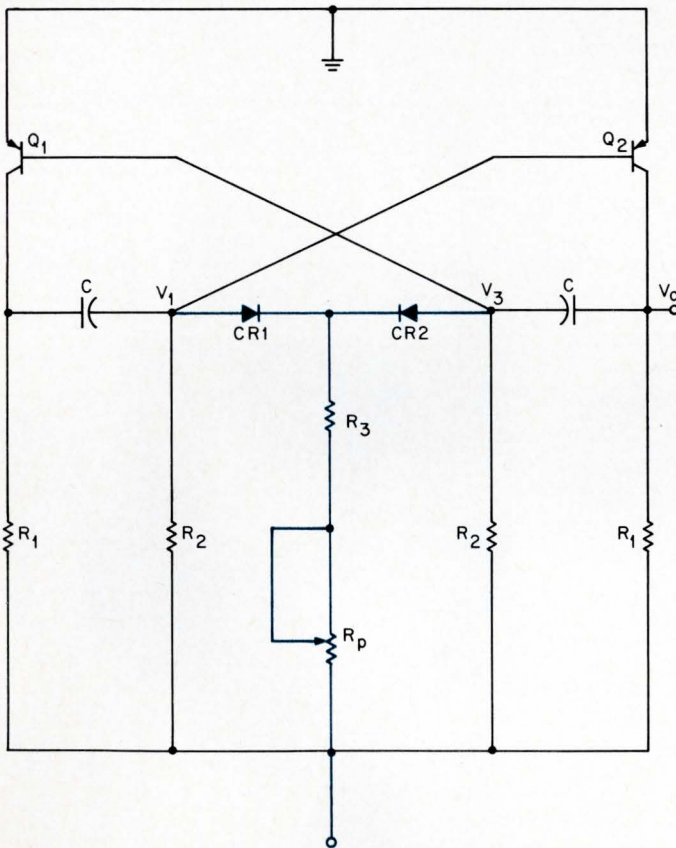

Fig. 3: If you remove the collector-to-base feedback, the resistance controlled multivibrator can be greatly improved. This is achieved by adding two diodes and three resistors to Fig. 2. The useful frequency range is now extended and the period of oscillation for this circuit is limited by

$$\left. \frac{T_{max}}{T_{min}} \right|_{max} = 0.3 \beta_{min}$$

where  $\beta_{min}$  is the minimum  $\beta$  of the transistors. A typical  $\beta_{min}$  of 40 gives a useful frequency range of 12.

$$\frac{T_{max}}{T_{min}} < 0.3 \beta_{min}$$

3. Equation 4 yields the following value for C.

$$C = \frac{T_{min}}{4.6 R_1} \quad (7)$$

4. Solving Eq. 7 for  $R_1$  yields

$$R_1 = \frac{T_{min}}{4.6 C} \quad (8)$$

Substituting Eq. 8 into Eq. 6 gives

$$R_2 = \frac{\beta_{min} T_{min}}{4.6 C} = \beta_{min} R_1 \quad (9)$$

5. Substituting Eq. 9 into Eq. 2 yields

$$R_3 = \frac{T_{min} \beta_{min} R_1}{1.38 C \beta_{min} R_1 - T_{min}} = \frac{\beta_{min} T_{min}}{C (1.38 \beta_{min} - 4.6)} \quad (10)$$

6. Substituting Eqs. 8, 9 and 10 into Eq. 1 yields:

$$R_p = 3.3 \beta_{min} R \left[ \frac{T_{max} - T_{min}}{(\beta_{min} - 3.3) (\beta_{min} T_{min} - 3.3 T_{max})} \right]$$

### A design example

A 10 – 100 Hz oscillator with  $V_s = 6$  V will be designed to illustrate the applications of these formulas.

1. Q1 and Q2 will be 2N4060's which have a  $\beta_{min} = 40$  at  $I_c = 1$  mA. Therefore,

$R_1$  was chosen to be 6.2 k $\Omega$

$$2. \frac{T_{max}}{T_{min}} = \frac{100}{10} = 10 < 0.3 \beta_{min} = 12.$$

$$3. C = \frac{10^{-2}}{4.6 \times 6.2 \times 10^3} = 0.36 \mu f$$

$$4. R_2 = \beta_{min} R_1 = 240 \text{ k}\Omega$$

$$5. R_3 = \frac{40 \times 10^{-2}}{0.36 \times 10^{-6} (1.38 \times 40 - 4.6)} = 22 \text{ k}\Omega$$

$$6. R_p = 3.3 \times 40 \times 240 \times \left[ \frac{40 \times 10^{-3}}{(40 - 3.3) (40 \times 10 - 3.3 \times 100) 10^{-3}} \right]$$

Therefore

$$R_p = 1.1 \text{ M}\Omega$$

With the above values and with germanium diodes for CR1 and CR2, the frequency range was 10.6 Hz to 108 Hz.

### References

- Goan, Joseph, "Wide-Range Voltage Controlled Multis," E.E.E., April 1, 1964, p. 48.  
 Manzollilo, Dan, "Single Pot Symmetrically Controlled Astable Multivibrator," Ideas for Design, Electronic Design, July 19, 1962, p. 73.

**INFORMATION RETRIEVAL:**  
Oscillators, Circuit design, Circuit theory

# There isn't another like it. A 1/4-inch, single-pole, six position, 28-vdc. Helipot switch for PC boards.

**Beckman**® INSTRUMENTS, INC.

**HELIPOT DIVISION**

Fullerton, California 92634

INTERNATIONAL SUBSIDIARIES: AMSTERDAM; CAPE TOWN;  
GENEVA; GLENROTHES, SCOTLAND; LONDON; MEXICO CITY;  
MUNICH; PARIS; STOCKHOLM; TOKYO; VIENNA



Model 374H \$3.00 (1-9 pieces)

Model 374 \$2.75 (1-9 pieces)



# IC IDEAS

---

This month's Ideas	Page
No. 905: Low frequency sine wave crystal oscillator . . . . .	88
No. 906: Op amp makes unique one-shot . . . . .	88
No. 907: TTL compatible lamp driver . . . . .	90
No. 908: Zero input impedance preamp . . . . .	90
No. 909: One-shot triggers on both edges of input . . . . .	92
No. 910: Op amp phase shifter for 0 or 180° . . . . .	92

---

**Vote** for the one you like best.

Write the number of the Idea you like best in the box on the Inquiry Card, and send to us.

---

**Send us** practical, reproducible ideas that are original with you and have been implemented with linear or digital ICs.

- If we publish your idea you win a check for \$25.00.
- If our readers vote yours the best of the issue in which it appears, you have your choice of a Simpson 270 or a Triplet 600 multimeter.
- After 12 issues our readers will vote on the best

idea for all 12 issues. The winner gets his choice of either a Hewlett-Packard 1206A or a Tektronix 310A oscilloscope.

Submit your IC Ideas to:  
Alberto Socolovsky  
Editor  
THE ELECTRONIC ENGINEER  
Chestnut & 56th Sts.  
Philadelphia, Pa. 19139

---

## Here's how you voted

The winning Idea for the October 1969 issue is, "A staircase waveform generator"



James W. Foltz, our prize-winning author, is an engineer at Motorola's Integrated circuits center in Mesa, Arizona. Mr. Foltz has chosen the Simpson Model 270 multimeter as his prize.

## 905 Low frequency sine wave crystal oscillator

**Richard S. Baggett**

Hughes Aircraft Co., Los Angeles, Calif.

Low frequency (less than 90 kHz) crystals present a problem because the resistance of the crystal is very large—on the order of 50- to 100-k $\Omega$ . Because of this large resistance, the amplifier gain must be large so that a total loop gain of unity is maintained.

The  $\mu$ A702 used in this circuit provides the large gain needed and an AGC loop produces a sine wave output. The AGC loop is shown in the dashed lines. The output is rectified by  $CR_1$  and filtered by  $C_2$  and  $R_6$ . The resultant dc voltage is used to change the resistance of  $Q_1$  which changes the gain of the  $\mu$ A702. The value of  $C_3$  should be adjusted until an undistorted sine wave output is produced.

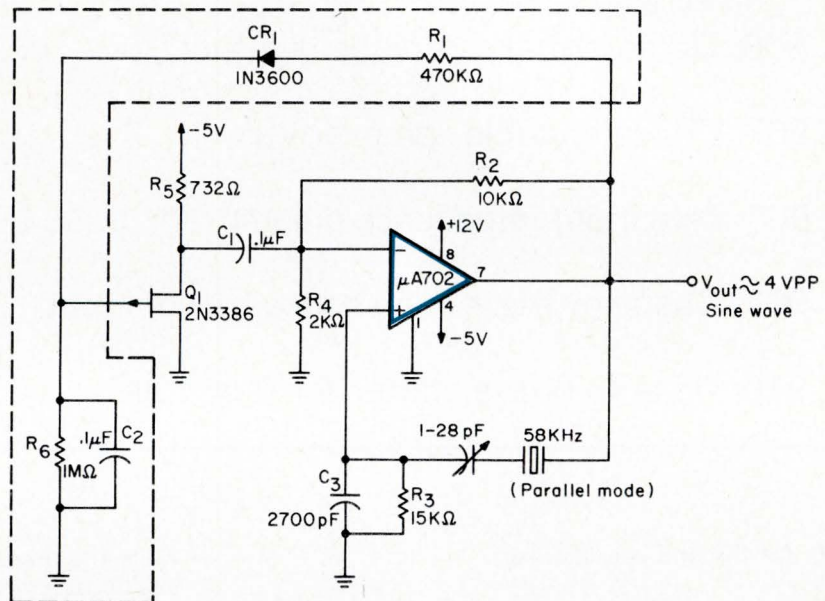

## 906 Op amp makes unique one-shot

**Maxwell G. Strange**

NASA, Goddard Space Flight Center, Greenbelt, Md.

This one-shot is inherently temperature stable. The circuit provides a highly repeatable trigger point independent of the input pulse rise time. Also, its output swing can drive FET switches or reed relays directly.

Voltage divider  $R_1$ ,  $R_2$ ,  $R_3$  and  $R_4$  holds the input threshold  $V_t$  at a positive value. Therefore, when the input is at ground, the output is saturated positively. When the input level exceeds  $V_t$ ,  $R_3$  provides regeneration to switch the output to negative saturation. Capacitor  $C$  then charges exponentially such that  $V_t$  returns toward its normal positive value. When  $V_t$  passes through OV, regenerative action causes the output to rapidly return to positive saturation.

Because the inverting input must return to ground before timeout,

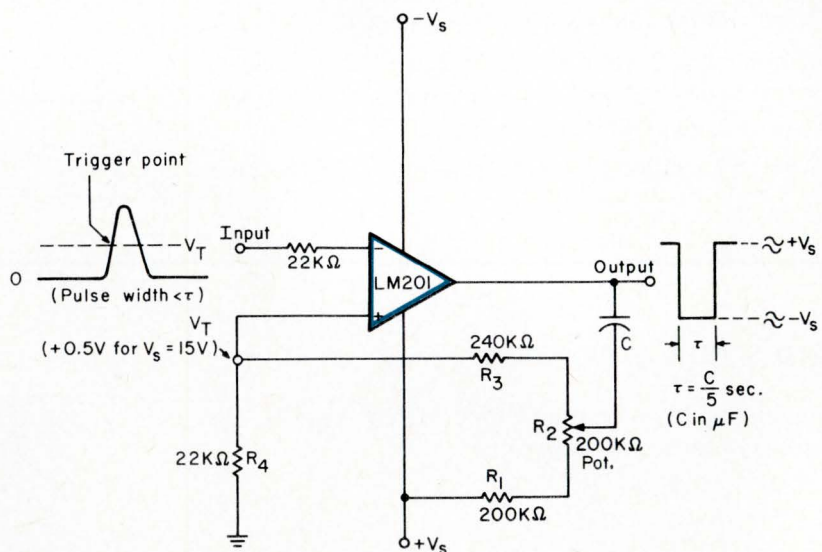

you can use an RC differentiator if the input pulse is too long or if its base level is at some level other than ground.

Pulse width, variable from micro-

seconds to seconds, is proportional to the value of  $C$ ; a value of 0.005  $\mu$ F gives about 1 ms. Resistor  $R_2$  provides a fine adjustment without affecting  $V_t$ .

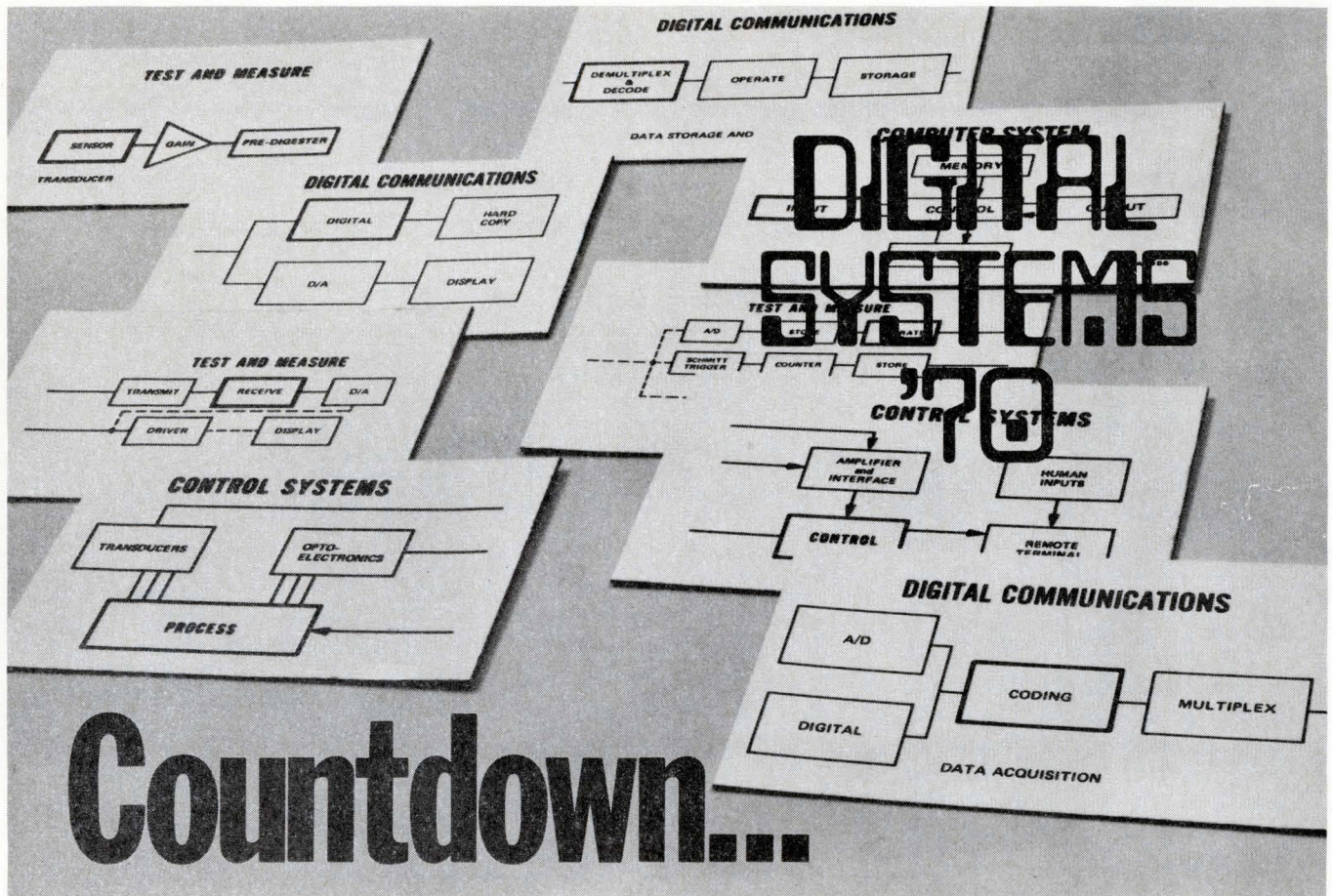

# Countdown...

## To Digital IC Problem Solving

Digital Systems '70 — an in-depth digital integrated circuit seminar covering all digital families is on the way. You'll learn of new techniques in high-speed logic, discuss complex and special functions — and probe the new developments in MOS, CMOS, Poly Cells, CAD and memories.

It will be a full day with a short pause for lunch (included in the nominal \$25 registration fee). And then off to the afternoon session highlighted by custom MSI/LSI discussions and a comprehensive high-speed logic applications clinic. Bring your questions along — you'll find our panel of "digital problem solvers" ready to provide tips on Motorola's complete digital line.

### Reserve Now.

Make your arrangements now as seating will be limited to the first 250 reservations in each area. Contact your nearby Motorola Semiconductor sales office or distributor for details. Or send your check or money order for \$25.00 to P.O. Box 20912, Phoenix, Arizona 85036.

### We'll be there...

May 11 - New York  
International Hotel,  
Kennedy Int'l Airport,  
Jamaica, L. I.

May 12 - New York  
Hilton Inn,  
Tarrytown, N.Y.

May 13 - Philadelphia, Pa.  
Holiday Inn,  
Route #1 &  
Schuylkill Expressway

May 14 - Washington, D.C.  
Twin Bridges Marriott,  
Twin Bridges, U. S. #1

May 15 - Florida  
Sheraton Ft. Lauderdale  
Ft. Lauderdale, Florida

May 18 - Texas  
Royal Coach Motor Hotel,  
Dallas

May 19 - Chicago  
Arlington Park Towers,  
Arlington Heights, Illinois

May 20 - Minnesota  
Thunderbird Motel  
Minneapolis

May 21 - California  
Sheraton Universal Hotel,  
Universal City

May 22 - California  
Ricky's Cabana Hyatt  
House,  
Palo Alto

May 25 - California  
Grand Hotel,  
Anaheim

*- where the priceless ingredient is care!*



**MOTOROLA**  
Digital Integrated Circuits

## 907 TTL compatible lamp driver

**Hal Koester**

Data Products Corp., Woodland Hills, Calif.

This simple and inexpensive incandescent lamp driver can be made with a TI SN7440 dual, 4-input NAND buffer. The lamp power source is directly off the IC power supply. Each lamp circuit requires 60 mA, and the series resistors are necessary to limit and balance the current.

A high level input will turn the lamp on. Unused inputs on the buffer can be left open or tied to the driving source if the loading is allowable. Because of the low intensity of the 338 lamp, a clear lens cap on the indicator will give best results.

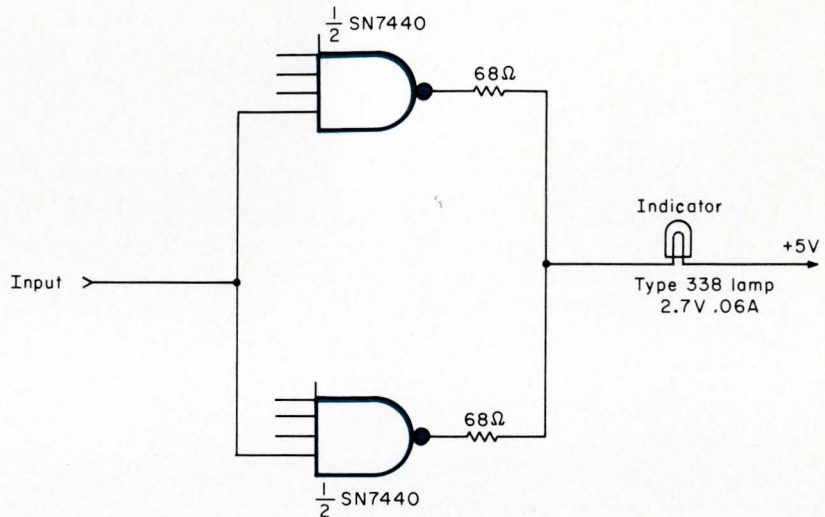

## 908 Zero input impedance preamp

**Albert E. Hayes**

Consulting Engineer, San Jose, Calif.

This circuit uses a zero input impedance amplifier as the preamp in a digital tape reproduce system. In conventional reproduce systems, the output voltage from the head is the time derivative of the recorded signal rather than a replica of the signal itself.

Also, to maximize the signal voltage at the preamp, you must maintain a high impedance across the head. This requirement encourages stray noise pickup and accentuates the undesirable shunting effect of the distributed capacity of the usual shielded head cable.

Using an IC op amp presents a virtual zero input impedance to the head terminals and the output current rather than the voltage is fed to the amplifier. Since this current is essentially the time in-

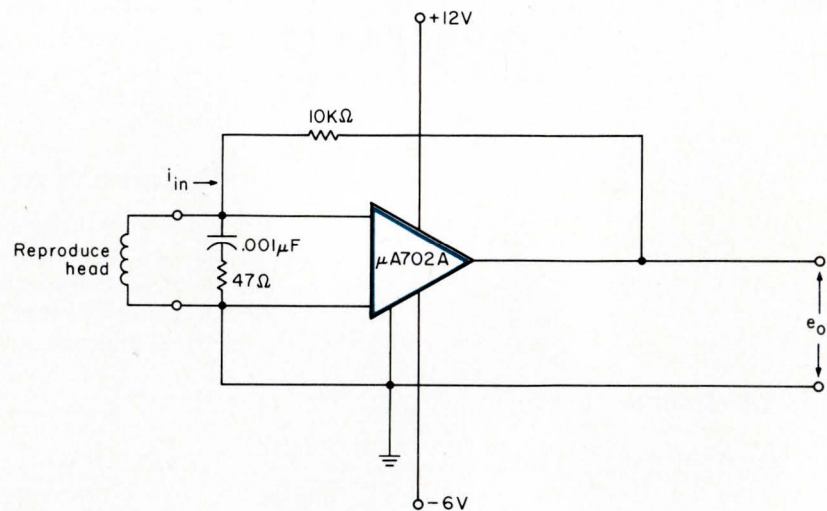

tegral of the voltage because of the inductance of the magnetic head, it comprises a replica of the recorded signal.

The values shown give you 10

mV of output signal for each microamp of head current. In addition, an obvious improvement in noise pickup results from the zero impedance head termination.

# FREE ALL YOU NEED TO KNOW ABOUT SERIES 54/74 TTL CIRCUITS.

272 pages of data list specs, illustrate logic diagrams, give test conditions for

- 54/74 STANDARD CIRCUITS
- 54H/74H HIGH SPEED CIRCUITS
- 54/74 MSI COMPLEX ARRAYS



**WANT THEM RIGHT AWAY? FILL OUT AND MAIL THE COUPON TODAY.**

**YES!** Send me the 54/74 handbooks I've checked.

Standard Circuits—88 page handbook EB25640A.

High Speed Circuits—88 page handbook EB25645.

MSI Complex Arrays—96 page handbook EB25655.

Name \_\_\_\_\_

Title \_\_\_\_\_

Company \_\_\_\_\_

Address \_\_\_\_\_

City \_\_\_\_\_

State \_\_\_\_\_ Zip \_\_\_\_\_

**MAIL TO:**  
 TECHNICAL LITERATURE SERVICE  
 SPRAGUE ELECTRIC COMPANY  
 233 MARSHALL STREET  
 NORTH ADAMS, MASS. 01247



Circle Reader Service Number 6 for 54/74 Standard Circuit Handbook

Circle Reader Service Number 7 for 54H/74H High Speed Circuit Handbook

Circle Reader Service Number 8 for MSI Complex Array Handbook.

## 909 One-shot triggers on both edges of input

**Ken Erickson**

Interstate Electronics Corp., Anaheim, Calif.

This circuit gives you a pulse of the desired width whenever the input changes logic states. If the input is a symmetrical square-wave you can use it as a frequency doubler. Another application is as a detector to monitor changes in digital data.

If the  $Q$  output of the flip-flop is initially at logic 0, when the input changes state, the output of the exclusive OR gate goes to a 1 level and triggers the one-shot. When the one-shot times out, the output goes low and the inverted output goes high thus toggling the flip-flop to the logic 1 state. This causes the output of the gate to go low and removes the input to the one-shot. With each half cycle of the input square wave this sequence is repeated.

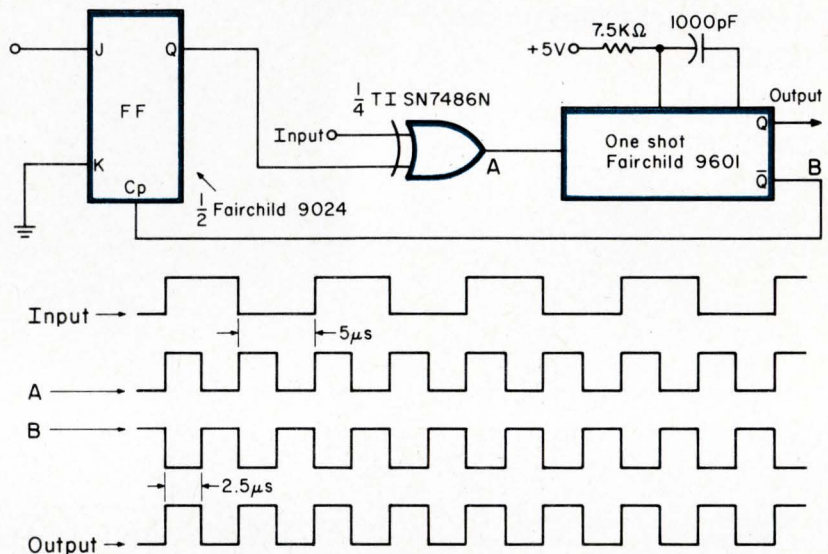

## 910 Op amp phase shifter for 0 or 180°

**Irwin Cohen**

Theta Instrument Corp., Bogota, N. J.

When a wideband, single-ended signal must be passed as is or else phase shifted by 180°, it usually requires more than one amplifier and several switching elements.

This circuit accomplishes the same function with one op-amp and retains the low source impedance. Switches  $Q_1$  and  $Q_2$  are MOSFETs but any switching element consistent with the dc offset requirements of the circuit could be used.

When  $Q_1$  is off and  $Q_2$  is on, the amplifier is in the inverting configuration with a gain of  $-1$ . With  $Q_1$  on and  $Q_2$  off, the amplifier functions in both the inverting and non-inverting configurations and by superposition the net gain is  $+1$ .

Matching of the gains in the two configurations is dependent on the match of the  $R_1$  resistors. The re-

For min. dc drift  $R_2 = 0.5R_1 - R_{on}$   
(of FET)

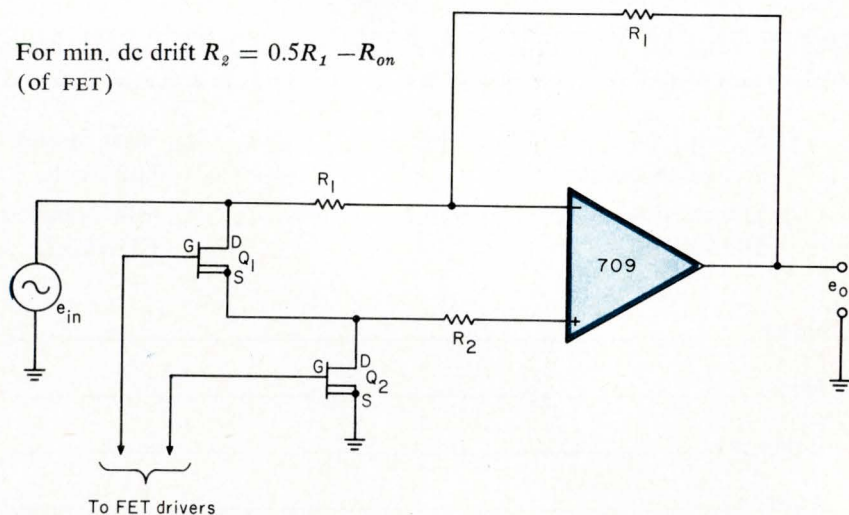

sistance of the FET switches has an insignificant effect on the circuit gain. In both modes, the output impedance approaches zero.

You can also use the circuit as a demodulator by driving the MOSFETs with a periodic reference signal.

# Take advantage of RCA's ability to supply superior SCR's and Triacs... when you need them.

Ask our solid-state specialists why RCA's broad line of industrial SCR's and triacs excel in quality, reliability, and performance. They'll tell you that RCA thyristors are subjected to some of the toughest quality assurance tests in the industry. Thus, they save design dollars by virtue of superior performance in critical applications.

Ask users of industrial thyristors why RCA is a key supplier and they'll tell you RCA services the industry! Whatever the application—area lighting to avionics, regulators to inverters, or power supplies to modulators—RCA has SCR's and triacs to meet your application requirements.

Use these SCR's and triacs in your control applications:

SCR Family	Rating		Triac Family	Rating	
	$I_T(\text{RMS})$	$V_{\text{DROM}}$		$I_T(\text{RMS})$	$V_{\text{DROM}}$
40740	10 A	600 V	2N5568	10 A	400 V
40752	20 A	600 V	2N5572	15 A	400 V
2N690	25 A	600 V	40671	30 A	600 V
2N3899	35 A	600 V	2N5543	40 A	600 V

NOTE: SCR ratings of 100, 200, & 400 volts and triac ratings of 200 & 400 volts are available in each family. Stud packages & isolated-stud packages are also available in each rating.

For further details and your copy of the latest thyristor catalog, THC-500, see your local RCA Representative or your RCA Distributor. Or write RCA Electronic Components, Commercial Engineering, Section RJ4 /UR6, Harrison, N. J. 07029. In Europe: RCA International Marketing S.A., 2-4 rue du Lièvre, 1227 Geneva, Switzerland.

**RCA**  
Thyristors

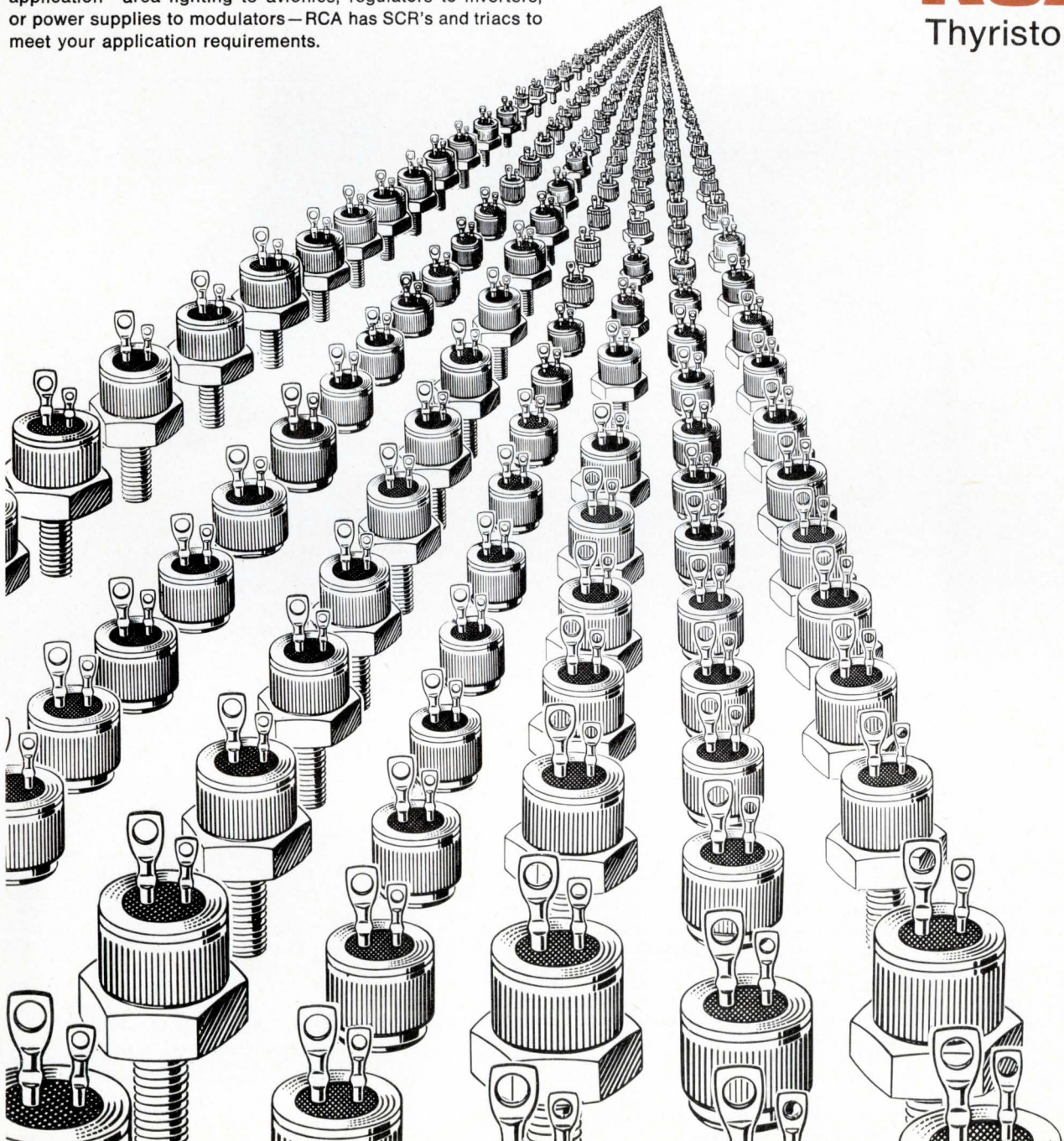

# Full performance at a price you can afford



You don't have to be a Scotsman to know that you pay more for top performance. So if we told you this new 3-digit DPM was made to sell for less than \$115 in OEM quantities, you'd figure its performance at something less than that delivered by our higher priced models.

But you'd be wrong. And here's why.

First of all, our initial objective was to develop an instrument for OEM measurement needs of the scientific and medical community. Obviously, price was an important factor. But so was performance. The happy solution

was to eliminate a few of the more exotic functions that these users normally don't require. For example, 100% overrange and standard BCD output (an option available on Model 1261).

Secondly, instead of compromising performance, we've actually *improved* it! Model 1261 is a basic 0-99.9 millivolt DC meter with 50% overrange capability, 100 microvolt resolution, long-term stability, 50 megohm input impedance, high rejection characteristics, and Weston's patented dual slope\* circuitry. It's packaged in the plug-in case that's common to all our

DPM's, giving you Weston front panel serviceability.

This latest addition to our DPM family brings .1% accuracy within range of practically everyone's budget. Make your own comparisons, spec for spec, with other digital compacts on the market. Write today for complete data and ranges available.

WESTON INSTRUMENTS DIVISION,  
Weston Instruments, Inc., Newark, N.J.  
07114, a Schlumberger company

**WESTON®**



# Feature article abstracts

Published information is vital to your job.

To save time in finding this information,  
we have abstracted the important technical features  
from eight electronic engineering publications.

Should any of these articles interest you, contact the magazine—  
names and addresses are listed below.

Reprints of articles with an asterisk are available free.

Save this section for future reference.

## Amplifiers

**Diodes make good gain-control devices**, Richard S. Hughes, U. S. Naval Weapons Center, "Electronic Design," Vol. 18, No. 3, February 1, 1970, pp. 54-57. Diodes can be used for gain-control of high-performance amplifiers. The circuits for four transfer functions are shown. They are: logarithmic function, inverse log function, hyperbolic function, and linear function. The subject of diodes used as attenuators is also discussed.

## Charts and Nomographs

**The Esclangon diagram for voltage and current along a transmission line**, Michel Paloujadoff, Institut Polytechnique de Grenoble, "IEEE Spectrum," Vol. 7, No. 2, February 1970, pp. 92-94. One of the problems facing electrical engineering students is to understand the phenomenon of voltage and current variation along an electric line. A graphic method, developed by the late F. Esclangon in 1943, is enlarged upon by the author as a useful complement to the Smith chart and usage of basic formulas.

**Nomographs ease circuit designing with op amps**, William H. Huber, TRW, "EDN," Vol. 15, No. 3, Feb. 1, 1970, pp. 37-42. This presents a number of nomographs useful in the design of summing and voltage follower amplifiers. The author claims these graphs will give you a first-try design accurate to 5%.

## Circuits

**\*Variable frequency multivibrator has wide range**, R. J. Surprenant, LTV Research Center, "The Electronic Engineer," Vol. 29, No. 4, pp. 83-85. The author discusses a circuit that overcomes the necessity for additional active components and control voltages or very limited frequency ranges for variable-frequency square wave oscillators, such as the astable multivibrator.

**Assemble a sequential counter**, Howard Raphael, Singer Corp., "Electronic Design," Vol. 18, No. 3, February 1, 1970, pp. 60-62. A step-by-step method is presented for starting with the number of stages needed and proceeding to the logic diagram. Flip-flops and gates are used as an alternative to expensive, unstocked, MSI devices.

**FETs improve IC op-amp performance**, Norman Matzen, Siliconix, "EEE," Vol. 18, No. 1, p. 69. A simple application note that shows how to improve the offset voltage of an LM201 operational amplifier (at the expense of its bandwidth and transient response) by adding a matched pair of low-cost JFETs at the op amp input, and operating them close to pinch-off.

**Gunn and LSA oscillators—capabilities and state of the art**, Prof. Lester Eastman, Cornell University, "Electro-technology," Vol. 85, No. 2, February 1970, pp. 25-28. Developments that have been made in the last few years with semiconductor bulk and transit-time devices promise to lead the way to simple, completely solid state microwave systems. Both Gunn Effect and LSA devices have been developed that generate power levels large enough to be useful for these systems. The author presents the capabilities of these graphically and also plots the experimental achievements that have been made thus far.

**Need a low-voltage dc converter?**, N. Poirier & B. L. Cochun, Northeastern University, "Electronic Design," Vol. 18, No. 4, February 15, 1970, pp. 66-68. Bipolar transistors have collector to emitter saturation voltages of only about 50mV, so with the proper clocking circuitry they can be used to multiply dc signals as low as 0.1V. Circuits for voltage doublers, triplers and clocks are illustrated.

**Nobody here but us Zeners**, Richard L. White, Rigely Banada Corp., "EDN," Vol. 15, No. 3, Feb. 1, 1970, pp. 45-50. The author shows you how to use Zener diodes to generate alphanumeric characters for CRT display. The method employs 28 Zener diodes to generate ten digits and uses 60-Hz line voltage, which it splits into two phases to drive a multiple sine wave-segment generator. The generator output passes through summing networks, logic gates, and so forth, and is displayed in the CRT.

**Silicon power transistors—design and applications**, Leo Lehner, Motorola Semiconductor Products, Inc., "Electro-technology," Vol. 85, No. 2, February 1970, pp. 29-34. Silicon power transistors becoming more and more popular as their performance increases and their price decreases. But there are critical factors to consider in developing them for the maximum performance

## Magazine publishers and their addresses

### EDN

Cahners Publishing Company  
3375 S. Bannock Street  
Englewood, Colo. 80110

### EEE

Mactier Publishing Co.  
820 Second Avenue  
New York, N. Y. 10017

### Electronic Design

Hayden Publishing Co.  
850 Third Avenue  
New York, N. Y. 10022

### Electronic Products

United Technical Publications  
645 Stewart Avenue  
Garden City, N. Y. 11530

### Electronics

McGraw-Hill, Inc.  
330 W. 42nd Street  
New York, N. Y. 10036

### Electro-Technology

Industrial Research Inc.  
Industrial Research Bldg.  
Beverly Shores, Ind. 46301

### IEEE Spectrum

Institute of Electrical & Electronics Engineers  
345 East 47th Street  
New York, N. Y. 10017

### The Electronic Engineer

Chilton Company  
56th & Chestnut Streets  
Philadelphia, Pa. 19139

\*Reprints available free. Request them on your company letterhead.

## ABSTRACTS

possible. You must consider power, voltage, gain, frequency, response, reliability, cost, ruggedness and thermal sinking. Here is how they are produced and how production, packaging and thermal factors affect their use.

### Communications

**Data transmission: a direction for future development**, Harry Rudin, Jr., IBM Zurich Research Lab, "IEEE Spectrum," Vol. 7, No. 2, February 1970, pp. 79-85. Dr. Rudin discusses the problems now existing as a result of the mismatch between the low-speed terminals and channels capable of continuous flow of information. Traffic theory principles make possible combining randomly occurring messages into a more continuous flow of data traffic. The author states that much can be done in this area, especially when you consider the impact of pulse code modulation.

**Why space broadcasting**, R. P. Haviland, General Electric Co., "IEEE Spectrum," Vol. 7, No. 2, February 1970, pp. 86-91. The efficacy of satellites for TV broadcasting for both developed and underdeveloped nations is examined. The author makes a case for using a community satellite in developing areas to initiate TV service while a satellite could be used in developed areas to open up the spectrum of program choice. Cost and telecommunication policies, both national and international, are discussed.

### Components

**\*Modern techniques of analog multiplication**, Tom Cate, Burr-Brown Research Corp., "The Electronic Engineer," Vol. 29, No. 4, pp. 75-79. New design approaches and low cost IC op amps have made a bigger market for analog multiplier modules. A practical guide to aid you in the selection of analog multipliers.

**Photocell inputs—watts or footcandles?**, James M. Palmer, Centralab Semiconductor, "EDN," Vol. 15, Feb. 15, 1970, pp. 35-41. The author claims that neither photometric nor radiometric terms currently used to describe photocell parameters are entirely satisfactory. He discusses photon and thermal detectors, and the problems of specifying these devices. Finally, the author proposes an alternative method of specification, one which uses a system of units peculiar to the detector in question. Although it appears cumbersome, this new method frequently gives the most repeatable results, according to the author.

### Computers and Peripherals

**Decipher the Gray code**, Monty Walker, The Singer Co., "Electronic Design," Vol. 18, No. 4, February 15, 1970, pp. 70-74. Operation of shaft encoders and counters is speeded up when the Gray code is used in place of binary, because only one bit changes when transitioning between consecutive numbers. Methods for converting from Gray to binary and decimal, and back, are given for either pencil and paper or logic circuitry.

**Laser recorders pick up where magnetic machines leave off in speed, capacity**, Stanley Parnas, Synergistics, "Electronics," Vol. 43, No. 4, February 16, 1970, pp. 101-103. A new possible application has been found for lasers—recorders. Laser beams shining onto film surfaces can be used to record data much faster than is now possible with magnetic recorders. This idea can be applied to permanent type digital-data storage, taking up much less space than magnetic tape.

**MOS Random-access Memories**, David Roop, Texas Instruments Inc., "Electronic Products," Vol. 12, No. 10, February 1970, pp. 96-97. This article reviews the MOS technology as it is applied to RAMs. Included is a short discussion of on-chip decoding vs off-chip decoding.

**Optical Character Recognition (OCR)**, Thomas L. Baasch, Assoc. Editor, "Electronic Products," Vol. 12, No. 10, February 1970, pp. 98-103. The

problem of teaching a machine to "read" is one that is getting a lot of attention. Here's a discussion of the techniques that help the machine understand the written word.

**Random-access MOS memory packs more bits to the chip**, Lee Boysel, Wallace Chan and Jack Faith of Four-Phase Systems, "Electronics," Vol. 43, No. 4, February 16, 1970, pp. 109-115. A random-access memory made with MOS has 1,054 bits, along with decoding circuitry, on a 150 mil square. The density is achieved by eliminating the separate feedback required to refresh each bit. Through new design, the refresh portion of the memory cell is shared among many bits. Thus, leaving more room for strictly data storing.

**Semiconductor memories**, Harry T. Howard, Tech. Ed., "EDN," Vol. 15, No. 3, Feb. 1, 1970, pp. 22-33. This surveys computer information storages that use semiconductor devices. The author points out that existing magnetic storage systems are the bases for semiconductor memory organizations. How to achieve such organizations economically with semiconductors is a current controversy. Ferrite core, bipolar, dynamic MOS, and static MOS mainframe memories are compared, and available semiconductor memories are listed by manufacturer and device number. The listing describes several important characteristics of each device.

### Digital Design

**Why use current-mode flip-flops?**, Ury Priel, Motorola Semiconductor, "Electronic Design," Vol. 18, No. 3, February 1, 1970, pp. 64-69. The advantages of current-mode logic are outlined and the gated R-S flip-flop is examined to illustrate them. Antirace flip-flops and master-slave circuits for lower speed-power products are discussed.

### Integrated Circuits

**The anatomy of integrated-circuit technology**, Harwick Johnson, RCA Labs, "IEEE Spectrum," Vol. 7, No. 2, February 1970, pp. 56-66. As a complement to J. J. Suron's article in January, "A perspective on integrated electronics," the author gives reasons for the spectacular growth of integrated circuits and discusses the consequences.

**\*Interfacing MOS and bipolar logic**, Tom Reynolds, Motorola Semiconductor Products, Inc., "The Electronic Engineer," Vol. 29, No. 4, pp. 62-65. Ways of combining MOS circuits and bipolar devices are discussed, along with a detailed presentation of what the problems at interface are. Circuits to solve the problems are recommended.

**LSI poses dilemma for systems designers**, Elizabeth de Atley, San Francisco Editor, "Electronic Design," Vol. 18, No. 3, February 1, 1970, pp. 44-52. This article is a series of interviews with systems and semiconductor spokesmen, and attempts to shed light on the question of which company should design the chips used in systems.

**\*MOS arrays in a data terminal**, Richard Perrin, Viatron Computer Systems Corp., "The Electronic Engineer," Vol. 29, No. 4, pp. 67-69. One of the largest users of MOS explains how they make substantial use of MOS arrays in their data terminals.

**\*MOS shift registers in arithmetic operations**, Jack Irwin, National Semiconductor Corp., "The Electronic Engineer," Vol. 29, No. 4, pp. 71-73. Despite an unhappy past history, calculators are a natural application for MOS. Because of size and cost advantages, MOS offers more function in a given area, even though they are slower than bipolars.

**What level of LSI is best for you?** G. E. Moore, Intel, "Electronics," Vol. 43, No. 4, February 16, 1970, pp. 126-130. Here is a different idea on how to decide what's best for you and about what LSI should cost. It is based upon a mathematical model developed by the author. From this model you can predict IC prices you should have to pay for your design and equipment.

### Materials

**Electrooptic effects in ferroelectric ceramics**, Cecil E. Land, Sandia Lab, and Richard Holland, Jet Propulsion Lab, "IEEE Spectrum," Vol. 7, No. 2, February 1970, pp. 71-78. Because ferroelectric ceramics are piezoelectric and optically birefringent and their coefficients of piezoelectricity and birefringence are electrically variable, these materials have diverse applications. Devices that exploit the property wherein light can be scattered or polarized in an electrically controllable way are discussed.

### Packaging

**Multiplexer p-c boards are both rigid and flexible in all the right places**, Raymond A. Grueninger, IBM Corporation, "Electronics," Vol. 43, No. 4, February 16, 1970, pp. 116-121. Because of new fabrication methods and films, it is possible to make multi-layer printed-circuit boards both rigid and flexible, exactly as required by the user.

**Wire or cable has many faces—know them all before choosing, Part I**, Frank Timmons, Belden, "EDN," Vol. 15, No. 4, Feb. 15, 1970, pp. 43-51. The author's premise is that there is no simple way to select electronic wire and cable, and that there is a lot more to the selection of a cable than whether or not it meets MIL specs. You can often get a better cable for your application, and at less cost, by checking with the cable manufacturer rather than ordering blindly from a military specification. The author discusses a wide range of electrical and mechanical requirements and parameters significant in the proper selection of a cable.

### Power Supplies

**Avoid the pitfalls of power-supply connections**, Arthur Darbie, Hewlett-Packard, "Electronic Design," Vol. 18, No. 4, February 15, 1970, pp. D10-D20. Improper wiring connections can degrade the performance of a power supply. Detailed discussions of five problem areas are given, with rules for avoiding trouble. The five categories are: improper dc distribution, ground loops, improper remote-sensing connections, improper remote-programming connections, and improper ac power-input connections.

### Test and Measurement

**Frequency meter, comparator, phase meter—three in one**, Arthur Delagrange and Robert Davis, Naval Ordnance Lab, "Electronics," Vol. 43, No. 4, February 16, 1970, pp. 122-124. This article describes an instrument that is a frequency meter, a comparator, and a phase meter all-in-one. Weighing only two pounds, the calibration/measurement unit features crystal control. The authors claim that it can be built for \$150 worth of parts.

### Miscellaneous

**From engineer to entrepreneur: financing the transition**, John F. Jordan, D. H. Baldwin Co., "IEEE Spectrum," Vol. 7, No. 2, February 1970, pp. 40-41. A well-established company may be the ideal spot for an engineer with an idea to look for financing and advice for his new high-technology firm. Practical suggestions dealing with such items as how to prepare a proposal, reincorporation agreements, and rules for the "qualified" stock option are included.

**Heat pipes—a cool way to cool circuitry**, C. H. Dutcher Jr. and M. R. Burke, Electronic Communications Inc., "Electronics," Vol. 43, No. 4, February 16, 1970, pp. 94-100. You can get rid of heat by piping it away from the source. Vapor heat transfer and capillary action combine to carry the heat through pipe-like conductors with good efficiency. Only a little over a year ago these were still in the laboratory, now they are commercially available.

Two and three-eighths inches high.

Two and three-eighths inches wide.

That's how to size up a miniature low-noise traveling wave amplifier. On the outside. Because right now that's the minimum size for designing in maximum integrated performance. Covering the things that really matter in ECM. Noise level. Gain stability at stress temperatures. Life and reliability.

That's the performance ballgame. And we play it to win.

Varian DRPM's measure up as the TWA's that deliver the best combination of performance and size going. Our wide dynamic range models check in at  $2\frac{3}{8} \times 2\frac{3}{8} \times 9\frac{1}{2}$ ". High gain models are an inch longer.

We offer a dozen off-the-shelf wide dynamic range models with up to 45 dB gain that'll cover any standard or straddleband range between 2 and 18 gigahertz. Standard models take 105°C in stride. All sport a maximum noise figure of 8.5 dB in S and C bands, 9.5 in X, 12.0 in Ku. Guaranteed through temper-

ature. The heaviest is 5.5 pounds, power supply included.

That's the big picture in miniature TWA's. It all fits in a  $2\frac{3}{8}$ " square frame. Rule in a smaller outside dimension and you rule out the best inside performance.

For more about the TWA's that deliver the performance you really need in ECM, call any Electron Tube and Device Group Sales Office. Or drop a line to TWT Division, 611 Hansen Way, Palo Alto, California 94303.



# The miniature low-noise twa ballgame begins at $2\frac{3}{8}$ ".

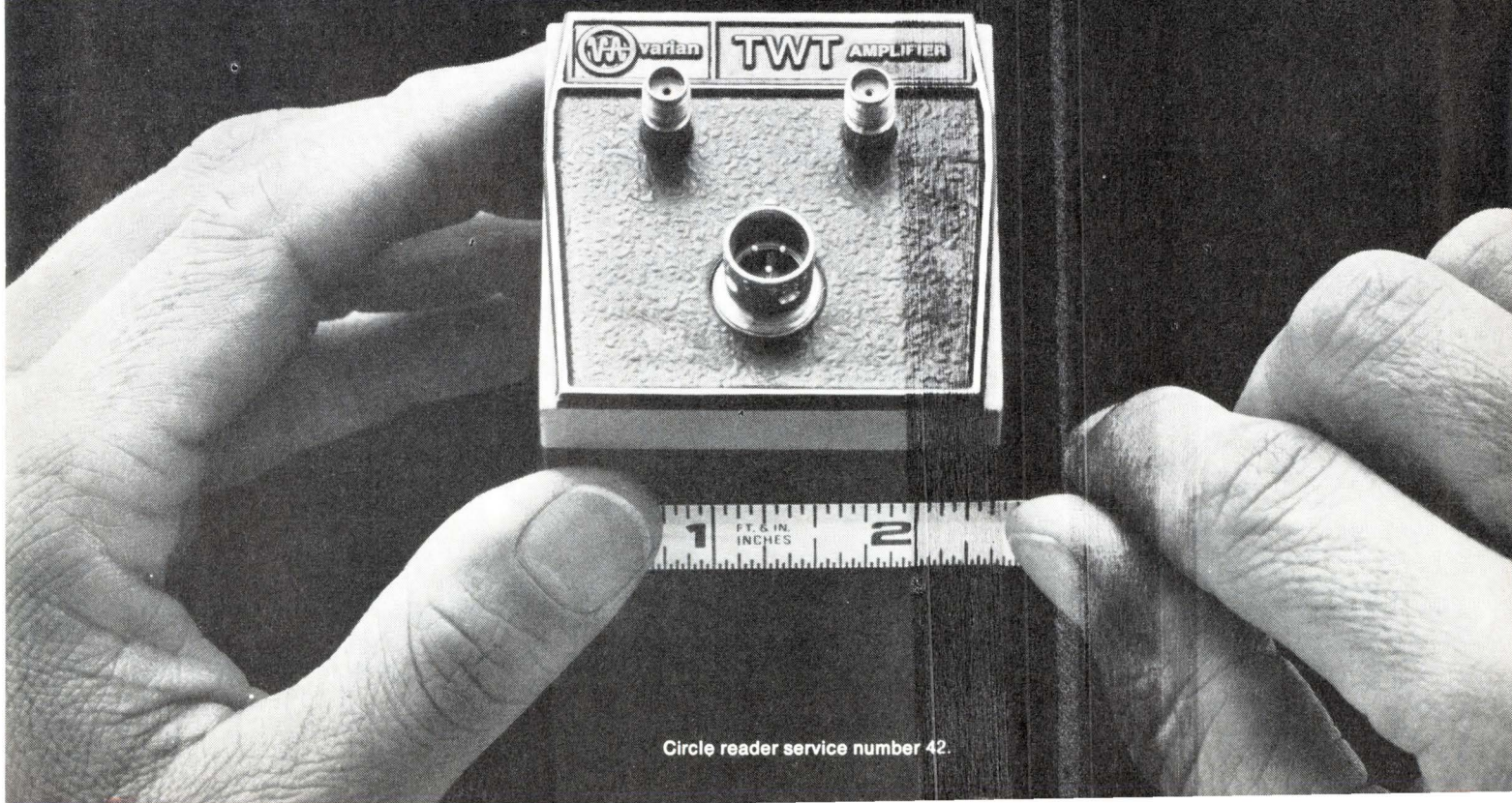

Circle reader service number 42.

## Low-frequency sweepers beat their way upstream

Swept low-frequency measurements are commonly needed in an electronics laboratory. And many such measurements must span several decades of frequency as, for example, when you test transducers, filter networks, audio amplifiers, and so forth. It is usual to make these measurements on a point-by-point basis, or with electromechanical sweep drive attachments.

But there is yet another way, one which uses the BFO (beat frequency oscillator) output of a wave analyzer or a selective voltmeter. This BFO output is a level signal source, which sweeps the input of the device under test. The analyzer or voltmeter then measures the amplitude of the resultant output of the tested device.

This test method seems, on the surface, quite satisfactory. But to make it work, you must meet several requirements. First of all, to cover frequencies lower than 100 Hz, you need a narrow-band filter in the system. This filter lets the analyzer separate the test signal from noise, and provides a reasonable dynamic range of measurement.

Secondly, use of a selective filter coupled with wide dynamic range implies slow sweep speeds in order to measure the true response of the device under test. For example in the 3590A, if the filter has a 10-Hz bandwidth, then you must sweep at about 1 Hz/s.

For electronic sweeps, a slow sweep speed means a limited sweep time. If you have a 100-s sweep, then at 1 Hz/s you can examine a 100-Hz band, maximum. But low-frequency and audio measurements should cover, preferably, 20 kHz. To fill such needs, you should have a 10,000-sweep time and a 2-Hz/s sweep rate.

Yet a third requirement on the sweeper comes about because, traditionally, audio measurements are made on a decibel vs log frequency basis.

To sum up these several requirements, a satisfactory low-frequency sweeper should have a

- narrow bandwidth, 10 to 20 Hz
- slow sweep speed, 1 to 2 Hz/s
- long sweep time, 10,000 to 20,000 s
- level output linear in dB

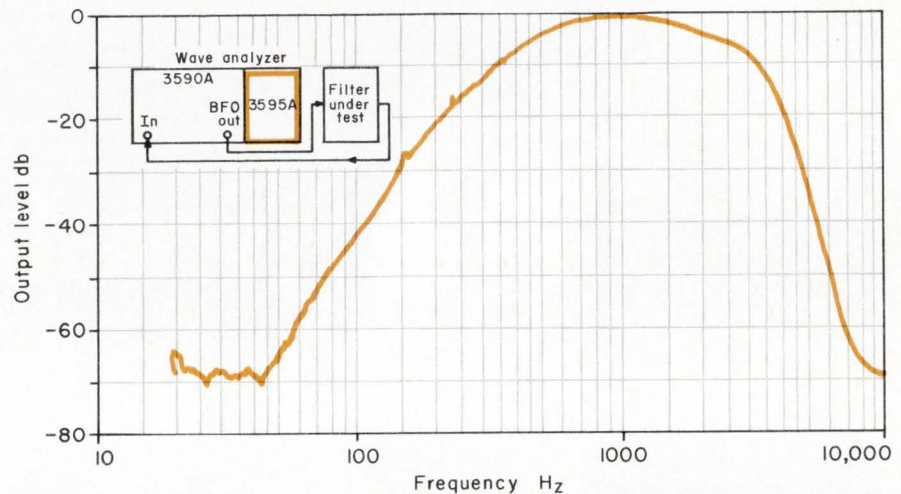

Noise weighting filters are used with rms responding voltmeters to measure noise on telephone circuits. Here is the response of one such network—called a CCITT message weighting filter—measured as shown in the inset diagram. See how the amplitude response is both measured and represented linearly in dB, and logarithmically as a function of three decades of frequency. The dynamic range could have been greater than the 70 dB shown, except that the filter is an active device and introduced noise of its own. Sweep speed was 1 Hz/s at the start, and 2 Hz/s at the higher-frequency end. Since you can switch sweep speed without undesirable output responses, you can have a full 20-kHz sweep bandwidth.

- horizontal output proportional to log frequency.

Hewlett-Packard's Model 3595A meets all of these requirements. It is a sweeping local oscillator plug-in designed for use with the manufacturer's 3590A wave analyzer and 3591A selective voltmeter.

3595A SWEEPING LOCAL OSCILLATOR

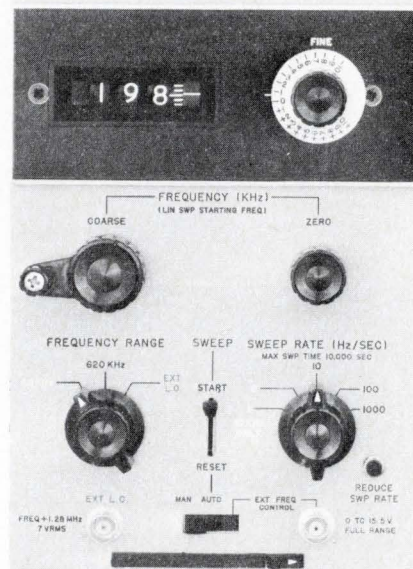

The 3595A gives you, for the first time, both electronic and manual tuning capability. You can sweep with the unit's two frequency ranges—20 Hz to 62 kHz, and 200 Hz to 620 kHz—automatically, for a maximum of 10,000 s. In other words, you can sweep a 10-kHz band at a 1-Hz/s rate.

Further, transient-free switching lets you select 1- or 2-Hz/s sweep rates at will. And you can special-order an extension of this switching capability into the 10-Hz/s range. The variable sweep rate lets you sweep uninteresting portions of the band under observation at a rapid rate, and those of interest at a slow rate.

In short, the 3595A combined with the 85-dB dynamic range of the 3590A lets you examine audio frequencies in a manner previously possible only with complex arrays of instrumentation.

The Model 3595A will be available in the Spring, and will sell for \$1375. 90 day delivery. For more information, contact Inquiries Manager, Hewlett-Packard, 1501 Page Mill Rd., Palo Alto, Calif. 94304. (415) 326-7000. **Circle 210 on Inquiry Card**

# Guess the price of HP's new counter

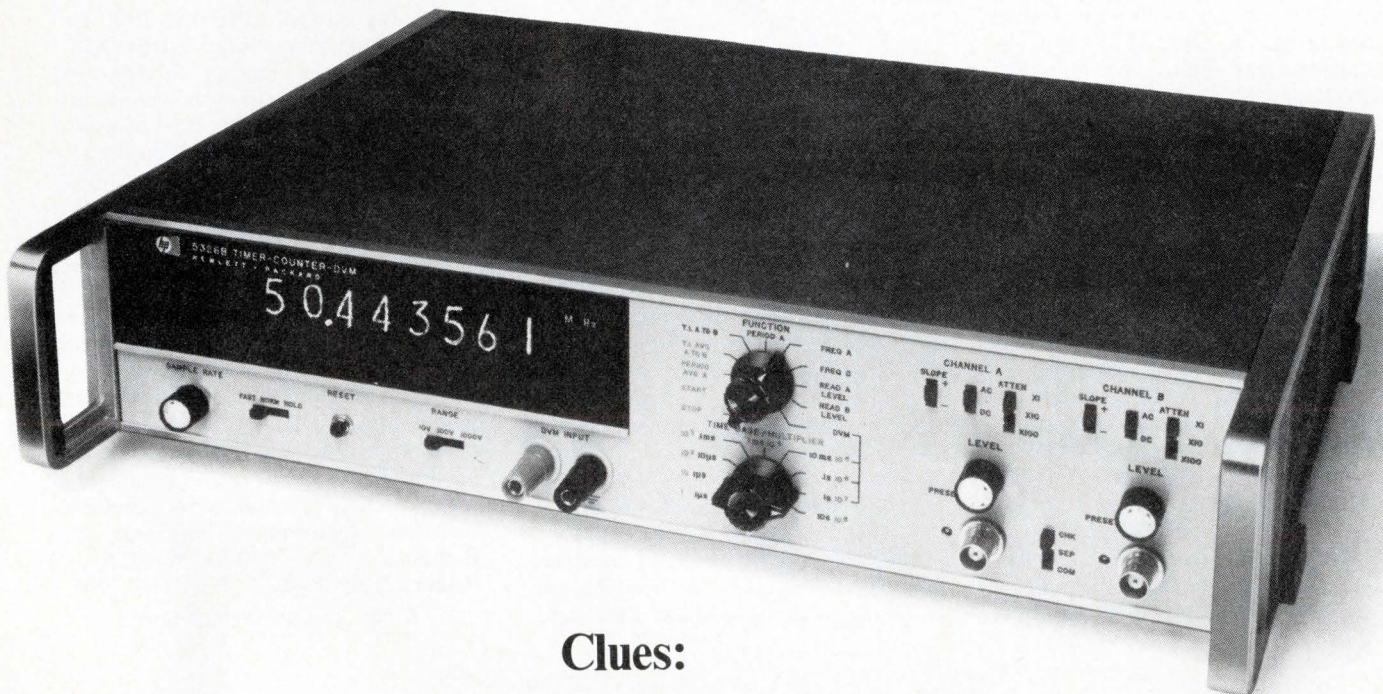

## Clues:

**it averages time intervals to 10 picoseconds**  
**it has a built-in 0.05% integrating DVM**  
**it's dc to 50 MHz, CW or burst**  
**its counter and DVM are easily programmable**

Surprise: \$1550. That modest amount buys a Hewlett-Packard timer/counter that does things universal counters never did before. For example, it averages time intervals as short as 0.15 nanoseconds. So you can resolve to 10 picoseconds on repetitive signals.

That modest sum also buys a counter with a built-in integrating digital voltmeter. So it's the only counter that can measure internal trigger level settings or other inputs with DVM precision. Now you can measure 10 to 90% rise times, half power points and other voltage-dependent time intervals. That means unprecedented simplicity, for example, in propagation

delay measurements. The counter also features four integration times. As a DVM, it provides three voltage ranges, 60 dB noise rejection and 0.05% accuracy.

Even without these exclusive features, the 5326's are real bargains. They count to 50 MHz direct with seven-digit resolution (eight digits optional), measure period and multiple period average and scale input frequencies by any power of 10 up to  $10^8$ . They measure ratio and they totalize.

With programming and BCD output options, the 5326's fit easily into systems applications. Counter and DVM are DTL programmable through a common connector.

You can get all of these benefits in the 5326B for \$1550, or buy the same counter, less the DVM, in the 5326A for \$1195. Any way you look at the 5326 A or B—either is a great counter value. Your local field engineer has all the facts about HP's new IC counter line. Give him a call or write to Hewlett-Packard, Palo Alto, California 94304; Europe: 1217 Meyrin-Geneva, Switzerland.

**HEWLETT  PACKARD**  
ELECTRONIC COUNTERS

02003

## New graphic recorder

### Is X-Y, strip and T-Y in one package.

A new Omnigraphic™ graphic recorder line (2000/3000 series) with a convertible chassis and plug-in expandability will replace previous flat bed X-Y and T-Y recorders.

In this new concept, one main frame is basic to a broad line of X-Y, strip chart, and T-Y recorders. The resulting reduction in production costs means a lower price for the series. There are two models being offered.

Model 2000 (\$770) is a basic X-Y main frame suitable for OEM and dedicated applications. It can be expanded to meet almost any user requirements by means of a variety of plug-in modules without modifications.

Model 3000, with a price of \$710 (plus modules), features multiple speeds and a wide choice of input functions from a variety of plug-in modules. Electric pen lift event marker and positive paper feed or roll take-up are standard. It has nine pushbut-

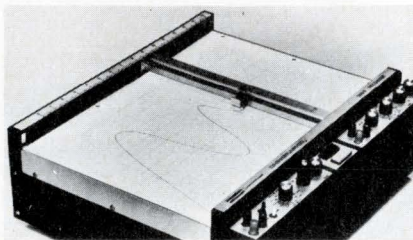

ton selected digital chart speeds and instantaneous reaction as there are no gear transmissions or clutches. Both recorders feature true differential input—they measure from any type of source up to  $\pm 500$  V from ground. Isolation and common mode rejection are good enough that shields and guards are not needed. Overshoot is not discernible on normal step inputs. It is  $< 1\%$  on full scale step inputs.

Thirteen plug-in modules available include dc coupler, dc ranging, dc switching with or without time base,

and dc preamplifier. The modules easily plug into all 2000 and 3000 recorders. They range in price from \$25. And here is a unique feature—a warranty that lets you exchange an unused module for another type of module and receive up to 90% credit towards the new module. It allows 90% credit on modules exchanged within 30 days; 85% credit within three months; 65% credit within 6 months; and 25% credit, within one year, toward purchase of a new module. Thus, if your needs change after you purchase a recorder for a certain function, you can exchange plug-in modules on this recorder for any other module made by the company. The same recorder would then meet application requirements for the new function. Houston Instrument, Division of Bausch & Lomb, 4950 Terminal Ave., Bellaire, Tex. 77401. (713) 667-7403.

Circle 264 on Inquiry Card

## Optically coupled isolators offer high speed switching

Two new high-speed switching units have been added to Texas Instruments' solid state optically coupled isolator (OCI) line. Each consists of a GaAs diode light source optically coupled to a silicon phototransistor. Both are compatible with Standard TTL and DTL.

Functionally, these isolators—the TIL107 and TIL108—are similar to relays and transformers because they offer a pair of input and output terminals with high electrical isolation. However, instead of using a magnetic field for signal transfer, they operate through internal light coupling—the input diode is electrically isolated from the output phototransistor. Their high voltage isolation of  $\pm 1$  kV makes them capable of replacing low power relays and pulse transformers. And, they are 1000 times faster. An advantage over

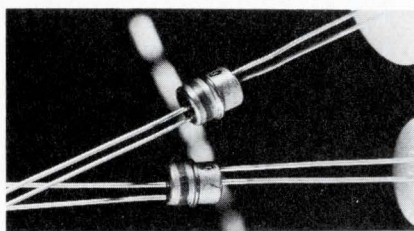

mechanical relays is that they have no moving parts or fragile wiring. An advantage over transformer counterparts is their lower frequency response which extends to dc. They also let you eliminate other associated circuitry.

They are useful as interface elements between systems where dc isolation is needed to eliminate ground loops and spurious noise. They can also be used as voltage regulators and line driver-receiver combinations in computer

peripherals and military communications.

Other features are their small size—0.206 x 0.220 inches in diameter, and the offsetting TCs of the phototransistor and LED. The offsetting TCs give them a stable output over a wide temperature range. Typical dc transfer ratios are 0.1 for the TIL107 and 0.2 for the TIL108. Packaged in an inverted two-lead TO-18 can, the ss isolators provide internal resistance  $> 10^{13} \Omega$  and a coupling capacitance of 0.4 pF.

Available from distributor and TI stock with two weeks delivery after receipt of order. TIL107 is \$6.00 (100 piece quan.) and TIL108 is \$10.00 (100 piece quan.). Texas Instruments Incorporated, Box 5012, M/S 308, Dallas, Tex. 75222.

Circle 265 on Inquiry Card

# USE TRON RECTIFIER FUSES TO PROTECT

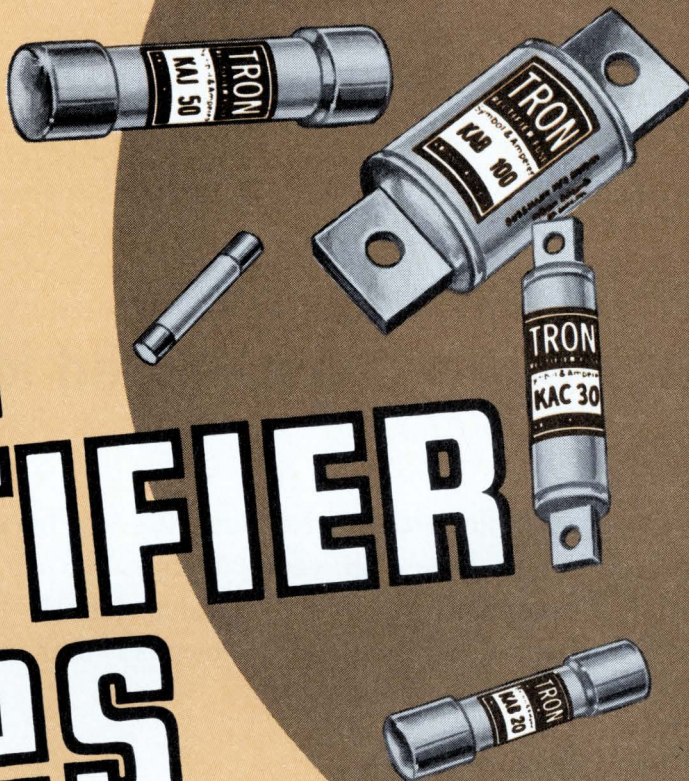

**VARIABLE SPEED DRIVES**  
... as used in machine tools and conveyor controls.

**INVERTERS**  
... wherever it is necessary to produce alternating current from direct current, such as non-interruptable power supplies.

**BATTERY CHARGERS**  
... used to charge batteries of industrial trucks, forklifts, etc.

**PLATING POWER SUPPLIES**  
... used to furnish direct current for electro-plating processes.

**POWER CONTROLS**  
... as used for heating, cooling and temperature control applications.  
... or wherever a fast-acting fuse is needed in the protection or isolation of electronic or electrical components.

*TRON fuses offer you a complete line—1/2 to 1000 amps.—voltages up to 1500.*

They are designed for the protection of solid state devices such as semi-conductor rectifiers, thyristors, SCR's—wherever extremely fast opening and great limitation of let-through current is needed.

*For full information on TRON Rectifier Fuses and time-current characteristic charts, write for BUSS Bulletin TRFS.*

**BUSSMANN MFG. DIVISION,  
McGraw-Edison Co.,  
St. Louis, Mo. 63107**

SUPPLIED THE ECONOMICAL WAY  
THRU DISTRIBUTORS  
**BUSS QUALITY**  
FUSES

**FOR FUSES AND FUSEHOLDERS OF UNQUESTIONED HIGH  
QUALITY FOR EVERY PROTECTION NEED...**

## Latch on to phase-locked loops

**The first monolithic, phase-locked-loop ICs are here. A big system on a little chip, each package holds all the components of the classical loop: phase comparator, error amplifier, lowpass filter, and VCO.**

Do you remember what got the linear IC market really moving? Sure you do. It was the first good monolithic op amp—the 709—about five years ago. Since then, process and design improvements have made the IC op amp the workhorse in applications not even dreamed of at its misty beginnings.

Well, we may be witnessing the start of another design revolution, because a new component has been born—the phase-locked loop in a monolithic structure. This means that an old concept, dating back nearly 40 years, is now a workable product: its cost and performance promise to be competitive with traditional ways of doing things.

What things? As a starter, phase-locked loop applications fall into four general classes: fm demodulation; signal conditioning; frequency multiplication and division; and a-m detection. And the real kicker here is that with these new monolithics, you need no tuned circuits. You've finally eliminated that old bugaboo of IC design—the inductor.

(There are several ways to simulate an inductance with inductorless circuitry. One popular method is to use gyrator networks, which "turn around" a capacitor's phase shift to simulate the voltage-current relationship of an inductor. But no technique is available on a production basis.)

### Where can you use it?

At the time of this writing, the listed applications are so numerous that the data sheet is already six pages long.

#### Phase-locked loops

Suppose you set an oscillator to operate at a frequency near that of some incoming signal which you wish to operate upon. Suppose further that you mix this incoming signal with the oscillator signal in a phase comparator. Then the comparator's output is a dc level. The amplitude and polarity of this dc level are a function of how much the oscillator frequency is above or below that of the incoming signal.

Now let the oscillator's frequency be voltage controlled (VCO), and derive its control signal from the comparator's low pass-filtered dc output, via an error amplifier. You now have a closed-loop system which forces the VCO frequency to vary in such a way as to reduce to a minimum the phase difference between the incoming signal and the VCO's output.

The near-zero-phase-shift condition is called the synchronized or locked state. In this locked state, the closed loop operates as a signal-tracking filter. Thus, if the input is, say, an fm signal, then the loop's dc error variations represent the recovered modulation of the input. Similarly, because the VCO tracks the input signal, the VCO's output is a reconstituted version of the loop's input.

But to give you some idea of what's practical with these devices, here is a small sampling of uses.

As frequency-selective fm demodulators, you can use these new ICs to perform as i-f strips and sound detectors for broadcast fm and tv receivers, as SCA detectors at 67 kHz, and as high-linearity detectors for very-wideband fm detectors. You can also use the devices to filter and demodulate multiplexed fm telemetry signals. Or, because the circuit can detect tones, you can build simple, but effective, paging receivers.

As a signal conditioner, the phase-locked loop can be used to synchronize signals, and to reconstitute or track noisy or unstable signals. For frequency-selective a-m detection, you can use a phase-locked loop as a coherent detector.

How about frequency multiplication and division? No problem. You can generate a wide range of frequencies which are integer multiples or submultiples of the input reference signal. And the output will have the same percentage of accuracy and stability as the input reference.

### Neat trick

Perhaps you need a data terminal. OK. Take an acoustic coupler and a touch-tone telephone unit. After you dial the computer central and tell it

*(continued on page 104)*



# 400 Hz Solid State Relays

for military & commercial aircraft

## Originators



**TO-5 Relays**

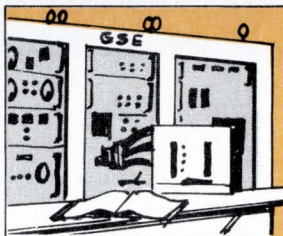
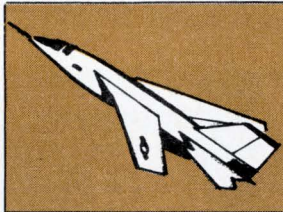
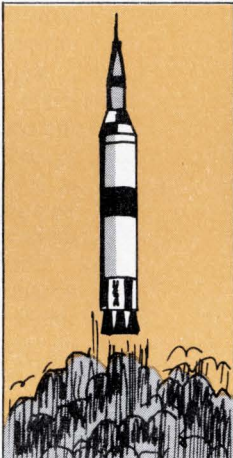

**Solid State Relay**

The originators of TO-5 relays announce another first! Solid state relays that meet or exceed all categories of MIL-STD 704A. Transient protected on input and output. Features include an ultra-sensitive "coil" (compatible with 5 volt logic systems, such as TTL), and a zero-voltage switching option to minimize RFI. They can switch over 5 KW, resistive or inductive loads (50-500 Hz). Extremely high reliability and maintenance-free operation

make them ideal for aircraft control and power system applications. Three input "coil" ranges are available, 3-8 VDC, 7-85 VDC and 90-230 VAC. Features include low contact resistance (50 milliohms typical) and contacts capable of withstanding overloads 1000% above ratings. Lack of moving contacts prevents arcing, permitting switching in explosive atmospheres, controlling motors, solenoid valves, actuators, transformers, etc.

The high contact surge rating is ideal for lighting control systems (5000 watts of tungsten lamps can be switched). For complete technical data on our 400 Hz Series 6 Solid State Relays and solutions to your 400 Hz power switching problems, contact

  
**TELEDYNE  
RELAYS**

3155 West El Segundo Blvd. Hawthorne, Calif. 90250  
Telephone (213) 679-2205

# ONLY VISHAY MAKES TRIMMERS WITH ALL THESE SPECS

**lowest  
temperature  
coefficient** **10**  
PPM/°C  
(-55°C to +150°C)

**lowest  
resistance  
values** **DOWN TO**  
**2Ω**

**lowest  
dynamic  
noise** **10Ω**  
ENR MAX.  
THERMAL NOISE  
NON-MEASURABLE

**lowest  
setability  
& stability** **LESS THAN**  
**.05%**  
"INFINITE RESOLUTION"

Vishay puts the state-of-the-art performance of its fixed resistors into trimming potentiometers! Here, for the first time is a combination of precision/stability/TC/resolution which eliminates the need for padding resistors, decreases test time, improves product performance — and YES! Vishay trimmers meet or exceed all requirements of MIL-R-27208 and/or MIL-R-22097 characteristic C. Send for your free copy of Bulletin TR-101 describing this new line of total performance trimmers.



## VISHAY RESISTOR PRODUCTS

A DIVISION OF VISHAY INTERTECHNOLOGY, INC.  
63 LINCOLN HIGHWAY ■ MALVERN, PA. 19355

PRECISION RESISTORS • NETWORKS • DECADE BOXES • TRIMMERS

*Cont. from page 102*

what you want it to do, you switch to FSK to transmit your data. Well, the IC phase-locked loop decodes such data automatically and, level-shifted through a transistor into a TTL gate, gives you a complete digital interlock right into the computer.

The loop also can regenerate the FSK data for transmission back to you. So a data set with a phase-locked loop and some logic gives you a bilateral system without an electrical connection to the telephone line.

### Two so far

The devices announced to date are the NE560B and the NE561B. The difference between the two is that the 561 has an internal phase-shifter which makes things a bit more handy for a-m detection. Both devices are otherwise useful for all the applications described.

The ICs operate from about 1 Hz to 60 MHz. You determine the frequency simply by setting an external capacitor. Useful input levels range from 100 μV to 1 V—a dynamic range of 80-dB.

The 100-μV sensitivity figure is specified for a 75-kHz fm deviation at 10.7 MHz. But note that you can drive the units differentially, which means that you can (effectively) double the sensitivity, that is, the 100-μV figure drops to 50 μV.

You can adjust the bandpass to ±1% of the center frequency, and the tracking range is similarly variable to ±20%. Third-harmonic distortion is 1% max. Power supply voltage can be anything between 15 and 26 V, and dissipation is 160 mW or less at 18 V.

Chip size is 68 x 72 mils, and the 45 active elements are all npn bipolar transistors. All circuits are built using dielectric isolation techniques.

A word about temperature stability. Frequency drift with temperature is specified as 1200 ppm/°C max., 600 ppm/°C typ. But in consumer/industrial applications, ambient changes are often not very large. And remember that once the loop locks, the stability of the output is solely a function of the input (reference) signal stability. In any case, the in-lock stability is still comparable to the best that you can achieve with resonant circuits.

What do these new devices cost? In 100-up quantities, the NE560B goes for \$18 each, and the NE561B is \$22. For more information, contact Signetics Corporation, 811 East Arques Ave., Sunnyvale, California 94086. (408) 739-7700.

Circle 266 on Inquiry Card

# CALL FOR PAPERS

## COMPUTER DESIGNER'S Conference & Exhibition

FOR THE MEN WHO DESIGN ANALOG/DIGITAL/HYBRID  
COMPUTER SYSTEMS & SUBSYSTEMS

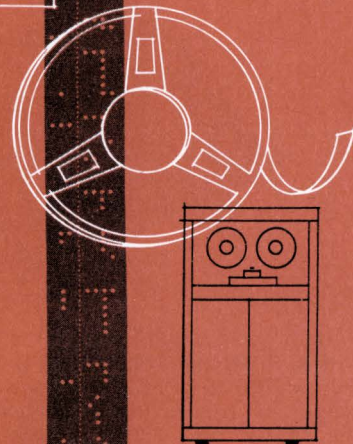
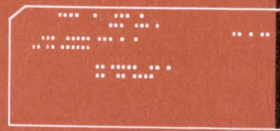

### You are invited...

to present a paper to the anticipated 15,000 computer engineers and scientists who will attend the first, national **COMPUTER DESIGNER'S CONFERENCE**— Anaheim Convention Center, Anaheim, California, January 19, 20, 21, 1971.

The Papers Committee is specifically interested in seeing 300 to 500 word abstracts detailing your new computer design developments, component applications and design techniques.

Abstract deadline is June 1, 1970; announcement of accepted papers will be made on August 1, 1970, and the completed paper, ready for publication will be due on December 1, 1970.

### Your Paper Delivered at This Conference can Advance Your Career

1. **YOUR PAPER BECOMES A PERMANENT PART OF THE REFERENCE MATERIAL ON COMPUTER DESIGN**—because every Technical Paper delivered at the conference will be published in a hardbound edition of the Conference Proceedings. This published work will be carried by the major technical libraries in the United States, Canada, Europe, United Kingdom and Japan.
2. **YOU WILL ACHIEVE PERSONAL RECOGNITION**—because your work will be brought to the attention of your company management.
3. **YOU AND YOUR COMPANY WILL BE RECOGNIZED AS LEADERS**—because of the favorable notice given to design work of sufficiently high caliber as to be selected for presentation at a nationwide conference.

### WHERE TO SUBMIT YOUR ABSTRACT

To participate in the first nationwide Computer Designer's Conference, submit your abstract, in triplicate, (300 to 500 words) to:

Technical Papers Committee, Computer Designer's Conference,  
222 West Adams, Chicago, Illinois 60606

### Suggested General Subject Areas...

Logic Design  
Systems Engineering  
A to D and D to A Converters  
Interconnection Systems  
Peripheral Systems and  
Accessories  
Input-Output Buffers  
Memories, Fixed, Erasable  
Circuit Design  
Test & Check-Out Equipment  
Information Display  
Data Acquisition  
Time Sharing Systems  
Serial/Parallel Converters  
Optical Computers  
Graph Plotters  
Printers  
Remote Terminals  
Multiplexers, Shift Registers  
Microprogramming  
Mechanical Computers  
Hybrid Computers  
Pattern Recognition  
Specialty Languages  
Analog Memories  
Digital Memories  
Memories (Semiconductor,  
Magnetic, Mechanical, Optical)

## NEW MICROWORLD PRODUCTS

### HIGH GAIN VIDEO AMPS

Hybrid units operate from  $-55$  to  $80^{\circ}\text{C}$ .

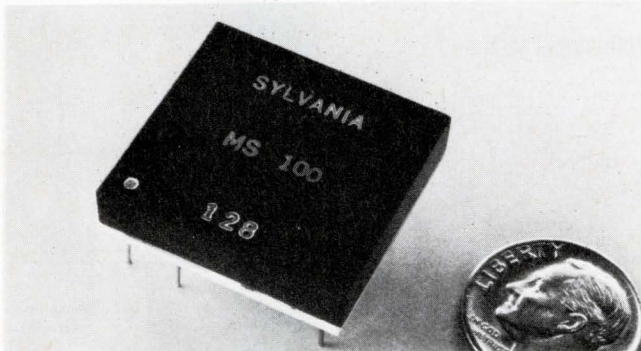

Both these amplifiers have an open loop gain of 50 dB with a 3 dB bandwidth of 1.0 MHz. Each amplifier can deliver 700 mW of output power and has an open loop output impedance of  $33\Omega$ . Slew rates are  $100\text{ V}/\mu\text{s}$  for the MS100 and  $180\text{ V}/\mu\text{s}$  for the MS100A. The units provide short circuit protection at the output and they are rated over the temperature range of  $-55$  to  $80^{\circ}\text{C}$ . The amplifiers are in a  $1\text{ in.}^2$  by  $0.200\text{ in.}$  thick package. In quantities of 1 to 49, price is \$52 ea. with off-the-shelf delivery. Sylvania Electric Products Inc., 40 Sylvan St., Waltham, Mass. 02154.

Circle 270 on Inquiry Card

### TTL UP/DOWN COUNTERS

Said to be lowest priced in the industry.

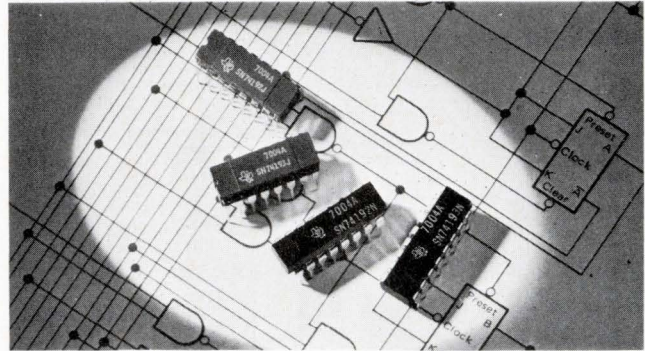

These MSI circuits are designated the SN54/74192, a 4-bit binary counter and the SN54/74193, a binary-coded decimal (BCD) counter. The devices consist of four J-K toggle flip-flops; one input buffer each for down, up, clear, and count/load control, one NAND gate each for borrow and carry outputs; and eight preset/clear NAND gates. Both units are available in 16-pin plastic (N suffix) and ceramic (J suffix) dual-in-line packages. Prices in 100-999 quantities, range from \$7.70 ea. to \$26.31 ea. Delivery is 3 weeks. Texas Instruments Incorporated, Inquiry Answering Service, Box 5012, M/S 308, Dallas, Tex. 75222.

Circle 272 on Inquiry Card

### DIGITAL DECODER/DRIVER

Drives 7-segment fluorescent readouts.

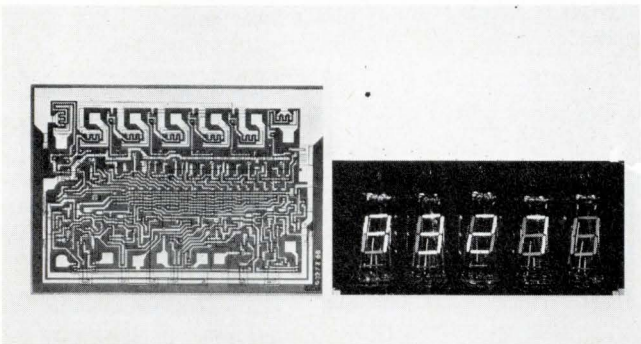

This bipolar decoder/driver can drive a 7-segment vacuum fluorescent numerical display directly. The MSI 9327 accepts four inputs in 8421 BCD format and generates appropriate outputs for the readout. The device comes in two models. The 9327A which has an output breakdown voltage of 64 V, can multiplex up to 12 readouts and can be used effectively in time share systems. The 9327B, with a lower breakdown voltage of 30 V, is used for driving Dual-In-Line packages and flatpacks. Prices range from \$8.00 to \$10.45 ea. (100-999 pcs.) Fairchild Semiconductor, 313 Fairchild Dr., Mountain View, Calif. 94040. (415) 962-3563.

Circle 271 on Inquiry Card

### N-CHANNEL READ ONLY MEMORY

In a 256-word by 2-bit format.

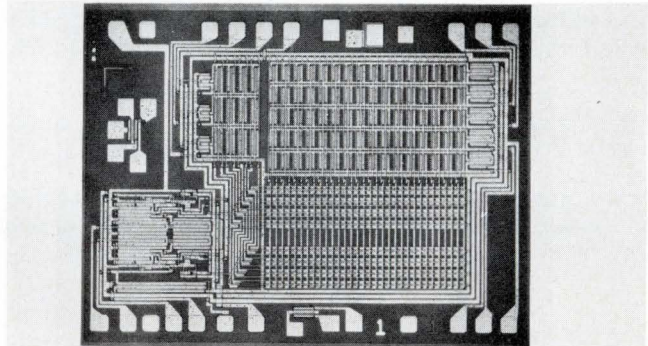

The ICM6008 contains all the decode electronics, memory storage devices, and the output drivers (which can be wired-ored). You can parallel the arrays, thereby making the memory expandable, both in the number of words (in multiples of 256), and in the number of bits/word (in multiples of 2). Operating speed is greater than 3 MHz over the industrial temperature range and the unit interfaces directly with bipolar logic. True zener diode protection is provided on all inputs and outputs. It's in a 16-lead ceramic DIP and costs \$45 ea. in quantities of 1-99. Intersil Inc., 10900 N. Tantau Ave., Cupertino, Calif. 95014. (408) 257-5450.

Circle 273 on Inquiry Card

### LADDER SWITCH

For D/A applications.

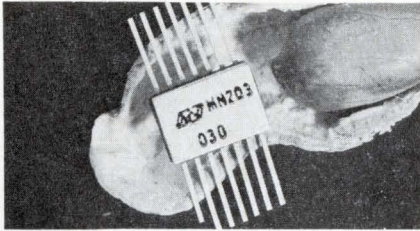

The MN203 contains a pair of SPDT switches designed to drive R/2R ladder networks. The input is compatible with monolithic logic circuits and the output delivers ground or 10 V to the ladder network. The unit has an offset of 2 mV max. and a series resistance of 20  $\Omega$  max. In lots of 250, price is \$36. Micro Networks Corp., 5 Barbara Lane, Worcester, Mass. 01604.

Circle 274 on Inquiry Card

### MATCHED PAIR TRANSISTORS

On a 20-mil square chip.

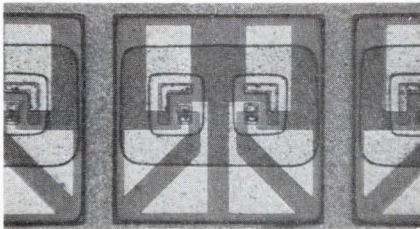

This Series includes the DI 4044/4878, DI 4100/4879 and DI 4045/4880 where the DI prefix identifies the equivalent 2N transistor for which each is designed. These transistors feature dielectric isolation, a high dc gain, and close parameter match from 10  $\mu$ A to 1 mA. Dionics Inc., 65 Rushmore St., Westbury, N.Y. 11590. (516) 997-7474.

Circle 275 on Inquiry Card

### DECODER/DRIVER

BCD to 7 outputs.

Each output of the FTD-1001 has a 30 V, 120 mA continuous drive capability and the max. package power dissipation is 1 W. Each collector output is uncommitted and the circuits are fully TTL and DTL compatible. Unit price is \$12.50 in 1-99 lots. Fabri-Tek Micro-Systems, Inc., 1410 S.W. 3rd St., Pompano Beach, Fla. 33060. (305) 943-9440.

Circle 276 on Inquiry Card

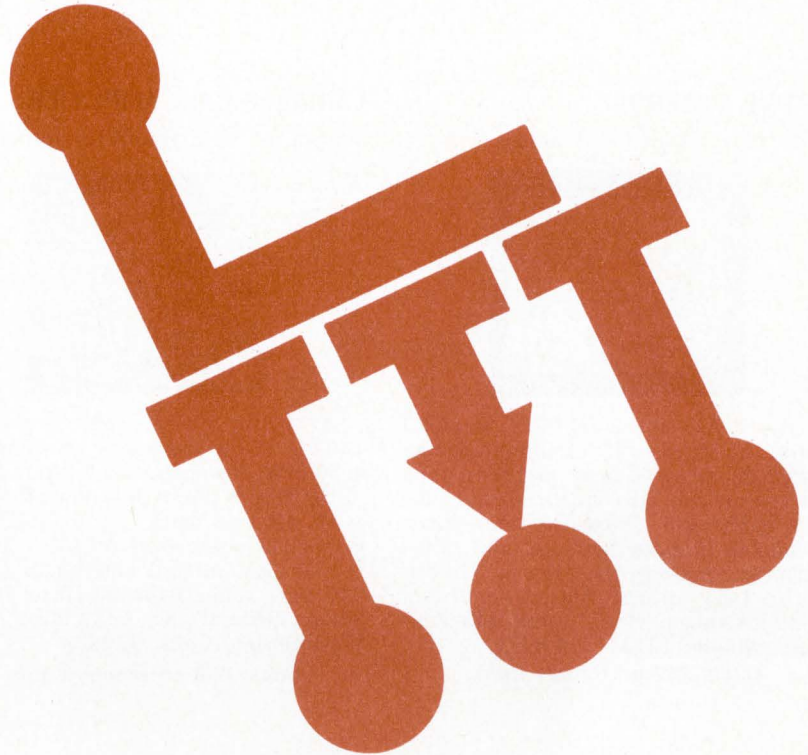

# RELIABILITY: The Word for MOS at AMELCO

When we decided to introduce our first MOS product, the most important consideration was reliability. Before the first device went out the door, there were 1,000,000\* hours of high temperature (125°C) stress (reverse bias) testing backing it up.

The reason for this stability is our **ADVANCED THICK OXIDE** over the "P" region, where it counts! This provides:

- Elimination of pinholes
- Low dielectric stress levels over "P" region
- Low capacitance
- High speed operation (10 MHz)
- Elimination of cross talk
- Unlimited life

Now available — off the shelf — in P-Channel (Type C):

2N4065 single transistor	3400	5-channel	Multiplexer
2N4066 dual transistor	3705	8-channel	Multiplexer
2N4067 dual transistor			
2N4120 single transistor			

We have low voltage (TTL compatible) and standard MOS voltage custom projects on stream. That's the beauty of our **ADVANCED THICK OXIDE** process. We can apply it to your needs — give us a call.

\* Device hours on one thousand 2N4066/7



TELEDYNE

## AMELCO SEMICONDUCTOR

1300 Terra Bella Ave., Mountain View, California (415) 968-9241 • Westwood, Massachusetts (617) 326-6600  
Orlando, Florida (305) 423-5833 • Ridgely, New Jersey (201) 943-4700 • Des Plaines, Illinois (312) 439-3250  
Anaheim, California (714) 635-3171 • Wiesbaden, Germany 372820

## NEW MICROWORLD PRODUCTS

### ACTIVE FILTERS

With power gain in all modes.

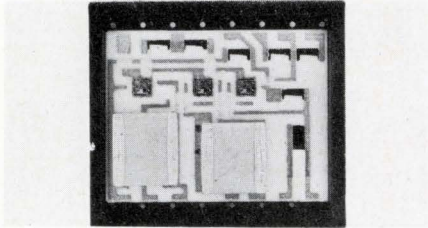

The VAF-100 is a state variable active filter capable of simultaneous bandpass, lowpass and highpass outputs. You can also independently adjust bandwidth, frequency and gain. Available in both hermetic and non-hermetic versions, the price is \$24.50 each, 1-24 pieces. Varadyne, Inc., 2330 Michigan Ave., Santa Monica, Calif. 90404. (213) 394-0271.

Circle 267 on Inquiry Card

### VARIABLE GAIN AMPLIFIER

With a 50 MHz frequency response.

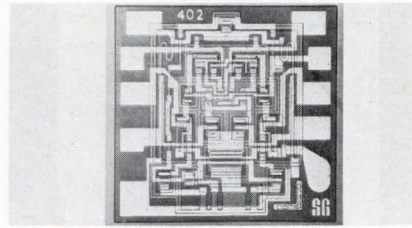

At 10 V, typical gain of the SG 1402 is 25 dB and power consumption is 50 mW. You can vary the gain from 25 dB at zero phase shift down through -24 dB and back up to +25 dB through a phase shift of 180°. Three versions are offered and prices (100-249 pcs) range from \$2.10 to \$9.95. Silicon General, Inc., 7382 Bolsa Ave., Westminster, Calif. 92683.

Circle 268 on Inquiry Card

### HIGH SPEED ANALOG SWITCH

Operates directly from logic.

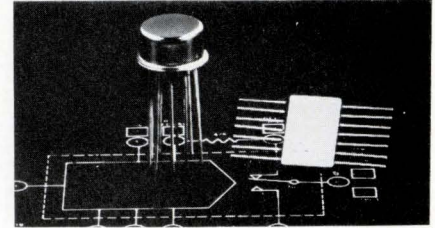

The CDA18 is a SPDT switch and driver circuit designed for use as an ultra high speed D/A switch with R/2R ladder networks or as a general purpose analog gate. This circuit has a max. turn-on time of 20 ns (12 ns typ.), and a max. on-resistance of 50 Ω (35 Ω typ.). Crystalonics, A Teledyne Co., 157 Sherman St., Cambridge, Mass. 02139. (617) 491-1670.

Circle 269 on Inquiry Card

- SPRING-LOADED CONTACTS DESIGNED TO BE PLUGGED INTO A MATING SOCKET

- PATENTED BIASING BALL CONSTRUCTION PROVIDES CONTACT BETWEEN PLUNGER AND LINING OF BARREL.

- LOW AND UNIFORM RESISTANCE

- ROUND, CONICAL & FLAT TIPS

- REPLACEABLE POGOS ARE AVAILABLE FOR CENTERLINE SPACING OF .050" UPWARD

- SINGLE, BOARD MOUNTED OR COMPLETE ACTUATING SYSTEMS

- GOLD-PLATED

- LONG LIFE

**New**

**REPLACEABLE**

**POGO  
Contacts**

Tel. (617) 222-3726

**Pylon**

PYLON COMPANY, INC. — 57 Newcomb St.  
Attleboro, Massachusetts 02703

## Motorola temperature compensated crystal oscillators



**Come in small packages  
Do a big job**

Where low power, small size and instant warm-up are required, choose a Motorola TCXO. They're ideal for a wide variety of industrial applications.

**Small Size.** They come in packages as small as 1.5 cubic inch.

**Wide Frequency Range.** From 500 KHz to 40 MHz. Extended ranges on special order.

**Stability.** ± 1 ppm from 0° to + 55°C. Higher stability on special order.

**Low Aging.** Less than 1 × 10<sup>-6</sup> per year.

And if you need a non-standard TCXO, just let us know. Variations in input voltage, frequency, output level and wave shape are available on special order.

For complete information, send for your free copy of Bulletin TIC-3213 today. Write Component Products, Dept. 40F, Motorola Communications & Electronics, Inc., 4501 W. Augusta Blvd., Chicago, Illinois 60651; or call (312) 772-6500.



Circle 56 on Inquiry Card

# LINEAR

## One more time:

*Fairchild built a reputation on new products, new technology and new applications. Last month we ran the editorial below. It announced another new step for Fairchild. A commitment to do business wherever there's business. First source. Or second. It was a major policy decision for us. So major, in fact, we're repeating the editorial this month.*

### EDITORIAL

#### **If We Can't Sell You Ours, We'll Sell You Theirs.**

For a long time, Fairchild built only linears designed by Fairchild engineers. We didn't think anything else was worth the effort. People said we had an NIH (Not Invented Here) complex. And, they were right.

However, it's been brought forcefully to our attention that a couple other guys in this business know what they're doing. The competition is coming out with some pretty worthwhile linears. Our customers have noticed too, because they're talking to other manufacturers about linears we don't make. They're even talking to sole sourcers!

To keep things even, we've decided to give our wandering customers something they're going to need if they start dealing with a sole source linear maker: A second source. Us. (Just in case the original supplier's factory blows up or they lose the formula or whatever it is that happens when you can't get delivery.)

Starting now, Fairchild is introducing a new line of linears. We call them IT circuits (Invented There). The first two are available today: The LM101 and the MC1495. Soon we'll add the LM101A, MC1496 and the SN7524. Of course, we've given them Fairchild part numbers. Here's a conversion chart:

$\mu$ A795	Analog Multiplier	MC1495
$\mu$ A796	Modulator	MC1496
$\mu$ A748	Operational Amplifier	LM101
$\mu$ A777	Operational Amplifier	LM101A
$\mu$ A761	Sense Amplifier	SN7524

There will be other additions to the IT line soon. So be sure you contact your local Fairchild Sales Engineer before you drop a design for lack of a reliable alternate source. Just give him the part number you want and ask him to check the IT line. Farewell NIH.

# Application Digest

If you'd like any of the following application literature just write: Fairchild Linear Applications, Box 880A, Mountain View, Calif. 94040. Ask for it by publication number.

Publication Number	Title
138	$\mu$ A725 Instrumentation Applications
134	The Frequency Division Multiplex Channel Amp with the $\mu$ A748
131	An Arithmetic Analog Computer using $\mu$ A735 Logarithmic Amplifier
129	Low-Pass Active Filter for Electronic Imaging using the $\mu$ A715
125	Applications of the $\mu$ A749 Dual Operational Amplifier
141	$\mu$ A742 (TRIGAC) AC Power Control Handbook
164	Applications of the $\mu$ A722 10-Bit Current Source
136	Low-Drift, Low-Noise Monolithic Operational Amp for Low Level Signal Processing — $\mu$ A725
133	More Voltage Regulator Applications using the $\mu$ A723
128	A High Speed Sample and Hold using the $\mu$ A715
126	The $\mu$ A749 Dual Operational Amplifier
123	A Micropower Monolithic Op Amp — $\mu$ A735
99	$\mu$ A733 Oscillators
140	$\mu$ A731 High Speed Dual Channel Sense Amplifier
130	$\mu$ A725 AGC Amplifier
127	A Trapezoidal Deflection Circuit for use with the 3250 Numeric Character Generator using the $\mu$ A715
111	A High Speed, Zero Input Current Chopper Amp — $\mu$ A715
119	A High Speed Differential Preamp for Thin Film Memories — $\mu$ A751
124	The $\mu$ A746E Color TV Chroma Demodulator IC
183	A Low-Noise Preamplifier — $\mu$ A741
175	The $\mu$ A739 — A Low-Noise Dual Operational Amplifier
122	A Monolithic Radiation-Resistant Operational Amp — $\mu$ A744
171	Applications of the $\mu$ A739 and $\mu$ A749 Dual Preamplifier Integrated Circuits in Home Entertainment Equipment

# Fairchild Cuts Prices of Ten Popular Linears

Say goodbye to modules.

New prices on Fairchild's most popular Linear ICs now make modules expensive as well as bulky.

## The Price Story:

DEVICE TYPE	ORDERING CODE	TEMPERATURE RANGE	OLD PRICE 100-999	NEW PRICE* 100-999
$\mu$ A715	U5F7715312	-55°C to +125°C	\$48.00	\$30.00
$\mu$ A715C	U5F7715393	0°C to +70°C	15.00	7.95
$\mu$ A722	U3M7722333	-20°C to +85°C	65.00	37.50
$\mu$ A722B	U3M7722334	0°C to +55°C	50.00	22.50
$\mu$ A725	U5B7725312	-55°C to +125°C	48.00	37.50
$\mu$ A725B	U5B7725333	-20°C to +85°C	37.50	25.00
$\mu$ A725C	U5B7725393	0°C to +70°C	—	15.00
$\mu$ A735	U5B7735312	-55°C to +125°C	48.00	37.50
$\mu$ A735B	U5B7735333	-20°C to +85°C	37.50	25.00
$\mu$ A735C	U5B7735393	0°C to +70°C	—	15.00

\*Call your local Fairchild distributor or Field Sales office for even lower volume prices.

## The Performance Story:

**$\mu$ A715 — High Speed Op Amp**  
 100V/ $\mu$ S Unity Gain Slew Rate  
 300nS Settling Time  
 65MHz Bandwidth  
 70nA Offset Current  
 Circle Reader Service Number 122

**$\mu$ A722 — 10 Bit D/A Converter**  
 Current Source  
 $\pm 8\frac{1}{2}$  Bit Accuracy  
 10 Bit Resolution  
 600nS Switching Speed  
 Internal Precision Reference  
 Circle Reader Service Number 123

**$\mu$ A725 — Instrumentation Op Amp**  
 0.5 $\mu$ V/ $^{\circ}$ C Voltage Drift  
 128dB Voltage Gain  
 120dB Common Mode Rejection  
 0.6pA $\sqrt{\text{Hz}}$  Input Noise Current  
 Circle Reader Service Number 124

**$\mu$ A735 — Micropower Op Amp**  
 100 $\mu$ W Power Consumption  
 0.5nA Offset Current  
 10M $\Omega$  Input Resistance  
 Wide Supply Voltage Range  
 Circle Reader Service Number 125

## Win \$100

We hope you're getting your entries ready for the contest we announced last month.

Just in case you missed the announcement, here's what you have to do to enter:

1. Get all the facts on a Fairchild Linear IC.
2. Design the world's greatest application for it.
3. Send to: Fairchild Linear Contest, P. O. Box 880A, Mountain View, California 94040.

All entries will be judged by the editors of EEE Magazine. Every month, they will select the most imaginative application and give us the designer's name. We'll publish the winning design and give the winner \$100 upon publication.  
 Ready. Set. Design!



# Introducing the World's First Monolithic J-FET Input Op Amp

Punch-through op amps are obsolete.

Fairchild's new  $\mu A740$  now offers 150pA (max.) current into either input. While some manufacturers are talking about super beta or punch-through transistors with current gains of 1000, Fairchild technology now makes possible J-FET devices with equivalent betas of over 15,000. And, they're completely compatible with standard monolithic processing.

The  $\mu A740$  is a simple two-stage design similar to the  $\mu A741$ , but employs J-FET input transistors to obtain extremely low input currents.

#### $\mu A740$ Electrical Performance

Input Current. . . . . 150pA max. (either input)  
 Unity Gain Slew Rate. . . . . 6V/ $\mu$ S  
 Input Resistance. . . . .  $10^{12}$  Ohms  
 Voltage Gain. . . . . 120dB  
 Input Offset Current. . . . . 30pA

The new linear has all the convenience of the  $\mu A741$ : internal frequency compensation for unity gain, input over-voltage protection to either supply, output short circuit protection to ground or either supply, and the absence of "latch-up."

Balanced offset null is easily obtained with a 10K $\Omega$  potentiometer and does not affect other parameters.

Other  $\mu A740$  features include a wide common mode range of  $\pm 12$  volts, high differential voltage range of  $\pm 30$  volts, and wide operating supply range of  $\pm 5V$  to  $\pm 22V$ .

The  $\mu A740$  is directly interchangeable with the  $\mu A741$ ,  $\mu A748$  or  $\mu A709$ .

The new Fairchild device provides circuit designers with superior performance in such

applications as active filters, voltage followers, integrators, summing amplifiers, sample and holds, transducer amplifiers and other general-purpose feedback applications.

The  $\mu A740$  is now available in TO-99 packages (both military and industrial temperature ranges) from any Fairchild Distributor.

Circle Reader Service Number 120

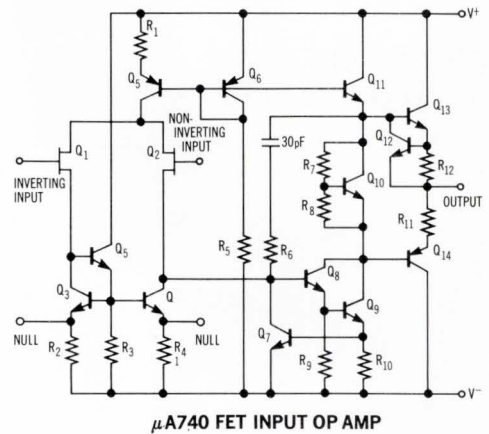

## $\mu A757$ Ideal Choice for an AGC-Able AM/IF Amplifier

Fairchild's  $\mu A757$  can be used very effectively as a high gain, wide AGC range IF amplifier. In this application, the input signal from the generator is matched to the input of the microcircuit with transformer  $T_1$ . The output of the 1st section is taken from Pin 12 across a tank circuit which acts as a load impedance. The signal is coupled through a capacitor to the input of the 2nd section, Pin 10. The output of the 2nd section is taken in a push-pull manner with transformer  $T_3$ . The secondary of  $T_3$  drives the diode detector

from which audio is recovered.  $Q_1$  acts as an AGC signal amplifier to provide gain for the AGC signal from the diode detector.

Voltage gain of the circuit from the input of  $T_1$  to the input of  $T_3$  is typically 80 dB, while the AGC range is typically 70 dB. Input signal handling capability of the microcircuit is typically 300 mV<sub>RMS</sub> at the input terminals of the microcircuit at full AGC. Stable gain is obtained over a wide temperature range, regardless of AGC setting.

Circle Reader Service Number 121

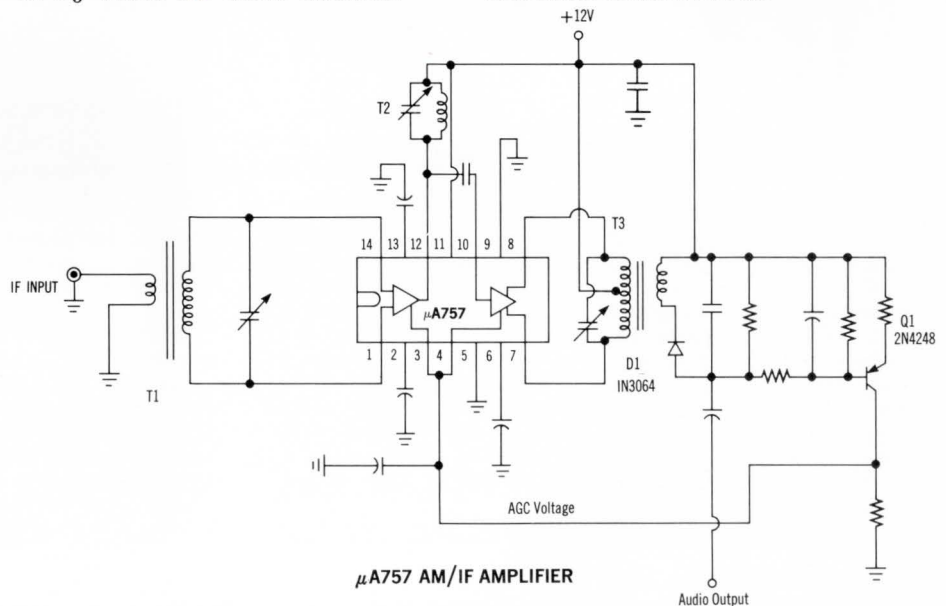

## NEW LAB INSTRUMENTS

### TIMER/COUNTER/DVM

Also averages time intervals.



Besides having all the functions of a medium-priced universal counter, Model 5326B can also average time intervals. That means it can measure repetitive time intervals as short as 0.15 ns, and it has resolution as fine as 10 ps. The instrument also has an internal integrating DVM (not a plug-in), with which it can measure its own trigger level settings. This gives you the ability to make such measurements as the 10-to-90% rise time, where the 10 and 90% points are the trigger points. The price is \$1550. The instrument is also available without the internal DVM for \$1195. Inquiries Manager, Hewlett-Packard Co., 1501 Page Mill Rd., Palo Alto, Calif. 94304. (415) 326-7000. Circle 211 on Inquiry Card

### PROGRAMMABLE MODULATION METER

Carrier frequencies from 2 MHz to 1000 MHz.

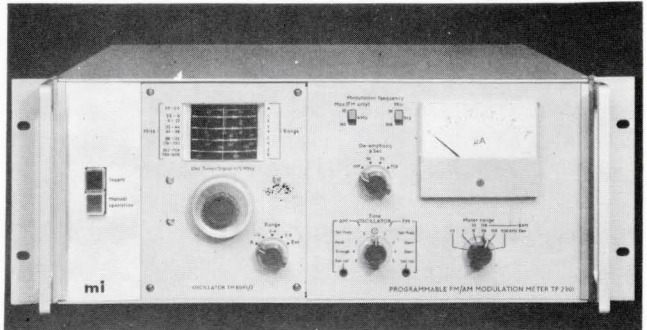

Model 2301 measures deviation in six ranges from  $\pm 1.5$  kHz to  $\pm 500$  kHz, full scale over an fm range from 30 Hz to 150 kHz. The unit also gives you the demodulated output with  $< 0.25\%$  distortion. For am applications, the 2301 measures up to 90% modulation depth at carriers from 2 MHz to 350 MHz with an analog output proportional to carrier shift. Control is by BCD where 0 = 0 to 0.8 V and 1 = 12 V  $\pm 2$  V. The measurement output is a dc analog proportional to fm deviation or am modulation. Price is \$4455 with delivery in August 1970. Marconi Instruments, 111 Cedar Lane, Englewood, N.J. 07631. (201) 567-0607.

Circle 213 on Inquiry Card

### RANDOM SIGNAL ANALYZERS

With or without on-line capability.

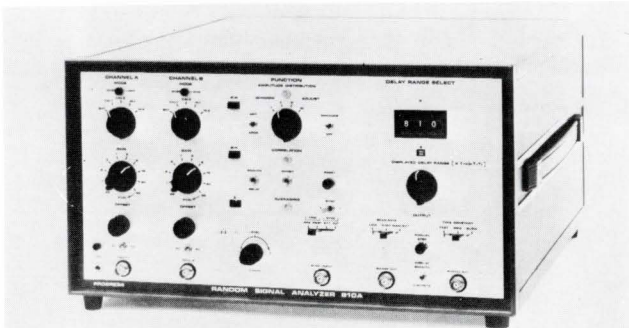

Model 810A, a real-time analyzer, can perform auto- and cross-correlation studies, amplitude probability distribution, amplitude probability density distribution and ensemble (signal) averaging. It gives you the equivalent of 9,990 lag values computed and displayed 100 points at a time. The smaller, Model 820A is similar to the 810A but without real-time capability. It computes the parameter at each delay value and reads it out before stepping to the next delay value. Prices are \$6000 to \$9500 for the Model 710A (depending on options) and \$3150 for the Model 820. Delivery is 60 days. Progress Electronics Co. of Oregon, 5160 N. Lagoon Ave., Portland, Ore. 97217. (503) 285-0581.

Circle 212 on Inquiry Card

### DIAGNOSTIC COMPUTER

For logic circuit analysis.

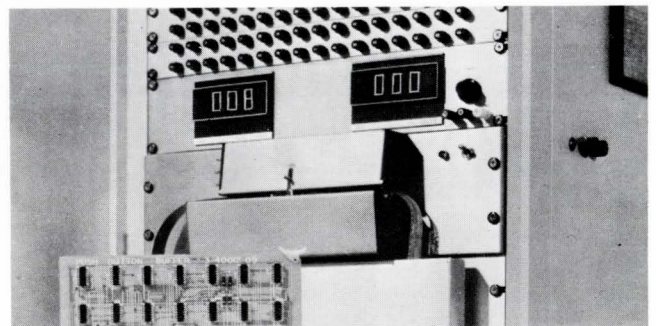

Using high speed punched tape as its program source, the DC III provides appropriate inputs and checks both the inputs and outputs of the digital device under test. Front panel displays indicate the sequence number of tests failed, together with identification of the I/O pins in error. A built-in digital voltmeter allows probing or trouble shooting, if desired. Test heads accommodate a variety of devices. The standard 64 I/O lines can be expanded to 254 if necessary. Availability is 30 to 60 days for standard units and approximately 120 days for expanded systems. Price is under \$17,000. Digital/General Corp., University Research Center, 11000 Cedar Ave., Cleveland, Ohio 44106. (206) 721-0440.

Circle 214 on Inquiry Card

The best gets better.

The HP 5248 General-Purpose Counter can now measure to 3 GHz with a single plug-in—without any gaps. This is made possible by our new 150 MHz to 3 GHz Heterodyne Converter, Model 5254C, and by extending the direct counting range of the 5248 counter mainframe to 150 MHz.

There's another benefit unique to these instruments that's not immediately apparent. Converter and counter ranges actually overlap so you derive the final answer by merely adding the converter dial reading and counter reading. There's no need to remember to subtract readings over any part of the frequency range.

Even before the latest improvements, no other counter could match the

usefulness and flexibility of the 5245 Series. We now offer fourteen different plug-ins to help you make all the measurements you need. These include six frequency converters; transfer oscillator to 18 GHz; two time interval units; two prescalers; video amplifier; DVM; and preset unit.

And you can't beat the 5245 line for reliability either. Its remarkable dependability has made it extremely popular, particularly with rental firms—some of our best customers. When their clients rent an HP counter, rental firms know they won't lose rental fees because of downtime.

The price of the new 5254C Heterodyne Converter is \$825. The

5248L counter is \$2900. You won't find a more economical single-package solution to your dc to 3 GHz counter needs. Your local HP field office has all the details. Give them a call. Or write to Hewlett-Packard, Palo Alto, California 94304; Europe: 1217 Meyrin-Geneva, Switzerland.

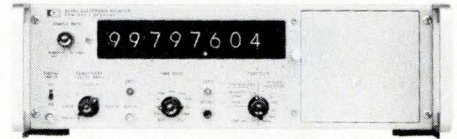

**HEWLETT**  **PACKARD**

**ELECTRONIC COUNTERS**

Circle 57 on Inquiry Card

02918

**There's a  
new reason why  
this continues to be  
the world's most popular  
counter line.**

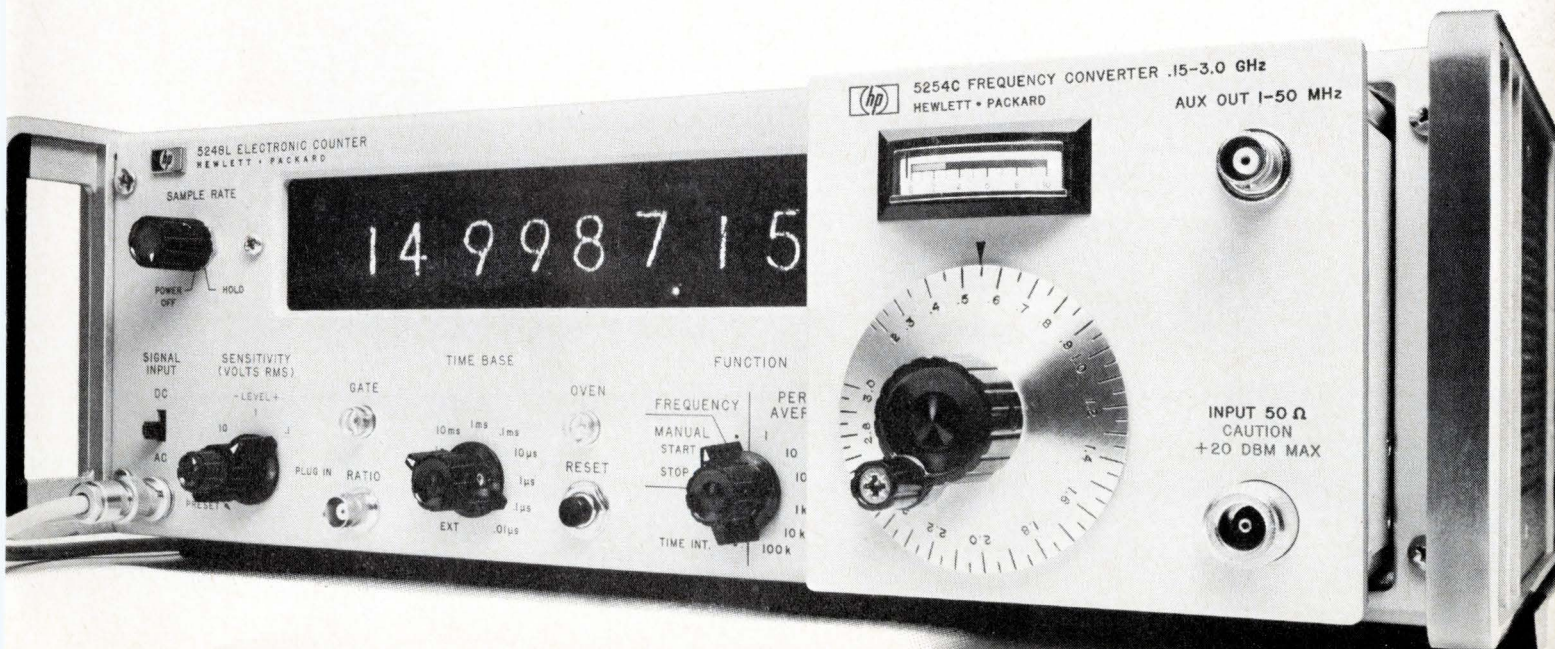

# Hot and cold

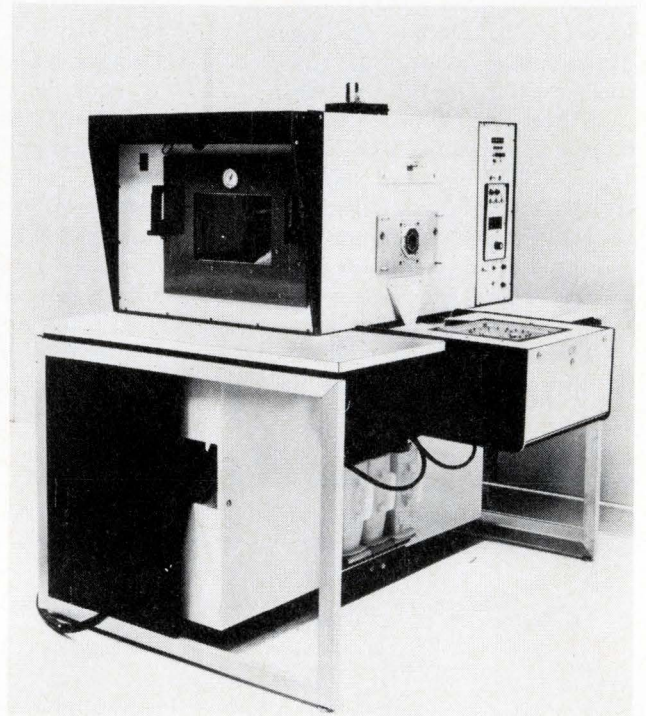
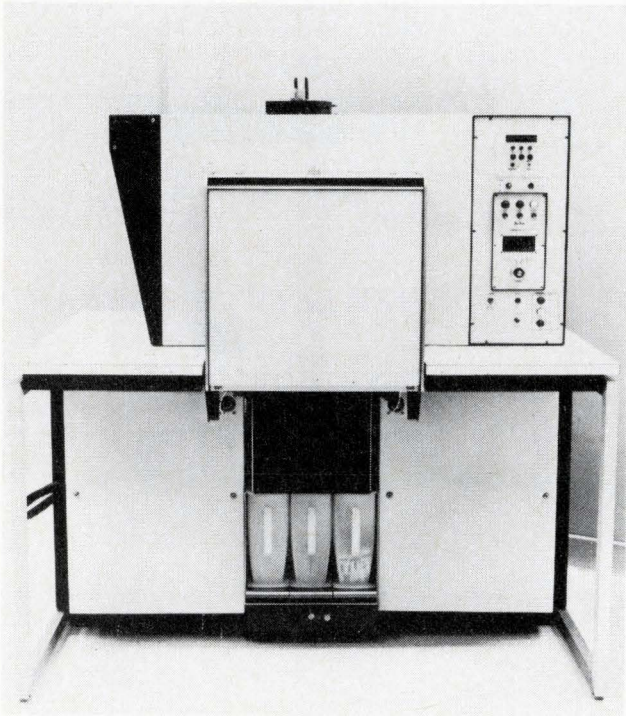

# running tests.

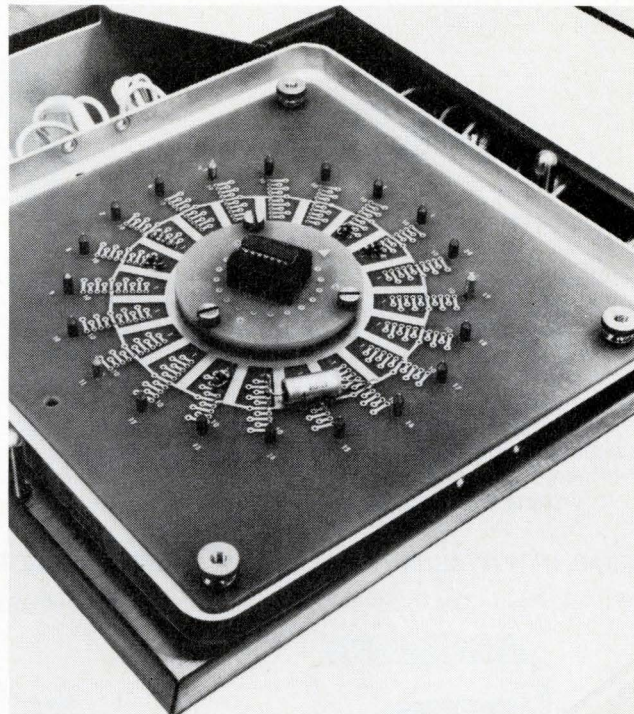
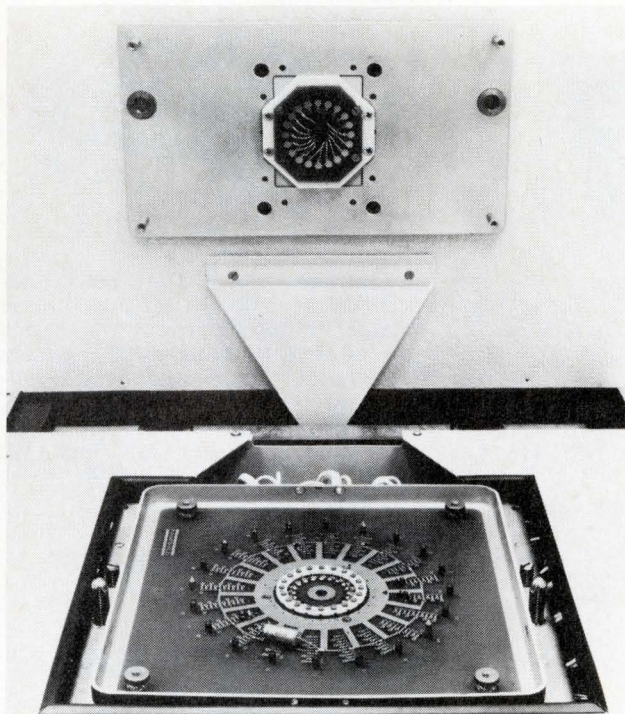

For ICs. DC, function, dynamic testing. Any one or all together. In a single pass. At any temperature from  $-55^{\circ}$  to  $125^{\circ}\text{C}$ . Up to 4500 per hour. Flat-packs, dual in-lines or TO-5s. In any lead configuration and mounted in conventional carriers.

The Fairchild 5900 series. Unique. Chambers for environmental IC testing, with options to spare. Dynamic, functional and DC parametric. Single or batches of 50,000, magazine-loaded and processed automatically.

Seventy-two units soaked simultaneously, tested serially to whatever parameters and temperature you program into the system. (And changing a program is as simple as changing a tape.) There's a post-test sort into three-class bins. Military, commercial, rejects. Or any other classes designated.

The 5900 Environmental Test Chambers are designed for closed loop operation with the Fairchild 4000, 4000M, 5000 and 5000C/5800 IC Test Systems. And ties on with a simple cable connect. Complete electrical isolation prevents any possibility of injected noise in circuits under test. Adapters for interchanging package configurations are easy plug-ins. And a swing-away test head permits performance board changes without disrupting the temperature chamber.

There's nothing remotely like the 5900s for IC testing. Nowhere else can you get it all, in the sample place, at the same time, under environmental conditions. DC, function, dynamic — we'll do it for you hot or cold. Or anywhere in between. All it takes is a system. Ours.

**FAIRCHILD**  
SYSTEMS TECHNOLOGY

## NEW LAB INSTRUMENTS

### AUTOMATIC CORE HANDLER

For testing ferrite memory cores.

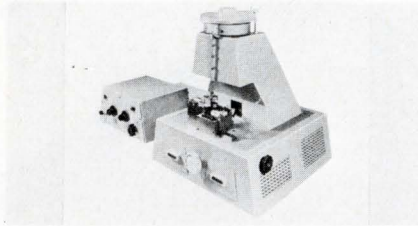

You use the Model X-13 with a core tester to electrically test 14 to 30 mil O.D. ferrite memory cores at rates from 200 to 1300 cores per minute. The handler features a vertical orientation and feed system which increases the core handling rate. Horex Electronics Inc., 1729 21st St., Santa Monica, Calif. 90404.

Circle 277 on Inquiry Card

### TIME INTERVAL METER

With 1 MHz crystal oscillator.

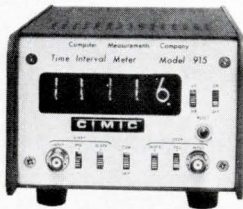

Model 915 triggers on positive or negative going pulses, and you can operate it in either a 1  $\mu$ s or 1 ms mode, with a range from 0 to 99,999. Measurements start on the A-input and stop on the B-input. Price is \$555. Computer Measurements Div., 12970 Bradley Ave., San Fernando, Calif. 91342. (213) 879-2511.

Circle 278 on Inquiry Card

### DIGITAL TO VOICE CONVERTER

Converts number to spoken message.

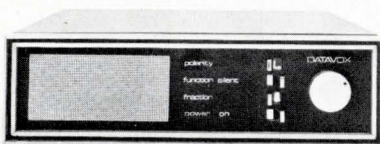

The Datavox 1 reads numbers and also announces polarity and function (volts, amps, etc.). You can adapt the unit to most digital instruments with a maximum of five digits. Unique messages and vocabularies can also be furnished. Price is \$795. Instrumentation Systems Inc., 1111 San Mateo N.E., Albuquerque, N.M. 87110. (505) 265-9536.

Circle 279 on Inquiry Card

### LAB POWER SUPPLY

With triple output.

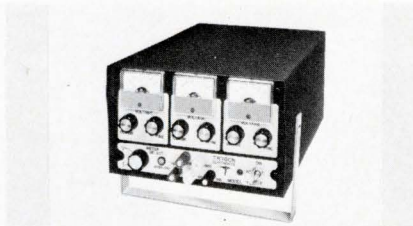

Model TL8-3 has outputs of 0 to +8 Vdc at 3 A, 0 to +32 Vdc at 1 A and 0 to -32 Vdc at 1 A. Other features include automatic current limiting, 0.01% regulation and 0.05% stability. It costs \$199. Delivery in 4 weeks. Trygon Electronics, Inc., 111 Pleasant Ave., Roosevelt, N.Y. 11575. (516) 378-2800.

Circle 280 on Inquiry Card

### WAFER PROBER

For medium-speed applications.

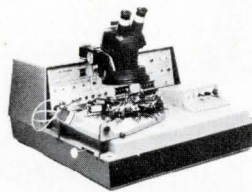

Model 900-OL provides indexing speeds of up to 2000 steps/s. The device has a probe capacity of 60 points, a maximum indexing error of 0.0001 in./in., and three optional inking modes. Indexing accuracy is  $\pm 0.25$  step, non-accumulative. Electroglas, Inc., 150 Constitution Dr., Menlo Park, Calif. 94025.

Circle 281 on Inquiry Card

### MODULE AND ARRAY TESTER

For go/no go testing.

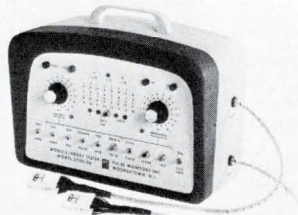

Model 2030A accommodates 14 or 16 pin ICs and supplies high and low frequency square waves, positive and negative 100 ns pulses and low repetition pulse trains. Output signal monitoring is provided by HI and LO indicator lamps. \$425 with 3 week delivery. Pulse Monitors, Inc., 351 New Albany Rd., Moorestown, N.J. 08057. (609) 234-0556.

Circle 282 on Inquiry Card

### DIGITAL VOLTMETER

With fast warm-up time.



This unit, Model 2700, reaches an accuracy of  $\pm 0.1\%$ ,  $\pm 1$  digit in one minute. A five minute warm-up brings the instrument to full rated accuracy of  $\pm 0.05\%$ ,  $\pm 1$  digit. Standard voltage range is .0001 to 999.9 Vdc Simpson Electric Co., Div. of American Gage and Machine Co., 5200 W. Kinzie St., Chicago, Ill. 60644.

Circle 283 on Inquiry Card

### RANDOM NOISE GENERATOR

With minimum output of 1 V rms.

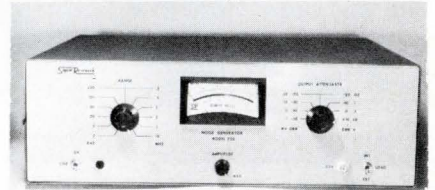

Model 220 features white noise in 11 bands ranging from 5 Hz to 2 kHz up to 10 MHz. The spectral density is flat to  $\pm 0.3$  dB on all ranges. Output impedance is 50  $\Omega$  and a 60 dB attenuator is provided. The metered output is calibrated in volts rms and dBm. Signal Research Inc., Box 79, Titusville, N.J. 08560.

Circle 284 on Inquiry Card

### CAPACITANCE METER

Typical accuracy is  $\pm 1\%$ .

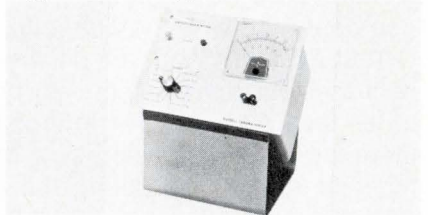

Model C1 measures capacitance without complicated null balancing procedures. Twelve overlapping ranges provide full scale readings of 100 pF through 30  $\mu$ F. The max. voltage across the capacitor is about 11 Vdc and all types, including electrolytics, can be tested. Price is \$325. Russell Laboratories, Box 644, Altadena, Calif. 91001.

Circle 285 on Inquiry Card

MINITAN is the first choice in size and reliability for Spacetac heart pacer modules.

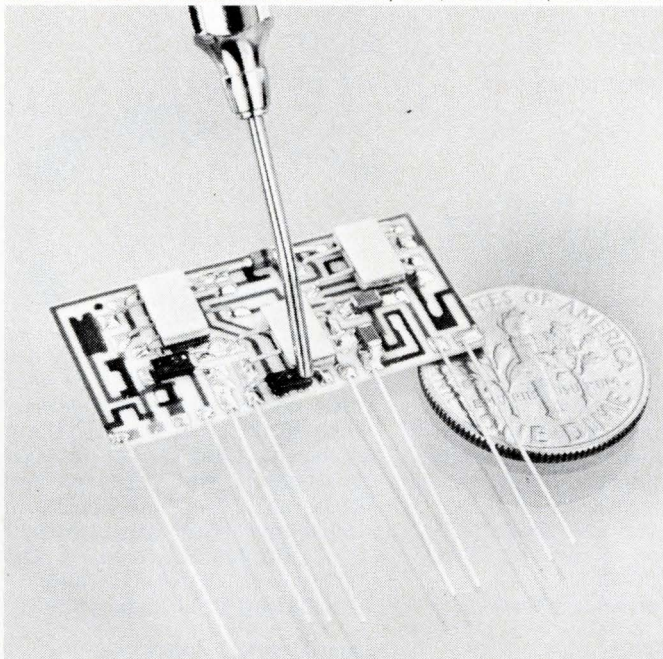

# NOW more microfarads per millimeter<sup>3</sup> from COMPONENTS

MINITAN . . . the world's smallest, proven microminiature solid electrolyte capacitor gives you the capacitance-to-volume ratios you've been searching for.

**75% Smaller than equivalent CS13 Sizes!** With Minitan you solve high density hybrid or thick film packaging problems without sacrificing performance. Polar and non-polar types from .001 to 220 ufd . . . working voltages to 35 volts . . . yet packaged in a case about the size of a pin-head — as small as .100 X .050 X .040.

**Flexibility To Fit!** 11 resin-sealed mylar case sizes . . . rectangular and tubular shapes . . . axial or radial leads. Easy-soldered nickel leads, as well as gold-plated kovar ribbon leads for maximum IC compatibility. Standard tolerances to  $\pm 5\%$ .

**Proven Reliability!** 1,679,000 Life Test Hours @ 85°C with only one failure. 130% surge voltage rating. Operating temp. range from  $-55^{\circ}\text{C}$  to  $125^{\circ}\text{C}$ . DC leakage typically less than .01 uA per ufd — volt.

Specified for manned space flights — where reliability and performance count! Specified for micropackaged commercial computers, portable communications, thick film hybrids — where reliability and performance count.

Specify Minitan to solve your space problems. Write today—we'll rush data sheets, samples and documented proof of Minitan reliability. See EEM file system 1500.

**COMPONENTS**   
INCORPORATED

BIDDEFORD, MAINE 04005

## SYSTEMS EQUIPMENT

### PERFORATED TAPE READER

Asynchronous speeds to 5 char./s.

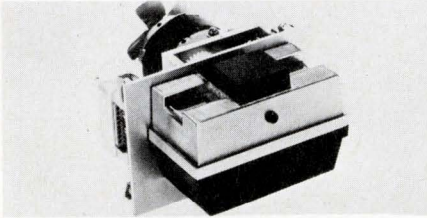

Model R-50 unidirectional reader has a "top load" read head that allows fast "straight line" tape loading. Positive hole/no-hole starwheel sensing from the bottom of the tape assures accurate reading. It reads 5, 6, or 7 level tapes in std. 11/16, 7/8, or 1 in. widths without modification. Any tape material can be read. \$350. Tally Corp., 8301 S. 180th St., Kent, Wash. 98031. (206) 251-5500.

Circle 224 on Inquiry Card

### MULTIPLEXER

Makes over 6 million connections.



Model MUX-810 is for high-speed digitizing of analog inputs. Eight analog signals can be connected to a single output. Connections can be made sequentially, with any number of channels in the sequence; or on a random access basis. Connections can also be stepped one channel at a time. Equivalent "on" res. of the unit is 0.2Ω. It operates over a range of 47 Hz through 420 Hz. Computer Labs, 1109 S. Chapman St., Greensboro, N.C. 27403. (919) 292-6427.

Circle 225 on Inquiry Card

### PLUG-IN MEMORY STACK

For mini and midi-computers.

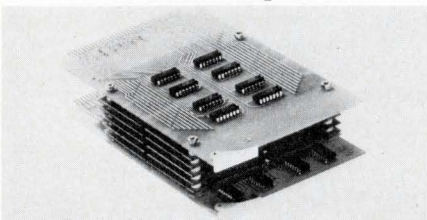

Series 200 memory stacks feature direct plug-in and 750 ns capability. They are available in 4k, 8k and 16k words with word lengths from 4 to 40 bits/word. Series 200 stacks use 18 mil memory cores with a 3D, 3-wire organization but 20 mil core stacks are also available. Ferroxcube Corp., Saugerties, N.Y. (914) 246-2811.

Circle 226 on Inquiry Card

### INTERFACE SYSTEM

For instruments/computers.

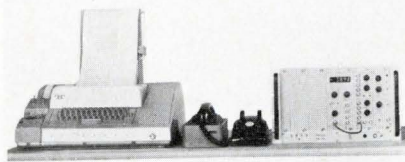

This system reduces real-time experimental data, then transfers it to a remote time-shared computer. Model 131 instrument/computer interface system can accept experimental data from up to 90 analog and digital instruments. These data are then processed by the appropriate instrument modules making up the Model 131. Princeton Applied Research Corp., Princeton, N.J. 08540.

Circle 227 on Inquiry Card

### MINI-COMPUTER

Low cost time-sharing system.

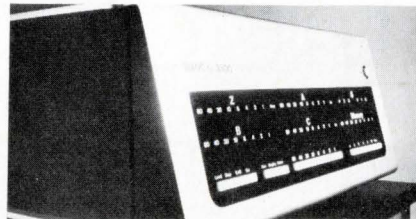

Model 3300 BASIC mini-computer system begins at only \$15,250 for a central processor and two teletype terminals. Extending the features of the highly popular and simple BASIC language, it accommodates up to 16 terminals. With the Model 1103A acoustic coupler, you may operate from remote locations using the Wang 3315 teletype terminal and std. telephone lines. Wang Laboratories, Inc., 836 North St., Tewksbury, Mass. 01876. (617) 851-7311.

Circle 228 on Inquiry Card

### TELEMETRY MULTI-COUPLER

Covers "L" and "S" bands in one unit.

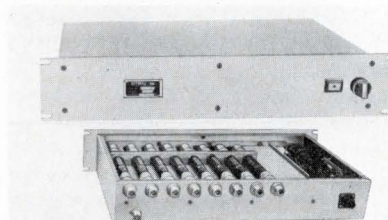

Model M4-1423R has a freq. range of 1435-2300 MHz and 2 dB min. gain. Output vswr is 1.5:1 max.; input vswr is <2.1:1. Unit has a ±2 dB max. response ripple and a NF of 8 dB max. Dynamic range is 75 dB; it has 4 outputs, with 50 dB min. output to output isolation. \$3000. Optimax, Inc., 258 Main St., Ambler, Pa. 19002.

Circle 229 on Inquiry Card

### ACOUSTIC COUPLER

New communications link.



Model 3040 links serial binary data sources and a distant time share computer or remote terminal. It operates with a normal telephone handset over public telephone lines, without special attachments. Model 3040 performs interchangeable with Teletype Models 33, 35, and 37 or with other printing mechanisms. Beckman Instruments, Inc., 2500 Harbor Blvd., Fullerton, Calif. 92634. (714) 871-4848.

Circle 230 on Inquiry Card

### SPUTTERING SYSTEM

Fully automatic.



High yield batch production system can process up to 4000 sq. in. of substrate material in one cycle. With the System 89, all critical operating functions are under "Program Control," eliminating the need for a skilled operator and further increasing uniformity from batch to batch. Film thickness uniformity tol. is as good as ±5% within the 8 in. circle of the substrate holder. Materials Research Corp., Orangeburg, N.Y. 10962. (914) 359-4200.

Circle 231 on Inquiry Card

### DIGITAL SYSTEM

Displays and records data.

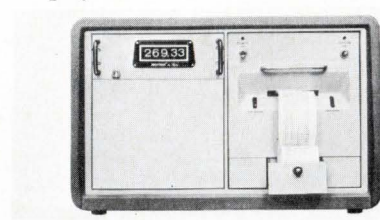

Data Monitor, Model DM-1, provides continuous digital readout and a printed record of remotely-located analog variables. It also delivers digital outputs for computer interfacing and for driving parallel displays at several locations. Accuracy: 1 part in 10,000. Printing rate, 3 lines/s. Theta Instrument Corp., Fairfield, N.J. 07006. (201) 227-1700.

Circle 232 on Inquiry Card



# 'NEW MATH'

## from Fairchild Controls

$$1 + 1 = \text{THE BIG } 1$$

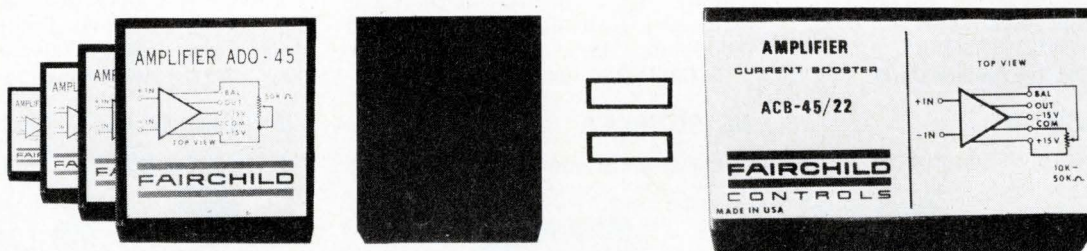

**CHOOSE 1** Fairchild Op Amp from our wide range of available amplifiers . . .

**ADD 1** current boosting circuit to give you 200 milliamps of output current . . .

**AND,** you get 1 package containing 2 circuits with the same electrical parameters — the same pin spacing and configuration as the original op-amps. Achieving space and cost savings not available in the use of two circuits to obtain extra output current.

Combining compatible components like these exemplifies Fairchild Controls' dedication to serve your broad scope amplification needs whether they be:

- Total systems.
- Proprietary op-amps.
- Reliable second sourcing the industry's broadest line of standard op-amps.

See your nearest Fairchild rep, or call or write Marketing Manager, at

**FAIRCHILD**  
CONTROLS

423 NATIONAL AVENUE, MOUNTAIN VIEW, CALIF. 94040 (408)962-3833

## NEW PRODUCTS

### VOLTAGE-VARIABLE DIODE

Tuning ratio above 14.

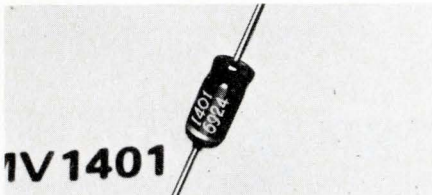

Hyperabrupt-junction voltage-variable capacitance diode, Type MV1401, features a min. tuning ratio of 14 at 1 MHz, specified for a reverse-voltage range of 1 to 10 V. It has a high nominal capacitance of 550 pF at 1 V and 1 MHz, and a min. figure of merit of 200 at 2 V and 1 MHz. \$5.95 ea. (100-999). Motorola Semiconductor Products Inc., Box 20924, Phoenix, Ariz. 85036. (602) 273-3466.

Circle 201 on Inquiry Card

### CHIP CAPACITOR

Range is 1200 to 470,000 pF.

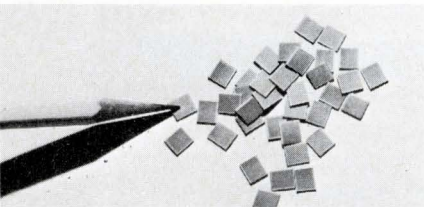

New ceramic chip measures  $0.230 \pm 0.010 \times 0.210 \pm 0.010$  and will replace the old  $0.230 \times 0.230$  size. Temperature range is  $-55^\circ$  to  $125^\circ\text{C}$ . Standard voltage ratings are 50 Vdc at  $125^\circ\text{C}$  and 100 Vdc at  $85^\circ\text{C}$ ; capacitance tol.:  $\pm 5\%$ ,  $\pm 10\%$ ,  $\pm 20\%$ . Chip comes in both NPO and general purpose dielectrics with noble metal terminations. Vitramon, Inc., Box 544 Bridgeport, Conn. 06601. (203) 268-6261.

Circle 202 on Inquiry Card

### GaAs EMITTERS

Radiate IR energy at 935 nm.

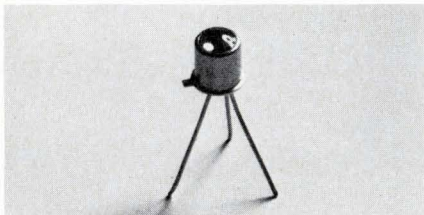

Four new gallium arsenide emitters are made from amphoterically doped, solution-grown GaAs. Three different headers offer a variety of outputs and beam patterns, ranging from 0.36 mW optical power output into a  $16^\circ$  optical beam to 150 mW into a  $150^\circ$  beam. Spectronics, Inc., 541 Sterling Dr. Richardson, Tex. 75080.

Circle 203 on Inquiry Card

### GLAZE RESISTORS

Values from 10 k $\Omega$  to 10 G $\Omega$ .

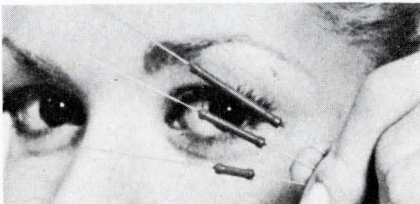

Stability of these miniature metal oxide glaze resistors is better than 1% under full loads for 2000 hours, with more than 40 W power diss./in<sup>3</sup>. Operating temps range from cryogenic levels to  $220^\circ\text{C}$ ; TCS from 200 to 660 ppm; voltage coeff. from 2 to 5 ppm; and accuracy from 0.5% to 2% depending upon the resistance value. Victoreen Instrument Div., 10101 Woodland Ave., Cleveland, Ohio

Circle 204 on Inquiry Card

### DC SOURCES

For PC board mounting.

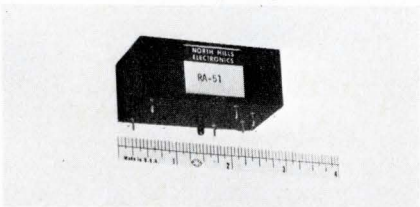

Precision loadable series RA-50 dc voltage ref. sources accept an unregulated dc input which can vary as much as  $\pm 10\%$  and convert it to stable 10 Vdc, 0 to 5 mA output. Under steady state input conditions the voltage drift does not exceed  $\pm 3$  ppm in 8 hrs. or  $\pm 10$  ppm in 30 days. TC is a low 1 ppm/ $^\circ\text{C}$  for  $0^\circ$  to  $50^\circ\text{C}$  amb. North Hills Electronics, Inc., Glen Cove, L.I., N.Y. 11542. (516) 671-5700.

Circle 205 on Inquiry Card

### PANEL METER

Has insertable scales.

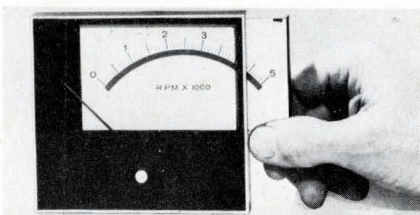

Series 7000 panel meters have a new case design which permits mounting on the panel front, or behind the panel with either an optional bezel or lens kit. Tracking of 1% is standard in taut band meters in dc ranges. Sizes are  $3\frac{1}{2}$ ,  $4\frac{1}{2}$  and  $5\frac{1}{2}$  in., with all popular ranges available. API Instruments Co., Chesterland, Ohio 44026.

Circle 206 on Inquiry Card

### CONDUCTIVE EPOXY

Two-component, silver filled.

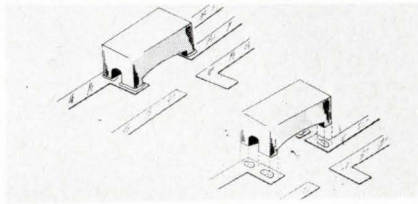

Epo-Tek H21 is a 100% solids system that permits rapid and reliable positioning of chip resistors, chip capacitors, LID's, inductors, and other devices in hybrid circuits. It can be used in the  $300^\circ\text{C}$  to  $400^\circ\text{C}$  range for intermittent service, and will withstand continuous operating temp. of  $250^\circ\text{C}$ . Volume resistivity is rigidly held at 0.0006 to 0.0009  $\Omega\text{-cm}$ . Epoxy Technology, Inc., 65 Grove St., Watertown, Mass.

Circle 207 on Inquiry Card

### PRECISION ADAPTERS

Keep reflections to a minimum.

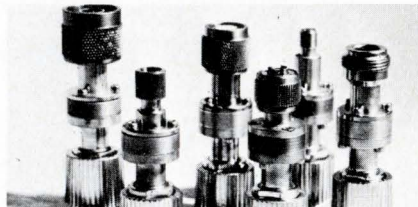

Precision 7 mm adapters are for applications where you want to keep reflections to an absolute minimum. A modified 7 mm connector is used in which the inner conductor is supported radially by a set of dielectric pins and longitudinally by a dielectric slab, instead of by the more conventional support bead. The pins and slab are carefully compensated. Alford Mfg. Co., 120 Cross St., Winchester, Mass. 01890.

Circle 208 on Inquiry Card

### 1000 VA LINE REGULATOR

Nominal 50  $\mu\text{s}$  response time.

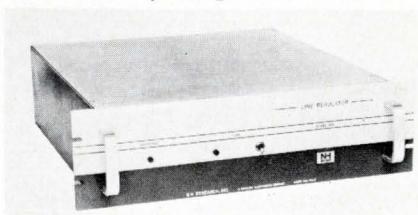

Model 3131 1000 VA line regulator features improved regulation for line and load conditions, plus fast response for any transients that may appear on the input line signal. This 1000 VA regulator has a total front panel height of  $5\frac{1}{4}$  in. and a weight of about 70 lbs. \$995. NH Research, Inc., 1510 S. Lyon St., Santa Ana, Calif. 92705.

Circle 209 on Inquiry Card

# Need A Scope That Remembers?

If you make real-time measurements in the 50 MHz to something for you to remember: Only Hewlett-Packard offers

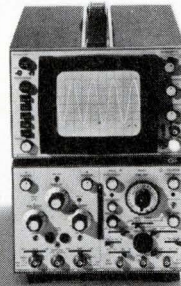

100 MHz frequency range, here's a storage scope with bandwidth

capabilities in these frequencies. In addition to this exclusive capability, Hewlett-Packard offers a scope that remembers sampling displays and spectrum analysis displays.  If you want low-frequency, high-sensitivity in a low-cost

scope that you can

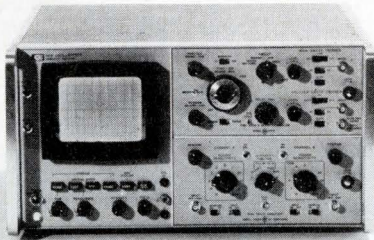

remembers, HP has it, too.  In all the HP scopes, at the twist of a knob, vary persistence—an HP exclusive. HP's storage technique allows you

to store gray shades for complete Z-axis information—another HP exclusive. HP storage industry-standard, aluminized, P-31 phosphor; so you get the same brightness, the same

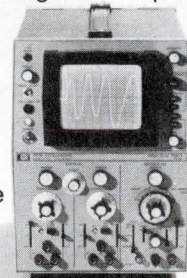

CRT's use burn-

resistance, the same writing speed, the same operating life you get with a conventional CRT—another HP exclusive.

And, HP storage CRT's are the only ones with an internal graticule to eliminate parallax.  With an HP storage scope,

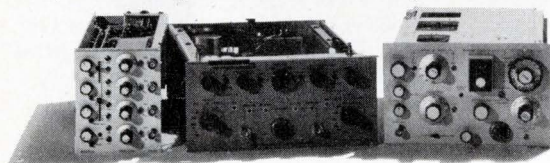

you really get three scopes in one. Use it to store, or to vary

display time, or as a conventional scope. Choose a 180 or 140 series storage oscilloscope with plug-ins which match

your high frequency needs. Choose the low-cost

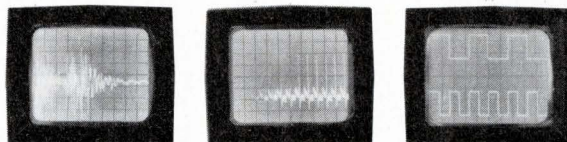

1200 series for

your low-frequency measurements.  For application information on HP scopes that remember, contact your

local HP field engineer.

080/5

Or, write to Hewlett-Packard, Palo Alto, California 94304.  
 Europe: 1217 Meyrin-Geneva, Switzerland.  
 Prices: HP 141 Mainframe, \$1395 or \$1500;  
 HP 181A Mainframe, \$1850; HP 1200 Series, \$1550 or \$1900.

**HEWLETT  PACKARD**  
 OSCILLOSCOPE SYSTEMS

## NEW PRODUCTS

### SOLID STATE SOURCE

Klystron replacement for X-band.

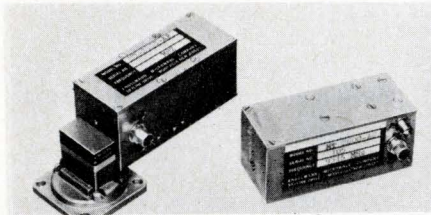

Miniature ss source is for klystron replacement applications in the 8.5 to 10.0 GHz region. It delivers a min. of 10 mW output from either an OSM connector or waveguide flange over the range of  $-30^{\circ}$  to  $+70^{\circ}\text{C}$  with a stab. of  $\pm 0.2\%$ . It is tunable over  $\pm 100$  MHz. Engelmann Microwave Co., Skyline Dr., Montville, N.J. 07045. (201) 334-5700.

Circle 215 on Inquiry Card

### SILICON CHOPPER

Transformer-coupled.

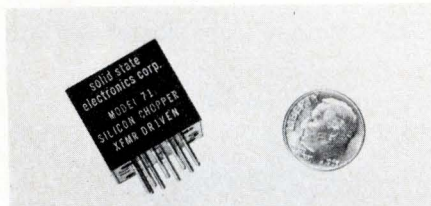

Model 71 chopper (or modulator) is an encapsulated unit designed to alternately connect and disconnect a load from a signal source. It may also be used as a demodulator to convert an ac signal to dc. It can linearly switch or chop voltages over a wide dynamic range which nominally extends down to 1 mV and up to  $\pm 10$  V. The contacts can handle up to 5 mA. Solid State Electronics Corp., 15321 Rayen St., Sepulveda, Calif. (213) EM 4-2271.

Circle 216 on Inquiry Card

### ISOLATION TRANSFORMER

Eliminates spurious ground loops.

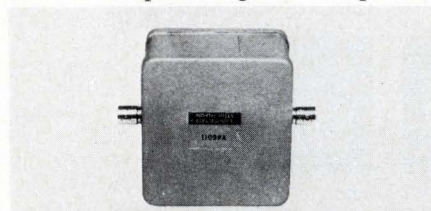

Wideband 1109-PA ground isolation transformer eliminates spurious ground loop currents in  $75\Omega$  coax, video and data signal lines. Using transformer balancing and shielding techniques, 140 dB attenuation is achieved against 60 Hz interference with minimal distortion and attenuation over the 25 Hz to 7 MHz band. \$125 (1-9). North Hills Electronics, Inc., Alexander Place, Glen Cove, L.I., N.Y. 11542. (516) 671-5700.

Circle 217 on Inquiry Card

### LEAD TRIMMER

Pneumatic machine.

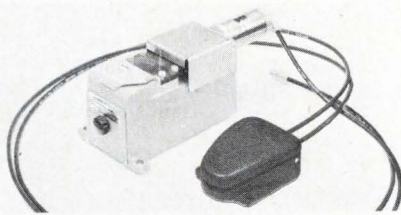

MARK IX trimmer trims parallel leads of components such as transistors, disc capacitors, DIP modules ICs in TO packages and most other setups within a 1 in.<sup>2</sup> area. Quick change dies may be built to trim up to 20 leads on a single module to specified lengths from 0.050 to 0.500 in. Technical Devices Co., 11242 Playa Ct., Culver City, Calif. 90230.

Circle 218 on Inquiry Card

### CRYSTAL FILTER

Sharp selectivity.

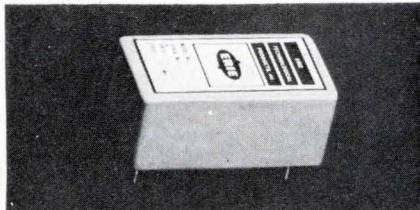

Model 900-190-1 filter is centered at 10.7 MHz and has 6 dB bandwidth of 2.2 kHz min. It can be used wherever narrowband selectivity is needed and small size and low cost are important. Additional specs: 45 dB BW = 5.0 kHz; ripple =  $\pm 0.5$  dB max.; insertion loss = 4.0 dB max.; input and output terminations =  $600\Omega$  plus 30 pF. \$12.40 to \$26.00 ea. Erie Frequency Control, div. of Erie Technological Products, 453 Lincoln St., Carlisle, Pa. 17013. (717) 249-2232.

Circle 219 on Inquiry Card

### LATCHING RELAYS

In TO-5 cases.

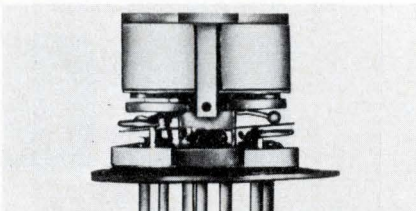

The first two types (424A and 424AD) in a new line of four-pole magnetic latching relays are identical except that the D version has an internal chip diode in parallel with each coil for transient suppression. The single-throw units are fast (1.5 ms actuation time), and are thus well suited to use in systems where memory is needed. Teledyne Relays, 3155 W. El Segundo Blvd., Hawthorne, Calif. 90250. (213) 679-2205.

Circle 220 on Inquiry Card

### LATCHING RELAY

Meets Mil-R-5757E.

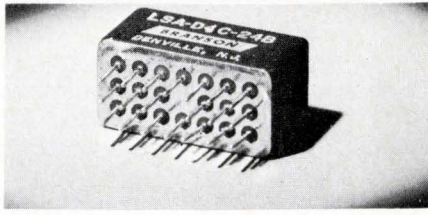

This 4 PDT (4FC) magnetic latching relay meets the requirements of Mil-T-5757E, including welded seal. It is available with 6, 12 and 24 Vdc coils and operates from a 150 mW short duration pulse. Contacts are rated low level to 2 A res. Temperature range is  $-65^{\circ}$  to  $+125^{\circ}\text{C}$ . Branson Corp., Vanderhoof Ave., Box W., Denville, N.J. 07834. (201) 625-0600.

Circle 221 on Inquiry Card

### SILICON PHOTODIODE

Broad spectral response.

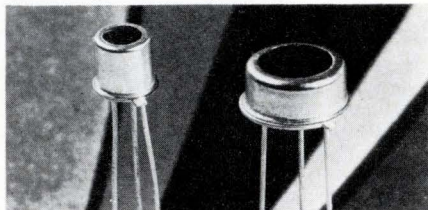

The SGD-040 is available in two hermetically sealed package setups; Type "A" conforms to a TO-5 mechanical outline and Type "B," to a TO-46 outline. Characteristics include: sens. of 0.5 A/W at  $0.9\mu\text{m}$ ; spectral response range from  $0.35\mu\text{m}$  in the UV to  $1.13\mu\text{m}$  in the near IR; rise-time  $< 1$  ns; channel imp.  $> 25\text{M}\Omega$ ; and dark leakage current  $< 1$  nA. EG&G, Inc., Electronic Products Div., 160 Brookline Ave., Boston, Mass. 02215. (617) 267-9700.

Circle 222 on Inquiry Card

### PUSHBUTTON SWITCHES

Reed actuated, low profile.

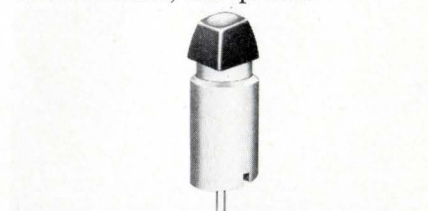

Single pole normally open switch provides the low operating force and high reliability needed in keyboards. The RSM-41 mounts on a 0.75 in. spaced matrix, and is free from interaction between units. Minimum operating force, 1.2 oz.; max. 2.0 oz.; voltage, 50 V; current, 500 mA; power, 10 W; initial contact res., 15 m $\Omega$ . Alco Electronic Products, Inc., Box 1348, Lawrence, Mass. 01842. (617) 686-3887.

Circle 223 on Inquiry Card

# NOW... A NEW AND EXPANDED MANUFACTURING SYSTEM FOR HIGH TECHNOLOGY INDUSTRIES

## ...by Hamilton Precision Metals

• COMPUTER • INSTRUMENT • TELECOMMUNICATION • BUSINESS MACHINE

The Precision Metals Division of Hamilton Watch Company is now geared to meet the requirements of computer, instruments, telecommunication and business machine manufacturers—as well as other high technology industries—with high-quality precision strip, foil and wire processing, precision Photoforming® and parts assembly.

Hamilton's metals technology includes precision rolling of ultrathin strip and foil and wire drawing in pure metals, commercial alloys and proprietary metals with highly specialized properties. This facility also includes heat-treating and annealing to provide the physical or magnetic properties required.

Photoformed parts are produced from the precision-rolled strip and foil in high volume, meeting the most rigid shape and dimensional specifications. Parts are manufactured by modern, high-production equipment in the most advanced chemical etching facility featuring "ultraclean" production conditions.



49468400 HAMILTON

HAMILTON 45182500

COMPUTER CIRCUITS

HEAD ALIGNMENT CLIPS

SHIELDS

TAPE CLEANER BLADES

HEAD LAMINATIONS

HEAD SPRINGS

TYPICAL COMPUTER PARTS

For useful printed data on precision-processed metals, Photoformed parts and assembled components write:

**PRECISION METALS DIVISION**  
**HAMILTON**  
 WATCH COMPANY • LANCASTER, PA. 17604 • PHONE (717) 394-7161

## NEW PRODUCTS

### INDUSTRIAL SCRs

Hermetically-sealed.

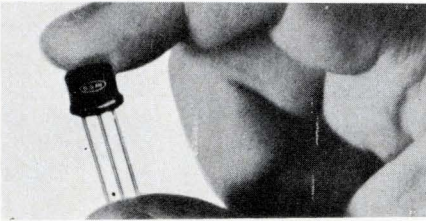

ID200 series SCRs provide low-cost electrical equivalents for the widely used C106 series plastic SCRs. They are for 1-V, medium-current control uses. Voltage ratings are from 50 to 200 V with a cont. dc forward current rating of 1.6 A at 70°C case and a gate trigger current of 200  $\mu$ A max. From \$.70. Unitrode Corp., 580 Pleasant St., Watertown, Mass. 02172. (617) 926-0404.

Circle 246 on Inquiry Card

### HV POWER SUPPLY

Delivers 5.5 kVdc at 500  $\mu$ A.

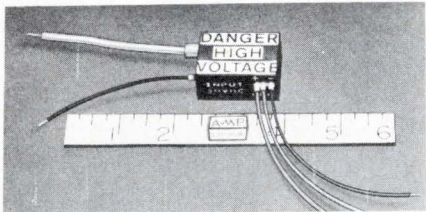

Miniature supply is only  $1\frac{1}{2} \times 1 \times 1\frac{1}{16}$  in., but delivers 5.5 kVdc at 500  $\mu$ A. The 2.3 oz. unit is fully encapsulated in thermally conductive epoxy, and when provided with adequate heat sinking, it will maintain rated current output at any temp. from -55°C to +75°C. The unit can charge a 0.6  $\mu$ F capacitor, parallel with 10 M $\Omega$  in 2s., with a 20% duty cycle. Captron Div. of AMP Inc., 155 Park St., Elizabethtown, Pa. 17022. (717) 564-0101.

Circle 247 on Inquiry Card

### TOROIDAL INDUCTORS

Small in size and weight.

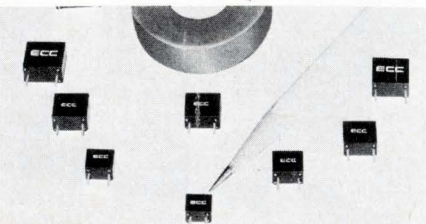

These inductors come in 90 inductance values from 0.1  $\mu$ H to 10 mH with tolerances to  $\pm 1\%$ . All are temp. stabilized and display high Q for optimum operation at freqs. between 250 kHz to 25 MHz. Eighteen different packages are used in sizes ranging from 0.100 x 0.200 x 0.200 in. up to 0.300 x 0.500 in. Engineered Components 2134 W. Rosecrans Ave., Gardena, Calif. (213) 321-6565.

Circle 248 on Inquiry Card

### TRANSISTOR AMPLIFIER

With a low-noise figure of 7 dB.

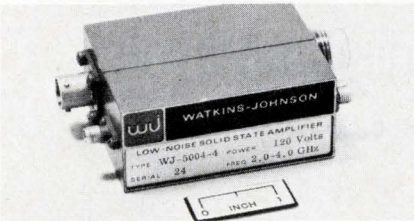

This S-band amplifier (WJ-5004-4) delivers a guaranteed power output (for 1 dB gain compression) of +5 dBm and small signal gain of 25 dB. It meets the respective environmental requirements of Mil-E-16400F, including Amendment 4 dated 15 May 1968, and Mil-E-5400K, Class 2. Watkins-Johnson Co., 3333 Hillview Ave., Stanford Industrial Park, Palo Alto, Calif. 94304. (415) 326-8830.

Circle 249 on Inquiry Card

### IC DE-SOLDER TIP

Speeds solder melting time.

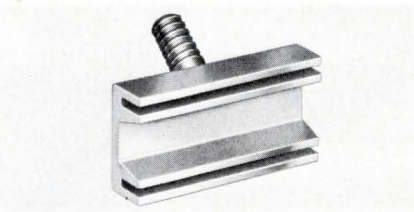

Model 6948 de-soldering tip steps up solder melting time on PC boards. It features a slotted head that simultaneously applies heat on both sides of the IC leads. Up to 16-pin DIPs can be released in one operation. Tip is iron clad, nickel plated and pre-tinned. It is available singly or included in the company's Princess<sup>®</sup> IC de-solder kit (Model #6939). Unger, div. of Eldon Industries, Inc., 233 Manville Ave., Compton, Calif. 90220. (213) 774-5950.

Circle 250 on Inquiry Card

### REED SWITCH

Low profile.

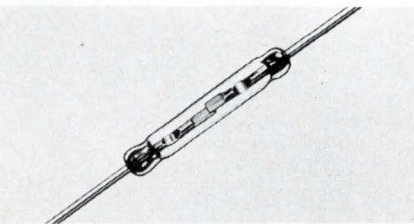

Tiny Tina, centertap reed switch meets the full electrical and physical requirements of DIL reed relay manufacturers. Operate time, including bounce, is typ. 250  $\mu$ s, enabling fast cycling; and <50 mW of power are needed for switch operation. It has easily workable 0.020-in. dia. leads. Gordos Corp., 250 Glenwood Ave., Bloomfield, N.J. 07003. (201) 743-6800.

Circle 251 on Inquiry Card

### POWER RESISTOR

With flat heat sink.

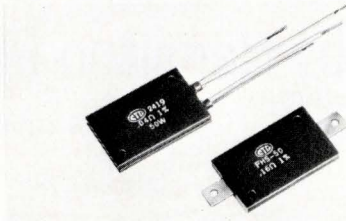

Industrial power resistor with a new wafer construction allows power dissipations to 50 W, with 0.003 to 25  $\Omega$  resistance values, low TCS (to  $\pm 5$  ppm) high accuracies ( $\pm 5\%$  std. tolerance), and chassis mount construction. It has Kelvin Varley (4 wire) construction for 0.05% measurements. Charles T. Gamble Industries, Fairview St. & New Jersey Ave, Riverside, N.J. 08075. (609) 461-1900.

Circle 252 on Inquiry Card

### POWER SUPPLIES

High efficiency, low ripple.

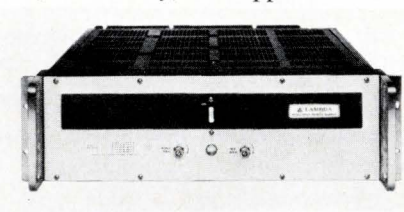

New line of modular supplies are for TTL, ECL, RTL, DTL and HTL logic uses. An electronic ripple reducer produces low output ripple <10 mV rms, max. The LV Series is offered in three package sizes from 3 to 15 V and up to 150 A. Line reg. is 0.15% +10 mV for line variations from 105 to 132 Vac. Load reg. is 0.15% +10 mV. TC is 0.03% +0.5 mV/°C. Lambda Electronics Corp., 515 Broad Hollow Rd., Melville, N.Y. 11746. (516) 694-4200.

Circle 253 on Inquiry Card

### GUNN EFFECT SS SOURCE

Uses cavity stabilization methods.

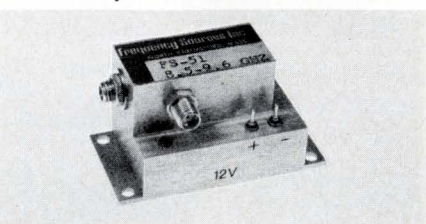

Model FS-51 covers 8.5-9.6 GHz and 9.5-10.5 GHz ranges with three min. power levels available; 5 mW, 10 mW, and 25 mW. Frequency stab. is  $\pm 10$  ppm/°C max. with  $\pm 5$  ppm/°C being typ. It has an op. temp. range from -30° to +70°C. The fm noise is typ. 5 Hz/1000 Hz from the carrier. Frequency Sources, Inc., Kennedy Dr., Box 159, North Chelmsford, Mass. 01863. (617) 774-0577.

Circle 254 on Inquiry Card

# STACK THESE UP AGAINST THE OTHERS

## Your Best Buys In Power Supplies Come From Heath

Heath Power Supplies have been the first choice of thousands of engineers for over 20 years . . . and with good reason. They offer that skillful blend of performance, versatility and price that make them the best all-around supplies available. And for the price of a couple of supplies from anyone else, you can buy all seven of ours. We still believe you should be able to get a stack of supplies without spending a pile of money. When you need a reliable, well-designed power supply and low cost too, there's only one best buy — Heathkit. For performance, versatility and top dollar value, the others just don't stack up.

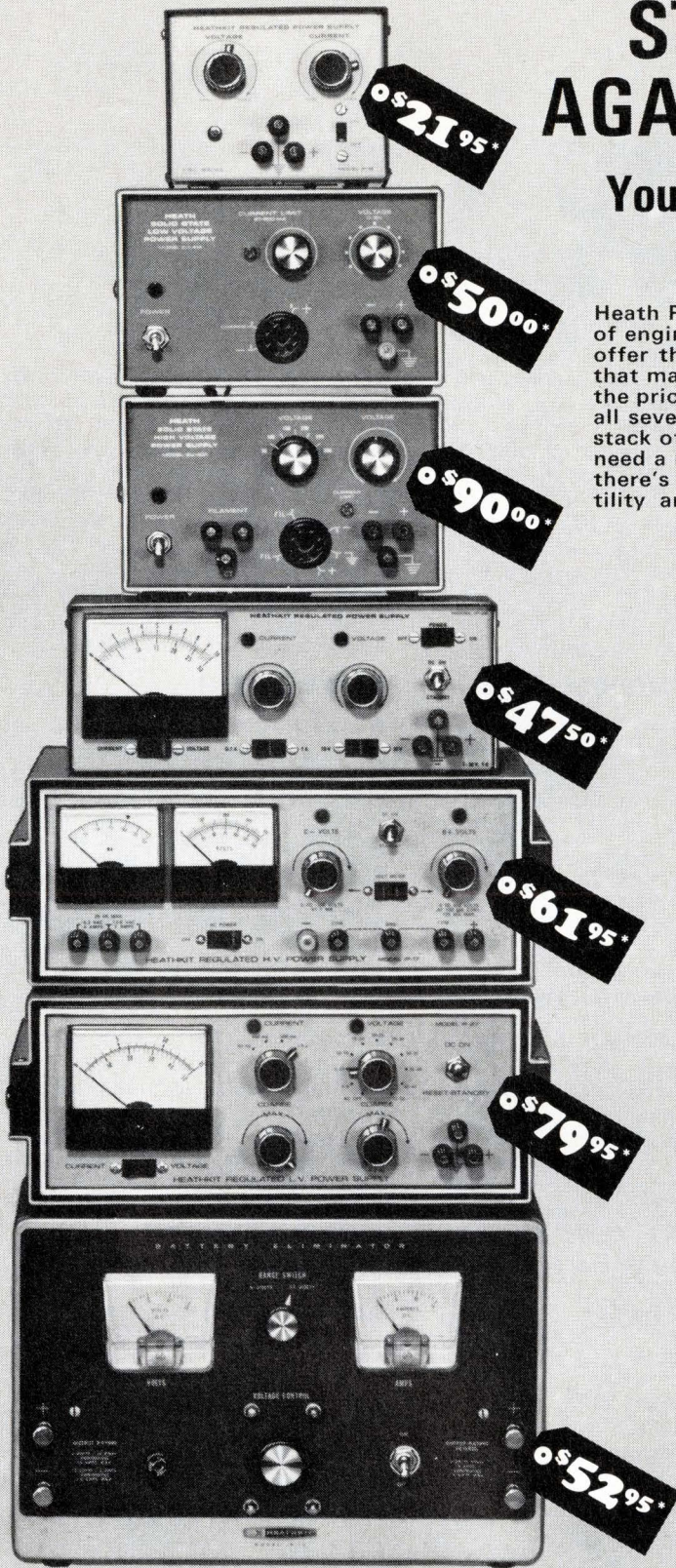

### \$21.95\* buys a Solid-State 1-15 VDC Kit

- Variable 1-15 VDC • Adjustable current limiting • Up to 500 mA continuous • Positive or negative ground • External AC or DC programming • Darlington pair regulation • Less than 5 mV ripple • 120/240 VAC • Circuit board construction. IP-18, 9 lbs.

### \$50.00\* buys an Assembled 0-15 VDC Supply

- Solid-State • Variable 0-15 VDC • Adjustable current limiting 35-750 mA • Overcurrent indicator • 0.02% regulation • 0.02% stability • External programming • 5-way binding post and octal socket output • 120/240 VAC • Assembled & tested. EU-41A, 6 lbs.

### \$90.00\* buys Assembled 50-300 VDC Supply

- Solid-State • Variable 50-300 VDC • 20 mA current limiting • 6.3 VAC @ 1 A • 1% regulation • Less than 50 mV ripple • 120/240 VAC • 5-way binding post & octal socket output • Assembled & tested. EU-40A, 7 lbs.

### \$47.50\* buys a Solid-State 1-30 VDC Kit

- Two variable ranges . . . 1-10 & 1-30 VDC • Two range current limiting . . . 10-100 mA & 10 mA-1A • Switched metering • Function lamps • External voltage sensing • AC & DC programming • Standby switch • 120/240 VAC • Circuit board/wiring harness • IP-28, 9 lbs.

### \$61.95\* buys a 0-400 VDC Kit

- 0 to 400 VDC & 0 to -100 VDC • 6.3 VAC @ 4A & 12.6 VAC @ 2A • Separate meters for B+ voltage & current • 1% regulation • Less than 10 mV ripple • 120/240 VAC • Kit IP-17, 21 lbs. • Assembled & tested IPW-17, 18 lbs., \$95.00\*

### \$79.95\* buys a Solid-State 0.5-50 VDC Kit

- 0.5 to 50 VDC • .05% regulation • Adjustable current limiting • 4 switched current ranges . . . 50, 150, 500 & 1500 mA max. • Standby switch • Less than 200 uV ripple • Floating output • Immune to transients • 120/240 VAC • Kit IP-27, 16 lbs. • Assembled & tested IPW-27, 14 lbs., \$125.00\*

### \$52.95\* buys a 6 & 12 VDC Kit

- Switched 6 VDC @ 10 A or 12 VDC @ 5 A output • Filtered and unfiltered outputs • Separate voltage and current meters • Less than 0.3% ripple • Doubles as a battery charger • Heavy duty • Kit IP-12, 18 lbs.



**NEW**  
**FREE 1970 CATALOG!**  
 Now with more kits, more color. Fully describes these along with over 300 kits for stereo/hi-fi, color TV, electronic organs, guitar amplifiers, amateur radio, marine, educational, CB, home & hobby. Mail coupon or write Heath Company, Benton Harbor, Michigan 49022.

HEATH COMPANY, Dept. 520-25  
 Benton Harbor, Michigan 49022



Enclosed is \$ \_\_\_\_\_, plus shipping.

Please send model (s) \_\_\_\_\_

Please send FREE Heathkit Catalog.  Please send Credit Application.

Name \_\_\_\_\_

Address \_\_\_\_\_

City \_\_\_\_\_

State \_\_\_\_\_

Zip \_\_\_\_\_

\*Mail order prices; F.O.B. factory. Prices & specifications subject to change without notice.

TE-219

## NEW PRODUCTS

### QUARTZ FILTERS

With a 5 MHz center freq.



These 6-pole coupled mode quartz filters have a 3 dB BW of 14 kHz, and a 60 dB BW of 70 kHz. Temperature stab. is  $\pm 0.005\%$ , and time stab.  $\pm 0.0007\%$ /yr. Operating temp. range is from  $-45^\circ$  to  $+85^\circ\text{C}$ . Input and output impedances are 12,000  $\Omega$ . Maximum insertion loss is 4 dB, ultimate attenuation 100 dB. Piezoelectric Div., Gould Inc., 232 Forbes Rd., Bedford, Ohio 44146.

Circle 255 on Inquiry Card

### PHOTOTRANSISTOR ARRAYS

OCR applications.

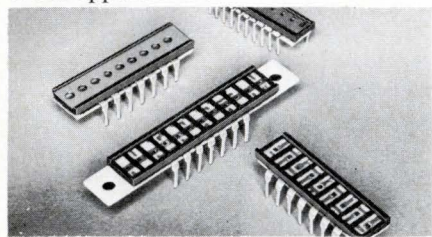

These std. arrays come with from 5 to 12 phototransistor sensors and a variety of on-center distances. All commercially available phototransistor chips are available with std. positioning tolerances to  $\pm 0.001$  in. Arrays can be mounted directly to a fiber-optic head or a PCB, plugged into std. sockets or attached by mounting holes. HEI, Inc., Jonathan Industrial Ctr., Chaska, Minn. 55318. (612) 445-3510.

Circle 256 on Inquiry Card

### STRIPLINE ATTENUATORS

Give up to 5 W of power.

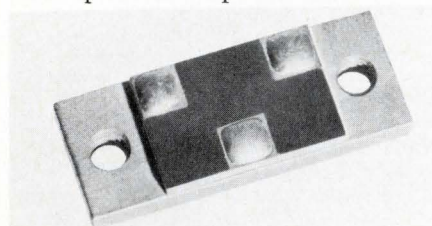

These flat attenuator chips are for stripline, microstrip and PC uses, and are available in models ranging from  $\frac{1}{2}$  W to 5 W, and from 1 dB to 20 dB, with a 10% or 0.5 dB tol. A vswr of  $< 1.2$  and up to 4 GHz is attainable with proper mounting. \$7.75 to \$20.00. EMC Technology, Inc., 1300 Arch St., Philadelphia, Pa. 19107. (215) 563-1340.

Circle 257 on Inquiry Card

### HV LATCHING RELAY

Weighs only 34 grams.

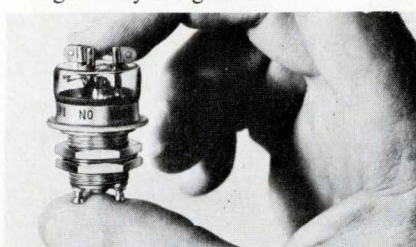

Type TCR/L high-vacuum SPDT magnetic latching relay can switch 2500 W with only a 3 ms, 18 Vdc pulse. It can be operated at 5000 V in air and 15,000 V in oil or gaseous dielectric media. Because of the short pulse used to operate this relay, the coil temp. rise is negligible. It meets Mil-Std-5757. Torr Laboratories, Inc., 222 Cotner Ave., Los Angeles, Calif. 90064. (213) 477-1224.

Circle 258 on Inquiry Card

### DIL RESISTOR MODULE

Low height profile is 0.250 in.

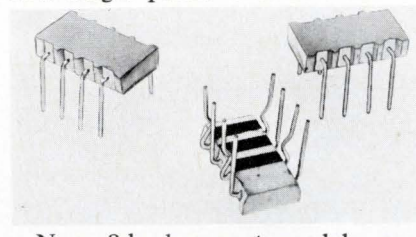

New 8-lead cermet module provides a small economical package for uses requiring 7 or fewer resistors. Series 760 modules with 8-pin leads are available with capacitor chips and/or active devices. Lead spacing is 0.100 in. Total module load at  $70^\circ\text{C}$  is  $\frac{3}{4}$  W. Base prices are \$.74 ea. in 1000 lots, based on  $\pm 2\frac{1}{2}\%$  tol. and std. rc of  $\pm 250$  ppm/ $^\circ\text{C}$  from 50  $\Omega$  through 1 M $\Omega$ . CTS of Berne, Inc., Berne, Ind. 46711. (219) 589-3111.

Circle 259 on Inquiry Card

### FLAT JUMPER CABLE

For multiple circuits.

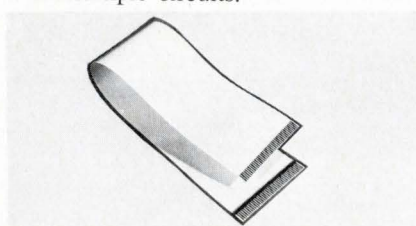

This jumper cable is for connections such as a circuit patch cord, board extension, chassis to cabinet, chassis to chassis, and cabinet interconnection. Designed to mate with PC connectors, contact is made directly to the flat cable conductors, eliminating the need for attached contacts or terminals. Burndy Corp., Tape Cable Div., 15 Linden Park, Rochester, N.Y. 14625.

Circle 260 on Inquiry Card

### SILICON NPN TRANSISTORS

Plastic power line.

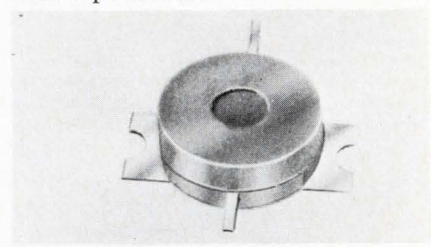

The B5000-5150 series is well suited for hybrid circuitry application where power transistor functions are required. The transistors are plastic packaged. A typical cost for the B5000-5150 is \$0.90 ea./100. Electrical characteristics are:  $h_{FE}$  range up to 250,  $I_C$  3 A max. and  $V_{CEO}$  up to 60 V max. Solitron Devices, Inc., 256 Oak Tree Rd., Tappan, N.Y. 10983. (914) 359-5050.

Circle 261 on Inquiry Card

### ROTARY SWITCH

For PC board applications.

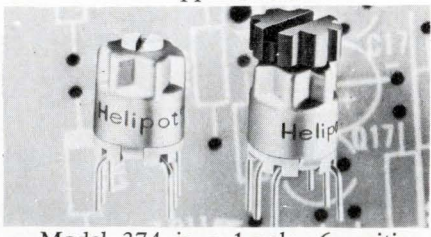

Model 374 is a 1-pole, 6-position,  $\frac{1}{4}$  in. dia. cermet switch that will handle 100 mA at 28 Vdc and will operate from  $-55^\circ$  to  $+85^\circ\text{C}$ . They have a precious metal wiper for longer life, and built-in standoffs to allow easy board washing. Two std. models are available—the 374 (screwdriver adjust) and the 374H (thumbwheel adjust). Helipot Div., Beckman Instruments, Inc., 2500 Harbor Blvd., Fullerton, Calif. 92634.

Circle 262 on Inquiry Card

### PARAMETRIC AMPLIFIERS

Feature noise temp. to 100°K.

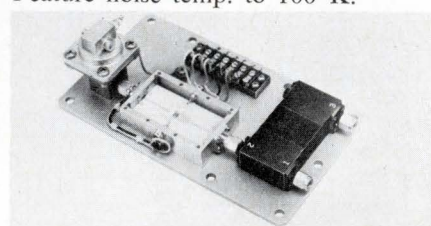

"PAR" series, uncooled paramps cover freq. ranges from 1 to 8 GHz with bws to 500 MHz. A double balanced design<sup>PP</sup> on an alumina substrate provides high LO to rf isolation from the built-in avalanche diode pump source. Weighing  $< 2$  lbs., a typ. RHG paramp has a freq. range from 3.7 to 4.2 GHz. Electronics Lab., Inc., 94 Milbar Blvd., Farmingdale, N.Y.

Circle 263 on Inquiry Card



# Using spot ties?

## GUDE-TIES, replacing plastic wraps, cut yearly material cost more than 75%

"GUDE-TIES", CUT LENGTHS of Gudebrod Flat Braided Lacing Tapes, are specifically produced for spot tying—in production harnessing or for on-site work. A comparative engineering analysis found that material costs for Gude-Ties was 76.7% less than for plastic wraps on a yearly production basis, and harness weight was reduced also. In aviation and other important applications weight of the harness is important, and gaining more importance. Gude-Ties are dispenser packaged for one hand, easy withdrawal. Meet MIL-T Specs, make firm knots. Available in 6", 8", 10", 12", 15", 18", 20" and 22" lengths (other lengths to order).

8769  
STYLE 18 18" LENGTH  
100 PIECES  
**GUDEBROD  
GUDE-TIES**  
NYLON TYPE 1 FINISH B  
MIL-T-43435 MIL-T-713A  
GUDEBROD BROS. SILK CO., INC.  
PHILADELPHIA • NEW YORK • BOSTON  
CHICAGO • BURBANK • CHARLOTTE

### Try **GUDEBROD'S SYSTEM "S"**

In spot tying when you combine Gudebrod Gude-Ties with Gudebrod Gude-Snips and the Gudebrod Swivel-Tilt Harness Board Mount you're really streamlining the production of wire harnesses. Gude-Snips, palm-of-the-hand snips cut cleanly, easily—right or left hand. Spring action, Du Pont Teflon bearing. Eliminate constant reaching for knife or shears. The balanced, three dimensional action of the Gudebrod Swivel-Tilt Harness Board Mount brings every section of the harness within easy, comfortable reach.

Cuts fatigue — speeds work. Ask for full information about Gudebrod System "S" for spot tie lacing. (For continuous tying, ask about System "C".)

Gudebrod Swivel-Tilt  
Harness Board Mounts  
available in several sizes

**G**UDEBROD

*Electronics Division*

GUDEBROD BROS. SILK CO., INC. Founded 1870, 12 South 12th Street, Philadelphia, Pa. 19107

1870—100 Years of Quality—1970

# AMPERITE

## Thermostatic DELAY RELAYS

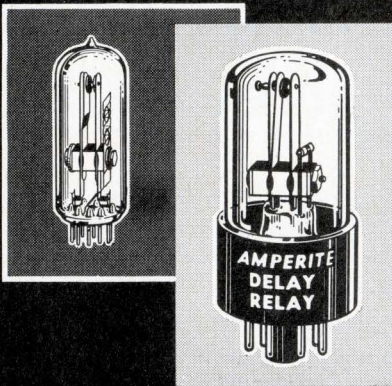

**Only a glass seal**  
offers true hermetic sealing  
... assuring maximum stability and life!

**Delays: 2 to 180 seconds** . . . Actuated by a heater, they operate on A.C., D.C., or Pulsating Current . . . Being hermetically sealed, they are not affected by altitude, moisture, or climate changes . . . SPST only—normally open or normally closed . . . Compensated for ambient temperature changes from  $-55^{\circ}$  to  $+80^{\circ}$  C. . . Heaters consume approximately 2 W. and may be operated continuously . . . The units are rugged, explosion-proof, long-lived, and—inexpensive!

**TYPES:** Standard Radio Octal, and 9-Pin Miniature.  
List Price, \$4.00

**PROBLEM? Send for Bulletin No. TR-81**

# AMPERITE

## BALLAST REGULATORS

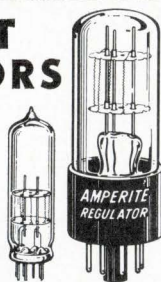
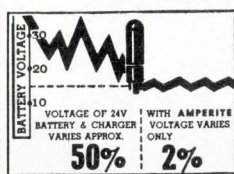

Hermetically sealed, they are not affected by changes in altitude, ambient temperature ( $-50^{\circ}$  to  $+70^{\circ}$  C.), or humidity . . . Rugged, light, compact, most inexpensive . . . List Price, \$3.00.

Write for 4-page Technical Bulletin No. AB-51

# AMPERITE

600 PALISADE AVE., UNION CITY, N.J.  
Telephone: 201 UNion 4-9503  
In Canada: Atlas Radio Corp., Ltd.,  
50 Wingold Ave., Toronto 10

Circle 65 on Inquiry Card

## NEW PRODUCTS

### RADIAL LEAD INDUCTOR

Values from 0.10 to 100,000  $\mu$ H.

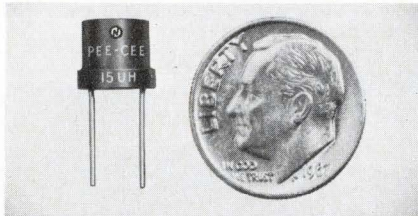

"Pee Cee Ductor" is a fixed shielded rf inductor for pc applications. Designed to meet Mil-C-15305C, Grade 1, Class B requirements, it has unitized epoxy-molded construction. Standard inductance tol. is  $\pm 10\%$ . Printed board mounting is facilitated by 0.200 grid spacing to allow for max. density packaging. Nytronics, Inc., 550 Springfield Ave., Berkeley Heights, N.J. 07922.

Circle 233 on Inquiry Card

### CRYSTAL FILTER

Operates at std. i-f of 21.4 MHz.

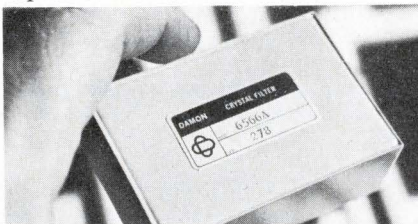

This band-pass filter has a 60 dB to 3 dB bandwidth ratio of 1.22:1 nom. from  $-55^{\circ}$  to  $+85^{\circ}$  C. Designed for use in communications receivers, radar and telemetry systems, Model 6566A has a 3 dB BW of 26 kHz and an insertion loss of 4 dB. Passband ripple is  $\pm 3/4$  dB with an ultimate rejection of 80 dB min. Source imp. is 50  $\Omega$  and load imp. is 200  $\Omega$ . Damon/Electronics Div., 115 Fourth Ave., Needham Heights, Mass. 02194. (617) 449-0800.

Circle 234 on Inquiry Card

### CERMET MATERIALS

For film resistors and hybrids.



New thixotropic pastes come with TCR levels of from 100  $\Omega$ /sq. to 10 k $\Omega$ /sq. They are completely blendable over the entire sheet resistivity range, and accept laser trimming very well. They are reproducible batch-to-batch and meet or exceed appropriate Mil Specs. Cermetalloy, Cermet Div. of Bala Electronics Corp., Box 465, Bala-Cynwyd, Pa. 19004. (215) 828-4650.

Circle 235 on Inquiry Card

### HV FET INPUT OP AMP

Features low bias current.

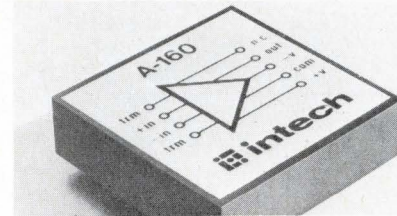

Model A-160 op amp has a 10 pA max. input bias current with supply voltages up to  $\pm 50$  V, 94 dB min. CMR and 20  $\mu$ V/V supply rejection. It also offers 20 V/ $\mu$ s min. slewing rate, 200,000 min. open loop gain and 4 MHz typ. BW. Initial offset voltage is 1 mV max. adj. to zero and max. drift is 25  $\mu$ V/ $^{\circ}$ C. \$85 (1-9). Intech Inc., 1220 Coleman Ave., Santa Clara, Calif. 95050. (408) 244-0500.

Circle 236 on Inquiry Card

### DIP TEST SOCKETS

Devices inserted with leads up.

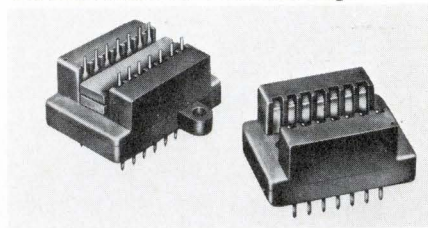

The need to manipulate leads into individual contacts is eliminated with 121-0102 series inverted sockets. Positive wiping-action spring contacts are recessed in deep grooves to guide leads during insertion. Contact res. of  $< 0.010 \Omega$ , max. current of 1.0 A, dielectric withstanding volt. of 1800 Vrms, and interlead capacitance of 0.6 pF at 1.0 MHz. \$1.58 to \$2.95. Barnes Corp., 24 N. Lansdowne Ave., Lansdowne, Pa. 19050. (215) 622-1525.

Circle 237 on Inquiry Card

### LOW PRESSURE TRANSDUCER

With input to output isolation.

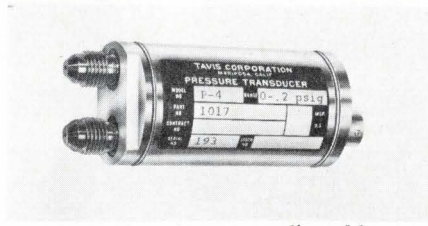

Model P-4 features adjustable zero and full scale and low power consumption. Ranges of 0-0.1 to 0-100 psia, psig, or psid are available. It operates on 20 to 40 Vdc unregulated power at 6 mA. Available with outputs of 0-5,  $\pm 2.5$ , or  $\pm 5$  Vdc. Tavis Corp., Bootjack Rd., Mariposa, Calif. 95338.

Circle 238 on Inquiry Card

## ROTARY SWITCH

24-position (15° angle of throw).

This miniaturized switch has a 1.350 in. dia. with a behind-panel dimension of 0.916 in. for a one-deck unit. Each additional deck adds about 0.333 in. It is available with 1 to 12 poles/deck and with as many as 12 decks in a switch. A total of 12 poles is the max./switch. Series 53M15 is rated at ¼ A, 115 Vac, res. load, and ¼ A, 6-28 Vdc, res. load. Grayhill Inc., 543 Hillgrove Ave., LaGrange, Ill. 60525. (312) 354-1040.

Circle 239 on Inquiry Card

## LEAD STRAIGHTENER

Increases component processing speed.

"Niagara Wire Straightener" increases axial lead component output from 100/hr. by manual operation to over 3,000/hr. It accepts deformed wires in angles of up to 45° from centerline axis, in variable lengths from 0.500 to 3.0 in. In diameters from almost zero to 0.250 in. It can be set to accept miniature resistors, capacitors, transistors, diodes, and so forth. Niagara Electro-Mechanical Corp., 1280 Erie Ave., North Tonawanda, N. Y. 14120.

Circle 240 on Inquiry Card

## THUMBWHEEL SWITCHES

Protect equipment.

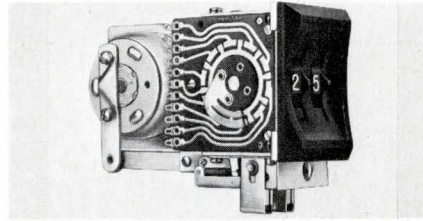

These switches protect important processes and production machines from damage caused by switching, unknown to the operator. This is done by locking thumbwheel switches into positions from which they can be released only by a constant duty dc solenoid, either remotely controlled or key controlled. Solenoid can be supplied as a remote-control feature only (Series LRT-27000-S as shown in photo) or as a manual and remote feature (Series TIR-27000). About \$75 for a 3-module assembly. Chicago Dynamic Industries, Inc., Precision Products Div., 1725 Diversey Blvd., Chicago, Ill. 60614. (312) 935-4600.

Circle 241 on Inquiry Card

## INJECTION MOLD MACHINE

Has automatic cycling.

Multa-Press G-55 ram-operated vertical injection molding machine has both semi-automatic and manual controls with adjustable injection pressure to 16,000 psi and clamp pressure to eight tons. The dual-heat zone cylinder gives a 2 oz. shot size with 6 lbs./h plasticizing capacity. It takes all normal thermoplastic and injection moldable thermoset materials. Morgan Industries, Inc., 3311 E. 59th St., Long Beach, Calif. 90805. (213) 634-4074.

Circle 242 on Inquiry Card

## HIGH POWER TWT

With broadband match.

The YH1150 is a water-cooled helix type, high power cw TWT suitable for troposcatter radio links in the range of 1.7 GHz—2.1 GHz. Its cw rf output power is 1 kW. A gain of 26 dB may be realized. Electron beam is focused by a solenoid with low dc power consumption. The amplifier is short-circuit stable. Telefunken, South St., Roosevelt Field, Garden City, L.I., N.Y. 11530. (516) 741-1390.

Circle 243 on Inquiry Card

# a Perfect Marriage

## Megasample Multiplexing and Conversion

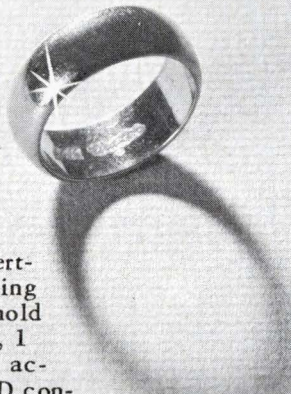

DYNATRONICS combines a high speed A/D converter with multiplexing and sample and hold to provide 10 bit, 1 megasample data acquisition and A/D conversion - field proven in operational systems - with only four cards:  
 ADC-7 A/D Converter. Up to 12 bits. Two cards.  
 ICC-641 Multiplexer. 32 channels. One card.  
 ICC-640 Dual Sample and Hold. One card.

A complete line of Integrated Circuit Cards is offered as building blocks for digital data systems.

**GENERAL DYNAMICS**  
**Electronics Division - Dynatronics Operation**  
 P. O. Box 2566, Orlando, Florida 32802

Circle 66 on Inquiry Card

## Rotron brings a new DIMENSION for LOW PROFILE cooling applications



A fan that's just 3 1/8" square — fits standard 3 1/2" rack panel. Delivers big 33 CFM of air at free delivery.  
 ■ Pressure characteristics better than larger conventional fan designs. ■ Optimum performance. .05 to .075 inch water at 25-30 CFM. ■ Double flange construction for universal flush mounting. ■ Low maintenance.

Aerodynamic design provides high pressure in range approaching free delivery.

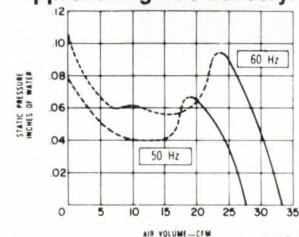

Available from stock



For complete technical details write today to Rotron Incorporated, Woodstock, N.Y. 12498

Circle 67 on Inquiry Card



## RF and POWER SWITCHES

A complete line of rotary, high voltage and high current ceramic-type switches for RF and low frequency applications.

Write for catalog, containing information on the mechanical and electrical properties of our standard line of switches.

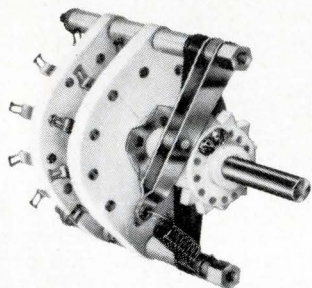

**RADIO SWITCH CORPORATION**

P.O. Box 79, Marlboro, N.J. 07746  
Tel (201) 462-6100

Circle 68 on Inquiry Card

## NEW PRODUCTS

### DC SERVO MOTOR

Drives computer cassette tapes.



This dc motor directly drives cassettes for digital data entry at speeds from 2 to 20 ips without requiring any intervening mechanical gearing. The size 13 motor has low ripple torque to keep tape drive uniform and speed control accurate to within  $\pm 3\%$ , a high starting torque and a low starting voltage. Usually, two motors are needed—one driving the tape, the other working off a low signal to maintain proper tape tension. Clifton Div., Litton Precision Products Inc., Marple at Broadway, Clifton Heights, Pa. 19018. (215) 622-1000.

Circle 244 on Inquiry Card

### SIGNAL ISOLATOR

For dc-to-dc isolation.

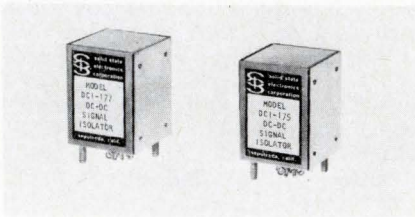

Model DC1-177 is useful for: floating signals off ground, isolating different signal grounds, isolating high potential difference circuits (to 500 V), 180° phase inversion, dc polarity reversal or ac phase inversion, and providing an additional isolated ref. voltage or LV power supply. Input signals from -10 to +10 Vdc or 20 V pk-to-pk ac can be isolated and transferred to an isolated two-port. Solid State Electronics Corp., 15321 Rayen St., Sepulveda, Calif. 91343. (213) 785-4473.

Circle 245 on Inquiry Card



WE WANT OUR NAME ON THE TIP OF YOUR TONGUE!

**Scotchpar** 3M  
BRAND POLYESTER FILM COMPANY

# LITERATURE

## Instrumentation handbook

Just as you pick up the Hewlett-Packard catalog to "brush up" on the basic principles of counters or Wien-bridge oscillators, you will find yourself referring constantly to the Honeywell Instrumentation Handbook; not only for product information, but also for the excellent glossaries and short technical notes on the basic principles behind many of the instruments Honeywell sells. We found the glos-

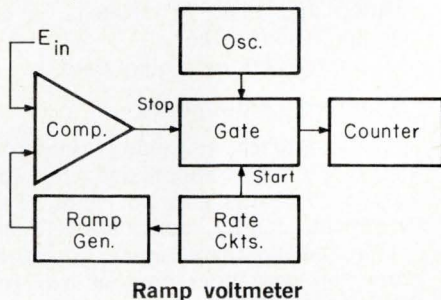

Ramp voltmeter

saries of transducer terms, the application note on signal conditioners, and the basic principles for the different types of digital voltmeters, of particular interest to our readers. These, incidentally, include not only the principles behind Honeywell multimeters and panel meters, but also those applying to DVMS of other manufacturers. Honeywell Inc., Test Instruments Div., 4800 E. Dry Creek Rd., Denver, Colo.

Circle 361 on Inquiry Card

## Industrial catalog

New products for industrial use are introduced in this 56-page supplement to the company's 1970 industrial catalog. You will find a useful semiconductor and IC directory, plus information on digital display equipment, oscilloscopes, power supplies, and other industrial products. Allied Electronics Corp., 100 N. Western Ave., Chicago, Ill. 60680.

Circle 362 on Inquiry Card

## Hybrids

The essential details of thick-film hybrid circuits, how they are made, and why they provide the best solutions to circuit miniaturization are explained to you in this 16-page brochure. The development and design conditions are outlined for you, and the company explains their methods and capabilities in meeting these requirements. Centralab Semiconductor, 4501 North Arden Dr., El Monte, Calif. 91734.

Circle 363 on Inquiry Card

## Millimeter wave catalog

All the way from Japan comes this 75-page catalog containing 420 products of mm wave test equipment and components covering from 18 to 170 GHz. Frequency meters, attenuators, and phase shifters are among the direct reading instruments discussed. Other feature products include a precision standing-wave detector, dry calorimeter, and a matched hybrid tee. Specs are given for all products, performance curves for principal equipment. Hitachi Ltd., Telecommunications Dept., International Div., Nippon Bldg., No. 8, 2-chome, Ohtemachi, Chiyoda-ku, Tokyo, Japan.

Circle 364 on Inquiry Card

## ICs

Integrated circuits in the 5400 and 7400 TTL series are the subject of a 32-page brochure. Following Fairchild's initial entry into the 7400 market, the publication covers the first 24 products in their series and indicates the recommended operating con-



ditions for these circuits. Nine full pages are devoted to diagrams and schematics showing test circuits and voltage waveforms. Fairchild Semiconductor, Box 1058, Mountain View, Calif. 94040.

Circle 365 on Inquiry Card

## Low cost transistors

A line of plastic-encapsulated silicon bipolar, unijunction, and field effect transistors are detailed in a 12-page brochure. The economy transistors meet high reliability specifications and offer such benefits as moisture resistance, stability, solderability, ruggedness, and indexability. An application guide listing device recommendations and electrical parameters is provided, as is a cross-reference of transistor type designations, direct replacements, preferred types, and equivalents. Texas Instruments Inc., Inquiry Answering Service, P.O. Box 5012, M/S 308, Dallas, Texas. 75222.

Circle 366 on Inquiry Card

## Computer handbook

If you're interested in mini-computers, you'll want a copy of this 408-page manual describing the Varian 520/i minicomputer priced at \$7500. Systems designers, programmers and users will find its descriptions of hardware, interfaces and software useful references. Since the various sections are cross-referenced, you'll have no trouble finding the information you need. Varian Data Machines, 2722 Michelson Dr., Irvine, Calif. 92664.

Circle 367 on Inquiry Card

## DC-to-dc transformers

A selector guide devoted to dc-to-dc converter transformers is suggested for engineers involved in circuitry using magnetic components. Power ratings from 25 mW to 125 VA are provided and the possibilities of using plus and minus output voltages in op-amp applications are explored in schematics. A feature of the catalog is a discussion of compact dc-to-dc converter transformers that operate at a switching frequency of 20 kHz and have a power output of 30 VA. Microtran Co., Inc., Valley Stream, N.Y. 11582.

Circle 368 on Inquiry Card

## Testing digital ICs

A method of performing both parameter and functional tests simultaneously for all combinations of inputs has been termed the analogical circuit technique. The method has been applied to test instruments making possible high speed, go/no-go testing as well as evaluation and parameter

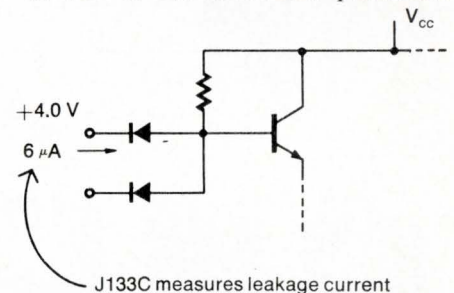

analyses of ICs. The instrument (designated ACT 1) is described in a 12-page brochure. Though it is primarily an incoming inspection instrument, it is available for engineering use by adding such accessories as an analog programmer, evaluation test deck, and a pattern control unit. Teradyne Inc., 183 Essex St., Boston, Mass. 02111.

Circle 369 on Inquiry Card

## LITERATURE

### Signal conditioning

The six basic types of signal sources, conventional amplifier input configurations, and proper grounding techniques are explained to you in this 16-page booklet. It is filled with illustrations to help you select the proper amplifier and signal cabling methods for your application, and you receive instructions for eliminating the problems of signal cable shielding and ground loop. Brush Instruments Div., Gould Inc., 3631 Perkins Ave., Cleveland, Ohio 44114.

Circle 370 on Inquiry Card

### Power supplies

Whether your application is op amps, ICs, logic circuits, relays, lamps, or electronic measuring equipment, you're sure to find the right ac-to-dc plug-in power supplies among the 82,000 listed in this 24-page catalog. And just as important—the model you choose from this catalog will be shipped to you three days after receipt of order. The company will also ship a completely wired, multiple-output, power supply system in just nine days. Acopian Corp., Easton, Pa. 18042.

Circle 371 on Inquiry Card

### FETs and ICs

Choose your FET by number or by application—it's listed both ways in this 12-page short form catalog. And if you don't find the one you need, call the company and they'll make one specially for you. All the digital and

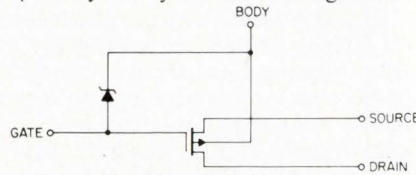

#### Zener gate protection

linear ICs described are accompanied by schematics. An OEM price list is included for your convenience. Siliconix Inc., 2201 Laurelwood Rd., Santa Clara, Calif. 95054.

Circle 372 on Inquiry Card

### Product selector guide

Switches, readouts, and indicator lights are listed in a 55-page, sectioned product selector guide. Each section offers data on indicators by size or product grouping. The reference is indexed. Dialight Corp., 60 Stewart Ave., Brooklyn, N.Y. 11237.

Circle 373 on Inquiry Card

### Computer glossary

More than a hundred words of the jargon of the computer industry are defined in this 8-page glossary. It covers the gamut from "access time" to "zero suppression." Definitions provide cross-references, synonyms and/or antonyms, and table illustrations where necessary. In defining abbreviations, root words are given in addition to the explanation. For instance: "FORTRAN: Formula Translator. The language for a scientific procedural programming system." General Automation Inc., 706 W. Katella Ave., Orange, Calif. 92667.

Circle 374 on Inquiry Card

### Standard components

A comprehensive catalog brings you information on standard inductor, capacitor, resistor, and pot lines. The electrical, density, and physical and environmental characteristics of inductors and capacitors are outlined for you, and complete specs are given for resistors and pots. The 42-page catalog is offered to you by Nytronics Inc., 550 Springfield Ave., Berkeley Heights, N.J. 07922.

Circle 375 on Inquiry Card

## Proven: Your most efficient circuit board heat sink . . . .

NATURAL CONVECTION CHARACTERISTICS

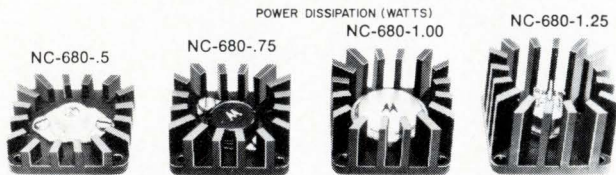
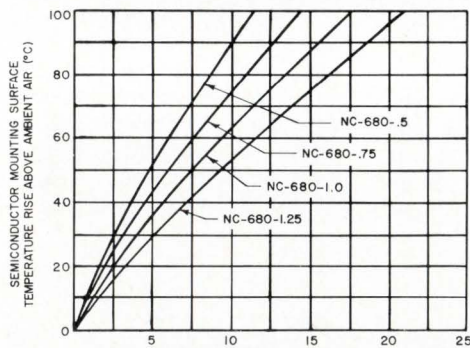

Most versatile line of 1100 aluminum heat sinks dissipates up to 15 watts with an 80°C rise. Free air circulation design permits mounting in any position. Accepts nearly all popular transistors.

Only 73¢ in lots over 500. Send for Bulletin 680.

**WAKEFIELD**  
DELTA DIV. ENGINEERING INC., Wakefield, Mass. 01880 • 617-245-5900

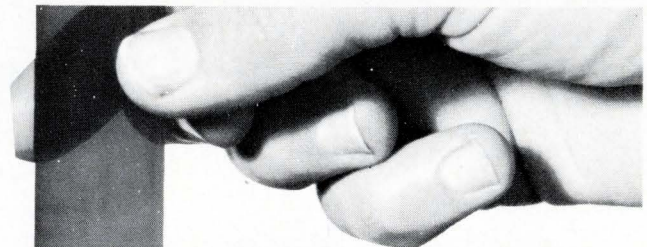

## DILECTRIX DF-1300 TFE Teflon\* cast tape...

Adds moisture barrier and chemical resistance to insulation systems

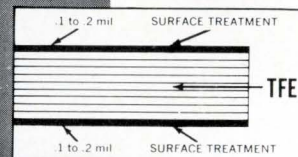

Here's a void-free multi-laminar cast TFE tape with zero moisture absorption. And in combination with other material adds a weatherproof and chemical barrier to an

insulation system. Both surfaces are receptive to bonding agents assuring complete bonding to other materials.

Dilectrix DF-1300 TFE Teflon Tape adds excellent protection in moist and corrosive environments. Available up to 2½ mils thick, ¼" to 12" wide. Send for complete technical data and free sample.

**Dilectrix**

CORPORATION  
A SUBSIDIARY OF NATVAR CORPORATION  
69 Allen Blvd., Farmingdale, N. Y. 11735

\*DuPont trademark

### D/A converters handbook

Aimed at design and application engineers, a 28-page guide to D/A converters is divided into three sections. Section one covers basic theory and includes typical circuits and definitions of parameters. Section two describes applications for the devices, and section three provides technical information on a line of ultraminiature D/A converters. Datel Corp., 943 Turnpike St., Canton, Mass. 02021.

Circle 376 on Inquiry Card

### Chemicals catalog

A 1970 catalog devotes itself to inorganic and organometallic chemicals, ultrapure chemicals, pure metals, and related materials for research. Included in this year's version are 200 elements available from the company, as well as analytical data on the metals being offered. Color-coded for quick and easy reference, the catalog is available to research scientists in chemistry, physics, electronics, and optics. Alfa Inorganics Inc., Box 159, Beverly, Mass. 01915.

Circle 377 on Inquiry Card

### Application report

Schematics thoroughly illustrate the applications of the SN 54/74154 decoder/demultiplexer IC discussed in this 8-page report. You will learn the internal logic design and performance capabilities of the device as a 4- to 16-line decoder, or as a 1- to 16-line demultiplexer. Switching characteris-

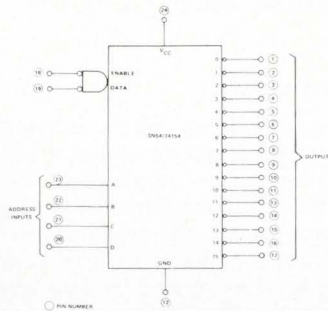

tics are given in chart form and truth tables are listed for all 16 outputs. The reduction in package count, number of interconnections, and wiring complexity will give you the increased reliability you're looking for. Texas Instruments Inc., Box 5012 M/S 308, Dallas, Texas 75222.

Circle 378 on Inquiry Card

### Logic handbook

A third edition of a control handbook is aimed at specifiers, designers, manufacturers, and/or users of electronic or mechanical logic for instrumentation and control. The 282-pager deals with available methods and products for implementing fast and reliable solid-state electronic control systems. Low-cost logic and interfacing modules designed to operate in an electrically noisy environment are featured. Application notes to aid the reader in designing systems from the modules are included.

Available on company letterhead from Digital Equipment Corp., 146 Main St., Maynard, Mass. 01754.

### Power systems supplement

A complete line of standard power supplies are described in a 31-page brochure. Each system discussed is supplied with power controls, systems metering panel, and cables to facilitate ordering a complete power system ready for hook-up. Lambda Electronics Corp., Route 110, Melville, N.Y. 11746.

Circle 379 on Inquiry Card

# engineers with good connections keep up their contacts



They use MS-230 Contact Re-Nu to maintain full electrical continuity on relays, connectors... all types of contacts where dirt, erosion dust and greasy films can lead to erratic operation. MS-230 is formulated especially

for cleaning contacts. Make it a part of your regular preventive maintenance program.

Write on your company letterhead for a free 16-oz. sample. For literature only, use bingo card.



**miller-stephenson chemical co., inc.**

Route 7, Danbury, Conn. 06813

## LITERATURE

### Application note

Much of the subject material encountered in engineering and electronic technician courses has to do with the frequency behavior of electrical networks. This 17-page note, "Using the 675/676A Network Analyzer as an Educational Tool," demonstrates sev-

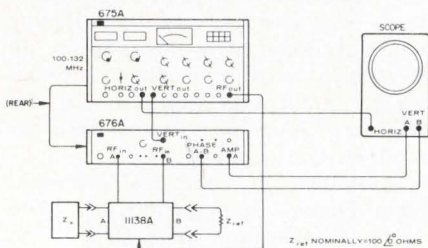

Setup for measuring complex impedance

eral network responses which might be useful in the classroom. If you're a design engineer, you'll find the included Nichol's chart oscilloscope CRT overlay useful in predicting the closed loop behavior of feedback network designs. Hewlett-Packard, 195 Page Mill Rd., Palo Alto, Calif. 94306.

Circle 380 on Inquiry Card

### Special offer

A "Guide to Thick-Film Hybrid Design" wall chart, 14 by 22 inches, in full color, is available from Sylvania Electric. The chart contains important information about active devices, inks and passive components, along with useful packaging information. For your free copy,

Circle 381 on Inquiry Card

### Data services

Because Honeywell is a complex corporation it has developed many information system applications for its own use. Now these internal resources are brought directly to you. This 20-page brochure describes six data-processing services offered by data centers in sixteen cities. These include time-sharing, remote and on-site batch data processing machine time, contract software, systems consulting, and facilities management. Honeywell Information Services Div., G2118, 2701 Fourth Ave. S., Minneapolis, Minn. 55408.

Circle 382 on Inquiry Card

### Computer data reduction

If you send for this 22-page publication you will be adding another section to your "Semiconductor Strain Gage Handbook." (In case you missed the first offer, the other seven sections are also available.) This part covers the basic problems involved in the reduction of data from semiconductor

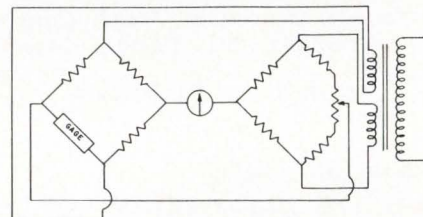

Standard strain indicator with separate balancing bridge

gages, the availability and applicability of time-sharing computers for this reduction, and five programs appropriate to strain data reduction and transducer compensation, each accompanied by a typical data run. BLH Electronics Inc., 42 Fourth Ave., Waltham, Mass. 02154.

Circle 383 on Inquiry Card

## FOR EXCELLENCE IN ROTARY SWITCHES SPECIFY GRAYHILL

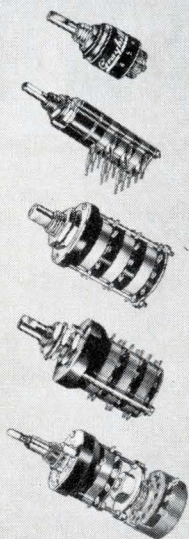

- 15°, 30°, 36°, 45°, 60° or 90° Angle Of Throw
- 2 To 24 Positions Per Pole
- Ratings Up To 15 Amps.
- 1 To 6 Poles Per Deck
- 1 To 12 Decks
- Diameters 1/2" To 2 1/4"
- Shorting Or Non-shorting Contacts
- Explosion Proof

- Military Or Commercial Styles
- Single Or Concentric Shafts
- Solder Lug Or Printed Circuit Terminals
- Switch And Potentiometer Combinations
- Key Lock Option
- Homing Rotor (Bridging And Shorting) Option
- Spring Return Option
- Power or Signal Switching
- Isolated Position (Pull-To-Turn) Option
- Adjustable Stop Option



For your Grayhill Engineering Catalog offering complete technical data—contact

543 Hillgrove Avenue  
LaGrange, Illinois 60525  
Area Code 312, Phone 354-1040



... the Difference Between Excellent and Adequate

134

Circle 73 on Inquiry Card

## Ultra critical uses?

Model	Resistance Range	Power Rating @ 70°C	*Max. Oper. Volts	Length Inches	Diameter Inches
MOX-400	1 - 2500 megs	.25W	1,000V	.420 ± .050	.130 ± .010
MOX-750	1 - 5000 megs	.50W	2,000V	.790 ± .050	.130 ± .010
MOX-1125	1 - 10000 megs	1.00W	5,000V	1.175 ± .060	.130 ± .010
MOX-1	10K - 500 megs	2.50W	7,500V	1.062 ± .060	.284 ± .010
MOX-2	20K - 1000 megs	5.00W	15,000V	2.062 ± .060	.284 ± .010
MOX-3	30K - 1500 megs	7.50W	22,500V	3.062 ± .060	.284 ± .010
MOX-4	40K - 2000 megs	10.00W	30,000V	4.062 ± .060	.284 ± .010
MOX-5	50K - 2500 megs	12.50W	37,500V	5.062 ± .060	.284 ± .010

\*Applicable above critical resistance. Maximum operating temperature, 220°C. Encapsulation: Si Conformal.

## Mastermox Resistors are still the best answer.

10K ohms to 10,000 Megohms Resistance

Mastermox resistors bring new accuracy to ultra-precision applications. Advanced metal oxide glaze construction. More watts per cubic inch means twice the performance in equivalent space. Stable? To new limits! Use Mastermox resistors to obtain new performance highs.

Send for Mastermox brochure.

DMA 536

VICTOREEN INSTRUMENT DIVISION  
10101 WOODLAND AVENUE • CLEVELAND, OHIO 44104  
EUROPE: ARNDALE HOUSE, THE PRECINCT, EGHAM, SURREY, ENGLAND • TEL: EGHAM 4887



Circle 74 on Inquiry Card



### Correlation analysis

A comprehensive description of auto- and cross-correlation techniques is provided in a 19-page bulletin. Applications in characterizing linear systems are covered, as are vibration analysis, turbulent fluid flow, cross-talk identification, EEG signal analysis, and noise studies. Descriptions of signal correlators and a Fourier analyzer are contained and operational theory is included. Graphs and schematics are generously used throughout the bulletin. Princeton Applied Research Corp., Box 565, Princeton, N.J. 08540.

Circle 384 on Inquiry Card

### Thermoelectric manual

This company's complete line of thermoelectric products is covered in a 104-page manual. Application notes, technical and performance data on thermoelectric components, assemblies, power supplies, temperature controllers, instruments and accessories are all included. The publication is available from Cambridge Thermionic Corp., 445 Concord Ave., Cambridge, Mass. 02138.

Circle 385 on Inquiry Card

### Mini rectangular connectors

Two separate lines of mini-rectangular connectors which accept crimp-removable snap-lock contacts are outlined in a 23-page catalog. The two connector lines described are the Trim Trio, which accommodates #30 solid—#14 stranded wire in turned, formed or sub-miniature coaxial con-

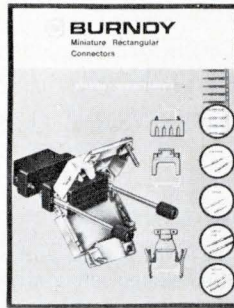

tacts, and the MS HYFEN line with a diameter contact of .040 in. Schematics, dimensions, and tooling requirements for each type of contact are provided, along with descriptions for hand and automatic tooling equipment. Burndy Corp., Norwalk, Conn. 06852.

Circle 386 on Inquiry Card

### SCR systems glossary

Definitions for avalanche diode, closed-loop feedback, full and half wave rectification, and zener diode are among those included in this 4-page glossary of terms applicable to SCR adjustable speed/torque drive systems. Bodine Electric Co., 2500 W. Bradley Pl., Chicago, Ill. 60618.

Circle 387 on Inquiry Card

### CAD and test center

This is an explanation of what this new company does, what they do it with, and how they do it. It carefully outlines the steps involved in computer-aided design of a circuit board and the necessary testing required to make it acceptable to you, the customer. It is written in terms understandable to those unfamiliar with the computerman's language. The importance of people is emphasized, and to show you just how important *their* people are, a background of each top man, covering his work and accomplishments, is included. A most informative 35-page book. Telpar, 4300 Sigma Rd., Dallas, Texas 75234.

Circle 388 on Inquiry Card

BRAND POLYESTER  
**Scotchpar**<sup>®</sup>  
FILM

WE WANT OUR NAME  
ON THE TIP  
OF YOUR TONGUE!

**3M**  
COMPANY



## LITERATURE

### Design guide

Packaging and cable designers will be interested in this 24-page design guide which illustrates the use of flexible etched cables in component and system designs. Graphic illustrations show good high-density, low-volume interconnection and cable designs. Electro-Mechanisms, 29 Crown St., Nashua, N.H. 03060.

Circle 389 on Inquiry Card

### Disconnect terminals

High reliability disconnect terminals for a variety of applications are discussed in a 6-page bulletin. Suggested for electronic production, cable and harness terminations, pc boards, interconnections, customized back planes, test panels, programming boards and stranded-wire terminations to wire-wrap pins, the terminals are available with solder, gold, or nickel coatings. Also included are descriptions of hand and crimping tools to facilitate crimping of terminals to leads. Berg Electronics, Inc., New Cumberland, Pa. 17070.

Circle 390 on Inquiry Card

### Data transmitter

Bulletin .07 describes a solid-state data transmitter which has been designed for use with Bell Systems' data phone. The unit combines direct manual data entry and visual verification of entered data, and is suggested for applications in professional and small business billing, ordering systems, and inventory systems. Included in the brochure are salient features and specs for the device. Datron Systems Inc., 100 Route 46, Mountain Lakes, N.J. 07046.

Circle 391 on Inquiry Card

### Enclosure styling

Rack modularization and standardization plus design customization are offered to you in a new concept in electronic enclosure styling. Interchangeable horizontal and vertical extrusions allow you to choose from 33 different styling treatments or ensembles. This 12-page catalog will help you to select the style features you prefer. Amco Engineering Co., 7333 W. Ainslie St., Chicago, Ill. 60656.

Circle 392 on Inquiry Card

### Heat sinks/dissipators

After a general discussion of semiconductor heat sinks/dissipators for metal and plastic case transistors and diodes, each individual device is illustrated and described. The text clearly explains the purpose and capabilities of each device, diagrams give dimensions, and charts indicate performance characteristics. This 32-page catalog is offered by International Electronic Research Corp., 135 W. Magnolia Blvd., Burbank, Calif. 91502.

Circle 393 on Inquiry Card

### Silicone resin

Two separate literatures describe different aspects of silicone resins for electrical insulation. Publication C1 contains a summary of properties and application of MS silicone resins for electrical insulation and includes graphs, tables, and application data. Publication C14 is a guide to various products for application in silicone varnish, flexible insulation, silicone resin-bond, rigid insulation and silastomer flexible insulation. Midsil Corp., Box 475, Emerson, N.J. 07630.

Circle 394 on Inquiry Card

## ABSOLUTE SHAFT ENCODERS WITH FAR FEWER BRUSHES

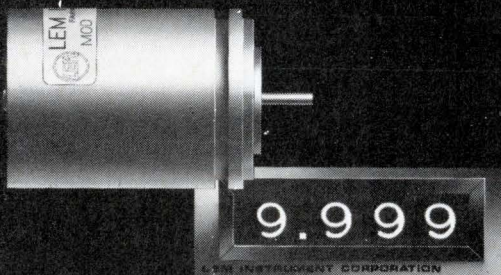

- UNLIMITED CHOICE OF FUNCTION • LOW COST • LOW TORQUE & INERTIA • NON-AMBIGUOUS, CONTINUOUS, PARALLEL OUTPUT • LOW NOISE

The new LEM Shaft Encoders utilize a unique disc, brush assembly and electronic configuration that makes it possible to encode any function in any code with the same basic disc and rotating brush arrangement.

High reliability, low torque and inertia, self-contained logic, low noise and long trouble-free life are a few of the features offered by the new LEM units.

These new shaft encoders are available in all standard and any special codes and functions at low cost. Also available is a complete line of solid state, digital displays compatible with the new encoder line. Request new catalog.

# LEM

**INSTRUMENT CORPORATION**  
Subsidiary of TWIN DISC, INCORPORATED  
20 Sarah Drive, Farmingdale, New York 11735  
Phone (516) 293-7240

Circle 76 on Inquiry Card

## VARGLAS ACRYLIC SLEEVING

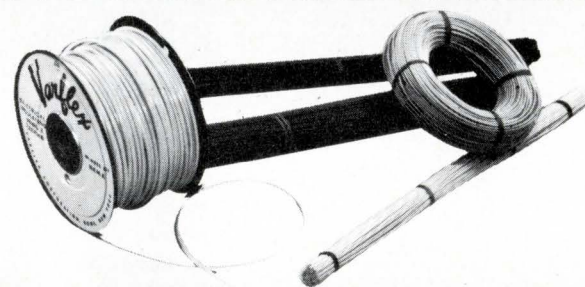

## FOR CLASS F APPLICATIONS

Varglas Acrylic Sleeving by Varflex will not soften, flow or blister — even at 155°C, for as long as 15,000 hours. In fact, it passes the thermal endurance test under MIL-1-3190 (latest revision).

Made of modified acrylic resin on Fiberglass braid, it is compatible with polyester, epoxy, phenolic or formvar coatings and is made to exceed military, IEEE and NEMA standards. Varglas resists acids, solvents, oils, alkalis, fungus and moisture.

Select from a wide range of sizes and coding colors. Immediate off-the-shelf shipment or one week for special production.

Send for free sample of  
this and 24 other sleeveings.  
**VARFLEX CORPORATION**  
506 W. Court Street  
Rome, New York 13440

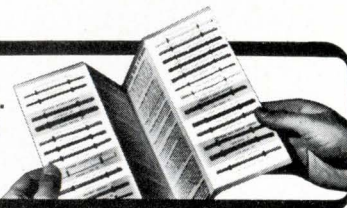

Circle 77 on Inquiry Card

## Computer handbook

Intended to acquaint the reader with a family of small, general-purpose computers, a 404-page handbook (soft-cover) surveys two central proc-

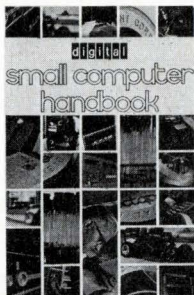

essors, covering interfacing and operating characteristics. Appendices and conversion tables are included in the reference. Digital Equipment Corp., 146 Main St., Maynard, Mass. 01754.  
Circle 395 on Inquiry Card

## Voltage tunable magnetron

VTM modulation and power supply requirements are the subject of a revised 16-page bulletin. Available types of VTMs, including key features and applications of general and specific types, are listed. A section on power supply requirements details VTM power supply connections, filament, injection, and anode supply features, and includes schematics and performance data. General Electric Company, Microwave Devices Literature Section, 316 E. Ninth St., Owensboro, Ky. 42301.

Circle 396 on Inquiry Card

## Stock relays

You're sure to find the relay you're looking for among the 512 listed in this 24-page stock catalog. To make sure you've made the right selection, complete technical data, including

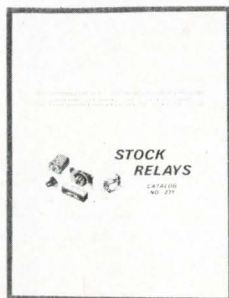

functional operating characteristics and dimensional drawings, is provided. Another convenience for you—they're ready for immediate delivery. Magnecraft Electric Co., 5575 N. Lynch Ave., Chicago, Ill. 60630.

Circle 397 on Inquiry Card

The Electronic Engineer • April 1970

## Rf connectors

All major rf connector classifications and subtypes are brought together for you in this 161-page catalog. To help you with proper identification and selection of connector types, a section on the nomenclature of connectors and fittings is included. A cross-reference to military and Dage part numbers, cable data, and cable assembly instructions are provided. You'll find the catalog fully illustrated with dimensions and engineering data for each connector type within a series. Bendix, Microwave Devices Div., Hurricane Rd., Franklin, Ind. 46131.

Circle 398 on Inquiry Card

## TTL/DTL logic modules

This new logic module line allows you to design and assemble digital systems of any nature or complexity using a broad selection of pre-engineered, general purpose logical build-

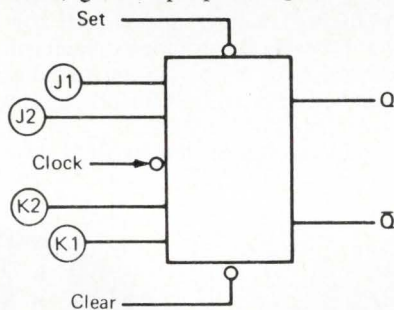

ing blocks. This 10-page selector guide provides schematic diagrams and general specs for each available module. Wyle Computer Prod., Div. Wyle Labs., 128 Maryland St., El Segundo, Calif. 90245.

Circle 399 on Inquiry Card

## Connector manual

A 28-page manual describes various types of mil-spec connectors, used in military systems design. Printed circuit, power, and communications connectors specified by eight application requirements are discussed, and a brief tabular index lists the connectors' characteristics and special features. Elco Corp., Willow Grove, Pa. 19090.

Circle 400 on Inquiry Card

## Can lugging system

Bulletin 203 discusses terminal/machine systems for high-lugging of shield cans. It describes the lugging system, and includes schematics of several lugs and shield-can mountings. Berg Electronics, Inc., New Cumberland, Pa. 17070.

Circle 401 on Inquiry Card

Circle 78 on Inquiry Card →

# packaged readouts

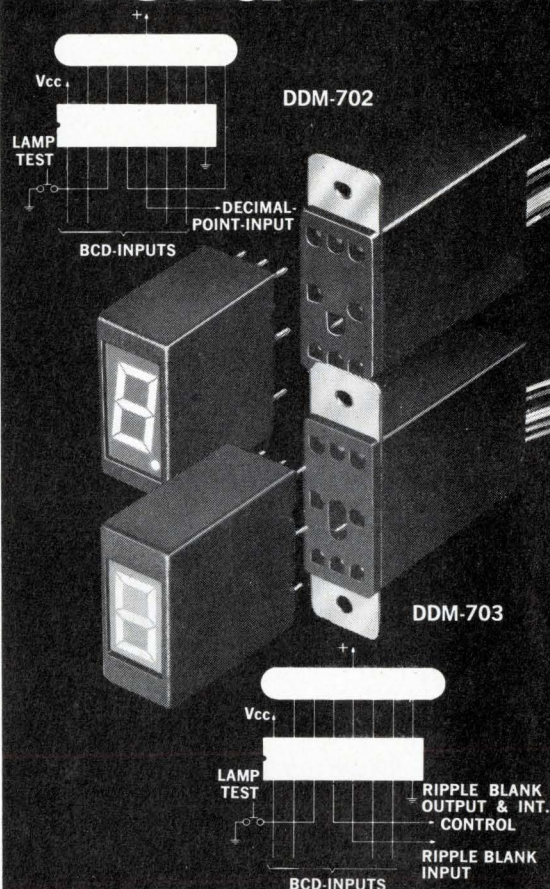

Now you can buy the complete readout and decoder/driver combination rather than assemble your own.

The ALCO "packaged readouts" include the 7-segment incandescent devices ready to plug into its own mating decoder/driver having a BCD input compatible with DTL and TTL circuitry.

Model DDM-702 has an ALCO MS-4100BC seven-segment readout and features an inverter-driver function necessary to energize the decimal point in the display device. Complete Package Price, \$19.95 (100 lot).

Model DDM-703 includes an ALCO MS-4000BC readout having a ripple blanking capability and intensity control input. Both models operate on 5V and have a lamp test provision. Complete Package, \$18.95 (100 lot).

It's more convenient to plan your designs the ALCO way. We provide a cost advantage whether application is for a prototype or in production. We also supply matching bezels and mounts to support up to 8 of the above modules.

Call us now at (617) 686-3887 and ask for one of our readout specialists.

# ALCO®

ELECTRONIC PRODUCTS, INC.

Lawrence, Massachusetts 01843

## LITERATURE

### Miniature d/a converters

An 8-page application note serves as a complete guide to the use of both the 0.4 in.-High L-series and the 7/8 cubic in. U-series "Minidac" modules, self-contained digital-to-analog converters. Given information includes comprehensive specs, operating principles and the use of modular converters in non-inverting, inverting and bipolar modes. Analog Devices, Pastoriza Div., 221 Fifth St., Cambridge, Mass. 02142.

Circle 402 on Inquiry Card

### Non-standard resistors

The "Functional Guide to Non-Standard Resistors" details the performance levels available in various types of non-standard resistors and includes charts showing the range of available lead and packaging variations. Using these charts, you can "build" resistors to meet your special needs. Throughout the 16 pages, examples illustrate how a departure from a standard design can be made to achieve a specific function. Dale Electronics Co., Box 609, Columbus, Neb. 68601.

Circle 403 on Inquiry Card

### IC logic

A comprehensive brochure (25640A) provides information on the Series 54/74 TTL ic logic. The catalog is divided into three reference sections. The first provides you with general design characteristics promoting reliable system design. The second, electrical characteristics, gives specific test limit and test condition information for use in device evaluation of 62 IC's, and the third on parameter measurement provides complete dc and ac measurement methods and procedures. Sprague Electric Co., Marshall St., North Adams, Mass. 01247.

Circle 404 on Inquiry Card

### Subminiature connectors

Connector configurations and insert types for 9, 15, 25, 37 and 50 contacts in both crimp snap-in and solder pot type terminations are given in this 28-page catalog on D-subminiature connectors. Also listed are combination layouts with provisions for inclusion of high voltage and coaxial contacts. Detailed illustrations supplement technical information and instructions. Cinch Mfg. Co., 1501 Morse Ave., Elk Grove Village, Ill. 60007.

Circle 405 on Inquiry Card

### Power supplies supplement

Published as a supplement to Power Supply Handbook 269, this 16-pager covers modular and rack-adaptable power supplies for systems, test equipment and OEM applications. Specs for standard models, as well as descriptions of power supplies capable of supplying dc volts from 0 to 180 Vdc and currents up to 70 A are provided. Trygon Electronics, Inc., 111 Pleasant Ave., Roosevelt, N. Y. 11575.

Circle 406 on Inquiry Card

### Voltage measurement

"Theory and Practical Application of Pulse and Peak Voltage Measurement" discusses the theory and techniques utilized in measuring peak values of waveforms—one-shot, repetitive and periodic. The 20-page paper also provides application data pertinent to the use of equipment such as peak reading memory voltmeters in the monitoring, life-testing, and power-aging fields. Micro Instrument Co., 12901 Crenshaw Blvd., Hawthorne, Calif. 90250.

Circle 407 on Inquiry Card

## GOOD BUY, MR. CHIPS

BY MONOLITHIC DIELECTRICS



**CHIP KIT NO. 1** consists of 300 monolithic ceramic capacitor chips for hybrid circuits. Browse, examine, and test. There are 10 chips of each standard RETMA values from 1.2 pf to 330 pf in  $\pm 10\%$  tolerances at 50 VDCW.

**CHIP KIT NO. 2** consists of 300 sample chips, 10 chips each of all standard RETMA values from 390 pf to .1 MFD in  $\pm 10\%$  tolerances at 50 VDCW.

**KIT NO. 1 or KIT NO. 2—\$49.50 ea. A GOOD BUY!**  
Delivery from stock. Call direct and ask for Jim Waldal.

Monolithic Dielectrics Inc.

P.O. Box 647, Burbank, Calif. 91503 • (213) 848-4465



Stocked in three popular functional sizes, standard Bord-Pak Cases—ranging in sizes from 5 1/16" W x 5 1/16" H x 1 1/8" D to 15 7/8" W x 5 1/16" H x 1 1/8" D—facilitates economical and attractive packaging of standard circuit guides and other electronic components. The recessed satin anodized front panel (plain or punched to specification) has polished aluminum frame, assembled with gray pebble grain, finished side panels and gray suede-like top, back and bottom.

Write today for details on cases, circuit guides and other money-saving Bord-Pak packaging services.



the BUCKEYE stamping co.  
555 Marion Rd., Columbus, Ohio 43207  
"Quality Products Since 1902"

### Wirewound resistors

"Stocked" military - precision, wirewound resistors with tolerances as accurate as 0.005% are discussed in an 8-page bulletin. Specs are conveniently condensed to table and chart form. Prices are listed for both standard and non-standard values. The company claims a "price and delivery breakthrough" due to volume production, and states that you can obtain your shipment within 3 days of receipt of order. General Resistance, Div. of Chronetics, 500 Nuber Ave., Mt. Vernon, N. Y. 10550.

Circle 408 on Inquiry Card

### DC power supplies

Ultramini dc power supplies for digital and linear ICs are the subject of a 16-page catalog/handbook. Included in the literature is a selection guide which lists the devices according to output, regulation data, and price information. Also provided is a glossary of terms, principles of operation, operating features, and detailed specs. Datel Corp., 943 Turnpike St., Canton, Mass. 02021.

Circle 409 on Inquiry Card

### The broadband generation

A 1970 version of state-of-the-art broadband products features various new devices and improved specs on all items in the product lineup. The 152-pager lists coaxial couplers, attenuators and rf and microwave instrumentation. All products are geared to the broadband concept. For ease of selection, each section is preceded by a summary. The new edition also includes a technical data section which describes measurement techniques and includes new nomographs. Narda Microwave Corp., Plainview, N. Y. 11803.

Circle 410 on Inquiry Card

### Relays

In selecting relays for a particular application you must consider the circuit design and the operating environment as well as the relay. This 20-page bulletin discusses relay selection, indicating how common pitfalls can be avoided. In addition, it introduces a series of relays suited to various applications and provides schematics and specs to help you make the right selection. Cornell-Dubilier Electronics, Div. Federal Pacific Electric Co., 118 E. Jones St., Fuquay-Varina, N. C. 27526.

Circle 412 on Inquiry Card

### D-to-A converter with muscle

An interesting brochure explaining an instrument that truly belongs to the era of systems: a power digital-to-analog converter. This instrument (H-P 6130B) delivers an analog output (up to 50 V, 1A) to the load that varies in response to digital inputs. The brochure explains performance and applications. Hewlett-Packard, New Jersey Division, 100 Locust Ave., Berkeley Heights, N. J. 201-464-1234.

Circle 411 on Inquiry Card

### High vacuum technology

A comprehensive 368-page catalog has been designed for the vacuum market. Containing information for various vacuum needs, the reference provides an index which lists compatible components and systems according to applications. Systems charts and scientific tables are included as are descriptive specs. Veeco Instruments Inc., Terminal Dr., Plainview, N. Y. 11803.

Circle 413 on Inquiry Card

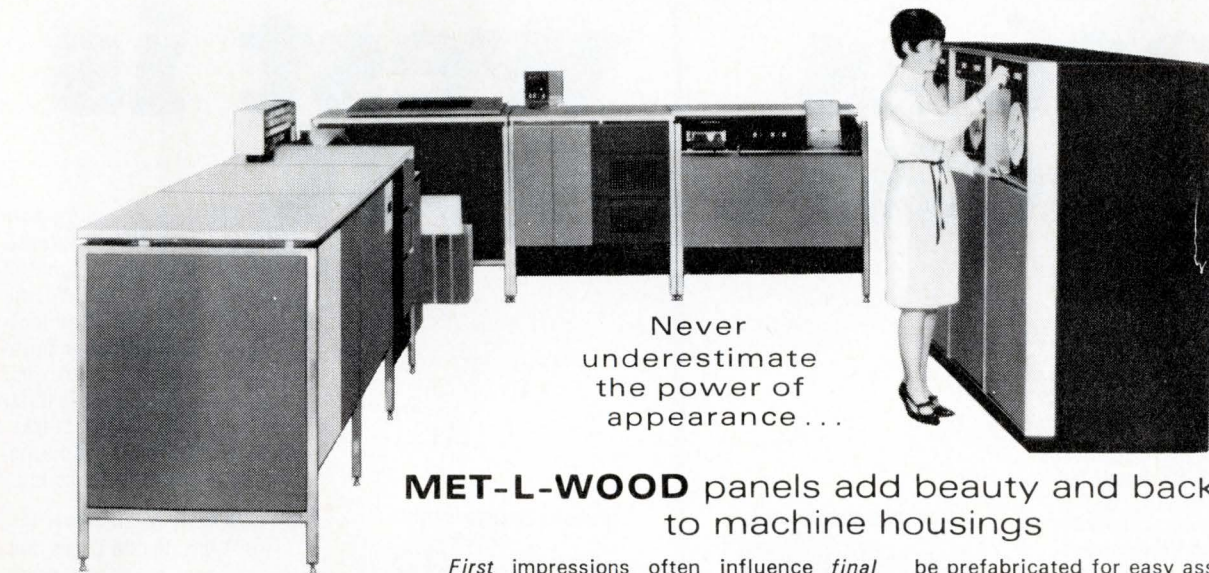

Never underestimate the power of appearance...

## MET-L-WOOD panels add beauty and backbone to machine housings

First impressions often influence final decisions. To compete in today's marketplace, even sophisticated machinery cries out for housing design that says... beauty... purpose... versatility. And nothing says it better than unique MET-L-WOOD. MET-L-WOOD is a laminate, consisting of a core of plywood or other lightweight material with metal or other durable facings structurally bonded to both surfaces. The result is a panel of great durability and versatility that lends itself to dramatic design, withstands abuse and continues to look like new for years. MET-L-WOOD panels are easy to work with, requiring no special tools, or may

be prefabricated for easy assembly. Learn for yourself how MET-L-WOOD fits into your housing plans. Write for brochure to: MET-L-WOOD CORPORATION, 6744 West 65th Street, Chicago 60638.



**MET-L-WOOD**  
Corporation

STRUCTURAL LAMINATES SINCE 1925

## LITERATURE

**Common terminal connectors** for maximum terminal contact with minimal electrical noise and serial IR loss—4 pages. Lear Siegler Inc., 714 N. Brookhurst St., Anaheim, Calif. 92803.

Circle 414 on Inquiry Card

**Single section variable resistors** with direct and vernier drive on concentric shafts—2 pages. CTS of Asheville Inc., Mills Gap Rd., Skyland, N. C. 28776.

Circle 415 on Inquiry Card

**Sample and hold circuit** offers high input impedance and eliminates special power requirements—4 pages. Data Technology Corp., 1050 E. Meadow Circle, Palo Alto, Calif. 94303.

Circle 416 on Inquiry Card

**Pressure transducers** use ICs with built-in heaters to maintain stability over wide temperature span—2 pages. Electro-Science Inc., 1502 W. 34th St., Houston, Tex. 77018.

Circle 417 on Inquiry Card

**IC relay controller** for use as an on/off control with 50 millisecond response. Triplett Corp., Bluffton, Ohio 45817.

Circle 418 on Inquiry Card

**Logic circuit analyzer** that accepts circuits with up to 96 inputs and 144 outputs, and performs up to 4000 tests per second. General Radio, West Concord, Mass. 01781.

Circle 419 on Inquiry Card

**High power pulse modulators**, available with power outputs from 1 to 50 kW, are solid state, have regulated output power and can be remotely programmed. Bertan Associates Inc., 15 Newton Rd., Plainview, N.Y. 11803.

Circle 420 on Inquiry Card

**Solid-state power controls** for 120- and 240-V ac or dc motors and heaters designed with ac or pulsating and full dc output delivered simultaneously—1 page. Ohmite Mfg. Co., 3601 Howard St., Skokie, Ill. 60076.

Circle 421 on Inquiry Card

**Sense amplifiers**, high speed series 7520: electrical characteristics, recovery and recycle times, logic diagrams, switching characteristics, and schematics—8 pages. Silicon General Inc., 7382 Bolsa Ave., Westminster, Calif. 92683.

Circle 422 on Inquiry Card

**Op amp catalog** lists complete specs on each model. Features include high slewing rate and high output power levels—4 pages. Optical Electronics Inc., Box 11140, Tucson, Ariz. 85706.

Circle 423 on Inquiry Card

**"Specifying a voltage controlled filter,"** a design-aid applications bulletin prepared to help the design engineer in selecting a vcf for a specific signal processing job. Aritech Corp., 130 Lincoln St., Brighton, Mass. 02135.

Circle 424 on Inquiry Card

**Data communications system, 520/DC**, is described in an 8-page brochure containing specs and information on software packages. Varian Data Machines, 2722 Michelson Dr., Irvine, Calif. 92664.

Circle 425 on Inquiry Card

**Semiconductor storage unit** with modular capacity of 2, 4, or 8 million bytes per stand-alone unit, and a data transfer rate synchronous to CPU speeds up to 16 million bytes/second—6 pages. Advanced Memory Systems Inc., 1276 Hammerwood Ave., Sunnyvale, Calif. 94086.

Circle 426 on Inquiry Card

# east is east

And there is no real reason to order your Tape Wound Cores from the other coast. Magnetic Metals has full Tape Wound Core production facilities (not just warehouses) on both coasts. So, no matter where you need them, Magnetic Metals makes Tape Cores—and stocks them—near to you. This means the fastest delivery possible.

Call Magnetic Metals now for the Tape Wound Cores and other magnetic parts you need.

**Stock quantities maintained on:**

- Tape Wound Cores
- Permalloy Powder Cores
- Ferrite Pot Cores
- Ferrite Toroids
- Electromagnetic shielding
- Transformer laminations
- Synchro-servo laminations

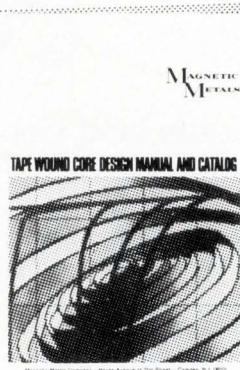

Free from  
Magnetic Metals

## MAGNETIC METALS COMPANY

HAYES AVENUE AT 21ST STREET  
CAMDEN, NEW JERSEY 08101 • (609) 964-7842  
Camden, N.J., Chicago, Ill., Newport Beach, Calif.

Circle 82 on Inquiry Card

# west is west

And there is no real reason to order your Tape Wound Cores from the other coast. Magnetic Metals has full Tape Wound Core production facilities (not just warehouses) on both coasts. So, no matter where you need them, Magnetic Metals makes Tape Cores—and stocks them—near to you. This means the fastest delivery possible.

Call Magnetic Metals now for the Tape Wound Cores and other magnetic parts you need.

**Stock quantities maintained on:**

- Tape Wound Cores
- Permalloy Powder Cores
- Ferrite Pot Cores
- Ferrite Toroids
- Electromagnetic shielding
- Transformer laminations
- Synchro-servo laminations

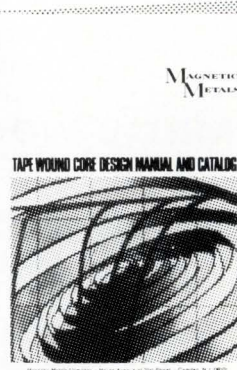

Free from  
Magnetic Metals

## MAGNETIC METALS COMPANY

NEWPORT BEACH, CALIF. 92663  
(714) 545-9413  
Newport Beach, Calif., Chicago, Ill., Camden, N.J.

The Electronic Engineer • April 1970

**Plug-in PC card modules** for reading and retaining the peak value of one-shot or repetitive pulse voltage waveforms—6 pages. Micro Instrument Co., 12901 Crenshaw Blvd., Hawthorne, Calif. 90250.

Circle 427 on Inquiry Card

**Connector chart** contains a selection of PC edge connectors, interconnectors, combination connectors, and high density connections. Mepco Inc., Columbia Rd., Morristown, N.J. 07960.

Circle 428 on Inquiry Card

**A power hybrid circuit** that can drive a 7-segment readout tube directly is described in this 4-page brochure. Fabri-Tek Micro-Systems Inc., 1410 W. 3rd St., Pompano Beach, Fla. 38060.

Circle 429 on Inquiry Card

**Semiconductor mounting kits** use military spec approved hardware chosen by the customer to enable uniformity guarantee—4 pages. Thermalloy Co., 8717 Diplomacy Row, Dallas, Tex. 75247.

Circle 430 on Inquiry Card

**Digital multimeters**—series 5200 and 5400. An 8-page data sheet gives complete specs, instrument options and accessories. Dana Laboratories Inc., 2401 Campus Dr., Irvine, Calif. 92664.

Circle 431 on Inquiry Card

**Waveform generators**, compatible with system interfaces using standard TTL and DTL positive logic—4 pages. Microdot Inc., 220 Pasadena Ave., South Pasadena, Calif. 91030.

Circle 432 on Inquiry Card

**Solid-state time delay** for proximity switching control, 0.05- to 1-second and 0.05- to 10-second ranges—2 pages. Electro Products Labs Inc., 6125 Howard St. Chicago, Ill. 60648.

Circle 433 on Inquiry Card

**Digital converter** for interfacing digital systems with synchro resolver and dc analog systems—design manual 1069. Transmagnetics Inc., 134-25 Northern Blvd., Flushing, N.Y. 11354.

Circle 434 on Inquiry Card

**Multiplexer input limiter** and input connector card (20 wire) allows separation of low-level analog signal wiring from digital logic wiring—4 pages. Data Technology Corp., 1050 E. Meadow Circle, Palo Alto, Calif. 94303.

Circle 435 on Inquiry Card

## New Short Form Catalog from Newport Labs

Free: Newport Laboratories short-form catalog describing its complete line of products: digital panel meters, DC data amplifiers, galvo drivers, dual DC power supplies, DC differential amplifiers, photomultiplier amplifiers and voltage-to-frequency converters. An important guide for anyone buying or specifying test instrumentation equipment, Newport's catalog presents pertinent data such as performance specifications, mounting options and applications. It is an invaluable reference for the most comprehensive line of high-quality DPM's, amplifiers and other instruments available.

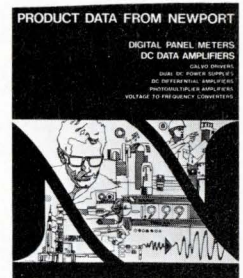

## NEWPORT LABORATORIES, INC.

630 East Young Street, Santa Ana, California 92705 (714) 540-4914.

Circle 140 on Inquiry Card

## ANNOUNCING . . .

A Course in

# INTEGRATED CIRCUITS

And an important opportunity for all design, equipment and systems engineers to stay ahead of the evolution in integrated circuits.

There is now available a practical and authoritative course in Integrated Circuits. This 10 part course appeared originally in *The Electronic Engineer* and is now being reprinted by popular demand. The course is designed for engineers who are buying or using, or who plan to use the whole range of integrated circuits—Silicon monolithic, thin-film, MOS, and hybrids. The course describes the function and use of integrated circuits in clear and complete form.

**You achieve new skills**—This course gives the required background to properly communicate with device designers. The course will also sharpen your capability to make the right decisions about the selection and use of ICs. In addition, the course traces the history of integrated circuits so you can evaluate new developments and anticipate those now on the drawing board. The course also includes a study of manufacturing details to keep you abreast of the complexities in this area.

The complete 10 part course costs \$4.00. Send your order to *The Electronic Engineer*, Chestnut and 56th Streets, Philadelphia, Pennsylvania 19139.

## NOW AVAILABLE . . .

A Course in

# TELEMETRY

A special course on Telemetry is now being offered to all electronic engineers. It appeared originally in *The Electronic Engineer*. The course analyzes the fundamentals of telemetry and describes the function of telemetry equipment. The course consists of several parts, each one patterned after one specific portion of a telemetry system. Today, more than ever before, there is a critical need for more reliable, smaller, lighter *data gathering hardware*. This course provides a sound insight into the modern methods of data acquisition, processing and display and how they are organized. Some of the areas covered are:

- Multiplexers and Encoders
- Analog to Digital conversion
- Demultiplexing and Decoding
- Processing and Display

This course is especially useful to digital designers, design engineers, engineering managers, telemetry engineers, instrument designers and computer designers.

The complete 5 part course is available for just \$4.00 and this includes a test. All those successful in passing the examination will receive a formal Certificate of Completion that is suitable for framing.

To get this course, send your order to *The Electronic Engineer*, Chestnut and 56th Streets, Philadelphia, Pennsylvania 19139.

- Sensors, Transducers and Signal Conditioning

**LOOKING FOR THOSE HARD-TO-GET SPECIAL AND DISCONTINUED TRANSISTORS ... INCLUDING PHILCO TYPES? YOU JUST FOUND THEM!**



All 100% tested . . . guaranteed & at the industry's lowest prices. Write for new catalog and compare

**LTE**  
**LANSDALE**  
 Transistor & Electronics, Inc.  
 COLMAR, PENNA. 18915 • 215-855-9002

Circle 83 on Inquiry Card

**READ THESE BOOKS**

**Computers for Engineers**

Rv Britow Hodae. Published 1969 by McGraw-Hill Book Co., 330 W. 42 St., New York, N. Y. 10036. Price \$11.00. 212 pages.

This book breaks naturally into two sections. The first four chapters describes how computers work. The author succeeds in his mission of providing an elementary introduction to computers for engineers and managers. The explanations of what a computer does, what its elements are, and how they are organized into a powerful engineering tool, are easily understood. Numerous pertinent illustrations aid a clearly written text. You get the feeling that the author of this Rosetta Stone for deciphering computerese is on your side.

In the last four chapters, FORTRAN and PL/1 computer languages are presented along with engineering examples which add some structure and meaning. Definitions pile up rapidly, and soon you are in one of those situations where the use of words you just learned seems to exceed those you knew before. FORTRAN is a complex enough language that the accompaniment of an interactive feedback mechanism, such as an instructor or terminal, is much more efficient than reading alone.

For those engineers and managers who have not had exposure to computers in their education or work experience, but find a need arising, this book will quickly make them more comfortable. If you are the dedicated type of reader who can learn FORTRAN from a book, it will be doubly valuable.

**Progress in Direct Digital Control**

Edited by Dr. Theodore J. Williams and Frank M. Ryan. Published 1969 by Instrument Society of America, Publications Department, 530 William Penn Place, Pittsburgh, Pa. 15219. Price \$17.00. 300 pages.

**Electronic Test & Measurement Handbook**

By John J. Schultz. Published 1969 by Tab Books, Blue Ridge Summit, Pa. 17214. Price \$7.95 for hardbound; \$4.94 for paperback. 224 pages.

**Integrated Circuits**

**A Basic Course for Engineers and Technicians**

By Robert G. Hibberd. Published 1969 by McGraw-Hill Book Company, 330 West 42 St., New York, N. Y. 10036. Price \$9.95. 171 pages.

**Absolute Measurements in Electricity and Magnetism**

By Andrew Gray. Republished 1967 by Dover Publications, Inc., 180 Varick St., New York, N. Y. 10014. Price \$4.00 for paperback. 837 pages plus index.

**The Technology of Computer Music**

By M. V. Mathew. Published 1969 by the MIT Press, 50 Ames Street, Cambridge, Mass. 02142. Price \$12. 188 pages.

**KEEP PACE WITH SPACE AGE! SEE MOON SHOTS—LANDINGS, SPACE FLIGHTS, CLOSE-UP! AMAZING SCIENCE BUYS for FUN, STUDY or PROFIT**

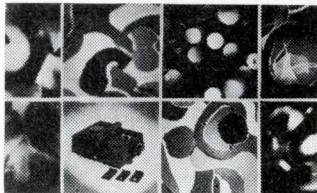

**SPECIAL VISUAL EFFECTS PROJECTOR SET**

Dazzling, avante-garde visual effects. Fantastic variety. Incredibly beautiful. Special package offer contains all necessary apparatus. Create floating, exploding, fiery bursts of color like "Symphony of Spheres", "Chromatic Starbursts", "Crystal Starburst". Features 35mm 500 W. fan cooled projector—produces big image at short distance. Accepts two 9" diam. wheels (Dry Kaleidoscope & Hevidoscope), 2 cylindrical accessories (6" Colored Cloud & 5" Hexidoscope w/six internal mirrored walls). Instructions. Stock No. 71,212EE ..... \$79.50 Ppd.

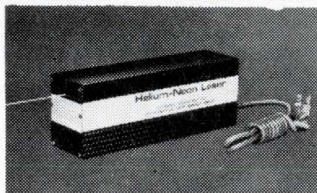

**NEW \$99.50 HELIUM-NEON LASER!**

Completely assembled, instant-starting w/three times power output of comparable models. Steady, ripple-free light of moderate (safe) power. Excellent collimation. Particularly useful for studies, experiments in holography, interferometry, diffraction, optical alignment. Simple and safe to use—just plug in, switch on. The 4½ lb. unit reaches 75% power in 2 secs.; full power, typically 0.5 milliwatt (0.3 mW minimum) in 3 mins. Beam divergence only 2 milliradians (far ahead of competition); beam only 2 cm. at 40 feet. Stock No. 79,004EE ..... \$99.50 Ppd.

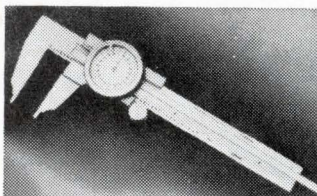

**PRECISION READING DIAL CALIPERS**

4" capacity. Precision dial for inside, outside, depth measurements. Read directly from dial graduated and guaranteed to .001". Beam scale graduated in inches and 10ths of inch. Measuring surfaces ground and lapped for accuracy. Stainless steel, chrome finish. 7" long x 2½" wide. Leather case incl. Stock No. 60,452EE (in's.) \$19.25 Ppd. Stock No. 60,509EE (met.) \$21.00 Ppd.



**GIANT FREE CATALOG**

Completely new 1970 edition. 148 pages—1000's of Bargains. New items, categories, illustrations. Dozens of electrical and electromechanical parts, accessories. Enormous selection of Astronomical Telescopes, Microscopes, Binoculars, Magnifiers, Magnets, Lenses, Prisms. Many war surplus items: for hobbyists, experimenters, workshop, factory. Write for catalog "EE"

**Choose from 20 standard gear trains with the new line of 1000 series instrument motors by Indiana General.**

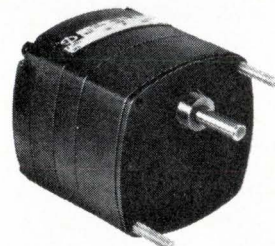

- Reluctance synchronous
- Induction
- Servo control
- Hysteresis synchronous

New Indiana General 1000 series motors have permanent lubrication, epoxy insulated stators, offer a wide choice of standard and special gear trains.

Write for 8-page booklet describing specifications with suggested applications and special options.

Indiana General, Electro-Mechanical Products, Oglesby, Illinois 61348.

**indiana general**

a division of Electronic Memories & Magnetics Corporation

ORDER BY STOCK NUMBER • OPEN ACCOUNT TO RATED FIRMS • MONEY-BACK GUARANTEE  
**EDMUND SCIENTIFIC CO.** 300 EDCORP BUILDING  
 BARRINGTON, NEW JERSEY 08007



# Advertisers—April 1970

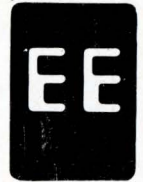

No liability is assumed for errors or omissions.  
This Index is published for a convenience.

ADVANCED MICRO DEVICES .....	6 & 7
Keye/Donna/Pearlstein	
ALCO ELECTRONICS PRDTS., INC. ....	137
Marketronics Adv.	
AMELCO SEMICONDUCTOR .....	107
Monda McCarter & Smith	
AMERICAN MACHINE & FOUNDRY CO.	
POTTER & BRUMFIELD DIV. ....	36
Grant, Wright & Baker, Inc.	
AMP, INC. ....	30 & 31
Aitkin-Kynett	
AMPERITE CO. ....	128
H. J. Gold Co., Adv.	
AUGAT, INC. ....	52
Horton, Church & Goff, Inc.	
BECKMAN INSTRUMENTS, INC.	
HELIPOT DIV. ....	86
N. W. Ayer/Jorgensen/MacDonald, Inc.	
BELDEN CORP. ....	80 & 81
Fensholt Adv., Inc.	
BUCKEYE STAMPING .....	138
Wheeler, Kight & Gainey, Inc.	
BUSSMANN MFG. DIV. ....	101
Henderson Adv. Co.	
CARTESIAN, INC. ....	50 & 51
Miller/Stoll Adv.	
CERMETEK, INC. ....	38
Hal Lawrence, Inc.	
CHEMICAL MICRO MILLING CO. ....	69
Robert H. Kieffreider Assoc.	
CHRONO-LOG CORP. ....	46
Mort Barish Assoc., Inc.	
CINCH-GRAPIK .....	2
Stral Adv. Co., Inc.	
COMPONENTS, INC. ....	117
Owens & Assoc. Adv., Inc.	
COMPUTER DESIGNERS CONFERENCE ....	105
Industrial & Scientific Conference Management, Inc.	
COMPUTER MEASUREMENTS, DIV. NEWELL INDUSTRIES .....	28
Jones, Maher, Roberts, Inc.	
DANA LABORATORIES, MEASUREMENTS DIV. ....	33
Rose Assoc., Adv.	
DILETRIX CORP. ....	132
Sanger-Funnell, Inc.	
DYNATRONICS OPERATION, ELECTRONICS DIV., GENERAL DYNAMICS CORP. ....	129
Neals & Hickok, Inc.	
EDMUND SCIENTIFIC CO. ....	142
Walter S. Chittick Co., Inc.	
ELCO CORP. ....	35
Schaefer Adv., Inc.	
ELECTRONIC ARRAYS, INC. ....	Inside Back Cover
Hal Lawrence, Inc.	
EXECUTONE, INC., PRINTACT RELAY DIV. ....	52
J. A. Richards	
FAIRCHILD CAMERA & INSTRUMENT CORP. 41	
John Meade, Inc.	
FAIRCHILD CONTROLS .....	119
Markman, Inc.	
FAIRCHILD SEMICONDUCTOR ..26 & 27, 109-111	
Chief/Day, Inc.	
FAIRCHILD SYSTEMS TECHNOLOGY ..114 & 115	
Hall Butler Blatherwick, Inc.	
FERROXUBE CORP. ....	13
W. H. Schneider, Inc.	
GENERAL INSTRUMENT CORP.	
SEMI. ASSEMBLY DIV. ....	25
MICROELECTRONICS DIV. ....	48 & 49
Norman Allen Assoc., Inc.	
GRAYHILL, INC. ....	134
Carr Liggett Adv., Inc.	
GUARDIAN ELECTRIC MFG. CO. ....	24
Kalb/Tookey & Assoc., Inc.	
GUDEBROD BROS. SILK CO., INC. ....	127
Ramsdell, Bright & Nathans, Inc.	
HAMILTON WATCH CO. ....	123
Beaumont, Heller & Sperling, Inc.	
HEATH CO. ....	125
Advance Adv. Service	
HEWLETT-PACKARD CO.	
COLORADO SPRINGS DIV. ....	121
LOVELAND DIV. ....	82
Tallant/Yates Adv., Inc.	
HEWLETT-PACKARD CO., ROCKAWAY DIV. 39	
Culver Adv., Inc.	
HEWLETT-PACKARD	
SANTA CLARA DIV. ....	99, 113
Lennen & Newell/Pacific	
HUGHES AIRCRAFT CO., NPB/MOSFET DIV. 70	
Foote, Cone & Belding	

INDIANA GENERAL CORP. ....	142
The Griswold-Eshleman Co.	
INSTRUMENT PRDTS., DIV. 3M CO. ....	29
Reach, McClinton & Co., Inc.	
KEPCO, INC. ....	Inside Front Cover
Weiss Adv.	
LAMBDA ELECTRONICS .....	53-60
Michel-Cather, Inc.	
LANSDALE TRANSISTOR & ELECTRONICS, INC. ....	142
Product Promotions Agency, Inc.	
LEM INSTRUMENT CORP. ....	136
Quinlan Keene Peck & McShay, Inc.	
MAGNETIC METALS CO. ....	140
Robert H. Kieffreider Assoc.	
MET-L-WOOD CORP. ....	139
Drew & Carr, Inc.	
MILLER-STEPHENSON CO. ....	133
Michel-Cather, Inc.	
3-M CO., FILM & ALLIED PRDTS. DIV. ....	45, 130, 135
Young & Rubicam, Inc.	
MONOLITHIC DIELECTRICS .....	138
Eastman Adv.	
MONROE, THE CALCULATOR CO. ....	14 & 15
Baker & Hartel, Inc.	
MOTOROLA COMMUNICATIONS & ELECTRONICS, INC. ....	108
Brand Adv., Inc.	
MOTOROLA SEMICONDUCTOR PRDTS., INC. 89	
Lane & Wampler Adv., Inc.	
NATIONAL SEMICONDUCTOR CORP. ....	17 & 18
Hall Butler Blatherwick, Inc.	
NEWPORT LABORATORIES, INC. ....	141
Tidewater Adv.	
NORTEC ELECTRONICS .....	66
Paul Pease Adv.	
NORTRONICS .....	51
Stral Adv. Co., Inc.	
PHILCO-FORD CORP. ....	8
Hal Lawrence, Inc.	
POTTER & BRUMFIELD DIV.	
AMERICAN MACHINE & FOUNDRY CO. ....	36
Grant, Wright & Baker, Inc.	
PYLON CO., INC. ....	108
American Line-A-Graph Corp.	
RCA ELECTRONIC COMPONENTS	
THYRISTORS DIV. ....	93
DIGITAL ICS DIV. ....	Back Cover
Al Paul Lefton Co., Inc.	
RADIO SWITCH CORP. ....	130
Carpenter, Matthews & Stewart, Inc.	
RENTAL ELECTRONICS .....	40
Larcom Randall Adv., Inc.	
ROTRON INC. ....	129
Lescarbours Adv., Inc.	
SCANBE MFG. CORP. ....	37
Jansson Adv., Inc.	
SINGER-LINK DIV. ....	47
Cookley Heagerty, Inc.	
SPRAGUE ELECTRIC CO.	
CAPACITOR DIV. ....	1
SEMICONDUCTOR DIV. ....	91
The Harry P. Bridge Co.	
TELEDYNE PHILBRICK NEXUS .....	74
Renaccio Adv., Inc.	
TELEDYNE RELAYS .....	103
S. Michelson Adv.	
TEXAS INSTRUMENTS, INC.	
COMPONENTS GROUP .....	22 & 23
Albert Frank-Guenther Law	
UNION CARBIDE CORP. ....	11
Windfield, Inc.	
UNITEK CORP. ....	5
M. C. Wysock & Assoc.	
UNITRODE CORP. ....	21
The Silton Co., Inc.	
VARFLEX CORP. ....	136
Barlow/Johnson, Inc.	
VARIAN ASSOCIATES .....	97
Botsford, Constantine & McCarty, Inc.	
VICTOREEN INSTRUMENT DIV. ....	134
Dix & Eaton, Inc.	
VISHAY RESISTOR PRDTS., INC. ....	104
Larwin Adv.	
WAKEFIELD ENGINEERING, INC. ....	132
Robert Robotham Adv.	
WESTON INSTRUMENTS, INC.	
NEWARK DIV. ....	94
Arndt, Preston, Chapin, Lamb & Keen, Inc.	

## DISTRICT SALES MANAGERS

<b>EDWARD G. SHAUD</b>	
BALA-CYNWYD, (Pa.) 19004	
One Decker Square	
(Area Code 215) SHERWOOD 8-2000	
<b>JOSEPH DRUCKER</b>	
NEW YORK 10017—100 East 42nd St.	
(Area Code 212) OXFORD 7-3400	
<b>JOHN W. BERNHARDT</b>	
CHICAGO 60606—120 S. Riverside	
Plaza	
(Area Code 312) 782-1400	
<b>G. T. ALFANO</b>	
NEEDHAM HEIGHTS, MASS. 02194—	
570 Hillside Ave.	
(Area Code 617) 444-0010	
<b>TERRENCE D. BUCKLEY</b>	
<b>THOMAS R. BORIS</b>	
LOS ANGELES 90005 3727 W.	
Sixth St. #202	
(Area Code 213) DUNKIRK 7-1271	
<b>RALPH PETERSEN</b>	
LOS ALTOS (San Francisco) 94022	
199 First St., Room 335	
(Area Code 415) 941-6655	
<b>RICHARD DUTE</b>	
CLEVELAND 44114—601 Rockwell Ave	
(Area Code 216) SUPERIOR 1-2860	
<b>FRANK A. SMITH</b>	
HOLLYWOOD, FLA. 33020—	
2419 Hollywood Blvd.	
(Area Code 305) 927-7829	
<b>NEWTON B. COLLINSON</b>	
ATLANTA 30309—1776 Peachtree St.	
N.W.	
(Area Code 404) 872-4723	
<b>HAROLD E. MOTT</b>	
<b>WAYNE L. LOVING</b>	
DALLAS 75206—Meadows Bldg	
Expressway at Milton	
(Area Code 214) EMERSON 3-6426	
<b>BRENT GILBERT</b>	
BELLAIRE, (Texas) 77401	
P.O. Box 160	
(Area Code 713) 621-7550	
<b>INTERNATIONAL BUSINESS OFFICES</b>	
London, S W 1 .....	Max F. Holsinger
67-68 Jermy St., St James's	Dir. European Sales
TRA 6318-9	Roy V C. Hall, A. Berg
Cables	WHIP LONDON S W 1
Manchester 22 .....	D. I. Goulden
Haletop, Wythenshawe Civic Centre	MERCURY 3292
4 Dusseldorf-Rath ...	E. Hillerbrand, R. Schomburg,
Eitelstrasse 32	W. Heckelmann
Dusseldorf 632031	
Cables	WHIP DUSSELDORF
Paris, 8e .....	S. Brown-Joussard
70 Rue de Ponthieu	ELYSEES 65-77
Cables	UIIP PARIS 16e
Tokyo .....	C. T. Sakaguchi
Room 814, Togin Bldg. Marunouchi	
CPO Box No. 1572	Tel: 211-3506-3509
Cables	CLARENCESAKA TOKYO
<b>BUSINESS STAFF</b>	
<b>K. ROBERT BRINK</b>	
<i>Editor</i>	
<b>STEPHEN A. FARKAS</b>	
<i>Marketing Services Manager</i>	
<b>DENNIS J. PERKINS</b>	
<i>Promotion Manager</i>	
<b>JOHN E. JAENISCH</b>	
<i>Advertising Sales Manager</i>	
<b>PAT KAUFFMAN</b>	
<i>Production Manager</i>	
<b>WILLIAM M. COFFEY</b>	
<i>Circulation Director</i>	
<b>JAMES F. NAGY</b>	
<i>Circulation Manager</i>	
<b>JOSEPH P. BABCOCK</b>	
<i>Reader Service Manager</i>	
<b>JOHN H. KOFRON</b>	
<i>Chilton Research Services</i>	
<b>C. R. WILHIDE</b>	
<i>Washington Vice-President</i>	



# EVEN SQUINTING WON'T HELP.

No use, fellas. You need a microscope to see the world's most densely packed LSI circuit.

That's what Electronic Arrays has done this time.

4692 transistors (4096 bits of memory) on a single 88 x 94 mil chip.

Since that kind of density is not available elsewhere, may we take this hallowed moment to proudly proclaim our EA 3300 (a 512 word, 8 bit/word ROM) the champion of the LSI world.

We didn't, however, design the EA 3300 this way just to show off.

EA 3300 has the most functional complexity of any product available today in a 24 pin package.

That reduces cost.

A smaller die further reduces costs by giving you higher yields and greater product performance and reliability.

Our entire line of Registers, ROM's, Read/Write RAM's and Logic circuits is made in *production quantities* with the same close-tolerance MOS technology as the EA 3300.

And all products are available *immediately* from 24 distributors nationwide, and 6 international distributors.

To see is to believe. Do both by addressing your purchase orders to your nearest EA distributor or to Electronic Arrays, Inc., 501 Ellis Street, Mountain View, California 94040. (415) 964-4321.



**electronic  
arrays, inc.**

**Proven MOS products delivered in volume.**

Forms for your specialized bit patterns are available from any of our representative offices or directly from the factory. The EA 3307, which is an EA 3300 already programmed to be an EBCDIC to ASCII and ASCII to EBCDIC code converter, is available from distributor and factory stock. Features include two output inhibit controls that give 1024 4/bit words; nine input addresses; all decoding on the chip; power requirements less than 100 milliwatts; synchronous 2-phase clock, 24 pin hermetic dual-in-line package.

Circle 2 on Inquiry Card

# Use COS/MOS more ways in more places

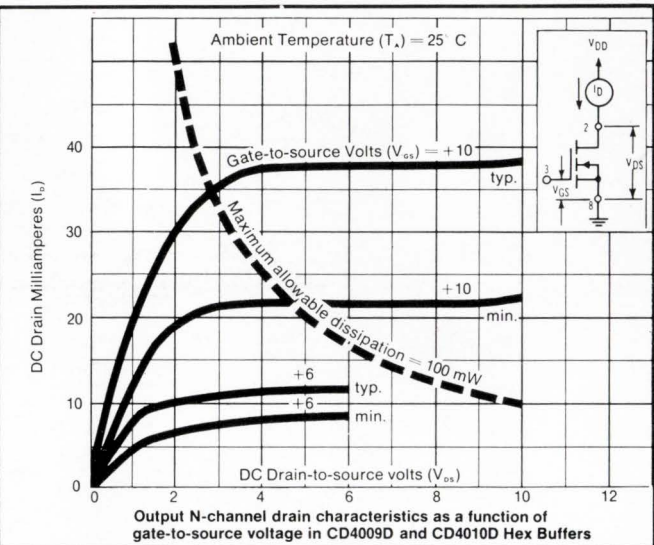
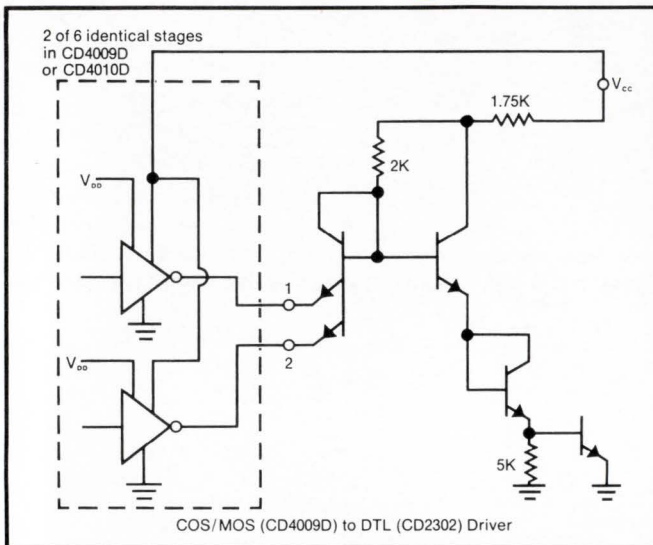

16-lead DIC Hex Buffer/Logic-Level Converters  
CD4009D — Inverting Type \$7.00  
CD4010D — Non-inverting Type \$7.00  
(1,000 unit prices)

$V_{DD} = 10V$   $V_{CC} = 5V$

CD4009D as a Logic-Level Converter/Inverter

CD4009D as a COS/MOS to COS/MOS Inverter

## RCA-CD4009D and CD4010D COS/MOS Hex Buffers bring more flexibility to your logic circuits

Now you have many more opportunities to take advantage of the known capabilities of COS/MOS—RCA's Complementary Symmetry MOS digital integrated circuits. Use the new CD4009D (inverting) and CD4010D (non-inverting) hex buffers for:

- greater driving capability, and wider current flexibility in COS/MOS systems
- greater latitude for interfacing COS/MOS with DTL and/or TTL devices.

A most important feature of these new hex buffers in such applications is their low "1" and "0" output impedances which result in excellent dynamic noise margins.

For more information on the COS/MOS Hex Buffers and the rest of RCA's growing line of COS/MOS Integrated Circuits, get in touch with your local RCA Representative or your RCA Distributor. For specific technical information, write RCA Electronic Components, Commercial Engineering, Section D50, Harrison N.J. 07029.

**RCA** Integrated Circuits