

Avatar.

*MacMainFrame™ Series
Macintosh-to-Mainframe Link*

*Token-Ring Workstation
Installation Guide*

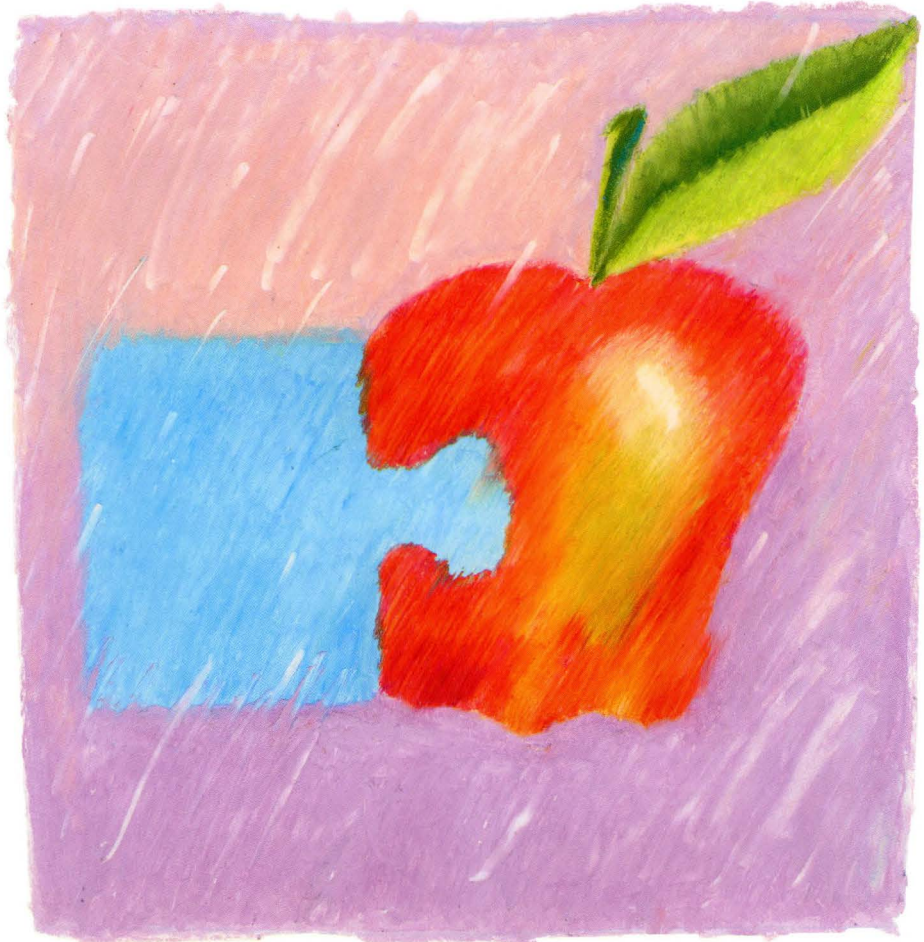

MacMainFrame™ Series

Macintosh to Mainframe Link

***Token-Ring
Workstation***

Installation Guide

**This manual also includes
instructions for
ALL USERS of Avatar
Token-Ring hardware.**

Avatar.

65-2800-101

Copyright © 1990

Avatar Corporation
65 South Street
Hopkinton, MA 01748
(508) 435-3000

All Rights Reserved

The information contained herein is the property of Avatar Corporation. It shall not be reproduced, disclosed, or used in whole or in part without written permission of Avatar Corporation.

MacMainFrame and EasyKeys are trademarks of Avatar Corporation.

Fiber Optic System is a trademark of Du Pont Electronics.

IBM PC, CICS, TSO, CMS, and IND\$FILE are trademarks of International Business Machines Corporation.

MacLinkPlus is a trademark of Dataviz Corporation.

Microsoft is a registered trademark, and Excel is a trademark of Microsoft Corporation.

PageMaker is a registered trademark of Aldus Corporation.

PhoneNet is a trademark of Farallon Computing Inc.

VAX is a trademark of Digital Equipment Corporation.

The following are trademarks of Apple Computer, Incorporated:

AppleTalk

EtherTalk

HyperCard

HyperTalk

LocalTalk

Macintosh

Macintosh II

Macintosh IIcx

Macintosh IIfx

Macintosh SE

Macintosh SE/30

MacTerminal

MultiFinder

TokenTalk

WARNING: This equipment generates, uses, and can radiate radio frequency energy; and if not installed and used in accordance with the instruction manual, may cause interference to radio communications. It has been tested and found to comply with the limits for a Class A computing device pursuant to Subpart J, Part 15 of FCC Rules, which are designed to provide reasonable protection against such interference when operated in a commercial environment. Operation of this equipment in a residential area is likely to cause interference; in which case the user must correct the interference at his/her own expense.

WARNING: This equipment is a Class A digital apparatus which complies with the Radio Interference Regulations, CRC c. 1374.

MacMainFrame Series
Part # 65-2800-101-AB

Printed in the United States of America

Table of Contents

| | |
|---|-----------|
| Preface | v |
| Audience..... | v |
| How To Use This Book..... | v |
| Chapter 1 — Introduction | 1 |
| Avatar's Token-Ring Products | 2 |
| How to Use This Book..... | 3 |
| What is MMF Token-Ring Workstation?..... | 5 |
| Chapter 2 — What You Need First | 7 |
| Experience..... | 7 |
| Macintosh Hardware..... | 8 |
| Network Hardware..... | 9 |
| Software..... | 10 |
| Network Requirements | 11 |
| Chapter 3 — Installing Avatar Token-Ring Hardware | 13 |
| Introduction..... | 13 |
| Avatar Hardware Installation — Macintosh SE Machines..... | 15 |
| Avatar Hardware Installation — Macintosh SE/30 Machines..... | 23 |
| Avatar Hardware Installation — Macintosh II Machines | 31 |
| Attaching the External Cable | 35 |
| Connecting the Workstation to the Token-Ring LAN | 37 |
| How to Change the Token-Ring Address | 38 |
| Chapter 4 — AvaTR | 39 |
| Introduction..... | 39 |
| Part 1 — Installing AvaTR..... | 41 |
| Part 2 — Enabling AppleTalk Connectivity..... | 46 |
| To Set The AppleTalk Zone..... | 50 |
| Chapter 5 — Installing the MMF Token-Ring Workstation Software | 51 |
| Introduction..... | 51 |
| Before You Start..... | 52 |
| 1. Check Your MMF Workstation software. | 53 |
| 2. Open the Workstation diskettes..... | 54 |

| | |
|--|-----------|
| 3. Drag files to the System folder. | 55 |
| 4. Install the Workstation application. | 56 |
| 5. Go to the Control Panel. | 57 |
| 6. Go to the Avatar Control Panel..... | 58 |
| 7. Check the lock panel..... | 59 |
| 8. Select the Token-Ring driver. | 59 |
| 9. Set the Token-Ring Parameters..... | 60 |
| 10. Close the Token-Ring panel, go to the LU panel. | 64 |
| 11. Go to the language panel..... | 65 |
| 12. Check the lock panel. | 66 |
| 13. Close the Control Panel..... | 66 |
| 14. Restart your Macintosh. | 67 |
| 15. Run the MMF Checker application | 68 |
| Software Installation Done | 70 |
| Appendix A — Key to MMF Workstation's Icons | 71 |
| System Icons..... | 72 |
| Application Icons..... | 73 |
| Appendix B — The Avatar Lock Panel..... | 75 |
| Introduction | 75 |
| To Set The First Password..... | 77 |
| To Open the Lock | 78 |
| To Change the Password..... | 79 |
| When You Forget Your Password | 79 |
| Index..... | 81 |

Preface

This manual shows you how to install

- Avatar's Token-Ring hardware, and
- Avatar's MacMainFrame Series Token-Ring Workstation

on your Apple™ Macintosh computer.

Audience

This book is for people who set up MacMainFrame Workstation machines and who administer MacMainFrame networks.

How To Use This Book

If you've never used MacMainFrame Workstation before, follow the chapters in order.

If you have used MacMainFrame Workstation before, turn to the section you need and follow the instructions there.

- Chapter 1 — Introduction
- Chapter 2 — What you need first
- Chapter 3 — Hardware Installation
- Chapter 4 — AvaTR
- Chapter 5 — Software Installation
- Appendix A — Key to Icons
- Appendix B — Using the Avatar Lock Panel
- Index

Related Documents

The MacMainFrame Series *Coax/SDLC/Token-Ring Workstation User Guide*

The MacMainFrame Series *Graphics Option User Guide*

For More Help

Contact Avatar Customer Support: 1-800-282-8276

Chapter 1

Introduction

Avatar offers several levels of Token-Ring connectivity — hardware, network software, and terminal emulation software. This manual describes Avatar's Token-Ring hardware and one of Avatar's software Token-Ring products, the MacMainFrame Token-Ring Workstation.

For more information on Avatar's other software Token-Ring products, please see your Avatar representative.

Terminology: For convenience, we'll abbreviate the term MacMainFrame as MMF hereafter.

Avatar's Token-Ring Products

Hardware: Token-Ring boards for Macintosh SE, SE/30, and Macintosh II family.

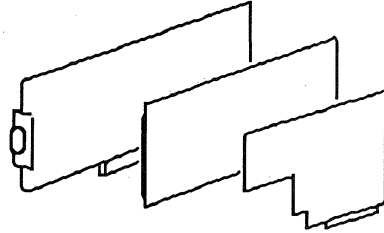

Network Software: AvaTR software, which provides Token-Ring service and enables AppleTalk connectivity for Avatar Token-Ring hardware.

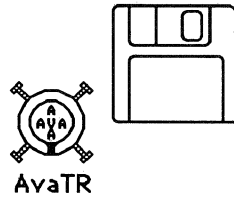

Applications:
Avatar's
MacMainFrame Series
Token-Ring products:

- MacMainFrame Workstations
- MacMainFrame/ Gateway Servers
- MacMainFrame/ Gateway Clients



How to Use This Book

This book explains how to install Avatar's Token-Ring hardware, and it explains how to install and use Avatar's MMF Token-Ring Workstation, which uses Avatar Token-Ring hardware.

Since you may not be using all the functionality available from these two products at once, find out how much of this book you do need to read by following these instructions.

For All Users of Avatar Token-Ring Hardware

Read Chapter 2 to make sure your installation meets the minimum hardware and software requirements.

Read Chapter 3 to find out how to install Avatar's Token-Ring hardware in your Macintosh.

Read Chapter 4 to find out how to install Avatar's AvaTR software in your Macintosh.

REMEMBER: Even if you're not planning to use any MMF software (such as MMF/GW Client or MMF Workstation), you still need to install the AvaTR network software to ensure that your Avatar Token-Ring hardware operates properly.

If You Will Also Be Running MMF Token-Ring Workstation

If you're using Avatar Token-Ring hardware:

FIRST read Chapter 2, basic hardware and software requirements.

THEN read Chapter 3, installing your Avatar Token-Ring hardware.

THEN read Chapter 4, Part 1, installing the AvaTR software.

FINALLY follow the instructions in Chapter 5 to install your MMF Workstation software.

If you're using non-Avatar Token-Ring hardware:

FIRST follow your hardware vendor's instructions to install your Token-Ring hardware.

THEN follow the instructions in Chapter 5 to install your MMF Workstation software.

If You Want AppleTalk Connectivity

You may want AppleTalk connectivity in order to use an Avatar MacMainFrame Series product, such as MMF/GW Client, or you may want to use AppleTalk connectivity for other applications. In either case:

FIRST read Chapter 2, basic hardware and software requirements.

THEN read Chapter 3, installing your Avatar Token-Ring hardware.

THEN read Chapter 4, Parts 1 and 2, Installing the AvaTR Software and Enabling AppleTalk Connectivity.

What is MMF Token-Ring Workstation?

The MacMainFrame Series Workstation hardware and software package lets your Macintosh computer connect to an IBM host computer. Once the connection is established, MacMainFrame Workstation emulates IBM 3278/3279-style terminals on your Macintosh. Using the MacMainFrame Workstation, you can conduct several logical unit (LU) sessions at once with the host. (The number of LU sessions depends on your MacMainFrame Workstation machine and the availability of LU sessions at the host.)

The diagram below shows a MMF Token-Ring Workstation in place on a Token-Ring LAN and communicating with an IBM host:

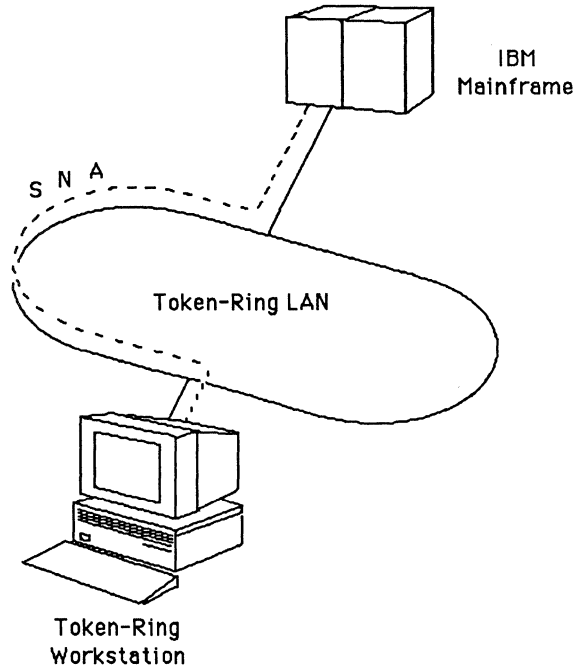

The MMF Token-Ring Workstation can also communicate with an AppleShare Server at the same time:

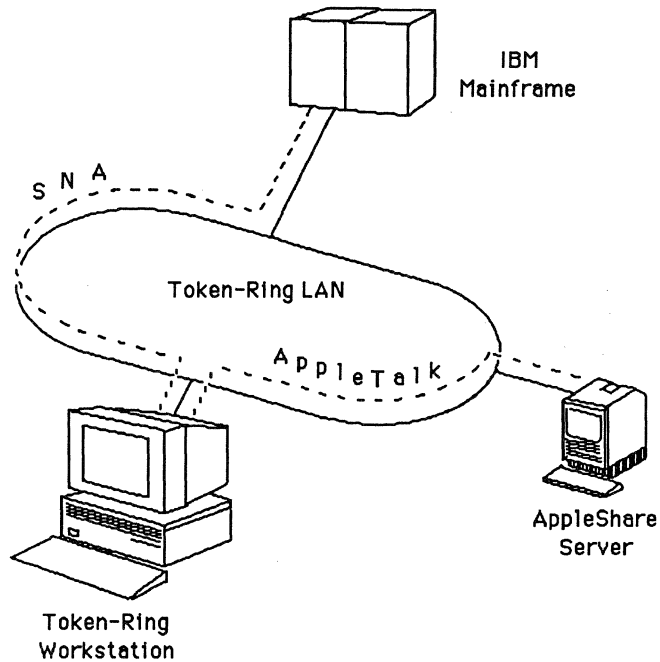

Using the MMF Workstation Sections in this book

As mentioned above, you should follow all the chapters in order.

Most of the information in this book is for MMF Workstation installers. The only topic that is not an integral part of MMF Workstation functionality is AppleTalk connectivity. We have noted this in the text.

Chapter 2

What You Need First

Experience

To install Avatar's **Token-Ring hardware** in your Macintosh, you need most of the things mentioned in this chapter. Where differences occur, we have noted them in the text.

To Install Avatar's **MMF Token-Ring Workstation**, you need all the things mentioned in this chapter.

For All Users

You should be familiar with basic Macintosh operations — using the mouse, using pull-down menus, using dialog boxes, and so on.

For MMF Token-Ring Workstation Users Only

- A working knowledge of the IBM operating environments with which you will be connecting is helpful.
- The MacMainFrame Token-Ring Workstation software *runs with both Avatar and non-Avatar hardware*, including hardware sold by Apple Computer Inc., h-three Systems Corporation, and Avatar.

If you're using **non-Avatar Token-Ring hardware**, *you may need additional documentation* to complete your installation of your MacMainFrame Series Workstation. See your hardware/software vendor for more information. Please check with your Avatar representative if you're not sure your Token-Ring hardware is compatible with MMF Token-Ring Workstation.

Macintosh Hardware

Your Macintosh must be one of the following to use Avatar's Token-Ring hardware:

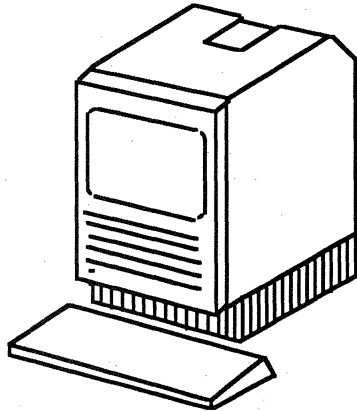

Macintosh SE,
Macintosh SE/30

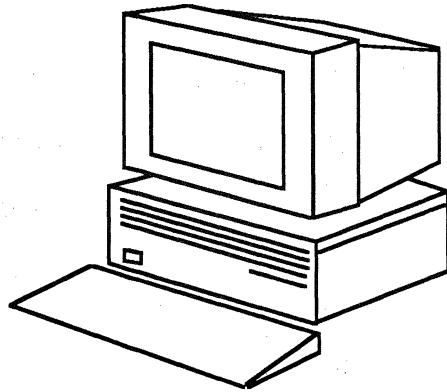

Macintosh II Family

Your Macintosh must also have a free expansion slot in its chassis in order to install the Token-Ring hardware.

- The single slot on the SE or SE/30 must be free.
- One of the slots on the Macintosh II must be free.

Network Hardware

External Cables

You must provide an external Token-Ring cable to connect the Workstation to the Token-Ring LAN.

For MMF Token-Ring Workstation Users Only

Make sure you have the appropriate hardware for your Workstation-to-host network environment. You may use Avatar's Token-Ring hardware or you may use a Token-Ring hardware product of another vendor.

If you're using **Avatar Token-Ring hardware**, use this book to install the Token-Ring hardware into your Macintosh.

If you're using **non-Avatar Token-Ring hardware**, see your hardware/software vendor for appropriate information about how to install that hardware and establish AppleTalk connectivity via that hardware.

Software

Basic Requirements

To run Avatar's Token-Ring hardware, your Macintosh must be equipped with System version at least 6.0.5.

To find out the version of your System, go to the Finder, then pull down the Apple menu and select **About the Finder...**

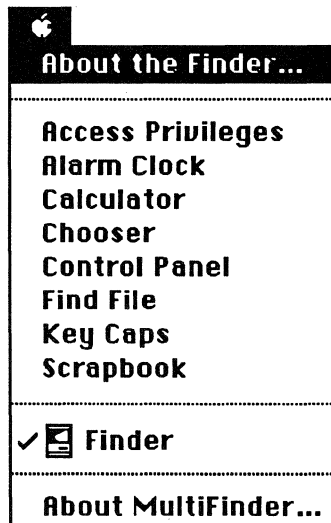

You'll see a window like this:

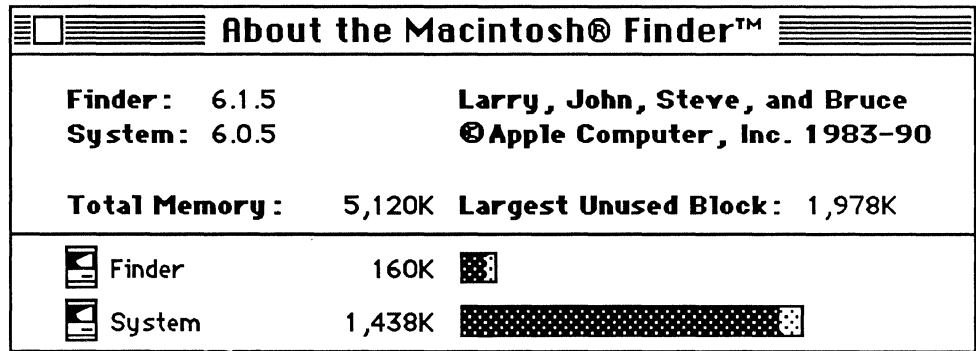

The second line shows that the system is version 6.0.5.

Network Requirements

Connectivity to IBM Host— via Token-Ring LAN

Your Macintosh must have access to a Token-Ring network that leads to the IBM host with which you want to communicate.

Once the MMF Workstation software or MMF/GW Server software is running, it automatically makes contact with the IBM host over the established network path and automatically obtains **logical unit (LU) sessions** from the host.

Chapter 3

Installing Avatar Token-Ring Hardware

Introduction

This chapter explains how to install Avatar Token-Ring hardware in your Macintosh computer.

Structure of This Chapter

- The first part of this chapter is divided into subsections according to the **various Macintosh hardware platforms**. Turn to the subsection that applies to your Macintosh and follow the directions there to install your Avatar Token-Ring hardware.
- The instructions in the second half of this chapter apply to **all Macintoshes**.

Audience

For All Avatar Hardware Users:

Follow all the instructions in this chapter. They explain how to:

- Install the Avatar Token-Ring board into an expansion slot in your Macintosh, and
- Connect your board-equipped Macintosh to the IBM host machine.
- Optionally change the board's Token-Ring address.

In the first half of the chapter, turn to the subsection that applies to your Macintosh and follow the directions there for installing the Token-Ring hardware in your Macintosh.

For Avatar Token-Ring Workstation Users Only:

To install MacMainFrame Token-Ring Workstation, you install both hardware and software into your Macintosh computer, and you connect the Macintosh to the IBM host via a Token-Ring LAN that leads to the IBM host.

The MMF Workstation software runs on various Token-Ring hardware platforms, including those sold by Apple Computer Inc., h-three Systems Corporation, and Avatar.

- If you're using **Avatar Token-Ring hardware**, follow all the instructions in this chapter.
- If you're using **non-Avatar Token-Ring hardware**, skip this chapter and Chapter 4 and proceed to chapter 5.

Avatar Hardware Installation — Macintosh SE Machines

WARNING: The Avatar hardware for the SE version of the MMF Workstation is not user-installable.

Please have an authorized Apple dealer install the Avatar MMF Workstation hardware on your Macintosh SE.

These instructions are provided for the authorized Apple dealer.

Unpacking Avatar Hardware for Macintosh SE

Open the Avatar shipping carton and make sure you have everything shown here:

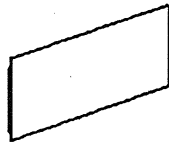

MMF Token-Ring Workstation board

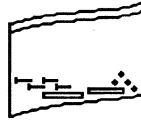

Plastic bag with screws, nuts, etc.

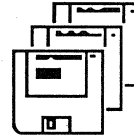

Three diskettes containing software



Internal cable with backing plate and 9-pin D-connector

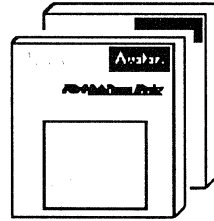

*MMF Workstation User's Guide,
MMF Workstation Installation Guide*

If you're missing something, contact Avatar. If anything is damaged, contact the shipping agent.

External Cables

REMEMBER: You must provide an external cable to connect the Workstation to the Token-Ring LAN. Example:



Installing Avatar Hardware Into Macintosh SE

Follow these steps to install the MMF Workstation hardware into a Macintosh SE machine:

1. Power down the SE.
2. Open the SE's case.
3. Disconnect the cables to the SE motherboard.
4. Remove the motherboard from the chassis.
5. Take the Workstation board out of its anti-static bag.
6. Connect the Workstation board to the motherboard:
 - Press the two standoffs onto the motherboard until you hear them snap into place.
 - Line up the connector on the Workstation board with the expansion connector on the SE motherboard.
 - Gently but firmly press the Workstation board into place on the motherboard.

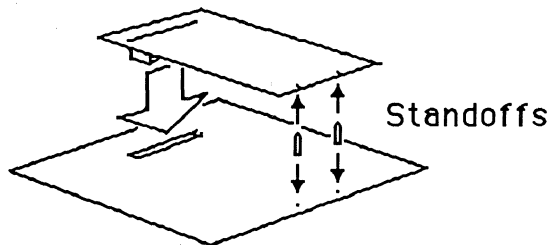

7. Install the internal cable:

- On the Workstation board, find the J1 connector; it is a blue plug under the edge of the board:
- Plug the internal cable into this connector.

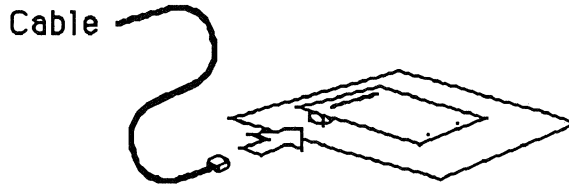

Close-up:

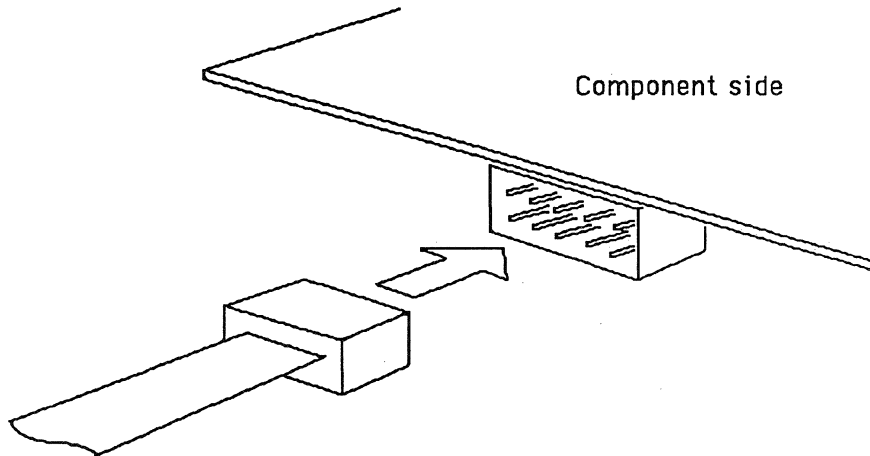

-
8. Thread the cable into position in the SE's chassis:

Cable's
backing
plate →

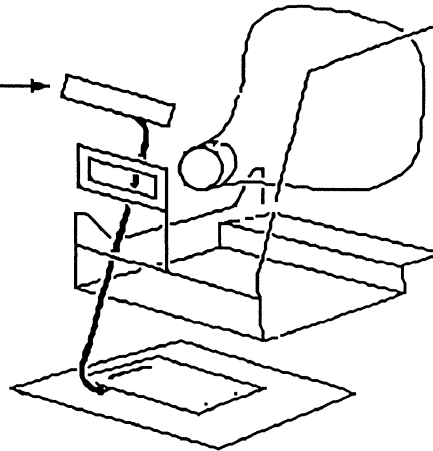

Motherboard

9. Slide the motherboard/Workstation board back into the SE chassis.
First, rotate the Macintosh onto its face:

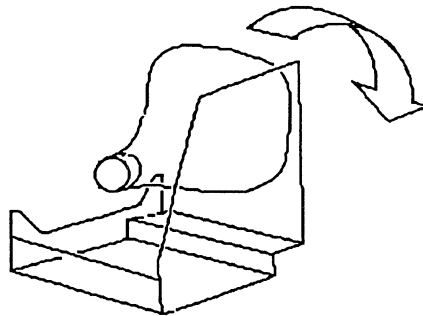

Then insert the motherboard:

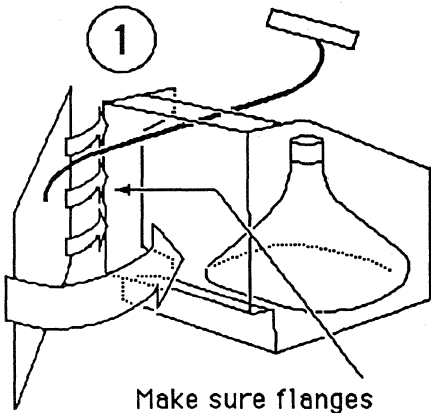

Make sure flanges interlock

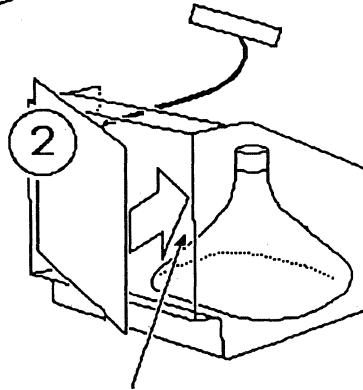

Make sure flanges interlock

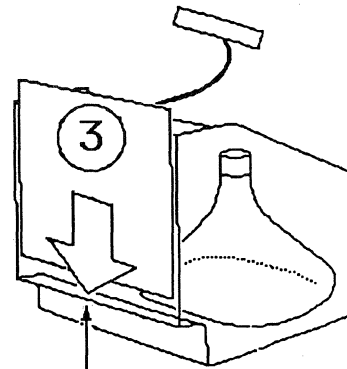

Make sure flanges interlock

-
10. Position the internal cable's backing plate in the backing plate mounting. Make sure the 9-pin D-connector connector faces outward:

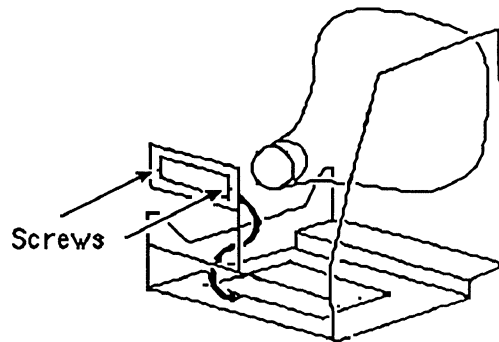

Screw the plate into the Macintosh chassis.

11. On the outside of the case in back, remove the knockout panel that covers the accessory port.

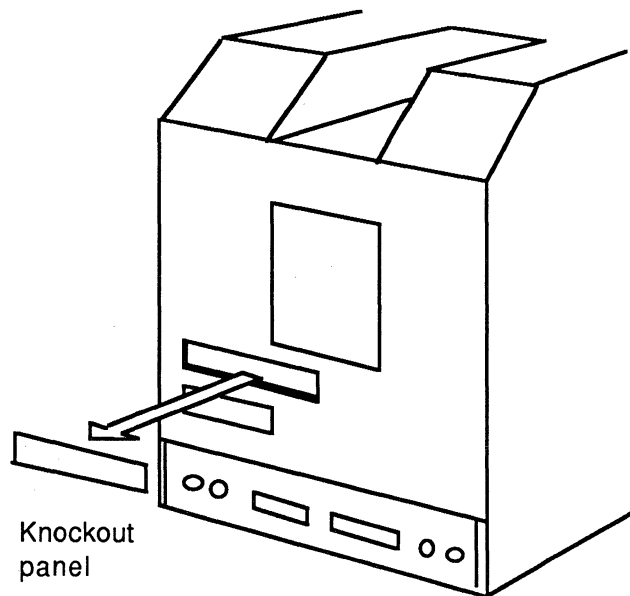

-
12. Reassemble your SE, positioning the accessory port on the case over the mounted end of the cable that now projects out the back of the chassis.

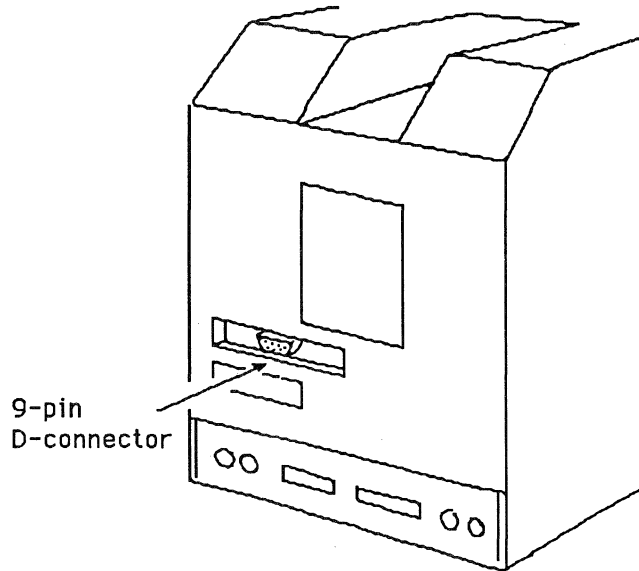

Physically, your internal hardware installation is complete.

Before you can use your MMF Token-Ring Workstation, you must also install the external cable. See the second half of this chapter for complete instructions.

REMEMBER: Test your MMF hardware. To do this, you use the MMF Checker program, which comes with your MMF software. Software installation is described in Chapter 5. The Checker program is also described in Chapter 5.

Avatar Hardware Installation — Macintosh SE/30 Machines

WARNING: The Avatar hardware for the SE/30 version of the MMF Workstation is not user-installable.

Please have an authorized Apple dealer install the MMF Workstation hardware on your Macintosh SE/30.

These instructions are provided for the authorized Apple dealer.

Unpacking Hardware for Macintosh SE/30

Open the Avatar shipping carton and make sure you have everything shown here:

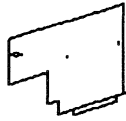

MMF Token-Ring Workstation board

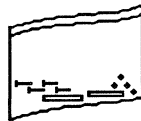

Plastic bag with screws, nuts, etc.

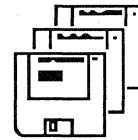

Three diskettes containing software



Internal cable with backing plate and 9-pin D-connector



MMF Workstation User's Guide,
MMF Workstation Installation Guide

If you're missing something, contact Avatar. If anything is damaged, contact the shipping agent.

External Cables

REMEMBER: You must provide an external cable to connect the Workstation to the Token-Ring LAN. Example:



Installing Avatar Hardware Into Macintosh SE/30

Follow these steps to install the MMF Workstation hardware into a Macintosh SE/30 machine:

1. Power down the SE/30.
2. Open the SE/30's case. (The diagram below shows only the main features of the SE/30's internal hardware.)

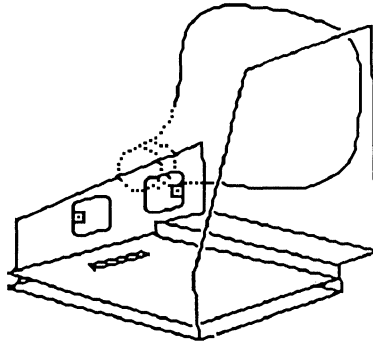

3. Take the Workstation board out of its anti-static bag.

-
4. Position the Workstation board inside the SE/30's chassis.

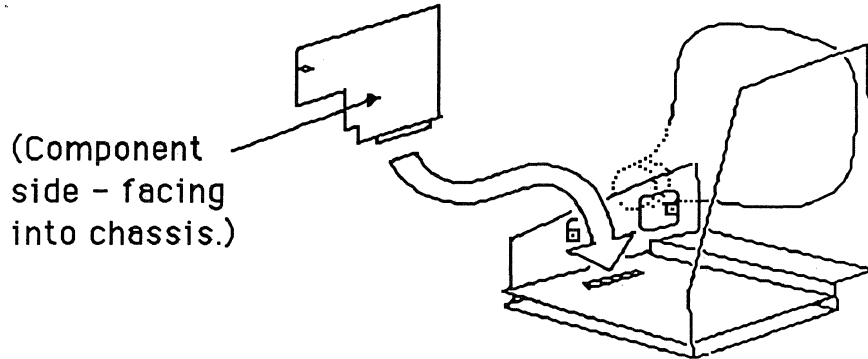

Make sure the Workstation board tucks under the forward flange on the side mounting plate.

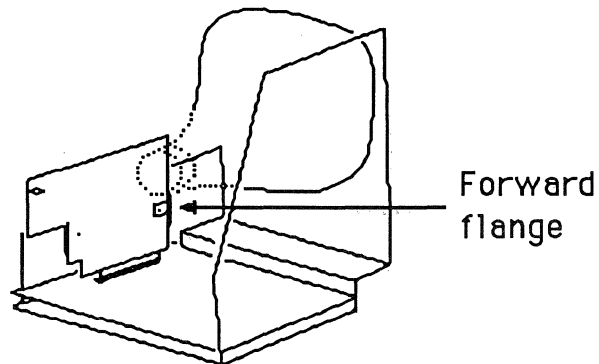

Press the Workstation board down on the expansion connector on the SE/30's motherboard.

-
5. Screw the Workstation board to the side mounting plate.

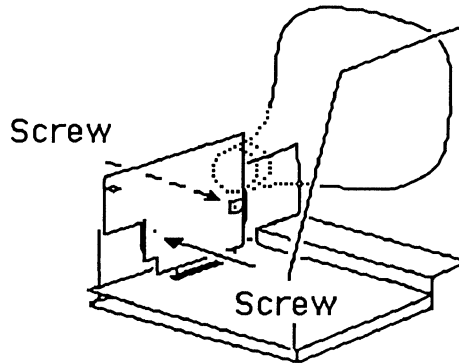

6. Install the internal cable.

Position the backing plate of the internal cable on the inside of the SE/30's chassis so that the 9-pin D-connector connector faces outward:

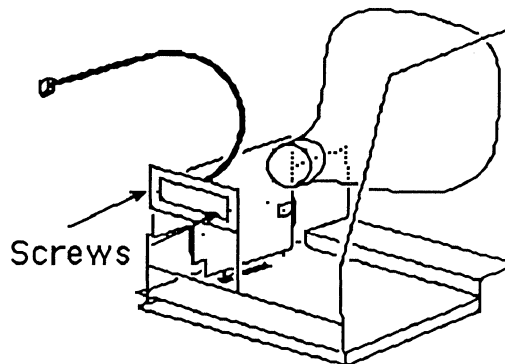

Screw the plate into the Macintosh chassis.

-
7. Connect the other end of the internal cable to the Workstation board.
 - On the Workstation board, find the TBS connector.
 - Plug the cable into this connector.

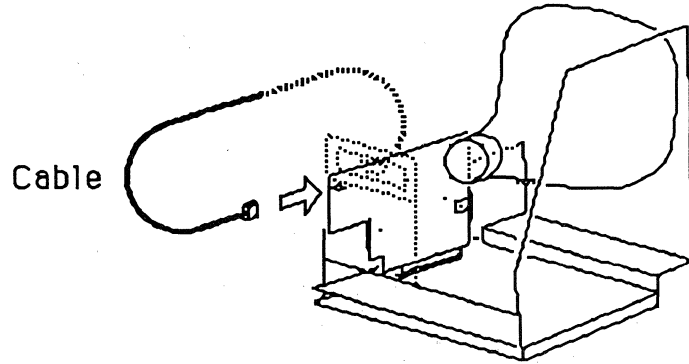

Close-up:

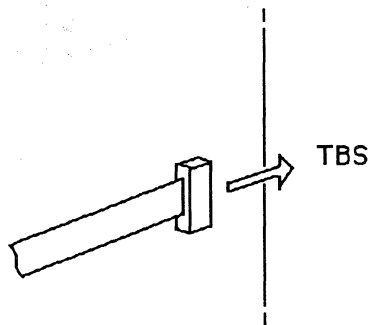

-
8. On the outside of the case in back, remove the knockout panel that covers the accessory port.

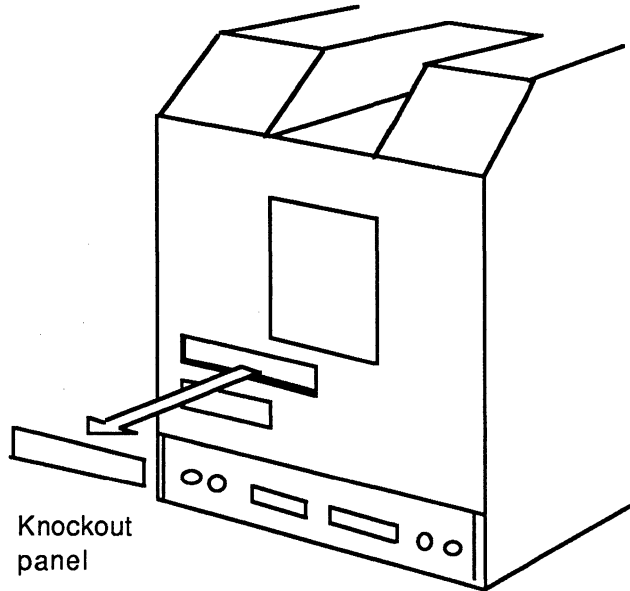

-
9. Reassemble your SE/30, positioning the accessory port on the case over the mounted end of the cable that now projects out the back of the chassis.

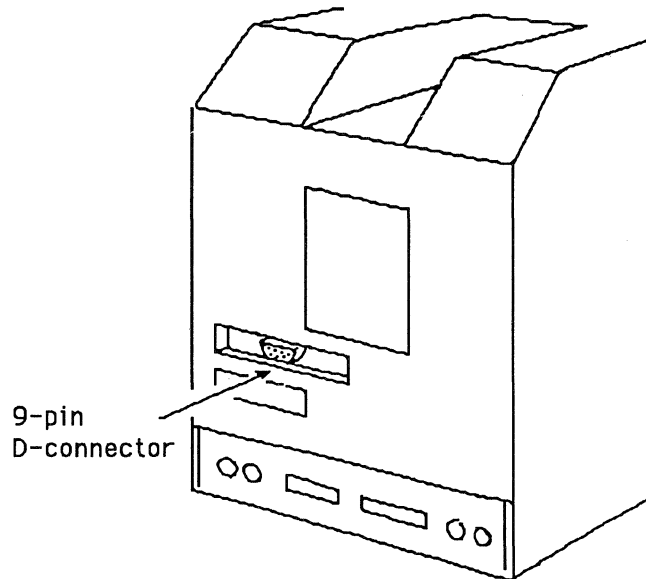

Physically, your internal hardware installation is complete.

Before you can use your MMF Token-Ring Workstation, you must also install the external cable. See the second half of this chapter for complete instructions.

REMEMBER: Test your MMF hardware. To do this, you use the MMF Checker program, which comes with your MMF software. Software installation is described in Chapter 5. The Checker program is also described in Chapter 5.

Avatar Hardware Installation — Macintosh II Machines

Unpacking Avatar Hardware for Macintosh II Family

Open the Avatar shipping carton and make sure you have everything shown here:

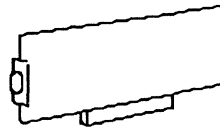

MMF Token-Ring Workstation board

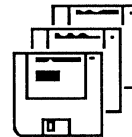

Three diskettes containing software

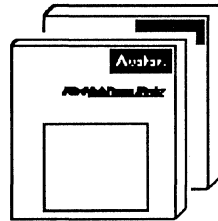

*MMF Workstation User's Guide,
MMF Workstation Installation Guide*

If you're missing something, contact Avatar. If anything is damaged, contact the shipping agent.

External Cables

REMEMBER: You must provide an external cable to connect the Workstation to the Token-Ring LAN. Example:



Installing Avatar Hardware Into Macintosh II Family

Follow these steps to install the MMF Workstation hardware into a Macintosh II machine:

1. Power down the Macintosh II.
2. Open the Macintosh II's case.

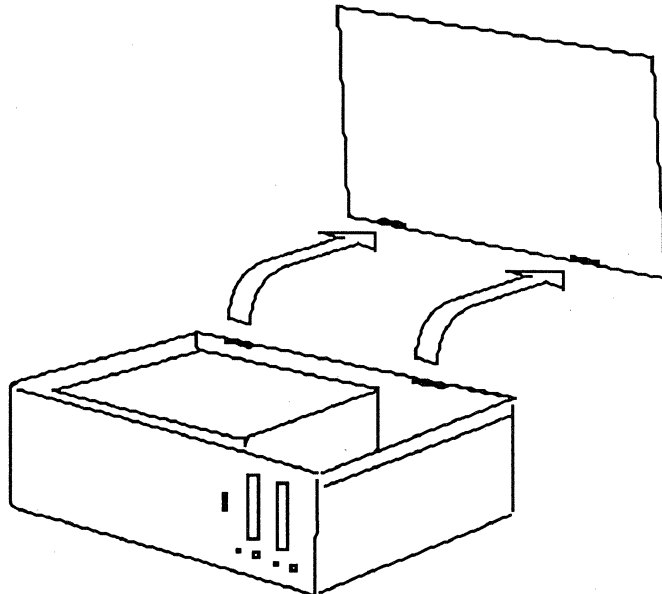

3. Select a slot for the Workstation board. Remove the knockout panel from that slot.
4. Take the Workstation board out of its anti-static bag.

-
5. Slide the Workstation board into the slot in the Macintosh II's chassis:
 - Make sure the 9-pin D-connector projects out through the rear panel.
 - Make sure the expansion connector on the Workstation board lines up with the expansion connector on the Macintosh II's motherboard; the motherboard is on the bottom of the chassis.
 - Gently but firmly press the Workstation board down into place.

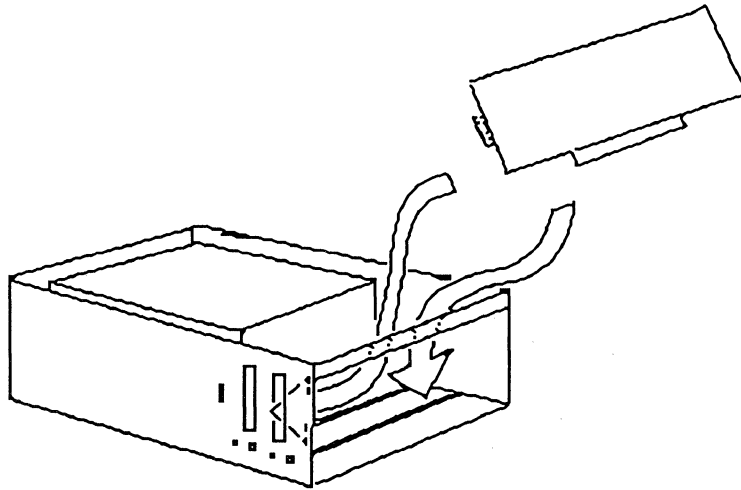

6. Close the Macintosh II's case.

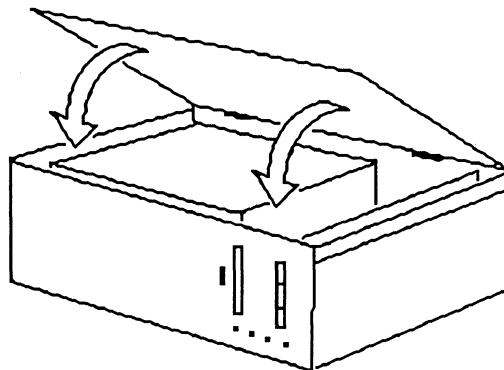

Physically, your internal hardware installation is complete.

Before you can use your MMF Token-Ring Workstation, you must also install the external cable. See the second half of this chapter for complete instructions.

REMEMBER: Test your MMF hardware. To do this, you use the MMF Checker program, which comes with your MMF software. Software installation is described in Chapter 5. The Checker program is also described in Chapter 5.

Attaching the External Cable

After you have installed the Workstation board in your Macintosh and closed the case, install the external Token-Ring cable that connects the Macintosh to the IBM host.

The following sections show how to attach the external cable to Macintosh SE and SE/30 machines and to Macintosh II machines.

Attaching External Cable to Macintosh SE and SE/30

Plug the Token-Ring cable into the Workstation board's 9-pin D-connector, which extends out of the back of the Macintosh SE and SE/30, as shown here:

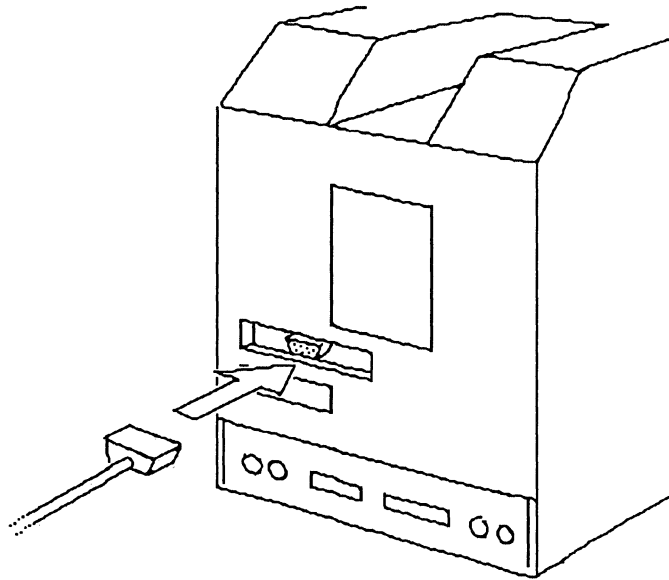

Attaching External Cable to Macintosh II Family

Plug the Token-Ring cable into the Workstation board's 9-pin D-connector, which extends out of the back of the Macintosh II, as shown here:

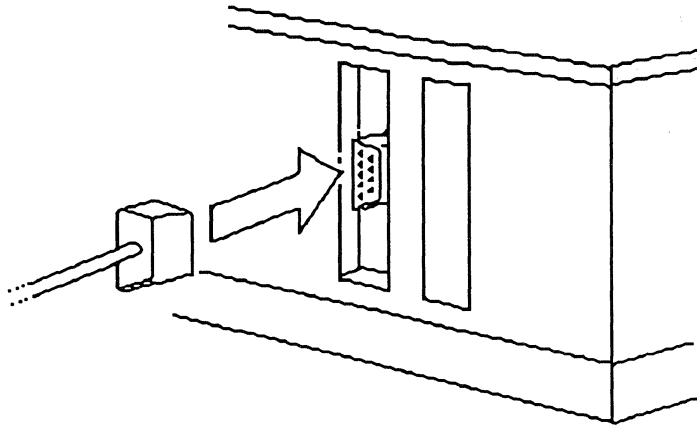

Connecting the Workstation to the Token-Ring LAN

To connect the MMF Token-Ring Workstation to the IBM host, there are two steps:

1. Connect the Token-Ring cable from the Workstation machine to the Token-Ring MAU (Multistation Access Unit). There are various styles of MAUs; here's an example of one:

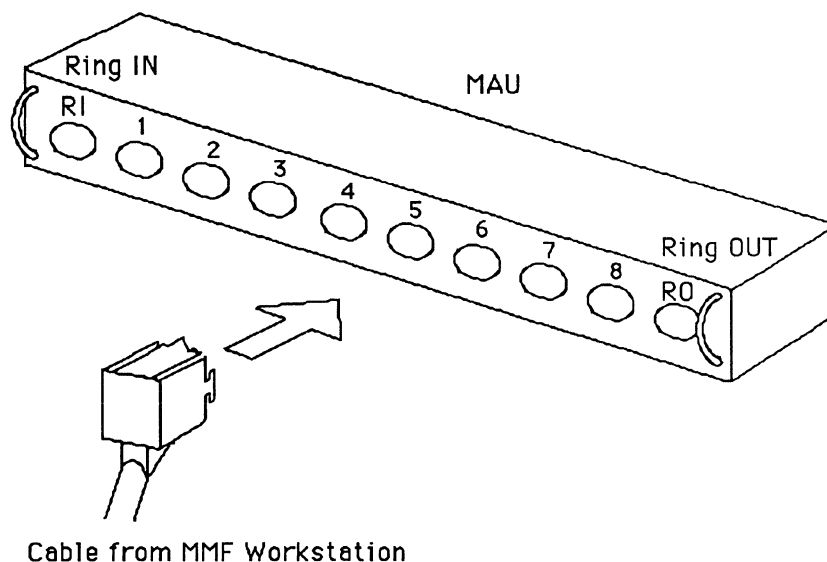

The Token-Ring MAU, in turn, gives your Workstation access to the Token-Ring LAN (Local Area Network).

2. Make sure the Token-Ring LAN leads eventually to the IBM host.

See your network administrator for complete information about connecting to your Token-Ring LAN and about the LAN's connections to the IBM host.

How to Change the Token-Ring Address

This section assumes the Avatar Token-Ring hardware is installed and the AvaTR software is also installed. Chapter 4 explains how to install AvaTR.

For all Macintoshes equipped with Avatar Token-Ring hardware, use:

- The MMF Checker application. Pull down the Control menu and select **Configure Token-Ring...**

On MMF Token-Ring Workstations, use either:

- The Control Panel. Go to the Avatar panel and select the Token-Ring driver. When the 802.5 button appears, click the button; use the Token-Ring Parameters panel that appears.
- The MMF Checker application. Pull down the Control menu and select **Configure Token-Ring...**

For complete information on the MMF Checker, see Chapter 5 in this book.

Chapter 4

AvaTR

Introduction

AvaTR is a software package that provides Token-Ring connectivity for Macintoshes that are equipped with Avatar Token-Ring hardware.

AvaTR also enables AppleTalk connectivity for these machines on the Token-Ring LAN to which their Avatar Token-Ring hardware is connected. (AvaTR does not literally provide the AppleTalk software; AppleTalk software is part of the Macintosh's operating system. AvaTR simply provides the appropriate software support for the AppleTalk software to communicate over Avatar Token-Ring hardware.)

This chapter has two main parts:

1. How to install AvaTR, which gives Token-Ring connectivity.
2. How to enable AppleTalk connectivity.

Please read the next section to find out which parts you need.

How to use this chapter

All Macintoshes that use Avatar Token-Ring hardware:

- Read Part 1.
- Read Part 2 if you also want AppleTalk connectivity over the Avatar Token-Ring hardware.

MMF Token-Ring Workstations that use Avatar Token-Ring hardware:

- Read Part 1. (You may also read Part 2 in order to enable AppleTalk connectivity, but AppleTalk connectivity is not an integral part of the Workstation.)

All MMF/GW Token-Ring Servers:

- Read Part 1.
- Read Part 2 if you have Clients on the same Token-Ring LAN on which you're communicating with the host.

MMF/GW Clients that use Avatar Token-Ring hardware to communicate with their MMF/GW Servers:

- Read Part 1 and Part 2.

Part 1 — Installing AvaTR

Briefly, to install AvaTR, you start your Macintosh from the AvaTR diskette and then run the Apple Installer from that diskette.

Before you start

Make sure:

1. Your Avatar Token-Ring hardware is installed in your Macintosh.
2. Your Macintosh is physically connected to the Token-Ring LAN.

See Chapter 3 for how to perform these tasks.

1. Open the AvaTR diskette.

Open the AvaTR diskette and make sure you have everything shown here:

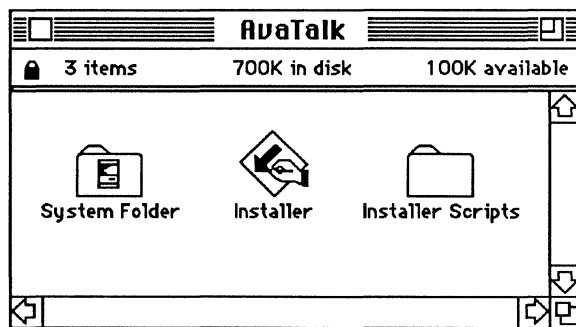

In the System Folder:

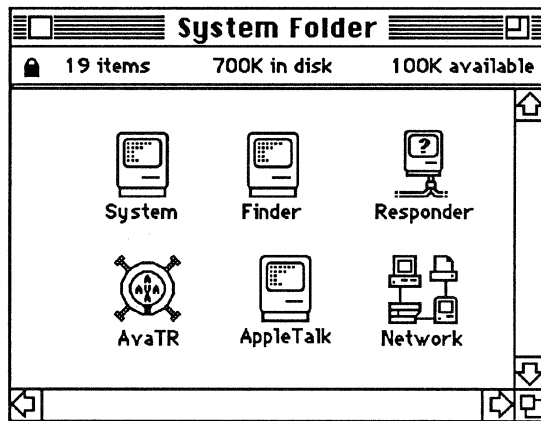

2. Restart your Macintosh from the AvaTR diskette.

Make sure the AvaTR diskette is still in your Macintosh's diskette drive.

Pull down the Finder's Special menu and select **Restart**.



3. Open the Installer.

When your Macintosh is started again, open the Installer application:



Installer

You'll see the following dialog box:

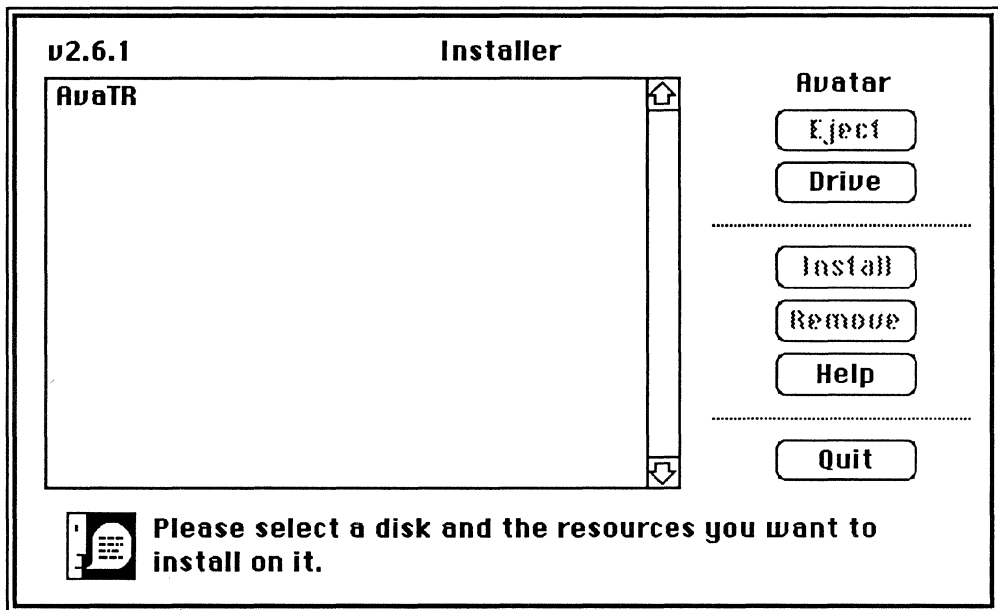

REMEMBER: Don't move the Installer onto your Macintosh — just run it from the AvaTR diskette.

4. Install AvaTR.

To install AvaTR, select AvaTR from the scroll list:

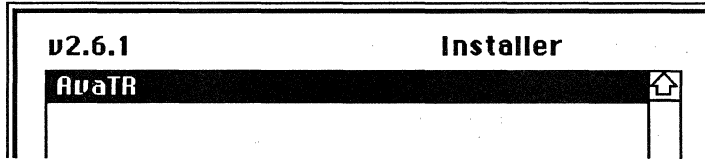

Use the Eject and Drive buttons, if necessary, to make sure you're installing to the correct disk.

Then click the Install button:

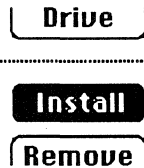

When installation has completed successfully, you'll see this message (with the name of your disk substituted for Avatar):

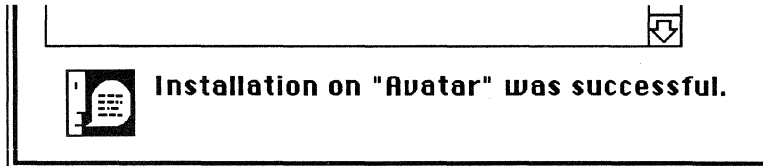

5. Quit the Installer.

When the Installer has finished installing AvaTR, close the Installer. (Don't eject the AvaTR diskette yet; it will eject automatically after the next step.)

Your installation of AvaTR is now complete.

6. Restart your Macintosh from your regular start-up disk.

Make sure you start up your Macintosh **from your regular start-up disk**, not the Installer diskette.

Select **Restart** from the Special menu:



As your Macintosh comes up, if you're running a MMF product, the presence of normal MMF icons on your start-up screen means that AvaTR is operating normally.

Part 2 — Enabling AppleTalk Connectivity

Enable AppleTalk connectivity if you're planning to use AppleTalk to communicate via your Avatar Token-Ring hardware.

- You might want to use AppleTalk this way in order to communicate with other Macintoshes on the Token-Ring LAN, such as AppleShare Servers.
- MMF/GW Token-Ring Servers need AppleTalk connectivity. MMF/GW Clients that are using Avatar Token-Ring hardware to communicate with their MMF/GW Servers need AppleTalk connectivity. For more information on MMF/GW Servers and Clients, see the MacMainFrame Series *Gateway Server Administrator's Guide*.

Before you start

Make sure you have installed AvaTR (see Part 1 of this chapter) including restarting your Macintosh.

1. Go to the Control Panel.

Pull down the Apple menu and select the Control Panel.

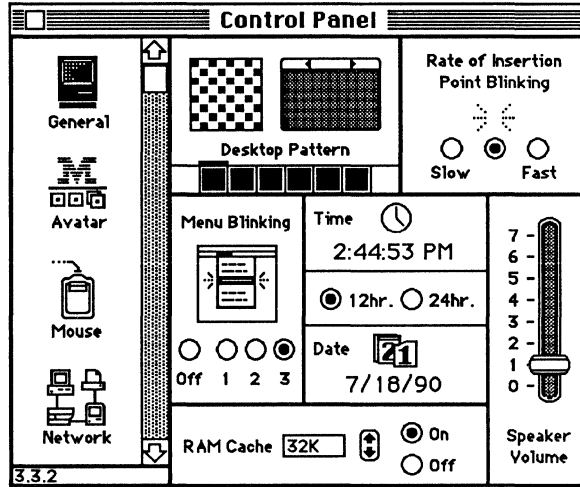

In the Control Panel, select the Network panel:

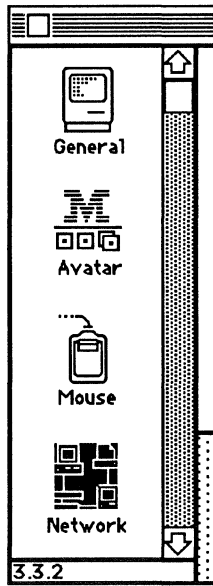

2. Select AvaTR.

In the Network panel, select the AvaTR icon.

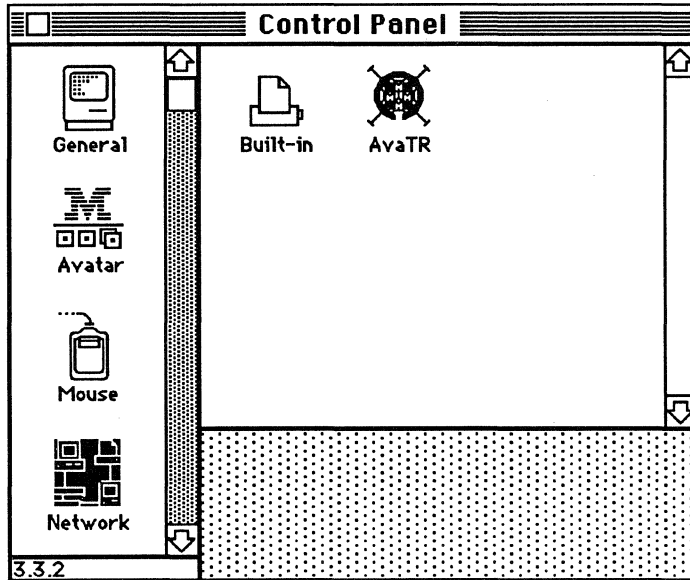

The cursor will now change to a rolling ring, indicating that AvaTR is trying to insert your Macintosh onto the Token-Ring LAN.

CAUTION: The effects of this step are immediate. This means that by clicking a *non-AvaTR* icon (assuming, of course, you've previously selected AvaTR here), you can take your Macintosh *off* the Token-Ring LAN in the middle of a data transfer.

If you are about to disrupt ongoing network communications, you'll see the following message:

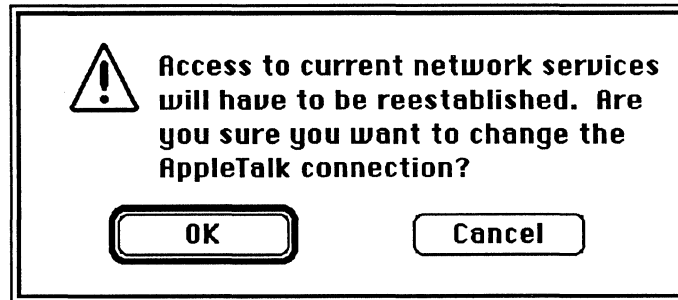

Answer appropriately and proceed.

Multiple Token-Ring Boards

If you're a Macintosh II and you have more than one Avatar Token-Ring board, you'll have more than one AvaTR. The AvaTR copies will be named AvaTR(9), AvaTR(A), etc., according to the Macintosh II slots in which their boards reside. Example:

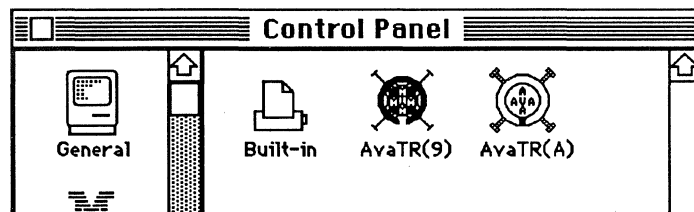

In this case, changing your selection from one AvaTR to another changes your AppleTalk connectivity from one Avatar Token-Ring hardware connection to another.

3. Close the Control Panel.

Enabling AppleTalk connectivity over your Avatar Token-Ring hardware is done.

To Set The AppleTalk Zone

NOTE: This section is useful only if there is more than one AppleTalk zone on your LAN.

To set your AppleTalk zone, go to the Network Panel (in the Control Panel) and double-click on the the AvaTR icon.



The Network Panel will these display a dialog box like this:

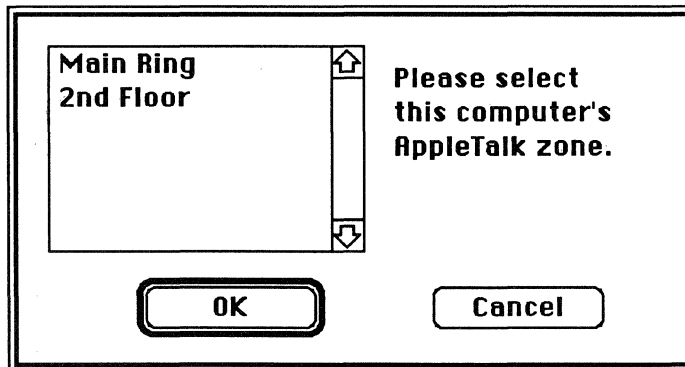

Click on the AppleTalk zone in which you want your Macintosh to reside.

When you're done, click **OK** or **Cancel**.

Your network administrator determines the AppleTalk zones on your network. See them for complete information.

Chapter 5

Installing the MMF Token-Ring Workstation Software

Introduction

The steps to install the MMF Workstation software are the same for all Macintosh hardware platforms:

1. Check your MMF Workstation components.
2. Open the Workstation diskettes.
3. Drag files to the System folder.
4. Install the Workstation application.
6. - 13. Go to the Control Panel and perform various set-up tasks.
14. Restart your Macintosh.
15. Run the MMF Checker application.

The following sections explain each step in detail.

Before You Start

These instructions assume your Token-Ring hardware is installed and AppleTalk connectivity is enabled on your Macintosh.

Does your Workstation require AvaTR?

Workstations with Avatar Token-Ring hardware need AvaTR. If your MMF Token-Ring Workstation and is equipped with Avatar Token-Ring hardware, make sure you have installed the **AvaTR** software. AvaTR provides Token-Ring connectivity for your Macintosh. (AvaTR also enables AppleTalk connectivity for Mac-to-Mac communication on the Token-Ring LAN.)

Chapter 4 contains complete instructions for installing AvaTR.

Workstations with non-Avatar Token-Ring hardware do not. If you're using non-Avatar Token-Ring hardware on your MMF Token-Ring Workstation, you don't need the AvaTR software.

1. Check Your MMF Workstation software.

To install the MMF Workstation software you need the software and the manual.

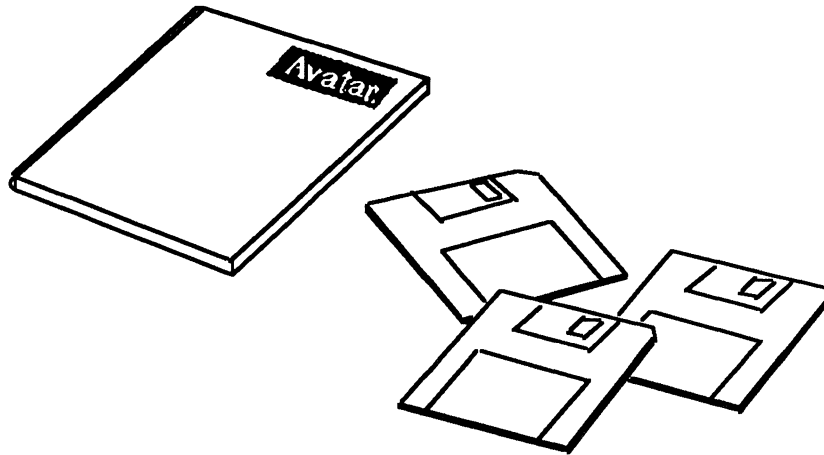

You're reading the manual now.

The software comes on three diskettes.

2. Open the Workstation diskettes.

Double-click the mouse on the diskette icon to open the diskettes.

Make sure you have all the documents shown below. If anything is missing, Contact Avatar.

Diskette 1:

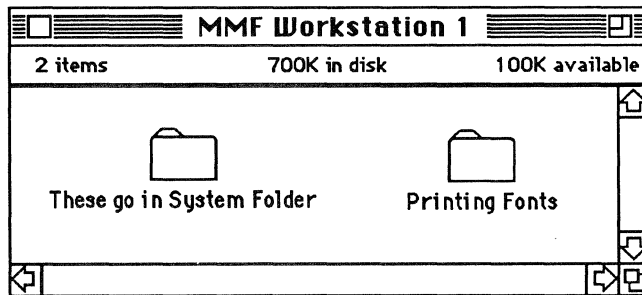

Diskette 2:

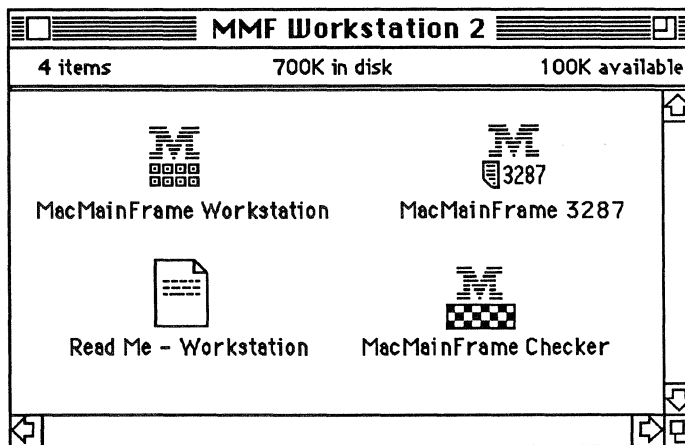

Make a backup copy of each diskette.

Read the Read Me - Workstation document first. It contains important information about the current release of the Workstation software. Read Me - Workstation is a Macintosh text document, which you can read with the TeachText application.

3. Drag files to the System folder.

Insert the diskette and double-click on the folder entitled, "These go in System Folder."

Make sure the following documents are there. (If you're not sure which documents are which, Appendix A contains a key to the MMF Workstation icons.)

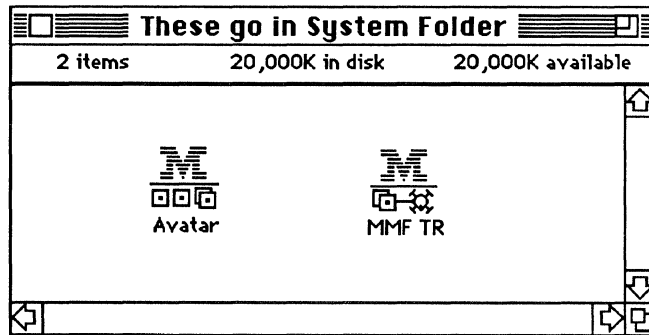

Drag the Avatar icon and the Token-Ring driver icon — MMF TR — to the System folder:

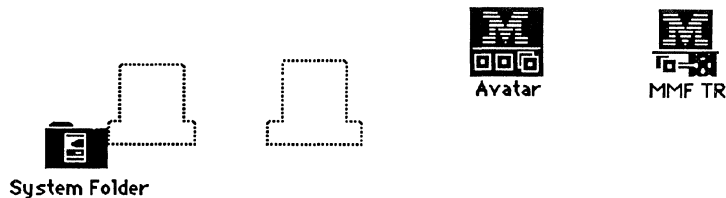

Close the System folder.

4. Install the Workstation application.

Insert the diskette and drag the MMF Workstation application icon from the diskette to a convenient place on your Macintosh's start-up disk.

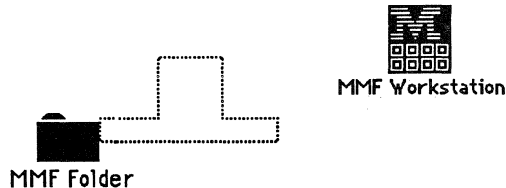

MacMainFrame 3287, MacMainFrame Graphics

You may also install these other MacMainFrame products at this time:

- **MacMainFrame 3287**, Avatar's printer emulation software. For complete information on MMF 3287, see the *MacMainFrame Series Coax/SDLC/Token-Ring Workstation User Guide*.
MMF 3287 comes with the MMF Token-Ring Workstation software.
- **MacMainFrame Graphics**, Avatar's host graphics emulation software, for use with MacMainFrame Series products. For complete information on MMF Graphics, see the *MacMainFrame Series Graphics Option User Guide*.

MMF Graphics is a separate product; see you Avatar representative.

5. Go to the Control Panel.

Pull down the Apple menu and select the Control Panel.

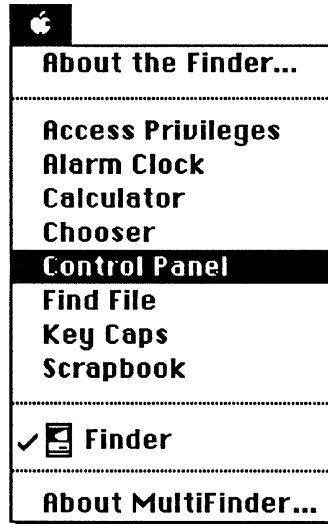

In the Control Panel, you'll do the following:

- Go to the Avatar panel; select a driver for the Token-Ring hardware.
- Select the language conventions for your workstation.
- Identify your LU session(s) as being for Terminal, Printer, or Graphics.
- In the Avatar panel, go to the 802.5 Parameters panel (Token-Ring parameters panel); set your Token-Ring address and other Token-Ring parameters.
- In the Avatar panel, optionally lock all the Avatar panel settings.

The following sections — steps 6 through 13 — show you how to do this.

6. Go to the Avatar Control Panel.

Click the Avatar icon.

The Avatar panel will appear, displaying the MMF Drivers that currently reside in your System Folder.

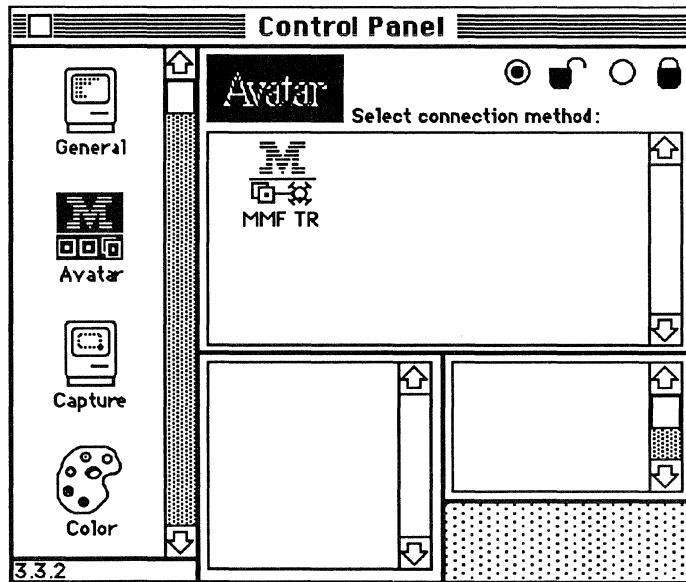

7. Check the lock panel.

Supply a password if necessary, and make sure the unlocked icon is selected:

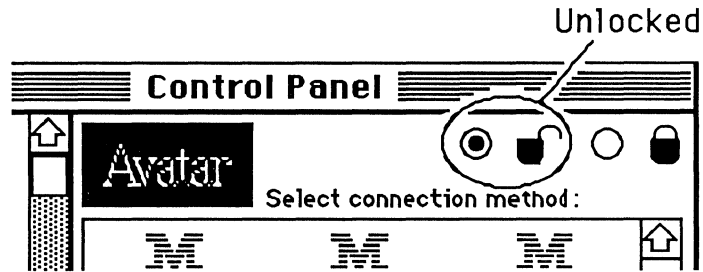

For complete information on how to use the Avatar lock panel, see Appendix B.

8. Select the Token-Ring driver.

Click on the MMF TR (MacMainFrame Token-Ring) driver.

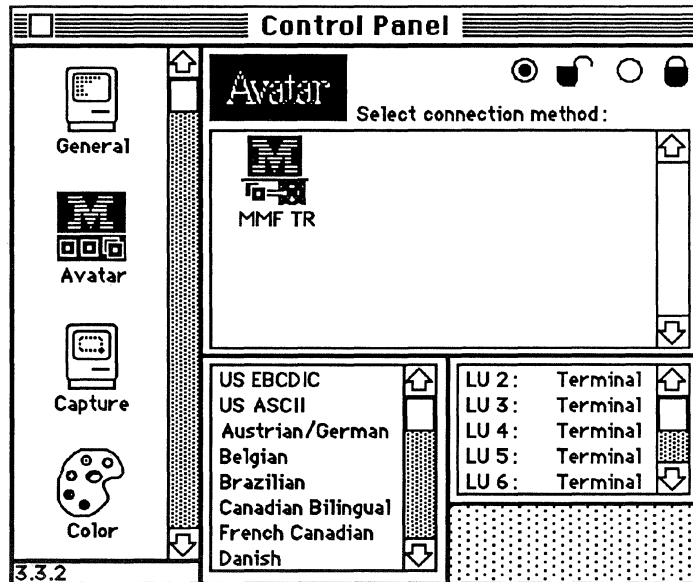

9. Set the Token-Ring Parameters.

When you select the MMF Token-Ring driver, the Token-Ring parameters button, which is labeled **802.5 Setup**, will appear in the lower right corner of the Control Panel:

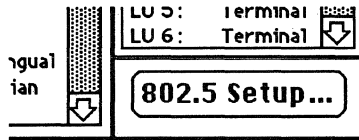

(802.5 is the IEEE standard on which Token-Ring protocols are based.)

- Click the 802.5 Setup button.

You'll then see the Token-Ring Parameters panel. Briefly, this panel lets you establish your MMF Workstation as a physical unit (PU) on the IBM network. Make sure the information in this panel is correct.

- Verify the items in this panel by referring to the next section.
- Click **OK** or **Cancel** as appropriate to return to the main Control Panel.

The Token-Ring Parameters Panel

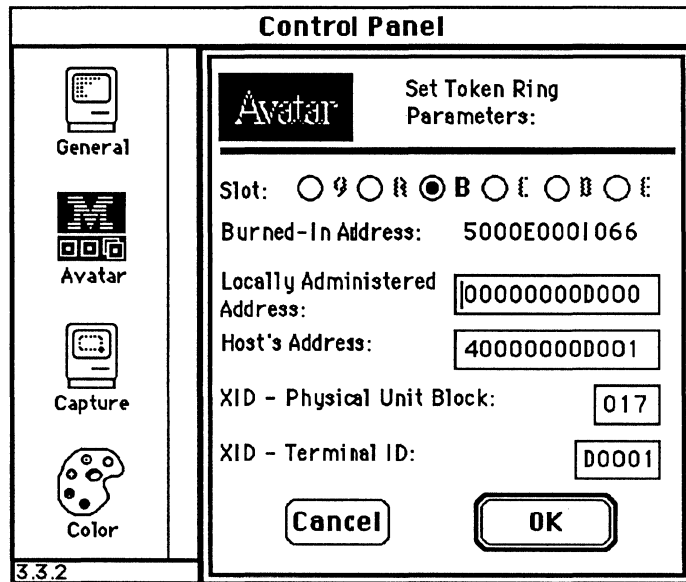

NOTE: On **Macintosh SE machines**, where there is only one expansion slot, the first item will mention not mention the slot but simply mention the hardware, if any, that is currently in the slot. Example:

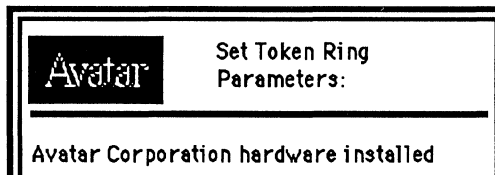

Items in the Token-Ring Parameters panel

Slot: 9 A B C D E These radio buttons specify the Token-Ring board that MMF Workstation should use to connect to the host, according to the board's expansion slot in a Macintosh II chassis.

- If there's only one Token-Ring board, MMF Workstation pushes the correct button for you, and you can't change the button.

-
- If there's more than one Token-Ring board, MMF Workstation stops at the first Avatar Token-Ring board it finds and pushes that button for you. You can select a different button if you wish.

If there are no Avatar boards, MMF Workstation stops at the first Token-Ring board it finds and pushes that button. If there are other Token-Ring boards, you can select a different button if you wish.

Since there are several slots in a Macintosh II, you can have several Token-Ring boards, so you'll need to check these buttons to make sure the MMF Workstation software selects the correct one for you.

REMEMBER: *This feature is for Macintosh II machines only.* See your Macintosh II documentation for information on opening the Macintosh II chassis and obtaining the names of the expansion slots.

Burned-in Address: This is the Token-Ring board's unique permanent address, which the manufacturer assigns to the board according to the IEEE 802.5 Token-Ring standard.

To have the board use the burned-in address on the Token-Ring network, make sure the **Locally-Administered Address** field contains all zeroes.

Locally-Administered Address: This is an alternate address that the Token-Ring board can use in place of its burned-in address.

If there is anything in this field other than zeroes, this field will become the board's Token-Ring address, overriding the burned-in address. To clear this alternate address and have the board use its original burned-in address, fill this field with zeroes.

Host's Address: The Token-Ring address of the IBM host or of an upstream cluster controller that leads to the IBM host. Obtain this address from your network administrator.

XID - PU Block: Obtain the PU Block from the IBM system manager or from your network administrator.

XID - Terminal ID: Obtain the Terminal ID from the IBM system manager or from your network administrator.

The MMF Workstation software and the IBM host concatenate the PU Block and the Terminal ID to form a complete XID. The XID identifies your Macintosh to the IBM host as an IBM Physical Unit (PU).



Confirms the information in the Token-Ring Parameters panel.



Discards any changes you've made and restores the information that was in place when you invoked the Token-Ring Parameters panel.

10. Close the Token-Ring panel, go to the LU panel.

After you leave the Token-Ring Parameters panel and return to the main Control Panel, go to the LU panel:

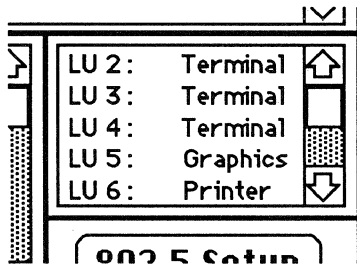

Make sure your LU sessions are set to the appropriate type, either Terminal, Printer, or Graphics. To do this, position the cursor over the desired LU and hold down the OPTION key. The cursor will change from a cross to a double-ended arrow:

LU 4: + Terminal

LU 4: ↔ Terminal

Click the cursor on the desired LU to have the LU's type change from Terminal to Printer to Graphics to Terminal, and so on in a loop.

- LU sessions of type Printer are for use by the **MMF 3287** printer emulation software. Only one LU session at a time can be a Printer session. For complete information on MMF 3287, see the MacMainFrame Series *Coax/SDLC/Token-Ring Workstation User Guide*.
- LU sessions of type Graphics are for use by the **MMF Graphics** software. For complete information on MMF Graphics, see the MacMainFrame Series *Graphics Option User Guide*.

11. Go to the language panel.

The language panel appears in the Avatar Control Panel:

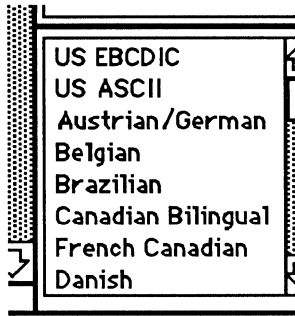

Scroll through the list of languages and click on the language that's configured on your IBM host. See your host system manager for information about this language.

The language panel lets you select the language conventions that your MMF Workstation will follow when it transfers data to and from the IBM host . (Example: When you select Austrian/German, MMF Workstation will recognize and reproduce characters that have umlauts over them — ä, ë, etc.)

This selection applies to all LU sessions on this Workstation.

12. Check the lock panel.

The Lock panel lets you optionally lock the parameters in the Avatar control panel.

Go to the Lock panel again and make sure the icon you wish is selected — either locked or unlocked. Supply a new password now if you wish.

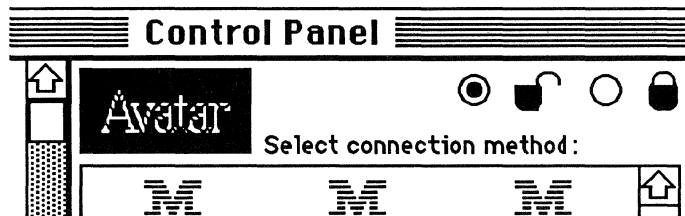

For complete information on how to use the Avatar lock panel, see Appendix B.

13. Close the Control Panel.

Close the Macintosh Control Panel by clicking the Close box in the upper left corner.

You'll see an alert box:

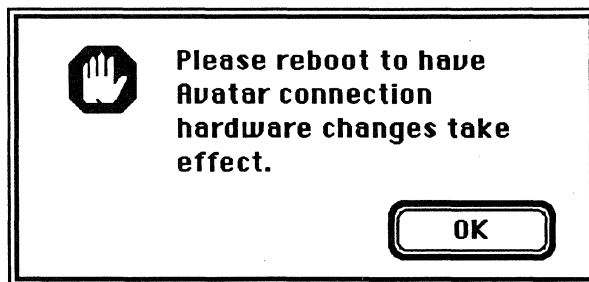

14. Restart your Macintosh.

Select **Restart** from the Special menu:



As your Macintosh comes up, the Workstation icon will appear:



Bad Start-up

At power-up time, if the Workstation icon turns on its side or has an X through it, make sure your MMF Workstation hardware and software are installed properly.



(You can force the MMF Workstation not to run by powering up your Macintosh with your finger on the OPTION key or the mouse button. The Token-Ring Workstation icon will also appear with an X through it in that case.)

When your Macintosh is up again (and no sideways or X-ed out icons have appeared), MMF Workstation is running again.

15. Run the MMF Checker application

The MMF Checker application tells you the current status of your MMF hardware and software. You can use MMF Checker as soon as your Macintosh has powered up.

To check your entire MMF Workstation configuration:

1. Make sure the MMF Workstation hardware is properly installed in your Macintosh. See Chapter 3.
2. Make sure the Macintosh is physically connected to the IBM host via the external cable. See Chapter 3.
3. Make sure the AvaTR software is properly installed in your Macintosh. See Chapter 4.
4. Make sure the MMF Workstation software is properly installed in your Macintosh. See the preceding instructions in this chapter.
5. Load the MacMainFrame Checker application from the MMF Workstation distribution diskette (or the AvaTR diskette) to your Macintosh's start-up disk.



MacMainFrame Checker

6. Double-click on the MMF Checker icon. The menu bar will change to the Checker's:



-
7. To check your MMF Workstation hardware status, select **Hardware Status...** from the Control menu:

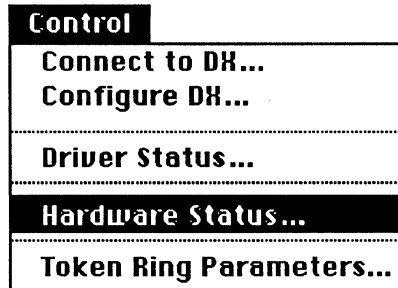

- To check your MMF Workstation software status, select **Driver Status...** from the Control menu:

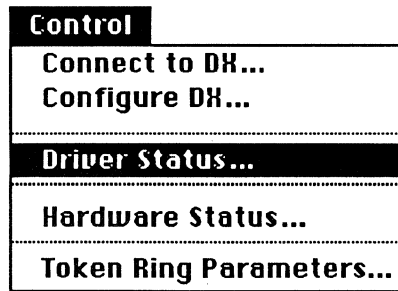

Change the Token-Ring Address If Necessary

- To change your MMF Workstation's Token-Ring address, select **Token-Ring Parameters...** from the Control menu:

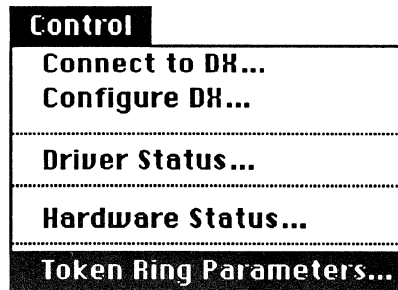

-
8. When you've finished running the Checker, pull down the Checker's File menu and select **Quit** to quit the Checker.

Software Installation Done

Your MMF Workstation software is now installed.





To start and configure the MMF Workstation software, follow the instructions in the MacMainFrame Series *Coax/SDLC/SDLC Workstation User Guide*.

Appendix A



Key to MMF Workstation's Icons

This appendix lists the icons you may see when you use MMF Token Ring Workstation.





System Icons

| Icon | Type | Does this: |
|---|------------------------|--|
|  <p>Avatar</p> | Control Panel document | Lets you select driver software that MMF products must use; lets you supply configuration parameters to the drivers. |
|  <p>MMF TR</p> | Driver software | Lets MMF products communicate with hardware and perform other basic tasks. |
|  <p>Network</p> | Control Panel document | Lets you choose AvaTR, for use on Token Ring Workstations. |
|  <p>AvaTR</p> | AvaTR software | Lets Avatar Token-Ring hardware communicate on Token-Ring LANs; also lets AppleTalk protocols run over Avatar Token-Ring hardware. |
|  <p>MacMainFrame Checker</p> | Application | Lets you verify your hardware and software installation of MMF Workstation, and lets you configure your MMF Workstation. |

Application Icons

| Icon | Type | Name and Function: |
|--|------------------------------|--|
|  MacMainFrame Workstation | Application | MacMainFrame Workstation — This is the MMF Workstation software. Accepts and displays data in your 3270 windows; communicates with the MMF Workstation driver. |
|  (User supplies name) | Session Settings document | Saves your MMF Workstation set-up — LU sessions, host configuration, keyboard layout, etc. |
|  (User supplies name) | Batch document | Contains commands for MMF Workstation to perform batch processing of uploads, downloads, and File deletes. |

Application Icons, continued

| Icon | Type | Name and Function: |
|--|-------------------------|---|
|  <p data-bbox="297 453 501 517">MacMainFrame 3287</p> | Application | MacMainFrame 3287 — Emulates a 3287-type printer and lets MMF Workstation route an IBM print stream to the Chooser printer. |
|  <p data-bbox="344 656 454 682">Armonk</p> | Font | Armonk — Avatar's proprietary type font (bitmap version), for use with MMF Series products. |
|  <p data-bbox="354 847 444 873">Armon</p> | Font | Armon — Postscript version of Armonk font. |
|  <p data-bbox="301 1038 496 1098">(User supplies name)</p> | Print Settings document | Saves your MMF 3287 set-up. |

Appendix B

The Avatar Lock Panel

Introduction

The lock panel lets you secure some of the MMF Workstation's parameter settings so that no one can change them without a password. The lock panel does not prevent users from using the Workstation.

To get to the lock panel, go to the Macintosh Control Panel and select the Avatar icon in the scroll list on the left. (If there's no Avatar icon in the list, your Workstation software is not fully installed. See Chapter 3 for instructions.)

The lock panel looks like this:

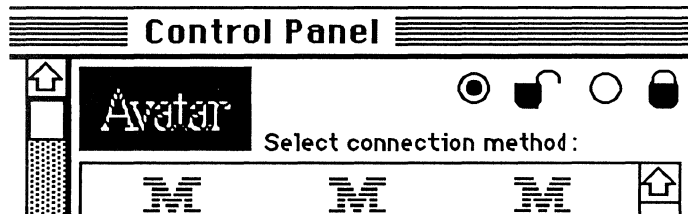

If the locked lock is selected, you must supply a password before you can change any parameters in the various parameters panels.

Locked Items

On MMF Token Ring Workstations, the items that the Avatar lock panel locks include:

- LU panel settings.
- Language panel settings.
- Token Ring panel settings.

When the items are locked, you can view the parameter settings, but you can't change them unless you click the unlock radio button and fill in the passwords as MMF requests.

CAUTION: Once you give a user the password for their Workstation, they can change the password at that Workstation, which means they can temporarily prevent you, the network administrator, from changing the settings at that Workstation any further.

Items the Lock Does Not Affect

The Avatar lock panel's mechanism does *not* affect the following items:

- Applications, such as the MMF Workstation application.
- The contents of MMF Session Settings documents.

To Set The First Password

Avatar ships the lock panel in an opened state; that is, there is no password and anyone can use the lock panel and the parameters it controls.

To set the first password:

1. Click the "locked" radio button: 

You'll see the following dialog box:

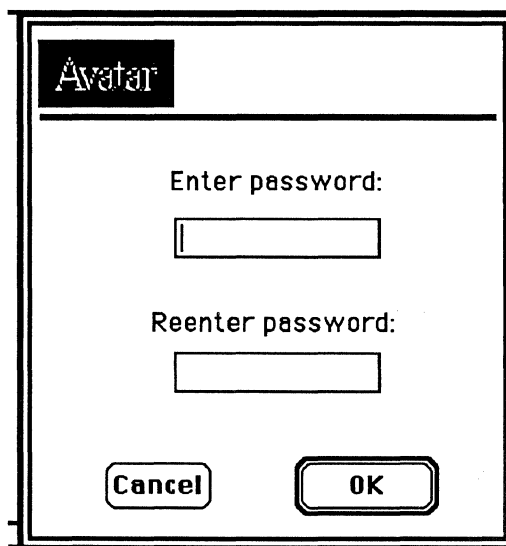

The dialog box is titled "Avatar" in a black box at the top left. It contains two text prompts: "Enter password:" followed by a rectangular input field, and "Reenter password:" followed by another rectangular input field. At the bottom of the dialog, there are two buttons: "Cancel" on the left and "OK" on the right.

2. To set the new password, enter the password in both password items, as the prompts indicate.
3. Click OK.

MMF will return you to the lock panel, and the locked icon will be selected:



This means your MMF Workstation parameters are *now locked*; you can use your workstation but you can't change any of its parameters unless you unlock the lock.

To Open the Lock

To open the lock:

1. Click the "unlocked" radio button: 

MMF will now display the following dialog box:



The dialog box has a title bar with the word "Avatar" on the left. Below the title bar, the text "Enter password:" is centered above a rectangular input field. At the bottom of the dialog box, there are two buttons: "Cancel" on the left and "OK" on the right.

2. Supply a correct password.
3. Click OK.

MMF will return you to the lock panel, and the unlocked icon will be selected:



To Change the Password

To change the password:

1. Unlock the lock, as described above.
2. Then follow the same procedure as to set the first password: click the unlock radio button, then supply the new password in both password items.

When You Forget Your Password

If you forget the password, you won't be able to unlock the lock; you also won't be able to change the password (for example, to one you can remember).

To solve this problem, you must install a new copy of the Avatar Control Panel document in your System Folder:



Then go to the Avatar Panel and follow the steps in "To Set the First Password," above.

Don't forget to get rid of the old Avatar Control Panel document.

REMEMBER: The password.

Index

- 802.5
 - Panel 60
 - Parameters (See also Token-Ring Parameters)
 - Set-Up Button 60
- 802.5 Setup button 60
- 9-pin D-connector
 - On Macintosh II 33, 36
 - On Macintosh SE 21, 22, 35
 - On Macintosh SE/30 27, 30, 35

A

- Addresses
 - Burned-in 62
 - Host (In Token-Ring Parameters panel) 62
 - Locally Administered 38
 - Locally-administered 62
 - Token-Ring
 - How to change 38
- AppleTalk 39, 72
 - Enabling 46
 - Zones 50
- Armon (icon) 74
- Armonk™ font (icon) 74
- Avatar
 - Control Panel document 55
 - Control Panel document (icon) 72
 - Icon 58
 - Lock panel 75
 - Panel 58, (See also Control Panel)
 - 802.5 Set-Up Button 60
 - Lock panel 59
 - Products 2
- AvaTR 39, 48, 52
 - Diskette 41
 - Enabling AppleTalk connectivity 46
 - Installing 41
 - Setting AppleTalk zones 50

Token-Ring connectivity 39
AvaTR (icon) 72

B

Batch file (icon) 73
Burned-in address (In Token-Ring Parameters panel) 62
Buttons
 802.5 Set-Up 60
 802.5 Setup (See also Token-Ring Parameters)
 Token-Ring Parameters 60

C

Cables
 External 9
 How to attach 35
 For Macintosh SE 16
 For Macintosh SE/30 24
 Internal
 Installing 18, 27
 Token-Ring
 Attaching 35
 Attaching to Macintosh 35
Checker application 68
Checker application (icon) 72
Connectivity
 AppleTalk 46
Connectors
 9-pin D
 On Macintosh II 33, 36
 On Macintosh SE 21, 22, 35
 On Macintosh SE/30 27, 30, 35
 Expansion 17
 Macintosh II 33
 Macintosh SE/30 26
 J1 18
 TBS 28
Control Panel 57
 Avatar panel 58
 Closing 66
 Network Panel 47, 50

D

D-connector

On Macintosh II 33

On Macintosh SE 21, 22, 35

On Macintosh SE/30 27, 30, 35

Diskettes

AvaTR 41

MMF Workstation software 54

Dragging files to System Folder 55

Drivers

Checking with MMF Checker 69

MMF TR 55, 59

MMF TR (icon) 72

Token-Ring 59

E, F

Folders

System 55

G

Graphics 64

H

Hardware 8

Addresses 62

How to change 38

Checking with MMF Checker 69

Installation 13

Macintosh II 31

Macintosh SE 15

Macintosh SE/30 23

Network 9

Non-Avatar 7

Token-Ring 39

Multiple boards 49

Host Address (In Token-Ring Parameters panel) 62

- How to attach external cables 35
- How to change Token-Ring addresses 38
- How to install MMF Workstation hardware 13
- How to install MMF Workstation software 51
- How to use Avatar Token-Ring products 3

I

- IBM
 - Physical units 60
- IBM host 7, 11
 - Connecting MMF Workstation to 37
 - Connectivity to 11
- Icons 72
 - At start-up 67
 - Avatar 58
 - Avatar Panel 55
 - AvaTR 48
 - Bad start-up 67
- Installer 43
- Internal cables
 - For Macintosh SE 18
 - For Macintosh SE/30 27

J

- J1 connector (Macintosh SE motherboard) 18

K, L

- Language panel 65
- Locally Administered Address (Token-Ring)
 - How to change 38
- Locally-Administered Address (In Token-Ring Parameters panel) 62
- Lock panel 59, 66, 75
- LU panel (In Avatar panel) 64
- LU sessions 64
 - Changing
 - From Terminal to Printer to Graphics 64

M

- Macintosh 7, 8
 - Restarting 67
 - System 6.0.5 10
- Macintosh II
 - Attaching Token-Ring cable to 36
 - Installing hardware into 31
- Macintosh SE
 - Attaching Token-Ring cable to 35
 - Installing hardware into 15
- Macintosh SE/30
 - Attaching Token-Ring cable to 35
 - Installing hardware into 23
- MacMainFrame (See also MMF)
- MAU (See Multistation Access Unit)
- MMF 3287 64
- MMF 3287 (icon) 74
- MMF Checker 38, 68, 72
- MMF Graphics 64
- MMF TR 59
- MMF TR (driver) 55
- MMF TR (icon) 72
- MMF Workstation
 - Diskette 54
 - Hardware 8
 - Hardware installation 13
 - Icons 72
 - Installing 56
 - Introduction 5
 - Software
 - Diskettes 54
 - Software installation 51
- MMF Workstation (icon) 73
- MMF/GW Client 46
- MMF/GW Server 46
- Motherboards
 - Macintosh II 33
 - Macintosh SE 19
 - Macintosh SE/30 26
- Multistation Access Unit (MAU) 37

N

Network (Control Panel document) 72
Network panel (Control Panel) 47, 50
Networks 11
 Token-Ring 11, 37

O, P

Panels

 802.5 Parameters 60
 Avatar 58
 Control 57
 Language 65
 Lock 59, 66
 LU 64
 Macintosh Control Panel
 Closing 66
 Token-Ring Parameters 61

Parameters

 Token-Ring 61

Passwords 75

Physical Units 60

Print Settings documents (MMF 3287 74

PU Block (In Token-Ring Parameters panel) 62

PUs (See also Physical Units)

Q, R

Read Me - Workstation 54

Restarting

 Macintosh 67

S

Security 75

Session Settings document (icon) 73

Slot, expansion (In Token-Ring Parameters panel) 61

Software 10

 Installation 51

- Standoffs (hardware)
 - For SE board 17
- Start-up
 - Bad 67
 - Icons at 67
- System Folder 55
 - For AvaTR 42

T

- TBS connector (Macintosh SE/30 motherboard) 28
- Terminal ID (XID) (In Token-Ring Parameters panel) 63
- Terminology 1
- Token-Ring
 - Cables
 - Attaching to Macintosh II 36
 - Attaching to Macintosh SE and SE/30 35
 - Connectivity 39
 - D-connector 21, 22, 27, 30, 33, 35
 - Drivers 59
 - Hardware 39
 - Multiple boards 49
 - Multistation Access Unit (MAU) 37
 - Networks 11
 - Parameters 60
 - Parameters button 60
 - Parameters panel 61

U, V, W

- What you need first 7
- Workstations
 - Connecting to IBM host 37

X, Y, Z

- XID (In Token-Ring Parameters panel) 63

65-2800-101-AA

AVATAR CORPORATION
65 South Street, Hopkinton, MA 01748