



REV. LTR.	CONT. DOC. & NO.	DPT-MAN	CHKR.	APP'D BY	'S DATE	PAGE	LINE OR P	REVISION DESCRIPTION
A	ECN 4266	FH	KT 9/1/62	FLF				Initial Release
B	ECN 4415	RG	RG 6/14	FLF	7/2/62	46		Reversed position of cables #211 and #212.
C	ECN 4882	TG	FM 10/16/62	FLF	10-9/62			Added page 49A
D	ECN 5242	RG	KT 1/13/64	FLF	1/13/64			Changed cable clamp on page 49A from 11889185 to 11091261.
E	ECN 5411	RBH	KT 1/3/64	FLF	2/4			Added paragraph 5.0 to section III (pages 50 & 52).
F	ECN 5698	RG JSG	RG 4-13-64	FLF	4/13			Changed Cable Clip on page 49A from S-70376-1 to S-70376-3 Change the timing on the Multi "N" from 5.6 msec to 4.4 msec. See page 54.
G	ECN 6547	TJ	EG 2/16/65	FLF				Revised pages 1 and 1a from F to G. Revised pages 3, 4, 8, 9, 10, 11, and 36 from A to B. Revised page 54 from B to C. The above pages are revised to incorporate Multi timing changes and misc clerical changes.
H	ECN 6796	TJJ	P.W. 2-19-65	FLF	2/23	50	P5.0 TP 4.2	Added paragraph 4.2 to Section III (page 52a) Added page 52a Moved to page 52a from page 52 Added

D&D Spec. Inst.

RIN 5126
TL 7040m
P17.62

Burroughs Corporation  ELECTRODATA M & E DIVISION PASADENA CALIFORNIA	PREPARED BY Hausmann <i>4/30-63</i>	APPROVED F. L. Fox	DWG NO A 11891660	
	CHECKED BY <i>KT 5-9-63</i>	PROJ ENGR <i>L. Johnson 5-9-63</i>	PASS 1-b CONT <i>1-b</i>	TITLE B5000 SYSTEM SPECIAL INSTRUCTIONS TYPED DRAWING FORM
PROPERTY OF BURROUGHS CORPORATION NOT TO BE REPRODUCED NOR USED FOR MANUFACTURING PURPOSES EXCEPT ON BURROUGHS ORDER OR PRIOR WRITTEN CONSENT				

B5000 SYSTEM SPECIAL INSTRUCTIONS:

Generally, the information contained within these instructions is, by its nature, not included in any other form in released Engineering documents such as fabrication drawings, parts lists, instructions, specifications, etc.

Information in the following sections of Special Instructions is to aid and assist in the manufacture, test, and field maintenance of the various units and sub-systems of the B5000 System.

- SECTION I: B5000 SYSTEM HARDWARE
- SECTION II: CABLE INSTRUCTIONS
- SECTION III: SPECIAL WIRING AND COMPONENT LOCATION
- SECTION IV: ADJUSTMENTS & LUBRICATION



Burroughs Corporation  ELECTRODATA M & E DIVISION PASADENA CALIFORNIA	PREPARED BY Hausmann 4-3-63	APPROVED F. L. Fox	DWG NO A 11891660	 REV
	CHECKED BY	PROJ ENGR L. Johnson	Section I PAGE 1-C CONT ON 2	
PROPERTY OF BURROUGHS CORPORATION NOT TO BE REPRODUCED NOR USED FOR MANUFACTURING PURPOSES EXCEPT ON BURROUGHS ORDER OR PRIOR WRITTEN CONSENT		TITLE B5000 SYSTEM SPECIAL INSTRUCTIONS TYPED DRAWING FORM		

TABLE OF CONTENTS

SECTION I: B5000 SYSTEM HARDWARE

1.0 GENERAL

2.0 STANDARD B5000 UNIT LAYOUT

2.1 Physical Layout Figure #1

2.1.1 System Mix

2.1.2 Main Frame

2.1.3 Remote Units

3.0 RACK AND PANEL DESIGNATION

3.1 Wiring Designations

3.2 Rack Designations

3.3 Gates Figure #2

3.3.1 Backplane Wiring Frames Figure #3 & #4

3.3.2 Processor Unit Gates Figure #5

3.3.3 I/O Sub-system Gates Figure #5

3.3.4 D & D Unit Gates Figure #5

3.3.5 Central Control Unit Gates Figure #5



3.3.6 Memory Sub-system Gates Figure #6

3.3.7 Operator's Console Gate Figure #7

3.3.8 Drum Memory Sub-system Gates



3.3.9 Power Supply Gates

3.3.10 Peripheral Unit Gates

Burroughs Corporation  ELECTRODATA M & E DIVISION PASADENA CALIFORNIA	PREPARED BY Hausmann 4-3-63	APPROVED F. L. Fox	DWG NO A 11891660	
	CHECKED BY L. Johnson	PROJ ENGR L. Johnson	Section I PAGE 2 CONT ON 3	
PROPERTY OF BURROUGHS CORPORATION NOT TO BE REPRODUCED NOR USED FOR MANUFACTURING PURPOSES EXCEPT ON BURROUGHS ORDER OR PRIOR WRITTEN CONSENT		TITLE B5000 SYSTEM SPECIAL INSTRUCTIONS		

SECTION I: TABLE OF CONTENTS (cont'd)

- 3.4 Cable Racks Figure #8
 - 3.4.1 Cable Rack Trays
 - 3.4.2 Wire Connections to Cable Racks Figure #9 & #10
- 3.5 Voltage Regulator Figure #11
- 3.6 Cabinet Top Covers
 - 3.6.1 Panel Designation and Component Location Figure #12 & #12A
- 3.7 Groups of Frames and Panels
 - 3.7.1 D & D Unit Figure #13 & #14
 - 3.7.2 Power Supply Unit Figure #15A-B-C-D-E
 - 3.7.3 Operator's Console Unit Figure #16
 - 3.7.4 Processor Unit Figure #5
 - 3.7.5 Non-EDD Units

Burroughs Corporation  ELECTRODATA M & E DIVISION PASADENA CALIFORNIA	PREPARED BY T. J. Jones	APPROVED F. L. Fox	DWG NO. A 11891660	 B REV
	CHECKED BY	PROJ ENGR	Section I PAGE 3 cont on 4	
PROPERTY OF BURROUGHS CORPORATION NOT TO BE REPRODUCED NOR USED FOR MANUFACTURING PURPOSES EXCEPT ON BURROUGHS ORDER OR PRIOR WRITTEN CONSENT		TITLE B5000 Special Instructions TYPED DRAWING FORM		

SECTION I: B5000 SYSTEM HARDWARE

1.0 GENERAL: The information in this section indicates the designation and location of the various Units and the rack/panel designations within those Units.

2.0 STANDARD B5000 UNIT LAYOUT:

2.1 See Figure #1 for the physical layout of Units.

2.1.1 SYSTEM MIX

The B5000 System Index, #78526, in conjunction with the EDD Master Shipping Schedule, determines the "mix" of Units or Sub-systems within a given B5000 System.

2.1.2 The Processor Unit/s, I/O Sub-system, D & D Unit, Central Control Unit, and Memory Sub-system/s must be installed as a contiguous group (Main Frame) in the order shown in Figure #1. Hardware is supplied in the various Parts Lists for the physical joining of these cabinets. Main Frame is leveled by means of leveling screws (feet) on each individual cabinet.

2.1.3 REMOTE UNITS

The Power Supply, Drum Storage Sub-system, Operator's Console and DF/DC Basic Control are remote from the Main Frame group and at a distance within the limits of the cable assembly lengths specified for those Units in the B5000 System Cable Index, #11869823.

Peripheral equipment, such as printers and punches, are remote within the limits of the cable assembly lengths called out within the parts lists of those peripheral equipments.

Burroughs Corporation  ELECTRODATA M & E DIVISION PASADENA CALIFORNIA PROPERTY OF BURROUGHS CORPORATION NOT TO BE REPRODUCED NOR USED FOR MANUFACTURING PURPOSES EXCEPT ON BURROUGHS ORDER OR PRIOR WRITTEN CONSENT	PREPARED BY Hausmann	APPROVED F.L. FOX	DWG NO A 11891660	B REV
	CHECKED BY	PROJ ENGR L. JOHNSON	PAGE 4	Section 1 CONT ON 5
TITLE B5000 SYSTEM SPECIAL INSTRUCTIONS TYPED DRAWING FORM				

B5000 UNIT LAYOUT:

Reference 2.1 of this instruction.

- a. MAIN FRAME consists of Proc "A", I/O Sub-system, D&D Unit, Central Control Unit, Core Memory Sub-system #1, Core Memory Sub-system #2, and Proc "B". Cabinets are to be installed in the order as shown below. Core Mem S/S #2 and Proc "B" may or may not be installed in a particular B5000 System.
- b. Peripheral and remote units may be located at the discretion of Field Engrg and the customer.

POWER
SUPPLY
UNIT

PROC "A" UNIT	I/O CONTROL SUB-SYSTEM	DISPLAY & DISTRIBUTION UNIT	CENTRAL CONTROL UNIT	CORE MEM S/S #1	CORE MEM S/S #2	PROC "B" UNIT
	I/O-1 Unit I/O-2 Unit I/O-3 Unit I/O-4 Unit			M-0 Unit M-1 Unit M-2 Unit M-3 Unit	M-4 Unit M-5 Unit M-6 Unit M-7 Unit	

MAIN FRAME--Front View

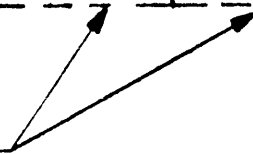
AS REQUIRED 

OPERATOR'S
CONSOLE UNIT



BASIC
CONTROL
SUB-SYS

DC CONT
UNIT

DRUM MEM
S/S

DRUM #1
UNIT

DRUM #2
UNIT

FIGURE #1

Burroughs Corporation  ELECTRODATA M & E DIVISION PASADENA CALIFORNIA	PREPARED BY Hausmann	APPROVED F. L. Fox	DWG NO A 11891660	A REV
	CHECKED BY	PROJ ENGR L. Johnson	PAGE 5	Section I CONT ON 6
PROPERTY OF BURROUGHS CORPORATION NOT TO BE REPRODUCED NOR USED FOR MANUFACTURING PURPOSES EXCEPT ON BURROUGHS ORDER OR PRIOR WRITTEN CONSENT		TITLE B5000 Special Instructions TYPED DRAWING FORM		

SECTION I: 2.1.3 Cont'd.

All remote equipment inter-connects with the D & D Unit only.

Power and incoming signals are distributed from the D & D Unit to the other cabinets of the Main Frame group.

3.0 BACK AND PANEL DESIGNATION:

3.1 To facilitate the use of Design Automation in the preparation of the B5000 Test & Field Documents, all wiring connections are designated by Rack-Panel-Row-Column-row-column.

3.2 The following are designated as racks within the B5000 Units and Sub-systems:

- | | | |
|----------------|-----------------------|---|
| a. Gates | c. Voltage Regulators | e. Groups of Component Panels |
| b. Cable Racks | d. Cabinet Top Covers | f. Groups of Stationary Backplane wiring frames |

3.3 GATES: A gate is employed as a hinged frame upon which may be mounted panels or backplane wiring frames. See Figure #2.

3.3.1 BACKPLANE WIRING FRAMES:

Each wiring frame is divided into two panels each. There are a possible six panels on each gate and these panels are designated "A" thru "F". See Figure #3 for location of panels so designated. Each panel is divided into ROW and COLUMN designations. Each panel has four ROWS of 200 pin connectors designated "A", "B", "C", and "D" from top to bottom respectively.

3

Reference 3.3

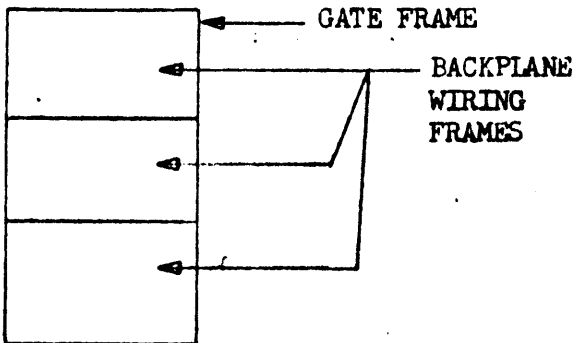

FIG #2

Reference 3.3.1

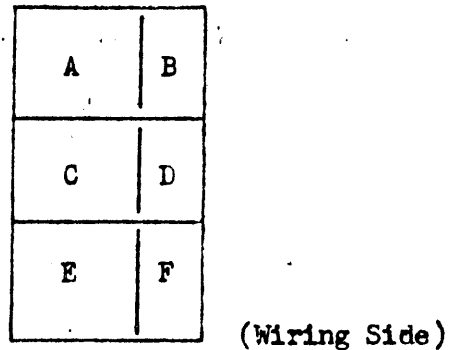

FIG #3

Reference 3.3.1

Wiring side of the A/B panel frame on GATE A of typical Unit.

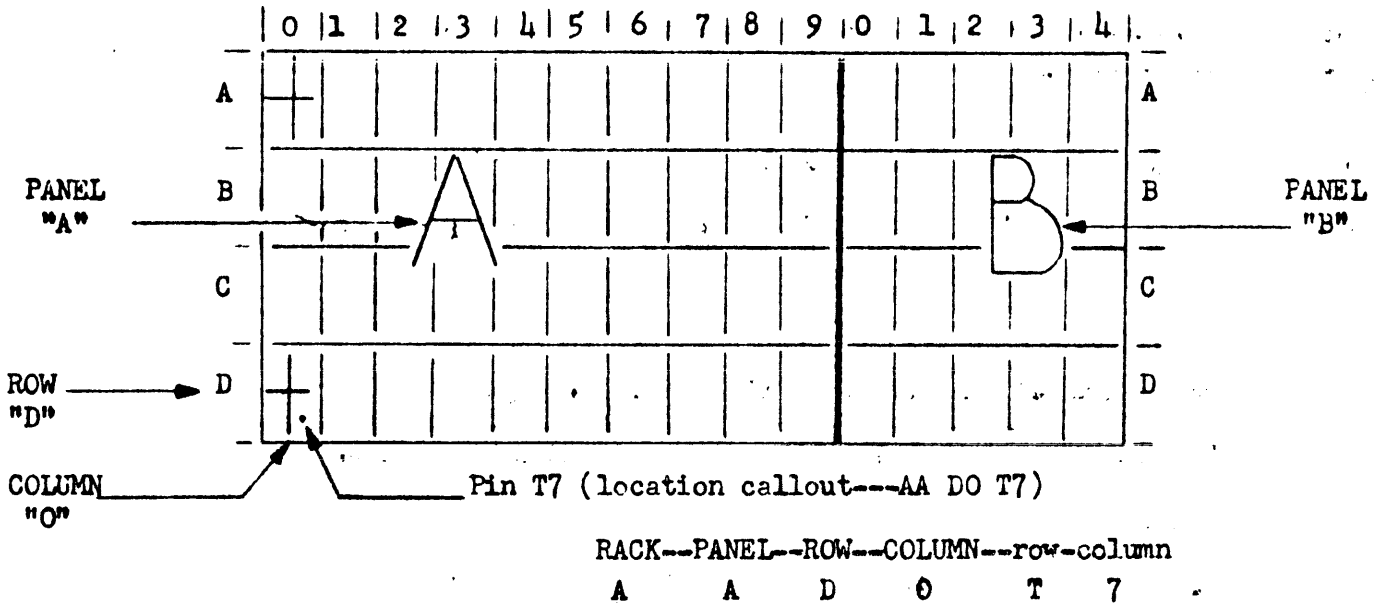



FIGURE #4

Burroughs Corporation  ELECTRODATA M & E DIVISION PASADENA CALIFORNIA PROPERTY OF BURROUGHS CORPORATION NOT TO BE REPRODUCED NOR USED FOR MANUFACTURING PURPOSES EXCEPT ON BURROUGHS ORDER OR PRIOR WRITTEN CONSENT	PREPARED BY Hausmann	APPROVED F. L. Fox	DWG NO A 11891660	A REV
	CHECKED BY	PROJ ENGR L. Johnson	Section I PAGE 7 CONT ON 8	
		TITLE B5000 Special Instructions TYPED DRAWING FORM		

SECTION I: 3.3.1 Cont'd.

Panels "A", "C" and "E" have ten columns of 200 pin connectors and these ten columns are designated (left to right on wiring side) "0" thru "9".

Panels "B", "D", and "F" have five columns of connectors and these connectors are designated "0" thru "4". See Figure #4.

Individual pins of the 200 pin connector blocks are numbered and marked on the connector block.

3.3.2 PROCESSOR UNIT GATES:

The Processor Unit has four hinged gates designated (front to rear) "A" "B", "D", and "E".

Processor "A" is identical in manufacture to Processor "B".

See Figure #5 for orientation of gates. A & B Gates hinge from the right side, therefore, on these gates LEFT Quad cables are used and break out of B-D-E Panels "4" Row. See Section II, Fig. #1.

3.3.3 Input/Output Sub-system Gates:

An I/O Control UNIT occupies one gate of the I/O Sub-system. A Sub-system may have one, two, three, or four I/O Units according to the "mix" of a given system.

Regardless of gate location of an I/O Unit, all I/O Units within a sub-system are identical in manufacture and employ the same DA documents.

All gates are designated as "A" Rack to allow use of the same set of DA documents for I/O-1, I/O-2, I/O-3, or I/O-4.

For location purposes, the gates are referred to as #1, #2, #3, or #4. See Figure #5.

FIGURE # 5

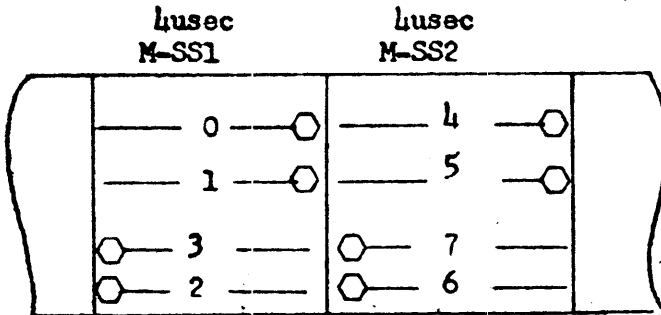

MAIN FRAME GATE ORIENTATION
 Reference 3.3.2, 3.3.3, 3.3.4,
 3.3.5, & 3.3.6

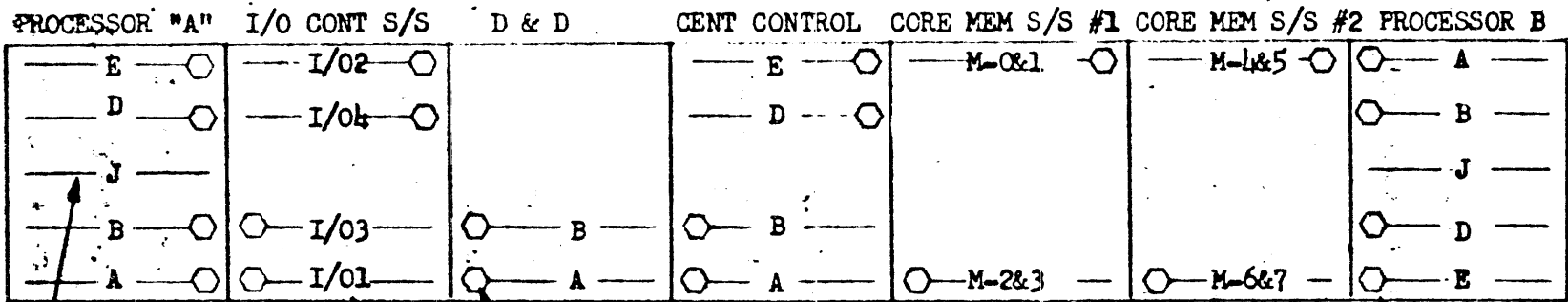

Front of Main Frame
TOP VIEW

EACH I/O GATE IS DESIGNATED "A"

HINGE (typ)

IN BOTH PROCESSORS, "A" & "B", THE HINGES ARE TOWARD CENTER OF THE MAIN FRAME.

PROC. A - FRONT GATE IS "A"
 PROC. B - FRONT GATE IS "E"

PROC RACK "J" IS NOT A GATE. PERMENANTLY AFFIXED RACK OF TWO BACKPLANE WIRING FRAMES.

Burroughs Corporation ELECTRODATA M & E DIVISION PASADENA CALIFORNIA		PREPARED BY Hausmann	APPROVED F.L. Fox
PROPERTY OF BURROUGHS CORPORATION NOT TO BE REPRODUCED NOR USED FOR MANUFACTURING PURPOSES EXCEPT ON BURROUGHS ORDER OR PRIOR WRITTEN CONSENT		CHECKED BY I. Johnsen	DWG NO A 11891660
TITLE B5000 SYSTEM SPECIAL INSTRUCTIONS.		PAGE 8	Section I CONT ON 9
			REV B

Burroughs Corporation  ELECTRODATA M & E DIVISION PASADENA CALIFORNIA	PREPARED BY T. J.	APPROVED F. L. Fox	DWG NO A 11891660	B REV
	CHECKED BY	PROJ ENGR L. Johnson	Section I PAGE 9 cont on 10	
PROPERTY OF BURROUGHS CORPORATION NOT TO BE REPRODUCED NOR USED FOR MANUFACTURING PURPOSES EXCEPT ON BURROUGHS ORDER OR PRIOR WRITTEN CONSENT		TITLE B5000 Special Instructions TYPED DRAWING FORM		

SECTION I: Cont'd.

3.3.4 Display & Distribution Unit Gates:

Two gates, designated "A" and "B", are required within a D & D Unit for a maximum system.

Gate "A" includes backplane wiring panels E/F, CC Display panel, Processor "A" Display panel, I/O-1 Display panel, and I/O-2 Display panel.

Gate "B" includes Processor "B" Display panel and the display panels for I/O-3 and I/O-4. Gate "B" will be installed only if one or more of its included panels are necessary. See Figure #5.

3.3.5 Central Control Unit Gates:

Four gates are required for a min/max system Central Control Unit. These four gates are designated as "A", "B", "D", and "E". See Figure #5.

3.3.6 Memory Sub-system Gates:

There is a maximum of TWO Memory Sub-systems within a B5000 System. These are designated as Memory Sub-system #1 (M-SS1) and Memory Sub-system #2 (M-SS2).

There are two types of Core Memory Units which may be installed in a Memory Sub-system. The two types are Core Memory Unit #78495 and Lusec Core Memory Unit #11154119.

Each Sub-system may contain 1, 2, 3 or 4 of either type Units.

Both types may exist in one Sub-system providing that Units #0 & #1 (4 & 5 are of the same type AND Units #2 & #3 (#6 & #7) are of the same type.

Burroughs Corporation  ELECTRODATA M & E DIVISION PASADENA CALIFORNIA PROPERTY OF BURROUGHS CORPORATION NOT TO BE REPRODUCED NOR USED FOR MANUFACTURING PURPOSES EXCEPT ON BURROUGHS ORDER OR PRIOR WRITTEN CONSENT	PREPARED BY T. J.	APPROVED F. L. Fox	DWG NO A 11891660	B REV
	CHECKED BY	PROJ ENGR L. Johnson	PAGE 10 cont on 11	TITLE B5000 Special Instructions TYPED DRAWING FORM

SECTION I: 3.3.6 Cont'd.

Regardless of TYPE or gate/position location, each Unit is designated as "A" Rack for wiring designations.

M-SS1: The Sub-system designated #1 contains Memory Units designated #0, #1, #2, & #3.

M-SS2: The Sub-system designated #2 contains Memory Units designated #4, #5, #6, & #7.

See Figure #5 for location of lusec Core Memory Units within a Sub-system.

See Figure #6 for location of Core Memory Units 78495, within a Sub-system.

3.3.7 Operator's Console Gate:

The Operator's Console has one electronic components gate. This gate is designated the "A" Panel of the "A" Rack. It consists of four ROWs of connector blocks with six COLUMNs of connectors in each row. See Figure #7.

3.3.8 Drum Memory Sub-system Gates:

The Drum Memory Sub-system for a maximum system contains two gates, an outer front gate for Drum Unit #1 and an outer rear gate for Drum Unit #2.

These gates bear NO rack designation. They serve to mount various component and wiring racks which will be covered in a later portion of this instruction.

CORE MEMORY UNIT LAYOUT: Memory Unit #78495 ONLY.

Reference 3.3.6

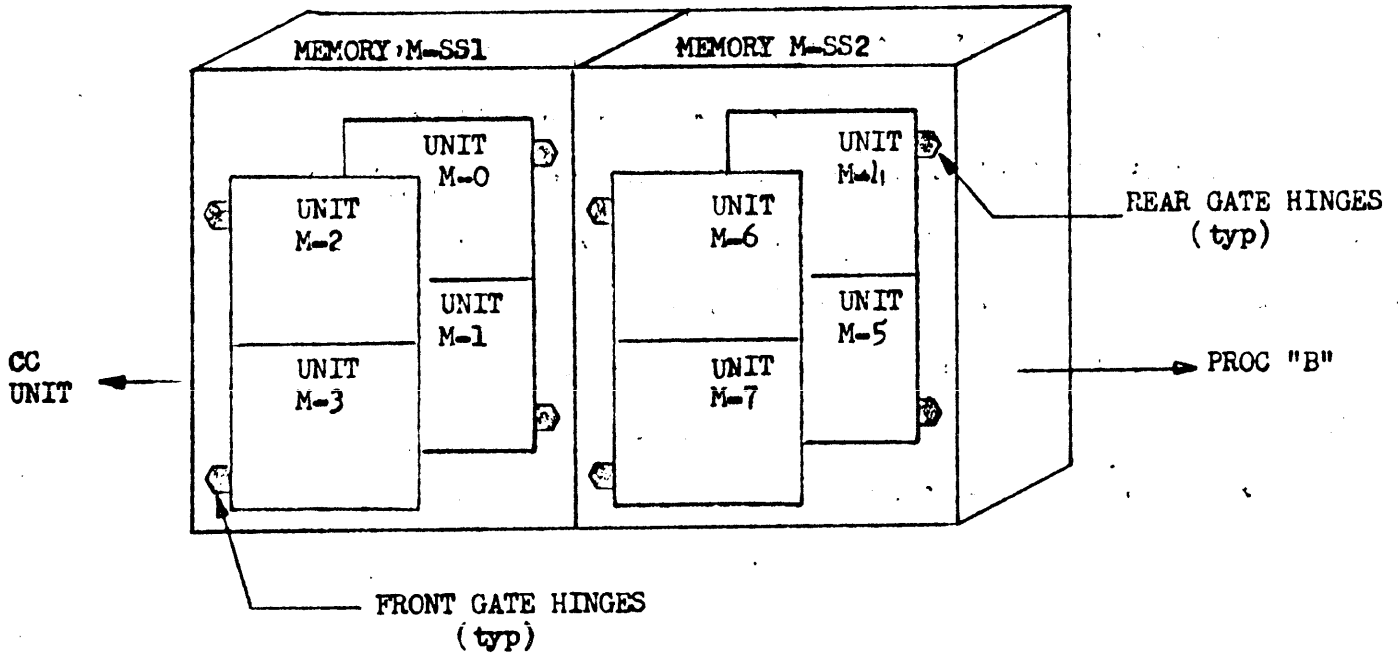
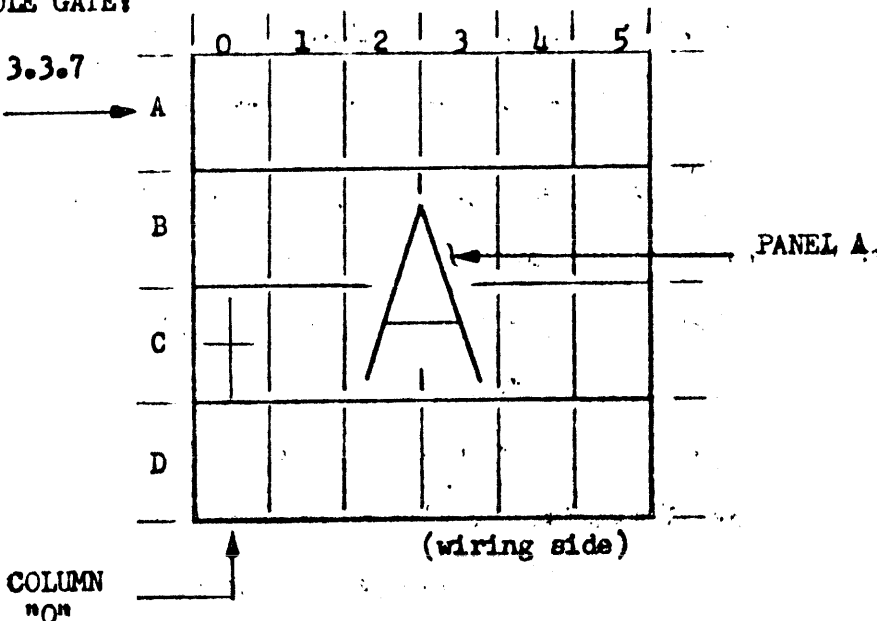

FIGURE # 6

OPRS CONSOLE GATE:

Reference 3.3.7

ROW
"A"



COLUMN
"0"

FIGURE # 7

Burroughs Corporation  ELECTRODATA M & E DIVISION PASADENA CALIFORNIA	PREPARED BY Hausmann	APPROVED F. L. Fox	DWG NO A 11891660	A REV
	CHECKED BY L. Johnson	PROJ ENGR L. Johnson	Section I PAGE 12 CONT ON 13	
PROPERTY OF BURROUGHS CORPORATION NOT TO BE REPRODUCED NOR USED FOR MANUFACTURING PURPOSES EXCEPT ON BURROUGHS ORDER OR PRIOR WRITTEN CONSENT		TITLE B5000 Special Instructions TYPED DRAWING FORM		

SECTION I:

3.3.9 Power Supply Gates:

There are NO designated gates within the Power Supply Unit.

3.3.10 Peripheral Unit Gates:

Explained where necessary in the individual Peripheral Unit documents.

3.4 Cable Racks:

Cables are routed between the Main Frame Units and between the racks of individual units by means of cable trays mounted at various heights on cable rack assemblies within each cabinet.

Processor Unit, Power Supply Unit, and Operator's Console Unit do NOT have cable racks installed. All other B5000 units and sub-systems make use of cable racks as described in above paragraph.

For wiring connections on these racks, the cable racks are designated as RACK "H".



3.4.1 Cable Rack TRAYS:

A maximum of twelve trays may be mounted on a cable rack. These trays are numbered #1 thru #12, with #1 as the top tray.

The number of trays used varies with the type Unit or Sub-system. See Figure #8 for location of trays by cabinet.

3.4.2 Wiring Connections on the Cable Rack:

Types of wire termination connectors or components mounted on the cable rack (Rack "H") are as follows:

Burroughs Corporation  ELECTRODATA M & E DIVISION PASADENA CALIFORNIA	PREPARED BY Hausmann	APPROVED F.L. Fox	DWG NO A 11891660	
	CHECKED BY	PROJ ENGR L. Johnson	Section I PAGE 13 CONT ON 14	
PROPERTY OF BURROUGHS CORPORATION NOT TO BE REPRODUCED NOR USED FOR MANUFACTURING PURPOSES EXCEPT ON BURROUGHS ORDER OR PRIOR WRITTEN CONSENT		TITLE B5000 SYSTEM SPECIAL INSTRUCTIONS TYPED DRAWING FORM		

CABLE RACK LAYOUT: Trays, Convenience Outlets, Term-Relay Panels

Reference 3.4.1

- a. CABLE RACK is designated RACK "H" for wiring callouts
- b. Tray #1 is added and Trays #4, #5, & #6 must be replaced by special trays #D-11159688 when μ sec Core Memories are installed in a Memory Sub-system.

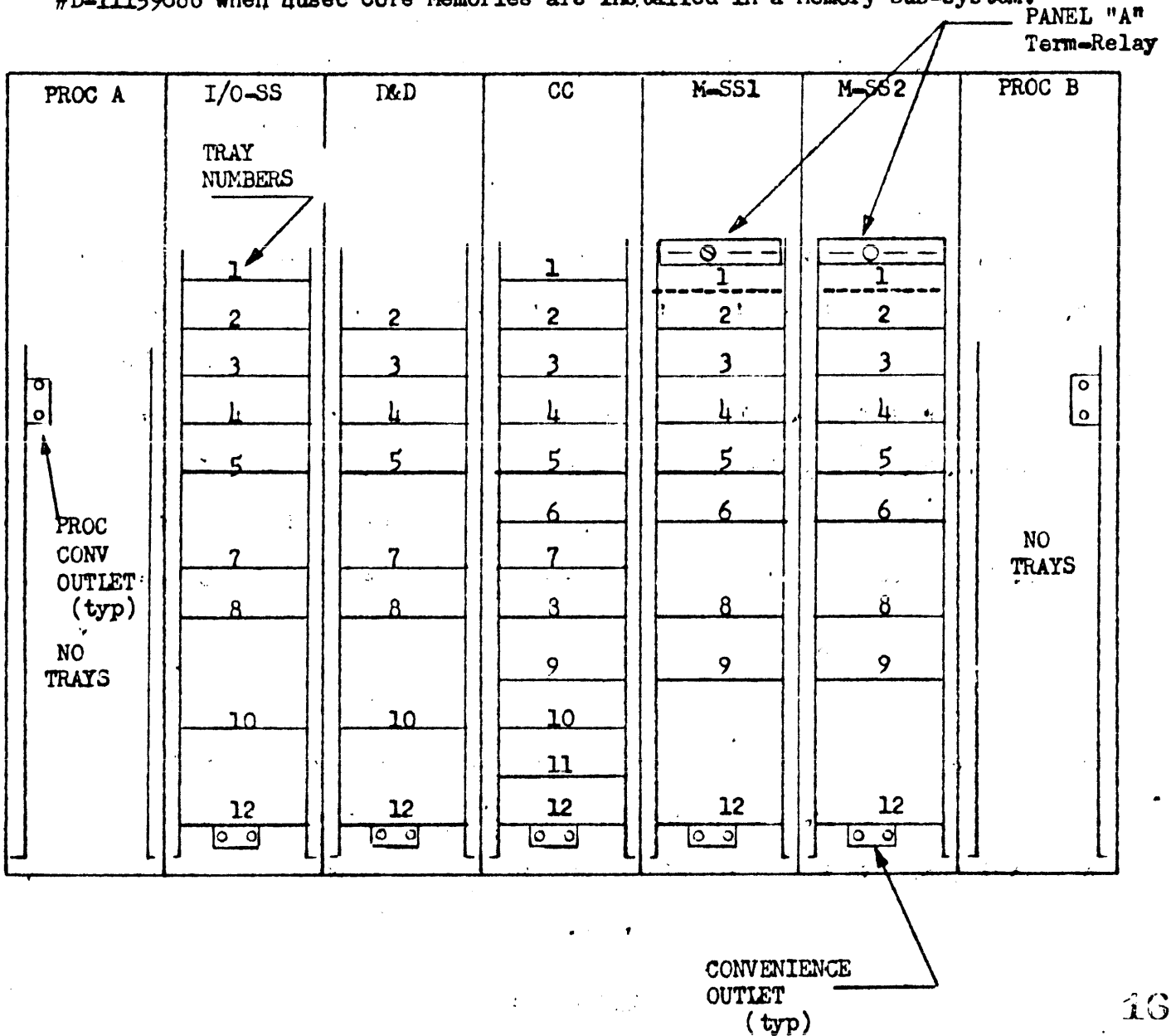



FIGURE # 8

Burroughs Corporation  ELECTRODATA M & E DIVISION PASADENA CALIFORNIA	PREPARED BY Hausmann	APPROVED F. L. Fox	DWG NO A 11891660	A REV
	CHECKED BY	PROJ ENGR L. Johnson	PAGE 14	Section I CONT ON 15
PROPERTY OF BURROUGHS CORPORATION NOT TO BE REPRODUCED NOR USED FOR MANUFACTURING PURPOSES EXCEPT ON BURROUGHS ORDER OR PRIOR WRITTEN CONSENT		TITLE B5000 Special Instructions TYPED DRAWING FORM		

SECTION I: 3.4.2 Cont'd.

- a. Convenience Outlets for 115V AC on the bottom of Tray #12 in each cabinet, with the exception of Processor. See Fig. #9.
- b. Terminal Strips mounted above the Tray #1 location in both the Memory Sub-system cabinets. See Figure #10.
- c. Relay mounted between Terminal Strips in "b" above. See Figure #10.

3.5 Voltage Regulator:

The Voltage Regulator is a Common Assembly (CA) used in all units of the Main Frame with the exception of the Display & Distribution Unit.

It is designated as RACK "C" in all using units and sub-systems and is located in the top center of all using cabinets.

All PANEL designation information is silkscreened on the physical assembly of the Voltage Regulator. ROW-COL-pin no. information is silkscreened or otherwise marked with the exception of the heat-sink panels "B" thru "P". See Figure #11. for heat-sink pin designations.

3.6 Cabinet Top Covers:

The top cover of the cabinet of each unit or sub-system is designated as Rack "F" for wiring purposes.

With the exception of the Drum Storage Sub-system top cover, all top covers are identical in manufacture. The Drum Sub-system has an additional fan in its cover making that assembly different than the standard "CA" assembly.

Burroughs Corporation  ELECTRODATA M & E DIVISION PASADENA CALIFORNIA	PREPARED BY Hausmann	APPROVED F.L. Fox	DWG NO A 11891660
	CHECKED BY	PROJ ENGR L. Johnson	Section I PAGE 15 CONT ON 16
PROPERTY OF BURROUGHS CORPORATION NOT TO BE REPRODUCED NOR USED FOR MANUFACTURING PURPOSES EXCEPT ON BURROUGHS ORDER OR PRIOR WRITTEN CONSENT		TITLE B5000 SYSTEM SPECIAL INSTRUCTIONS TYPED DRAWING FORM	

CONVENIENCE OUTLETS:

Reference 3.4.2

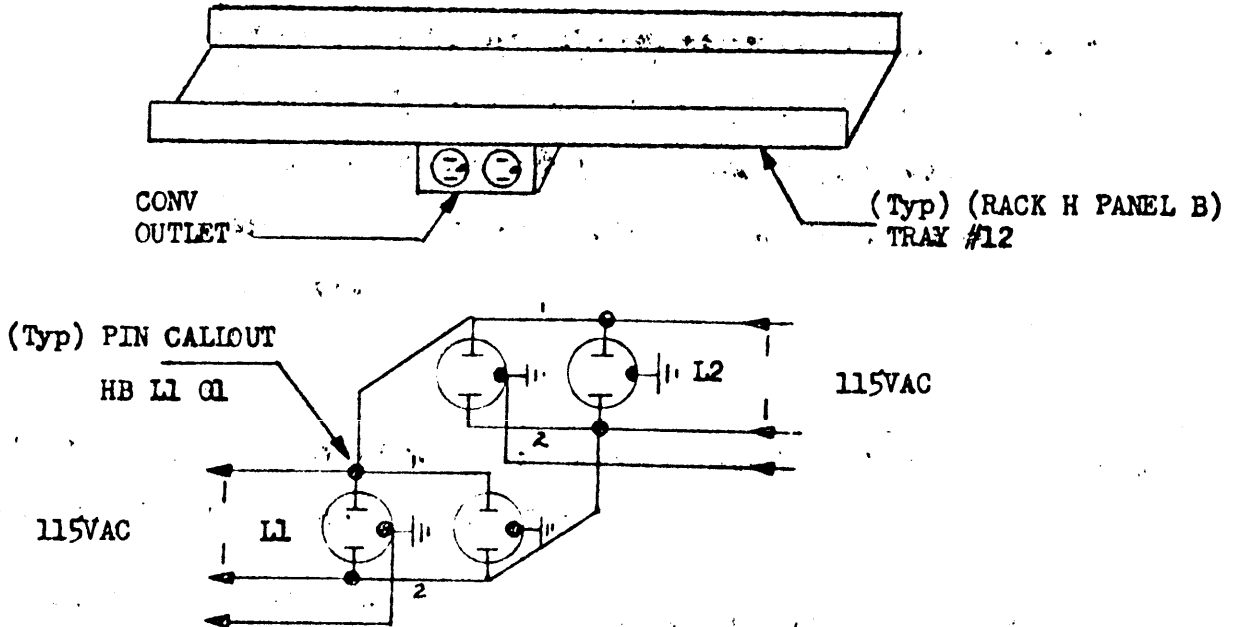

- a. Typical Tray #12 of all Main Frame Cabinets have mounted under them a double dual outlet box. The front dual outlet is designated L1 (HB L1) and the rear outlet is designated L2 (HB L2) for wiring purposes.
- b. Neither Processor having trays, a single dual outlet box is mounted where holes are provided on the frame of the "J" Rack. This frame is considered to be "H" Rack--B Panel. The outlet box is designated L1 (HB L1).

FIGURE #9

MEMORY SS TERM/RELAY PANEL:

Reference 3.4.2

RACK "H"

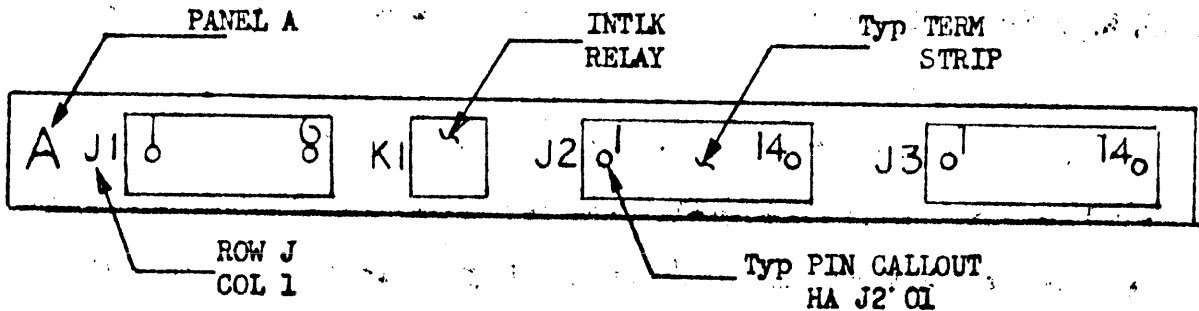



FIGURE #10

Burroughs Corporation  ELECTRODATA M & E DIVISION PASADENA CALIFORNIA	PREPARED BY Hausmann	APPROVED F.L. Fox	DWG NO A 11891660	A REV
	CHECKED BY	PROJ ENGR L. Johnson	Section I PAGE 16 CONT ON 17	
PROPERTY OF BURROUGHS CORPORATION NOT TO BE REPRODUCED NOR USED FOR MANUFACTURING PURPOSES EXCEPT ON BURROUGHS ORDER OR PRIOR WRITTEN CONSENT		TITLE B5000 SYSTEM SPECIAL INSTRUCTION <small>TYPED DRAWING FORM</small>		

HEAT SINK PIN & COMPONENT DESIGNATIONS:

Reference 3.5

- a. Sketch below is of a typical heat-sink and represents no particular assembly.
- b. Six mtg. areas on the front of the heat-sink are designated J1 thru P1. Pins are numbered top to bottom.
- c. Mtg. areas on the side of the heat-sink are designated J2, K2, L2. and, where necessary, M2. Pins are numbered front to rear OR top to bottom. Gnd pins are designated as Pin 3.

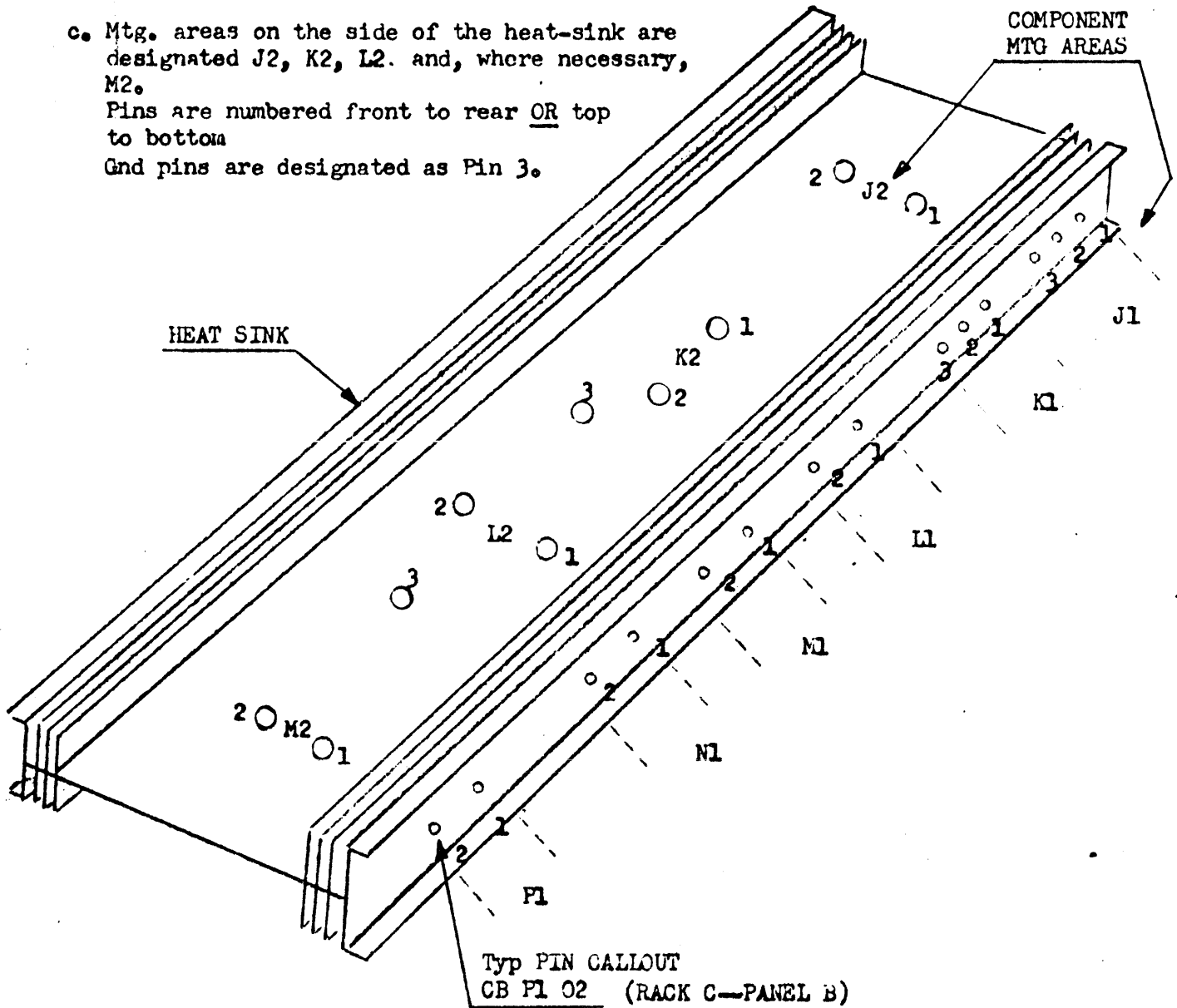



FIGURE #11

Burroughs Corporation  ELECTRODATA M & E DIVISION PASADENA CALIFORNIA	PREPARED BY Hausmann	APPROVED F. L. Fox	DWG NO A 11891660	A REV
	CHECKED BY	PROJ ENGR L. Johnson	PAGE 17	Section I CONT ON 18
PROPERTY OF BURROUGHS CORPORATION NOT TO BE REPRODUCED NOR USED FOR MANUFACTURING PURPOSES EXCEPT ON BURROUGHS ORDER OR PRIOR WRITTEN CONSENT		TITLE B5000 Special Instructions TYPED DRAWING FORM		

SECTION I: Cont'd.

3.6.1 Panel designation and component location: (see Figure #12 and #12-A)

- a. The horizontal panel of the Top Cover is designated Panel "A". The fans and terminal strip are mounted to the ("A") panel.
- b. The cabinet frame just below the "A" panel is designated as the "B" panel. If Cover Interlock Switches are installed, they are mounted to this ("B") panel. Interlock switches are installed in the D & D Unit cabinet and in the Memory and Drum Storage Sub-systems.
- c. In the Drum Storage Sub-system cabinet, the Heat Sense panel is mounted directly to the Top Cover. The designation of the Heat Sense panel is Panel "C".

3.7 Groups of frames and panels

Within the various cabinets, certain frames and/or panels are grouped together for designation purposes and are construed to be RACKs. These RACKs are described in the following paragraphs by Unit or Sub-system.

3.7.1 Display & Distribution Unit

- A. The "D" Rack consists of a group of panels located in the area normally occupied, in other cabinets, by the D gate.

The following panels are included in the "D" Rack: (see Figure #13).

- a. Power Distribution Panel
- b. "D" Connector Panel (Peripheral Unit Cable Connectors)
- c. "E" Connector Panel (TTU Cables and 115VAC Input)

Burroughs Corporation  ELECTRODATA M & E DIVISION PASADENA CALIFORNIA	PREPARED BY Hausmann	APPROVED F.L. Fox	DWG NO A 11891660	Section I PAGE 18 CONT ON 19
	CHECKED BY	PROJ ENGR L. Johnson	TITLE B5000 SYSTEM SPECIAL INSTRUCTIONS TYPED DRAWING FORM	

COMMON ASSEMBLY TOP COVER PANEL DESIGNATION & COMPONENT LOCATION:

Reference 3.6.1

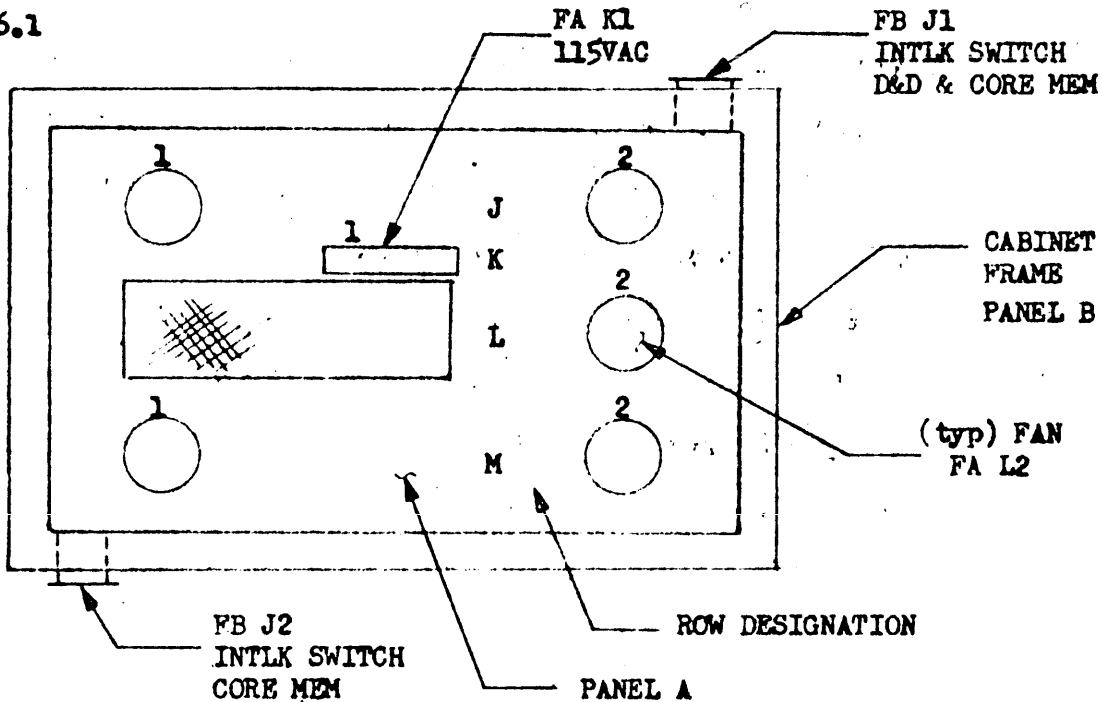

FIGURE #12

TRUM MEM SS TOP COVER PANEL DESIGNATION & COMPONENT LOCATION:

Reference 3.6.1

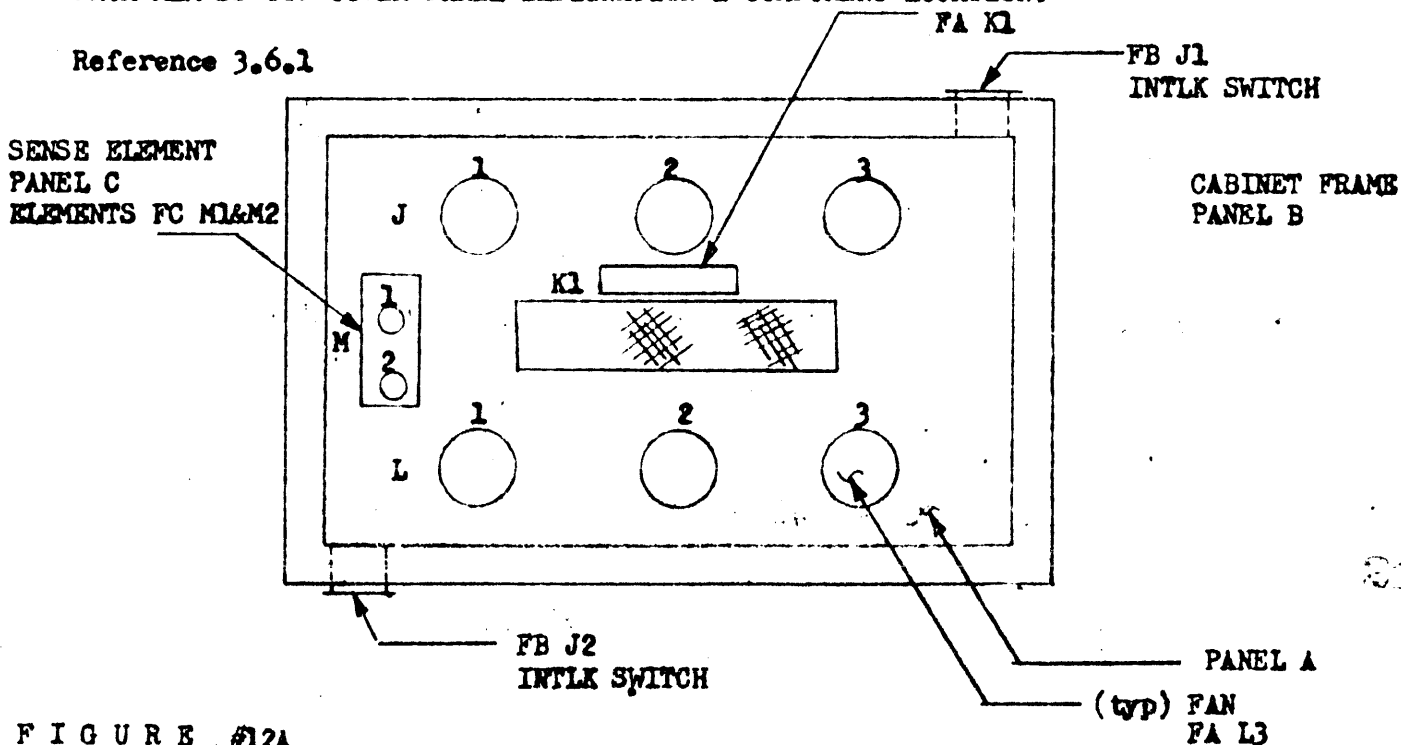

FIGURE #12A

Burroughs Corporation ELECTRODATA M & E DIVISION PASADENA CALIFORNIA	PREPARED BY FH	APPROVED F.L. Fox	DWG NO A 11891660	A REV
	CHECKED BY L. Johnson	PROJ ENGR L. Johnson	Section I PAGE 19 CONT ON 20	
PROPERTY OF BURROUGHS CORPORATION NOT TO BE REPRODUCED NOR USED FOR MANUFACTURING PURPOSES EXCEPT ON BURROUGHS ORDER OR PRIOR WRITTEN CONSENT		TITLE B5000 Special Instructions TYPED DRAWING FORM		

D&D UNIT "D" RACK:

Reference 3.7.1

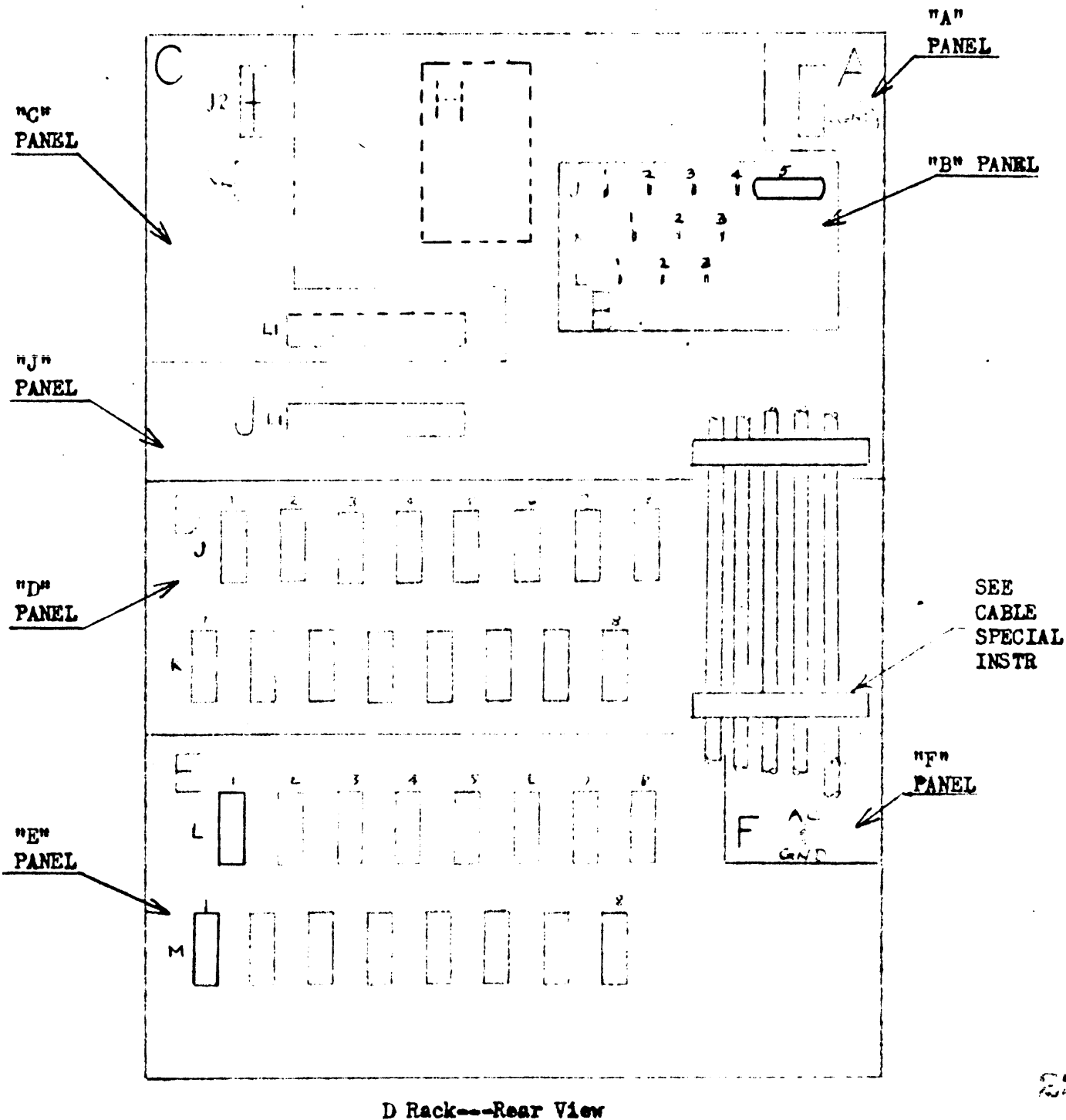



FIGURE #13

Burroughs Corporation  ELECTRODATA M & E DIVISION PASADENA CALIFORNIA	PREPARED BY Hausmann	APPROVED F. L. Fox	DWG NO A 11891660	A REV
	CHECKED BY	PROJ ENGR L. Johnson	PAGE 20 CONT ON 21	
PROPERTY OF BURROUGHS CORPORATION NOT TO BE REPRODUCED NOR USED FOR MANUFACTURING PURPOSES EXCEPT ON BURROUGHS ORDER OR PRIOR WRITTEN CONSENT		TITLE B5000 Special Instructions <small>TYPED DRAWING FORM</small>		

3.7.1 Cont'd

- B. The "A" & "B" gates are the front outer and inner gates, respectively, of the D & D Unit.

The "A" & "B" designation is for physical location only and is not to be construed as RACK designation for wiring purposes. For wiring purposes, each panel on both gates is considered to be Rack A.

- C. D & D Display Panels: (Fig. #14)

The four I/O Display Panels are identical in manufacture and utilize the same Circuit Lists and Schematics. One I/O Display Panel is carried as an item on the I/O Control Unit P/L but is to be physically installed in the D & D Unit. Their use with I/O-1-2-3 or 4 determines their physical location.

The two Processor Display Panels are identical in manufacture and utilize the same Circuit Lists and Schematics. One Proc. Display Panel is carried as an item on the Processor P/L but is physically installed in the D & D Unit. Their use with Processor "A" OR "B" determines their physical location.

As the Central Control Unit is not modular and only one is necessary within a B5000 System, the CC Display Panel is carried as an item on the D & D Unit P/L and its wiring is included in the D & D Unit Circuit List and Schematics.

Burroughs Corporation  ELECTRODATA M & E DIVISION PASADENA CALIFORNIA	PREPARED BY FH 3-20-63	APPROVED F.L.Fox	DWG NO A 11891660	A REV
	CHECKED BY	PROJ ENGR L. Johnson	PAGE 21	Section I CONT ON 22
PROPERTY OF BURROUGHS CORPORATION NOT TO BE REPRODUCED NOR USED FOR MANUFACTURING PURPOSES EXCEPT ON BURROUGHS ORDER OR PRIOR WRITTEN CONSENT		TITLE B5000 SPECIAL INSTRUCTIONS TYPED DRAWING FORM		

D&D UNIT "A" & "B" GATE PANEL LOCATION:

Reference 3.7.1 para B

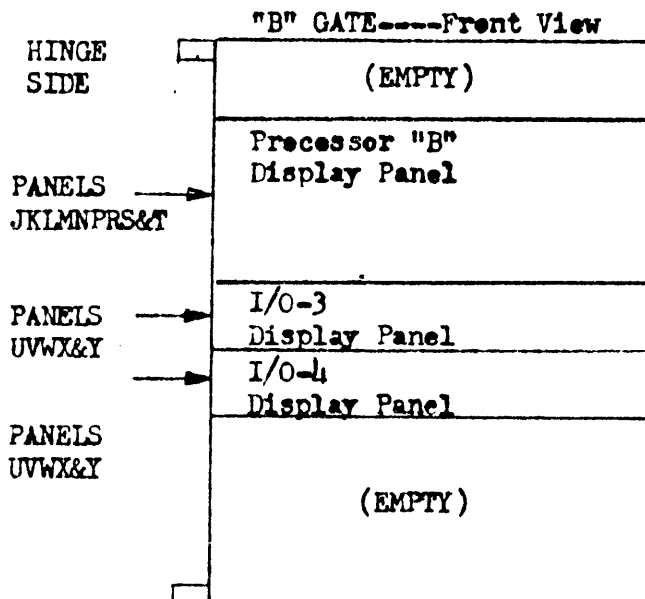
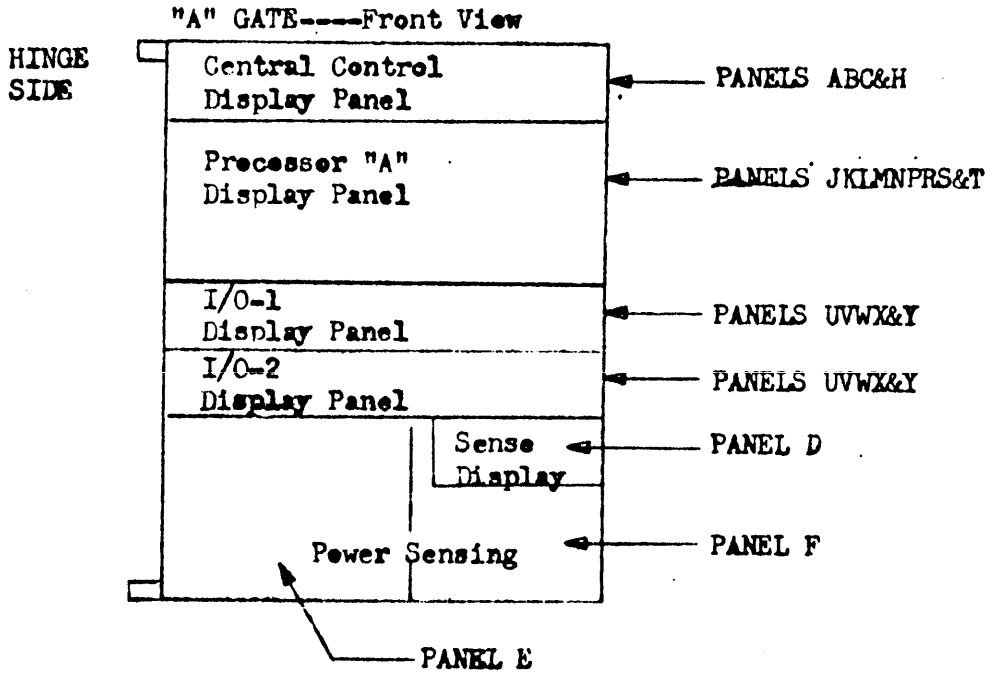



FIGURE 214

Burroughs Corporation  ELECTRODATA M & E DIVISION PASADENA CALIFORNIA	PREPARED BY Hausmann	APPROVED F. L. Fox	DWG NO A 11891660	A REV
	CHECKED BY	PROJ ENGR L. Johnson	Section I PAGE 22 CONT ON 23	
PROPERTY OF BURROUGHS CORPORATION NOT TO BE REPRODUCED NOR USED FOR MANUFACTURING PURPOSES EXCEPT ON BURROUGHS ORDER OR PRIOR WRITTEN CONSENT		TITLE B5000 Special Instructions TYPED DRAWING FORM		

3.7.2 Power Supply Unit:

The Power Supply Unit consists of five RACKs of panels for wiring purposes. The Row & Column information is silkscreened, or otherwise marked, on the panels contained in these racks. For location of the Power Supply Racks and Panels, see Fig. #15-A-B-C-D-E.

3.7.3 Operator's Console Unit:

See Figure #16 for Rack & Panel locations in the Operator's Console Unit.

3.7.4 Processor Unit:

Other than the racks previously covered in this instruction, the Processor has only one additional rack. It is the "J" Rack which consists of two backplane wiring frames located below the Processor Voltage Regulator and between the "B" & "D" Gates. (See Figure #5)

The two wiring frames are identical to the frames employed in the other gates of the Processor and their panel designations are Panels C & D on the top frame and Panels E & F on the lower frame.

The panels of the J Rack are oriented with the wirewrap sides facing the "D" & "E" Racks and the pluggables facing the "A" & "B" Racks.

3.7.5 Non-EDD Units:

Units designed and/or manufactured by Divisions of Burroughs, other than the ElectroData Division, do not necessarily follow the Rack-Panel-Row-Col-row-col concept of component and wiring designation.

No attempt will be made, in these instructions, to locate or describe the rack/panel designations of any B5000 employed units not designed at ElectroData, Pasadena.

25

Burroughs Corporation  ELECTRODATA M & E DIVISION PASADENA CALIFORNIA	PREPARED BY FH 3-20-63	APPROVED F.L. Fox	DWG NO A 11891660	A REV
	CHECKED BY	PROJ ENGR L Johnson	PAGE 23	Section I CONT ON 24
PROPERTY OF BURROUGHS CORPORATION NOT TO BE REPRODUCED NOR USED FOR MANUFACTURING PURPOSES EXCEPT ON BURROUGHS ORDER OR PRIOR WRITTEN CONSENT		TITLE B5000 Special Instructions		
TYPED DRAWING FORM				

POWER SUPPLY UNIT RACK & PANEL LOCATION:
 Reference 3.7.2

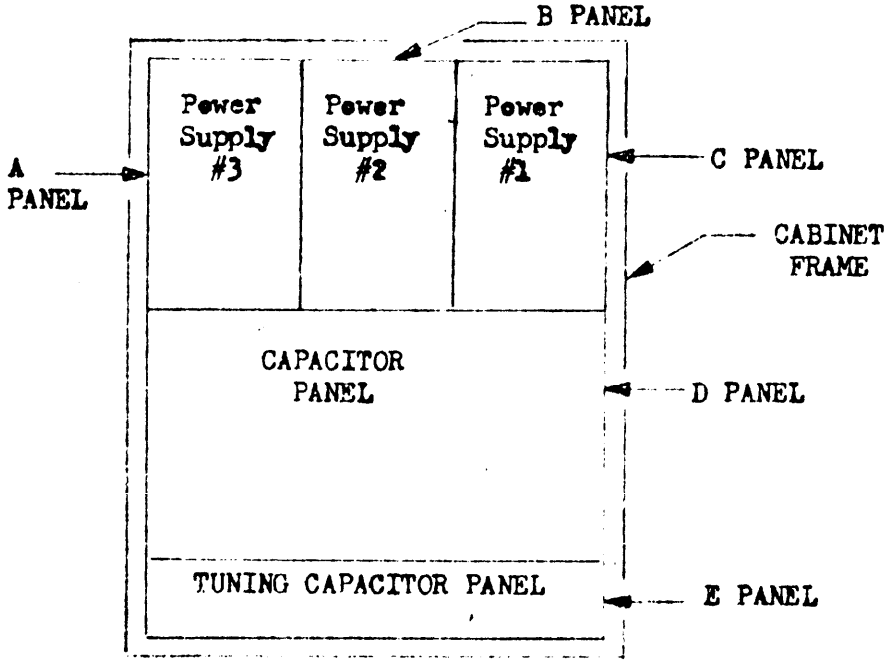

"A" RACK---Front view of Cabinet

FIGURE #15-A

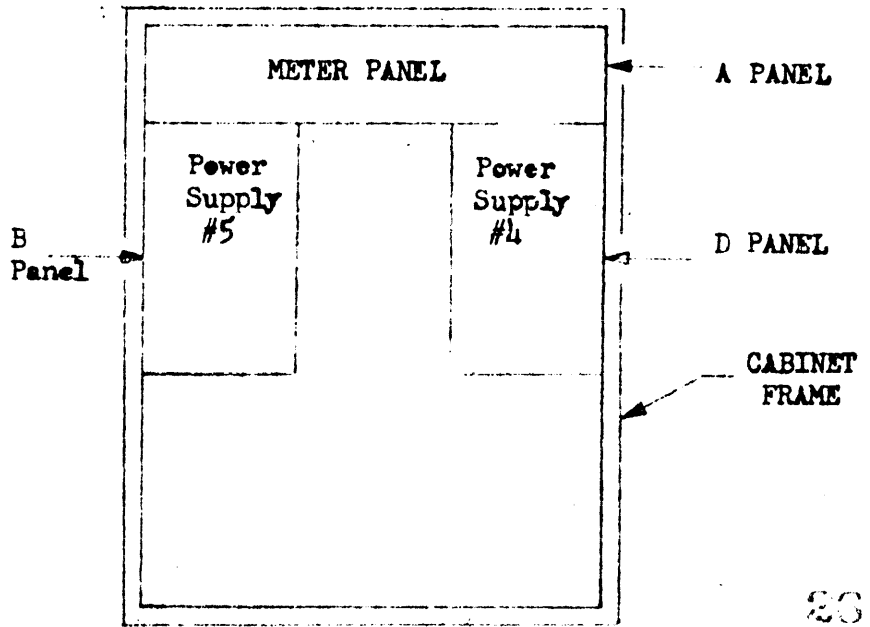

"E" RACK---Rear view of cabinet

FIGURE #15-B

Burroughs Corporation ELECTRODATA M & E DIVISION PASADENA CALIFORNIA	PREPARED BY FH 3-22-63	APPROVED F.L. Fox PROJ ENGR	DWG NO A 11891660	A REV
	CHECKED BY	L. Johnson	TITLE B5000 SPECIAL INSTRUCTIONS	Section I PAGE 24 CONT ON 25
PROPERTY OF BURROUGHS CORPORATION NOT TO BE REPRODUCED NOR USED FOR MANUFACTURING PURPOSES EXCEPT ON BURROUGHS ORDER OR PRIOR WRITTEN CONSENT			TYPED DRAWING FORM	

POWER SUPPLY UNIT RACK & PANEL LOCATION:

Reference 3.7.2

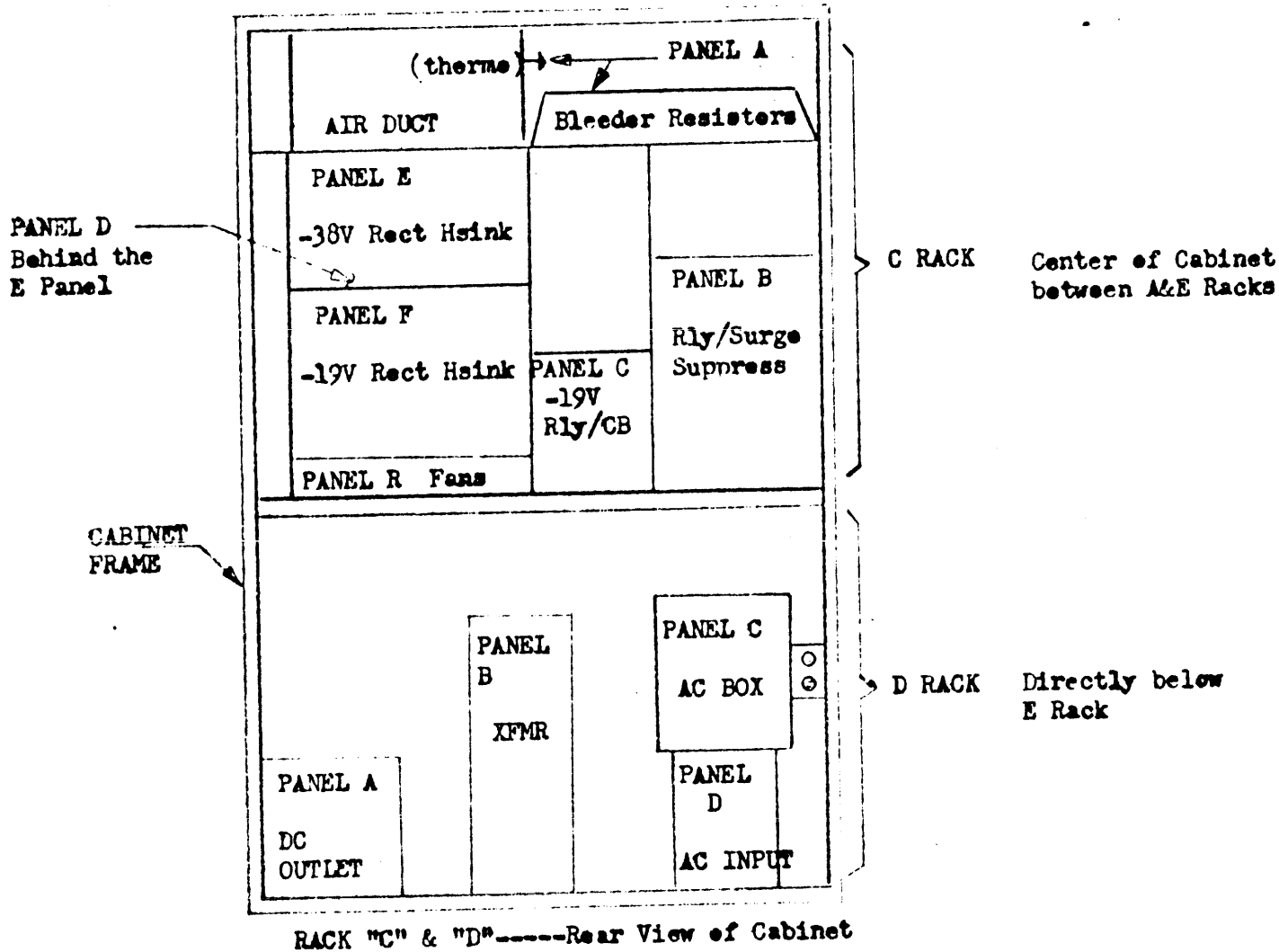



FIGURE #15-C

Burroughs Corporation  ELECTRODATA M & E DIVISION PASADENA CALIFORNIA	PREPARED BY FH 3-22-63	APPROVED F.L. Fox	DWG NO A 11891660	A REV
	CHECKED BY	PROJ ENGR L. Johnson	PAGE 25 Section I CONT ON 26	
PROPERTY OF BURROUGHS CORPORATION NOT TO BE REPRODUCED NOR USED FOR MANUFACTURING PURPOSES EXCEPT ON BURROUGHS ORDER OR PRIOR WRITTEN CONSENT		TITLE B5000 SPECIAL INSTRUCTIONS TYPED DRAWING FORM		

POWER SUPPLY UNIT RACK & PANEL LOCATION:

Reference 3.7.2

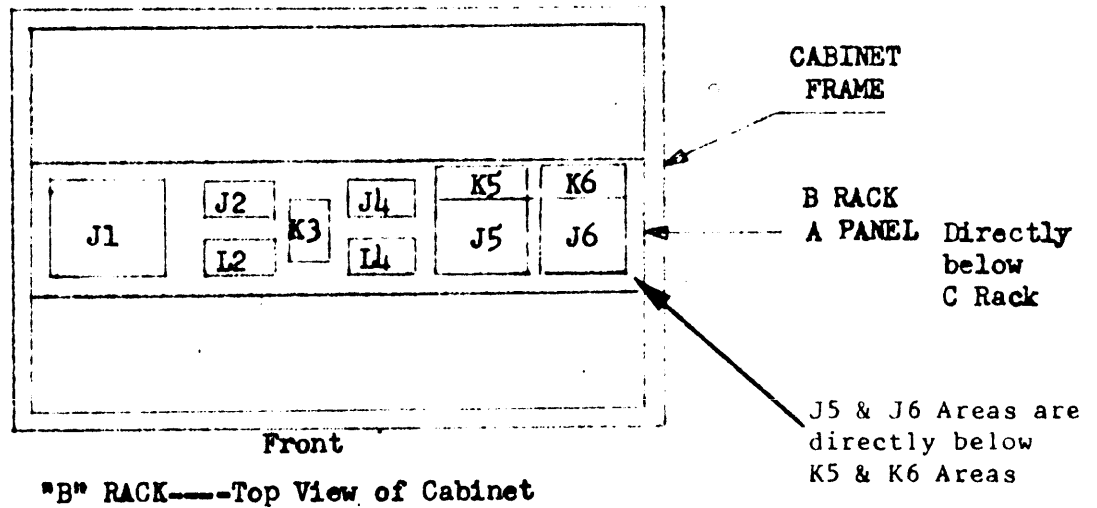

FIGURE #15-D

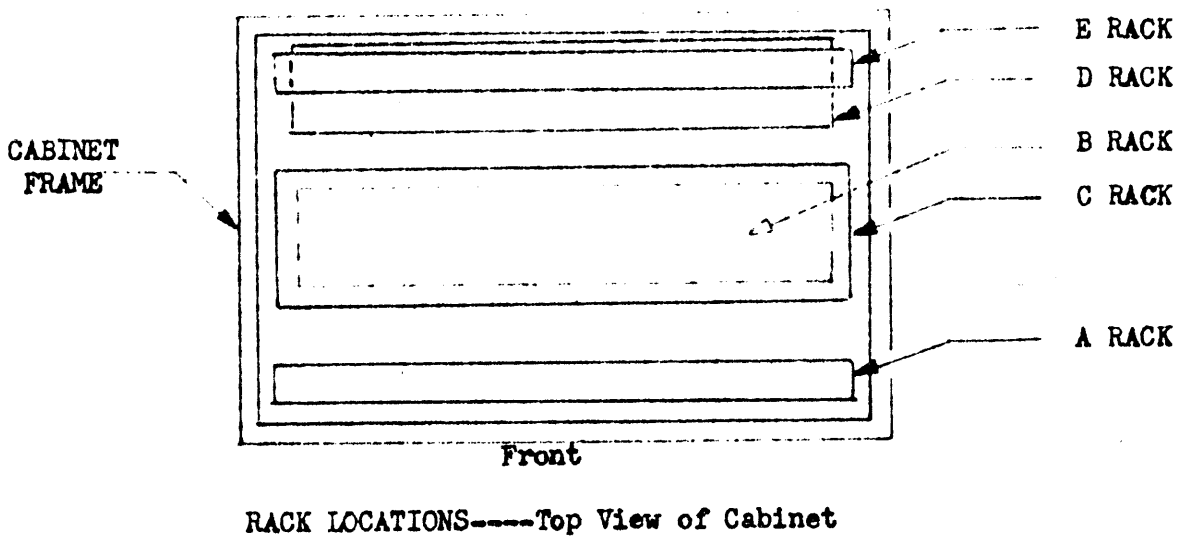

FIGURE #15-E

Burroughs Corporation ELECTRODATA M & E DIVISION PASADENA CALIFORNIA PROPERTY OF BURROUGHS CORPORATION NOT TO BE REPRODUCED NOR USED FOR MANUFACTURING PURPOSES EXCEPT ON BURROUGHS ORDER OR PRIOR WRITTEN CONSENT	PREPARED BY FH 3-23-63	APPROVED F.L. Fox	DWG NO A 11891660	A REV
	CHECKED BY	PROJ ENGR L. Johnson	PAGE 26	CONT. OF 27
TITLE B5000 SPECIAL INSTRUCTIONS			TYPED DRAWING FORM	

OPERATOR'S CONSOLE UNIT RACK & PANEL LOCATION:

Reference 3.7.3

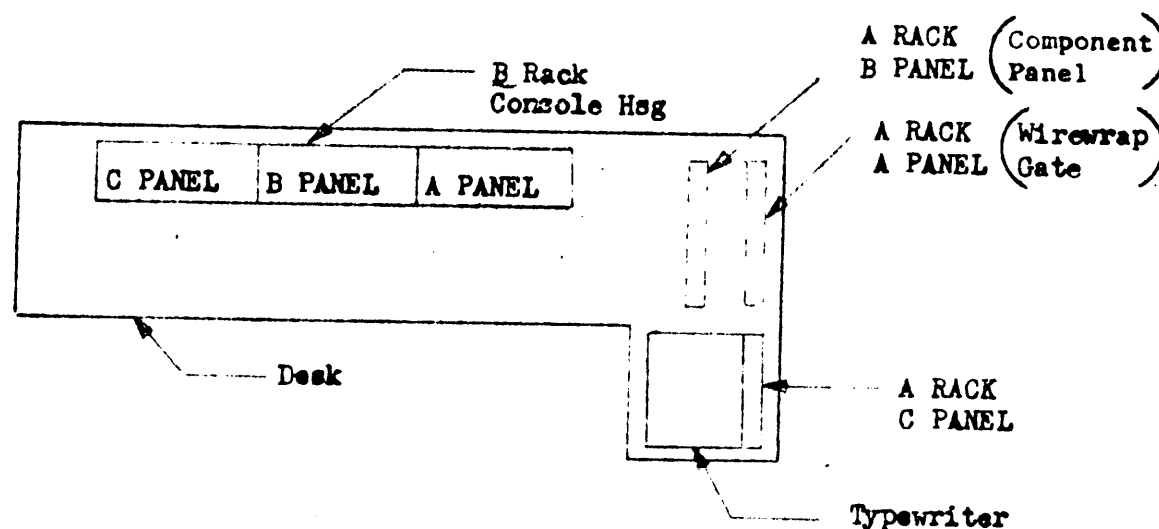

FIGURE #16

85





Burroughs Corporation  ELECTRODATA M & E DIVISION PASADENA CALIFORNIA	PREPARED BY Hausmann 4-3-63	APPROVED F. L. Fox	DWG NO A 11891660	
	CHECKED BY	PROJ ENGR L. Johnson	Section II PAGE 27 CONT ON 28	
PROPERTY OF BURROUGHS CORPORATION NOT TO BE REPRODUCED NOR USED FOR MANUFACTURING PURPOSES EXCEPT ON BURROUGHS ORDER OR PRIOR WRITTEN CONSENT		TITLE B5000 SYSTEM SPECIAL INSTRUCTIONS <small>TYPED DRAWING FORM</small>		

TABLE OF CONTENTS

SECTION II: CABLE INFORMATION

- 1.0 GENERAL
 - 1.1 Cable Documents
 - 1.1.1 Test & Field Reference Documents
 - 1.1.2 Manufacturing Documents
 - 1.2 Unit Cable Functions
 - 1.3 Peripheral Unit Cables
- 2.0 B5000 SYSTEM CABLE INDEX
 - 2.1 Cable Index Format
- 3.0 B5000 CABLE USAGE CHART
 - 3.1 Cable types
 - 3.2 Cable requirements and chart format
- 4.0 B5000 SYSTEM DISTRIBUTION & SENSING INDEX
 - 4.1 Index format
- 5.0 CABLE TYPES
 - 5.1 Quad Type Cables
 - 5.1.1 Quad location configurations Figure #1
 - 5.1.2 Quad functional types Figures #2 & #3
 - 5.2 Diode Stick Type Cables
 - 5.3 Single Conductor Cables
 - 5.4 Single twisted pair cables
 - 5.5 Composite DC power cable
 - 5.6 Winchester Connector type cables

Burroughs Corporation  ELECTRODATA M & E DIVISION PASADENA CALIFORNIA	PREPARED BY Hausmann 4-3-63	APPROVED F. L. Fox	DWG NO A 11891660	 Section II PAGE 28 CONT ON 29
	CHECKED BY	PROJ ENGR L. Johnson	TITLE B5000 SYSTEM SPECIAL INSTRUCTIONS	
PROPERTY OF BURROUGHS CORPORATION NOT TO BE REPRODUCED NOR USED FOR MANUFACTURING PURPOSES EXCEPT ON BURROUGHS ORDER OR PRIOR WRITTEN CONSENT			TYPED DRAWING FORM	

SECTION II: TABLE OF CONTENTS (cont'd)

- 6.0 SIGNAL CABLES
- 7.0 DISPLAY CABLES
- 8.0 POWER CABLES
 - 8.1 DC Power
 - 8.2 Local DC Power
 - 8.2.1 Power quads
 - 8.2.2 Memory special power
 - 8.3 Peripheral Unit Power
 - 8.4 Thermal Sense & Power Sense Cables
 - 8.5 115VAC Fan & Convenience Cables
- 9.0 CABLE ROUTING
 - 9.1 Cable Supports Figure #4
 - 9.2 Routing Rules Figure #5
- 10.0 CONDUIT
 - 10.1 Junction Box and Duct Kit
 - 10.2 Cable Grouping Figure #6
 - 10.3 Conduit routed cable lengths Figure #7
- 11.0 CLAMPING
 - 11.1 Quad & Display Cables on Gates Figure #8
 - 11.2 Clock Line Cables on Gates Figure #9 & #9A
 - 11.3 Peripheral Unit Signal Cables on Panels Figure #10

Burroughs Corporation  ELECTRODATA M & E DIVISION PASADENA CALIFORNIA PROPERTY OF BURROUGHS CORPORATION NOT TO BE REPRODUCED NOR USED FOR MANUFACTURING PURPOSES EXCEPT ON BURROUGHS ORDER OR PRIOR WRITTEN CONSENT	PREPARED BY Hausmann	APPROVED F. L. Fox	DWG NO A 11891660	A <small>REV</small>
	CHECKED BY	PROJ ENGR L. Johnson	Section II PAG 29 CONT ON 30	TITLE B5000 SYSTEM SPECIAL INSTRUCTIONS TYPED DRAWING FORM

SECTION II: CABLE INFORMATION

1.0 GENERAL

1.1 Applicable assembly Parts Lists, routing, termination, and distribution information for MIN/MAX B5000 System cables may be derived from the following documents:

- a. B5000 System Cable Index A 11869823
- b. B5000 System Cable Usage Chart B 11924776
- c. B5000 System Distribution & Sensing Index PL 11976693

- 1.1.1 Items "a" and "c" in 1.1 are Test & Field Documents and are carried in the Central Control T & F Index.
- 1.1.2 Item "b" in 1.1 is a document to be employed by Manufacturing in determining the proper cables to be ordered for any particular "system mix".

1.2 The following B5000 Unit and Sub-system cables are included in the Cable Index and Cable Usage Chart:

Central Control Unit	Inter-Rack and Inter-Unit
Display & Distribution Unit	Inter-Rack and Inter-Unit
Processor Unit	Inter-Rack and Inter-Unit
Core Mem Unit & Sub-system	Inter-Rack and Inter-Unit
* Drum Mem Unit & Sub-system	Inter-Rack and Inter-Unit
I/O Control Unit & Sub-System	Inter-Rack and Inter-Unit
* Operator's Console Unit	Inter-Rack and Inter-Unit
* Power Supply Unit	Inter Unit <u>ONLY</u>
* B5000 remote units/sub-systems	

1.3 Peripheral Unit cables, other than remote units specified in 1.2, do not appear in the Cable Index or Cable Usage Chart. These cables appear as items of the P/Ls of the Peripheral Units concerned.

Burroughs Corporation  ELECTRODATA M & E DIVISION PASADENA CALIFORNIA	PREPARED BY Hausmann	APPROVED F. L. Fox	DWG NO A 11891660	A REV
	CHECKED BY	PROJ ENGR L. Johnson	PAGE 30	CONT ON 31
PROPERTY OF BURROUGHS CORPORATION NOT TO BE REPRODUCED NOR USED FOR MANUFACTURING PURPOSES EXCEPT ON BURROUGHS ORDER OR PRIOR WRITTEN CONSENT		TITLE B5000 SYSTEM SPECIAL INSTRUCTIONS TYPED DRAWING FORM		

2.0 B5000 SYSTEM CABLE INDEX

2.1 Each individual cable within the MIN/MAX B5000 System has an indentification number assigned to it. These numbers are sequentially listed in the B5000 System Cable Index, A 11869823.

Recorded opposite each listed cable is the following information:

- a. -Engineering assembly number
- b. Accountable Unit/S-S Name
- c. FROM and TO location
- d. Tray routing
- e. General cable Function

3.0 B5000 CABLE USAGE CHART

3.1 The different types of cable assemblies used within the B5000 maximum system are numerically listed on the B5000 Cable Usage Chart, B 11924776.

3.2 Many cable assemblies have multiple usage within a given Unit and may also be employed in more than one Unit/S-S. As the B5000 System is modular, the Unit "mix" of systems may vary from system to system resulting in varying cable requirements.

The proper cable requirement of a particular mix may be determined by following the desired Unit columns on the Usage Chart and obtaining the cables in the quantities indicated in those columns.

4.0 B5000 SYSTEM DISTRIBUTION & SENSING INDEX

4.1 The B5000 System Dist. & Sense Index is a listing of diagrams indicating the distribution and termination of power, interlock, sensing, clock, and other circuits which are not shown on any other T & P type document released with the B5000.

Burroughs Corporation  ELECTRODATA M & E DIVISION PASADENA CALIFORNIA	PREPARED BY Hausmann	APPROVED F. L. Fox	DWG NO A 11891660	A REV
	CHECKED BY	PROJ ENGR L. Johnson	Section II PAGE 31 CONT ON 32	
PROPERTY OF BURROUGHS CORPORATION NOT TO BE REPRODUCED NOR USED FOR MANUFACTURING PURPOSES EXCEPT ON BURROUGHS ORDER OR PRIOR WRITTEN CONSENT		TITLE B5000 SYSTEM SPECIAL INSTRUCTIONS TYPED DRAWING FORM		

4.1. (contd)

The diagrams indicate the identification cable number, unit routing, and termination pins of each cable shown.

5.0 CABLE TYPES

The B5000 System utilizes the following general types of cables:

- a. Quad type cables --- 46TP, 50TW, 5TW
- b. Diode Stick Frame to Fanned end---various no. of conductors and AWG
- c. Single Conductor Cables---various AWG
- d. Single Twisted Pair Cables---various AWG
- e. Composit DC Pwr. Cable
- f. Winchester Connector Cables

5.1 QUAD TYPE CABLES

A Quad Cable is one having, permanently mounted on either OR both extremities, a 50 pin connector designed to allow its keyed insertion into one quadrant of a 200 pin wire-wrap connector.

The 200 pin connector is divided into 4 quadrants of 50 pins each.

These quadrants are identified by their location pins as A2, A7, N2, or N7.

5.1.1 The Quad Connectors have four location configurations as follows:

(Fig. # 1)

Right Lower (RL)---- Quadrants A7 & N7
 Right Upper (RU)---- Quadrants A2 & N2
 Left Lower (LL)---- Quadrants A2 & N2
 Left Upper (LU)---- Quadrants A7 & N7

5.1.2 The Quad Connectors are of three functional types as follows:

- a. 46 Twisted pair with a 4 pin common ground. There are 46 TP signal lines available and the ground wire of each connects to the common ground. (Fig. # 2.)

Burroughs Corporation  ELECTRODATA M & E DIVISION PASADENA CALIFORNIA	PREPARED BY Hausmann	APPROVED F.L. Fox	DWG NO A 11891660	A REV
	CHECKED BY	PROJ ENGR L. Johnson	PAGE 32 CONT ON 33	
PROPERTY OF BURROUGHS CORPORATION NOT TO BE REPRODUCED NOR USED FOR MANUFACTURING PURPOSES EXCEPT ON BURROUGHS ORDER OR PRIOR WRITTEN CONSENT			TITLE B5000 System Special Instructions <small>TYPED DRAWING FORM</small>	

1. Normal usage of Quad Connector Cables is to locate the Quad Cords in the column of 200 Pin Connector Blocks nearest the edge of the panel.
- If the panels are on gates, the column nearest the HINGE SIDE of the gate is used.
2. LEFT QUAD-cable breaks out to left of conn.
3. RIGHT QUAD-cable breaks out to the right of the Quad Conn.
4. KEY PINS exist to prevent Left to Right exchange of Quad Connectors.
5. Quads are designated by Key Pin Location.

LEFT QUAD

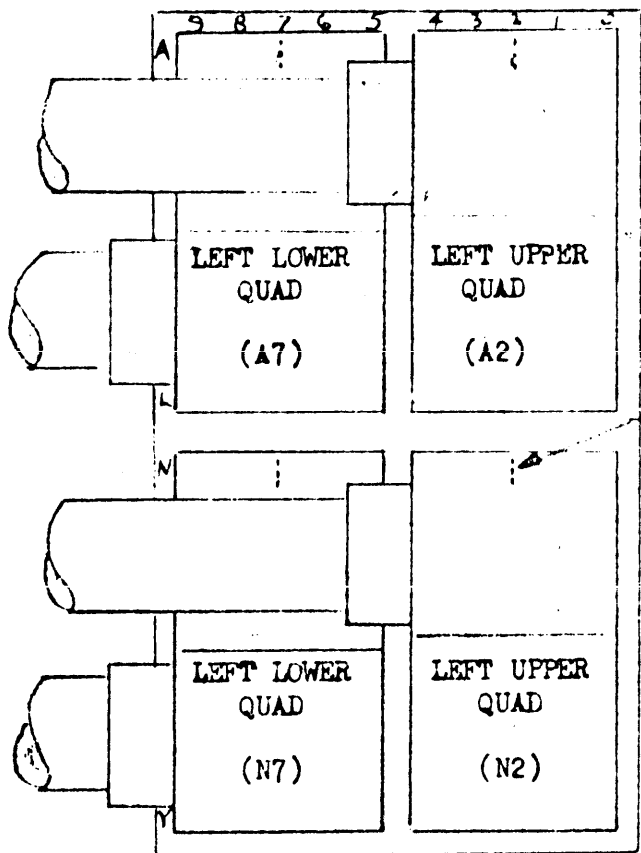

200 Pin
Connector
Block

Key Pin N2
(Example)

(Example)
Key Pin A7

RIGHT QUAD

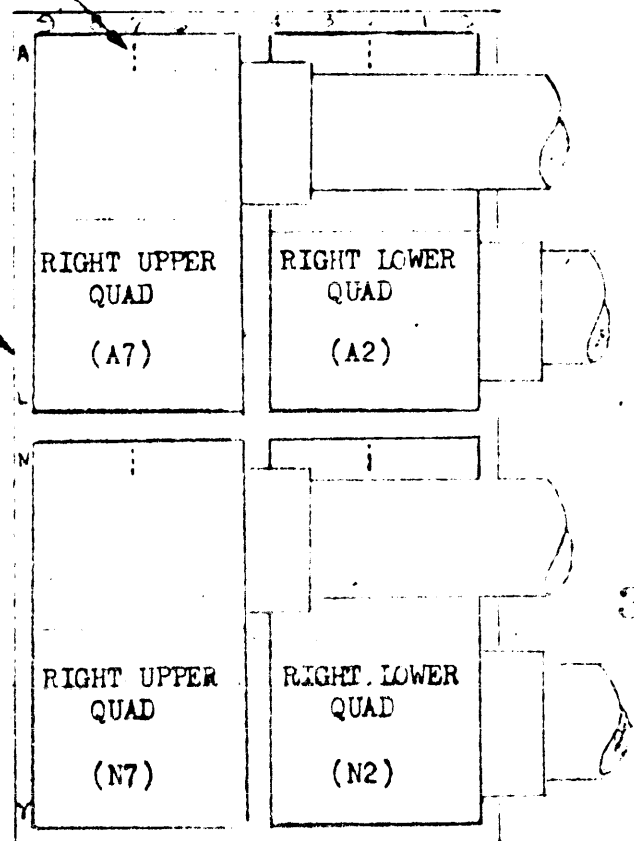

200 Pin
Connector
Block

← HINGE

Left or Right Quad Connectors nearest the Hinge are Lower Quads.

HINGE →

FIGURE #1

Burroughs Corporation  ELECTRODATA M & E DIVISION PASADENA CALIFORNIA	PREPARED BY Hausmann	APPROVED F.L. Fox	DWG NO A 11891660	A REV
	CHECKED BY	PROJ ENGR L. Johnson	PAGE 33 CONT. 34	
PROPERTY OF BURROUGHS CORPORATION NOT TO BE REPRODUCED NOR USED FOR MANUFACTURING PURPOSES EXCEPT ON BURROUGHS ORDER OR PRIOR WRITTEN CONSENT		TITLE B5000 SYSTEM SPECIAL INSTRUCTIONS TYPED DRAWING FORM		

QUAD CONNECTOR---46 TP, 4 Pin Common Ground

a. A copper ground plane is molded within the connector. All 50 pins protrude thru this ground plane. Four pins, A2-B2-K2-L2, are electrically connected to the plane; all other pins do not make electrical contact with the plane.

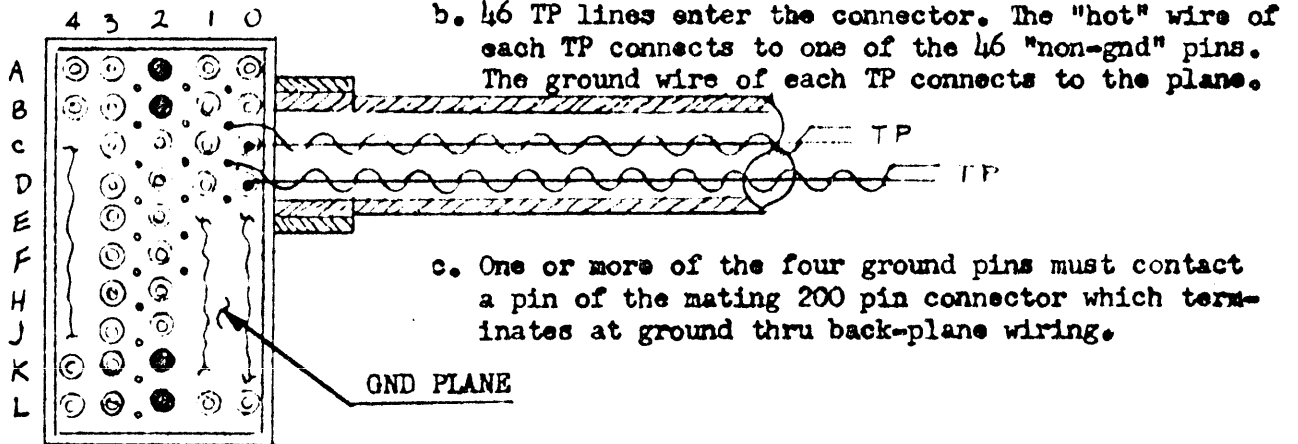

FIGURE 2

QUAD CONNECTOR---5 Conductor

- a. The ten pins of each pin column are commoned, i.e., Pins A5 thru L5, A6 thru L6, etc.
- b. A 12 AWG conductor is connected internally to each of the 5 circuits.

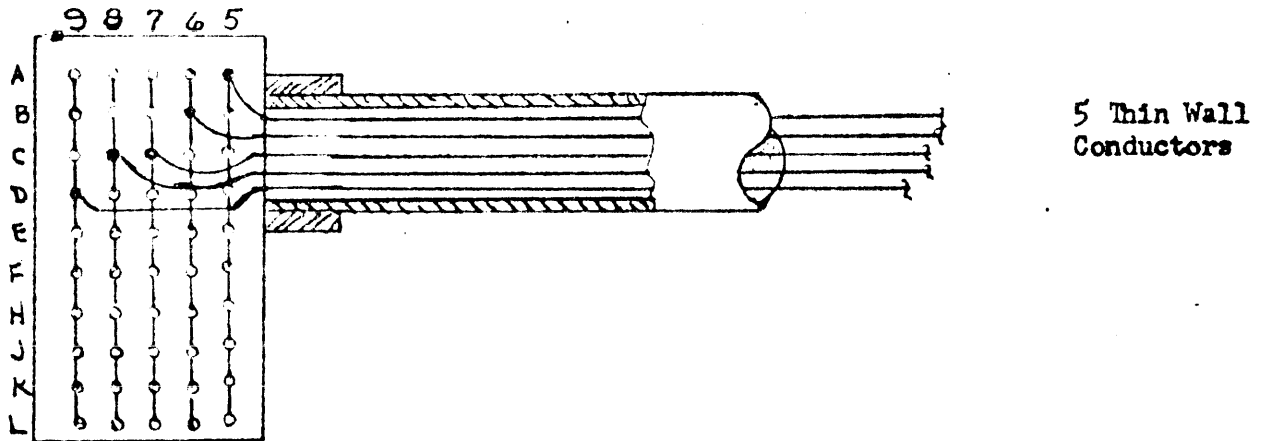



FIGURE # 3

Burroughs Corporation  ELECTRODATA M & E DIVISION PASADENA CALIFORNIA	PREPARED BY Hausmann	APPROVED F. L. Fox	DWG NO A 11891660	A REV
	CHECKED BY L. Johnson	PROJ ENGR L. Johnson	Section II PAGE 34 CONT ON 35	
PROPERTY OF BURROUGHS CORPORATION NOT TO BE REPRODUCED NOR USED FOR MANUFACTURING PURPOSES EXCEPT ON BURROUGHS ORDER OR PRIOR WRITTEN CONSENT		TITLE B5000 SYSTEM SPECIAL INSTRUCTIONS TYPED DRAWING FORM		

5.1.2 (contd)

- b. 50 Lines available. One Thin Wall line to each pin of the quad connector.
- c. 5 Lines available. The 10 pins of each quad column are commoned and each column connected to a #12AWG conductor. (Fig. # 3.)

5.2 DIODE STICK TYPE CABLES

This type cable is one having, permanently mounted at one or both extremities, diode stick frame (or similar assembly) which is inserted into one Quadrant pin column for connection.

This type cable is used for the following functions:

- a. Clock Lines
- b. Heat Sense Lines
- c. Power Sense Lines
- d. Memory Special Power

5.3 SINGLE CONDUCTOR CABLES

As the name implies, these cables are assemblies of terminating hardware and a single conductor. The AWG of these cables vary from #12AWG to #4/0 AWG. They will be further discussed under "Power Cables" in this instruction.

5.4 SINGLE TWISTED PAIR CABLES

As the name implies, this type is an assembly of terminating hardware and a twisted pair conductor. Some are rubber covered PVC TP and others are open PVC TP.

General function of this type is to route 115VAC from cabinet to cabinet.

Burroughs Corporation  ELECTRODATA M & E DIVISION PASADENA CALIFORNIA	PREPARED BY Hausmann	APPROVED F. L. Fox	DWG NO A 11891660	A REV
	CHECKED BY	PROJ ENGR L. Johnson	Section II PAGE 35 CONT ON	36
PROPERTY OF BURROUGHS CORPORATION NOT TO BE REPRODUCED NOR USED FOR MANUFACTURING PURPOSES EXCEPT ON BURROUGHS ORDER OR PRIOR WRITTEN CONSENT		TITLE B5000 SYSTEM SPECIAL INSTRUCTIONS <small>TYPED DRAWING FORM</small>		

5.5 COMPOSITE DC POWER CABLE

The Composite cable is a grouping of lines that route low power DC from the Power Supply Unit to the D&D Unit.

5.6 WINCHESTER CONNECTOR TYPE CABLES:

This type cable employs Winchester connectors and various TP cable to interconnect peripheral and remote units, signalwise, to the Main Frame.

6.0 SIGNAL CABLES

Signal communication between racks of a Unit, between Units/S-S, and between Main Frame cabinets is generally accomplished by means of Quad Type Cables. The construction of the Quad Type Cables includes Quad Conn to Quad Conn, Quad to Winchester Conn, Quad to Cannon Conn and Quad to fanned open end.

7.0 DISPLAY CABLES

The Display Cables are of the Quad to 50 Pin Cannon Connector type with 50 Thin Wall #24 AWG conductors.

These cables are routed from the CC, Processor, and I/O Units to their respective display panels in the D&D Unit.

They consist of lines for the control, set, and manual control of the various unit display panel components and their associated circuitry.

Burroughs Corporation  ELECTRODATA M & E DIVISION PASADENA CALIFORNIA PROPERTY OF BURROUGHS CORPORATION. NOT TO BE REPRODUCED NOR USED FOR MANUFACTURING PURPOSES EXCEPT ON BURROUGHS ORDER OR PRIOR WRITTEN CONSENT	PREPARED BY T. J. Jones	APPROVED F. L. Fox	DRAWING NO. A 11891660	B REV
	CHECKED BY	PROJECT ENGR	SECTION II PAGE 36 cont on 37	
		TITLE B5000 SYSTEM SPECIAL INSTRUCTIONS TYPED DRAWING FORM		

8.0 POWER CABLES

8.1 DC POWER

With the exception of various low power lines (see COMPOSITE CABLE, 5.5), power is distributed via Single Conductor cables from the Power Supply Unit to the D&D Unit.

DC Power is distributed via Single Conductor Cables from the D&D Unit to the Voltage Regulator and/or special terminal strips of the other cabinets of the Main Frame.

The -19V cables from Power Supply, to each main frame unit, pass thru D&D Unit but do not terminate there.

8.2 LOCAL DC POWER

8.2.1 Power Quads

Within each cabinet or Sub-system, power is distributed to each wire-wrap frame from the Voltage Regulator by means of Local Power Quad Cables.

Power Quad Cables are of the Right Upper OR the Left Upper connector type. See D-11973443, Quad Pwr Cable Routing Diagram.

8.2.2 Memory Special Power, Core Memory Unit #78495:

Special low power lines and Master Clear lines are routed from terminal strips on the cable rack assembly of each Memory Sub-system, via diode stick cables, to connector blocks on each Memory Unit within that sub-system. See D-11975372, Gnd-AC-Special Pwr Diagram.

Display Core Memory Unit #11154119:

Special power is routed from terminal strip on cable rack to the Display Panel. From the Display Panel via quad cable to the backplane connector.

Burroughs Corporation  ELECTRODATA M & E DIVISION PASADENA CALIFORNIA	PREPARED BY Hausmann	APPROVED F. L. Fox	DWG NO A 11891660	A REV
	CHECKED BY L. Johnson	PROJ ENGR L. Johnson	Section II PAGE 37 CONT ON 38	
PROPERTY OF BURROUGHS CORPORATION NOT TO BE REPRODUCED NOR USED FOR MANUFACTURING PURPOSES EXCEPT ON BURROUGHS ORDER OR PRIOR WRITTEN CONSENT		TITLE B5000 SYSTEM SPECIAL INSTRUCTIONS TYPED DRAWING FORM		

8.0 POWER CABLES (contd)

8.3 PERIPHERAL UNIT POWER

Peripheral Units, in some cases, receive a portion of necessary power from the D&D Unit via peripheral signal cables.

115VAC is received directly from the building circuits.

See various Peripheral Unit Interconnecting Line Specs.

8.4 THERMAL SENSING & POWER SENSING CABLES

Thermal Element leads and the -12V Over-current Sense Line are directed to one wire-wrap frame in each cabinet by means of a diode stick type cable.

These lines, in addition to the Power Sense lines for -1.2, -12, & 4.5, are routed via spares in signal cables and back-plane wiring to the Sensing Section of the D&D Unit.

See D-11971520, Heat-Pwr Sense-Intlk Diagram.

8.5 115VAC FAN & CONVENIENCE CABLES:

Two 115VAC circuits are routed to the D&D Unit from the Pwr Supply Unit, one each for the Fan Ckts and the Convenience Outlet Ckts.

The Fan Ckt is distributed to a terminal strip in the top cover of the D&D Unit and from there it is multiplied to all other Units in the Main Frame.

Burroughs Corporation  ELECTRODATA M & E DIVISION PASADENA CALIFORNIA	PREPARED BY Hausmann	APPROVED F. L. Fox	DWG NO A 11891660	A REV
	CHECKED BY	PROJ ENGR L. Johnson	Section II PAGE 38 CONT ON 39	
PROPERTY OF BURROUGHS CORPORATION NOT TO BE REPRODUCED NOR USED FOR MANUFACTURING PURPOSES EXCEPT ON BURROUGHS ORDER OR PRIOR WRITTEN CONSENT		TITLE B5000 SYSTEM SPECIAL INSTRUCTIONS TYPED DRAWING FORM		

8.5 115VAC FAN & CONVENIENCE CABLES (contd)

The Convenience Ckt is distributed from a terminal strip in the D&D Unit thru a multipled cable to dual outlets in all main frame cabinets of a basic B5000 System.

Additional short cables are available to add to the multiple when Mem Sub-system #2 and/or Processor B is added to the system make-up.

See D-11975372, Gnd-AC-Spec Pwr Diagram.

9.0 CABLE ROUTING

Within the B5000 Main frame, the general routing of cables is accomplished by means of Cable Trays.

The tray routing of each individual cable is indicated in the "Tray Column" of the Cable Index, 11869823. Exact compliance with tray routing is necessary to insure proper fit and appearance of overall cabling.

9.1 CABLE SUPPORTS

To prevent the pinching of cables at the lower hinges of certain gates, two cable supports, B-11982238, and their mounting hardware are supplied with each Central Control Unit.

After the Units of the Main Frame have been joined, the cable supports are installed as follows: (See FIG. #4)

- a. From the right rear of Tray #11 level of the Central Control cabinet to Tray #11 level of the M-881 cabinet.
- b. From the left front of Tray #11 Level of the Central Control cabinet to Tray #11 level of the D&D cabinet.

Burroughs Corporation  ELECTRODATA M & E DIVISION PASADENA CALIFORNIA	PREPARED BY Hausman	APPROVED F.L. Fox	DWG NO A 11891660	A REV
	CHECKED BY	PROJ ENGR L. Johnsen	Section II PAGE 39 CONT ON 40	
PROPERTY OF BURROUGHS CORPORATION NOT TO BE REPRODUCED NOR USED FOR MANUFACTURING PURPOSES EXCEPT ON BURROUGHS ORDER OR PRIOR WRITTEN CONSENT		TITLE B5000 SYSTEM SPECIAL INSTRUCTIONS TYPED DRAWING FORM		

LOCATION OF CABLE SUPPORTS:

Reference 9.0 of this instruction.

- a. Install two cable supports as shown in sketch below.
- b. Loosen and use existing mtg. hardware which secures tray #11 to the tray support in the CC Unit.
- c. Use supplied hardware to secure the CABLE SUPPORTS to the #11 tray supports of the I/O and D&D Units.
- d. Install Supports with "hemmed" edge up.

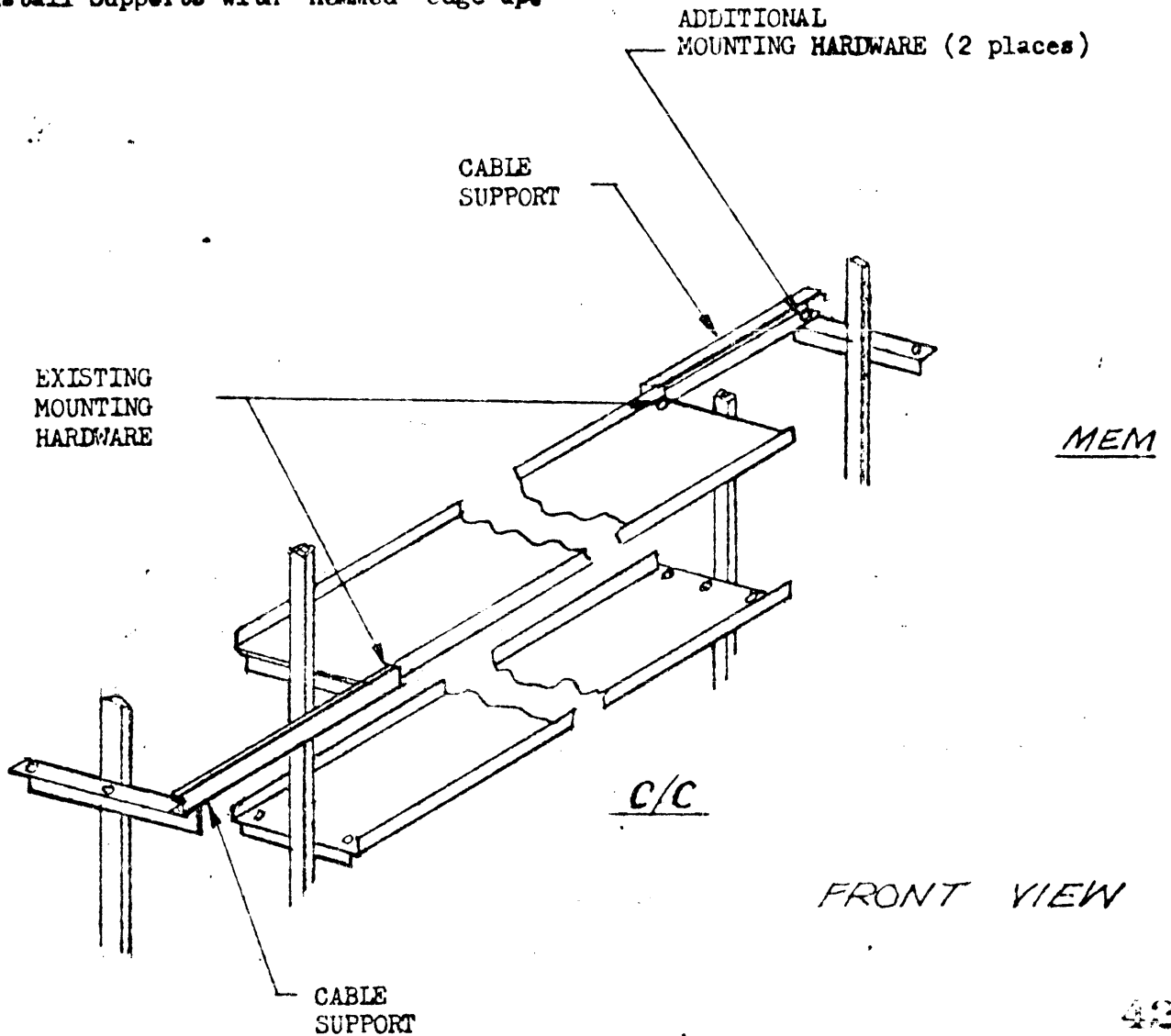

D&D

FIGURE # 4

Burroughs Corporation  ELECTRODATA M & E DIVISION PASADENA CALIFORNIA	PREPARED BY Hausmann	APPROVED F. L. Fox	DWG NO A 11891660	A REV
	CHECKED BY	PROJ ENGR L. Johnson	Section II PAGE 40 CONT ON 41	
PROPERTY OF BURROUGHS CORPORATION NOT TO BE REPRODUCED NOR USED FOR MANUFACTURING PURPOSES EXCEPT ON BURROUGHS ORDER OR PRIOR WRITTEN CONSENT		TITLE B5000 SYSTEM SPECIAL INSTRUCTIONS TYPED DRAWING FORM		

Form cables going to the lower E/F Panel rows of the CC gates ~~over these~~ supports to prevent pinching and chafing of the cables as the gates are swung full open and full closed.

9.2 ROUTING RULES

The following basic rules are to be observed when installing cables into the trays of a B5000 System Main Frame:

9.2.1 The letters "F" and "R" following a tray number in the Index, indicates Front and Rear of that tray (in front of or to the rear of the tray support post).

9.2.2 With the exception of Voltage Regulator cables, which break into the trays from above, cables will not enter trays except from the ends of the trays.

EXAMPLE: Peripheral Signal Cables from the "D" Rack of the D&D Unit to the CC Unit do not enter the D&D Unit cable rack but are clamped along the "D" rack and first enter trays at the left of the CC Unit.

9.2.3 A cable must follow the same designated tray, and F or R of that tray, thru all Units which it may pass. Must not jump from one tray to another or pass from F to R within its run length.

9.2.4 Whenever possible, cables to any "D" Gate are routed in the FRONT of the tray. Cables to the "B" Gates are routed in the REAR of the tray. This is to allow sufficient bend radius when the gates are closed.

Burroughs Corporation  ELECTRODATA M & E DIVISION PASADENA CALIFORNIA	PREPARED BY Hauemann	APPROVED F. L. Fox	DWG NO A 11891660	A REV
	CHECKED BY L. Johnson	PROJ ENGR L. Johnson	Section 11 PAGE 41 CONT ON 42	
PROPERTY OF BURROUGHS CORPORATION NOT TO BE REPRODUCED NOR USED FOR MANUFACTURING PURPOSES EXCEPT ON BURROUGHS ORDER OR PRIOR WRITTEN CONSENT		TITLE B5000 SYSTEM SPECIAL INSTRUCTIONS TYPED DRAWING FORM		

9.2.5 To prevent all excess cable length from being at one end of the run, equally distribute the cable slack at each bend at the racks.

9.2.6 To prevent unnecessary tangles and snarls in the breakouts of cables from tray to gates, it is recommended that cables be installed and clamped in place one tray at a time, i.e., Tray #11 cables be installed and clamped, then Tray #10, Tray #9, etc.

9.2.7 Using supplied tray clamps, cables are to be clamped in one or two levels within the F or R of the tray. (See FIG #5)
Up to four 46TP cables, up to ten 50TW or Local Pwr cables, or any combination of the two sizes to fill the same tray space may be clamped in one level.

In a "less than MAX" system, the F or R of some trays will have no cables present. To allow the use of the tray clamp, spare gate clamps may be used as fillers to support the end of the tray clamp not supported by existing cables.

10.0 CONDUIT

Some B5000 System installations will require conduit to route power cables from the Power Supply Unit to the D&D Unit of the Main Frame.

Six runs of 2" conduit will be required for a maximum system. As each system will vary in lengths required, the customer will determine and furnish the necessary conduit.

Burroughs Corporation  ELECTRODATA M & E DIVISION PASADENA CALIFORNIA	PREPARED BY Hausmann	APPROVED F.L. Fox	DWG NO A 11891660	A REV
	CHECKED BY	PROJ ENGR L. Johnson	Section 11 PAGE 42 CONT ON 43	
PROPERTY OF BURROUGHS CORPORATION NOT TO BE REPRODUCED NOR USED FOR MANUFACTURING PURPOSES EXCEPT ON BURROUGHS ORDER OR PRIOR WRITTEN CONSENT		TITLE B5000 SYSTEM SPECIAL INSTRUCTIONS TYPED DRAWING FORM		

TRAY CLAMPING LEVELS:

Reference 9.2.7 of this instruction.

- a. Four 46TP cables to fill a FRONT or REAR tray level.
- b. Ten 50TW or 5TW to fill a FRONT or REAR tray level.
- c. Any combination of cables to occupy the same space as cables in "a" or "b" above.
- d. Use spare or extra cable gate clamps to support the tray clamp where any level is not filled.

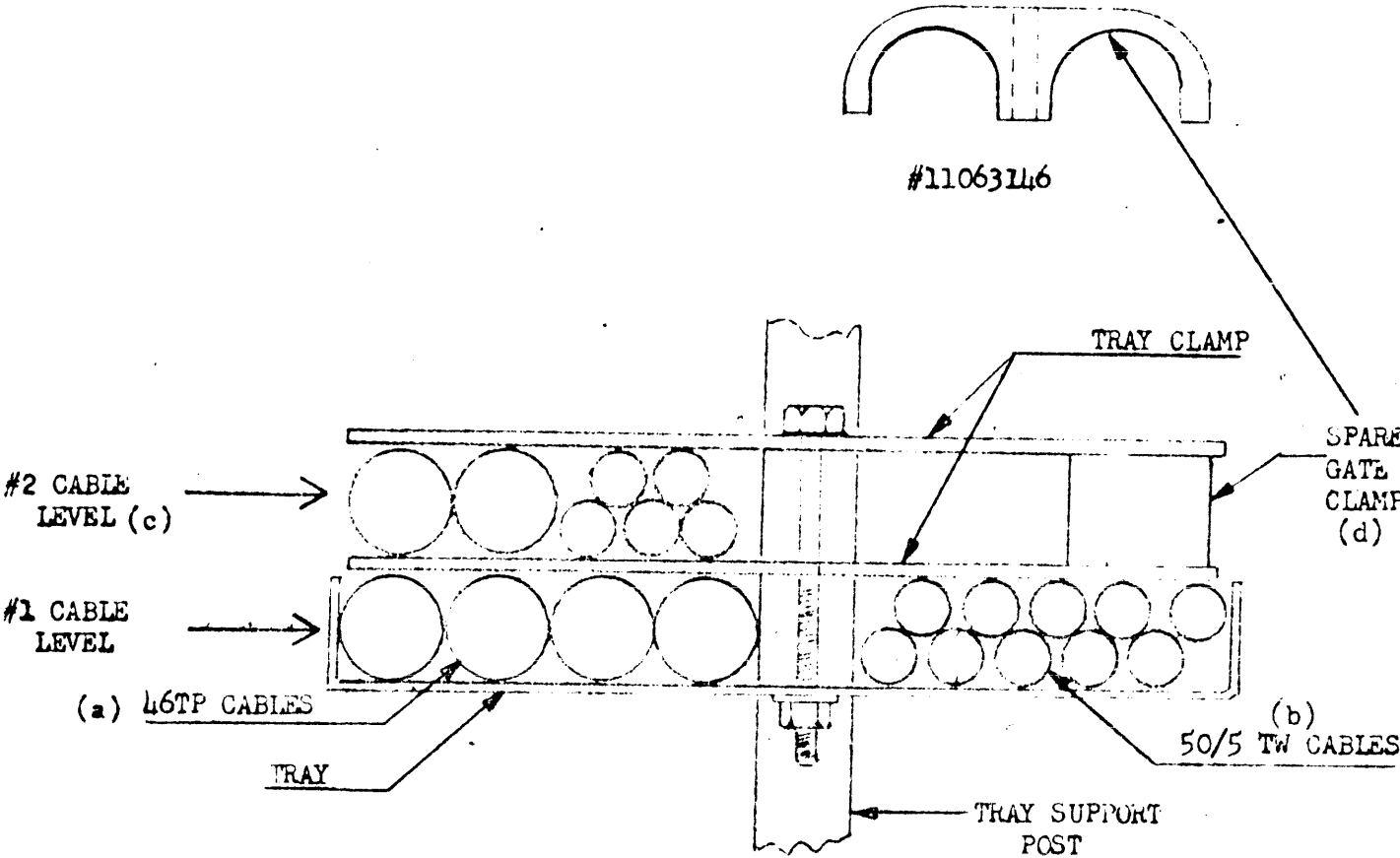



FIGURE # 5

Burroughs Corporation  ELECTRODATA M & E DIVISION PASADENA CALIFORNIA PROPERTY OF BURROUGHS CORPORATION NOT TO BE REPRODUCED NOR USED FOR MANUFACTURING PURPOSES EXCEPT ON BURROUGHS ORDER OR PRIOR WRITTEN CONSENT	PREPARED BY Hausmann	APPROVED F. L. Fox	DWG NO A 11891660	A REV
	CHECKED BY L. Johnson	PROJ ENGR L. Johnson	Section II PAGE 43 CONT ON 44	TITLE B5000 SYSTEM SPECIAL INSTRUCTIONS TYPED DRAWING FORM

10.1 JUNCTION BOX & DUCT KIT

A Junction Box and Duct Kit is released on the D&D Unit Parts List and is to be shipped to the Installation site with each B5000 System. The material in this KIT is to be installed AS REQUIRED, according to the needs as determined by Field Engineering, to carry power wiring from the Power Supply Unit to the D & D Unit.



10.2 CABLE GROUPING

To meet UL requirements, cables will be grouped within certain conduit runs as follows: (See Figure #6)

<u>Conduit</u>	<u>Cable NO.</u>	<u>Gauge</u>	<u>Conduit</u>	<u>Cable NO.</u>	<u>Gauge</u>
1	#201	#4/0	4	#204	#1/0 (shld)
	#210	#1/0		#203	#1/0
	#211	#4		#198	Composite
2	#200	#4/0	5	#205	#1/0 (shld)
	#212	#1/0		#208	#1/0 (shld)
	#213	#4		#209	#1/0 (shld)
3	#202	#4/0	6	#206	#1/0 (shld)
	#216	#4		#207	#1/0 (shld)
	#224	#10 (4 cond)			

10.3 CONDUIT ROUTED CABLE LENGTHS

Power cables are supplied to the field in standard maximum lengths. When conduit is required, it will at times be necessary to shorten these cables to meet a particular system requirement.

Burroughs Corporation  ELECTRODATA M & E DIVISION PASADENA CALIFORNIA	PREPARED BY Hausmann	APPROVED F.L. Fox	DWG NO A 11891660	
	CHECKED BY 	PROJ ENGR L. Johnson	Section II PAGE 44 Contd 45	
PROPERTY OF BURROUGHS CORPORATION NOT TO BE REPRODUCED NOR USED FOR MANUFACTURING PURPOSES EXCEPT ON BURROUGHS ORDER OR PRIOR WRITTEN CONSENT		TITLE B5000 SYSTEM SPECIAL INSTRUCTIONS <small>TYPED DRAWING FORM</small>		

CONDUIT DESIGNATION FOR CABLE GROUPING:

Reference 10.2

The sketch below indicates the conduit (1 thru 6) designation for a normal installation.

At the discretion of the installing personnel, and according to the relative location of the two Units, the number designations may be physically reversed or their sequence changed to meet a particular need.

GROUNDING:

- a. Utilizing mounting holes in Duct and duct-entry of the Junction Box, secure the two parts with screws and other hardware supplied in the Kit. Screws to be installed with heads inside the duct.
- b. To satisfy NEL Code, attach Gnd Strap, #11052891, to any one of the conduits and connect this strap to Bldg Ground as required by Code.

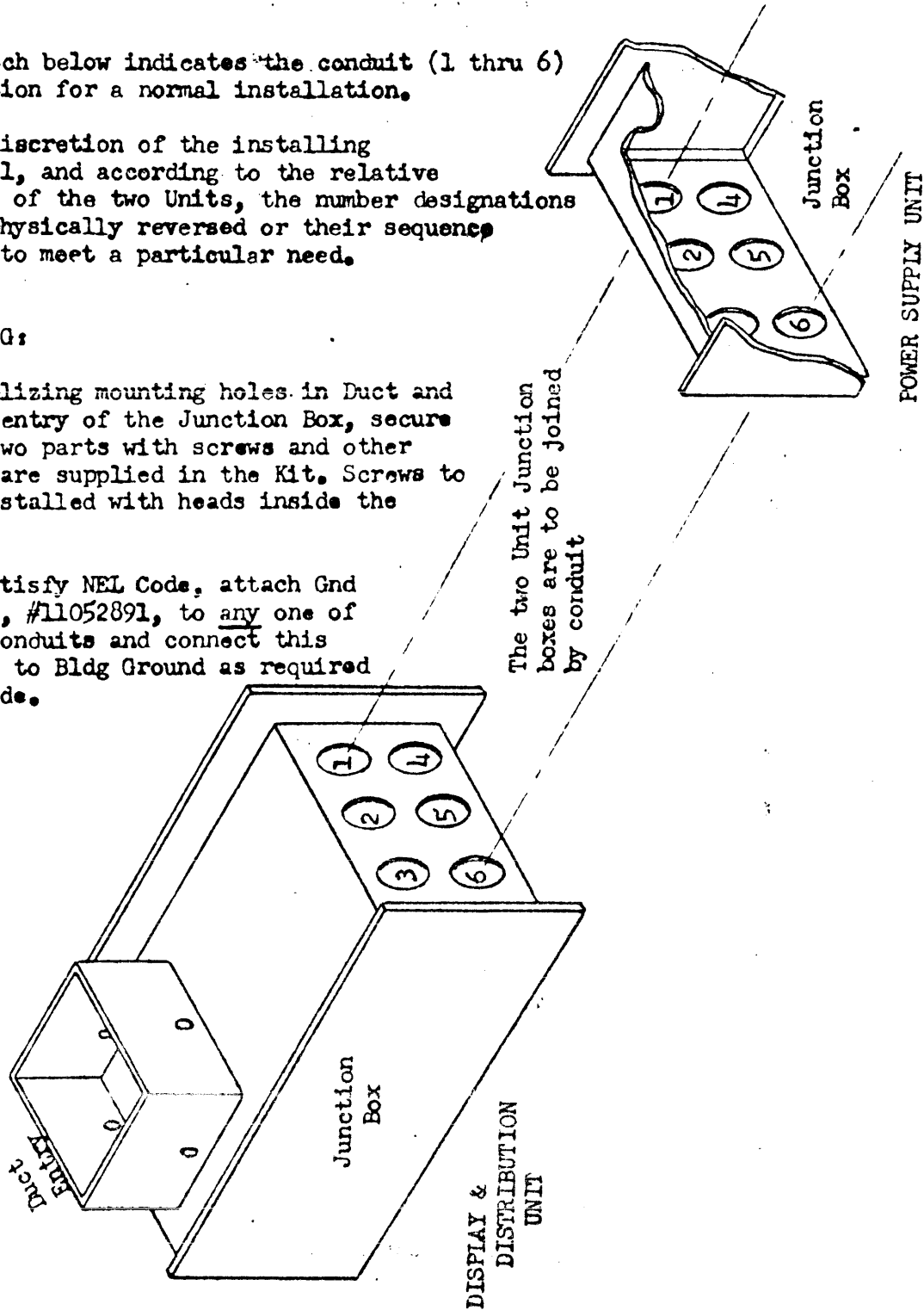



FIGURE #6

Burroughs Corporation  ELECTRODATA M & E DIVISION PASADENA CALIFORNIA PROPERTY OF BURROUGHS CORPORATION NOT TO BE REPRODUCED NOR USED FOR MANUFACTURING PURPOSES EXCEPT ON BURROUGHS ORDER OR PRIOR WRITTEN CONSENT	PREPARED BY Hausmann	APPROVED F. L. Fox	DWG NO A 11891660	A REV
	CHECKED BY	PROJ ENGR L. Johnson	Section II PAGE 75 CONT ON 76	
		TITLE B5000 SYSTEM SPECIAL INSTRUCTIONS TYPED DRAWING FORM		

10.3 (cont)

A Field Cable Lug KIT, A-11993813, is released on the D&D Unit Parts List and is to be shipped to the installation site with each B5000 System.

The terminal lugs in this KIT are to be installed AS REQUIRED according to the needs as determined by Field Engineering. Special tools for the application of the lugs will be furnished by Field Engineering.

See Figure #7 for clamping of power cables on the "D" Rack of the D & D Unit.

11.0 CLAMPING

All quad and signal type cables must be clamped or otherwise secured to prevent unnecessary leverage or tension at the connector area.

11.1 Quad & Display Cables on Gates: Figure #8

All quad or display cables terminating on hinged gates are physically connected near the hinge side of each gate. Generally these are clamped on a special bracket mounted on the hinge side of the gate frame.

11.2 Clock Line Cables on Gates: Figure #9 & 9A

This type cable is routed from the inner areas of the gate toward the hinge side of the gate frame.

To prevent its interfering with the removal of other pluggable components, spring cable clamps, #11974383, are to be employed to route the Clock Cable inside the channel of the horizontal members of the panel frame.

Burroughs Corporation  ELECTRODATA M & E DIVISION PASADENA CALIFORNIA	PREPARED BY Hausmann 4-4-63	APPROVED F.L. Fox	DWG NO A 11891660	B REV
	CHECKED BY	PROJ ENGR L. Johnson	PART 46	CONT ON #47
PROPERTY OF BURROUGHS CORPORATION NOT TO BE REPRODUCED NOR USED FOR MANUFACTURING PURPOSES EXCEPT ON BURROUGHS ORDER OR PRIOR WRITTEN CONSENT		TITLE B5000 SYSTEM SPECIAL INSTRUCTIONS <small>TYPED DRAWING FORM</small>		

CLAMPING OF CONDUIT ROUTED POWER CABLES:

Reference 10.3

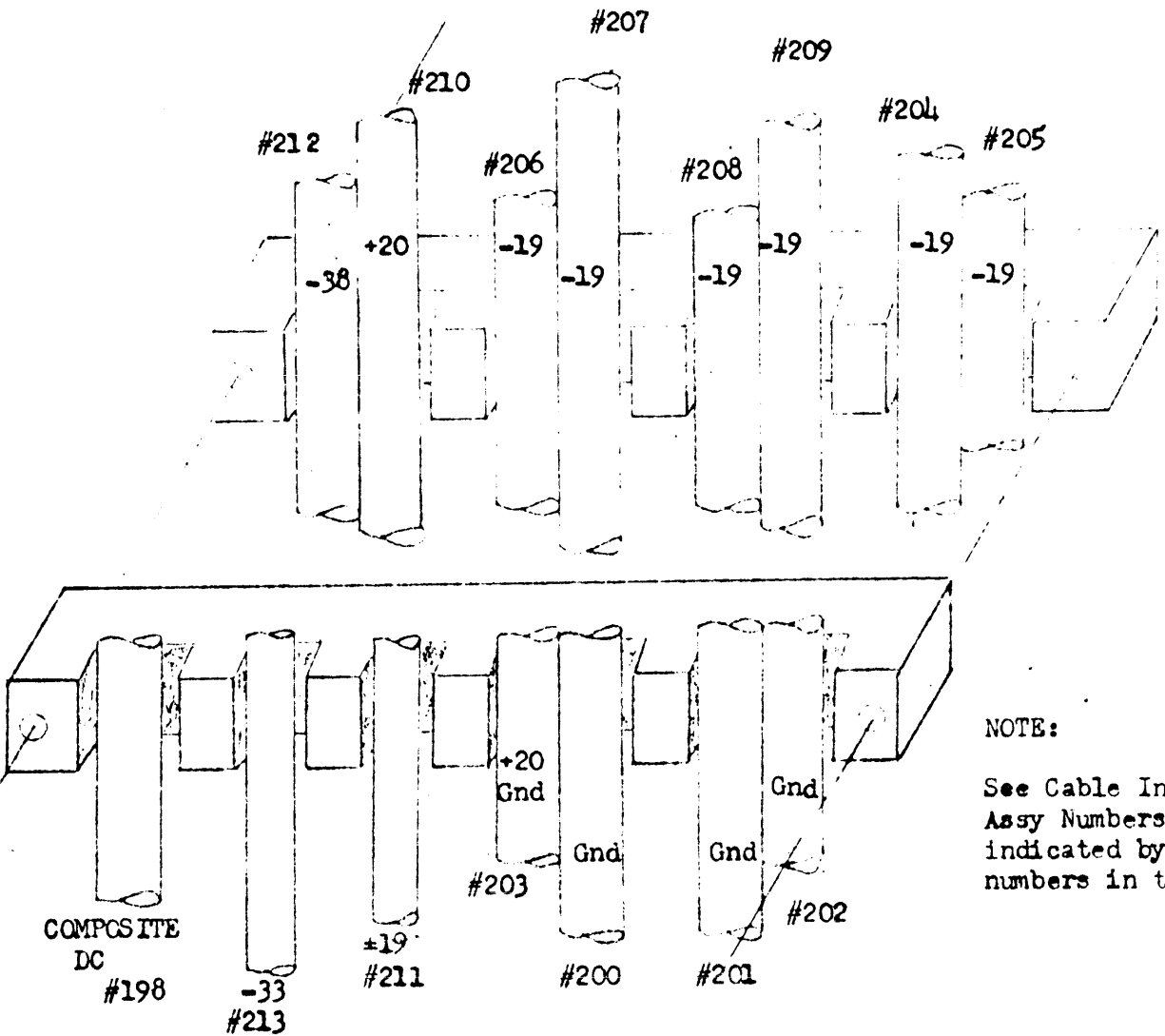

NOTE:
See Cable Index for Ass'y Numbers of cables indicated by identification numbers in the sketch.

REAR VIEW OF D&D "D" RACK CLAMP AREA

FIGURE #7

Burroughs Corporation  ELECTRODATA M & E DIVISION PASADENA CALIFORNIA	PREPARED BY Hausmann	APPROVED F.L. Fox	DWG NO A 11891660	Section II PAGE 47 CONT ON 48	A REV
	CHECKED BY	PROJ ENGR L. Johnson	TITLE B5000 SYSTEM SPECIAL INSTRUCTIONS		
PROPERTY OF BURROUGHS CORPORATION NOT TO BE REPRODUCED NOR USED FOR MANUFACTURING PURPOSES EXCEPT ON BURROUGHS ORDER OR PRIOR WRITTEN CONSENT			TYPED DRAWING FORM		

CLAMPING OF GATE QUAD CABLES:

Reference 11.1

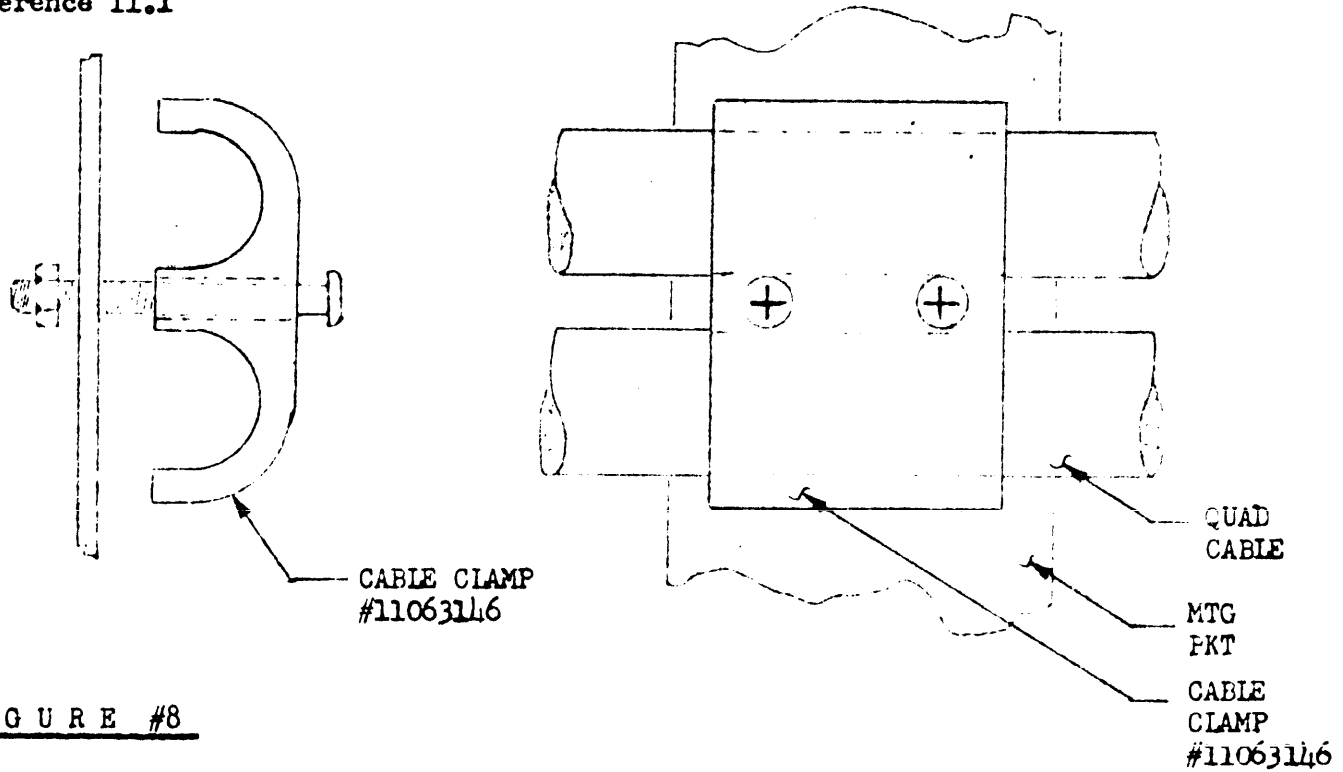

FIGURE #8

ROUTING & SECURING OF CLOCK TYPE CABLES:

Reference 11.2

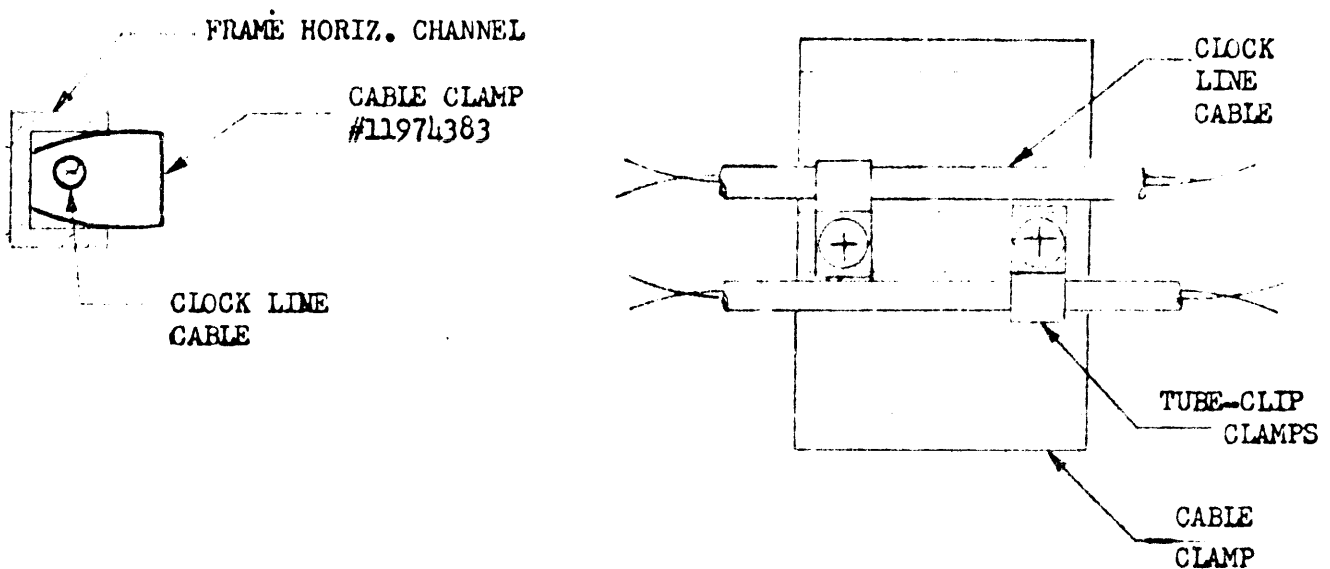



FIGURE #9

FIGURE #9-A

Burroughs Corporation  ELECTRODATA M & E DIVISION PASADENA CALIFORNIA	PREPARED BY Hausmann	APPROVED F. L. Fox	DWG NO A11891660	A REV
	CHECKED BY L. Johnson	PROJ ENGR L. Johnson	Section II PAGE 18 CONT ON 49	
PROPERTY OF BURROUGHS CORPORATION NOT TO BE REPRODUCED NOR USED FOR MANUFACTURING PURPOSES EXCEPT ON BURROUGHS ORDER OR PRIOR WRITTEN CONSENT		TITLE B5000 SYSTEM SPECIAL INSTRUCTIONS TYPED DRAWING FORM		

11.2 (cont'd)

The cables are to be secured at the hinge edge of the gate by means of small tube-clip clamps mounted by utilizing the same screws that secure the signal cable clamps.

11.3 Peripheral Unit Signal Cables on Panels: Figure #10.

The connectors of cables which meet Peripheral I/O cables are stationary and secured to connector panels on the "D" rack of the D & D Unit. This type cable shall be secured by tube-clip type clamps affixed to the connector panel.

11.4 Single Twisted Pair Cables:

Various TP lines, such as Fan AC distribution, are secured within the lengths of their runs by means of small tube-clip clamps applied at mounting hole locations in the panels and frames.

Burroughs Corporation  ELECTRODATA M & E DIVISION PASADENA CALIFORNIA	PREPARED BY Haubmann	APPROVED F.L. Fox	DWG NO A 11891660	Section II PAGE 49 CONT ON 49a
	CHECKED BY L. Johnson	PROJ ENGR L. Johnson	TITLE B5000 SYSTEM SPECIAL INSTRUCTIONS	
PROPERTY OF BURROUGHS CORPORATION NOT TO BE REPRODUCED NOR USED FOR MANUFACTURING PURPOSES EXCEPT ON BURROUGHS ORDER OR PRIOR WRITTEN CONSENT			TYPED DRAWING FORM	

CLAMPING OF PERIPHERAL UNIT INPUT/OUTPUT CABLES:

Reference 11.3

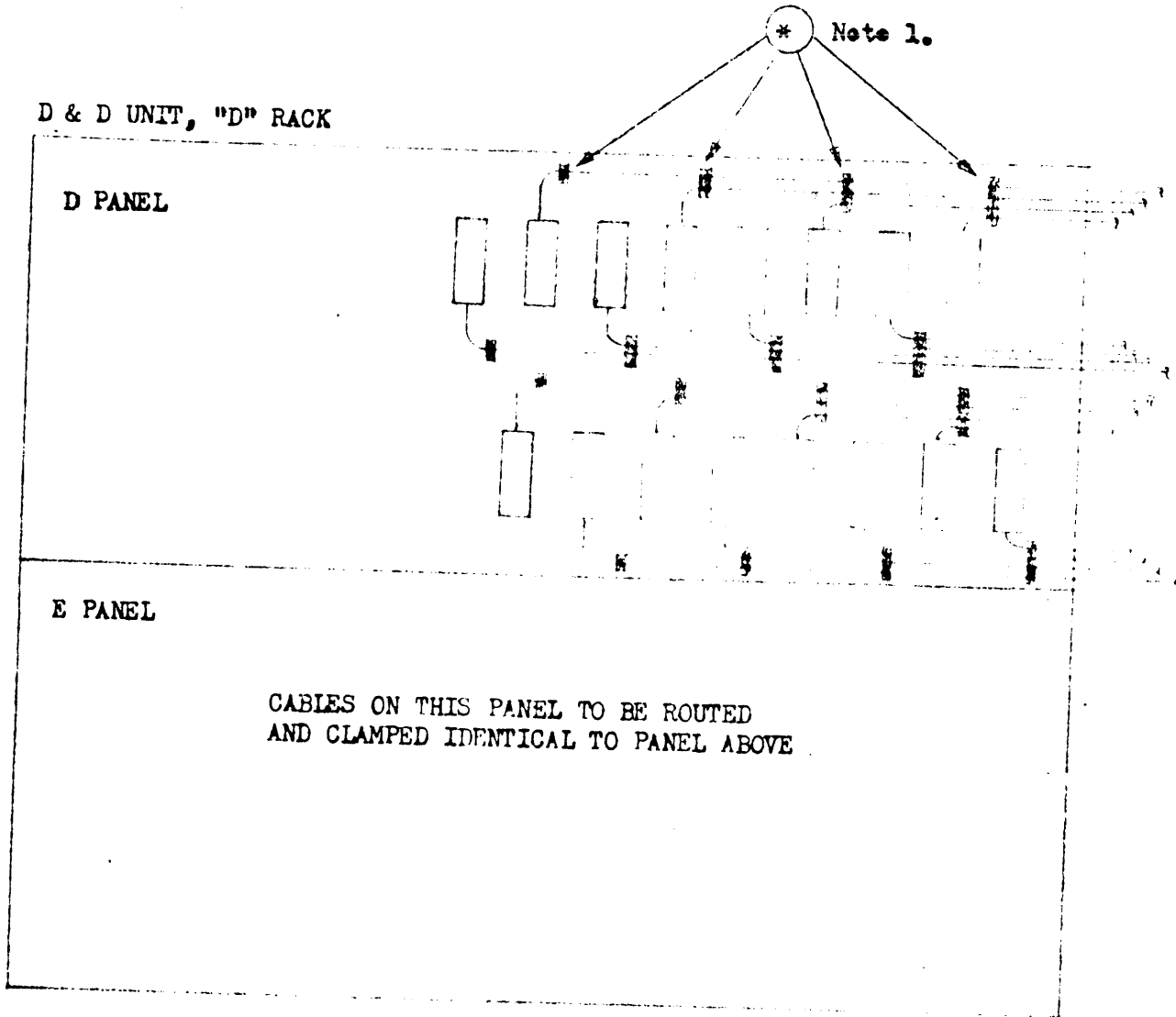

* NOTE 1: TUBE-CLIP TYPE CLAMPS OF VARIOUS SIZES APPEAR ON ENGINEERING PARTS LISTS ON AN "AS REQUIRED" (AR) BASIS.

CORRECT SIZE AND QUANTITY OF CLIPS ARE TO BE CHOSEN ACCORDING TO THE SYSTEM "MIX" OF NECESSARY PERIPHERAL UNITS.

2. THE BREAK OUT OF CABLES, OF ANY PARTICULAR ROW, ALTERNATES FROM TOP TO BOTTOM. THIS LIMITS A POSSIBLE MAXIMUM OF FOUR CABLES UNDER ANY ONE CABLE CLAMP.
3. CABLES ON THE E PANEL ARE BROKEN OUT, ROUTED, AND CLAMPED IN THE SAME MANNER AS INDICATED IN THE ABOVE SKETCH FOR THE D PANEL.

FIGURE #10

Burroughs Corporation  ELECTRODATA M & E DIVISION PASADENA CALIFORNIA	PREPARED BY R. Kaminski/T. Gibson	APPROVED <i>Johnson</i> 10/11/63	DWG NO. A -11891660	C REV
	CHECKED BY <i>R. Gibson</i> 10/9/63	PROJ. ENGR I.C. Johnson	Section II PAGE 49a Cont. 0950	
PROPERTY OF BURROUGHS CORPORATION NOT TO BE REPRODUCED NOR USED FOR MANUFACTURING PURPOSES EXCEPT ON BURROUGHS ORDER OR PRIOR WRITTEN CONSENT		TITLE B 5000 SYSTEM SPECIAL INSTRUCTIONS		
TYPED DRAWING FORM				

PURPOSE/DESCRIPTION: To instruct how certain cables are to be routed and secured on the Memory Subsystem Gate and Core Rack weldment, using the parts contained in the Gate Cable Clamp Kit, PL ND 11112679.

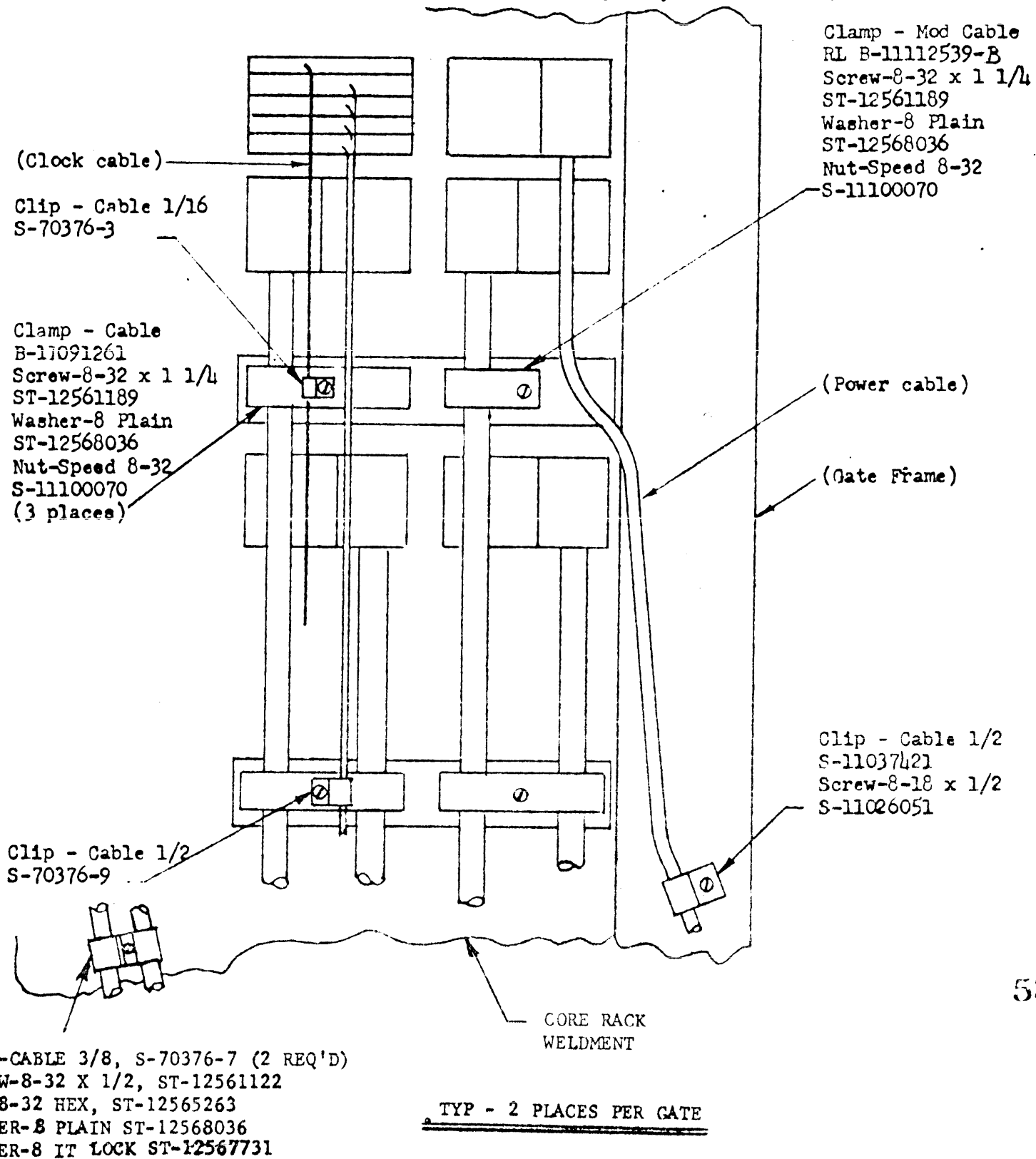



Burroughs Corporation  ELECTRODATA M & E DIVISION PASADENA CALIFORNIA	PREPARED BY Hausmann	APPROVED F. L. Fox	DWG NO A 11891660	 Section III PAGE 50 CONT ON 51
	CHECKED BY .	PROJ ENGR L. Johnson	TITLE B5000 SYSTEM SPECIAL INSTRUCTIONS <small>TYPED DRAWING FORM</small>	
PROPERTY OF BURROUGHS CORPORATION NOT TO BE REPRODUCED NOR USED FOR MANUFACTURING PURPOSES EXCEPT ON BURROUGHS ORDER OR PRIOR WRITTEN CONSENT				

TABLE OF CONTENTS

SECTION III: SPECIAL WIRING & COMPONENT LOCATION

- 1.0 GENERAL
- 2.0 D & D UNIT
 - 2.1 Additional Units
 - 2.1.1 Processor "B"
 - 2.1.2 Core Mem Sub-system #2
 - 2.2 Marginal Voltage Testing
- 3.0 VOLTAGE REGULATOR
 - 3.1 -12V Current Sensing Sensitivity
 - 3.1.1 Core Mem Sub-system
 - 3.1.2 I/O Control Sub-system
- 4.0 CENTRAL CONTROL UNIT
 - 4.1 Cable Bus Plug-ins
 - 4.2 Plug-ins for 4usec Core Memory and 6usec Core Memory
- 5.0 CORE MEMORY SUBSYSTEM
 - 5.1 Package handle instructions.

Burroughs Corporation  ELECTRODATA M & E DIVISION PASADENA CALIFORNIA	PREPARED BY Hausmann	APPROVED F. L. Fox	DWG NO A 11891660	A REV
	CHECKED BY	PROJ ENGR L. Johnson.	Section III PAGE 51 CONT ON 52	
PROPERTY OF BURROUGHS CORPORATION NOT TO BE REPRODUCED NOR USED FOR MANUFACTURING PURPOSES EXCEPT ON BURROUGHS ORDER OR PRIOR WRITTEN CONSENT		TITLE B5000 SYSTEM SPECIAL INSTRUCTIONS TYPED DRAWING FORM		

SECTION III: SPECIAL WIRING & COMPONENT LOCATION

1.0 GENERAL: The B5000 System being modular, minor wiring and component differences exist between systems according to the varying "mix" of Units and/or Sub-systems of a particular system.

The information in this section (Section III) of instructions indicate when and where these differences will occur.

2.0 D & D UNIT

2.1 Additional Processor or Core Memory:

Each D & D Unit is wired for a normal compliment of 1 (one) Processor Unit and 1 (one) Core Memory Sub-system. Certain wires must be removed from the D & D Unit when Processor "B" and/or Core Memory Sub-system #2 are required. Remove wires as follows:

2.1.1 If Processor "B" is required, remove D & D Unit wire from

AF B0 H0 to AF A0 Z0.

2.1.2 If Core Memory S/S #2 is required, remove D & D Unit wire from

AF B0 B2 to AF A0 Z8.

2.2 Marginal Voltage Testing:

When performing marginal voltage test, per SPS #11976586, install a "NO-CUT" diode stick into location AF B4 L9 of the D & D Unit.

DIODE STICK MUST BE REMOVED after completion of testing and prior to resuming of operation.

3.0 VOLTAGE REGULATOR

3.1 To increase the sensitivity in the -12V current sensing circuit of the Voltage Regulator, certain units must have one resistor removed from the circuit as follows:

Burroughs Corporation  ELECTRODATA M & E DIVISION PASADENA CALIFORNIA	PREPARED BY T. J. Jones	APPROVED F. L. Fox	DWG NO A 11891660	C REV
	CHECKED BY	PROJ ENGR L. Johnson	PAGE 52 cont on 52a	
PROPERTY OF BURROUGHS CORPORATION NOT TO BE REPRODUCED NOR USED FOR MANUFACTURING PURPOSES EXCEPT ON BURROUGHS ORDER OR PRIOR WRITTEN CONSENT		TITLE B5000 SYSTEM SPECIAL INSTRUCTIONS TYPED DRAWING FORM		

SECTION III:

3.1 (cont'd)

3.1.1 Core Memory Sub-system Voltage Regulator:

Remove resistor CT K2 from circuit in all Core Memory Sub-systems.

(Disconnect and tape at terminal A1.)

3.1.2 I/O Control Subsystem Voltage Regulator:

Remove resistor CT K2 from circuit in any I/O Control Subsystem having only 1 (one) I/O Control Unit installed. Resistor should not be removed in subsystems having I/O-2, I/O-3, or I/O-4 installed.

THE RESISTOR MUST BE REINSTALLED INTO ANY ONE UNIT SUBSYSTEM HAVING ADDITIONAL I/O UNITS INSTALLED IN THE FIELD.

4.0 CENTRAL CONTROL UNIT:

4.1 I/O Cable Bus Plug-ins #11986965, must be installed in any Central Control Unit employed in a system having less than a full compliment of 4 (four) I/O Control Units as follows:

<u>I/O UNIT NOT IN "MIX"</u>	<u>CC LOCATION OF CABLE BUS</u>
I/O-2	EC BO N2
I/O-3	EC CO N2
I/O-4	EC DO N2

Burroughs Corporation  ELECTRODATA M & E DIVISION PASADENA CALIFORNIA	PREPARED BY T. J. Jones	APPROVED F.L. Fox	DWG NO A 11891660	A REV
	CHECKED BY	PROJ ENGR L. Johnson	PAGE 52a cont on 53	
PROPERTY OF BURROUGHS CORPORATION NOT TO BE REPRODUCED NOR USED FOR MANUFACTURING PURPOSES EXCEPT ON BURROUGHS ORDER OR PRIOR WRITTEN CONSENT		TITLE B5000 SYSTEM SPECIAL INSTRUCTIONS		
TYPED DRAWING FORM				

4.0 CENTRAL CONTROL UNIT: (cont'd)



4.2 Plug-ins for 4usec Core Memory or 6usec Core Memory:

The following Diode Stick Part Numbers should be used when System is employing either a 4usec or 6usec Core Memory Unit:

LOCATION	PART NUMBER FOR 4usec CORE MEMORY	PART NUMBER FOR 6usec CORE MEMORY
AA A8 Y7	80188-29	80188-33
AA B8 Y7	80188-29	80188-33
AA C8 Y7	80188-29	80188-33
AA D8 Y7	80188-29	80188-33
AB A2 Y2	80188-29	80188-33
AB B2 Y2	80188-29	80188-33
AB C2 Y2	80188-29	80188-33
AB D2 Y2	80188-29	80188-33

5.0 CORE MEMORY SUBSYSTEM



5.1 To prevent interference between packages located on the Voltage Regulator and the bus bar plastic cover mounted on the rear gate (Memory Module "O"), remove the HANDLES from packages in locations CTN1A2, CTN1A7, and CTN1N2 of the Voltage Regulator.

Burroughs Corporation  ELECTRODATA M & E DIVISION PASADENA CALIFORNIA	PREPARED BY Hausmann	APPROVED F. L. Fox	DWG NO A 11891660	
	CHECKED BY 	PROJ ENGR L. Johnson	Section IV PAGE 53 CONT ON 54	
PROPERTY OF BURROUGHS CORPORATION NOT TO BE REPRODUCED NOR USED FOR MANUFACTURING PURPOSES EXCEPT ON BURROUGHS ORDER OR PRIOR WRITTEN CONSENT		TITLE B5000 SYSTEM SPECIAL INSTRUCTIONS TYPED DRAWING FORM		

T A B L E O F C O N T E N T S

SECTION IV: ADJUSTMENTS AND LUBRICATION:

- 1.0 GENERAL
- 2.0 ELECTRICAL ADJUSTMENTS
 - 2.1 Input/Output Control Unit
 - 2.2 Central Control Unit
 - 2.3 Operator's Console Unit
 - 2.4 Core Memory Unit
 - 2.5 Drum Memory Unit
 - 2.6 Display & Distribution Unit
 - 2.7 Power Supply Unit
 - 2.8 Processor Unit
 - 2.9 Peripheral Units
- 3.0 MECHANICAL ADJUSTMENTS
- 4.0 LUBRICATION
 - 4.1 Muffin Fans

Burroughs Corporation  ELECTRODATA M & E DIVISION PASADENA CALIFORNIA	PREPARED BY T. J. Jones	APPROVED F. L. Fox	DWG. NO. A 11891660	 Section IV PAGE 54 cont on 55
	CHECKED BY	PROJ ENGR L. Johnson	TITLE B5000 SYSTEM SPECIAL INSTRUCTIONS	
PROPERTY OF BURROUGHS CORPORATION NOT TO BE REPRODUCED NOR USED FOR MANUFACTURING PURPOSES EXCEPT ON BURROUGHS ORDER OR PRIOR WRITTEN CONSENT			TYPED DRAWING FORM	

SECTION IV: ADJUSTMENTS

1.0 GENERAL

This section (Section IV) is concerned with the manual adjustment of elec/mech components and mechanical lubrication by Test & Field personnel.



2.0 ELECTRICAL ADJUSTMENTS:

2.1 Input/Output Control Unit:

Adjust the Multis and Delay Multis in the I/O Units as follows:

<u>Location</u>	<u>Timing</u>	<u>Logic Name</u>	<u>DA Type</u>
ADBOA2*	6.6 \pm .5 Millisec	BTDM	MM N
ABB4A7	6.6 \pm .3 Millisec	BRIM	DM J
ABB6N2	200 \pm 10 microsec	BWIM	MU I
ABB2N2	96 \pm 5 microsec	BFIM	MU H
ABB4A2	250 \pm 10 microsec	BF2M	MU I
AAB7N2	6.0 $\begin{smallmatrix} +0 \\ - .6 \end{smallmatrix}$ microsec	DSL1M	MU F
AAB7A2	17 \pm 1 microsec	DS2M	MU G
AAB6A2	35 $\begin{smallmatrix} + 1 \\ - 3 \end{smallmatrix}$ microsec	IM1M	DU E
AAB6A7	85 \pm 5 microsec	IM2M	DU F
AAB8N2	15 \pm 1 Millisec	LP1M	MM S
AAB8A2	300 \pm 15 microsec	LP1M	MU I
AAB9A2	850 \pm 40 microsec	LP2M	MU J
AAB4A2	67 \pm 3 Millisec	WGBM	MM O
AAB4N2	4.4 \pm .3 Millisec	WGNM	MM N
AAA9N7	21 microsec	LD1M	DU E
ABA0N2	60 microsec	LD2M	DU F

* BTDM is set at 6.6 Millisec for operation with 120 ips TTU's. BTDM is set at 7.8 \pm .5 Millisec if I/O is operating 1 or more 83 ips TTU's.

Burroughs Corporation  ELECTRODATA M & E DIVISION PASADENA CALIFORNIA	PREPARED BY Hausmann	APPROVED F. L. Fox	DWG NO A 11891660	
	CHECKED BY 	PROJ ENGR L. Johnson	Section IV PAGE 55 CONT ON 56	
PROPERTY OF BURROUGHS CORPORATION NOT TO BE REPRODUCED NOR USED FOR MANUFACTURING PURPOSES EXCEPT ON BURROUGHS ORDER OR PRIOR WRITTEN CONSENT		TITLE B5000 SYSTEM SPECIAL INSTRUCTIONS TYPED DRAWING FORM		

SECTION IV:
2.0 (cont'd)

2.2 Central Control Unit:

Adjust the Multis and Delay Multi in the Central Control Unit as follows:

<u>LOCATION</u>	<u>TIMING</u>	<u>LOGIC NAME</u>	<u>DA TYPE</u>
EA D5 A7	55.0 ₋ +10.0 millisecs	SCMM	MM O
EA B6 N7	10.0 ₋ + 2.0 millisecs	LOAY	DM J
EA B7 N2	12.0 ₋ + 2.0 millisecs	60CM	MM S

2.3 Operator's Console Unit:

Adjust the Multis and Delay Multis in the Operator's Console as follows:

<u>LOCATION</u>	<u>TIMING</u>	<u>LOGIC NAME</u>	<u>DA TYPE</u>
AA A4 A7	100.0 ₋ + 3.0 millisecs	TMOM	MTYB
AA A3 A7	30.0 ₋ + 3.0 millisecs	KITM	MTYA
AA A5 A7	30.0 ₋ +10.0 5.0 millisecs	TODM	DM K
AA A4 N7	40.0 ₋ +10.0 0 millisecs	KBJM'	DM K

2.4 Core Memory Unit:

Manual adjustment and timings for components of this Unit are included in the TFR Documents of each Core Memory Unit.

2.5 Drum Memory Unit:

Manual adjustemnt and timings for components of this Unit are included in the TFR Documents of each Drum Memory Unit.

Burroughs Corporation  ELECTRODATA M & E DIVISION PASADENA CALIFORNIA	PREPARED BY Hausmann	APPROVED F. L. Fox	DWG NO A 11891660	Section IV PAGE 56 CONT ON 57	A REV
	CHECKED BY	PROJ ENGR L. Johnson	TITLE B5000 SYSTEM SPECIAL INSTRUCTIONS TYPED DRAWING FORM		
PROPERTY OF BURROUGHS CORPORATION NOT TO BE REPRODUCED NOR USED FOR MANUFACTURING PURPOSES EXCEPT ON BURROUGHS ORDER OR PRIOR WRITTEN CONSENT					

SECTION IV:

2.0 (cont'd)

2.6 Display & Distribution Unit:

Adjust the (-9)VR output of the voltage reference package in the voltage sensing area of the D & D Unit as follows:

<u>LOCATION</u>	<u>OUTPUT</u>	<u>LOGIC NAME</u>	<u>DA TYPE</u>
AE B3 A7	-9V +1%	(-9)RV	VR P

2.7 Power Supply Unit:

Necessary manual adjustments are included in the Standard Performance Specification, #11944469, of the Power Supply Unit.

2.8 Processor Unit:

No manual electrical adjustments necessary.

2.9 Peripheral Units:

Electrical adjustments necessary in peripheral gear such as printers, punches, tape units, etc., will be included in the TFR Documents of those units.

3.0 MECHANICAL ADJUSTMENTS:

The necessary adjustment and timings for all electro-mechanical peripheral units will be included in the TFR Documents and Field Manuals of those units.

Burroughs Corporation  ELECTRODATA M & E DIVISION PASADENA CALIFORNIA PROPERTY OF BURROUGHS CORPORATION NOT TO BE REPRODUCED NOR USED FOR MANUFACTURING PURPOSES EXCEPT ON BURROUGHS ORDER OR PRIOR WRITTEN CONSENT	PREPARED BY Hausmann	APPROVED F. L. Fox	DWG NO A 11891660	A REV
	CHECKED BY	PROJ ENGR L. Johnson	Section IV PAGE 57 CONT ON F	
		TITLE B5000 SYSTEM SPECIAL INSTRUCTIONS TYPED DRAWING FORM		

SECTION IV:

4.0 LUBRICATION:

4.1 Muffin Fans:

The Muffin Fans in the various Units of the B5000 must be lubricated at six month intervals to prevent binding and bearing wear.

Special Oil Injector, #11838588, must be used to apply light oil, #11838596, thru the self-sealing rubber cap located on the air-flow side of the fan as follows:

- a. Remove cap from OIL INJECTOR and remove excess air by holding the needle up and pressing the plunger.
- b. Place the Injector needle at the center of the rubber cap and pierce the cap at a 45° angle to a depth of $\frac{1}{4}$ inch.
Some of the later model fans have a VENDOR label over the rubber cap. The injector needle should enter the letter "O" in the word "OIL" printed on this label.
- c. Depress the plunger to allow approximately 1/16 inch of oil to flow into the oil chamber. Rotate the fan while depressing plunger.

Fans in the Power Supply and on the Voltage Regulator are mounted on hinged assemblies. These assemblies may be pivoted on their hinges to allow access to the rubber cap area of the individual fans. Access may be gained to the fans in the top panel of each cabinet by removing the grille frame and screen of each fan from the Top surface of the top panel assemblies.