

# 160 COMPUTER

*Programming Manual*

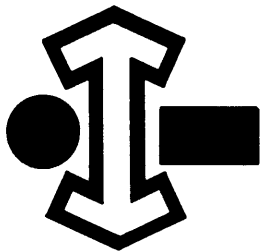

CONTROL DATA CORPORATION

# 160 COMPUTER

*Programming Manual*

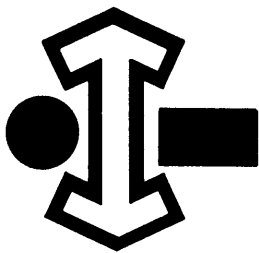

CONTROL DATA CORPORATION

Publication No. 023a

## CONTENTS

	page
INTRODUCTION	1
GENERAL DESCRIPTION	2
INSTRUCTION REPERTOIRE	6
INPUT-OUTPUT	7
MACHINE ORGANIZATION	29
PROGRAMMING	42

## LIST OF FIGURES

### Figure No.

1	Instruction Word	2
2	Punched Paper Tape Levels	11
3	Ferranti Reader Head Side View	13
4	BRPE Punch	17
5	Physical Layout of Tape	19
6	Magnetic Tape Control Panel	24
7	Tape at Unload Position	27
8	Block Diagram	30
9	Typical Instruction Composition	31
10	Console Display Panel and Switches	37

## LIST OF TABLES

### Table No.

1	Instructions	4
2	Typewriter Codes	14
3	Magnetic Tape Control Panel	24
4	Steps in Executing Instructions	40



The Model 160 Electronic Data Processing Computer.

## INTRODUCTION

The Model 160 Electronic Data Processing Computer is a small, highly flexible, multipurpose, stored program device with data processing capabilities equal to that of many large-scale computers. The large (4,096 12-bit words) magnetic core memory with its high operating speed (60,000 instructions per second) makes the Model 160 a powerful data processing tool. The 160 has a full complement of logical and decision-making instructions, and uses single-address logic for most cases. Multiply and divide instructions are not included as such but these operations may be obtained by proper programming.

A 350-character-per-second Ferranti photoelectric reader for punched paper tape, and a Teletype Corporation Model BRPE paper tape punch (~~60~~<sup>110</sup> frames per second) are supplied as standard equipment. Optional input-output equipment includes:

- 1) up to four Ampex Model FR400 (or FR300) magnetic tape handlers with input-output rates of 15,000 and 30,000 6-bit characters per second, respectively
- 2) an 80-column punched card reader
- 3) an 80-column card punch
- 4) a line printer
- 5) a Soroban-modified IBM electric typewriter
- 6) a digital communications line buffer

## GENERAL DESCRIPTION

The Model 160 is a parallel, single-address computer. Its 4,096 12-bit word memory has a storage cycle time of 6.4 microseconds. Instructions require from one to four cycles and thus range in execution times from 6.4 to 25.6 microseconds; average execution time for an entire program is approximately 15 microseconds per instruction.

Operation of the computer is controlled by an internally stored program of single-address instructions located in sequential storage locations. These instructions operate on two major internal registers, A and P, each capable of handling 12 bits of information.

### REGISTERS

The A register contains the results of all arithmetic and logical operations and contains one operand. It is used as a 12-bit subtractive accumulator and performs arithmetic modulus  $2^{12}-1$ .

The P register contains the address of the current instruction. Prior to reading the next instruction, a "1" is added to the contents of P in order to select the address of the instruction; the jump address is inserted in P for the same reason.

### INSTRUCTIONS

The instruction word (figure 1) is divided into a 6-bit function code (F) and a 6-bit execution address (E). The function code is held in the most significant 6 bits of the instruction word; the least-significant 6 bits are reserved for E.

The function code determines which of the 62 possible instructions (table 1) will be performed. These 62 instructions are variations of the 20 basic operations available on the computer. These operations are: shift, logical product, logical sum, load, load complement, add, subtract, store, shift replace, replace add, replace add one, zero jump, non-zero jump, positive jump, negative jump, unconditional jump, input, output,



Figure 1. Instruction Word.

external function and stop. (A jump causes a new sequence of instructions to be executed starting at the jump address. The jump address in the 60-63 instruction is obtained as  $P + E$ ; in the 64-67 instruction the address is obtained as  $P - E$ .)

The 6-bit execution address ( $E$ ) is used to refer to: (1) one of the 63 locations preceding the current instruction; (2) one of the 63 locations following the current instruction; (3) one of the first 64 storage locations. Any of the locations referred to above may contain a 12-bit operand or, in cases 2 and 3, another 12-bit address (the indirect address). In the no address mode,  $E$  is used as an operand.

### ADDRESSING MODES

Depending on the instruction code, the execution address  $E$  is used for 6 different modes, referred to as  $n$ ,  $d$ ,  $i$ ,  $f$ ,  $b$  and  $fi$ .

No Address (n)	$E$ is used as the lower 6 bits of a 12-bit operand, the upper 6 bits being zeros. No storage reference is made.
Direct Address (d)	$E$ is used to address one of the first 64 storage locations from which a 12-bit operand is obtained.
Indirect Address (i)	$E$ is used to address one of the first 64 storage locations. The 12-bit contents of that location represent another address within storage. This latter address contains the 12-bit operand to be used by the instruction.
Relative Address Forward (f)	$E$ is added to the contents of $P$ . The sum specifies a new address where the operand to be used by the current instruction will be found.
Relative Address Backward (b)	$E$ is subtracted from the contents of $P$ . The resultant difference specifies a new address where the operand to be used by the current instruction will be found; this new address cannot be further than 63 locations from the current instruction. $P$ is unchanged.
Relative Forward Indirect Address (fi)	$E$ is added to the contents of $P$ in order to specify one of the 63 locations immediately following the current instruction address; the 12-bit contents of that location are used to address an operand anywhere on storage. $P$ is unchanged.

TABLE 1. INSTRUCTIONS

MNEMONIC & OCTAL CODE		NAME	ADDRESS MODE	EXECUTION TIME μSEC	COMMENTS
ERR	00	Error		6.4	Stop operation. On pressing RUN switch, next instruction will be executed.
HLT	77	Halt		6.4	
SHA	01	Shift A	(n)	6.4	Shift A depends on value of E for its action. Three possibilities: 0102 Shift the contents of A left end-around 1 binary position. 0110 Shift the contents of A left end-around 3 binary positions. 0112 Multiply the contents of A by octal 12 (decimal 10).
LPN	02	Logical Product	(n)	6.4	Form in A the logical product of original contents of A and operand. Logical product is formed for each bit of A as follows: Original contents of A      0 0 1 1 Operand                      0 1 0 1 Logical product              0 0 0 1
LPD	10		(d)	12.8	
LPI	11		(i)	19.2	
LPF	12		(f)	12.8	
LPB	13		(b)	12.8	
LSN	03	Logical Sum	(n)	6.4	Form in A the logical sum of original contents of A and operand. Logical sum is formed for each bit of A as follows: Original contents of A      0 0 1 1 Operand                      0 1 0 1 Logical sum                  0 1 1 0
LSD	14		(d)	12.8	
LSI	15		(i)	19.2	
LSF	16		(f)	12.8	
LSB	17		(b)	12.8	
LDN	04	Load	(n)	6.4	Replace contents of A with operand.
LDD	20		(d)	12.8	
LDI	21		(i)	19.2	
LDF	22		(f)	12.8	
LDB	23		(b)	12.8	
LCN	05	Load Complement	(n)	6.4	Replace contents of A with one's complement of operand. The one's complement is obtained by replacing each bit of operand with its opposite, that is, replacing "1" with "0" and "0" with "1".
LCD	24		(d)	12.8	
LCI	25		(i)	19.2	
LCF	26		(f)	12.8	
LCB	27		(b)	12.8	
ADN	06	Add	(n)	6.4	Form in A the sum, modulus $2^{12}-1$ , of original contents of A and operand.
ADD	30		(d)	12.8	
ADI	31		(i)	19.2	
ADF	32		(f)	12.8	
ADB	33		(b)	12.8	
SBN	07	Subtract	(n)	6.4	Form in A the difference, modulus $2^{12}-1$ , of original contents of A minus operand.
SBD	34		(d)	12.8	
SBI	35		(i)	19.2	
SBF	36		(f)	12.8	
SBB	37		(b)	12.8	
STD	40	Store	(d)	19.2	Replace operand with contents of A, which remain unchanged.
STI	41		(i)	25.6	
STF	42		(f)	19.2	
STB	43		(b)	19.2	
SRD	44	Shift Replace	(d)	19.2	Form in A the value of operand shifted left end-around one bit position. Replace operand with result.
SRI	45		(i)	25.6	
SRF	46		(f)	19.2	
SRB	47		(b)	19.2	



TABLE 1. (CONT'D.)

MNEMONIC & OCTAL CODE		NAME	ADDRESS MODE	EXECUTION TIME μSEC	COMMENTS
RAD	50	Replace Add	(d)	19.2	Form in A the sum, modulus $2^{12}-1$ , of original contents of A and operand. Replace operand with result.
RAI	51		(i)	25.6	
RAF	52		(f)	19.2	
RAB	53		(b)	19.2	
AOD	54	Replace Add One	(d)	19.2	Form in A the sum, modulus $2^{12}-1$ , of operand and one. Replace operand with result.
AOI	55		(i)	25.6	
AOF	56		(f)	19.2	
AOB	57		(b)	19.2	
ZJF	60	Zero Jump	(f)	6.4	If A contains all zeros, jump; otherwise obtain next instruction from next sequential storage location.
ZJB	64		(b)	6.4	
NZF	61	Non-Zero Jump	(f)	6.4	If A does not contain all zeros, jump; otherwise, obtain next instruction from next sequential storage location.
NZB	65		(b)	6.4	
PJF	62	Positive	(f)	6.4	If A is positive (leftmost bit is "0"), jump; otherwise, obtain next instruction from next sequential storage location.
PJB	66		(b)	6.4	
NJF	63	Negative Jump	(f)	6.4	If A is negative (leftmost bit is "1"), jump; otherwise, obtain next instruction from next sequential storage location.
NJB	67		(b)	6.4	
JPI	70	Jump Indirect	(i)	12.8	Obtain next instruction from location specified by contents of E, which designates one of the first 64 storage addresses.
JFI	71	Jump For- ward Indirect	(fi)	12.8	Obtain next instruction from location specified by contents of address located E positions following current instruction address (E + P).
INP	72	Input	(fi)	12.8 + 12.8n	Read from selected input device successive units of information into storage in sequential locations beginning with the starting address and running up to but not including the terminating address. * Obtain next instruction from storage address 2 positions following input instruction. The latter is terminated upon filling the specified storage area or upon receiving an External Disconnect from input device. On termination, A contains the address of storage location 1 position following last unit of input data stored.
OUT	73	Output	(fi)	12.8 + 12.8n	Transmit to selected output device words of information from storage beginning at starting address and continuing up to but not including the terminating address. * Obtain next instruction from storage location 2 positions following output instruction. Upon completion, A will contain terminating address.
OTN	74	Output Direct	(n)	6.4	Transmit lower 6 bits (E) of this instruction to selected output device. If more than 6 bits are used by output equipment other bits will be zero.
EXF	75	External Function	(f)	12.8	Transmit external function code to external equipment. The code is specified by contents of storage location E positions following external function instruction.
INA	76	Input to A	(n)	6.4	Read into A one frame of data from select input device, clearing previous contents of A.
					*The starting address is E positions following the current instruction address; the terminating address follows immediately after the current instruction address.

## INSTRUCTION REPERTOIRE

CODES	NAME	STORAGE CYCLE & ADDRESS MODE	CODES	NAME	STORAGE CYCLE & ADDRESS MODE
ERR 00	Error	1	STD 40	Store	3 (d)
SHA 01	Shift A	1 (n)	STI 41		4 (i)
LPN 02	Logical Product	1 (n)	STF 42		3 (f)
LSN 03	Logical Sum	1 (n)	STB 43		3 (b)
LDN 04	Load	1 (n)	SRD 44	Shift Replace	3 (d)
LCN 05	Load Complement	1 (n)	SRI 45		4 (i)
ADN 06	Add	1 (n)	SRF 46		3 (f)
SBN 07	Subtract	1 (n)	SRB 47		3 (b)
LPD 10	Logical Product	2 (d)	RAD 50	Replace Add	3 (d)
LPI 11		3 (i)	RAI 51		4 (i)
LPF 12		2 (f)	RAF 52		3 (f)
LPB 13		2 (b)	RAB 53		3 (b)
LSD 14	Logical Sum	2 (d)	AOD 54	Replace Add One	3 (d)
LSI 15		3 (i)	AOI 55		4 (i)
LSP 16		2 (f)	AOF 56		3 (f)
LSB 17		2 (b)	AOB 57		3 (b)
LDD 20	Load	2 (d)	ZJF 60	Zero Jump	1 (f)
LDI 21		3 (i)	NZF 61	Non-Zero Jump	1 (f)
LDF 22		2 (f)	PJF 62	Positive Jump	1 (f)
LDB 23		2 (b)	NJF 63	Negative Jump	1 (f)
LCD 24	Load Complement	2 (d)	ZJB 64	Zero Jump	1 (b)
LCI 25		3 (i)	NZB 65	Non-Zero Jump	1 (b)
LCF 26		2 (f)	PJB 66	Positive Jump	1 (b)
LCB 27		2 (b)	NJB 67	Negative Jump	1 (b)
ADD 30	Add	2 (d)	JPI 70	Indirect Jump	1 (d)
ADI 31		3 (i)	JFI 71	Indirect Jump	2 (f)
ADF 32		2 (f)	INP 72	Input	2 + 2n (f)
ADB 33		2 (b)	OUT 73	Output	2 + 2n (f)
SBD 34	Subtract	2 (d)	OTN 74	Output	1 (n)
SBI 35		3 (i)	EXF 75	External Function	2 (f)
SBF 36		2 (f)	INA 76	Input to A	1 (n)
SBB 37		2 (b)	HLT 77	Halt	1

## INPUT-OUTPUT

Peripheral equipment is connected to the computer via the input-output cable, which consists of 12 input lines, 12 output lines, and several control lines including external function ready, input request and output ready.

The 12 output lines are dual-purpose. They carry up to 12 bits of output information from the computer to the external device; they also carry external function information to the control unit of the peripheral equipment. The type of information on the output lines is determined by an accompanying signal that also appears on the output ready or the external function ready line.

The 12 input lines are also dual-purpose. Normally they carry up to 12 bits of input information from the external device to the computer. After a status request external function, the input lines carry 12 bits of status information, which is read into the computer by an input instruction. Status information is identified by the fact that it is the first information read in by an input instruction after a status request.

The computer will perform only one assigned operation (compute, input or output) at a time. Thus both the input and output lines may terminate in the main switching register, Z.

The five instructions concerned with input and output operations are 72, 73, 74, 75 and 76. The 75 (EXF) instruction signals the appropriate peripheral device to connect to the input or output lines. The 72 (INP), 73 (OUT), 74 (OTN) or 76 (INA) instructions transfer the data. On paper tape and other non-block-transfer devices once an input or output selection has been made by the EXF instruction any number of successive inputs or outputs may be made without another EXF. Any time a change is made from input to output or vice versa, or whenever a change of equipment is made, an EXF instruction must precede the input or output instruction. An EXF must also precede each input or output operation of a block-transfer device, such as magnetic tape or punched card equipment.

## OPERATION OF INPUT-OUTPUT INSTRUCTIONS

### INP (72) Input

The sequenced input instruction goes through the following steps:

- 1) P is added to E to specify the location of the starting address; P remains unchanged.
- 2) The starting address is read into A.
- 3) P is increased by one in order to specify the location of the terminating address.
- 4) Data is read from the input device and stored at the address specified by A.
- 5) The contents of A are increased by one.
- 6) The contents of A are compared with the contents of the location specified by P (terminating address).
- 7) If the contents of the location specified by P are not equal to A, steps 4 through 7 are repeated; if equal, the next instruction is read.

### OUT (73) Output

The sequenced output instruction goes through the following steps:

- 1) P is added to E to specify the location of the starting address; P remains unchanged.
- 2) The starting address is read into A.
- 3) P is increased by one in order to specify the location of the terminating address.
- 4) Output data is obtained from the address specified by A and is sent to the output device.
- 5) The contents of A are increased by one.
- 6) The contents of A are compared with the contents of the location specified by P (terminating address).
- 7) If the contents of the location specified by P are not equal to A, steps 4 through 7 are repeated; if it is equal, the next instruction is read.

OTN (74) Output Direct

Send a 12-bit output word to the output device. The word consists of 6 higher-order zeros and the 6-bit value of E from the OTN instruction.

INA (76) Input to A

Clear A. Read a 12-bit word from the selected input device and place in A.

EXF (75) External Function

The External Function instruction places a 12-bit code on the output lines and places a signal on the external function ready line. Upon receiving this signal, all external devices examine the code contained on the output lines. If a device recognizes its external function code, it sends an acknowledgment (resume signal) to the computer, which then proceeds to the next instruction. If no external unit sends back a resume, the computer will stop and display a SEL signal on the console.

External Function Codes

The 12-bit external function code is divided into a 6-bit unit designator (upper 6 bits) and a function designator. The unit designators, in octal notation, are:

03XX card punch and reader	11XX magnetic tape control unit 1
41XX paper tape reader and punch	12XX magnetic tape control unit 2
42XX typewriter	

The codes (including function designators) are listed below in detail.

#### Card Punch and Reader

0301 read station A	0305 punch and read A
0302 read station B	0306 punch and read B
0303 read stations A and B	0307 punch and read A and B
0304 punch	0340 request status

#### Magnetic Tape Control Units

The two tape control units can each handle up to 4 tapes. The tape codes are similar, regardless of the number of the tape unit which is activated. For this reason, the fourth character (unit designator) is represented by an X.

111X write	115X rewind unload
113X read forward	114X request tape status
112X backspace	1172 select even parity (BCD)
116X rewind	1171 select odd parity (binary)

Low-Speed Equipment

4102 select photoelectric reader	4210 select typewriter output
4104 select high-speed punch output	4220 select typewriter keyboard input
4240 request typewriter status	

Status Request Response

When a status request is issued, the program must also issue an input instruction to read the response into the computer. The response is a 12-bit number with various interpretations. For the request 0340 (card reader or punch), for example, the equipment may respond with any or all of the following codes:

0400 no card in magazine	2000 failed to feed card
1000 card stacker full	4000 not ready

For a request (114X or 124X) to a magnetic tape control unit, the interrogated unit may respond with any or all of these codes:

0001 even parity (BCD)	0010 illegal BCD
0002 not ready	0020 end-of-file mark read
0004 parity error in last operation	0040 end of tape

For the request 4240 to the typewriter, the equipment may respond with the following:  
0010 typewriter not in computer mode

If more than one code response is made, the resultant code recognized is the sum of the transmitted codes. For example, if the magnetic tape unit makes the following responses:

0004	000	000	000	100
0020	000	000	010	000
0040	000	000	<u>100</u>	<u>000</u>
	<u>000</u>	<u>000</u>	<u>110</u>	<u>100</u>
	0	0	6	4

The resulting code is 0064, which must be analyzed by the program in order to determine which codes it is composed of and which conditions exist in the interrogated unit.

### INPUT-OUTPUT EQUIPMENT

Up to five external input-output control units may be attached to the standard computer. The reader and punch are located in the computer and are not considered external equipment. A number of devices may be attached to a control unit, such as up to four tape handlers for each tape control unit.

#### Ferranti Photoelectric Punched Paper Tape Reader

The Ferranti photoelectric punched paper tape reader is located in the top of the computer desk to the right of the control panel. It will read 5-, 6- or 7-level punched paper tape at a rate of up to 350 frames per second.

Operating Instructions. The 7-level punched paper tape consists of seven information levels and one sprocket (or feed) hole level. The levels are numbered as shown in figure 2. The seven levels of tape read will appear in bits 6 through 0 of core storage as levels 7 6 5 4 3 2 1.

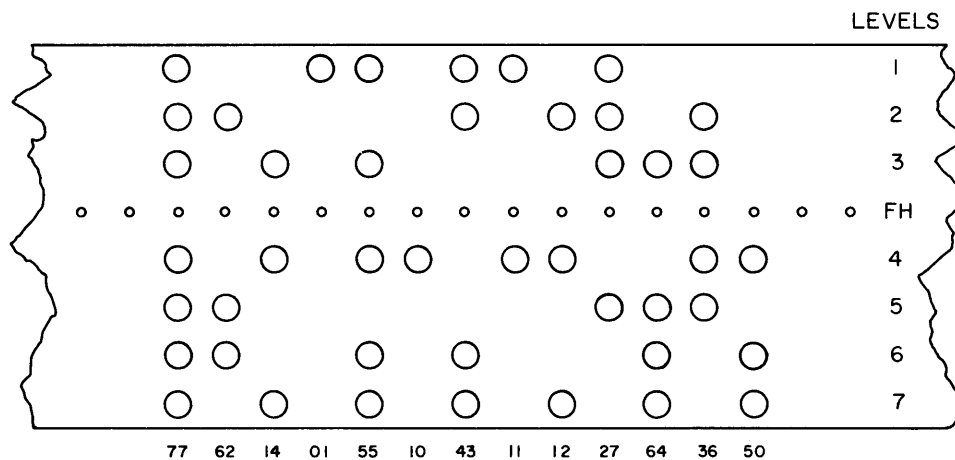

Figure 2. Punched Paper Tape Levels.

In the side view of the tape reading head shown in figure 3, the tape travels from right to left. To load tape, release the tape hold-down lever by turning it counterclockwise. Insert the tape in the reading head with the seventh level of tape toward the open side. Make sure that the tape is inside of the tape guide and has a leader which is long enough to fit between the drive roll and the drive pressure roll. Lock the tape in the reader by turning the tape hold-down lever in a clockwise direction until a click is heard, signifying that the tape is locked in.

Positioning of Tape. When initially inserting tape, the first frame of information to be read is the frame directly over the photo cell slot under the lens. During operation the tape will stop on the next frame to be read, or in the space before that frame.

Operation with the Computer. The external function 4102 must be issued by the computer prior to reading information under program control. This causes the reader to be connected to the input line for input operation. The selection is held until some other input or output device is used.

#### Typewriter

A Soroban-modified IBM electric typewriter is optional equipment with the computer. The typewriter is mounted on a separate typing desk with its control and power supply housed inside the desk, and is connected to the computer via the input-output cable. The typewriter will accept input information at normal typing speeds and will print output from the computer at a rate of 10 to 12 characters per second.

Operating Instructions. Left and right margins are set by moving the carriage to the margin stop, depressing the margin set key and holding it down while setting the carriage at the desired position. Power is turned on by moving the lever switch under the right side of the keyboard until a light appears in the white window. For other settings and controls see the typewriter manual.

Operation with the Computer. The external function 4204 must be issued before issuing output to the typewriter. The selection will be held until some other input or output device is used, including input via typewriter keyboard.

The external function 4202 must be issued before using keyboard input. The selection will be held until typewriter output or some other input or output function intervenes.



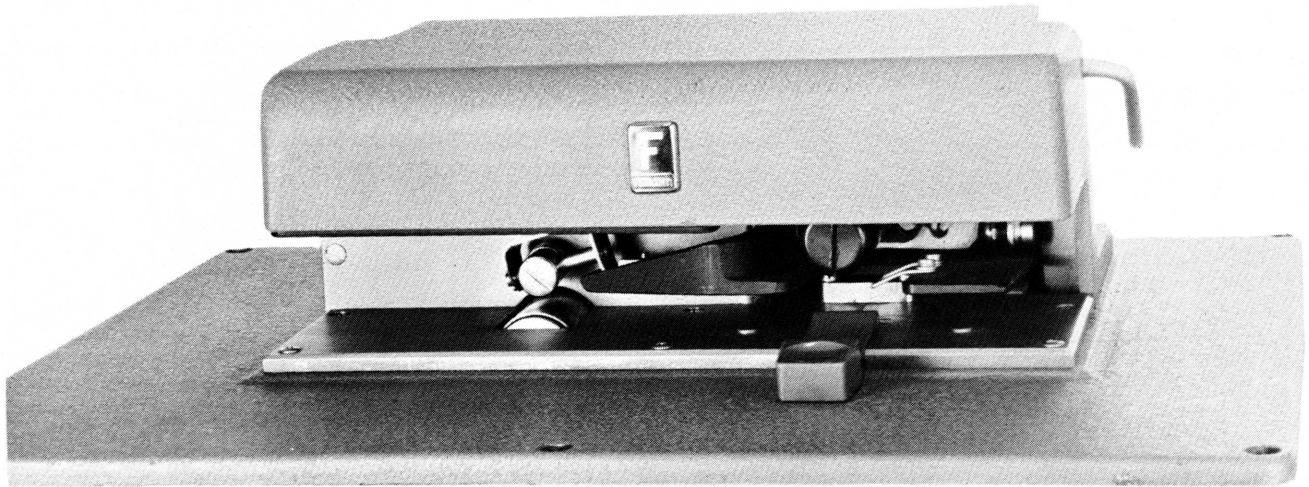

Figure 3. Ferranti Reader Head, Side View.

On receiving an EXF 4202 and the subsequent input instruction, an input request light will come on at the typewriter desk. The operator may then type the desired information. Completion of typing is indicated to the computer by sending an input disconnect signal. This signal may be initiated manually by depressing the Input Disconnect switch on the typewriter control panel, or automatically on typing carriage return when the Input Disconnect switch is in the AUTOMATIC position. In the latter case, a carriage return code is sent to the computer from the typewriter immediately preceding the disconnect.

The typewriter control will give a response of 0010 to a status request if the typewriter motor is off or if the typewriter is disconnected from the computer, as when being used for manual typing.

Typewriter Codes. Table 2 lists the octal codes which are sent to the computer upon depressing a typewriter key (input), or are accepted by the typewriter (output). On output, any octal code not listed is ignored by the typewriter and causes no action.

Typewriter Control Panel. Associated with the typewriter is a control panel containing two lever switches (Operation Mode and Input Disconnect) and two lights (ready and input request).

TABLE 2. TYPEWRITER CODES

a. Characters UC LC	Code	a. Characters UC LC	Code	a. Characters UC LC	Code
A a	30	P p	15	# 3	64
B b	23	Q q	35	\$ 4	62
C c	16	R r	12	% 5	66
D d	22	S s	24	φ 6	72
E e	20	T t	01	& 7	60
F f	26	U u	34	$\frac{1}{2}$ 8	33
G g	13	V v	17	( 9	37
H h	05	W w	31	- 52	
I i	14	X x	27	? /	44
J j	32	Y y	25	" ' 54	
K k	36	Z z	21	. + 46	
L l	11			. . 42	
M m	07	) 0	56	: ; 50	
N n	06	* 1	74	, , 40	
O o	03	@ 2	70	+ = 02	

b. Functions	Code	b. Functions	Code
Tab	51	Upper Case	47
Space	04	Carriage Return	45
Back Space	61	Lower Case	57

The Operation Mode switch is a three-position lever switch which controls the mode operation of the typewriter. Its three positions from top to bottom are:

- 1) COMPUTER. Operation of the typewriter is under control of the computer for input and output.
- 2) MANUAL. The typewriter is removed from computer control and may be used for typing heading and comment information. If the switch is moved from COMPUTER to MANUAL during a typewriter input or output operation the computer will halt and display a wait for input (IN) or wait for output (OUT) condition.
- 3) CLEAR. This position is used to reset the typewriter control, which should be cleared at the beginning of the operation after it has power turned on. The CLEAR position will also drop an EXF selection of the typewriter for input or output.

The Input Disconnect switch selects a method of sending an input disconnect (which terminates an input instruction) to the computer. Its three positions from top to bottom are:

- 1) AUTOMATIC. An input disconnect is sent to the computer each time the typewriter is used for input and a carriage return is typed. The carriage return code (45) is sent to the computer preceding the disconnect.
- 2) NONE.        } In these two positions a carriage return code is
- 3) MANUAL.     } sent each time a carriage return is typed.

In the NONE mode no input disconnect is sent to the computer. At any time when the typewriter is used for input, the Input Disconnect switch may be pressed to the MANUAL position to terminate the current input instruction.

Lights on the control panel and their purposes are:

- 1) The ready light signifies that the typewriter control has power on and is operating.
- 2) The input request light signifies that the computer requires typed information from the keyboard.

#### Teletype Model BRPE Paper Tape Punch

The Teletype paper tape punch is located in the left pedestal of the console. It will punch 7-level paper tape at a rate of up to 60 frames per second.

Operating Instructions. Tape is threaded as shown in figure 4. The chad drawer should be emptied each time a new roll of tape is placed in the punch.

To place a new roll of tape in operation:

- 1) Tear off old tape and run out of the punch block by holding down the tape feed lever.
- 2) Lift tape reel out of punch. Remove old roll of tape by unscrewing the X-shaped side of the tape reel.
- 3) Place new roll of tape on reel so tape unwinds in a counterclockwise direction, and attach the X-shaped side plate.
- 4) Place tape reel in punch, thread tape through the loop on the reel brake arm, through loop at front of punch, around the two rollers and into the tape guide.
- 5) Slowly slide the tape through the punch block. If it does not go through, tear off a piece of tape and try again. Lift tape tension lever so that the tape will start to go between the tape tension lever and the tape feed wheel.
- 6) Pull on end of tape and press tape feed lever. The tape should now feed automatically into the punch block. After about six inches of tape have been run out, the feed holes will be correctly punched.

Operation. The lower-order seven bits (6 to 0) of the current output word will be punched as levels 7 6 5 4 3 2 1, respectively. The external function 4104 must be given before the first output word to use the Teletype punch. Once selected for output, the selection will remain until some other device is used for input or output.

#### Magnetic Tape System

The magnetic tape system is comprised of one to four tape handlers and a tape control unit (TCU). The equipment is housed in a cabinet approximately 5 feet 8 inches high by 28 inches deep. The width is 2, 4, 6 or 8 feet, depending on whether 1, 2, 3 or 4 tape handlers are used. The tape handler may be an Ampex FR400, capable of a tape information rate of 15,000 6-bit characters per second, or an Ampex FR300, capable of transferring 30,000 6-bit characters per second.

Tape Characteristics. Tape system information is recorded with a density of 200 6-bit characters per inch on both the FR300 and FR400 tape systems. Tape used and produced is compatible with tape used and produced by the Model 1604 computer and the IBM 727 and the IBM 729 low density tape drives.

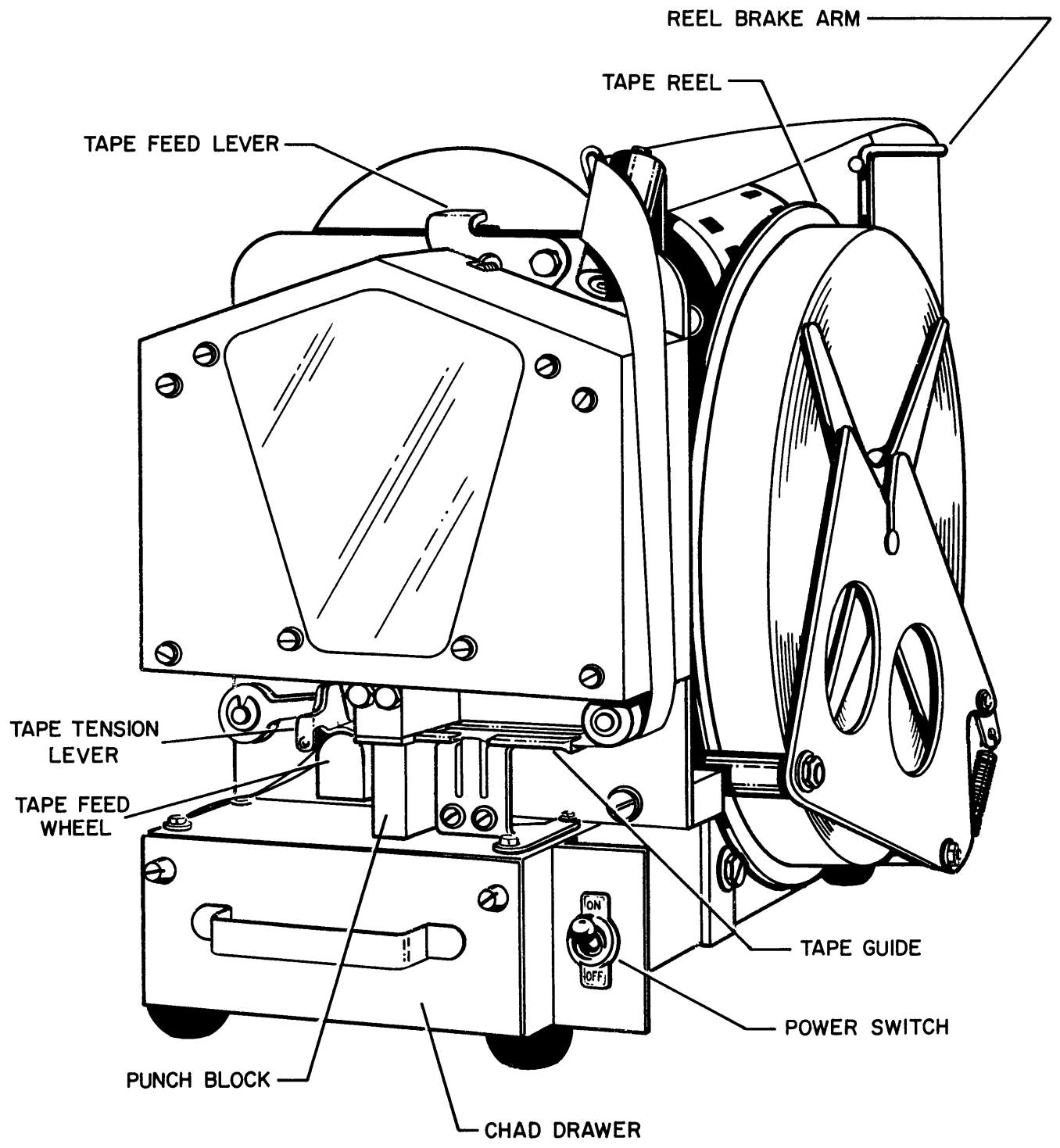

Figure 4. BRPE Punch.

Information is recorded in six channels as a series of 6-bit characters. A seventh channel records parity information about the other six channels. Parity information is generated and recorded by the TCU during a write operation; it is checked by the TCU during a read operation and by the read gap during a write operation.

Information is written in unit records of 2 to 4,096 characters. The lower limit of 2 is required since a 1-character record will be treated as a file mark. The upper limit is dictated by the core storage size of the computer. The TCU writes a longitudinal parity check character 0.02 inches after a record.

A 1-inch blank space defines the end of record. It also allows space for the tape to attain full speed for reading or writing after a stop. A 6-inch blank space followed by a 1-character record (octal 17) with an identical check bit constitutes a file mark or tape mark, which may be used to indicate the end of a group of related records. Any number of files may be written on a tape.

Even or odd parity can be chosen for reading or writing. Even parity requires that the sum of "1's" written on a frame (including the check bit) be even. Odd parity requires an odd sum. If a tape is written in even parity the 6-bit code 000000 is illegal, since nothing will be written; the TCU checks for this character and will indicate an error. Odd parity is referred to as the binary mode since all 64 possible 6-bit characters may be written and read. Even parity is used mainly for reading and writing BCD tapes for use on IBM 727 or 729 tape systems.

The tape system uses 1/2-inch wide plastic tape up to 3600 feet long wound on reels 10 1/2 inches in diameter. The beginning and end of the area of tape used for recording is indicated by small reflective spots manually attached to the tape. The spots provide compatibility with IBM tapes and are detected by photo-sensing means. The spot at the beginning of the tape is the load-point marker; the spot at the opposite end of the tape is the end-of-tape marker. Figure 5 shows the physical layout of the tape and the position of the reflective spots with respect to the ends of the tape. The end-of-tape indication is made available to the computer through the status request instruction.

Metal-backed tape attached to each end of the recording tape provides a means for detecting the physical beginning and end of the tape. Tape is stopped automatically when the metal-backed leader or trailer is detected by sensing posts located adjacent to the

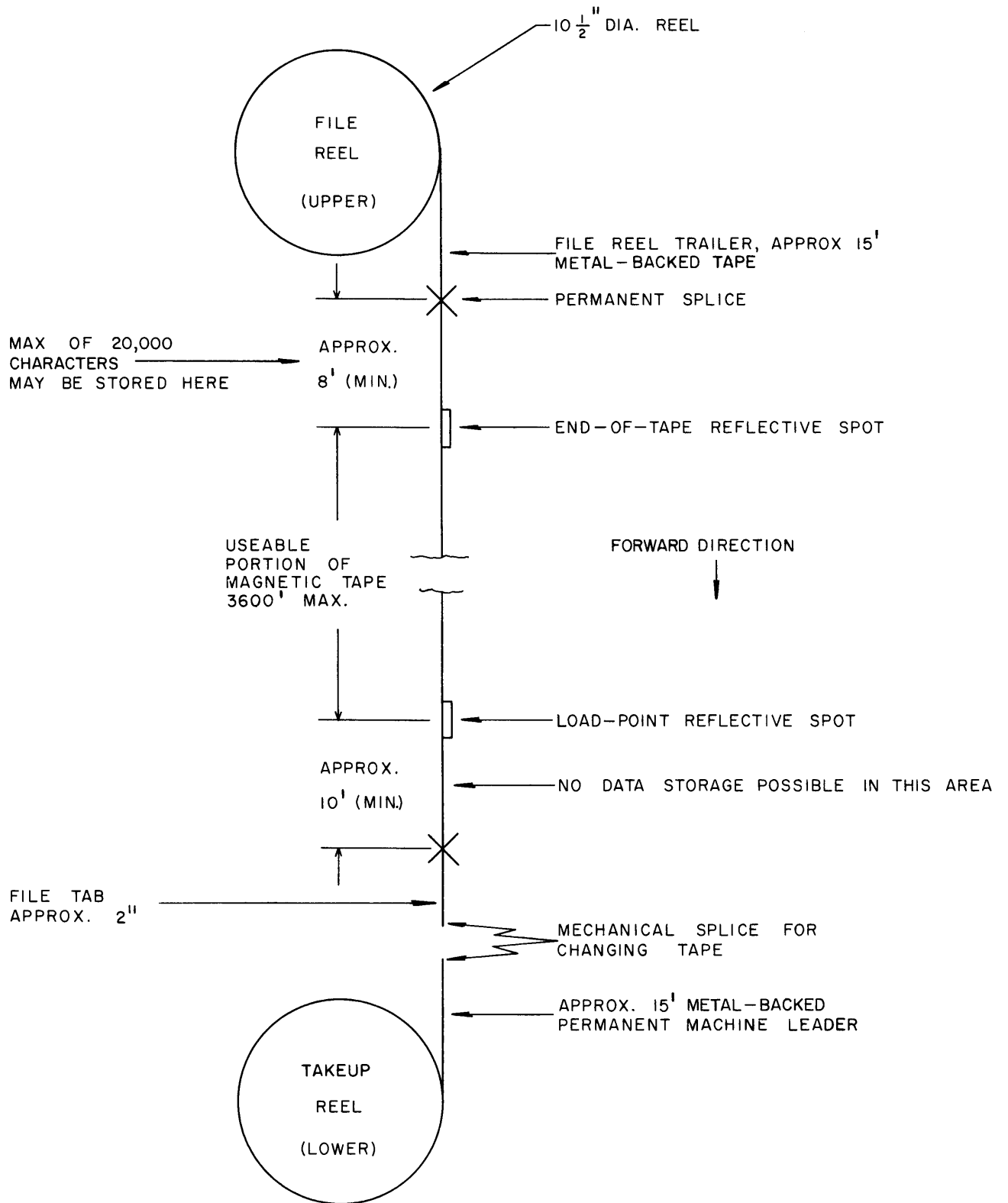

Figure 5. Physical Layout of Tape.

file reel (upper) and takeup reel (lower). When the metal-backed leader is contacting the upper sense post (all tape wound on file reel) the tape is at unload position. The area between the end-of-tape marker and the metal-backed trailer provides storage as indicated (figure 5) for completion of a record after the end-of-tape marker is detected.

Use of Tape. The computer performs the following functions using the tape system:

- 1) select parity
- 2) write record
- 3) write tape mark
- 4) rewind load
- 5) rewind unload
- 6) read forward
- 7) backspace
- 8) search tape mark forward
- 9) search tape mark backward

Select Parity. Prior to initiating a read or write operation on magnetic tape, the programmer must select the mode of parity to be used by the tape control unit. This is accomplished by issuing the external function 1171 to select odd parity and the external function 1172 to select even parity. Once made, a parity selection will hold until a different parity selection is designated.

Write Record. Writing a record is accomplished by issuing a write external function (111X) followed by an output instruction. The interval between the issuing of the 111X external function and the time the tape reaches writing speed is available for computing. However, the output instruction must be issued within 6 milliseconds after the EXF for the 300 series tape handler and within 20 milliseconds for the 400 series tape handler.

Write Tape Mark. A tape mark is written by issuing a write external function (111X) without any associated output instruction. The TCU performs this function by examining the output ready line at the time it is ready to write on tape. If there is no output information ready, it proceeds to write a long (6 inch total) inter-record gap and the required tape mark.

Rewind Load. On issuing the external function 116X the selected tape unit will rewind to the start (or load) point and halt. The rewind is controlled by each individual tape unit and any of the other units may be used while the specified unit is rewinding. All four units may rewind at one time.



Rewind Unload. Issuing the external function 117X will cause the tape unit to rewind to the unload point. In addition, an interlock is set which makes it impossible for the computer to address that unit again until the operator presses the Rewind Load button on that handler. A rewind load light appears on the tape unit and will remain on until the operator presses the Rewind Load button.

Read Forward. Reading forward is accomplished by issuing a 113X external function followed within 6 milliseconds for the 300 series tape handler (10 milliseconds for the FR400) by a read instruction. The read operation causes tape motion to continue until the next interblock space. If the input instruction specifies more than the number of characters in the record, the input will be terminated by the end of record.

Backspace. A backspace operation is accomplished by issuing a 112X external function and an Input to A instruction (76). The operation moves the tape backward one record to the preceding record gap and positions the read head ready to read forward. None of the information passed over is available to the computer.

Search Tape Mark. A read forward 113X (or a backspace 112X external function) without any associated input instruction will cause tape control to search forward (or backward) until it encounters a tape mark, at which time the tape unit will stop.

After a search forward the reading head will be positioned ready to read forward the first record of the file. After a search backward the head will read the tape mark forward. Reaching the load point or physical end of tape will terminate the search and set up the end-of-tape status.

Scatter Read and Write. It is possible on the FR400 tape unit (15,000 characters per second) to write information on one tape record from separate areas of memory by programming a continuous series of output instructions for one write tape external function (111X).

Similarly, information from one record of tape can be placed in various areas of memory by a series of input instructions following one read forward external function (113X).

Error Detection. Errors in reading are detected by making both a vertical (across character) and longitudinal (across record) parity check. If either check fails, the Parity Error FF will be set for interrogation by a status request. The read and write gaps on the tape head are separated by 0.39 inches. On writing, the information just written is checked by reading it at the read gap. If there is a vertical parity error in the information read, the Parity Error FF will be set.

The parity checking of a write operation will not be completed until five milliseconds after the writing of a record is completed for a 400 series tape handler (2 1/2 milliseconds for a FR300). To allow checking for a parity error at the correct time, a not ready status will exist until the end of parity checking. The Parity Error FF or the Illegal BCD FF will be reset upon initiation of another tape operation.

A program error will occur if the programmer attempts to:

- 1) write on tape which is protected from a write
- 2) backspace or search backward when the tape is at load point
- 3) operate a unit which has been interlocked by a rewind unload instruction and has not yet been serviced by the operator.

In all of these cases the program error indicator on the tape unit will light and the computer will stop with SEL (Select) indicated on the status display module.

Write Lockout. The magnetic tape reels have a slot near the hub which accepts a plastic ring called the write enable ring. When the ring is in the slot, the tape may be written upon; if there is no ring in the slot, the reel cannot be written upon and is in a write lockout condition. In either case information can be read from the tape. The above lockout function can be duplicated manually by the Write Lockout switch on the tape unit control panel (table 3).

Status Replies. Responses given by a tape unit to a status request (EXF 114X) depend upon the conditions listed below:

0002 Not Ready

A not ready response is given by a specified unit under any of the following conditions:

- 1) The unit number addressed has not been assigned to tape handler.
- 2) The unit is in rewind unload condition and has not been reset by operator.
- 3) Unit is rewinding.

- 4) Unit has completed a write but has not completed the parity checking.
- 5) Unit has finished reading requested information but has not completed the longitudinal parity check.
- 6) Unit is doing a search for tape mark and has not yet found it.
- 7) Unit is writing a tape mark.

The not ready condition will be reset when none of the above conditions prevail.

#### 0004 Parity Error

A parity error indication will be given if a vertical or longitudinal parity error occurs during reading, or a vertical parity error occurs during the check of information written by the write head. The parity error indication will be reset on initiating another tape operation on any tape unit.

#### 0010 Illegal BCD

An illegal BCD indication will be given if the binary character 000000 existed in the last record written in even parity mode. The indication will be reset on initiating another tape operation on any tape unit.

#### 0020 File Mark Read

The file mark indication will be set if the previous read forward or backspace operation encountered a file mark, or if the search file (forward or backward) operation encountered a file mark. The indication is reset upon initiation of the next tape operation on any tape unit.

#### 0040 End of Tape or Load Point

An end-of-tape or load-point indication will be set if the tape unit detects the end-of-tape or load-point reflective spot, respectively. The former indication will be reset upon initiation of a backward tape operation on the specified tape unit; the latter indication will be reset upon initiation of a forward operation on the specified tape unit.

Operation Control. Each tape unit is provided with switches and indicators to assist operation. The controls are mounted on a panel (figure 6) above the front door of each unit. Table 3 gives the functions of the various controls.

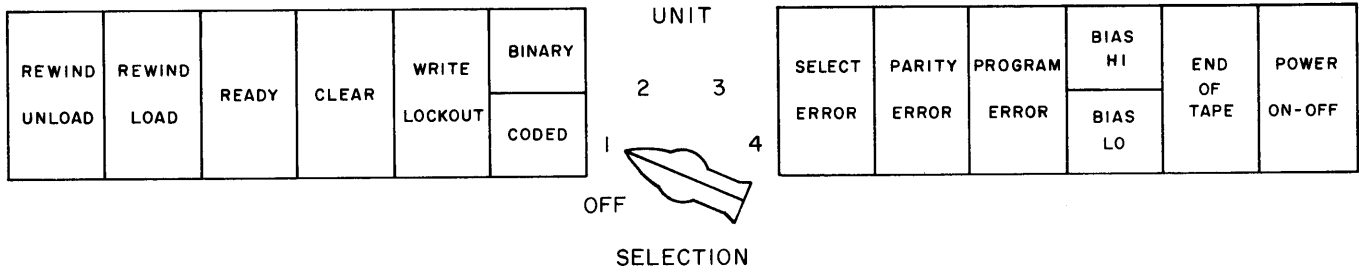

Figure 6. Magnetic Tape Control Panel.

TABLE 3. MAGNETIC TAPE CONTROL PANEL

Name	Function
REWIND UNLOAD	S* Moves tape to unload position and interlocks it to place the unit in a not ready condition. The control duplicates a programmed rewind unload instruction.
	I** Light is turned on by switch operation or programmed rewind unload instruction; remains on until Rewind Load is pressed.
REWIND LOAD	S Moves tape to load point and releases an existing interlock condition. When arriving at load point from unload position, ready light turns on to indicate a unit ready condition. Control duplicates a programmed rewind instruction.
	I Light indicates unit moving to load point.
READY	I Light is on at all times tape is available for computer use.
CLEAR	S Stops (immediately) tape motion and clears TCU. New manual or programmed selections are necessary to reselect tape unit and/or operation required.

\* Switch  
 \*\* Indicator

TABLE 3. MAGNETIC TAPE CONTROL PANEL (CONT'D.)

Name	Function	
WRITE LOCKOUT	S	Pressing switch prevents writing on unit; again pressing switch releases write lockout condition. However, write lockout condition prevails despite switch setting when a file reel is installed without a write enable ring.
	I	Light indicates write lockout condition because of above switch action or absence of write enable ring on file reel.
BINARY	I } I }	Indicates parity selection.
CODED		
UNIT SELECTION	S	5-position switch: 1, 2, 3 and 4 provide unit designation. OFF disconnects unit from TCU.
SELECT ERROR	I	On if duplicate Unit Selection switch settings exist.
PARITY ERROR	I	On if parity error exists on unit. Turned off by initiation of new read or write operation on any unit.
PROGRAM ERROR	I	On when program error exists on unit. Turned off by manually correcting error condition.
BIAS HI	I	Indicates bias level of read amplifier set to compensate for higher than normal tape signals.
BIAS LO	I	Indicates bias level of read amplifiers set to compensate for lower than normal tape signals.
END-OF-TAPE	I	On when end-of-tape reflective spot marker detected. Turned off by next backward operation on unit.
POWER ON-OFF	S	Press to turn on; press again to turn power off.
	I	On when power is on.

To load magnetic tape (figure 7):

- 1) Press Power On-Off button to apply power to the unit.
- 2) Open door to handler.
- 3) Check that file reel to be loaded has been file protected by write enable ring.
- 4) Mount the reel on the file reel hub and tighten the hub knob. To insure proper reel alignment push the reel firmly against the reel hub stop before tightening the knob. If the write enable ring has been removed from the reel, check that the write lockout light is on when the reel is loaded. If the light is not on call maintenance.
- 5) Press upper Reel Brake push button (to release mechanical brake) and check that pulling tape from reel causes it to rotate clockwise. Pull sufficient tape from reel to reach end of permanent machine leader held by leader clamp.
- 6) Connect file tab to permanent machine leader.
- 7) Take up slack by turning file reel while depressing upper Reel Brake push button.
- 8) Lift leader clamp.
- 9) Close door.
- 10) Rotate the Unit Selector switch to position 1, 2, 3 or 4 to assign the unit a logical program selection number.
- 11) Press Clear button.
- 12) Press Rewind Load button to move tape to load position. The ready indicator will turn on when unit is ready to be operated.

To unload magnetic tape:

- 1) Depress Rewind Unload to move tape to unload position.
- 2) Open door to handler.
- 3) To secure tape, lower leader clamp.
- 4) Press upper Reel Brake button and pull sufficient tape from file reel to provide slack.
- 5) Unfasten mechanical splice which connects the file tab to the permanent machine leader.
- 6) Loosen the hub knob and remove file reel.
- 7) Check the reel to determine if it is to be file protected and label the reel as necessary prior to storage.

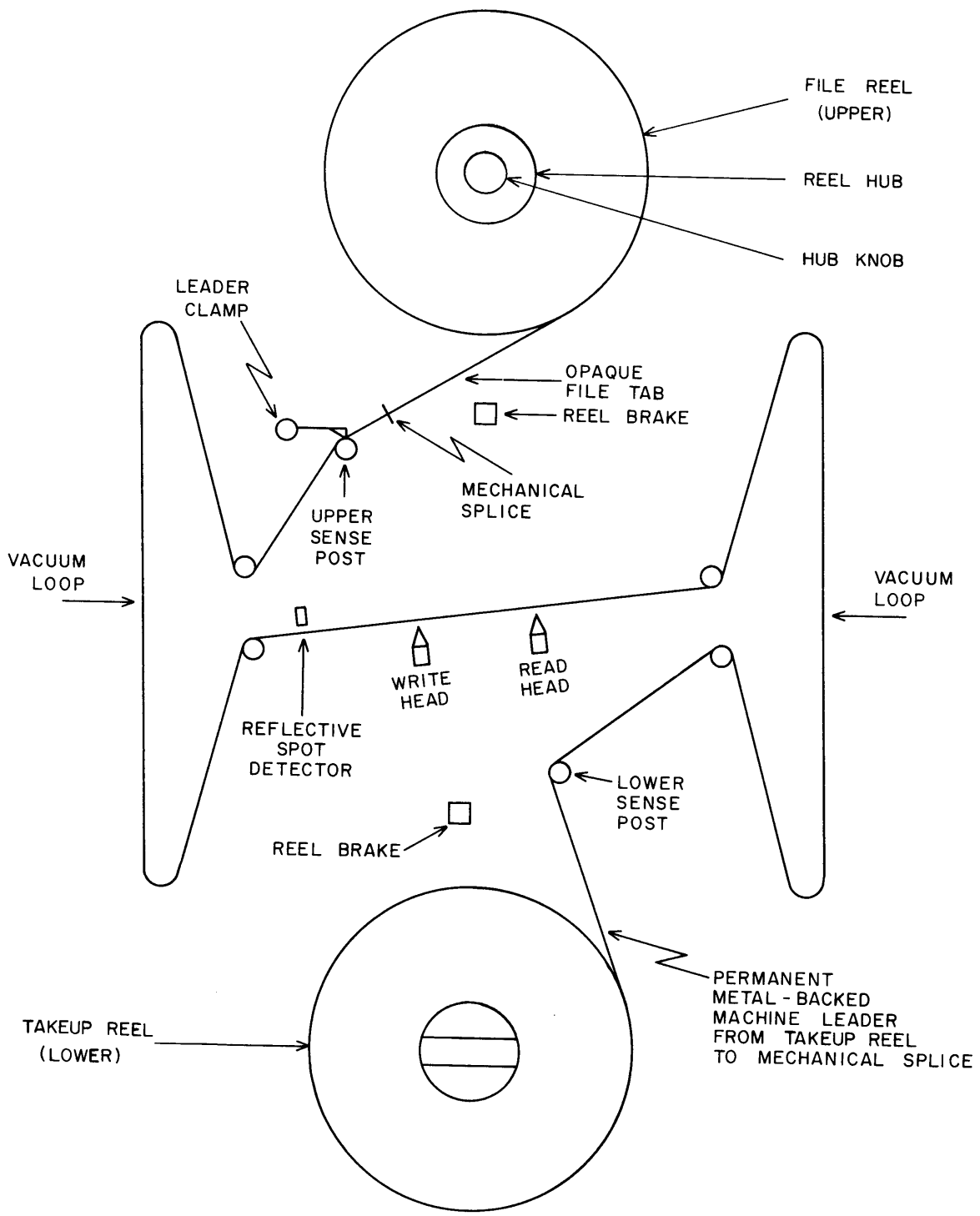

Figure 7. Tape at Unload Position.

### Attaching Reflective Spots

Reflective spots are placed on the tape to enable sensing of the beginning and end of the useable portion of the magnetic tape. The markers also provide compatibility with IBM equipment. The reflective spots are small pieces of plastic 1 inch long by  $3/16$  inch wide, coated with an adhesive on one side and vaporized aluminum on the other. They are placed on the base or uncoated side of the tape and detected by photo-sensing circuits. The marker at the beginning of the tape is the load-point marker, the marker at the end of the tape is termed the end-of-tape marker.

The load-point marker must be placed at least 10 feet from the splice of the file tab and magnetic tape (figure 5). The marker is placed with its 1-inch dimension parallel to, and not more than  $1/32$  inch from, the edge of the tape nearest the operator when the file reel is mounted.

The end-of-tape marker should be placed not less than 18 feet from the physical end of the tape attached to the takeup reel hub. This space includes approximately 10 feet of tape trailer (which may be metal-backed tape) and enough tape to hold a record of 20,000 characters after the end-of-tape marker is sensed. The marker is placed with its 1-inch dimension parallel to, but not more than  $1/32$  inch from, the edge of tape nearest the tape unit (when reel is mounted).

The markers should be properly aligned and firmly attached to the tape. It is recommended they be applied away from the tape unit using manual rewinding equipment. Use care to avoid dust accumulating on the tape.



## MACHINE ORGANIZATION

The Model 160 consists of six registers, an adder pyramid and a 4,096 12-bit-word magnetic core storage unit. The interconnection of these units is shown in figure 8. Three of the registers, P, A and Z, contain information of interest to the programmer and are displayed on the console. The other three registers are used transiently and are not displayed.

### FUNCTION OF THE REGISTERS

P, a 12-bit register, contains the address of the instruction currently being executed by the Model 160, except during 72 and 73 sequences.

A, a 12-bit register, contains the result of all arithmetic and logical instructions and is also used as one of the operands. In the input and output operation it is used by the 72 and 73 instructions to contain the address of the next unit of information.

Z is a 12-bit general communication register which retains information going to and from magnetic core storage; it also is used for input and output.

F is a 6-bit register which retains the function code of the current instruction to control its execution.

S, a 12-bit register, is used to specify the storage location of information or instructions. It also is the path of transmission of data to the P register.

B is a 12-bit transient register which is used in conjunction with the adder pyramid to perform additions and subtractions.

The adder pyramid performs arithmetic modulus  $2^{12}-1$  (or one's complement) using a subtractive logic which prevents the formation of minus zero (7777) in all arithmetic operations. The pyramid is used as a data transfer device by adding minus zero to the data; information may be transferred from any adder pyramid input to any B register output. Although the adder pyramid will not generate minus zero (7777), any arithmetic operation using minus zero will give the correct result; thus  $n + (-0) = n$ .

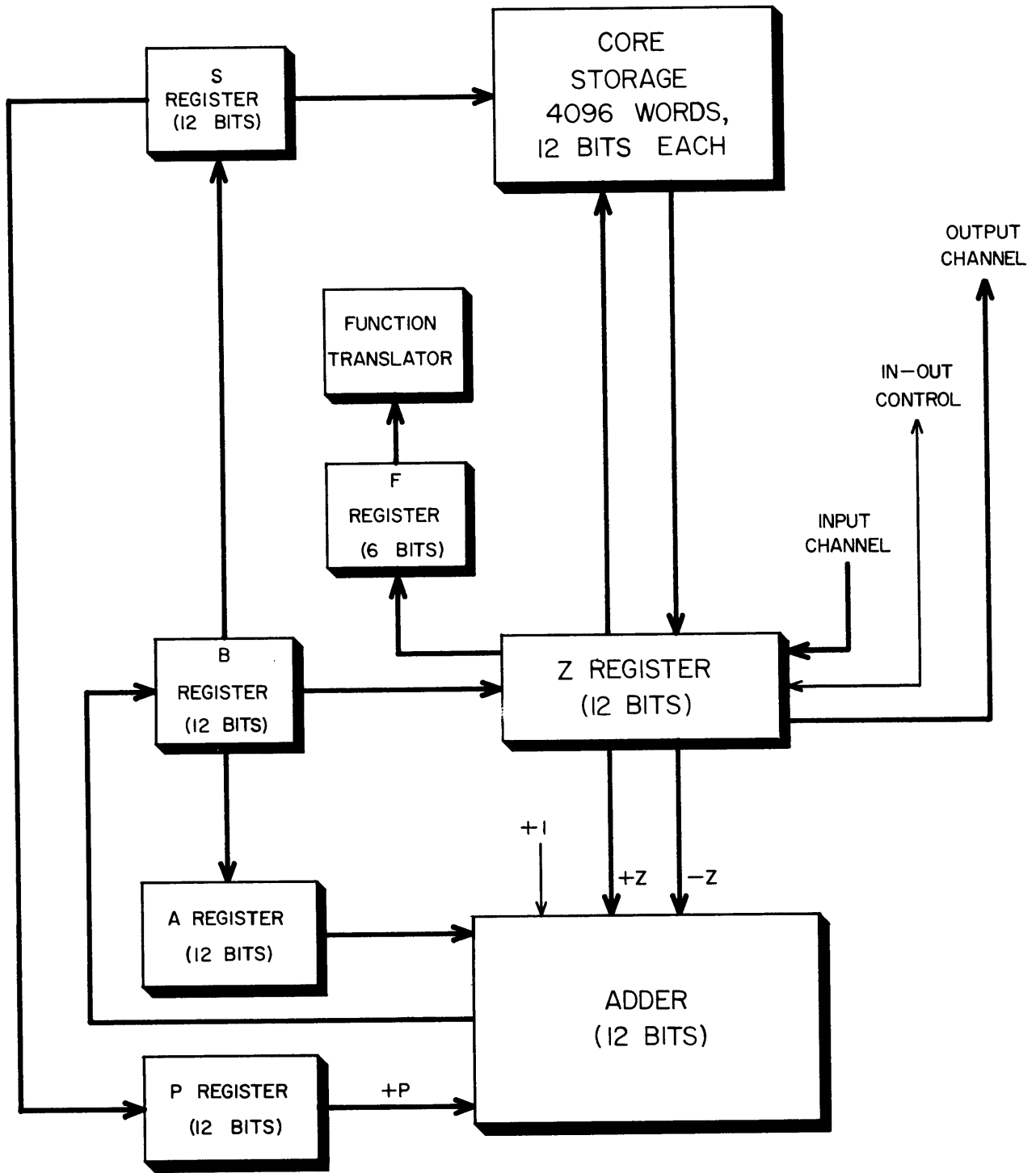

Figure 8. Block Diagram.

The 4,096 12-bit words of storage are addressed as octal locations 0000 to 7777. The complete storage cycle takes 6.4 microseconds. Information read is available 2.2 microseconds after the start of the cycle, leaving the rest of the cycle available to the computer for arithmetic operations.

### ORGANIZATION OF INSTRUCTIONS

The execution of an instruction by the computer is accomplished in a series of data transmissions, each of which is the result of a machine-generated command. Certain of these commands often occur in the same order; such a group of commands is known as a major sequence. Any instruction, then, may be defined in terms of these major sequences plus such additional commands as do not fall conveniently into the major sequence category.

Figure 9 shows the composition of a typical instruction, 20 Load Direct Address (d), using commands and sequences.

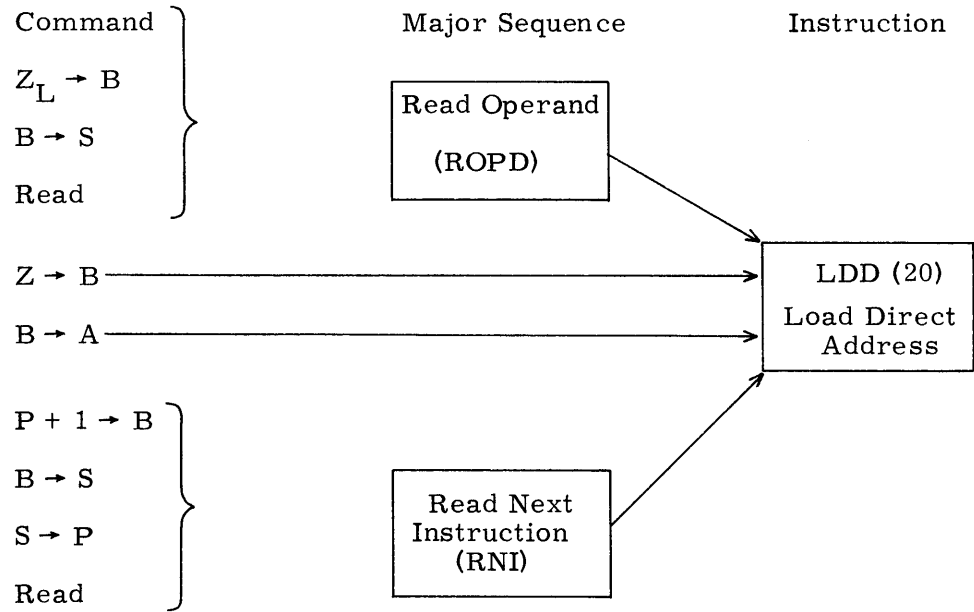

Figure 9. Typical Instruction Composition.

## Commands

Commands may be grouped according to the register involved.

### I. Adder Pyramid Commands

For some commands the adder pyramid combines the operands to produce the sum modulus  $2^{12}-1$  in the B register. The commands are shown in the column at the left; sources of the operands are analyzed in the two columns at the right.

Commands	First Operand	Second Operand
$P + 1 \rightarrow B$	P	+1
$P - Z \rightarrow B$	P	$-Z_L$
$P + Z \rightarrow B$	P	$+Z_L$
$A + 1 \rightarrow B$	A	+1
$A \rightarrow B$	A	
$-Z \rightarrow B$		-Z
$A + Z \rightarrow B$	A	+Z
$A - Z \rightarrow B$	A	-Z
Shift A left 1 place $\rightarrow B$		$A \cdot 2^1$
Shift A left 3 places $\rightarrow B$	$A \cdot 2^3$	
$Z \rightarrow B$	Z	

The adder pyramid is also used to produce logical sum and logical product.

### II. B register

$B \rightarrow S$

$B \rightarrow Z$

$B \rightarrow A$

### III. S register

$S \rightarrow P$

Act as address for core storage

### IV. Z Register

$Z \rightarrow F$

Z to output equipment

Input device to Z

Storage to Z

### V. Storage Operations

Read

Information is read into Z register from the storage location specified by S; S remains unchanged.

Write

Information contained in Z is stored at the storage location specified by S.

## Major Sequences

Major sequences and their associated commands are given below:

### I. Read Next Instruction (RNI)

- 1)  $P + 1 \rightarrow B$
- 2)  $B \rightarrow S$
- 3)  $S \rightarrow P$
- 4) Read

### II. Jump To Next Instruction (JNI)

Type of jump determines mode of address as forward, backward or indirect.

The sequences are:

- a) forward
  - 1)  $P + Z_L \rightarrow B$
  - 2)  $B \rightarrow S$
  - 3)  $S \rightarrow P$
  - 4) Read
- b) backward
  - 1)  $P - Z_L \rightarrow B$
  - 2)  $B \rightarrow S$
  - 3)  $S \rightarrow P$
  - 4) Read
- c) indirect
  - 1)  $Z \rightarrow B$
  - 2)  $B \rightarrow S$
  - 3)  $S \rightarrow P$
  - 4) Read

### III. Store Contents of A (STA)

- 1)  $A \rightarrow B$
- 2)  $B \rightarrow Z$
- 3) Write

### IV. Read Operand (ROPD)

An operand may be addressed as:

- a) direct
- b) indirect
- c) forward
- d) backward
- e) no address

The sequences are:

- a) direct
  - 1)  $Z_L \rightarrow B$
  - 2)  $B \rightarrow S$
  - 3) Read
- b) indirect
  - 1)  $Z_L \rightarrow B$
  - 2)  $B \rightarrow S$
  - 3) Read
  - 4)  $Z \rightarrow B$
  - 5)  $B \rightarrow S$
  - 6) Read
- c) forward
  - 1)  $P + Z_L \rightarrow B$
  - 2)  $B \rightarrow S$
  - 3) Read
- d) backward
  - 1)  $P - Z_L \rightarrow B$
  - 2)  $B \rightarrow S$
  - 3) Read
- e) no address

Set  $Z = Z_L$  with zeros as high order.

## Instructions

Each instruction is analyzed into a series of major sequences and individual commands.

### Shift A

1) May be:  
 $A \cdot 2^3 \rightarrow B$   
 or  $A \cdot 2^1 \rightarrow B$   
 or  $A \cdot (2^3 + 2^1) \rightarrow B$  } depending on value of E

$\left\{ \begin{array}{l} E = 10 \\ E = 02 \\ E = 12 \end{array} \right.$

2)  $B \rightarrow A$

3) RNI

### Logical Product

1) ROPD

2)  $L(Z)(A) \rightarrow B$

(logical product of Z and A)

3)  $B \rightarrow A$

4) RNI

### Logical Sum

1) ROPD

2)  $(Z) \oplus (A) \rightarrow B$

(logical sum)

3)  $B \rightarrow A$

4) RNI

### Load

1) ROPD

2)  $Z \rightarrow B$

3)  $B \rightarrow A$

4) RNI

### Load Complement

1) ROPD

2)  $-Z \rightarrow B$

3)  $B \rightarrow A$

4) RNI

### Add

1) ROPD

2)  $A + Z \rightarrow B$

3)  $B \rightarrow A$

4) RNI

### Subtract

1) ROPD

2)  $A - Z \rightarrow B$

3)  $B \rightarrow A$

4) RNI

### Store (40)

1)  $Z \rightarrow B$

2)  $B \rightarrow S$

3) STA

4) RNI

### Store (41)

1)  $Z_L \rightarrow B$

2)  $B \rightarrow S$

3) Read

4)  $Z \rightarrow B$

5)  $B \rightarrow S$

6) STA

7) RNI

### Store (42)

1)  $P + Z \rightarrow B$

2)  $B \rightarrow S$

3) STA

4) RNI

### Store (43)

1)  $P - Z \rightarrow B$

2)  $B \rightarrow S$

3) STA

4) RNI

Shift Replace

- 1) ROPD
- 2)  $Z + Z \rightarrow B$
- 3)  $B \rightarrow Z$
- 4)  $B \rightarrow A$
- 5) Write (-S is still at OPD address)
- 6) RNI

Replace Add

- 1) ROPD
- 2)  $A + Z \rightarrow B$
- 3)  $B \rightarrow A$
- 4)  $B \rightarrow Z$
- 5) Write
- 6) RNI

Replace Add One

- 1) ROPD
- 2)  $Z + 1 \rightarrow B$
- 3)  $B \rightarrow A$
- 4)  $B \rightarrow Z$
- 5) Write
- 6) RNI

Condition Jump

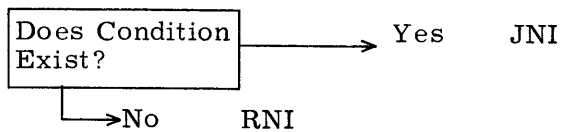

Indirect Jump (70)

- 1)  $Z_L \rightarrow B$
- 2)  $Z + 1 \rightarrow B$
- 3)  $B \rightarrow A$
- 4)  $B \rightarrow Z$

Indirect Jump (71)

- 1)  $P + Z_L \rightarrow B$
- 2)  $B \rightarrow S$
- 3) Read
- 4) JNI (indirect)

Input (72)

- 1) Read operand (starting address of buffer)
- 2)  $Z \rightarrow B$
- 3)  $B \rightarrow A$
- 4) Initiate input
- 5) On resume  $A \rightarrow B$
- 6)  $B \rightarrow S$
- 7) Write
- 8)  $A + 1 \rightarrow B$
- 9)  $B \rightarrow A$
- 10)  $P + 1 \rightarrow B$  ( $P + 1$  first cycle only;  $P \rightarrow B$  all successive cycles)
- 11)  $B \rightarrow S, S \rightarrow P$
- 12) Read
- 13)  $A - Z \rightarrow B$
- 14)  $B \rightarrow A$
- 15) Sense  $A = \emptyset$  or  $A \neq \emptyset$
- 16)  $A + Z \rightarrow B$
- 17)  $B \rightarrow A$
- 18) If  $A \neq \emptyset$  on sense, go to step 4
- 19) If  $A = \emptyset$  on sense, RNI

Output (73)

- 1) Read operand (starting address of buffer)
- 2)  $Z \rightarrow B$
- 3)  $B \rightarrow A$
- 4)  $A \rightarrow B$
- 5)  $B \rightarrow S$
- 6) Read
- 7) Initiate output
- 8)  $A + 1 \rightarrow B$
- 9)  $B \rightarrow A$
- 10)  $P + 1 \rightarrow B$  on resume ( $P + 1$  first cycle only;  $P \rightarrow B$  on all successive cycles.)
- 11)  $B \rightarrow S$
- 12)  $S \rightarrow P$

- |  |                                 |
|--|---------------------------------|
| 13) Read address                                 | Input to A                      |
| 14) $A - Z \rightarrow B$                        | 1) Initiate input               |
| 15) $B \rightarrow A$                            | 2) On resume, $Z \rightarrow B$ |
| 16) Sense $A = \emptyset$ or $A \neq \emptyset$  | 3) $B \rightarrow A$            |
| 17) $A + Z \rightarrow B$                        | 4) RNI                          |
| 18) $B \rightarrow A$                            | Halt                            |
| 19) If $A \neq \emptyset$ on sense, go to step 4 | 1) Stop                         |
| 20) If $A = \emptyset$ on sense, RNI             | 2) On start, RNI                |

#### Output (74)

- 1) Initiate output of  $Z_L$
- 2) RNI on resume

#### External Function

- 1) ROPD (forward only)
- 2) Initiate EXF
- 3) On resume, RNI

### CONTROL CONSOLE

The computer control console (figure 10) consists of a display panel with three projection display units which show the contents of the P, A and Z registers in octal notation.

Three switches per octal position of display enable the operator to clear and enter binary information in the register. A separate status display module displays the status of the machine at all times. Below the display panel is the operating control panel which contains power ON and OFF push buttons and four lever switches.

#### Run-Step Switch

Placing this switch in the RUN position causes operation to take place continuously until a stop condition occurs. Operation may be resumed by returning the switch to the center and back to RUN. To stop operation, place the Run switch in the center position. The computer will then stop upon completion of the current instruction.

Placing this switch in STEP position will cause one phase of operation to take place. A phase is one storage reference cycle.



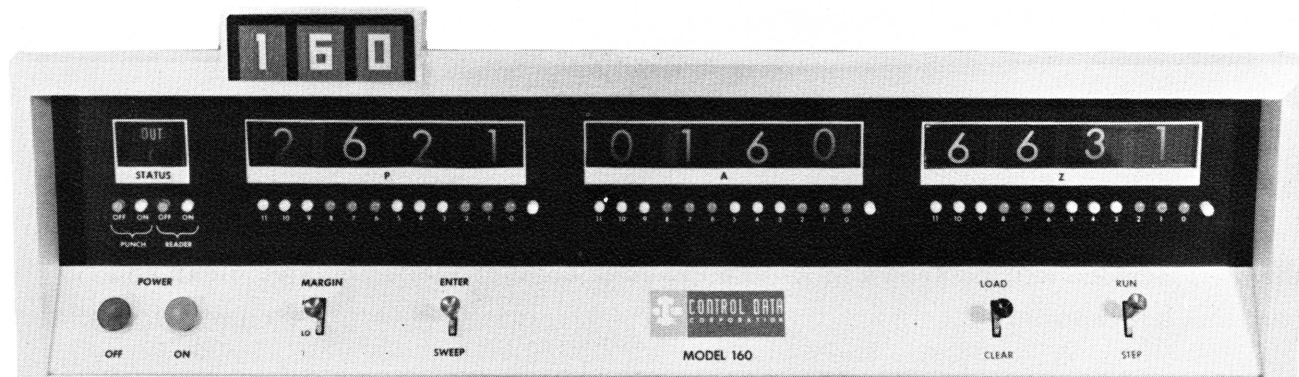

Figure 10. Console Display Panel and Switches.

#### Load-Clear Switch

Placing this switch in the CLEAR position causes the registers to be reset to zero. Core storage is unchanged by the clear operation.

To load paper tape, place the specially prepared machine-load paper tape on the Ferranti reader, clear, place the switch in LOAD position, put the starting address of the information in the P register, and place Run-Step switch in the RUN position. The Ferranti photoelectric reader will load successive storage locations until the end leader is reached on the tape as indicated by the absence of seventh-level punches. If more information is to be read into the next locations from the same tape, return the Run-Step switch to the center position and then to RUN.

#### Enter-Sweep Switch

To manually enter information, place this switch in the ENTER position and master clear; place the address of the first word of a block of information in the P register and the first word of information in the Z register. On issuing a run or step, the information in Z is stored and also transferred to the A Register. From this point on, P will show the location of the last information stored and A will show what was stored. To enter the next word, place the information in Z and issue a run or step. To enter a new block of information, master clear and start the above procedure again.

Note that the information which appears in A comes directly from Z and thus shows the programmer what was last inserted.

To examine the contents of a block of storage location, put the switch in the SWEEP position and master clear. Place the address of location to be examined in P and press the Step switch. The contents of the location specified by P will be shown in the Z register. Each time the Step switch is pressed P will advance one and the contents of the next location will be shown in Z. To examine another block, master clear and repeat this procedure.

#### Hi-Lo Switch

This switch varies the bias on the storage unit to check operation. It should normally be in the center position and not operated by the programmer-operator, as it is used for maintenance and test of the computer. When it is operated an M appears on the status display module, superimposed over the present contents of the module.

#### Display Panel

The P, A, and Z registers are displayed as four octal digits corresponding to the 12-bit binary contents of the registers. These register display lights are turned off when the machine is in the run mode.

Information may be entered into the registers by pressing the set push buttons below the octal display. When in the step mode, the registers are manually cleared by pressing the button at the extreme right. The push buttons are active at all times and care should be taken to avoid accidentally pressing the buttons while the computer is operating in the run mode. No damage will occur to the machine, but the program most likely will be destroyed.

#### Status Display

The status display module shows the condition of the computer at all times. A green background indicates the machine is running; a red background indicates a stop.

Information displayed in the lower row indicates by the letters A, B, C or D which phase of an instruction is about to be executed. During run, these phase indicators are turned off.

Information displayed in the upper row indicates stop or wait conditions. The letters ERR will be displayed with a red background to indicate any attempt to execute an instruction with the operation code 00 (a program error). The letters IN, OUT or SEL will be displayed with a green background to indicate that the computer is waiting for a response from external equipment during the execution of an input, output or external function instruction. This condition usually arises from trying to use external equipment that is either not connected, not turned on or not ready.

## SPECIAL OPERATING PROCEDURE

### Machine Load

The computer has special circuits to allow for automatic loading of programs and data from specially prepared tapes. Information is prepared on punched paper tape in a two-frames-per-word format. The first frame of each word contains a seventh-level punch and the six higher-order bits of the word; the second frame contains the six lower-order bits of the word.

Successive words must follow each other on tape. The loading will stop upon reaching a frame where there should be a seventh-level punch and none exists. Tape may be placed in the reader anywhere on the leader and the computer will search for the first word. The address of the first location to be loaded must previously be placed in P.

### Clear Storage

To clear storage, master clear, place the Enter-Sweep switch in SWEEP position and activate the Run switch. In this situation each word is read to Z and restored. By holding down the clear button on the Z register, the register will be cleared before restoring each word, thereby clearing storage.

To write a preset pattern in all words of storage, clear storage and hold the desired pattern in Z as described above.

### Program Step

The Step switch may be used to check out a program. Each time the switch is depressed one phase of execution of the instruction is performed. The phase indicators on the status display (A, B, C or D) tell which phase is about to be executed. All instructions obtain the next instruction in phase D; however, the instruction will be in the Z register

upon completion of phase D. The next phase may be A, B, or D, which will show on the status module.

The Z register will show a blue-green background light each time an instruction is in Z to avoid the problem of identifying the point at which an instruction appears.

Table 4 shows the steps in executing instructions, along with the content of the display registers corresponding to the phase displayed on the status module. The P register contains the address of the instruction being executed.

TABLE 4. STEPS IN EXECUTING INSTRUCTIONS

Instructions	Phase	Z Register	A Register	
00,77	D	Instruction	NC*	
01, 02, 03, 04, 05, 06, 07	D	Instruction	Result	
10, 14, 20, 24, 30, 34	B	Instruction	NC	
12, 16, 22, 26, 32, 26	D	Operand	Result	
13, 17, 23, 27, 33, 37				
11, 15, 21, 25, 31, 35	A	Instruction	NC	
	B	Address of Operand	NC	
	D	Operand	Result	
40, 42, 43	B	Instruction	NC	
	C	Previous Content Of Location	NC	
	D	Result	NC	
41	A	Instruction	NC	
	B	Address Of Operand	NC	
	C	Previous Content Of Location	NC	
	D	Result	NC	
44, 46, 47	B	Instruction	NC	
50, 52, 53	C	Operand	Result	
54, 56, 57	D	Result	Result	
45, 51, 55	A	Instruction	NC	* NC indicates no register change.
	B	Address of Operand	NC	
	C	Operand	Result	
	D	Result	Result	

TABLE 4. (CONT'D.)

Instruction	Phase	Z Register	A Register
60, 61, 62, 63, 64, 65, 66, 67	D	Instruction	NC
70, 71	B	Instruction	NC
	D	Jump Address	NC
72	B	Instruction	NC
	C	Input Character	Location of 1st input
	D	NC	Next input location
	C	Input Character	NC
	D	NC	Next input location
 <p>C → D cycle continues until input location compares with final storage location.</p>			
73	B	Instruction	NC
	C	Location of Output	Location of Output
	D	Output Character	Location of Next Output
Repeated	{ C	Output Limit	NC
	{ D	Output Character	Location of Next Output
74	D	Instruction	NC
75	B	Instruction	NC
	B	Function Code	Function Code
	D	NC	NC
76	C	Input Character (Green Background)	NC
	D	Instruction (No Green Background)	Input Character

## PROGRAMMING

Programming the Model 160 is slightly different from programming most other single-address computers. The major difference is the ability of the 160 to use only six bits as an address. Through the various addressing modes, these six bits are used to directly specify one of the first 64 storage locations, or one of the 63 locations preceding or following the instruction. Indirect addressing enables the programmer to extend the instruction to a two-word format where the second word (located usually at storage location 0 to 63) is a full 12-bit address.

### PROGRAMMING CONVENTIONS

The conventions discussed below have been developed through preliminary 160 programming. Addresses are given in octal notation.

#### Storage Locations 0-77

Storage locations 0-77 are unique in their use for direct and indirect addressing because they can be referred to by an instruction any place in storage. These locations should be reserved for use as indirect addresses and as counters which are used by more than one routine. Certain locations should be reserved for subroutine return addresses.

To maintain compatibility with Control Data Corporation programming aids the following conventions will be observed:

- 1) Locations 70 to 77 will be used as transient locations within a subroutine. The subroutines will have to preset these locations before using them.
- 2) Location 0 to 1 will be used as the entry to a program where the instructions are:

Locations	Contents
0000	7001
0001	Address of Program

- 3) Locations 2 through 7 will be used for subroutine exits. Location 7 is the exit for the highest-order subroutine, 6 the next lowest, and so forth.
- 4) Locations 10 to 67 may be used as permanent storage by any program.

#### Addressing

The use of the 12-bit word as an address includes the sign bit; thus care must be taken in testing numbers 4000 to 7777 since they are considered negative.

The one's complement arithmetic used in the computer applies to all operations, including advancing P and relative addressing. Note that the value 7777 cannot be generated by one's complement arithmetic. The use of location 7777 should be discouraged.

Locations 7400 to 7776 are used by service routines. Any programmer wishing to use these services should not use these locations in his program.

## PROGRAMMING TECHNIQUES

### Counters

The Replace Add One instruction makes it desirable to preset a counter to a negative value and count up to zero. The simplest method is to enter (-n) in the counter. The adding to the counter and testing should be placed after the operation to be controlled. The following routines show examples of this:

Routine One - Perform operation ten times.

START	LCN	12	place (-10) in A
	STF	CT	place (-10) in counter
OPN	.		operation
	.		
	.		
	AOF	CT	count + 1
	NZB	OPN	count = 0? no, return to operation
	STP		yes, stop
CT			counter location

The above routine assumes that less than 63 locations separate START and CT.

Routine Two - Perform operation one hundred times. (Operation takes 700 location)

LIM	01	44	
START	LCB	LIM	preset counter to (-100 decimal)
	STD	77	
OPN	.		
	.		operation
	.		

AOD	77	counter + 1
ZJF	DONE	done? (CTR=0 ?)
JFI	01	no, return to operation

O P N

DONE	STP	yes, stop
------	-----	-----------

This is the method of counting most generally used but requires more storage space than the previous routine.

### Subroutine Entry and Return

The following methods are applicable to subroutines which require various amounts of information.

Routine Three - Entry to subroutine which does not require parameter.

MAIN	LDF	RET	place return address in location 07
	STD	07	
	JFI	01	jump to subroutine at RTN
		RTN	
RET		NEXT	
NEXT			continuation of program
RTN	.		<u>Subroutine</u>
	.		
	.		
	JPI	07	return to main program

Routine Four - Subroutine requiring three parameters. The parameters are in the three locations preceding the continuation of the main program.

MAIN	LDF	RET	
	STD	07	
	JFI	01	
		RTN	
RET		NEXT	parameter 1
			parameter 2
			parameter 3
NEXT			



The subroutine then is:

RTN	LCN	03	
	RAD	07	
	LDI	07	place first parameter
	STF	P1	
	AOD	07	
	LDI	07	place second parameter
	STF	P2	
	AOD	07	place third parameter
	LDI	07	
	STF	P3	
	AOD	07	set return subroutine
	JPI	07	return

#### PROGRAMMING AIDS

Programming aids supplied by Control Data Corporation include:

- Service Routines
- 160 Assembly Program
- Multiple Precision Package
- Floating-Point Package

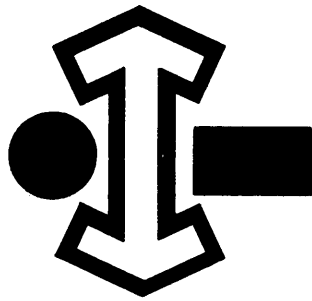

**CONTROL DATA CORPORATION**

501 Park Avenue, Minneapolis 15, Minnesota