

CONTROL DATA® 6000 SERIES COMPUTER SYSTEMS

CHIPPEWA LABORATORIES FORTRAN COMPILER RUN

Preliminary Edition

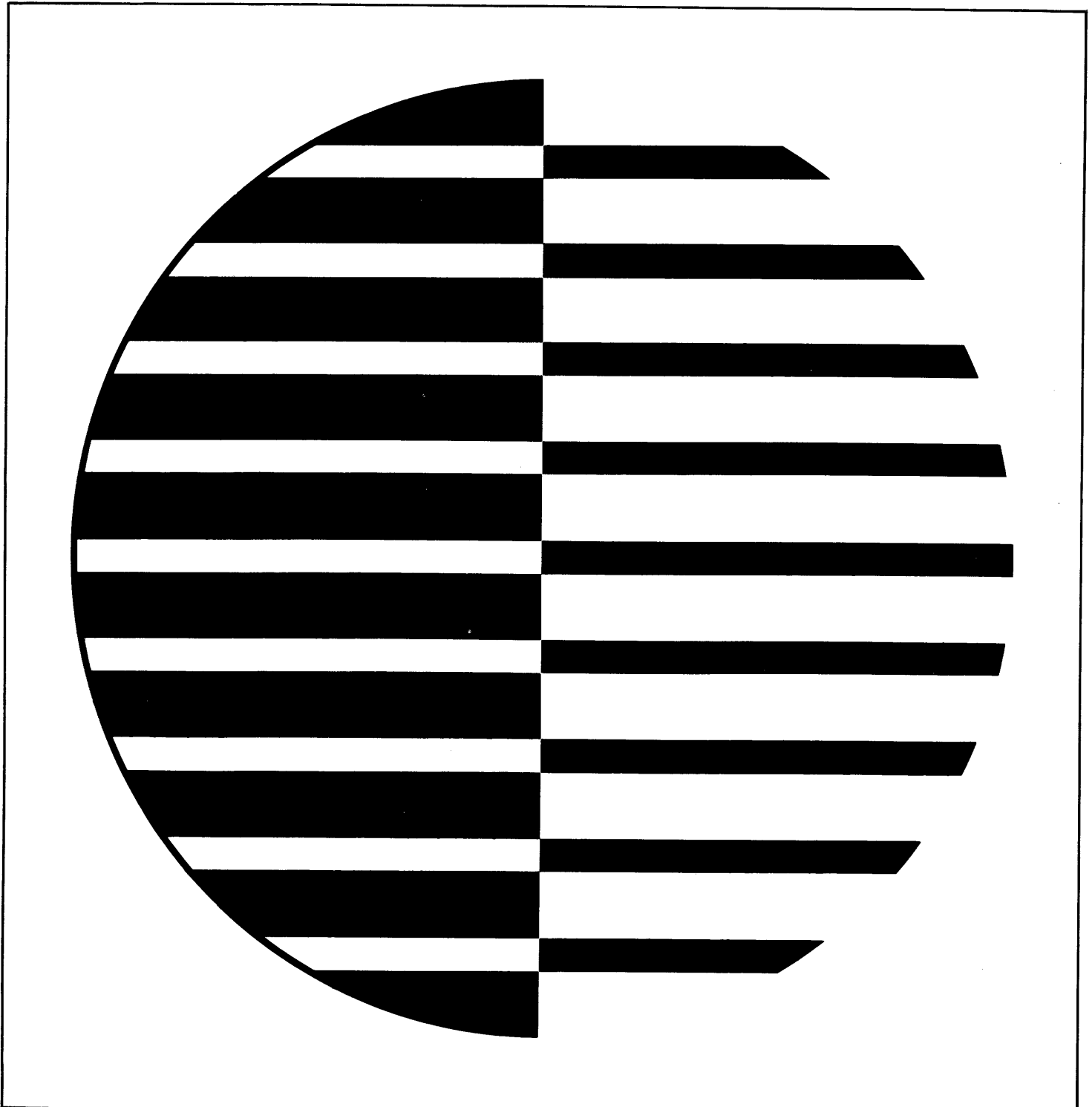

CONTROL DATA CORPORATION
DEVELOPMENT DIVISION - APPLICATIONS

CHIPPEWA LABORATORIES FORTRAN COMPILER

RUN

April 15, 1966

CHIPPEWA FORTRAN COMPILER - RUN

Revision 1

<u>Description</u>	<u>Add/Insert</u>
Simplified flow charts for the CXP subroutine (pages CXP-4, CXP-5)	Added to CXP subroutine description in section 3
CHAIN subroutine description	Inserted alphabetically in section 3
Sample compilation, sheets 1 - 3	Added sheets 1 - 3 at the end of section 2

CHIPPEWA FORTRAN COMPILER - RUN

TABLE OF CONTENTS

	<u>Section</u>
General Description	1
Statement Processing	2
Subroutine Descriptions	3
Compiler Flow Charts	A
Compiler Constants and Temporaries	B
Execution Time Routines	C

CHIPPEWA FORTRAN COMPILER - RUN

Section 1

GENERAL DESCRIPTION

INTRODUCTION

"RUN", the Chippewa Laboratory's FORTRAN compiler for the 6000 series computer systems, generates binary object code directly from FORTRAN II and FORTRAN IV source programs. The compiler also accepts programs written in a subset of the ASCENT assembly language, and in the MACHINE assembly language. The compiler also accepts certain Control Data 3000 series FORTRAN statements, such as ENCODE, DECODE, BUFFERIN, and BUFFEROUT.

The memory layout of the compiler is shown in Figure 1-1. The compiler routines are loaded into memory at location RA, and occupy 24,000₈ locations. Memory space for the compiler buffers and tables, which require approximately 6300₈ locations, is allocated downward from location FL. The minimum space required by the compiler is therefore approximately 32,300₈ locations. Unless adequate space has been reserved for the compiler (by specifying the proper value on the job card), the compiler will exit without attempting to compile.

The Input and Output buffers are used by the compiler in conjunction with the Chippewa Operating System's CIO peripheral package to read in source cards and to list the source and object programs. The transmittal of data between the various buffers is illustrated in Figure 1-2. Source cards from the input file on the disk are read into the Input buffer, which is 1001₈ words in length. As source cards are processed they are transferred, one at a time, into a 10₈-word card buffer. Within the card buffer, the source card is examined to determine if it is a statement card or a comments card. A statement card is transmitted to the string buffer, where it is initially packed one character per word, and another card is brought to the card buffer from the Input buffer. If the next card is a continuation card, it too is transferred to the

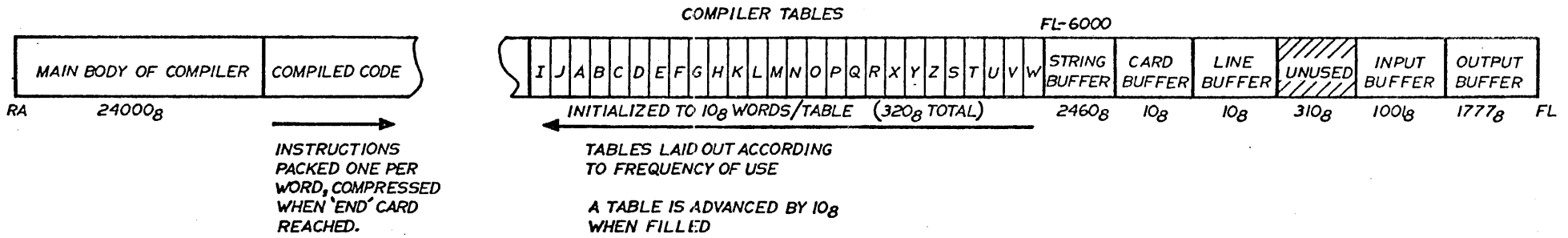

INITIAL COMPILER LAYOUT

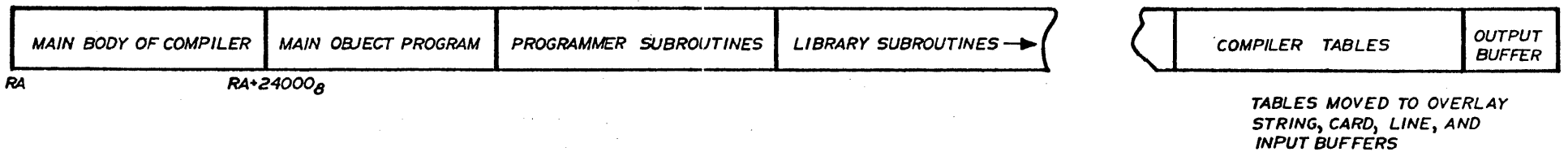

COMPILER LAYOUT DURING LIBRARY SUBROUTINE LOADING

Figure 1.1

string buffer. This process is repeated until an entire statement has been loaded into the string buffer. Since the size of the string buffer, in which a statement is initially packed one character per word, is 2460_8 or 1328_{10} , the number of continuation cards is limited to 19. All source cards, including both statement cards and comments cards, are transmitted directly from the card buffer to the Output buffer for subsequent listing. Depending upon the mode of compilation, object code instructions may be converted and placed in the line buffer (10_8 words), and from there transmitted to the Output buffer for listing.

Once a statement has been transmitted to the string buffer, the first four characters of the statement are examined to determine the statement type, and the appropriate subroutine is called to process the statement. Since the string buffer is packed one character per word, in most cases the next step is to assemble the contents of the string into a sequence of variables, constants and separators. Since memory assignments cannot be made until all source statements have been processed, variables and constants are replaced in the string by various types of tags, and the variables and constants stored in the compiler tables. (The compiler tables are expanded as entries are made.) The statement is then analyzed and the generated object instructions are packed one instruction per word. In all instructions referencing memory, the K portion of the instruction will at this point contain a tag. Thus, during the compilation of a program, the generated object code expands upward from $RA+24000_8$, and the compiler tables expand downward from $FL-6000_8$. When an END card is detected, the generated instructions are packed and memory assignments made. All tags other than those defining external references are replaced with addresses, and the compiler tables are reduced accordingly. Subsequent subprograms are read from the input file and compiled, the object code for each beginning where the object code of its predecessor ended. When the end of the input file is reached, library subroutines are loaded and all subroutine references are replaced with memory addresses. The compiled program is then written on the disk, and the compilation process terminated. Since the string buffer, card buffer, and line buffer are not required for the loading of library routines, the tables are moved up to overlay these buffers before the library routines are loaded (see Figure 1-2).

In processing MACHINE or ASCENT subprograms, the compiler transfers source

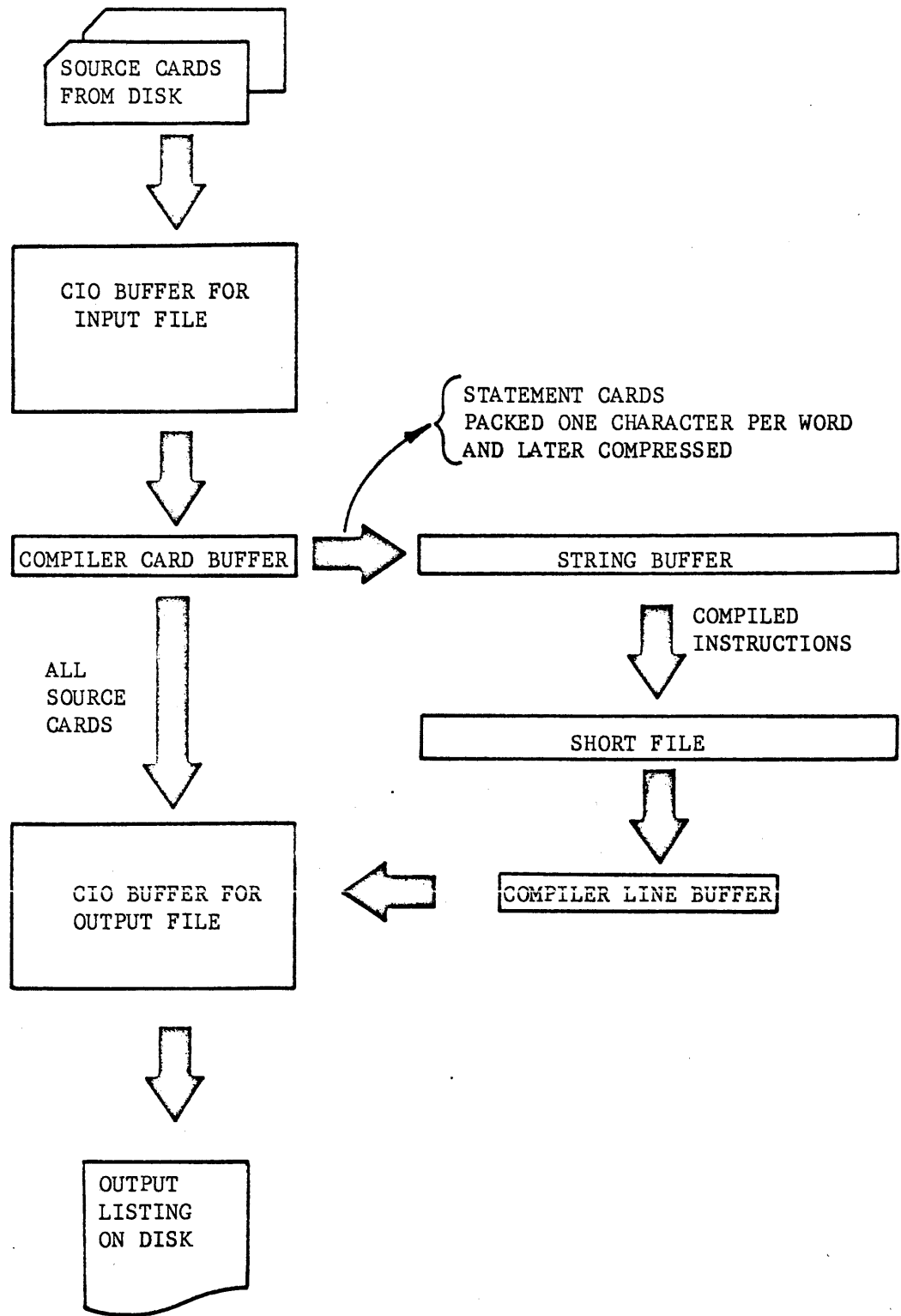

Figure 1-2

COMPILER BUFFER USAGE

cards to the string buffer in the manner described earlier. A subroutine is then called to process the assembly language record. Memory references are tagged, and the appropriate compiler tables entered. The assembled instructions are packed in the object program area. During the processing of the END card, the tags are replaced by memory addresses and constants are transferred from the appropriate table to the program area.

COMPILER TAGS AND TABLES

As constants, variables, subroutine and function names, and statement numbers are encountered in the processing of the source language statement in the string buffer, they are entered in one of the compiler tables and replaced in the string buffer by tags. The tags are entered in tables also, and their relative position within these tables corresponds to the table position of the constant, variable, external name or statement number which the tag replaced. Many of the compiler tables are used in pairs: the address-dependent quantity is entered in one table, and the tag which replaces it in the string buffer is also entered in the corresponding location in the following table. For example, the Constant Value Table (Table A) and the Constant Tag Table (Table B) are paired tables. When a constant is encountered in the source statement, it is converted to its binary equivalent and entered in the Constant Value Table. A Constant Tag is generated and entered in the string buffer, and also in the Constant Tag Table. Thus, if the constant was entered in location 35 of the Constant Value Table, the tag which replaced it in the string will be entered in location 35 of the Constant Tag Table.

The nine different types of tags used by the compiler are uniquely identified by the value of the high-order five bits of the tag. Tags are advanced as they are assigned: the current value of each tag is maintained in a temporary (TGA, TGB, etc.). All tags, with the exception of library tags, are re-initialized prior to the compilation of each subroutine. Library tags are initialized only when the compiler is first loaded. Tags are usually advanced by one, although they may be advanced by two when a double-precision or complex value is entered in a table. Library tags are advanced by 100_8 . The types of tags used by the compiler, and the numeric ranges which these tags may assume, are listed below.

<u>Current Tag Value</u>	<u>Tag Type</u>	<u>Tag Values</u>	<u>Listing Indicator</u>
TGA	Program Tag	200000-217777	L
TGI	Indirect Tag	220000-237777	I
TGT	Temporary Tag	240000-257777	T
TGK	Constant Tag	260000-277777	C
TGF	Function Tag	300000-317777	F
TGW	Array Tag	320000-337777	A
TGV	Variable Tag	340000-357777	V
TGH	Statement Tag	360000-377777	N
TGL	Library Tag	400000-600000	S

The listing indicator appears on the object code listing preceding the tag number as specified in the low-order 15 bits of the tag. The tag number as given in the low-order 15 bits may range from 0 to 17777₈. Thus, the compiler permits up to 8192 tags of each type.

Constants, variables, subroutine and function references, and statement numbers are entered in the compiler tables when they are encountered in the string buffer, as are the tags which replace these quantities. There are 26 of these tables. The location of these tables is shown in the compiler layout illustration of Figure 1-1. The size of each table is initially set at 10₈ words: as tables are filled, they are expanded by 10₈ words: tables at lower memory locations are moved down to provide room for the increase. Associated with each table is a temporary which contains the parameters required to enter, search, and expand the tables. The format of these temporaries (which are labelled in the compiler as TBA, TBB, etc.) is shown below.

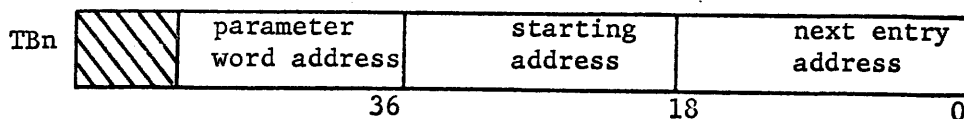

Note that this word contains its own address. This permits table scanning routines, which are entered with this word in an X register, to readily obtain the parameter word for the succeeding table in memory (i.e., parameter word address + 1 = parameter word address for the succeeding table).

TABLE ENTRY FORMATS

TABLE TAG	TABLE NAME	10	9	8	7	6	5	4	3	2	1	
TBA	CONSTANT VALUE	← CONSTANT										
TBB	CONSTANT TAG	K-TAG		[Hatched]								
TBC	TEMPORARY TAG	H-TAG		[Hatched]								
TBD	PERMANENT TAG	A-OR K-TAG		[Hatched]								
TBE	FUNCTION NAME	FUNCTION NAME							[Hatched]			
TBF	FUNCTION TAG	F-TAG		AC		AT		[Hatched]		M		
TBG	DO NUMBER	STATEMENT NUMBER							[Hatched]			
TBH	DO PARAMETERS	INDEX ADDRESS			INCREMENT			LIMIT			[Hatched]	
TBK	STATEMENT NUMBER	STATEMENT NUMBER							[Hatched]			
TBL	STATEMENT TAG	A,H-OR K-TAG		[Hatched]								
TBM	VARIABLE NAME	VARIABLE NAME							[Hatched]			
TBN	VARIABLE TAG	A,V, OR W-TAG		[Hatched]							M	
TBO	COMMON NAME	COMMON NAME							[Hatched]			
TBP	ARRAY TAG	A- OR W-TAG		BLOCK NAME							M	
TBQ	ARRAY PARAMETERS	1	[Hatched]							LENGTH		
		2	[Hatched]			DIMENSION 1			LENGTH			
		3	DIMENSION 1			DIMENSION 1×2			LENGTH			
		1	[Hatched]							A-TAG		
		2	[Hatched]			A-TAG			A-TAG			
		3	A-TAG			A-TAG			A-TAG			
TBR	DATA STATEMENT	TRANSLATED DATA STATEMENTS										
TBX	EQUIVALENCE 2 ND NAME	SECONDARY NAME							[Hatched]			
TBY	EQUIVALENCE 1 ST NAME	PRIMARY NAME							BASE ADDRESS			
TBZ	EQUIVALENCE BIAS	[Hatched]							BIAS			
TBS	SUBROUTINE NAME	SUBROUTINE NAME							LENGTH			
TBT	SUBROUTINE TAG	L-TAG		[Hatched]							M	
TBU	SUBROUTINE PARAMETER	CODE LENGTH			TOTAL LENGTH			STARTING ADDRESS			N	
TBV	COMMON BLOCK	BLOCK NAME							STARTING ADDRESS			
TBW	PROGRAM FILE NAME	[Hatched]							LIMIT ADDRESS			
		FILE NAME							ARGUMENT ADDR.			
		[Hatched]							BUFFER LENGTH			
TBI*	ARGUMENT NAME	FUNCTION ARGUMENT NAME							[Hatched]			
TBJ*	ARGUMENT TAG	F-TAG		[Hatched]							M	

M=MODE
AC=ARG.
COUNT
AT= ARG.
TRANS.
IND.

FOR
VARIABLE
DIMENSIONS

N=NO. OF
ARGUMENTS

2-WORD
ENTRY

2-WORD
ENTRY

TAG	BASE VALUE	TYPE	LISTING INDICATOR	MODE (M)	TYPE
TCA (A-TAG)	200000	PROGRAM TAG	L	0	NON MODE
TGI (I-TAG)	220000	INDIRECT TAG	I	1	LOGICAL
TGT (T-TAG)	240000	TEMPORARY TAG	T	2	FIXED-POINT
TCK (K-TAG)	260000	CONSTANT TAG	C	4	FLOATING-POINT
TGF (F-TAG)	300000	FUNCTION TAG	F	5	DOUBLE-PRECISION
TGW (W-TAG)	320000	ARRAY TAG	A	6	COMPLEX
TGV (V-TAG)	340000	VARIABLE TAG	V		
TGH (H-TAG)	360000	STATEMENT TAG	H		
TGL (L-TAG)	400000	LIBRARY TAG	S		

* THE I AND J TABLES ARE USED AS UTILITY TABLES BY A NUMBER OF ROUTINES, SUCH AS THE END STATEMENT PROCESSOR

COMPILER TABLES

Figure 1.3

The format of the table entries is shown in Figure 1-3. Note that some tag tables may hold more than one type of tag. Although there are 26 tables, several tables are used as paired tables (see table descriptions) and so, counting these tables as single multi-word entry tables, we may consider the compiler tables to be functionally fourteen in number.

The compiler tables, and the manner in which the tags and tables are used in the compilation process, are briefly described below.

Constant Value Table;

Constant Tag Table: When a constant is encountered in the translation of a source language statement, it is converted to its equivalent binary form and entered in the Constant Value Table. A Constant Tag (K-tag) is generated, and entered in the corresponding location in the Constant Tag Table. The Constant Tag replaces the original constant in the string. The instruction compiled to fetch the constant will be of the form $SA_i = K\text{-tag}$. Constants which are integer or octal in mode, and less than $2^{16}-1$ in absolute value, are not entered in the Constant Value Table (unless they are subroutine arguments). The instruction compiled for a constant of this type will be of the form $SX_i = K$, where K is the constant value. The Constant Value Table is also used to store format statements during compilation. The format descriptors are packed in consecutive words of the Constant Value Table, 10 characters per word, and a Constant generated and entered in the Constant Tag Table for each word. Subsequent references to the format statement will be compiled with the Constant Tag associated with the first word of the format statement. Prior to entering a constant in the Constant Value Table, the table is scanned to determine if a constant of the desired value has been defined earlier and, if so, the tag associated with the earlier entry is used rather than generating a new tag and a new entry.

Temporary Tag Table;

Permanent Tag Table: These tables are most commonly used when a source program statement references another part of the program which has not yet been compiled, e.g., a GO TO n statement where statement n has not yet been processed. Reference points within the compiled program are defined by program tags (A-tags). The Temporary Tag Table provides a means of recording references to points as yet undefined in the program: The manner in which this is accomplished is illustrated in Figure 1.4.

GØ TO 10

INITIAL STATEMENT PROCESSING

- ENTER "10" IN THE STATEMENT NUMBER TABLE (TABLE K)
- GENERATE A STATEMENT TAG (H-TAG) AND ENTER IT IN THE CORRESPONDING LOCATION IN THE STATEMENT TAG TABLE (TABLE L)
- ENTER THIS STATEMENT TAG IN THE TEMPORARY TAG TABLE (TABLE C):
RESERVE CORRESPONDING ENTRY IN THE PERMANENT TAG TABLE (TABLE D)
- COMPILE INSTRUCTION: 0400 H-TAG

WHEN STATEMENT 10 IS ENCOUNTERED

- GENERATE PROGRAM TAG (A-TAG) FOR FIRST INSTRUCTION COMPILED FOR THIS STATEMENT
- SEARCH STATEMENT NUMBER TABLE FOR THIS STATEMENT NUMBER: WHEN FOUND, GET CORRESPONDING ENTRY FROM STATEMENT TAG TABLE
- SEARCH THE TEMPORARY TAG TABLE FOR THE STATEMENT TAG (H-TAG) OBTAINED FROM THE STATEMENT TAG TABLE: WHEN FOUND, ENTER THE PROGRAM TAG (A-TAG) IN THE CORRESPONDING LOCATION IN THE PERMANENT TAG TABLE
- REPLACE THE STATEMENT TAG (H-TAG) IN THE STATEMENT TAG TABLE ENTRY CORRESPONDING TO THE STATEMENT NUMBER WITH THIS PROGRAM TAG (A-TAG)

USE OF TEMPORARY & PERMANENT TAG TABLES: EXAMPLE

Function Name Table;

Function Tag Table: When an arithmetic statement function is encountered, the function name is entered in the Function Name Table, and a Function Tag is generated and entered in the Function Tag Table. Subsequent references to this function name are replaced in the string by the Function Tag. When this tag is processed, instructions are compiled to pass the arguments, and then an RJ F-tag is compiled to enter the coding compiled for the arithmetic statement function.

DO Number Table;

DO Parameter Table: When a DO statement is encountered, the statement number which terminates the DO loop is entered in the DO Number Table. Instructions are then compiled to initialize the DO index. The address of the SA6 instruction compiled to store the initial value in the index (i.e., the index store), and the Variable tags (or constants) for the increment and limit values are stored in the DO Parameter Table. Each time a statement number is processed, the DO Number Table is scanned to determine if the statement number terminates a DO loop. If it does, the entry in the DO Parameter Table corresponding to the statement number is obtained, and the limit and increment tags (or constants) used to compile the index increment and test instructions. When the index store instruction was compiled, it was tagged with a Program tag (A-tag). In processing the statement number which terminates the DO, the address of the index store instruction is obtained from the DO Parameter Table entry, and a PL or NG A-tag instruction compiled to provide the loop return.

Statement Number Table;

Statement Tag Table: Whenever a statement number is encountered in a source language statement, it is entered in the Statement Number Table (unless previously entered), and a tag is entered in the corresponding entry in the Statement Tag Table. This tag may be a Statement Tag, a Program tag, or a Constant tag. If the first reference to the statement number defines it (i.e., if it is first encountered in the statement number field), a Program tag (A-tag) is entered in the Statement Tag Table. This Program tag will also be used to tag the first compiled instruction for the statement which had this number. The case where the statement number is referenced before it is defined was discussed

earlier (see Figure 1.4). In this case, a Statement tag (H-tag) is generated and entered in the Statement Tag Table. This tag is later equated to a Program tag through the use of the Temporary and Permanent Tag Tables. If the statement number refers to a format statement, a Constant tag is entered in the Statement Tag Table. This Constant tag defines the starting location of the format statement in the Constant Value Table.

Variable Name Table;

Variable Tag Table: When a variable is first encountered in a source program, the variable name is entered in the Variable Name Table, and a tag is entered in the corresponding location in the Variable Tag Table. If the variable is not dimensioned, a Variable tag (V-tag) is generated and entered in the Variable Tag Table. If the variable is first encountered in a DIMENSION statement, an Array tag (W-tag) is generated and entered in the Variable Tag Table. Should the variable be an argument in a subroutine, a Program tag is entered in the Variable Tag Table. This Program tag will indicate where this value is located in the subroutine argument list which follows the subroutine entry point.

Common Name Table: When a COMMON statement is encountered, it is entered in the Common Name Table to be subsequently processed when the END statement is encountered. Common block names appear in the lower 42 bits, while common variable names appear in the upper 42 bits.

Array Tag Table;

Array Parameter Table: When a variable is encountered in a DIMENSION statement, the variable name is entered in the Variable Name Table, and an Array tag is entered in the corresponding entry in the Variable Tag Table. This Array tag is also entered in the Array Tag Table, while the dimension parameters are entered in the corresponding location in the Array Parameter Table (see Figure 1.3 for the format for 1, 2, and 3-dimensional arrays). If the dimensions are variables, the Array Parameter Table will contain a Program tag (A-tag) for each dimension parameter. This program tag will indicate where this value is in the argument list which follows the subroutine entry point. If the dimensions are constants, the Array Parameter Table will contain the values of the dimensions and (for 3-dimensional arrays) dimension product.

Data Statement Table: When a DATA statement is encountered, it is partially translated (i.e., variables are replaced by tags, constants are converted, etc.) and entered in the Data Statement Table to be subsequently processed when the END statement is encountered.

Equivalence Second Name Table;

Equivalence First Name Table;

Equivalence Bias Table: When an EQUIVALENCE statement is encountered, the variable names and bias values specified in the statement are entered in the equivalence tables. The equivalence tables are processed when the END statement is encountered.

Subroutine Name Table;

Subroutine Tag Table;

Subroutine Parameter Table: When a SUBROUTINE, FUNCTION, or CALL statement is encountered, or when a function subprogram reference is found, the subprogram name is entered in the Subroutine Name Table. A Library tag (L-tag) is generated and entered in the corresponding location in the Subroutine Tag Table. When the subprogram is compiled, the length of the compiled code, the total length (including compiled code, constants, local variables, etc.), the starting address, and the number of arguments are assembled into a single word and this word is entered in the Subroutine Parameter Table entry which corresponds to the subroutine name. The first entry made in each of these tables is for the main program.

Common Block Table: The Common Block Table is one of the tables in which entries occupy two consecutive locations. When the COMMON statement is first encountered, the common name and the block name are entered in the Common Name Table. During the processing of the END statement, the block name, together with the starting and ending address of the block, is entered in the Common Block Table in the format shown in Figure 1.3.

Program File Name Table: When a PROGRAM card is encountered, the arguments on the card are entered in the Program File Name Table in two consecutive words. The first word contains the file name and the address

of the CIO parameters for the buffer assigned (the CIO parameters occupy the first 10_8 words of the buffer area). The second word of the Program File Name Table contains the buffer length for the file. If no buffer length is specified, this length entry is set to 2010_8 . (This includes the space occupied by the CIO parameters.)

Argument Name Table;

Argument Tag Table: Although the nominal purpose of these tables is to assist in the processing of arithmetic statement functions, the Argument Name and Argument Tag Tables serve as compiler utility tables, and are used for a variety of purposes. For example, these tables are used in processing the EQUIVALENCE statement, in computing array references, and in processing the END statement.

While most of the compiler tags define quantities appearing in a source statement, the program tag (A-tag) is used to define locations within the compiled object code. During the compilation process, the generated instructions are packed in the upper 30 bits of a word, one instruction per word. All address fields in the generated instructions contain tags of various types. When the END statement is encountered, these tags are replaced with addresses and the object code is then compressed. When instructions are compiled for a statement which has a statement number, a program tag is entered in the low-order 18 bits of the word containing the first instruction compiled for this statement. For example, a statement such as $I = 0$ might be compiled as

SX6 = 0	:	
SA6 = V-tag	:	

if it were an un-numbered statement. If, however, this statement had a statement number, it might be compiled as

SX6 = 0	:	A-tag
SA6 = V-tag	:	

This program tag serves two purposes. First, a source program transfer of control to the numbered statement will result in the compilation of a jump instruction in which the address field contains this program tag. When the END statement is processed and the object code is compressed,

the program tag in instructions referencing the first instruction compiled for the numbered statement will be replaced with the address of this first instruction. Secondly, since the appearance of a program tag in the low-order bits of a word containing a compiled instruction indicates that this instruction is referenced elsewhere in the program, the instruction must be forced to the upper parcel(s) of a word when the object code is compressed.

Program tags are also used to define subroutine parameters. Since all tags (with the exception of library tags) are initialized at the beginning of subroutine compilation, there is a fixed relationship between the value of the program tag and the parameter number, as shown below.

<u>Subroutine Word No.</u>	<u>Contents</u>	<u>Program Tag</u>
1	Subroutine Name	L00002
2	Number of Arguments	L00003
3	Parameter 1	L00004
4	Parameter 2	L00005
⋮	⋮	
n	Parameter m	L0000(M+3)
n+1	Entry Line	L00001

Since the first six parameters (i.e., argument addresses) of a subroutine are also passed in a B register, there is a fixed relationship between the parameter number, the register in which it appears, and the program tag assigned to the parameter.

Register Associates

To assist in minimizing the number of fetches generated, the compiler utilizes 19 temporaries called Register Associates. These temporaries are associated with registers A0-A5, B1-B7, and X1-X6. As instructions are compiled for a source language statement, these Register Associates are updated to reflect the contents which the X, A, and B registers will have during the execution of the object program. For example, suppose an SA2 instruction is compiled to fetch a variable. The address field of the SA2 instruction will contain a variable tag (V-tag) which will be replaced by an address during the processing of the END statement. When this instruction is compiled, this variable tag is entered in the X2 and

A2 Register Associates, indicating that the X2 register contains the value of the variable while the A2 register contains its address. Before compiling a subsequent fetch, the Register Associates are examined to determine if the value is already available or, failing that, if the address is available and a 15-bit fetch instruction can be generated (i.e., in place of a 30-bit fetch instruction). Should subsequent instructions be compiled which use the X2 register as a result register, the X2 Register Associate will be cleared.

Compiler Master Loop

The flow chart for the compiler master loop is shown on pages A-1 and A-2 of Appendix A. The master loop may be considered as being composed of an outer loop and an inner loop. The outer loop controls program and subprogram processing, while the inner loop controls statement processing. The main functions of the compiler master loop are described below.

COMPILER INITIALIZATION

After clearing the Chain and Error indicators, the compiler calls the peripheral processor package "CHK" to determine the status of the OUTPUT file. This status is subsequently used to determine what, if any, repositioning of this file is required. The compiler then picks up the field length from the A0 register and, unless a field length of at least 32000₈ words was specified, immediately exits. If the specified field length was adequate, the Initialize for Input/Output (IIO) routine is called to set up the compiler buffers and to process the compiler arguments from the RUN card. These arguments are passed to the compiler in locations RA+2, RA+3, etc., during the loading of the compiler. The order in which these arguments appear, and the value assigned by the compiler if an argument is omitted, are shown in Figure 1-5. IIO also enters the string buffer starting address (FL-6000) in the A0 register, where it will remain for the duration of compilation. Next, the Read Next Card (RNX) subroutine is called to bring the first card to the

COMPILER ARGUMENTS

		<u>VALUE IF NOT SPECIFIED</u>
RA + 8	LINE LIMIT	20000 ₈
RA + 7	OUTPUT FILE	"OUTPUT"
RA + 6	INPUT FILE	"INPUT"
RA + 5	BUFFER LENGTH	2010 ₈
RA + 4	COMMON LENGTH	AS PER MAIN PROG.
RA + 3	PROGRAM LENGTH	JOB LENGTH
RA + 2	COMPILE MODE	"G"
RA + 1	0_____0	
RA	0_____0	

NOTE: THE FIELD LENGTH FROM THE JOB CARD IS IN A₀ ON ENTRY.

Figure 1-5

Card Buffer. This routine is used throughout the compiler to transfer a card from the Input Buffer to the Card Buffer and, if the Input Buffer is empty, to initiate a CIO call to fill the buffer. The Initialize Program Tables (IPT) subroutine is called to initialize the Library tag, set the Short File Start and Long File Start, and to set up the Subroutine Parameter, Common Block, and Program File Name Tables. These tables are initialized only at the beginning of compilation: all other tables, with the exception of the Argument Name and Argument Tag Tables, are initialized each time a program or subprogram is compiled. The Argument Name and Argument Tag Tables are initialized as required.

The Initialize Subroutine Tables (IST) routine is called next. This subroutine initializes the remaining tables and tags, and sets A7 to the Short File Start address. During compilation, the A7 register will always contain the address of the last instruction compiled and X7 will be used to store instructions as they are compiled. (Note: the return to compile the next subroutine is made to this point in the master loop.) RNX brought the first card into the card buffer: this card is examined to determine if it contains a + or - in column 1. If it does, then the following program or subroutine is not a source program but a binary deck, and control is transferred to the END statement processor which will load the binary object deck, extract any external references, and enter these in the Subroutine Name Table. If the first card does not contain a + or - in column 1, the Assemble FORTRAN Statement (AFS) subroutine is called. This subroutine transfers source cards from the card buffer to the string buffer, packing one character from the card

SUBPROGRAM
INITIALIZATION

into one word in the string buffer. AFS also transmits the source card to the Output Buffer (via the WNX routine) for listing. Next, AFS brings the next card to the card buffer and examines it to determine if it is a continuation card. If it is, it is also loaded in the string buffer. If the next card is a comments card, AFS transmits it to the Output Buffer. This process is repeated until AFS finds a non-comments, non-continuation card in the card buffer.

The first seven letters of the statement assembled in the string buffer by AFS are examined to determine if they are ASCENTF, MACHINE, or FORTRAN. If these letters are ASCENTF or MACHINE, the subprogram mode indicator (and subsequently the program mode indicator, if this is a main program) is set to -2 or -1, respectively. If these letters are FORTRAN, the next two letters are examined to determine if they are II, IV, or VI, and the mode indicator(s) set accordingly. If the card does not begin with ASCENTF, MACHINE, or FORTRAN, a FORTRAN IV compilation is assumed. (This mode is set by the Initialize Program Tables subroutine.) If these letters appeared on the first card, they are blanked out and the next seven letters are assembled. These letters are compared with entries in the table of Program Title Types: PROGRAM, SEGMENT, SUBROUT, FUNCTIO, END, and BLOCKDA. If not found in this table, the letters are examined to determine if they are the FUNCTION predecessors DOUBLE PRECISION, DOUBLE, READ, INTEGER, LOGICAL, or COMPLES. If they are, the function type indicator is set accordingly, these letters are blanked out, and the next seven letters assembled and checked. The header card is passed on to the inner portion of the compiler's master loop for processing. If the card was a PROGRAM card, the Program/Subprogram Indicator is set to zero; otherwise, it is set to a non-zero value. This indicator is

DETERMINING
COMPILATION
MODE

examined by the END statement processor to determine if tags should be replaced by absolute memory addresses or by memory addresses relative to the start of the subprogram when subroutines are separately compiled.

STATEMENT
PROCESSING
INITIALIZATION

The statement processing portion of the compiler master loop is now entered. (The program title card, or header card, is passed on to this portion of the compiler master loop for processing.) Various statement-related flags and indicators are cleared, and a program tag is generated and saved as the Current Program Tag. The Get Statement Number (GSN) routine is called to assemble the statement number, if any, associated with this statement. Processing of this statement number will be performed after this statement has been compiled.

STATEMENT
RECOGNITION

Column 1 of the source card is checked to see if it contains an F (FORTRAN II external function) and, if it does, the Process Function Name (FUN) subroutine is called to process the function. If the statement is not a FORTRAN II external function, the first two letters are examined and, if these letters are DO. If they are, the Sense DO Statement (SDO) subroutine is called to determine if the statement is a DO statement and to initiate DO statement processing. If the statement is not a DO statement, the Sense Formula (SFO) subroutine is called to determine if the statement is an arithmetic statement and to initiate arithmetic statement processing. If the statement is not a FORTRAN II external function, a DO statement, or an arithmetic statement, the first four letters of the statement are assembled and used to scan a Statement Letter group Table. If the statement is not found in this table, and the four letters are not TYPE, a Format Error diagnostic is generated. If the statement is found in this table, the Current

Jump and Continue indicators are processed, and a jump table used to transfer control to the appropriate statement processing routine. (Note that the relative location of the statement within the Statement Letter group table indicates if the statement is executable or non-executable.

RETURN FOR
NEXT
STATEMENT

Statement processing routines generally enter the Process Statement Number (PSN) subroutine upon completion of statement processing, and this routine in turn returns control to the compiler master loop. If the program title card called for a MACHINE or ASCENTIF assembly, the Process Machine/Ascent Records (MAA) subroutine is called.

CHIPPEWA FORTRAN COMPILER - RUN

Section 2

STATEMENT PROCESSING

INTRODUCTION

At the time the statement processing routine is entered from the compiler master loop, the source language statement in the string buffer is packed one character per word. Most statement processing routines call the Normalize Statement (TAB) subroutine. The TAB subroutine (see TAB description in Section 3) assembles the contents of the string buffer into a series of words containing variable, constants (which may occupy more than one word) and separators. The TAB subroutine also enters the format statement in the Constant Value Table. Next, the Translate Individual Quantities (TIQ) subroutine is called. TIQ translates the contents of the string buffer into a sequence of tags, separators, and constants which can easily be manipulated by the statement processing routines. The TIQ subroutine is discussed in Section 3.

There are two indicators which are tested during the processing of most executable statements as well as in the compiler master loop. One of these is the Current Jump Indicator, which is used in the processing of arithmetic statement functions and logical IF statements. Since arithmetic statement functions may occur anyplace within the source program, it is necessary to compile a jump over the code generated for a function. Therefore, before compiling the instructions for the function, a Statement Tag (H-tag) is generated and entered in the Temporary Tag Table, the corresponding entry in the Permanent Tag Table is reserved, and an 0400 H-tag instruction is compiled for the jump over the generated code for the function. The Current Jump Indicator is set to the address of this jump within the compiled code. Similarly, in the case of the Logical IF statement, a jump instruction over the coding generated for the TRUE condition must be compiled. In this case, an 0200 H-tag is

compiled and the Current Jump Indicator set to the address of this jump instruction. The Current Jump Indicator is carried along during the processing of non-executable statements and other arithmetic statement functions. When an executable statement is encountered, a Program tag is used to tag the first instruction compiled for this statement. The address contained in the Current Jump Indicator is used to obtain the jump instruction, and the Statement tag (H-tag) is extracted from the jump instruction. The Temporary Tag Table is then searched for the entry containing this tag, and the Program tag (A-tag) entered in the corresponding location in the Permanent Tag Table, thus equating the two tags. The use of the Current Jump Indicator is illustrated in Figure 2.1.

A second indicator which must be examined when a statement is compiled is the Continue Indicator. If a CONTINUE statement is encountered which does not terminate a DO loop, the Continue Indicator is set. This indicates that the A-tag which otherwise would be generated for the CONTINUE statement is instead to be assigned to the first executable statement following the CONTINUE statement. This is accomplished by the compiler master loop which, during the initialization performed for each statement, generates a Program tag and enters it in the X7 register, thus tagging the first instruction compiled for the next statement. If the Continue Indicator is set, this tag is left in X7 for subsequent processing. If the Continue Indicator is not set, the X7 register is cleared before a transfer to the statement processing routine takes place.

HEADER CARDS

Five different types of header cards are acceptable to the FORTRAN compiler: PROGRAM, SEGMENT, FUNCTION, SUBROUTINE, and BLOCKDATA. All but the last may have formal parameters included on the card. BLOCKDATA is a special type of subprogram which contains only declarative statements. PROGRAM and SEGMENT are closely related because the name appearing on the card of either is the identifying name of file on the disk containing the object program as the first record. Each of these files may contain many SUBROUTINE and/or FUNCTION subprograms.

LOGICAL IF COMPILATION

ARITHMETIC STATEMENT FUNCTION
COMPILATION

Figure 2.1

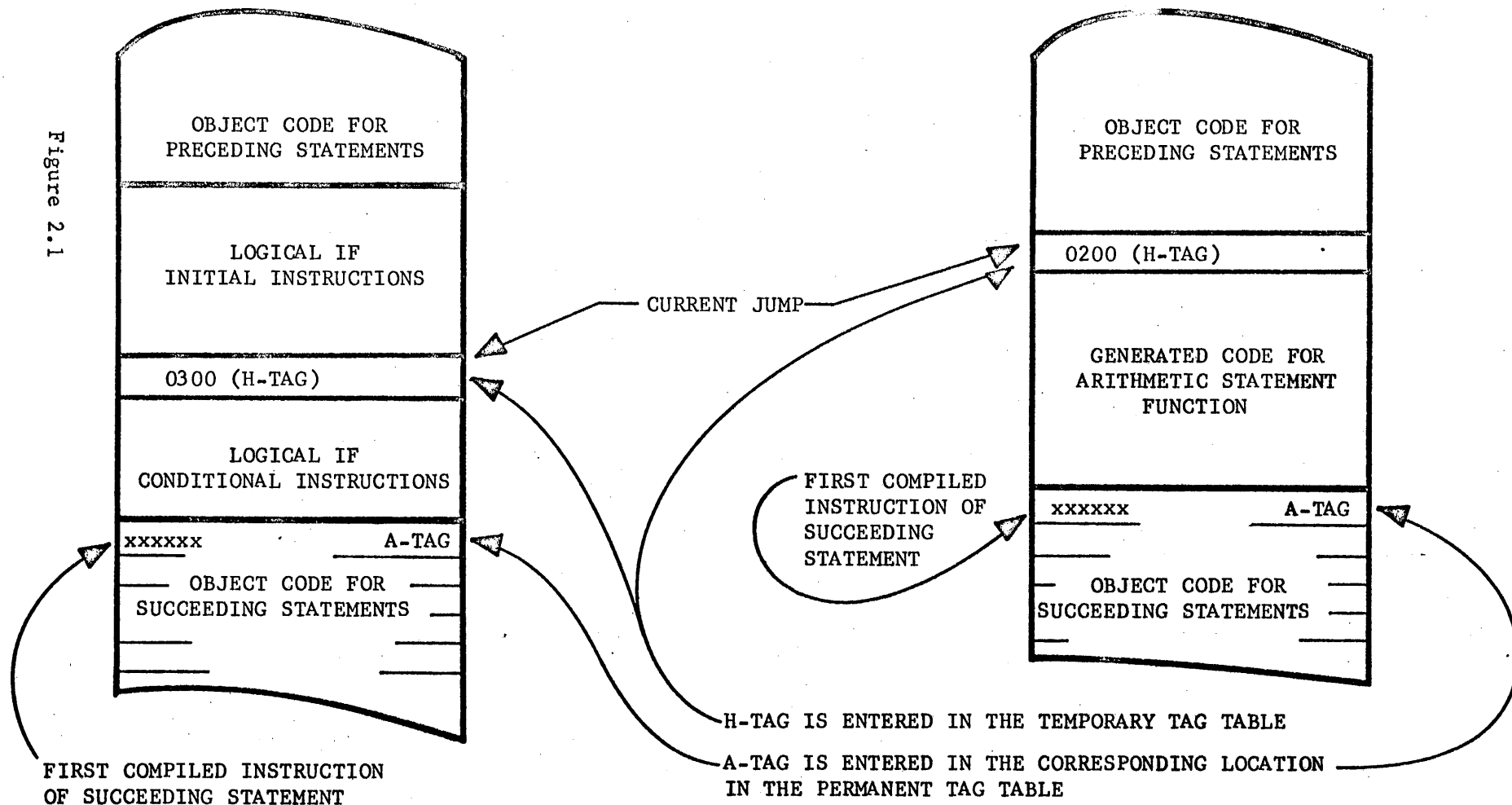

USE OF THE CURRENT JUMP

PROGRAM and SEGMENT differ in that numbered or blank common and the I/O buffers are initialized with a PROGRAM declaration but not with SEGMENT. Both are compiled to be read in from the disk beginning at RA. Any SEGMENT called will completely overlay the main program and its subroutines, but the I/O buffers and common will not be disturbed. A SEGMENT may be called repeatedly by any other segment or from the main file, and arguments may be transferred through COMMON. Any SUBROUTINE or FUNCTION referenced within a SEGMENT must be compiled with it because no portion of the main program or previous segment is available for use. The maximum number of I/O files referenced by the main program or any segments called must be declared on the PROGRAM card because only in this way is the buffer reserved for the file. All segments to be chained must be compiled with the same file names.

If no length is specified on either the RUN card or PROGRAM card for the buffers, then 2010_8 words are reserved for each file declared. An individual buffer length may be specified on the PROGRAM card which will override that specified on the RUN card, but neither length may be less than 1001_8 words. Equivalenced files will utilize the same buffer. Instructions are compiled to initialize buffer parameters, to set unused memory space to indefinites and blank or numbered common area cleared to zero upon encountering the PROGRAM card.

The mode of the FUNCTION is set from the preceding type declaration or by checking the first character of the name. This mode must agree with the type from a previous reference or the diagnostic "FUNCTION TYPE ERROR" results. An "ARGUMENT COUNT ERROR" identifies a previous call requiring more arguments than are being compiled. All arguments on a SUBROUTINE or FUNCTION card receive a location tag pointing to a reserved word beginning at the third relative word of the subprogram. Since the addresses of the first six arguments are passed to the subprogram via index registers B1-B6, instructions are compiled to pack the address, three per word, into two temporary words. B1 and B4 occupy the lower 18 bits of the two words with B2 and B3 packed in the next 18 bit portions of the first word. B5 and B6 reside in the second word in the same relation as B2 and B3.

A more detailed discussion of this initialization process is contained in the Process Name and Arguments (PPG) subroutine description in Section 3.

DO STATEMENT PROCESSING

In initialing the processing of a source language statement, the compiler master loop checks the first two letters of the FORTRAN statement to see if they are "DO". If they are, a routine called Sense DO Statement (SDO) is called to determine if the statement is actually a DO statement. The basic steps performed by SDO are tabulated in Figure 2.2. SDO scans the first part of the statement to determine if it has the sequence

$$[DO] [number] [variable] [=]$$

If this sequence is found, SDO scans the Variable Name Table for the variable and, if found, examines the corresponding tag from the Variable Tag Table to determine if the mode indicator for the variable is a 2 (integer mode). If the variable is not in the Variable Name Table, the first letter of the variable is checked to determine if it is I, J, K, L, M, or N. If the above sequence is found, and if the variable is an integer variable, SDO assumes that the statement is a DO statement, and proceeds with DO initialization processing.

The TAB subroutine is called to normalize the statement. Since executable instructions will be compiled to initialize the DO loop, the Current Jump and Continue indicators are processed. If the DO statement itself was numbered, a Program Tag (A-tag) is entered in X7 to tag the first executable instruction of the DO statement. Next, the TIQ subroutine is called to translate the statement into a sequence of separators, tags, and constants. TIQ will make any necessary entries in the Variable Name and Constant Value Tables.

The CDI (Compile DO Initial Instructions) subroutine is then called to compile the DO loop initialization instructions. The basic steps performed by this routine are illustrated in Figure 2.2. CDI enters the statement number (of the DO termination statement) in the DO Number Table (Table G), and then examines the string entry for the initial value (i.e., n_1) to determine if the initial value is a variable or a constant. If the initial value is a constant, CDI compiles an SX6 = K instruction to set the initial value. Should the initial value be a variable (i.e., as indicated by a variable tag in the string) CDI calls

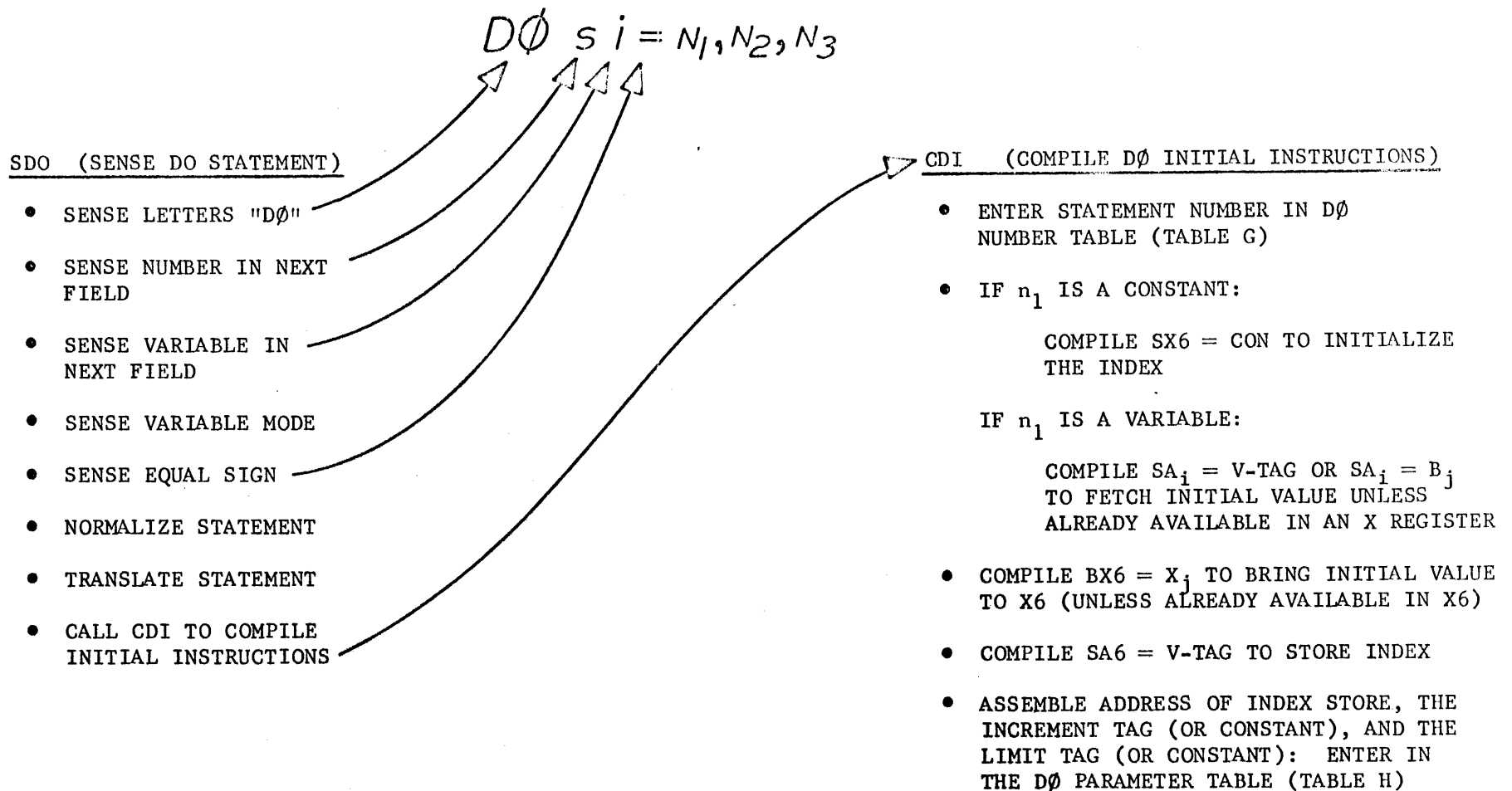

Figure 2.2

DO STATEMENT PROCESSING

the CIR (Compile Read Instructions) subroutine to compile a fetch instruction for the initial value. It is possible that the variable used as the initial value may (at execution time) be available in an X register. In this case, CIR will not generate a fetch instruction, but will supply CDI with the number of the X register in which the variable can be found at execution time. Whether or not a fetch instruction had to be compiled, CDI next compiles a $BX6 = X_1$ instruction to bring the initial value to a write register.

CDI next compiles an SA6 = Variable Tag instruction to store the initial value in the index location. A program tag (A-tag) is set in the lower half of the word in which this compiled instruction is stored, since this instruction is the return point from the bottom of the DO loop. Next, CDI examines the string to determine if an increment has been specified. If an increment has not been specified, the increment value is set to 1. If there is an increment entry in the string buffer, CDI examines the entry to determine if it is a variable tag for an integer variable or a constant. If it is not, an error exit occurs. The limit field is similarly checked. An example of the initial code compiled for the DO is shown in Figure 2.3.

Finally, CDI assembles the address of the index store instruction, the increment tag or constant, and the limit tag or constant into a single word (see Figure 1-3 for the format), and enters this word in the DO Parameter Table, (Table H). When the statement number of the statement which terminates the DO loop is encountered, these parameters will be used to compile the index test instructions. Processing of the DO is now complete, and so CDI jumps to PSN (Process Statement Number) to process the statement number, if any, associated with the DO statement, and from there control is returned to the compiler master loop for processing of the next statement.

Each time the compiler master loop processes a source statement, it calls the GSN (Get Statement Number) to perform the initial statement number processing. GSN determines if the statement which is about to be processed has a statement number, and, if so, extracts this statement number from the string buffer. GSN then scans the Statement Number Table and the DO Number Table for this statement number: if the

DO LOOP INITIALIZATION CODE

Figure 2.3

2-8

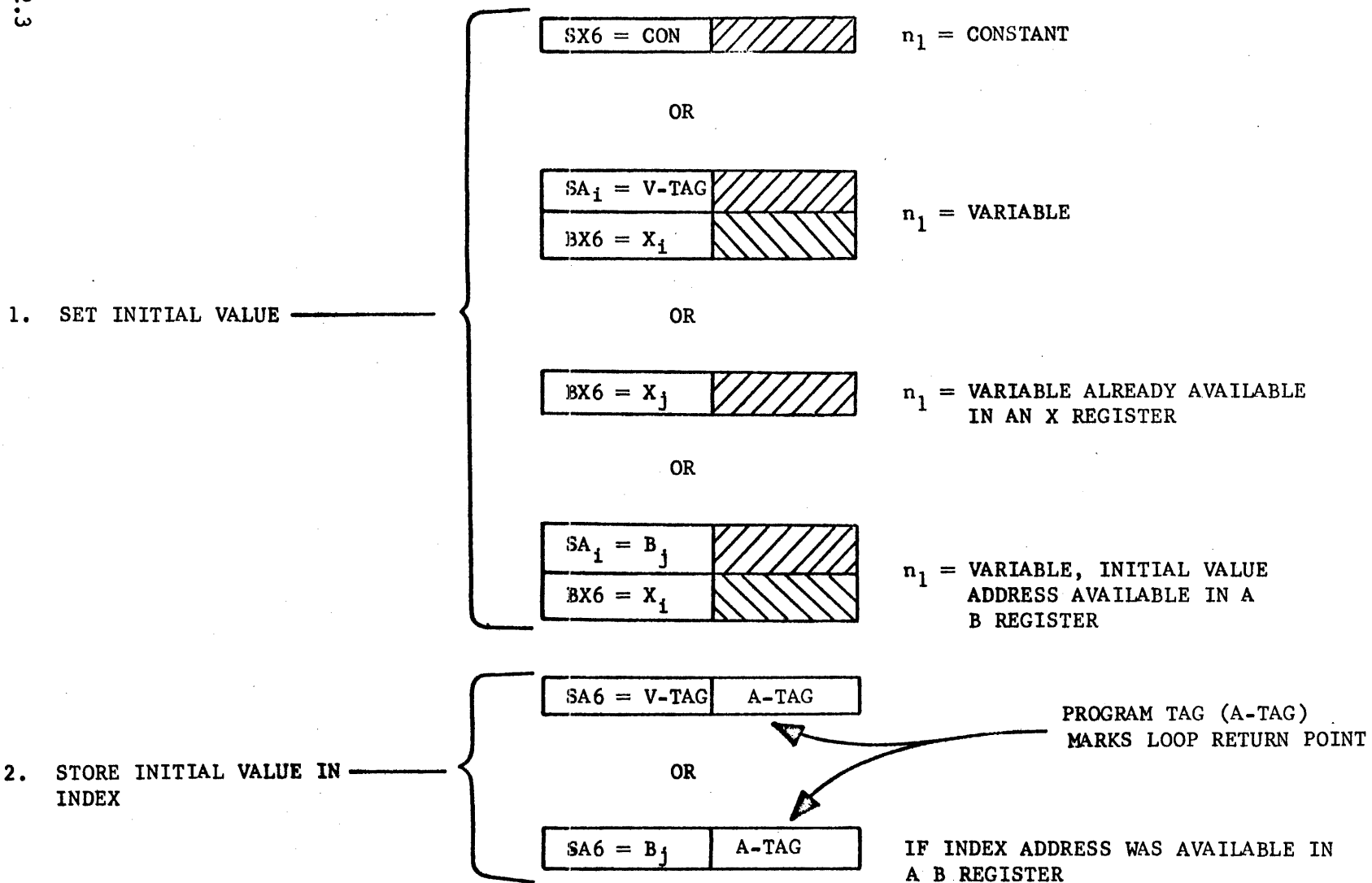

statement number is found in both tables, the DO termination indicator is set. The instructions for this statement are then compiled (unless the statement is a CONTINUE statement) and then the PSN (Process Statement Number) is called to process the statement number.

PSN checks the DO termination indicator: if this indicator is not set, PSN scans the Statement Number Table for the statement number and, if not found, enters the statement number in the Statement Number Table. The current program tag (A-tag) is entered in the Statement Tag Table, and the PDT (Process DO Tables) subroutine is called to compile the index test instructions. PDT first checks the Continue Indicator and the Current Jump Indicator, and processes these indicators if they are set. Next, the DO Number Table is scanned and, when found, the corresponding entry in the DO Parameter Table is saved. This entry is then deleted from the DO Number Table. The address of the index store instruction is then compared with the start of the group of instructions compiled for this statement (i.e., the DO termination statement) to determine if this is a one-statement DO. If so, an indicator is set, since one-statement DO loops are later analyzed to determine if the generated object code can be improved.

Next, the index store instruction was examined to determine if it was an SA6 = B_j instruction. If it was, the index address was the parameter of the subroutine, and so a Program tag can be formed by adding the B register number to a base tag value of 200003 (see page 1-14). If the index store was an SA6 = V-tag instruction, the Variable tag (V-tag) is extracted from the instruction. The Variable tag or Program tag which defines the location of the index is passed to the Compile Read Instructions (CIR) subroutine. CIR will generate a fetch instruction (if necessary) to fetch the index value. The increment parameter is next extracted from the DO Parameter Table entry, and examined to determine if it is a Variable tag or a constant. If the increment parameter is a Variable tag, the Analyze Loop Conditions subroutine is called to determine register availability, and the CIR subroutine called to compile a fetch instruction. This process is repeated for the limit parameter.

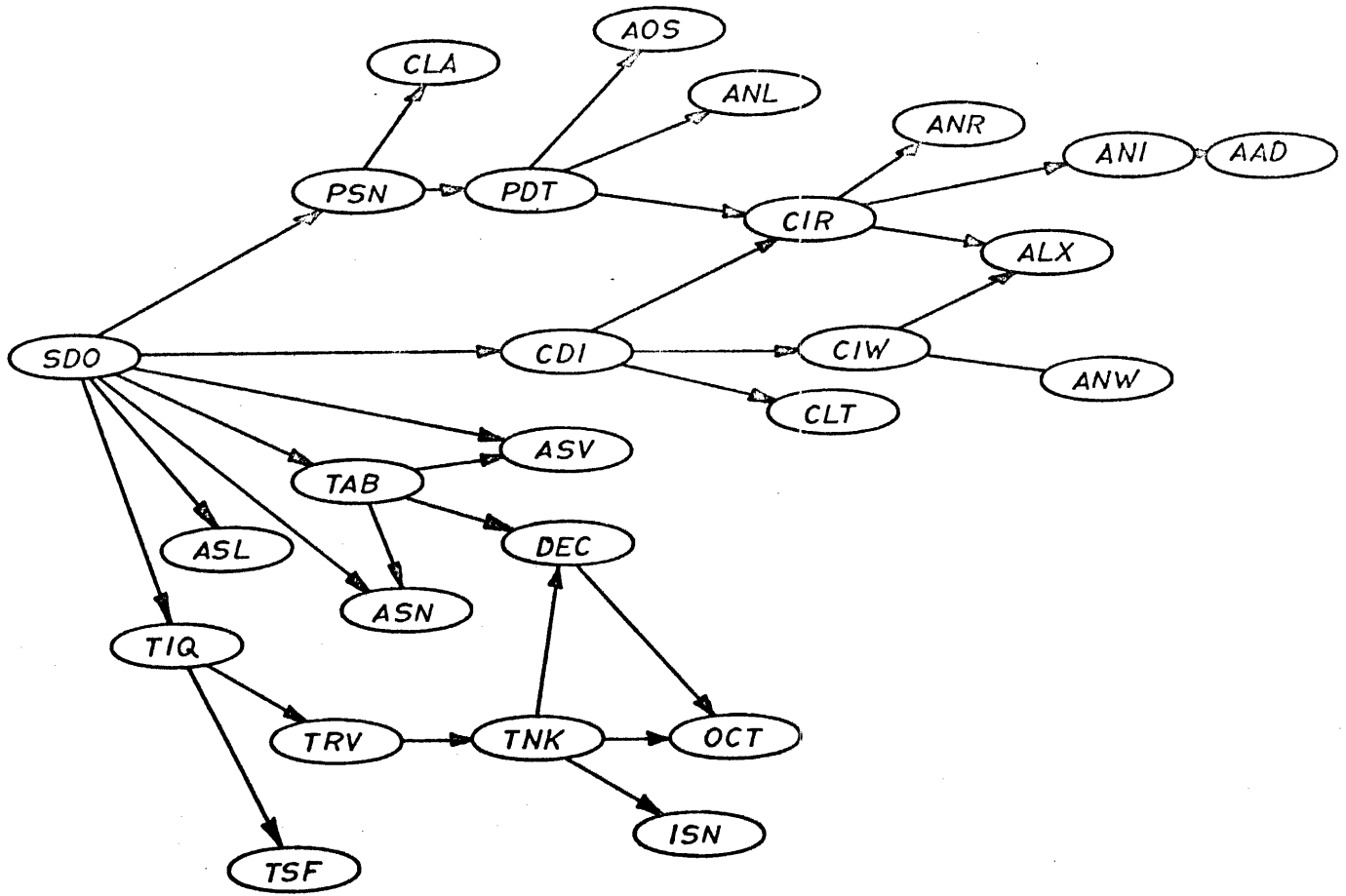

Figure 2.4

RUN COMPILER
 DO STATEMENT PROCESSING
 SUBROUTINE FLOW

- NOTE 1: ADF, SCT, AND SCH
SUBROUTINES NOT SHOWN
- NOTE 2: SUBROUTINES BEYOND THE
2nd LEVEL MAY NOT
NECESSARILY BE CALLED
IN NORMAL DO PROCESSING

When the index, limit, and increment parameters have been processed and any necessary fetch instructions have been compiled, PDT compiles the index increment instruction. If the increment parameter is a constant, this will be an $SX6 = Xj + K$ instruction, while if this parameter is a Variable tag, an $SX6 = Xi + Xj$ instruction is compiled (since a fetch instruction was compiled to bring the increment to Xi).

Next, the limit parameter is examined to determine what type of index test instructions must be generated. If the limit parameter is a constant, an "SX6 = X6 - K, NG X7 A-tag" sequence is compiled. If the limit parameter is a Variable tag, then an instruction has been compiled to bring the limit value to an X register, and so an "IX7 = Xi - X6, PL X7 A-tag" sequence is compiled. In either case, the A-tag is that initially assigned to the index store instruction.

If this is a one-statement DO loop, the Analyze One-Statement DO subroutine is called to attempt to improve the object code generated for the statement. The DO Number Table is then scanned again to determine if this statement appears again (remember that entries in this table are cleared as they are processed). If this statement number appears again in this table, then a nested DO loop is indicated, and so PDT repeats the process described. When all entries with this statement number in the DO Number Table have been processed, PDT exits to PSN, and from there control is returned to the compiler master loop.

ARITHMETIC STATEMENT PROCESSING

Prior to searching the table of statement types, the compiler master loop calls the Sense Formula (SFO) subroutine to determine if the statement is an arithmetic statement and, if it is, to initiate statement processing. SFO determines if the statement is an arithmetic statement function, in which case the Compile Function Definition (CFF) subroutine is called, or a replacement type arithmetic statement, in which case control is passed to the Compile Normal Formula (CNF) subroutine.

Statement evaluation by the CFF subroutine and by the CNF subroutine is similar in many respects. The basic steps in the evaluation process are tabulated in figures 2.5 and 2.6. Both CFF and CNF call the TAB subroutine

CNF - COMPILE NORMAL FORMULA: BASIC STEPS

- CALL "TAB" TO NORMALIZE THE STATEMENT
- CALL "TIQ" TO TRANSLATE THE STATEMENT INTO A SERIES OF SEPARATORS AND TAGS
- CALL "UNP" TO ELIMINATE PARENTHESIZED EXPRESSIONS
- CALL "CXP" TO COMPLETE EVALUATION OF THE EXPRESSION
- SET THE RESULT MODE TO AGREE WITH THE MODE OF THE TERM ON THE LEFT SIDE OF THE EXPRESSION
- COMPILE INSTRUCTIONS TO STORE THE RESULT

2-12

Figure 2.5

CFF - COMPILE FUNCTION DEFINITION: BASIC STEPS

- SET UP THE CURRENT JUMP
- ENTER EACH FUNCTION ARGUMENT IN THE ARGUMENT NAME TABLE (TABLE I)
- ENTER A TAG FOR EACH FUNCTION ARGUMENT IN THE ARGUMENT TAG TABLE (TABLE J)
- COMPILE A ZERO WORD FOR EACH ARGUMENT
- ENTER THE FUNCTION NAME IN THE FUNCTION NAME TABLE (TABLE E)
- ENTER A FUNCTION TAG IN THE CORRESPONDING ENTRY IN THE FUNCTION TAG TABLE (TABLE F)
- CALL "TAB" TO NORMALIZE THE STATEMENT
- CALL "TIQ" TO TRANSLATE THE STATEMENT INTO A SERIES OF SEPARATORS AND TAGS
- CALL "UNP" TO ELIMINATE PARENTHESIZED EXPRESSIONS
- CALL "CXP" TO COMPLETE EVALUATION OF THE EXPRESSION
- SET THE RESULT MODE TO AGREE WITH THE FUNCTION MODE
- COMPILE A JUMP INSTRUCTION TO THE FUNCTION'S ENTRY POINT

2-13

Figure 2.6

to assemble the statement in the string buffer into a series of variables, constants, and separators. CFF enters the function name in the Function Name Table and replaces it in the string with a Function tag. The function arguments are entered in the Argument Value Table and replaced in the string by function tags. The TIQ subroutine is used by both CNF and CFF to translate the constants and variables in the string into a sequence of tags, and to enter these values in the appropriate tables. In processing statements, the Function Name Table is searched for a variable before the Variable Name Table is searched. Thus, in processing an arithmetic statement of the replacement type, the Function Name Table will be empty and so the variables in the statement are determined to be active variables rather than dummy arguments. In processing an arithmetic statement function, statement variables will be found in the Function Name Table, indicating that these variables are dummy arguments.

Both CNF and CFF call the Unpack Parentheses (UNP) subroutine to eliminate array references, function references, and parenthesized expressions from the statement. A simplified flow chart of the UNP subroutine is shown in figure 2.7. When UNP finds an array reference, it compiles the instructions required to fetch the array element after scanning the statement to determine if this element has previously been referenced and is therefore available. If the parenthesized quantity is part of a function reference, UNP calls the CRF (Compile Function Reference) subroutine to construct the calling sequence for the function. If the parenthesized quantity is an expression, the Compile Expression (CXP) subroutine is called. CXP determines the dominant mode of the expression and selects the proper subroutine to compile instructions for the evaluation of the expression and the conversion of the result to the dominant mode.

When UNP has eliminated all parenthesized quantities from the statement, control is returned to CNF or CFF. These routines may call CXP directly to complete evaluation of the right-hand side of the statement. CNF and CFF then generate the instructions needed to store the result. In the case of CFF, instructions may be compiled to convert the mode of the result to the mode of the variable on the left-hand side of the statement, and a jump instruction to the function's entry/exit line is compiled.

When statement compilation is complete, control is transferred to the PSN subroutine to process the statement number, and from there control is returned to the master loop.

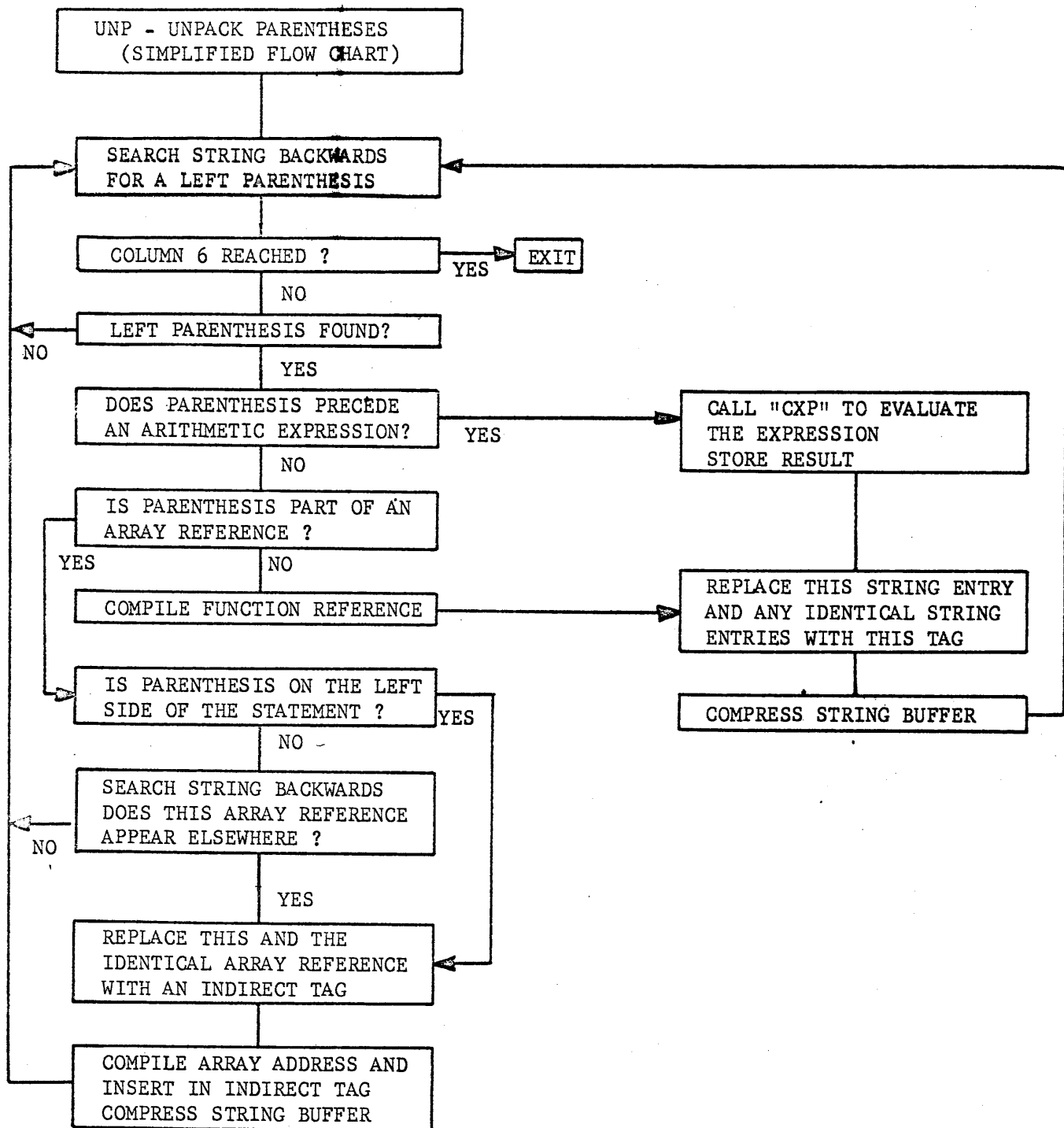

UNP-UNPACK PARENTHESES

Figure 2.7

INPUT/OUTPUT STATEMENTS

Upon encountering an input or output statement, the compiler generates a calling sequence for use by the execution time subroutines. There is no format cracking done during compilation, so all format diagnostics are produced during execution. Each particular set of I/O statements, i.e., READ, WRITE, ENCODE, BUFFER IN, etc., use an individual execution time subroutine. These subroutines do their own processing within themselves and do not depend on a central or generalized routine for the I/O. All information necessary for the completion of the task is generated by the compiler and passed to the execution time routine with successive calls.

In order for a central memory program to communicate with an external file, all information entering or leaving the program must pass through a buffer. For every I/O file, whether it be standard input or output, scratch tape, or data tape, used by the FORTRAN program, a declaration of the file name must be made on the PROGRAM card. Each file name causes a buffer with a minimum length of 1010 words or normally 2010 words to be reserved for its use. Any file that is not assigned to a special equipment via a control card will be assigned to the disk. The execution time subroutines use the system CIO (Circular Input/Output) for the physical transfer of data.

All information written on 1" tape or binary data written on $\frac{1}{2}$ " tape is recorded in blocks of 1000B words (physical record). The terminating block of a transfer is called a short block whose size is between 1 and 777B words. A logical record is defined as containing any number of physical records and terminated by a short block. Coded one inch tapes use packed display code with two consecutive characters whose value is zero terminating the records. These records may not be larger than 136 characters long but are written on 1" tape in the aforementioned logical record scheme. Therefore, the system makes no distinction between coded or binary data when a one inch tape is involved. There is a difference on $\frac{1}{2}$ " tape. All coded information is translated to BCD and written in 136 character physical records. In this case, a logical record is the

same as a physical record.

For a disk file, there is no specific record limit. The data is streamed out on the disk with a short sector (less than 100B words) being the terminating factor of a logical record. Like the one inch tape, coded and binary information appear the same to the system.

The compiler has I/O statement processors which decide from the form of statement which execution time routines are to be called. If a format statement is required, then the address of it must be available during execution. Since all I/O has to pass through a buffer, the address of this buffer must also be known. This information is compiled and sent to the subroutine in one entry. The I/O list is processed and one entry is made for each array or data item. It is during these entries that the format statement is cracked. A final entry is made to signal the end of the list.

The coded input statements (READ n, L; READ (i, n) L; READ INPUT TAPE i, n, L) call INPUTC. The file specified by "i" is read and the data "L" returns to the program according to the format "n". The following specifications are handled by INPUTC: E, F, D, O, A, *, I, l, X, R, L, P. Only with "F" conversion is a scale factor allowed. The format cracking utilized in INPUTC is flow charted in Appendix C, pages 1-5. During compilation, the address of the format statement is set into B3 to be passed to the subroutine. The address of a variable format is retrieved by assigning a variable tag to the format statement; thereby fetching the proper address during execution.

Binary data may be read by READ (i) L or READ TAPE i, L. During execution, INPUTB is referenced to read file "i" and insert the data in "L". No special word count is reserved in the data itself. The number of words defined by L determines the number of physical records that are read. Binary data may be written on a file by WRITE (i) L or WRITE TAPE i, L. Either of these statements request OUTPTB to transfer the information from "L" to file "i". The number of words written by these statements must be greater or equal to the number of words read by the corresponding READ statement.

OUTPTC is the execution time subroutine called to write coded data on a file. The statements PRINT n,L; PUNCH n,L; WRITE (i, n) L; or WRITE OUTPUT TAPE i, n, L will all cause OUTPTC to be referenced. As with coded input, the format is cracked during execution. The types of format specifications allowed on output are: I, X, A, O, H, /, F, E, D, R, L, *, P. There is little difference between the procedure of format cracking used by OUTPTC and INPUTC.

ENCODE and DECODE statements are also implemented. Storage manipulation to transfer data under a specific FORMAT statement is all that is involved so no physical data file is referenced. Therefore, the list processor used by READ/WRITE compiles a calling sequence to the execution time subroutines OUTPTS and INPUTS. These subroutines work on the same format cracking scheme as OUTPTC and INPUTC.

All the aforementioned statements result in the I/O being completed by the execution time subroutines before control is returned to the central program. Therefore, the data is immediately available to the programmer after an I/O statement has been processed. However, the user may choose to buffer his own I/O in which case the BUFFER IN and BUFFER OUT statements are available. BUFFERI and BUFFEO (execution time subroutines) are called, respectively, to initiate the transfer of data via CIO. In this case, the central processor is not released by a recall (RCL) request. Instead control is returned to the central program as soon as CIO has initiated the request. Any block of data, up to normal central memory restrictions, will be handled by these statements. Before using the data it is up to the user to check the status of the buffered unit by an IF (UNIT, i). This statement compiles a calling sequence to IOCHEK which is the execution time routine used for checking the status.

The execution time subroutines receive all addresses from the program via index registers. A calling sequence is constructed by the compiler for each statement. Listed on the following page are the calling sequences compiled to be used during execution.

CALLING SEQUENCES

READ, WRITE, PRINT, PUNCH

First Entry	B1 = 0 B2 = address of buffer parameter list or complemented address of variable tape number B3 = address of format statement
Intermediate Entries	B1 = address of data item or beginning address of array B2 = array length or 0
Final Entry	B1 = -1

ENCODE, DECODE

First Entry	B1 = 0 B2 = 0 B3 = address of format statement B4 = character length
Second Entry	B1 = beginning address of packed data B2 = 0
Intermediate Entries	B1 = address of data item or beginning address of array B2 = array length or 0
Final Entry	B1 = -1

BUFFER IN, BUFFER OUT

First Entry	B1 = mode constant B2 = address of buffer parameter list or complemented address of variable tape number
Second Entry	B7 = address of first word of data block
Third Entry	B7 = address of last word of data block

END STATEMENT PROCESSING

Three conditions will cause entry to the END processing routine.

1. An END statement
2. A plus in column one of the next input card
3. An end of record on input.

In case one of the following conditions prevail:

1. The instructions for the last subprogram have been compiled one per central memory word.
2. The location tag, if any is needed, is in the lower 18 bits of the compiled instruction.
3. All information needed to make memory assignments and process generated tags is contained in the temporary tables.

At this time, the instructions are packed and the location tags along with their absolute address are saved. Various routines are then called to make temporary, common, and unique variable assignments. The tags of the variables along with their memory addresses are saved.

The routine RAD is then called to replace tags with memory addresses. It will search the complete short file, that is the last program/subprogram compiled, and replace all K portions of 30 bit instructions that have tags with memory addresses. If, for some reason, a K tag is found that has not been given a memory assignment, some type of diagnostic is given. This could be caused by a missing statement, a dimension ordering error or could be a system error.

The DATA statement is then processed, the variable map written, and a return is made to the main loop for the next subprogram.

If there is a plus in column one of the next input card, a routine is entered to read in binary programs. These programs are positioned with the object deck already compiled. The information about each routine read in is extracted from the RA and RA+1 of the binary routine and entered into the subroutine tables. Processing then continues the same as if an end of record was detected originally on the input file.

A call is made to the PP routine CLL to load all subroutines not yet defined. The starting address of subroutines is now equated to memory addresses, and RAD is called once for each program/subprogram to replace all subroutine tags with memory addresses. The complete file, if no errors have been detected, is written on the disk.

Then, depending on the mode of compilation, a return may be made for another deck, the compiler may terminate, the deck may be punched or the EXU may be called to load and execute this compiled program.

A simplified flow of the END processing is found on the next page.

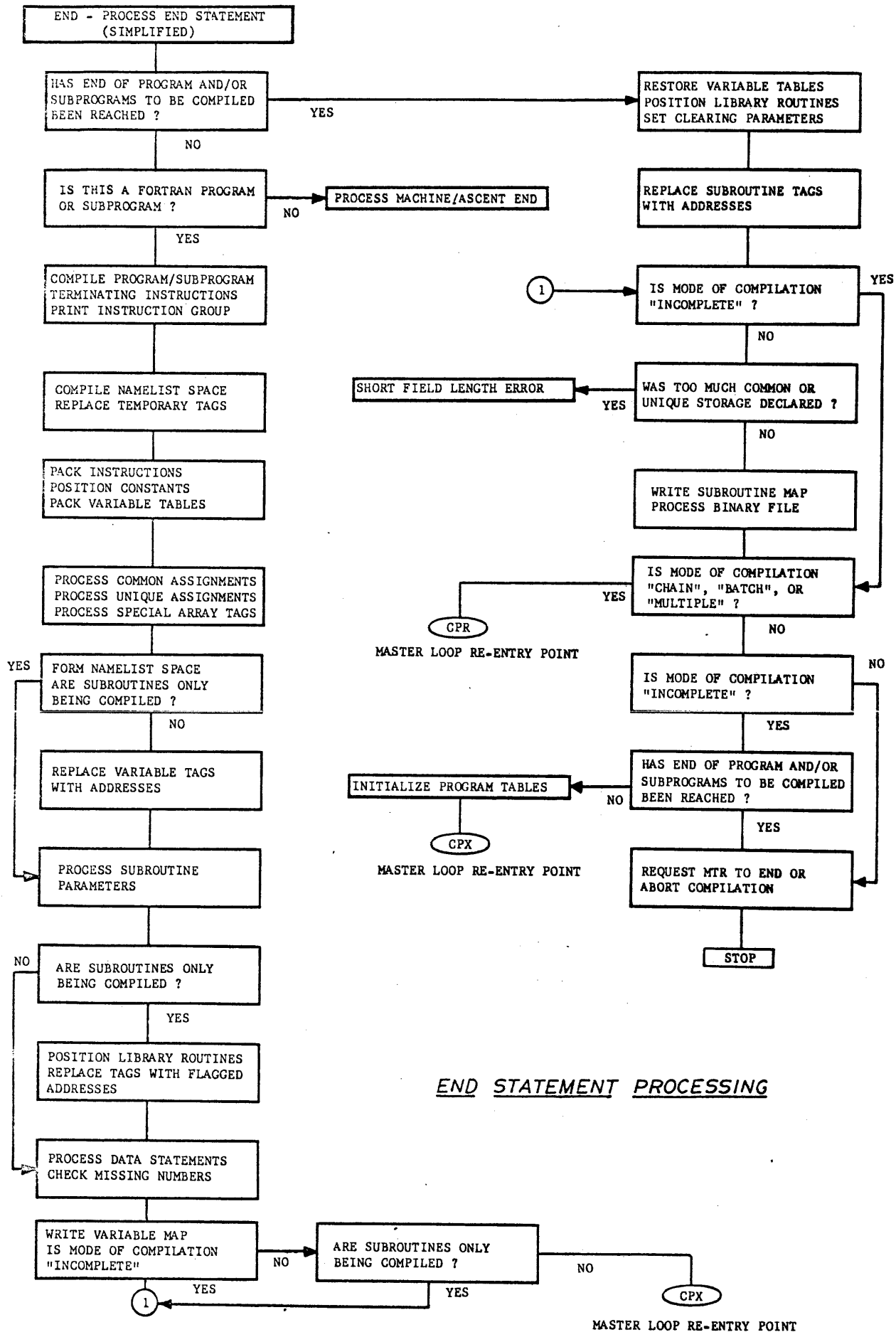

END STATEMENT PROCESSING

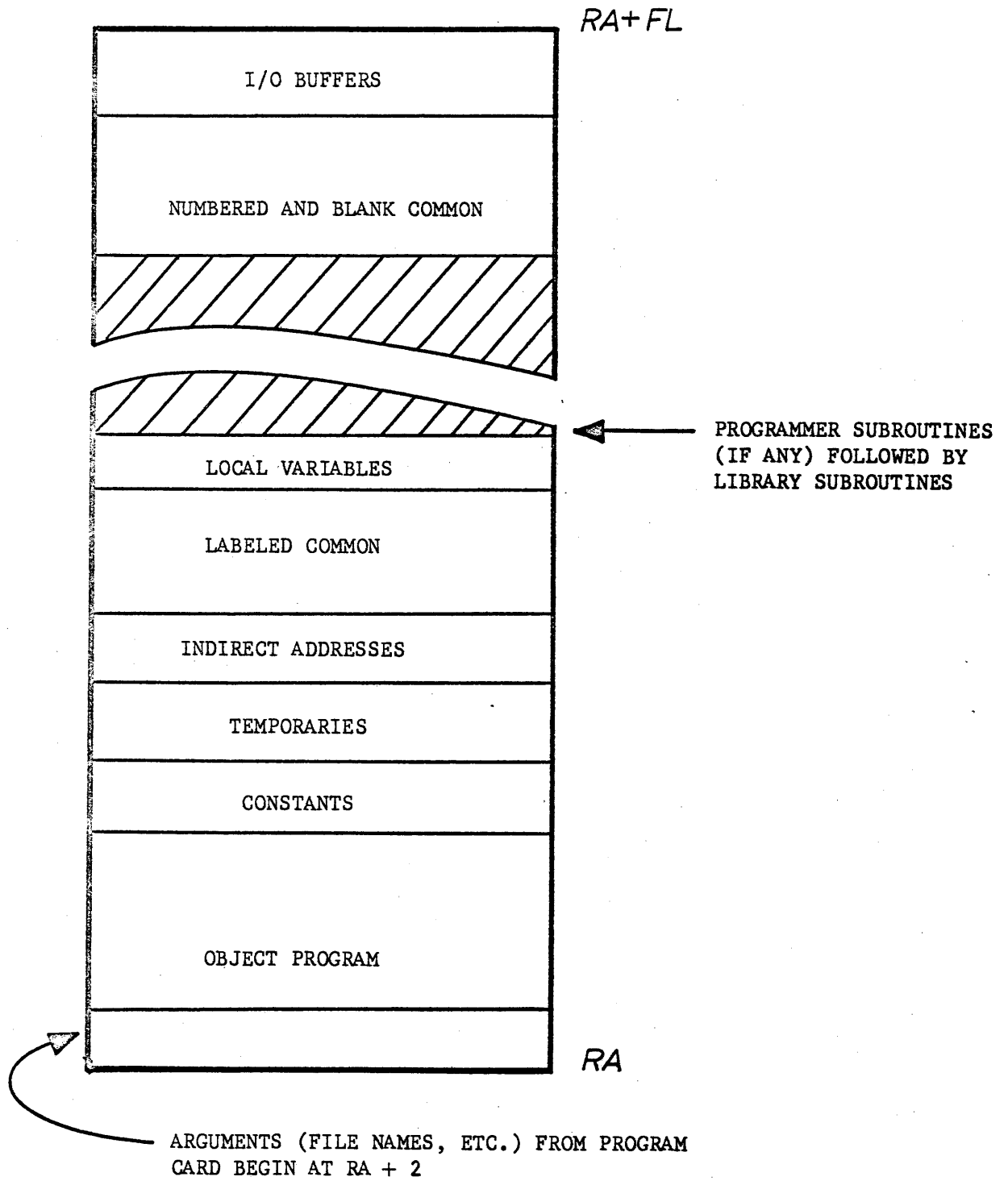

MAIN PROGRAM ORGANIZATION

LISTING

INTERPRETATION

```

PROGRAM TEST(INPUT,TAPE1 = INPUT)

000000 0          L00002
000001 0          L00003
000002 0          L00004
000003 0          L00005
000004 0          L00001
000005 5110 C00001
        63110
        21122
000006 63210
        21122
        63310
        74200
000007 37121
        0331 000000
000010 7160 001777
        20660

000011 56610          L00006
        6111 000001
000012 0712 L00006
        43600
000013 56610          L00007
        6111 000001
000014 0713 L00007
        5110 C00002
000015 63110
        43052
        5120 C00004
000016 63220
        67312
        5130 000002
000017 11730
        56730
        5140 C00005
000020 10740
        5170 000002
000021 7173 000010
        5173 000001
000022 5173 000002
        5173 000003
000023 76710
        5173 000004
        43700
000024 5173 000005
        5173 000006
000025 5150 C00003
        10750
000026 5173 000007
        67112

        NAME = 2

000027 7160 000002
        5160 V00001
    
```

ASCENT EQUIVALENT	COMMENTS
	Header card, processed by PPG
L00002 BSSZ 1	
L00003 BSSZ 1	RA, RA + 1 are MTR communications area
L00004 BSSZ 1	File Name and Buffer Address (INPUT)
L00005 BSSZ 1	File Name and Buffer Address (TAPE1)
L00001 BSSZ 1	Reserved word (subprogram entry/exit line)
SA1 C00001	C00001 - parameter word set up by END
SB1 X1	Extract local length
AX1 22B	
SB2 X1	Extract beginning address of COMMON
AX1 22B	
SB3 X1	Extract compiled field length
SX2 A0	Pick up field length from A0
IX1 X2-X1	
NC X1,0	Exit if insufficient space
SX6 001777B	
LX6 60B	Set X6 to an indefinite value
L00006 SA6 B1	
SB1 B1 + 1	Set unused program space (i.e., from
LT B1,B2,L00006	the end of local to the beginning of
MX6 0	COMMON) to indefinite: clear COMMON
L00007 SA6 B1	and buffer areas to zero
SB1 B1 + 1	
LT B1,B3,L00007	
SA1 C00002	Fetch compiled field length
SB1 X1	
MX0 52B	Set mask for file name
SA2 C00004	Fetch compiled buffer length
SB2 X2	
SB3 B1-B2	Compute starting address for 1st buffer
SA3 000002	Fetch first file name from RA + 2
BX7 X3*X0	Mask out buffer address, store file name
SA7 B3	as 1st buffer parameter
SA4 C00005	Fetch compiled file name and buffer
BX7 X4	address, store in RA + 2 (replace
SA7 000002	execution time file name)
SX7 B3 + 10B	Initialize circular buffer pointers
SA7 B3 + 1	Set FIRST
SA7 B3 + 2	Set IN
SA7 B3 + 3	Set OUT
SX7 B1	Pick up compiled field length
SA7 B3 + 4	Set LIMIT
MX7 0	
SA7 B3 + 5	Set sixth and seventh buffer parameters
SA7 B3 + 6	to zero
SA5 C00003	Fetch line limit
BX7 X5	
SA7 B3 + 7	Set line limit as eighth parameter
SB1 B1-B2	Set LIMIT for next buffer (unused in
	this example)
	Source card, processed by SFO
SX6 000002	Instructions compiled for this state-
SA6 V00001	ment by CXP

Note: words 0 - 26g were compiled by the PPG (Process Name and Arguments) subroutine. When the compiler master loop encounters a PROGRAM card, the PGM (Process Program Statement) subroutine is called: PGM checks to insure that a prior program or segment has not been compiled, and then calls PPG.

L0000n = PROGRAM TAG (A-TAG)
 C0000n = CONSTANT TAG (K-TAG)
 V0000n = VARIABLE TAG (V-TAG)

LISTING

```

DO 3 I = 1,NAME
000030 7160 000001
000031 5160 V00002 L00013
      3   BAT = ROB
      5150 V00001
000032 5110 V00004
      10610
000033 5160 V00003
      5120 V00002
000034 7262 000001
      37756
000035 0327 L00013
      A = 16.
      5110 C00006
000036 10610
      5160 V00005
      GO TO 1
000037 0400 N00001
      1   Q = 0.
000040 43600 L00020 (N00001)
      5160 V00006
      CALL BATSUB(A,B,C,D,E,F,G,10)
000041 6110 V00005
      6120 V00007
000042 6130 V00010
      6140 V00011
000043 6150 V00012
      6160 V00013
000044 7160 V00014
      5160 S00207
000045 7170 C00007
      5170 S00210
000046 0100 S00200 L00022
      0710 L00002
      END
000047 5120 C00010
      10720
000050 0100 S00300
  
```

INTERPRETATION

ASCENT EQUIVALENT	COMMENTS
	Source card, processed by SDO
L00013 SX6 000001	CDI(called by SDO) compiles instructions to initialize the DO index
SA6 V00002	
	Source card, processed by SFO. Statement number processed by PSN, which calls PDT to compile index increment and test instrs. Fetch ROB
SA5 V00001 ¹	
SA1 V00004	
BX6 X1	
SA6 V00003	Store (ROB) in BAT
SA2 V00002	Fetch I
SX6 X2 + 1	I = I + 1
IX7 X5-X6	NAME - I
PL X7, L00013	Loop if limit not reached
	Source card, processed by SFO
SA1 C00006	Fetch constant
BX6 X1	
SA6 V00005	Store constant in A
	Source card, processed by SGO
EQ B0,B0,N00001	N00001 = statement tag (H-tag)
	Source card, processed by SFO
L00020 MX6 0	L00020 is equated to N00001 through the Temporary and Permanent Tag Tables
SA6 V00006	
	Source card, processed by CLL. CLL calls PRR to compile argument handling instrs.
SB1 V00005	
SB2 V00007	
SB3 V00010	The addresses of the first six arguments are passed to the subroutine in registers B1 - B6
SB4 V00011	
SB5 V00012	
SB6 V00013	
SX6 V00014	Pick up address of seventh argument
SA6 S00207	Store 7th argument addr. in reserved word
SX7 C00007	Get address of 8th argument - a constant - and store in reserved word
SA7 S00210	
L00022 RJ S00200	Lower half of instruction word contains argument count and name of caller
	Source card, processed by END
SA2 C00010	Zero word passed to execution time subroutine END
BX7 X2	
RJ S00300	Jump to execution time subroutine END

1: the instruction in the lower half of word 31 is the limit fetch instruction for the DO index increment and test. Do index increment and test instructions are compiled by PDT (called by PSN). PDT calls the AOS subroutine (Analyze One-Statement Do) to attempt to place the increment and limit fetches (if any) at the beginning of the instructions compiled for the statement which terminated the DO loop.

LISTING

INTERPRETATION

```

SUBROUTINE BATSUB(W,X,V,D,R,J,M,L)
000077 0          L00002
000100 0          L00003
000101 0          L00004
000102 0          L00005
000103 0          L00006
000104 0          L00007
000105 0          L00010
000106 0          L00011
000107 0          L00012
000110 0          L00013
000111 0          L00001
000112 76710
          76120
          20122
          36717
000113 76230
          20244
          36727
000114 5170 T00001
          76740
          76350
000115 20322
          36737
          76460
          20444
000116 36747
          5170 T00002
          RETURN
000117 0400 L00001
          END
000120 5150 C00001
          10750
000121 0100 S00300
    
```

ASCENT EQUIVALENT	COMMENTS
	Header card, processed by PPG
L00002 BSSZ 1	Reserved for subroutine name
L00003 BSSZ 1	Reserved for argument count
L00004 BSSZ 1	These six words are unused, since the arguments to which they correspond are passed in registers B1 - B6
L00005 BSSZ 1	
L00006 BSSZ 1	
L00007 BSSZ 1	
L00010 BSSZ 1	
L00011 BSSZ 1	
L00012 BSSZ 1	Reserved for the seventh argument
L00013 BSSZ 1	Reserved for the eighth argument
L00001 BSSZ 1	Entry/exit line
SX7 B1	Save addresses of first three arguments in temporary word 1
SX1 B2	
LX1 22B	
IX7 X1 + X7	Store first three argument addresses
SX2 B3	
LX2 44B	
IX7 X2 + X7	Save addresses of next three arguments in temporary word 2
SA7 T00001	
SX7 B4	
SX3 B5	T0000n = Temporary Tag (T-Tag)
LX3 22B	
IX7 X3 + X7	
SX4 B6	Store second three argument addresses
LX4 44B	
IX7 X4 + X7	
SA7 T00002	Source card, processed by RTN
EQ B0,B0,L00001	Jump to entry/exit line
	Source card, processed by END
SA5 C00001	Pass a zero word to the execution time subroutine END. These instructions are unused in this example: they would be used if the RETURN statement was not present.
BX7 X5	
RJ S00300	

CHIPPEWA FORTRAN COMPILER - RUN

Section 3

SUBROUTINE DESCRIPTIONS

AAR - ANALYZE ARRAY REFERENCE

This routine is called during the processing of an arithmetic expression when it has become necessary to bring the address of an array entry to B7. It is entered in an attempt to stop the storing of the array address into an indirect cell. Two conditions will make this routine flag that the store is probably necessary.

1. If there are any more array references to be processed, the store must be generated.
2. If the mode of the array is integer and if there is a division specified in the expression before this array reference is made, the address must be saved.

Otherwise, the single array reference count is increased, the next indirect tag and index 7 are packed into X6 and the routine exits.

Subroutines Called: None

Temporaries/Flags: ARI - Array Reference Count
IGX - Current Index Assignment
SAR - Single Array Reference Count
TGI - Indirect Tag
TMF - Start of Array Reference
TMH - Start of Expression

Tables Referenced: None

Entry/Exit Register Conditions:

Entry: None

Exit: X6 - zero implies no processing done

X6 ≠ zero implies the next indirect tag and B7 have been packed in X6 and no store of the array address must be made.

ABS - PROCESS ABSOLUTE LIST

When the MAA (Process Machine or Ascent Records) subroutine encounters an ABS declarative, the ABS subroutine (Process Absolute List) is called. The ABS declarative permits the unsigned number on the right to be assembled into instructions containing the identifier in their address field. An example of the ABS declarative together with the basic steps in processing the list is shown in Figure ABS-1.

On entering the ABS subroutine, the TAB subroutine is called to normalize the list. The Variable Name Table (Table M) is scanned to determine if the variable which has been equated to the subroutine name has been entered and, if not, the variable is entered in the Variable Name Table. If the variable has previously been entered in the Variable Name Table, an error exit (Duplicate Tag Error) occurs. The variable name is also checked to insure that the first character is alphabetic and that the name is composed of two or more characters for machine programs.

Next, a check is made for the equal sign and the CVN (Convert Number) subroutine is called. If the constant is greater than -2^{16} and less than $2^{16}-1$, it is stored in the Variable Tag Table (Table N). If the constant lies between $2^{16}-1$ and $2^{17}-1$, a Statement Tag (H-tag) is generated and stored in the corresponding Variable Tag Table and the constant is stored in the Argument Tag Table (Table J).

Subroutines Called: TAB - Normalize Statement
 SCT - Scan Table
 CVN - Convert Octal or Decimal Number
 ADF - Advance Table

Temporaries/Flags: MOD - Subprogram Mode
 TGH - Statement Tag (set)
 IPS - Program/Subprogram Indicator

ABS DECLARATIVE PROCESSING

EXAMPLE: ABS (JJ=100, KK=100B, LL=7777)

1. STORE THE VARIABLE NAME (e.g., JJ) IN THE VARIABLE NAME TABLE
2. CHECK FOR AN EQUAL SIGN
3. CONVERT THE CONSTANT
4. LOOK FOR A TAG OR CONSTANT
5. STORE IN THE APPROPRIATE TABLE
6. IF THE NEXT ENTRY IS A COMMA, REPEAT 1-5
7. CHECK FOR A RIGHT PARENTHESIS
8. RETURN FOR THE NEXT RECORD

ACE - PROCESS ASCENT EQU

When the MAA (Process Ascent and Machine Records) subroutine encounters an EQU Ascent pseudo-operation instruction, the ACE subroutine is called.

The ACE routine writes a constant of "all fives" into the output buffer then transfers to WNX (Write Coded Record) and RNX (Read Coded Record). Next a call to TAB (Normalize Statement) reorders the string entries to one variable or separator per word. An equal sign is stored in column 9 and the location variable is stored in column 8. Further processing is handled with a jump to the ABS (Process Absolute List) subroutine.

Subroutines Called: WNX - Write Coded Record
RNX - Read Coded Record
TAB - Normalize Statement
ASV - Assemble Variable

Temporaries/Flags: CAS - Constant of Blanks
MHI - Machine Header Card Indicator (set)

Tables Referenced: None

Entry/Exit Register Conditions:

A1 string address of first character beyond EQU pseudo-operation code.

ACH - PROCESS ASCENT DPC AND BCD

When the MAA (Process Ascent and Machine Records) subroutine encounters a BCD or DPC pseudo-operation, the ACH subroutine is called. The PST routine is called to process the location tag and the ARA routine is called to adjust the address and write the register. Next the first character of the address field is erased from the string, and the next ten characters are accumulated. A test is made to insure that the pseudo-op appeared in the constant section. On exit from the routine, the code is in X6.

Subroutines Called: PST - Process Statement Tag
ARA - Adjust Running Address and Write Register

Temporaries/Flags: IWC - Instruction Word Count

Tables Referenced: None

Entry/Exit Register Conditions:

A1 - Address of first non-blank following opcode.
X6 - Hollerith field

ACE - PROCESS ASCENT EQU

When the MAA (Process Ascent and Machine Records) subroutine encounters an EQU Ascent pseudo-operation instruction, the ACE subroutine is called.

The ACE routine writes a constant of "all fives" into the output buffer then transfers to WNX (Write Coded Record) and RNX (Read Coded Record). Next a call to TAB (Normalize Statement) reorders the string entries to one variable or separator per word. An equal sign is stored in column 9 and the location variable is stored in column 8. Further processing is handled with a jump to the ABS (Process Absolute List) subroutine.

Subroutines Called: WNX - Write Coded Record
RNX - Read Coded Record
TAB - Normalize Statement
ASV - Assemble Variable

Temporaries/Flags: CAS - Constant of Blanks
MHI - Machine Header Card Indicator (set)

Tables Referenced: None

Entry/Exit Register Conditions:

A1 string address of first character beyond EQU pseudo-operation code.

ACH - PROCESS ASCENT DPC AND BCD

When the MAA (Process Ascent and Machine Records) subroutine encounters a BCD or DPC pseudo-operation, the ACH subroutine is called. The PST routine is called to process the location tag and the ARA routine is called to adjust the address and write the register. Next the first character of the address field is erased from the string, and the next ten characters are accumulated. A test is made to insure that the pseudo-op appeared in the constant section. On exit from the routine, the code is in X6.

Subroutines Called: PST - Process Statement Tag
ARA - Adjust Running Address and Write Register

Temporaries/Flags: IWC - Instruction Word Count

Tables Referenced: None

Entry/Exit Register Conditions:

A1 - Address of first non-blank following opcode.
X6 - Hollerith field

ACK - PROCESS ASCENT CON

When the MAA (Process Ascent and Machine Records) subroutine encounters a CON Ascent pseudo-operation code, the ACK subroutine is called. The constant in the address field is moved left beginning in column 7 of the string buffer. When an end of statement or a blank is encountered, a zero is written into the string and a transfer back to the main loop of MAC for further processing occurs.

Subroutines Called: None

Temporaries/Flags: None

Tables Referenced: None

Entry/Exit Register Conditions:

A1 string address of last character before the address field

ACR - PROCESS ASCENT BSS AND BSSZ

When the MAA (Process Ascent and Machine Records) subroutine encounters a BSS or a BSSZ pseudo-operation code, the ACR subroutine is called. Column 7 of the string buffer is set to a left parenthesis and the value of the address field is moved to the left beginning in column 8. Upon encountering the first blank or end of statement, a right parenthesis and a zero are stored into the next two columns of the string. Further processing is done in the Master loop of MAA.

Subroutines Called: None

Temporaries/Flags: None

Tables Referenced: None

Entry/Exit Register Conditions:

A1 - String address of the last character before the address field

AFS - ASSEMBLE FORTRAN STATEMENT

The AFS subroutine assembles a FORTRAN statement or assembly instruction from card buffer into the string buffer. If a statement is continued on one or more succeeding (continuation) cards, all such cards are also transmitted to the string buffer. Within the string buffer, information is packed one character per word, right-justified. The string buffer loading process is illustrated in figures AFS-1 and AFS-2.

On entry, the multiple statement indicator, ICE, is examined to determine if there were multiple statements on the card previously transmitted to the string buffer. If ICE is zero, then there were no multiple statements on the card previously transmitted to the string buffer: otherwise, ICE contains the address in the string buffer of the dollar sign which terminated the statement just processed. In the latter case, AFS blanks out the preceding statement and scans the remainder of the card until either a dollar sign or the end of the statement (a zero word) is encountered. If a dollar sign is encountered, the multiple statement indicator is set to the address of the dollar sign in the string buffer. Control is then returned to the calling program.

If there were no multiple statements on the previous card, AFS enters a loop which inputs, examines, and lists cards until a statement or instruction card is found. AFS calls the RNX subroutine to bring a card from the input buffer to the card buffer, and calls the WNX subroutine to transmit the card to the output buffer for listing. As each card is processed, AFS checks to see if the end of file has been reached. If the previous statement was an END statement, then PNM (program/sub-program name) will be zero: if PNM = 0 and an end of file is encountered, AFS transfers control to END (Process End Statement). In all other cases, detection of the end of file will result in an error exit. On the first entry to the loop, the card already in the card buffer is examined. If column 1 contains a period (page eject card), an asterisk or a dollar sign (remarks card), or in a FORTRAN program, the letter C (comments card), the card is listed (i.e., transmitted to the output buffer) and the next card brought to the card buffer. This process is repeated until a statement/instruction card is found: i.e., a non-

Figure AFS-1

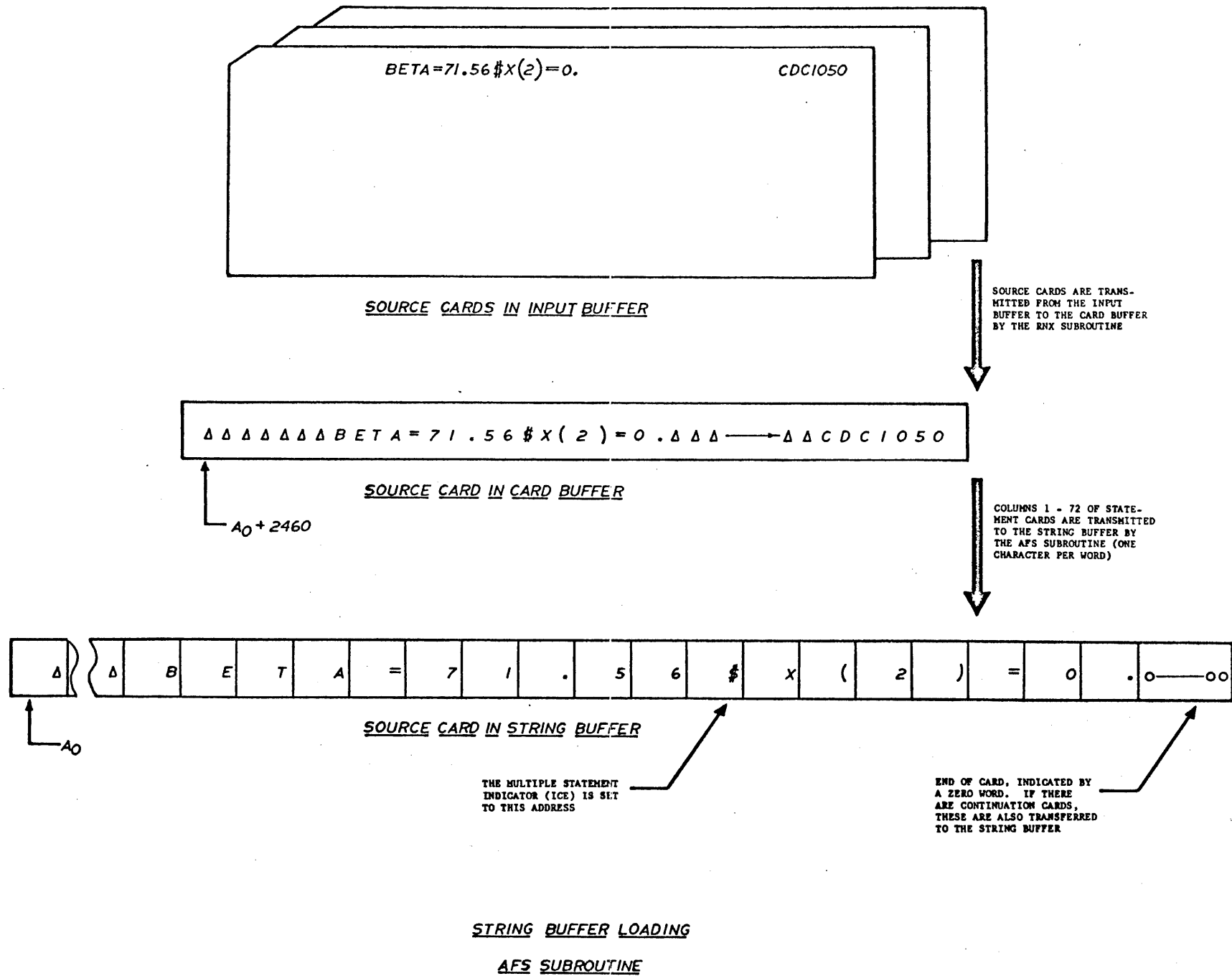

blank card which is not one of those described above.

Next, column 6 of the card is examined. If column 6 is blank, contains a zero (FORTRAN program), or does not contain an asterisk, AFS transfers the card from the card buffer to the string buffer. All 72 characters on the card (spaces included) are transmitted to the string buffer. Characters in the string buffer are packed one per word, right-justified. If a dollar sign is encountered in the transfer process, the multiple statement indicator is set to the address of the dollar sign in the string buffer. (Note: this dollar sign is replaced with a zero word on return to the main loop of RUN.) The end of the card in the string buffer is then marked by a zero word. This zero word will be overlaid if this statement is continued on succeeding cards.

After processing a statement or instruction card, AFS inputs another card into the card buffer to determine if the statement just processed is continued: if so, the associated continuation cards must also be transferred to the string buffer. AFS examines the card to determine if it is a comments card (C in column 1). If it is, it is listed and AFS brings another card to the card buffer. If a card is found which is not a comments card, column 6 is examined to determine if it is a continuation card (non-blank and non-zero in FORTRAN, an asterisk in assembly language). If it is not a continuation card, control is returned to the calling program: the card in the card buffer will be processed on the next entry to AFS. If the card is a continuation card, it is transferred to the string buffer and the process repeated.

If the first statement/instruction card found did not contain a blank or zero in column 6 (FORTRAN program) or contained an asterisk in column 6 (assembly program), then it is assumed that an out-of-sequence continuation card has been found. AFS enters a loop in which cards are read and listed until a non-continuation, non-comments card is found, at which point an error exit takes place (continuation error).

Figure AFS-2

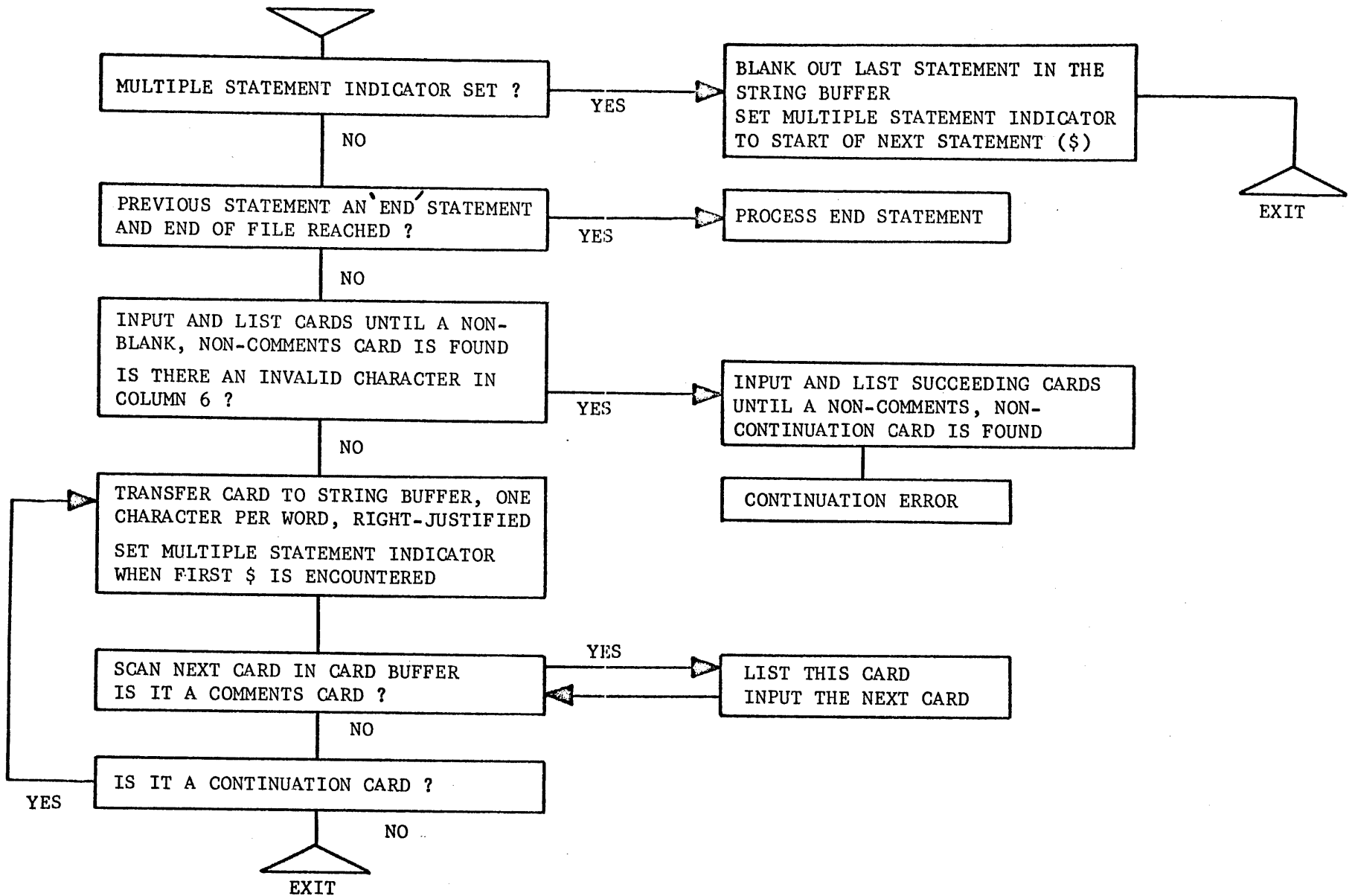

MAJOR FUNCTIONS
AFS SUBROUTINE

Subroutines Called: RNX - Read Coded Record
WNX - Write Coded Record
ASM - Assemble Mnemonic Code
END - Process End Statement

Temporaries/Flags: ICE - Multiple Statement Indicator (set)
MHI - Machine Heading Indicator (set)
IGS - Instruction Group Start (set)
PNM - Program/Subprogram Name
MOD - Subprogram Mode Indicator
FST - Long File Start
SIG - Compile Mode Indicator
ICA - Display Coded Running Address

Tables Referenced: none

Entry/Exit Register Conditions: n/a

ANK - ANALYZE ADDRESS GENERATING INSTRUCTIONS FOR RIGHT MEMBER

This routine is called during the processing of an expression when B7 has been used to hold the address of an array entry and there are more array references in the statement. If AO is still available, the last compiled instruction is changed to a set AO instruction and the AO register associate is set to the next indirect tag which is passed back to the calling program. It also clears the instruction register X7.

Subroutines Called: None

Temporaries/Flags: TGI - Indirect Tag
VTA - AO Register Associate

Tables Referenced: None

Entry/Exit Register Conditions:

Entry: None

Exit: X6 = zero if AO was not available

X6 ≠ zero if AO was used to hold the address of the array entry. Actually it would have the next indirect tag and bit 21 set to say the address was in AO.

ARA - ADJUST RUNNING ADDRESS AND WRITE REGISTER

When the MAA (Process Ascent and Machine Records) subroutine has packed as many consecutive instructions into one machine word as possible, the ARA routine is called to increment the running address by one and write the previously stored word. Should ARA be entered when the counter has been reset to zero, blanks are stored into the output buffer, then current running address is converted and stored. Should the counter be set to non-zero, the current word is written and the running address is incremented before the converting and storing of the running address.

Subroutines Called: None

Temporaries/Flags: ICT - Intraword counter
ADM - Current Running Address

Tables Referenced: None

Entry/Exit Register Conditions: N/A

ASL - ASSEMBLE LETTERS

The ASL subroutine assembles a specified number of letters from the string buffer into an assembly register. On entry to this subroutine, the B4 register contains the address of the location in the string buffer where assembly is to begin, and the B2 register contains the number of letters to be assembled. The assembled letters are returned to the calling program in the X6 register (left-justified). Spaces are ignored during assembly. If the end of the statement (indicated by a zero word in the string buffer) is encountered, or if a character is found which is not a letter, the assembly is terminated: the letters already processed, if any, are left-justified in the assembly register and control returned to the calling program.

Subroutines Called: none

Temporaries/Flags: none

Tables Referenced: none

Entry/Exit Register Conditions

Entry: B4 = address in string buffer where assembly is to begin

B2 = number of letters to be assembled

Exit: X6 = assembled letters, left-justified (zero if none assembled)

B2 = difference between number of letters requested to be assembled and number of letters actually assembled

B4 = address + 1 in the string buffer of the last letter assembled

Note: In the case where less than the requested number of letters were assembled, ASL exits with the non-alphabetic character which terminated the assembly in the X1 register.

ASM - ASSEMBLE MNEMONIC CODE

The ASM subroutine assembles the mnemonic code for an Ascent or Machine statement from the string buffer into the X6 register. First the routine scans over the leading blanks of the field being assembled. Then up to four alphabetic characters are moved into the X6 register. The first number or separator will terminate the collecting of letters in the X6 register. This character will be left in the X1 register. The result in X6 will be left justified and the B2 register will contain a flag (see chart below) to indicate the instruction type.

Subroutines Called: None

Temporaries/Flags: MOD - Subprogram Mode

Tables Referenced: None

Entry/Exit Register Conditions:

Entry: B4 - contains address in the string buffer where assembly is to begin

Exit: X6 - opcode left justified

X1 - next non-alpha string character

Note: The Ascent mnemonics composed of 2 letter and a number are split between X6 and X1 (i.e., SX1 X6 = SX and X1 = 34)

B2	<u>Value</u>	<u>Assembled Letters</u>	<u>Examples</u>
	0	4 letters except BSSZ	FORTRAN STATEMENTS
	1	3 letters BSSZ	END ASCENT PSEUDO-OPS
	2	2 letters 2 letters + Number	ASCENT MNEMONICS
	3	1 letter	Machine Mnemonic
	4	0 letters	CONSTANT

ASN - ASSEMBLE NUMBERS

The ASN subroutine assembles consecutive numbers from the string buffer into the assembly register. The routine attempts to assemble 7 numbers. On entry to this subroutine, the B4 register contains the address of the location in the string buffer where assembly is to begin. The assembled letters are returned to the calling program in the assembly register, X6 (left-justified). Spaces are ignored during assembly and, in the case of statement number assembly (i.e., assembly starting address not greater than column 5), leading zeroes are ignored. Numbers are transferred to the assembly register until either a non-space, non-numeric character is encountered or seven numbers have been assembled: The contents of the assembly register are then left-justified.

If no numbers were encountered, the assembly count (B2 register) is set to zero, and a display code zero is placed, left-justified, in the assembly register.

Subroutines Called: none

Temporaries/Flags: none

Tables Referenced: none

Entry/Exit Register Conditions

Entry: B4 = address in string buffer where assembly is to begin

Exit: X6 = assembled numbers, left-justified (display code zero if none assembled)

B2 = 7 - number of numeric characters assembled
(0 if none assembled)

B4 = address + 1 in the string buffer of the last letter assembled

Note: In the case where less than the requested number of digits were assembled, ASN exits with the non-numeric character which terminated the assembly in the X1 register.

ASV - ASSEMBLE VARIABLE

The ASV subroutine assembles consecutive alphanumeric characters from the string buffer into the assembly register. The routine attempts to assemble 7 such characters. On entry to this subroutine, the B4 register contains the address of the location where assembly is to begin. The assembled characters are returned to the calling program in the assembly register, X6 (left-justified). Spaces are ignored during the assembly. Characters are transferred to the assembly register until either 7 alphanumeric characters have been assembled or a non-space, non-alphanumeric character is encountered. If 7 consecutive alphanumeric characters are found, succeeding characters in the string buffer are read and examined until a non-space character is found. The contents of the assembly register are then left-justified.

The last character scanned is then examined to determine if it is an asterisk. If it is, and if this is an assembly program, it too is packed in the assembly register. Control is then returned to the calling program.

Subroutines Called: none

Temporaries/Flags: MOD - Subprogram Mode Indicator

Tables Referenced: none

Entry/Exit Register Conditions

Entry: B4 = address in string buffer where assembly is to begin

Exit: X6 = assembled characters, left-justified (0 if none assembled)

B2 = 7 - number of alphanumeric characters assembled

B4 = address of next non-space, non-alphanumeric character in the string buffer

Note: If an asterisk was packed in the assembly register, X1 is loaded with the character immediately following the asterisk in the string buffer. B4 is not advanced but still contains the address of this character.

BNX - BINARY OUTPUT ROUTINE

This routine is called at the end of compilation when the complete program including library subroutines are all in central memory. If a binary deck was requested, either the PBS or PBC PP punch routines are called. PBS is called if the mode of compilation is incomplete as it gives a status response when the punching is complete which PBC does not do.

A request is then made to CIO to write the program as a binary file whose name is in the same as the program name and the compiler remains in recall until the output has been completed. Another CIO request is sent to rewind the file. If the mode was not compile and execute, the routine exits. Otherwise, if a program was the first routine compiled, the name of the program is written into the dayfile and the PP routine EXU is called to read the program back in. AAB is called to adjust the program field length and BNX exits.

Subroutines Called: AAB - Adjust Program Field Length

Temporaries/Flags:

BOA -	}	Binary Buffer Parameters
BOB -		
BOC -		
BOD -		
FST -		Long File Start
ICM -		Incomplete Compile Mode Indicator
INQ -		Name for Dayfile
INV -		Segment Indicator
IPS -		Program/Subprogram Indicator
STG -		Compile Mode Indicator
ZAA -		Relative Start of Current Program or Subroutine

Tables Referenced: None

Entry/Exit Register Conditions: None

BRX - READ BINARY SUBROUTINES

This routine is called to read any subroutines that have been detected by the presence of a + in column 1 of the next input card. This routine transfers the binary routines from the input buffer to the compiled program area. It does its own requests to CIO when it is necessary, and does not use the RNX routine to read cards. When all routines have been transferred or when there is no room to continue the transfer, a zero entry is made and the routine exits.

Subroutines Called: None

Temporaries/Flags: INA - CIO Input Buffer Parameters

Tables Referenced: None

Entry/Exit Register Conditions:

Entry: X7 - address start of tables

X6 - start of the region to transfer routines to

Exit: None

CDC - CONVERT INSTRUCTION OR CONSTANT TO DISPLAY CODE

The CDC subroutine converts to display code the binary instruction formed from an Ascent or Machine source card. Upon entry into this routine, B1 contains a 5, 4 or 24B indicating a short, long or full word instruction, respectively. Detecting a short instruction, CDC will write one word into the output buffer and exit. The long instruction will call KOT to convert the binary tag to a mnemonic tag and thereby cause a two word entry into the output buffer. A full word instruction appends a zero word to its entry so that the buffer has three words stored. The exact form of these entries are shown in Figure CDC-1.

Subroutines Called: KOT - Convert Binary Tag to a Mnemonic Tag

Temporaries/Flags: None

Tables Referenced: None

Entry/Exit Register Conditions:

B1 24B, 5, 4

X1 binary instruction left-justified

CDC OUTPUT BUFFER ENTRIES

SHORT INSTRUCTION [X X I J K 0 0 0 0 0]

LONG INSTRUCTION [X X I J A B n n n n] [n 0 0 0 0 0 0 0 0 0]

FULL WORD INSTRUCTION [CH₁ ... CH₁₀] [CH₁₁...CH₁₆ 0 0 0 0]

XX _____ OPERATION CODE

I _____ RESULTANT REGISTER

J _____ FIRST OPERAND REGISTER

K _____ SECOND OPERAND REGISTER

ABnnnn _____ MNEMONIC TAG

CH₁-CH₁₆ _____ OCTAL DIGITS

Figure CDC-1

CFF - COMPILE FUNCTION DEFINITION

This routine controls the processing of all arithmetic statement functions after they are detected by the SFO routine. These functions are handled in the same manner as a function subprogram except that they may only contain one statement while a function subprogram may contain many. The function is a closed subroutine, entered via a return jump and exited from via the entry point. A zero word is compiled for each function argument plus one zero word for the entry/exit line. Since these functions are allowed to appear anywhere in the program, it is necessary to compile a jump over the closed subroutine that the arithmetic statement function generated. When such a jump is generated, the address of the jump is saved in "CJP" - current jump address.

On entry, the current jump address is examined to see if there is a current jump pending. If there is, a check is made to see that it was generated by an ASF rather than a logical if statement and a diagnostic given if not. If there is no current jump pending, a jump instruction is compiled to a statement or H tag and the address of this compiled jump is entered into CJP for later use.

The arguments to the function are then processed one at a time. The argument name is entered into the Argument Name Table and a Function Tag is generated, grouped with the mode and index assignment of the argument (if any) and entered into the Argument Tag Table. The function name is then entered into the Function Name Table and its tag and a mode indicator are entered into the Function Tag Table. This tag also replaces the name of the function in the string, and then the list of arguments are squeezed out of the string.

TAB is called to normalize the statement and TIQ is then called to translate the rest of the string entries into appropriate tags. If the dominant mode of the expression is double or complex or if the expression references other subroutines, the string is searched and for each function argument that has an index register associated with it,

the argument reference count is decreased by one and the index designation for the argument in the string is deleted.

UNP is then called to generate instructions to evaluate all expressions within parenthesis and replace these expressions with tags. An attempt is made to delete an unnecessary store if the function is a very simple one. Otherwise, CXP is called to compile the final answer and bring it to X6. An attempt is then made to have the answer end up in X6 and thus eliminate any unnecessary 10 instructions. Instructions are generated to convert the expression to the mode of the function and finally a jump instruction is compiled to exit through the function's entry point.

Subroutines Called: ADF - Advance Table
 CLT - Clear Temporary Tables
 CXP - Compile Expression
 SCT - Scan Table
 TAB - Normalize Statement
 TIQ - Translate Individual Quantities
 UNP - Unpack Parenthesis

Temporaries/Flags: ARF - Argument Reference Count
 ARG - Argument Count
 CJP - Current Jump Address
 IGX - Current Index Assignment
 INO - Dominant Mode Indicator
 MOD - Subprogram Mode
 STN - Statement Number
 TBE - E TABLE PARAMETERS
 TBF - F TABLE PARAMETERS
 TBI - I TABLE PARAMETERS
 TBJ - J TABLE PARAMETERS
 TEM - M TABLE PARAMETERS
 TGF - Function Tag
 TGH - Temporary or Statement Tag

Tables Referenced: Function Name (E)
 Function Tag (F)

Argument Name	(I)
Argument Tag	(J)
Variable Name	(M)

Entry/Exit Register Conditions: None

CHAIN

The method of chaining employed within the Fortran compiler, RUN, is a complete overlaying process. No portion of the main program is available to any segment; likewise, no portion of one segment is available to another. Only the main program or one segment resides in central memory at a time. Arguments may be passed between the main program and a segment or between segments only through blank or numbered common. A segment may be called for execution more than once but the main program should not be recalled since it clears common and the buffers. The maximum amount of numbered or blank common used by any segment must either be declared within the main program or on the RUN card. No diagnostic will result if a segment declares more common than has been previously reserved. A portion of the segment would in that case be overlaid with common.

A job that requires segmentation must have a main program. Initialization code for a program clears common and the I/O buffers. For each file designated on the PROGRAM card a buffer is allocated and the names, number, and order of these files must agree for each SEGMENT card. The segments are separated in the job deck by end-of-record (7-8-9) cards. These records are compiled and written on the disk as individual named files. The name of which is the word following segment on the SEGMENT card. Therefore, if the job deck consisted of a main program and five segments (each separated by an end-of-record card), there would be six named files on the disk for this job.

Segments are called for execution by the statement CALL CHAIN (seg), where seg is the name appearing on the SEGMENT card. During compilation a calling sequence which passes the address of the segment name in B1 to the subroutine CHAIN is generated. The subroutine fetches the segment name at execution time and sends a request to CIO (circular input/output) to rewind the file before it is loaded into central memory. Certain parameters must be initialized before calling CIO so CHAIN sets them in the first five executable words of the calling routine. That is, the CIO buffer parameters are stored in the calling routine beginning at RA+2+n where n is the number of I/O files declared.

A dayfile message informing the user of which segment is next to be executed is made by MSG (peripheral package). A limit of 100B messages is standard so if many segments are called and the MESSAGE LIMIT error is reached with of two system changes will solve the problem:

- a) increase the limit in MSG.
- b) remove the call to MSG in CHAIN so that no segment calls are entered into the dayfile.

Another peripheral package EXU (executed compiled program) is used to locate the file with the requested segment name on the disk and read it into central memory. The file is loaded beginning at relative zero (RA) so that there is no linkage of segments. Only one segment (that portion of the job deck between two end-of-record cards) resides in central memory at a time. EXU also requests the central processor to begin executing the new file in central memory.

CIR

CIR is called to compile read instructions. The tag of the desired read along with a mode indicator and an index assignment, if any, are specified in X6 upon entry in the following format:

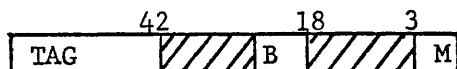

M indicates the mode of the tag and can range in value from one to seven. It is examined and directs the processing in the following order and essentially controls the type of instructions compiled.

M=7 This implies that the tag portion of X6 is a value rather than a tag. If the value is zero, a MXi 0 instruction is compiled to set the value of Xi to zero, while if the value of the tag is minus zero, a MXi 60 is compiled to set the value of Xi to minus zero. CIR then exits.

M=5, 6 This indicates that the tag portion of X6 is a double or complex tag and thus requires the fetching of two central memory words. If the address of the tag is assigned to an index register (B will be the index register the address is in) a SAi Bj is compiled. If B is zero, the A register associates are searched to see if the address is associated with an address register. If so, a SAi Aj is compiled. If not, a SAi TAG is compiled. The tag itself is examined to see if it is an indirect or location tag. If so the instruction just compiled will be reading an address and a SAi Xi is compiled to bring the desired value to Xi. Then a SA_(i+1) Ai+1 is compiled to fetch the second part of the double or complex number. The Xi and Ai register associates are set to this tag.

M=3 This indicates that the tag portion of X6 is a number whose value is less than 2^{16} . The X register associates are searched to see if this value is already in an X register. If it is, a BXi Xj is compiled and if not a SXi CONSTANT is compiled. In either case, the Xi register associate is set to this value before CIR exits.

If the mode of the tag was not one of the above, it is assumed to be a tag for a logical, integer, or real value and will require the fetching of one central memory word. The same method of determining the type of instruction to be compiled is employed as when the mode was double or complex (5,6) except that the final $SA_{(i+1)}$ A_{i+1} is not compiled.

Subroutines Called: ALX - Assign Long Register
 ANI - Analyze Possible Index Read
 ANR - Analyze Read Tag

Temporaries/Flags: BIT - Bypass Interregister Transfer Indicator
 INL - Logical If Indicator
 INN - Mode Indicator for Read
 RGX - Long Register Assignment
 VTA - A Register Associates
 VTY - X Register Associates

Tables Referenced: None

Entry/Exit Register Conditions:

Entry: X6 =

TAG	B	M
-----	---	---

B - Index Assignment

M - Mode Indicator

Exit: X6 =

	R
--	---

Register Assignment

CKD - CHECK MISSING DO NUMBERS

The DO Number Table is searched to see if there are any entries left that are not pseudo DO numbers. If there are, this indicates missing DO numbers and these are listed.

Subroutines Called: WST - Write Special Tag

Temporaries/Flags: None

Tables Referenced: DO Number (G)

Entry/Exit Register Conditions: None

CKL - CHECK MISSING SUBROUTINES

The list of subroutines requested via the CLL call is examined to see if there are any missing. This will be noted because of the fact that none of the missing ones will have a starting address and those missing subroutines will be listed.

Subroutines Called: WST - Write Special Tag

Temporaries/Flags: None

Tables Referenced: None

Entry/Exit Register Conditions:

Entry: B1 - start of the list of routines requested via CLL

Exit: None

CLL - PROCESS CALL STATEMENT

A CALL statement transfers control to a subroutine. Actual parameters may be exchanged between the calling program and the subroutine. No more than 60 parameter may be passed and successive calls to the same routine do not have to agree in the number of parameters used. Calling a subroutine with more actual parameters than formal parameters specified causes a diagnostic during compilation. A function call is compiled in the same manner as a subroutine call except that a value is returned in X6 from the function which must be saved upon reentry to the calling program.

A full word is reserved for each parameter on a SUBROUTINE or FUNCTION card. Each of these words receive a location tag during compilation. The first six arguments in a call are passed through index registers B1-B6 and the remaining addresses are compiled to be stored via external tags in their corresponding reserved word, which has a location tag, in the subroutine. Initial instructions in the subprogram pack the addresses, three per word, from the index registers in two temporary cells. B1 is saved in the lowest 18 bits of the first word with B2 and B3 packed in the next two 18 bit portions. The next temporary cell holds B4-B6 with the address in B4 residing in the lowest 18 bits. When one of these packed addresses is needed and is not available in the index register, then the proper temporary cell is read and the address is unpacked.

Two Fortran subroutines CHAIN and DUMP/PDUMP are specifically processed by CLL. The name of the segment called by CHAIN is replaced by a constant tag and the name is entered into the constant value table. A DUMP/PDUMP indicator is set for calls to these subroutines. After these initial checks and replacements are made, a call to CHAIN or DUMP/PDUMP is processed as any other subprogram request.

Only a routine with an external or a location tag may be called. The subroutine name is entered in the subroutine name table and may have the same name as the program. There will be no conflict because the program name is the first entry in the subroutine name table, so another entry is made for a subroutine name that is the same. When an actual parameter is the name of a function or subroutine, that name must also appear in an EXTERNAL statement in the calling program. This statement causes an external or library tag to be generated for

the subprogram name. This name will have a location tag in the subprogram called which used the name as an argument. Therefore, the name of the subprogram being called may have only a library or location tag.

A call that has arguments allows an arithmetic statement function as an argument. TIQ translates the individual arguments into appropriate tags, or constants. The segment called by CHAIN has already been given a constant tag. Any arithmetic expression or subscripted variable will not be evaluated but each portion of the expression will be replaced with the tag generated by a previous definition or assigned a tag at this point.

UNP directs the processing of expressions imbedded within parenthesis and function references. The outermost set of parentheses are removed and temporary tags are generated to save the information. A call is compiled to the function referenced whether it be an arithmetic function or a function subprogram and the answer which is returned in X6 is saved. (CRF is called by UNP for this purpose).

Upon return from TIQ and UNP, all the arguments have been replaced with tags, the function references processed, and the arithmetic expressions simplified by removing the imbedded parenthesis. PRR (process function/subprogram reference) is called to pass the addresses of the arguments to the subprogram. Any subscripted variable has the variable and subscript replaced with one tag when the array address is determined in the SAD (sense and process single array address) routine. The arithmetic expression partially processed by UNP is completely evaluated by CXP (compile expression). The expression is replaced in the string buffer by a temporary tag which saves the result of the expression. When all the arguments have been evaluated, the addresses of the first six are set into index registers B1-B6, and the remaining ones are to be stored in their corresponding reserved word via an external tag. A DUMP/PDUMP call causes the number of arguments to be passed in B7 and the field length to be set in X0.

If the subprogram called was not an argument to the subroutine, then a return jump to the subprogram is compiled. The return jump instruction is forced to the upper portion of the word. The lower 30 bits contain the number of

arguments in the reference to the subroutine and a tag corresponding to the location of the first word of the calling program or subroutine. The contents of the word has the subroutine's name in the left adjusted display code if the reference is from a subroutine; otherwise, the location is actually RA, which will be zero, if the call is made from a program or segment. Example -

0100 S00600

0715 L00002

where S00600 is location of the entry/exit word of the subroutine
 15 is the number of arguments in the call
 L00002 is the location of the name of the subroutine.

A subroutine used as an argument is a special case. Instead of entering the subroutine via a return jump, instructions are compiled to insert the proper return address in the entry/exit line and generate an unconditional jump to the first executable instruction of the subroutine. In this way a subprogram may call any one of many subroutines depending upon the argument passed from the main program. Each of the subroutines used as an argument to the subprogram must have been declared external to the main program - otherwise the argument is assumed to be a simple variable.

When the call to the subroutine has been generated, then instructions are compiled to restore the argument addresses to index registers if the called subroutine was used as an argument to this subprogram or a function was used as an argument in this call. PSN is called to process the next statement when the call statement processor has completed.

SUBROUTINES CALLED:	ADF	Advance Table	
	CLT	Clear Temporary Table	
	CRI	Compile Restore Instruction	
	PPR	Process Function/Subprogram Reference	
	SCT	Scan Table	
	TAB	Normalize Statement	
	TIQ	Translate Individual Quantities	
	UNP	Unpack Parenthesis	
	TEMPORARIES/FLAGS	ARF	Argument Reference Count
		FAG	Function Argument Use
FSR		Function Statement Reference Count	
ICE		Multiple Statement Count	

INF	DUMP/PDUMP Indicator
RJC	Return Jump Count
SIR	Subroutine Reference Count
TBA	A Table parameters
TBB	B Table parameters
TBM	M Table parameters
TBS	S Table parameters
TBU	U Table parameters
TGK	Constant Tag
TGL	Library Tag
TML	Argument Count
TMM	Subroutine Name
TMN	Subroutine Tag

TABLES REFERENCED:

Constant Name (A)
Constant Tag (B)
Variable Name (M)
Variable TAG (N)
Array Tag (P)
Subroutine Name (S)
Subroutine Tag (T)
Subroutine Parameter (U)

CNF - COMPILE NORMAL FORMULA

CNF is entered when SFO detects an arithmetic replacement statement. It controls the processing of the statement, the conversion of the expression evaluation to that of the answer, and the storing of the answer.

Upon entry, the last statement is checked to see if it was a conditional statement and if so, the expression is cracked immediately. If it wasn't the current jump cell (CJP) is examined. If there was a current jump, the cell is cleared and the expression is cracked. If there was no current jump, but there was a statement number, the expression is cracked. Otherwise, the continue indicator is cleared and if the last statement was not a CONTINUE, X7 is cleared to wipe out any program tag.

In order to evaluate the statement, TAB is called first to normalize the statement, TIQ is called to change the variables and constants to tags and then UNP is to control the compilation of instructions to evaluate and save all portions of the expressions that were imbedded in parentheses. Upon return from UNP, all expressions that were in parentheses are replaced with temporary tags.

A check is then made to see if the expression was a simple one. If so, and the right side is a constant, an instruction is compiled to set X6 to this constant and then go to the portion of the routine that takes care of converting and storing the answer.

If the right side was not a constant, but rather represented by a temporary tag, an attempt is made to delete a store. If the store is deleted, an attempt is made to delete a 106 instruction if there was one. Then the answer is converted and stored. If the right side was not represented by a temporary and was not a constant, or if it was a temporary but the last instruction did not store the answer into this temporary, CXP is called to compile instructions to evaluate what is left of the arithmetic expression.

Thus, CXP is the routine that finally compiles the last of the statement and brings the answer to X6 (and X7 if mode of expression is double or complex). An attempt is made to delete an extra 106 instruction by making the result of the last arithmetic operation X6. Instructions are then generated to convert the mode of the calculated answer to that of the left number of the statement if they are necessary.

The answer is now in X6 (and X7) and is ready to be stored in memory. If the address that the answer should be stored in is in an index register or if the address does not have to be calculated CIW is called to compile the proper write instruction and CNF exits to PSN (Process Statement Number). Otherwise, a search backwards of the compiled instructions is made to see if there is a register free between the present location and that of the temporary store of the address for the answer. If there is, an attempt is made to delete this address store and use the address as it is in the register. Otherwise, CIW is again called to compile the proper store instructions and then an exit is made to PSN.

Subroutines Called: ALX - Assign Long Register
 CIW - Compile Write Instructions
 CXP - Compile Expression
 TAB - Normalize Statement
 TIQ - Translate Individual Quantities
 UNP - Unpack Parenthesis

Temporaries/Flags: CJP - Current Jump Indicator
 INK - Continue Indicator
 RGX - Long Register Assignment
 STN - Statement Number

Tables Referenced: None

Entry/Exit Register Conditions

Entry: B6 ≠ zero if this is part of a conditional statement
 Exit: None

COM - PROCESS COMMON LIST

When the MAA (Process Machine or Ascent Records) subroutine encounters a COM declarative, the COM subroutine (Process Common List) is called. The COM declarative permits the programmer to allocate blank common storage by indicating the number of words and an identifier for the first word of the array. An example of the COM declarative together with the basic steps in processing the list is shown in Figure COM-1.

On entering the COM subroutine, the TAB subroutine is called to normalize the list. If the mode indicator shows anything other than FORTRAN II, a zero block name is entered into the Common Name Table (Table O). The Variable Name Table (Table M) is scanned to determine if the identifier has been previously entered and, if not, the identifier is entered into the Variable Name Table. If the variable has previously been entered in the Variable Name Table, an error exit (Duplicate Tag Error) occurs. The variable name is also checked to insure that the first character is alphabetic and that the name is composed of two or more characters.

Next, a check is made for the equal sign, and the CVN (Convert Number) subroutine is called. A machine constant error exit is taken if the constant is negative or greater than $2^{17}-1$. If the constant is in the proper range it is stored in the Array Parameter Table (Table Q). An Array Tag (W-tag) is generated and stored in the corresponding Array Tag Table (Table P) and Variable Tag Table (Table N).

Processing of the list entries continues in the manner described above until a right parenthesis, indicating the end of the list, is encountered.

Subroutines Called: ADF - Advance Tables
CVN - Convert Octal and Decimal Numbers
SCT - Scan Table
TAB - Normalize Statement

COM DECLARATIVE PROCESSING

EXAMPLE: $COM(B1=1, B2=2, B3=3)$

1. STORE VARIABLE NAME IN VARIABLE NAME TABLE
2. CHECK FOR EQUAL SIGN
3. CONVERT CONSTANT
4. STORE CONSTANT IN ARRAY PARAMETER TABLE
5. IF NEXT CHARACTER IS A COMMA, REPEAT 1 - 5
6. CHECK FOR A RIGHT PARENTHESIS
7. RETURN FOR THE NEXT SOURCE CARD

Temporaries/Flags: MOE - Program Mode (set)

Tables Referenced: TBM - Variable Name
TBN - Variable Tag
TBO - Common Name
TBP - Array Tag
TBQ - Array Parameter

Entry/Exit Register Conditions

CON - PROCESS CONSTANT LIST

When the MAA (Process Machine or Ascent Records) subroutine encounters a CON declarative, the CON subroutine (Process Constant List) is called. The CON declarative stores the constant in the list and tags the storage location with the identifier in the list. An example of the CON declarative together with the basic steps in processing the list is shown in Figure CON-1.

On entering the CON subroutine, the TAB subroutine is called to normalize the list. The Variable Name Table (Table M) is scanned to determine if the variable which has been equated to the constant has been entered, and, if not, the variable is entered in the Variable Name Table. If the variable has previously been entered in the Variable Name Table, an error exit (Duplicate Tag Error) occurs. The variable name is also checked to insure that the first character is alphabetic and that the name is composed of two or more characters.

Next, a check is made for the equal sign, and the CVN (Convert Number) subroutine is called. The constant is stored in the Hollerith Word Table (Table A), and a Constant Tag (K-tag) is generated and stored into the corresponding Hollerith Tag Table (Table B) and Variable Tag Table (Table N).

Processing of list entries continues in the manner described above until a right parenthesis, indicating the end of the list, is encountered.

Subroutines Called: TAB - Normalize Statement
SCT - Scan Table
ADF - Advance Table
CVN - Convert Octal and Decimal Numbers

Temporaries/Flags: TKG - Constant Tag (set)

CØN DECLARATIVE PROCESSING

EXAMPLE: CØN(C1 = 25, C2 = 777B, C3 = 6.54E-2)

1. STORE VARIABLE NAME (e.g., C1) IN VARIABLE NAME TABLE
2. CHECK FOR EQUAL SIGN
3. CONVERT CONSTANT
4. STORE CONSTANT IN CONSTANT VALUE TABLE
5. IF NEXT ENTRY IS A COMMA, REPEAT 1 - 4
6. CHECK FOR RIGHT PARENTHESIS
7. RETURN FOR NEXT SOURCE CARD

Tables Referenced: TBM - Variable Name Table
TBA - Constant Table
TBB - Constant Tag
TBN - Variable Tag

Entry/Exit Register Condition: DNA

Note: Error Exits: EMT - Machine Tag Definition Error
EMD - Machine Duplicates Tag Error
EMF - 1 Format Error

CRF - COMPILE FUNCTION REFERENCE

CRF is called to control the processing of a subroutine or function reference. Upon entry, the string entry containing the tag for the function is specified. Control will be routed to three routines depending upon the type of subroutine reference. If it is a built-in function, PBR is called to evaluate it; for an arithmetic statement function, PFR is called while PRR is called for a function/subprogram reference. Upon return from these routines, CRF will exit.

Subroutines Called: PBR - Process Built-in Function
PFR - Process Statement Function
PRR - Process Function-Subprogram

Temporaries/Flags: TML - Argument Count for Call
TMM - Name Tag for Call
TMN - Argument Tag for Call

Tables Referenced: None

Entry/Exit Register Conditions:

Entry: B5 + address of start of subroutine reference

Exit: X7 = zero

CVN - CONVERT OCTAL OR DECIMAL NUMBER

The CVN subroutine converts an octal or decimal number. It is used for constants in the address field of either a Machine or Ascent instruction. The unsigned constant is sent to DEC (Convert Decimal Number) and if the mode is Ascent, the sign is restored and a return to the calling program with the value in the X6 register occurs. However, if the mode is Machine, the B6 register is set to one and X6 contains the signed converted constant. Also leading blanks of the address field are compressed for machine instructions.

Subroutines Called: DEC - Convert Decimal Number

Temporaries/Flags: MHI - Machine Instruction

Tables Referenced: None

Entry/Exit Register Conditions:

X6 - Converted Constant

B6 - if Machine = 1

CXP - COMPILE EXPRESSION

CXP controls the evaluation of all arithmetic expressions, whether the expression is part of an arithmetic replacement statement, in an argument list, or the arithmetic expression of an IF statement. The starting address of the expression is specified upon entry and instructions will be compiled to evaluate the expression until a left parenthesis or comma is found that is not part of an array reference, or until end of statement has been reached.

Instructions are first compiled to calculate the address of all array entries within the expression. CSR (Compile Subscripted References) is called to compile these instructions and it will bring the address of the array entry to a specified index register. As each array address is calculated, the actual entry in the string is changed to an indirect tag along with an indication of which index register the address is in, and the rest of the array entry is squeezed out of the string. After index register 6 has been used, A0 is used to hold the next array address, B7 is used to hold the address of the last array entry and all addresses in between are saved in indirect cells.

It is assumed that by the time CXP is entered, all addresses for array entries that appear more than once in the statement have already been calculated and saved in an indirect cell and CXP makes no check to see if this has been done. After instructions have been compiled to determine the address of all array entries in the expression and the entries have been replaced by tags, the expression is ready to be evaluated. The HEX routine is called first to evaluate any exponentials within the statement. It will compile instructions to evaluate these exponentials, and store the answer into a temporary cell. The string entry for the exponential will be replaced by this temporary tag and the expression will be squeezed down. Since HEX has to examine every entry in the expression, it will also determine the dominant mode of the expression and, if there are any logical relations, it will set the logical relation flag.

When HEX returns to the CXP routine, the logical relation flag is checked and the HLR routine to handle logical relations is entered if any have been detected. Depending upon the dominant mode of the expression, CXP will then branch off to a routine to handle each mode. Generally, these routines are responsible for compiling instructions to evaluate the rest of the expression, converting all entries in the expression to the dominant mode if they are not in that mode already, and finally bringing the result of the expression to X6 and X7 if the dominant mode is double or complex. CXP will then change the last string entry of the expression to flag the dominant mode of the expression and exit.

Subroutines Called: AAR - Analyze Array Reference
 ANK - Analyze Address Generating Instructions
 for Right Number
 ALX - Assign Long Register
 BEX - Compile Simple Boolean Expression
 CSR - Compile Subscripted Reference
 FEX - Compile Simple Floating Expression
 HEX - Handle Exponentials
 HLR - Handle Logical Relations
 JEX - Compile Simple Integer Expression
 KEX - Compile Simple Complex Expression
 LEX - Compile Simple Logical Relation
 MEX - Compile Simple Double Expression

Temporaries/Flags: ARI - Array Reference Count
 BIT - Bypass Interregister Transfer Indicator
 HIC - Highest Index Count
 ICL - Simple Logical Relation Indicator
 ICU - Index Tag
 ICV - Upcoming Statement and Unpack Indicator
 IGX - Current Index Assignment
 INM - Logical Relation Indicator
 INO - Dominant Mode Indicator
 INX - Upcoming Statement Indicator
 INY - Complete Unpack Indicator

SAR - Single Array Reference Count
TGI - Indirect Tag
TGT - Temporary Tag
TMF - Start of Array Reference
TMG - Expression of Index Assignment
TMH - Start of Expression
VTA - A Register Associate
VTY - X Register Associate

Tables Referenced: None

Entry/Exit Register Conditions:

Entry: B5 - Address of the start of expression

Exit: None

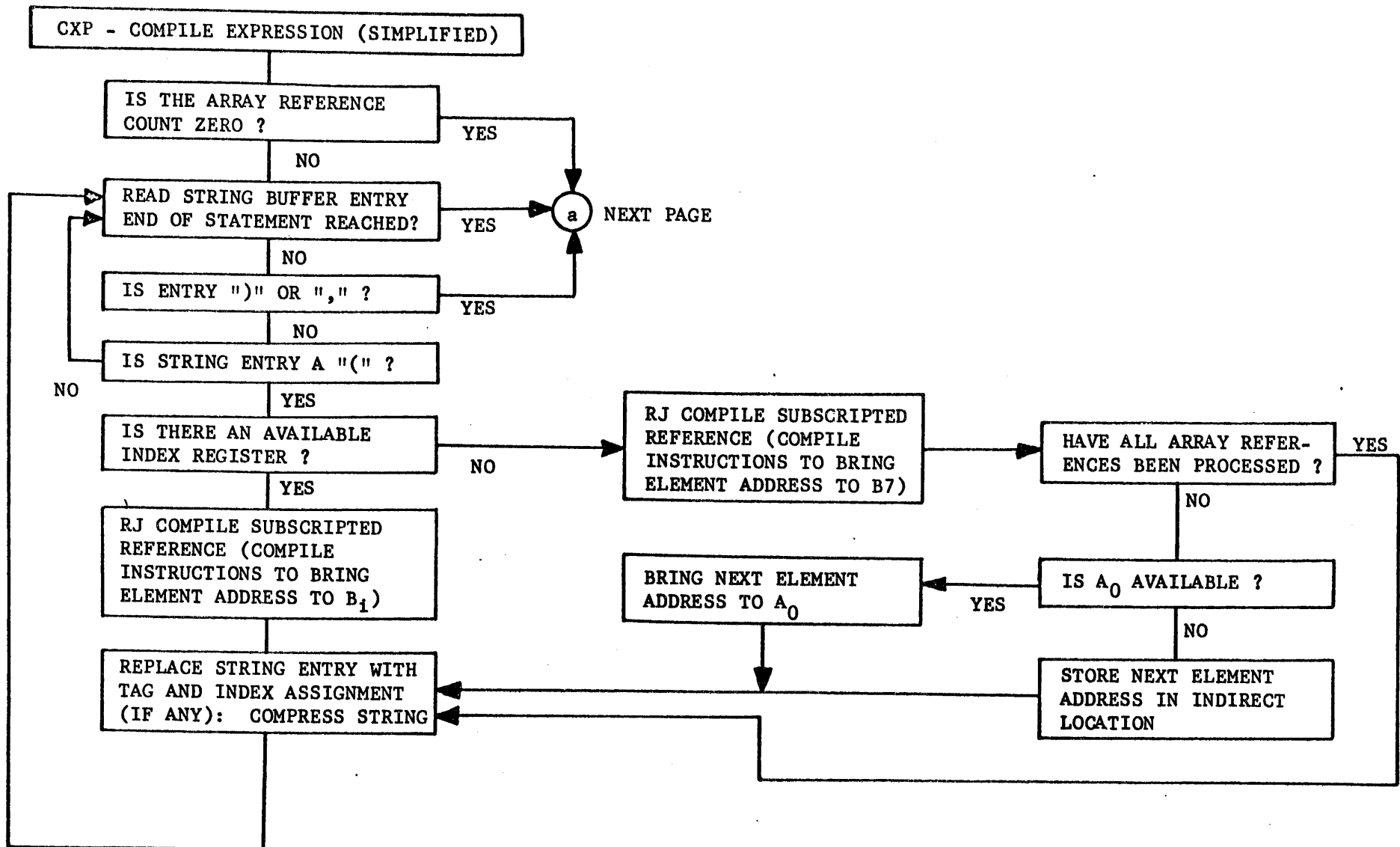

CXP-COMPILE EXPRESSION

a FROM PREVIOUS PAGE

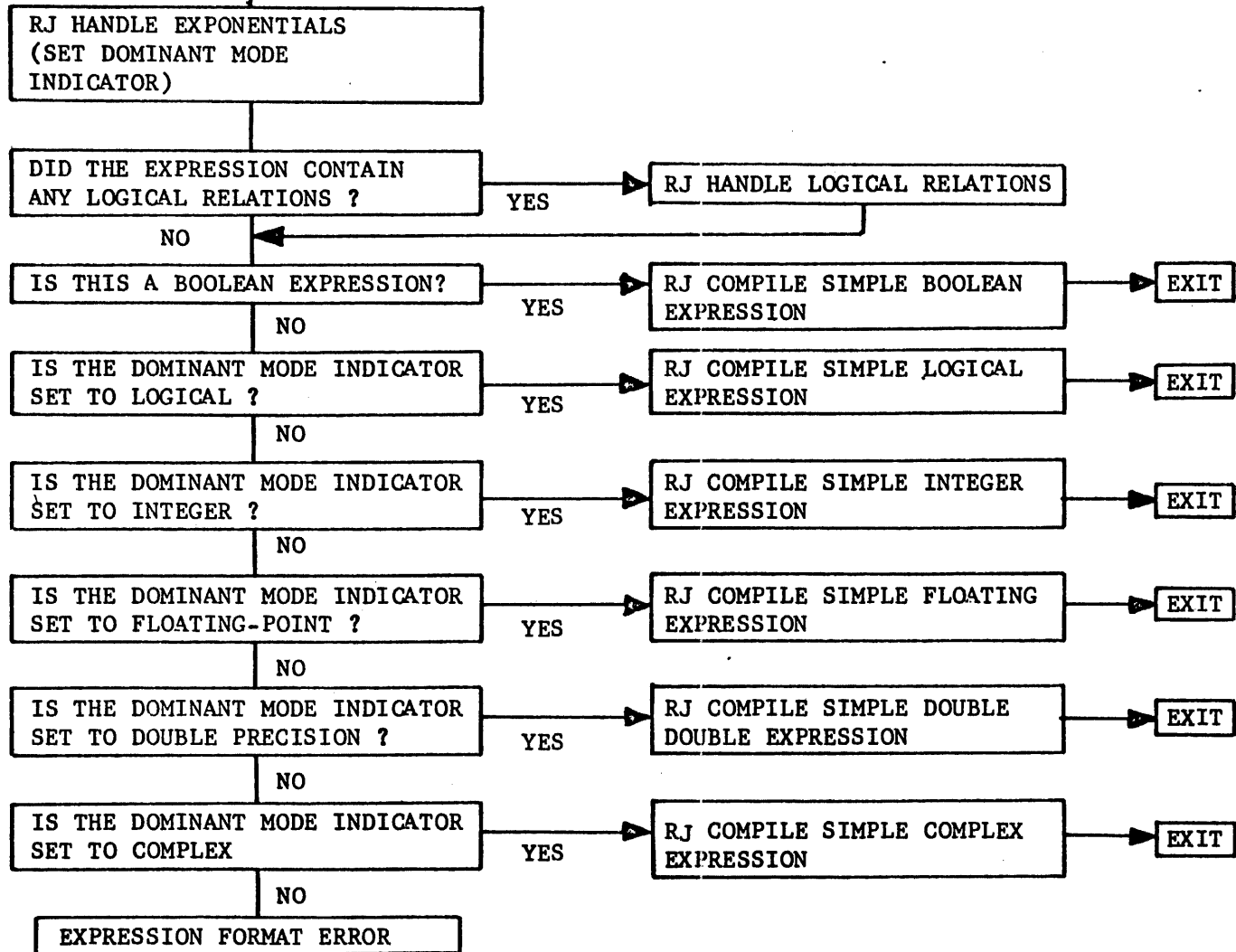

DEC - CONVERT DECIMAL NUMBER

The DEC subroutine converts a decimal constant to its binary equivalent; it also checks for octal constants of the form nnn...nB. (Note: octal constants of the form \emptyset nnn...n which appear in arithmetic statements are recognized by the Translate Variable subroutine.) DEC is called when a numeric entry is recognized in a DATA statement or arithmetic statement. On entering DEC, the string buffer address of the numeric entry is contained in the B5 register. When the TAB subroutine normalized the statement, it employed the ASN subroutine to pack digits into words. The ASN subroutines assembles up to seven digits per word, so numbers in the string buffer may occupy several entries. For example, a 20 digit octal constant would appear in the string buffer as shown in figure DEC-1a. Similarly, decimal constants may occupy several words. For example, a floating-point number such as 37.84625184E-40 would appear in the string buffer as shown in figure DEC-1b.

DEC searches the next three entries following the numeric entry to determine if the number is followed by a "B". If it is, the Convert Octal Constant (OCT) routine is called to convert the number. If the numeric entry was not followed by a B, this and succeeding entries are read, converted to binary, and packed in an assembly register. Conversion continues until a non-numeric entry is encountered or until more than 18 digits have been processed. The latter condition results in an error exit. The non-numeric which terminated this part of the conversation is examined to see if it is a period (i.e., a decimal point): if it is not, then the constant is an integer constant. If the non-numeric is a decimal point, then the entries following the decimal point are read, converted to binary, and packed in the assembly register. Conversion again continues until a non-numeric entry is encountered or until more than 18 digits have been processed. The number of digits in the fractional part are saved to be used later in computing the proper exponent value, and the assembled binary number is converted to floating-point and normalized.

nnnnnnn	nnnnnnn	nnnnnn	B	
---------	---------	--------	---	--

Word 1 Word 2 Word 3 Word 4

Figure DEC-1a: FORMAT OF A 20-DIGIT OCTAL NUMBER IN THE STRING BUFFER

37	.	8462518	4	E	-	40
----	---	---------	---	---	---	----

Word 1 Word 2 Word 3 Word 4 Word 5 Word 6 Word 7

Figure DEC-1b: FORMAT OF A FLOATING-POINT CONSTANT, 37.84625184E-40, IN THE STRING BUFFER

The non-numeric entry which terminated the conversion of the fractional part of the number is then examined: if it is a D or an E, the sign of the exponent is stored and the exponent converted to binary. This exponent is then combined with the number of digits in the fractional part of the number, and converted to the appropriate powers of two.

Subroutines Called: OCT - Convert Octal Constant

Temporaries/Flags: none

Tables Referenced: Table of Powers of 10^{2^n} (REG)

Entry/Exit Register Conditions

Entry: B5 = address of numeric entry in string buffer

Exit: B5 = address + 1 of last entry processed (i.e., the string buffer address of the entry following the number)

X6 = number

X2 = 0 (second word of a double precision conversion)

B6 = Mode Indicator

Note: The mode indicator is set as follows:

<u>Mode</u>	<u>Constant</u>
1	Octal
2	Integer
4	Floating Point
5	Double Precision

FIN - FORM INSTRUCTION

In the processing of Ascent or Machine records, an intermediate language is generated and stored in the string buffer. The FIN subroutine forms the octal instruction by examining the string buffer which has been flagged by the RDA routines. FIN first determines if the instruction is a long (30-bit) instruction. An equal sign in column 8 and either a positive result in the TOS Table look-up or entries 0-3 of the TOI Table look-up (see Appendix B) are 30-bit instructions. For these long instructions, FIN can determine the instruction by examining columns 7, 12 and 13. If column 7 is a P or R and column 12 is a period, then column 13 defines which 03 instruction should be formed. The X, A and B registers are always indicated by an A, C or B respectively, and a K address is flagged with a G. If column 7 is a P or R and column 12 is not a period, then column 12 describes instructions 04-07.

If column 7 is an A, C or B, it describes the resultant or "i" register and a table look-up provides the exact instruction. The tables searched are TOI for instructions 50-77, TOP for instructions 11-13, 15-17, 30-42, 44-45 and TOS for 10, 14, 20-27, 43, 47 and certain long instructions with implied X0 registers (see Figure RDA-1 for the flags corresponding to given instructions). Once the instruction is selected, a jump to FSI (Form Short Instruction) or FLI (Form Long Instruction) is taken.

Entry conditions are the flagged string, III, JJJ and KKK register constants. X5 contains the K value where applicable and X7 contains the current word address. Calls to further routines combine the opcode and registers.

Subroutines Called: SCS - Special Search
FSI - Form Long Instruction
FLI - From Short Instruction

Temporaries/Flags: III - i Portion of Machine Word
JJJ - j Portion of Machine Word
KKK - k Portion of Machine Word

Tables Referenced: TOI - Table of Format Checks on Instructions 50-77
TOP - Table of Identifying Characters
TOS - Table of Special Formats

FLI - ASSEMBLE LONG INSTRUCTION

When the FIN (Form Instruction) subroutine encounters a 30-bit Ascent or Machine instruction, the FLI subroutine is called. The FLI routine assembles these instructions as a 6-bit opcode, a 3-bit resultant register, a 3-bit operand register and a 15-bit address. Then it arranges these instructions in the parcels of a 60-bit machine word. If an RJ instruction is found, a full word is indicated. Upon entry, X0 contains the opcode right-justified, B1 and B2 contain the resultant and operand registers respectively. FLI calls the CDC (Convert Instruction or Constant Tag to Display Code) subroutine to form and insert in the output buffer the display code equivalent for this instruction. Next, the routine checks the intraword count and if the 30-bit instruction cannot be inserted, a call to the ARA (Adjust Address and Write Registers) subroutine is made and the 30-bit instruction goes to parcels 0 and 1 of the next word. If the 30-bit instruction can fit, a test is made to properly place this instruction and the intraword counter is incremented by 2. Upon exit from this routine, both the display code and binary forms have been recorded.

Subroutines Called: CDC - Convert to Display Code
ARA - Adjust Address and Write Register

Temporaries/Flags: ICT - Intraword Instruction Counter (set)

Tables Referenced: None

Entry/Exit Register Conditions:

X0 opcode (binary)
B1 - i portion of instruction else 0
B2 - j portion of instruction
X7 - current instruction word address

FSI - ASSEMBLE SHORT INSTRUCTION

When the FIN (Form Instruction) subroutine encounters a fifteen bit Ascent or Machine instruction, the FSI subroutine is called. The FSI subroutine assembles a six bit opcode, three bit resultant register (i) and two three bit operand registers (j, k), then stores the display code equivalent in the output buffer. Upon entry into this routine, X0 contains a table (TOP, TOS or TOI) entry. If bit 18 of X0 is set then a test is made on bits 6-11, if 6-11 are zero, B1, B2 and B3 contain the correct ijk register respectively. If bits 6-11 are equal to one, then X5 contains the corrected values for the i, j and k registers and if bits 6-11 equal two, the j and k registers must be interchanged. These bits may contain another value only if the i and j registers are equivalent. If bit 18 is not set, then B1, B2 and B3 contain the i, j and k registers and X0 contains the octal op code. A call is made to CDC (Convert Instruction or Constant Tag to Display Code) then a check is made as to the correct parcel in the current word. Since only one fifteen bit instruction is assembled, the intraword counter is incremented by one. Upon exit from this routine, both the display code and binary forms of the instruction have been recorded.

Subroutines Called: CDC - Convert Instruction or Constant Tag to Display Code

Temporaries/Flags: ICT - Intraword Counter (set)

Tables Referenced: None

Entry/Exit Register Conditions:

B1	resultant register
B2	first operand register
B3	second operand register
X0	opcode
X5	register values under certain conditions
X7	current instruction word address

HOL - PROCESS HOLLERITH LIST

When the MAA (Process Machine or Ascent Records) subroutine encounters an HOL declarative, the HOL subroutine (Process Hollerith List) is called. The HOL declarative allows a ten character group to be stored in display code and tagged with an identifier. An example of the HOL declarative together with the basic steps in processing the list is shown in Figure HOL-1.

On entering the HOL subroutine a jump is taken to ASV (Assemble Variable) to isolate the identifier. If the identifier is not followed by an equal sign an error exit (Machine Format Error) is taken. The identifier is also checked to insure that the first character is alphabetic and that the identifier is composed of two or more characters. Then the Variable Name Table (Table M) is scanned to determine if the identifier had been previously entered, and, if not, the identifier is entered into the Variable Name Table. If the identifier had previously been entered in the Variable Name Table, an error exit (Duplicate Tag Error) occurs.

Next, ten characters are assembled from the string. These ten characters are entered into the Hollerith Word Table (Table A). A Constant Tag (K-tag) is generated and stored into the corresponding Hollerith Tag Table (Table B) and Variable Tag Table (Table N).

Processing of the list entries continues in the manner described above until a right parenthesis, indicating the end of the list, is encountered.

Subroutines Called: ASV - Assemble Variable
SCT - Scan Table
ADF - Advance Table

Temporaries/Flags: TKG - Constant Tag (set)

HOL DECLARATIVE PROCESSING

EXAMPLE : HOL (H1=ABCDEFGH IJ, H2=1234567890)

1. CHECK FOR AN EQUAL SIGN
2. STORE VARIABLE NAME (e.g., H1) IN THE VARIABLE NAME TABLE
3. ASSEMBLE TEN CHARACTERS
4. STORE THE HOLI.ERITH FIELD IN THE CONSTANT TABLE
5. GENERATE A CONSTANT TAG AND STORE IN TABLE
6. IF THE NEXT ENTRY IS A COMMA, REPEAT 1- 5
7. CHECK FOR A RIGHT PARENTHESIS
8. RETURN FOR THE NEXT RECORD

Figure Hol-1

HOL-2

Tables Referenced: TBM - Variable Name Table
TBA - Hollerith Word Table
TBB - Hollerith Tag
TBN - Variable Tag

Entry/Exit Register Conditions: DNA

Note: Error Exits: EMT - Machine Tag Definition Error
EMF - Machine Format Error
EMD - Machine Duplicate Tag Error

IFH - PROCESS IF SENSE STATEMENT

IFH is called from IFS when it is determined that the IF might be a SENSE SWITCH or SENSE LIGHT type IF. After some initial checking to see that the format of the statement is correct, and determining which type sense it is, the two branches of the statement are changed to tags. Instructions are then generated to read RA of the program, to mask off the declared switch or light (actually these are the same), and a zero jump is compiled to the second branch. If the statement was a SENSE LIGHT IF, instructions are compiled to turn this light on. Finally, instructions are compiled to jump to the other branch of the statement if it is not the same as the upcoming statement number, and control is transferred to PSN to process the statement number.

Subroutines Called: ASL - Assemble Letters
ASN - Assemble Numbers
ISN - Identify Statement Number
CUN - Tag Upcoming Statement Number

Temporaries/Flags: None

Tables Referenced: None

Entry/Exit Conditions:

Entry: None

Exit: None

IFL - PROCESS LOGICAL IF STATEMENT

IFL is entered once the IFS routine determines that the statement is not an I/O type IF and that the first entry past the right parenthesis is not a statement number. At this time, the last parenthesis is replaced by a zero entry to flag the end of the statement and the statement is normalized starting with the second parenthesis. The first parenthesis is replaced by an equals sign in order to simulate an arithmetic expression and the individual entries in the statement are translated to proper tags. UNP is called to control the evaluation of all portions of the expression that are imbedded in parenthesis. CXP is then called to complete the evaluation of the expression. An instruction is compiled to count the number of ones in X6 and a zero jump instruction over the coding that will be generated by the evaluation of the rest of the logical IF statement is compiled. An attempt is made here to eliminate a BX6 Xi instruction if it was the last one compiled in the evaluation of the expression. The processed portion of the IF statement is changed to blanks, the address of the zero jump instruction is saved as the current jump and a return to the main routine is made at CPQ which is the return for a conditional statement.

Subroutines Called: CXP - Compile Expression
TAB - Normalize Statement
TIQ - Translate Individual Quantities
UNP - Unpack Parenthesis

Temporaries/Flags: CJP - Current Jump
TGH - Statement Tag
TMO - Start of Conditional Statement

Tables Referenced: None

Entry/Exit Register Conditions

Entry: B3 = address of first left parenthesis in string

B4 = address plus one of last right parenthesis

Exit: B5 = 24B to flag a conditional statement next

IFS - PROCESS IF STATEMENT

The IFS routine controls the evaluation of an IF statement. The system allows four types of IF including the I/O checks, the SENSE SWITCH AND SENSE LIGHT checks, the logical type IF, and the normal arithmetic expression with two or three branches. The first seven characters past the first left parenthesis are extracted and a check is made to see if this might be a SENSE type IF. If so, control is passed to the IFH routine. If not a check is made to see if it is some type of I/O check, and if it is, it is evaluated within this routine. If it is not an I/O type IF, the first entry after the last right parenthesis is examined. If it is not a number, a logical type IF is assumed and control is transferred to the IFL routine.

I/O type IF: After extracting the tape number and determining which type of I/O check is being made, the routine to compile tape handling instructions (PMT) is called. After returning from this routine, the call to the proper routine will have been compiled and then the proper tests will have to be generated. For an "IF(UNIT, ''") I/O check, tests are generated to jump to each one of the branches. The upcoming statement number is checked for the rest of the I/O checks and one of the test jumps is eliminated if possible.

Normal IF: When it has been determined that it is a normal IF, the statement has been normalized and the first entry past the last right parenthesis is a number. In order to use the existing arithmetic statement processing, column seven is changed to an equals sign, and the routine called UNP is called to control the processing of all portions of the statement embedded in parenthesis. CXP is then called to complete the evaluation of the expression and the appropriate test jumps are then generated with checking for equal branches and branches the same as the upcoming statement number. Any unnecessary test jumps are thus eliminated. Control is then given to the PSN routine to process the statement number.

Subroutines Called: ASL - Assemble letters
ASN - Assemble numbers
ASV - Assemble variable
CUN - Tag upcoming statement numbers
CXP - Compile expression
ISN - Identify statement number
PMT - Compile tape handling instructions
TAB - Normalize statement
TIQ - Translate quantities
UNP - Unpack parenthesis

Temporaries/Flags: TMI - First statement number
TMJ - Second statement number
TMK - Third statement number

Tables Referenced: None

Entry/Exit Register Conditions

Entry: B4 = First left parenthesis of statement

Exit: None

ISL - IDENTIFY SYMBOLIC TAG

The ISL subroutine is called when a symbolic tag is being processed by PTC (Process Tag and Constant). ISL checks the tag length; it must be less than six alphanumeric characters, then the Argument Name Table (Table I) is scanned and if the variable is found to be there, a normal return is taken. If the variable does not yet appear in the table, a statement tag is generated and both the tag and name are sent to the Variable Name Table. The generated tag is returned in the X6 register.

Subroutines Called: SCM - Scan With Masking
ADF - Advance Tables

Temporaries/Flags: TGH - Statement Tag

Tables Referenced: TBI - Argument Name Table

Entry/Exit Register Conditions:

Entry: X6 - Variable Name

Exit: X6 - Generated Statement Tag

ISN - IDENTIFY STATEMENT NUMBER

The ISN subroutine searches the Statement Number Table (Table K) for a specified statement number and, if not found, enters it in the Statement Number Table. On entering the ISN subroutine, leading zeroes are deleted from the statement number, and the number checked to see if it is composed of more than five digits. If the number contains more than five digits, or contains a non-numeric character, an error exit (Statement Number Error) occurs. If the number is a valid statement number, the Statement Number Table is searched: if the number is found in this table, control is returned to the calling program. If the number is not found in the Statement Number Table, it is entered in this table, and a statement tag (H tag) is generated and stored in the corresponding entry in the Statement Tag Table (Table L). Control is then returned to the calling program.

Subroutines Called: SCT - Scan Tables
ADF - Advance Tables

Temporaries/Flags: TGH - Statement Tag (set)

Tables Referenced: Statement Number Table (Table K)
Statement Tag Table (Table L)

Entry/Exit Register Conditions

Entry: X6 = Statement number

Exit: X6 = corresponding tag from Statement Tag Table

KOT - CONVERT BINARY TAG TO MNEMONIC TAG

The KOT subroutine converts the binary tag associated with the instruction to a mnemonic tag which is printed with a compiled listing. Input to the routine is from CDC (Convert Instruction or Constant Tag to Display Code) which places the binary tag left-justified in the X1 register. Output is the alphanumeric tag in display code. Tags in the range of 200000 to 600000 are converted by examining the upper 5 bits and selecting a letter (L, I, T, C, F, A, V, N or S) for this configuration. The sixth bit, if set, generates a 1 as the second character and if unset, generates a zero. The remaining four digits are merely converted to their display code equivalent. The program tag description given in the appendix shows the exact letter given above for any given numeric tag.

Subroutines Called: None

Temporaries/Flags: MOD - Machine/Ascent Indicator

Tables Referenced: None

Entry/Exit Register Conditions:

X1 binary tag left-justified
X6 mnemonic tag left-justified

LST - PROCESS INPUT/OUTPUT LIST

The calling sequence to the execution time I/O routines is constructed by LST. The statement processor, RIT (READ), WOT (WRITE), PNC (PUNCH), etc., decides from the form of the statement which execution time routine is to be referenced. Also, the file name from the logical unit parameter has been constructed and B3 contains the address of the format statement.

At least three calls are made to the I/O subroutines - 1) initialization 2) intermediate 3) termination. There will be an intermediate entry for each array or data item to be transferred. Naturally, an I/O statement without a list would have only two entries made to the subroutine. The ENCODE/DECODE statements have a different initialization entry for their subroutines but the intermediate and termination entries are the same. The subroutines that will be referenced are:

INPUTC for coded reading
 INPUTB for binary reading
 INPUTS for DECODE
 OUTPTC for coded writing
 OUTPTB for binary writing
 OUTPTS for ENCODE

The calling sequence for these subroutines, except INPUTS and OUTPTS is:

Initialization:	B1 = 0
	B2 = address of parameter or complemented address of variable tape number
	B3 = address of format statement
Intermediate:	B1 = address of data item or beginning address of array
	B2 = array length or 0
Termination:	B1 = -1

For INPUTS and OUTPUTS:

Initialization I	B1 = 0
	B2 = 0
	B3 = address of format statement
	B4 = number of coded characters
Initialization II	B1 = address of packed data
	B2 = 0

All files to be referenced within a program must be declared on the PROGRAM card. Each name is entered into the File Name Table. Whenever a reference is made to a file, the location of the buffer parameter list may be retrieved from this table if the logical unit number is not a variable. The address is then set in B2 to be sent to the subroutine. In the case that the logical unit number may vary, PMD (Process Tape Medium for Input/Output) will pass the address of the variable in complemented form to the subroutine. The initialization entry to the subroutine is then made with B1, B2, and B3 set accordingly. TSF (Tag Special Function) finds the tag associated with the subroutine to be called and this tag is used in the return jump instruction.

TAB (Normalize Statement) removes unnecessary blanks, and packs the variables and constants into one-word string buffer entries. Replacing the variables with tags is done by TIQ (Translate Individual Quantities). A simple variable address is set in B1 and B2 is zero unless the variable is double or complex in which case B2 = 2.

An implied DO-loop transfer makes an entry into the subroutine for each item in the array. Example: READ (25, 10) (T(I), I=1, 8) causes the subroutine to be referenced eight times. However, if T had been dimensioned then READ (25, 10) T would transfer the whole array with only one entry because the array length is retrieved from the Array Parameter Table and set in B2. The implied DO-loop code is generated by HBL (Process Left Parenthesis) and HCL (Process Equal Sign).

An array variable which is subscripted in the list requires CSR (Compile Subscripted Reference) to fetch the address of the word within the array. This address is sent in B1 and B2 will be zero since only one word of

the array is being transferred.

If the variable was an argument to the routine, then it would have a location tag. If this tag is not in the Array Tag Table, then it must not have been dimensioned. GAT (Compile Argument Address Pick) gets the address that was passed to the routine and sets it into B1.

A variable with a location tag that was found in the Array Tag Table may

- 1) be followed by a subscript
- 2) have had fixed dimensions and the entire array is to be transferred
- 3) have variable dimensions and the entire array is to be transferred

In the first case, the subscript is handled in the same way as an array that was not passed to the routine as an argument. CSR (Compile Subscripted Reference) compiled instructions to fetch the proper word within the array and this address is set in B1.

An array variable used as an argument which appears in a DIMENSION statement may have the dimensions as constants or variables. A variable dimension also enters the routine as an argument. If the dimensions are constants, then the array length of the variable is read from the Array Tag Table and saved in the Constant Value Table. CIR (Compile Read Instructions) is called to fetch this value as a different argument is passed to the routine. B2 is then set to this array length and the beginning address of the array is found by GAT (Compile Argument Address Pick).

Variable dimensioned arrays have an entry in the Array Tag Table but the array parameters are given location tags instead of constant values. By scanning the Array Tag Table and checking the 2^{16} bit of the corresponding entry, it can be determined whether or not the dimensions have location tags. Instructions are compiled to construct the length of the array. If it is a single dimensioned array, then just the address of the one variable is sent in B2. A two dimensioned array must use the product of these two variables as a length. So with three dimensions, another product of the third dimension and the first two necessary for the length. In all cases the beginning address of the array is sent to

the subroutine in B1 and the length is set in B2. A double or complex variable always has an array length twice the size available from the Array Parameter Table set in B2.

When the last data item has been processed, then a final entry with B1 = 1 is compiled to the subroutine. CRI (Compile Restore Instruction) is called to restore the addresses of the arguments to index registers if there were any arguments passed to the routine.

Subroutines Called: ADF - Advance Table
 ASV - Assemble Variable
 CIA - Clear All Registers
 CIR - Compile Read Instructions
 CRI - Compile Restore Instructions
 CSR - Compile Subscripted Reference
 GAT - Compile Argument Address Pick
 HCL - Process Equal Sign
 HBL - Process Left Parenthesis
 PMD - Process Tape Medium
 SCM - Scan Table With Mask
 SCT - Scan Table
 TAB - Normalize Statement
 TIQ - Translate Individual
 TSF - Tag Special Function

Temporaries/Flags: TMA - Pseudo Statement Number
 TMD - Subroutine Tag

Tables Referenced: Constant Value (A)
 Constant Tag (B)
 Array Tag (P)
 Array Parameter (Q)

Entry/Exit Register Conditions:

Entry: X4 - Subroutine Name
X5 - Filename
B6 - NZ if ENCODE/DECODE
Exit: None

MAA - PROCESSING MACHINE OR ASCENT RECORDS

When the Run compiler interprets an Ascent or Machine header card, all subsequent records, without an * in column 1 until the next END card, are processed by the MAA subroutine. MAA first concerns itself with the operation field of the current record. Examining this field determines one of four types for this record (reference Figure MAA-1): 1) a constant or Machine register notation, 2) an Ascent mnemonic, 3) an Ascent pseudo-op or 4) a Machine declarative or FORTRAN non-executable.

The first group is processed in the MAA routine while the other three are linked with a series of subroutines. Upon determining a Machine operation or constant, MAA calls the PST (Process Location Tag) subroutine to store and tag the statement label or suppress any leading blanks. Next, a check is made for a left parenthesis indicating a block reservation request. Several checks are made for the correct form for this instruction, if there is a positive decimal or octal number enclosed within parenthesis, followed by an end of statement, and a core overflow will not occur, then MAA allocates and initializes to zero the given number of cells, and a jump to a common return area occurs. (reference Figure MAA-2). Should the type one processing encounter a constant, a jump is taken to ARA (Adjust Address and Write Register) to write the previous word. Then a jump to TAB (Normalize Statement) reorders the string buffer and a jump to CVN (Convert Constant) stores the octal equivalent to the FORTRAN acceptable constant. If this section has been entered from another type processing a check is made on the constants range. In any event, the common return area is entered. (reference Figure MAA-3). Sensing a dollar sign in the instruction field transfers control to the type 2 processing of a NO instruction. Another acceptable form for type 1 is the constant section header card. This card will cause a call to ARA (Adjust Address and Write Register) subroutine, set the instruction word counter, write blanks into the output buffer, write the record, read the next record, check for an end of file which is illegal at this point, then return to the main Run loop. (reference Figure MAA-4).

Type 1 processing of a Machine register notation calls the PAF (Process

TYPE I

NO LETTERS

- HEADER CARD
- CONSTANTS

MACHINE OPCODES

TYPE II

TWO LETTER
ASCENT MNEMONICS

- 2 LETTER OPCODES
- 2 LETTER + DIGIT
OPCODES

TYPE III

ASCENT PSEUDO-
OPERATIONS

- BSS
- EQU
- DPC
- BCD
- CON
- BSSZ

TYPE IV

MACHINE
DECLARATIVES

- CON
- ABS
- SUB
- RES
- COM
- HOL
- FORTRAN
STATEMENTS

OPERATION CODE FIELD TYPES

Additive Field) subroutine. This routine flags the string buffer with an intermediate language identical to RDA's processing of Ascent instructions (reference Figure RDA-1). If a tag or constant has not been processed, the PTC (Process Tag and Constant) subroutine is called, then FIN (Form Instruction) is called and the processing is continued as in type 2.

The common return section indicates a full word has been processed, calls CDC (Convert to Display Code) for the output listing, writes the record into the buffer area, reads the next record, checks for an illegal end of file, then returns for processing this record. The return calls AFS (Assemble FORTRAN Statement) and if an * is found, the next record is read and checked; if not, MAA is re-entered from the Run main loop. The processing of type 2 Ascent mnemonics also calls the PST (Process Location Tag) subroutine then calls the RDA (Reduce Ascent Format) subroutine to flag the string buffer with an intermediate language (reference Figure RDA-1). A test is made to determine if the Ascent instruction had a constant or tag in the address field, or a literal in the instruction field. If the latter condition exists, control is transferred to type 1 processing described above. If the former condition exists, a call to PTC (Process Tag and Constant) will convert these fields before calling the FIN routine. If neither of the above conditions exist, then a direct transfer to FIN (Form Instruction) routine which interprets the string buffer and generates the 15 or 30 bit instruction. These routines also store the binary word. Then the buffer is written and the next record read, checked for an end of file, and control returns to the Run main loop.

Type 3 processing is merely a table look-up resulting in an unconditional transfer to an open routine which generally returns to the common return area of the type 1 processing (reference MAA-5). These open routines are ACE (Process Ascent EQU), ACH (Process Ascent BCD and DPC), and ACR, ACK (Process Ascent CON). A transfer to this section without a find results in an error exit.

The processing of type 4 instructions checks the relative position of the declarative or FORTRAN statement. These instructions must appear at the beginning of the program. If a FORTRAN statement is detected,

BLOCK RESERVATION PROCESSING

EXAMPLE : BLKI (100)

- CHECK THE FORMAT
- CONVERT THE CONSTANT
- INCREMENT THE RUNNING RELATIVE ADDRESS
- CHECK THE TOTAL FIELD LENGTH
- INITIALIZE THE STORAGE AREA
- CONVERT TO DISPLAY CODE
- OUTPUT TO BUFFER
- INPUT THE NEXT RECORD AND RETURN FOR PROCESSING

CONSTANT SECTION PROCESSING

EXAMPLE : CONI 15.64E03

- NORMALIZE STATEMENT
- CONVERT THE CONSTANT
- STORE CONSTANT INTO OUTPUT BUFFER
- INDICATE FULL WORD INSTRUCTION
- CONVERT TO DISPLAY CODE
- TRANSFER TO OUTPUT BUFFER
- READ THE NEXT RECORD
- IF NOT AN END OF FILE, RETURN FOR PROCESSING

Figure MAA-3

MAA-4

CONSTANT HEADER CARD PROCESSING

FORMAT - COLUMN 7-8 ..

- CHECK FOR THE FIRST HEADER CARD
- SET CONSTANT SECTION FLAG
- WRITE BLANKS INTO THE OUTPUT BUFFER
- READ THE NEXT RECORD
- IF NOT AN END OF FILE, RETURN FOR PROCESSING

Additive Field) subroutine. This routine flags the string buffer with an intermediate language identical to RDA's processing of Ascent instructions (reference Figure RDA-1). If a tag or constant has not been processed, the PTC (Process Tag and Constant) subroutine is called, then FIN (Form Instruction) is called and the processing is continued as in type 2. (reference MAA-6). The common return section indicates a full word has been processed, calls CDC (Convert to Display Code) for the output listing, writes the record into the buffer area, reads the next record, checks for an illegal end of file, then returns for processing this record. The return calls AFS (Assemble FORTRAN Statement) and if an * is found, the next record is read and checked; if not, MAA is re-entered from the Run main loop.

The processing of type 2 Ascent mnemonics also calls the PST (Process Location Tag) subroutine then calls the RDA (Reduce Ascent Format) subroutine to flag the string buffer with an intermediate language (reference Figure RDA-1). A test is made to determine if the Ascent instruction has a constant or tag in the address field, or a literal in the instruction field. If the latter condition exists, control is transferred to type 1 constant processing described above. If the former condition exists, a call to PTC (Process Tag and Constant) will convert these fields before calling the FIN routine. If neither of the above conditions exist, then a direct transfer to FIN (Form Instruction) routine which interprets the string buffer and generates either a 15-bit or 30-bit instruction. The routines called by FIN store the binary word. Then the buffer is written and the next record is read, checked for an end of file which is illegal at this point and then transferred to the main loop of Run.

Type 3 processing is merely a table look-up resulting in an unconditional transfer to an open routine which generally returns to the common return area of the type 1 processing (reference MAA-5). These open routines are ACE (Process Ascent EQU), ACH (Process Ascent BCD and DPC), ACR (Process BSS and BSSZ), ACK (Process Ascent CON). A transfer to this section without a find results in an error exit.

The processing of type 4 instructions checks the relative position within the program of the declarative or FORTRAN statement. These instructions must appear at the beginning of the program. If a FORTRAN statement is detected,

PSUEDO OPERATION PROCESSING

EXAMPLE: TAGA BSS 5
BSSZ 7
CON 6.3

EXAMPLE: TAGE EQU 777

Figure MAA-5

1. MOVE OPCODE TO COLUMN 7 OF THE STRING
2. END STRING AT FIRST BLANK
3. IF BSS/BSSZ: STORE A RIGHT PARENTHESIS IN THE STRING
4. GO TO TYPE I PROCESSING

1. PROCESS LOCATION TAG
2. INSERT EQUAL SIGN
3. GO TO TYPE IV (ABS) PROCESSING

EXAMPLE: TAGD BCD $n A_0 A_1 \dots A_n$ $n \leq 10$
TAGF DPC $*A_0 \dots A_9*$

1. PROCESS LOCATION TAG
2. ACCUMULATE TEN CHARACTERS
3. NORMAL EXIT IF IN CONSTANT SECTION
4. ERROR EXIT IF NOT IN CONSTANT SECTION
5. GO TO TYPE I PROCESSING

MACHINE INSTRUCTION PROCESSING

EXAMPLE: $T = (C + TAG)$

- PROCESS ADDITIVE FIELD
- PROCESS TAG OR CONSTANT, IF ANY
- FORM INSTRUCTION
- WRITE CODED RECORD
- READ NEXT RECORD
- IF NOT AN END OF FILE, RETURN FOR PROCESSING

Figure MAA-6

PROGRAM ORDER

- HEADER CARD
- FORTRAN CARDS, IF ANY
- DECLARATION CARDS, IF MACHINE HEADER CARD
- INSTRUCTION CARDS
- CONSTANT HEADER CARD
- CONSTANT CARDS
- END CARD

ASCENT MNEMONIC PROCESSING

EXAMPLE: $SX1 = X2 + TAG$

1. PROCESS TAG IN THE LOCATION FIELD
2. REDUCE THE ASCENT CODE
3. FORM THE 30-BIT or 15-BIT INSTRUCTION
4. OUTPUT DISPLAY CODE TO BUFFER
5. RETURN FOR THE NEXT RECORD

then a transfer back to the RUN compiler is initiated to complete the processing. If a declarative is encountered, then a table look-up and jumps similar to type 3 processing occurs. These routines return to an unconditional transfer to the Run compiler. The routines involved in the six declarative processing are CON, COM, ABS, HOL, RES, and SUB.

The common error exit for the MAA subroutine sets the buffer to a string of * and sets several flags. The next record is read and checked for an END card or a second END card which is processed by ENO; a single END card is processed by MND, and all other cards return to the Run compiler and AFS then returns to MAA.

Subroutines Called: Reference Figure MAA-7

Temporaries/Flags:

- ADM - Running Relative Address
- ICE - Dollar Sign Pointer (set)
- INJ - Continue Indicator (set)
- ICT - Intraword Instruction Counter (set)
- FLH - Subprogram Error Flag (set)
- FLF - Job Error Flag (set)
- PNM - Program/Subprogram Name
- IWC - Number of Instruction Words (set)
- ZAA - Relative Start of Current Program or Subroutine

Tables Referenced:

- MTB - Table of Tag-defining Operation Codes
- MTA - Table of Ascent Pseudo Operations
- TBJ - Argument Tag Table

Entry/Exit Register Conditions: N/A

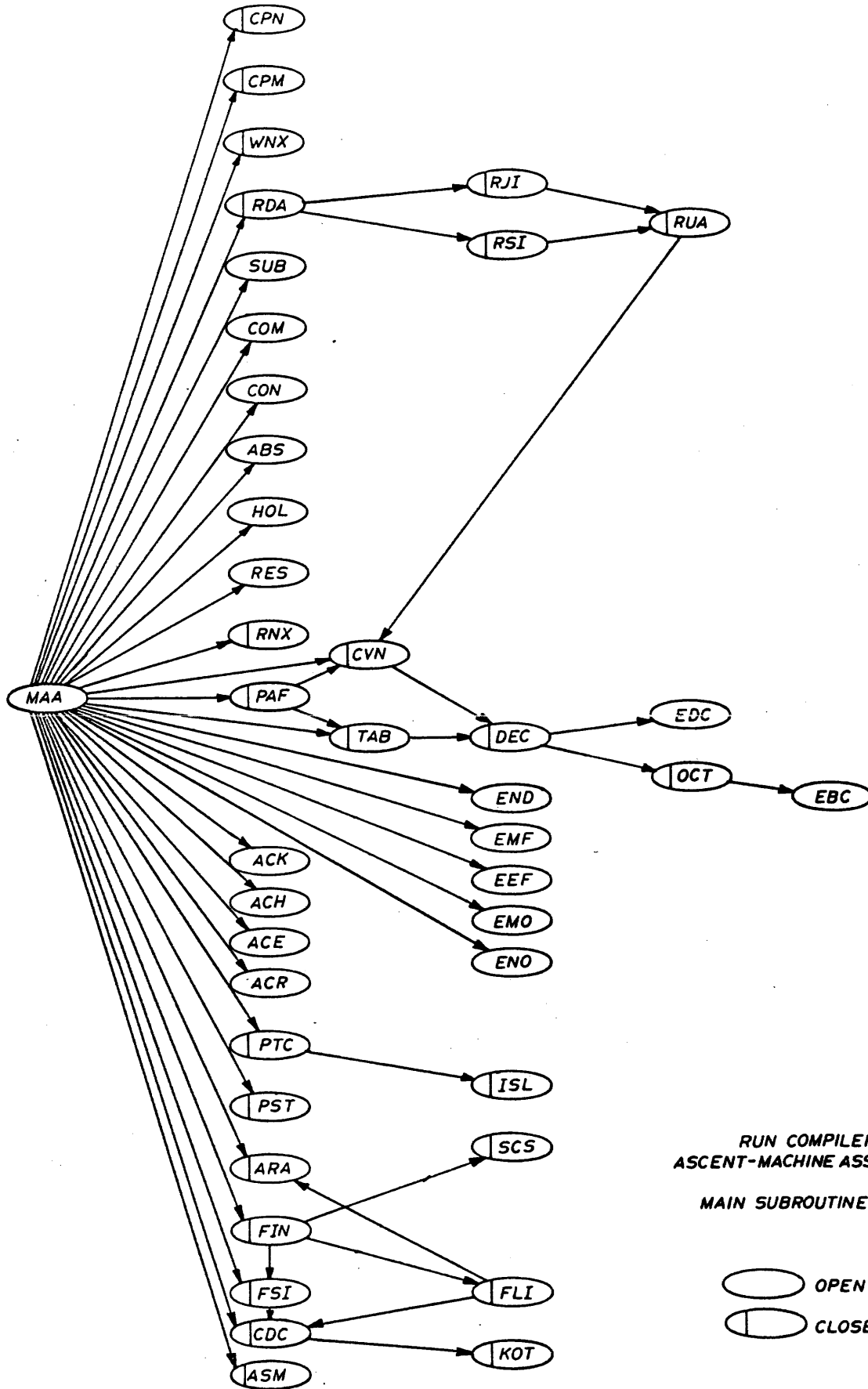

RUN COMPILER
 ASCENT-MACHINE ASSEMBLY
 MAIN SUBROUTINE CALLS

○ OPEN
 ◐ CLOSED

MCA - MAKE RELATIVE COMMON ASSIGNMENTS FOR FORTRAN IV

This routine is called during the processing of the END card to make the common assignments. Upon entry, CTY (Common Block Type Indicator) is set to zero if blank common is to be processed, and set to one if labeled common is to be processed. After blank common is processed, the routine processes numbered common and then exits. The PCA routine (Process Common Assignments) calls this routine to make numbered and blank common assignments while the PUA (Process Unique Assignments) routine calls this routine to process labeled common. In the processing of common, the Common Name Table is searched until a non-eliminated block name is found. If the block has not yet been declared in a previous program or subroutine, the current common block relative address (in the case of blank common) or the base address of the variables (in the case of labeled common) is entered, along with the block name or number, into the Common Block Name Table. If the block was declared, its starting address is extracted from the Common Block Name Table. Each succeeding variable tag is examined and assigned memory location(s) until another block name is found or until the end of the table is detected. Each variable whose tag is not an address tag is entered into the J Table along with its relative address. If the variable has an address tag, it is not entered into Table J. The Primary Name Table is then searched to see if any variables were declared equivalent to this one. If there are some, these entries in the Primary Name Table and Secondary Name Table are cleared. If the secondary tag is in the Variable Tag Table, the tag and address are entered into the J Table. Whether or not the tag is in the Variable Name Table, the block length is extended if the equivalences make it necessary.

When all variables belonging to the block are processed, the limit address of the block is entered into the Common Block Name Table unless the block was previously defined. If it was previously defined, the limit address is compared to the previous limit address to make sure this address is not greater. If it is a diagnostic is given. The routine then exits.

Subroutines Called: ADF - Advance Table
SCT - Scan Table

Temporaries/Flags: BAV - Base Address of Variables
CBA - Current Common Block Relative Address
CTY - Common Block Type Indicator
TBJ -
TBO - Table Parameters
TBP -
TBV -
TMC - Free Temporary
TMP - Current Extended Common Block Length
TMQ - Current Common Block Name
TMR - Base Address for Equivalence Group

Tables Referenced: Argument Name (J)
Common Name (O)
Array Tag (P)
Common Block Name and Address (V)

Entry/Exit Register Conditions: None

MTU - MOVE TABLES UP

This routine is responsible for relocating the 26 temporary tables and adjusting the TBN parameters to reflect this change. It is called prior to processing of library subroutines and usually overlays the input buffer to make more room available for the loading of library subroutines.

Subroutines Called: None

Temporaries/Flags: None

Tables Referenced: Argument Name (I)
(Referenced because it is the first table)
Program File Name (W)
(Referenced because it is the last table)

Entry/Exit Register Conditions:

Entry: B1 - how much the tables should be moved

Exit: None

PAF - PROCESS ADDITIVE FIELD

When the MAA (Process Ascent and Machine Records) subroutine encounters a Machine instruction, PAF is called to examine this instruction. This routine collects the terms, stores the register values in constants III, JJJ, and KKK, then converts the register notation to the notation used by RDA for the Ascent instructions (reference Figure RDA-1). The string buffer is flagged identically to the way RDA flags it so that FIN (Form Instruction) can be called to further process these Machine instructions. PAF uses the RCD Table look-up to convert the letters to the conventional A, B, and X registers. Error exits are taken if too many terms or a blank within the address field occurred.

Subroutines Called: TAB - Normalize Statements
 CVN - Convert Number
 ADF - Advance Tables
 ASN - Assemble Number
 ASV - Assemble Variable

Temporaries/Flags: III - i Portion of Machine Word
 TKG - Constant Tag
 JJJ - j Portion of Machine Word
 KKK - k Portion of Machine Word

Tables Referenced: RCD - Table of Operational-Register Codes
 TBA - Constant Value Table
 TBB - Constant Tag

Entry/Exit Register Conditions:

B6 - non-zero if a tag or constant has not been processed

PAT - PROCESS ADDITIVE ADDRESS

When the MND (Process Machine or Ascent End) subroutine encounters a tag plus a constant in the address field, the PAT Subroutine is called. The Variable Tag (V-tag) is in the upper 18 bits of the Argument Tag Table (Table J) and the Constant tag is in the lower 18 bits. These tags are merged together so that upon exit the X6 register contains the address of the location of the V-tag plus the constant.

Subroutines Called: SCM - Scan With Masking

Temporaries/Flags: BAK - Base Address for Constants

Tables Referenced: TBJ - Argument Tag

Entry/Exit Register Conditions:

X6 - Combined tag

PBR - PROCESS BUILT-IN-FUNCTION REFERENCE

PBR is entered when a built-in function has been detected. It merely routes the processing to one of the other routines depending upon the number of arguments the built-in function has and whether or not it is a logical function.

Subroutines Called: CMA - Compile Multiple Argument Function
COA - Compile One Argument Function
CTA - Compile Two Argument Functions
KMA - Compile Multiple Double Argument Functions
KSF - Compile Special Logical Function

Temporaries/Flags: FIV - Start of the last of library functions

Tables Referenced: None

Entry/Exit Register Conditions:

Entry: B4 - address of string entry of function

Exit: None

PCA - PROCESS COMMON VARIABLE ASSIGNMENTS

This routine is called during the processing of an END card after the instructions have been packed and the constants moved into the program area. If any variables were declared common, the equivalence tables are searched to process variables which were declared equivalent to a variable in common. If the mode is FORTRAN IV, the secondary name is removed from the common table and replaced by the primary name. If the mode is FORTRAN II the secondary name is replaced by the primary name and all equal primary names in the Primary Name Table are changed to the secondary name.

After the equivalence tables have been processed, the relative common assignments are made by calling either the FORTRAN II routine (MKA) or the FORTRAN IV routine (MCA). The FORTRAN IV routine will first make blank common and then numbered common block assignments. When the memory assignment has been made the variable tags and starting address will be entered into the J Table by MKA or MCA. This routine will then set bit 16 of the address to flag them relocatable to the start of common.

Subroutines Called: ADF - Advance Tables
 MCA - Make FORTRAN IV Relative Assignments
 CKA - Make FORTRAN II Relative Assignments
 SCT - Scan Table

Temporaries/Flags: CBA - Current Common Block Relative Address
 CSA - Common Starting Address
 FLC - Program Common Field Length
 IPS - Program/Subprogram Indicator
 LBA - Latest Buffer Address
 MOD - Subprogram Mode
 MOE - Program Mode
 TBJ - }
 TBO - } Table Parameters
 TBV - }

TBX - }
TBY - } Table Parameters
TBZ - }

Tables Referenced: Argument Name Table (J)
 Common Name Table (O)
 Common Block Name and Address (V)
 Equivalence Secondary Name (X)
 Equivalence Primary Name (Y)
 Equivalence Bias (Z)

Entry/Exit Register Conditions: None

PCT - PROCESS SPECIAL ARRAY TAGS

PCT is entered during the processing of the END statement to process any temporary array tags in the Temporary Tag Table. For each array tag in this table, Table J is searched to find the starting address of the array. The array address increment is added to the starting address of the array, incorporated with the corresponding permanent tag in Table C and then entered into the J Table.

This type of entry is made when calculating array addresses such as $A(I+10)=$.

Subroutines Called: ADF - Advance Tables
SCM - Scan With Masking

Temporaries/Flags: TBC - Table Parameters
TBD -

Tables Referenced: Temporary Tag (C)
Permanent Tag (D)

Entry/Exit Register Conditions: None

PFR - PROCESS STATEMENT FUNCTION REFERENCE

PFR compiles instructions to transfer arguments to an arithmetic statement function and a return jump to the function. Two methods are employed in the passing of arguments. If the function does not reference any subroutines, the actual argument itself rather than the address is transferred to the space reserved for it at the start of the function. If the function does reference subroutines, the number of arguments is saved, the addresses of the first N arguments are transferred via index registers and the value of the remaining arguments are transferred to the reserved space. N will equal five minus the number of arguments and the first index used will be the number of arguments plus one. For example, if the function had four arguments, the address of the first two would be passed in B5 and B6 while the values of the last two would be transferred to the corresponding cells at the beginning of the function.

Subroutines Called: ADF - Advance Tables
 CIR - Compile Re
 CLA - Clear Index and Address and Input Tags
 CXP - Compile Expression
 GAT - Compile Argument Address Pick
 SAD - Sense and Process Single Array Address
 SCT - Scan Table

Temporaries/Flags: ARG - Argument Count
 IGX - Index Assignment
 TBA - Constant Name Table Parameters
 TBB - Constant Tag Table Parameters
 TGK - Constant Tag Table Parameters
 TGL - Argument Count for Call
 TMM - Name Tag For Call
 TMN - Argument Tag for Call
 VTY - X6 Register Associate

Tables Referenced: Constant Name (A)
 Constant Tag (B)

PGP - PROCESS SUBPROGRAM PARAMETERS

If the compilation mode is incomplete, the first part of the program is changed to the following format, with the needed information extracted from the table entries for each subroutine. The format of the first N+2 words where N is the number of parameters is as follows:

Name	42	total length	18
buffer start	18	addr. of first inst.	18
base addr. of temps.	18	base addr. of temps.	18
no. of arguments	6		

base addr. of constant	18	base addr. of indirect	18	addr. of local var.	18	mode	6
------------------------	----	------------------------	----	---------------------	----	------	---

If the compilation mode is not incomplete, the name of the routine and the total length are entered into the first program location, the instruction word count entered into the Subroutine Parameters Table and also the total length. The start of the new short file is set and the unused space indicator is updated if need be.

Subroutines Called: SCT - Scan Table

Temporaries/Flags: BAI - Base Address for Indirects
 BAK - Base Address for Constants
 BAT - Base Address for Temporaries
 FST - Long File Start
 ICB - Argument Count
 ICM - Incomplete Compile Mode Indicator
 ICO - Base Address for Variables
 INT - First Instruction Address
 INV - Unused Compiler Space
 IWC - Number of Instruction Words
 MOD - Subprogram Mode
 PNM - Program/Subprogram Name
 TBI -

TBI -

TBJ - Table Parameters

TBS -

ZAA - Relative Start of Current Program or
Subroutine

ZAB - Short File Start

Tables Referenced:

Argument Name	(I)
Argument Tag	(J)
Subroutine Name	(S)
Subroutine Parameters	(U)

FIG - PRINT INSTRUCTION GROUP

This routine is called during the processing of the statement number and during the processing of the END card. It is responsible for listing all object code compiled for the last statement along with the current running address. The listing will correspond exactly to the actual program that is loaded into core for execution except that the K portions of the 30 bit instructions will necessarily contain tags rather than absolute addresses as the assignment of variables and temporary cells is not made until the subprogram is completely compiled.

If no object listing is required, this routine merely calls PJG to process the group ending address and then exits.

Otherwise, the instructions are examined one at a time. The current running address is updated and listed when it is detected that the examined instruction will not fit into the word that is presently being processed. The method of forcing instructions to start a new word is exactly the same that is used when the instructions are packed during the processing of the END statement. The 15 bit instructions are converted to display code and listed. If the K portion of the 30 bit instruction is a tag, the first two numbers of the tag, which describe which type of tag it is, are replaced by a letter and then the instruction is converted to display code and listed. If there is an address tag associated with the instruction, it is also listed. After all instructions have been examined, the execution address of the next instruction group is saved, a line of blanks is written and the routine exits.

Subroutines Called: KOT - Convert Binary Tag to Mnemonic Tag
 PJG - Process Group Ending Address
 WNX - Write Coded Record

Temporaries/Flags: ADM - Running Relative Address
 ICT - Intraword Instruction Counter
 IGE - Instruction Group End
 IGS - Instruction Group End
 INU - Unused Compiler Space

Tables Referenced: TBC - Temporary Tag Table
TBD - Permanent Tag Table
TBI - Argument Name Table

Entry/Exit Register Conditions: None

PKI - PACK INSTRUCTIONS

In processing the END statement, the instructions are packed. PKI is called after the temporary tags have been replaced with permanent tags, but before the variable tags are replaced by addresses. The 15 and 30 bit instructions are shifted into consecutive words with the unused portions filled with pass (46000) instructions. An instruction with an operation code of 01, 02, or 04 does not allow any more instructions packed into the word with the exception that an 07 instruction following an 01 may occupy the lower bits of the word. All tagged instructions (location tags) are saved along with their corresponding addresses in the J Table. These addresses are relocatable to the beginning of the program or subprogram if, in this case, the subroutines are being compiled separately. Bit 17 is set to indicate that the address is relocatable from the beginning of the subroutine.

When the end of the instructions is found, the number of words of instructions is saved.

Subroutines Called: ADF - Advance Tables

Temporaries/Flags: ICM - Incomplete Compile Mode Indicator
IGE - Instruction Group End
IPS - Program-Subprogram Indicator
INC - Number of Instruction Words
ZAA - Relative Start of Current Program or Subprogram
ZAB - Short File Start

Tables Referenced: Argument Tag Table (Table J)
(not used as such at this time)

Entry/Exit Register Conditions: None Used

PLR - POSITION LIBRARY SUBROUTINES AND EQUATE TAGS WITH ADDRESSES

This routine is responsible for reading in binary decks that appear in the input file, making a call to CLL (PP routine) to bring in any subroutines that have not yet been defined, and then to relocate the flagged addresses within these routines to absolute memory addresses.

The routine is called after it has been detected that all source input has been compiled. It first calls MTU to move the 26 temporary tables up over the string and over the input file buffer if no binary decks appear in the file in order to make more room to load in library subroutines. BRX is called to read in the binary routines appearing in the input file if any. CLL is called to read in the routines that have not yet been defined, and the compiler enters RECALL until CLL has terminated. Each routine is then checked to make sure that it was not called with more parameters than the routine just read in was assembled to handle. Each subroutine is examined one word at a time and all addresses that were flagged as program relocatable are relocated as are all locations that were flagged common relocatable. The Subroutine Tag Table is then searched and all tags along with the address of their entry/exit line are entered into the J Table. Each argument is given a tag and address in the J Table also.

Subroutines Called: ADF - Advance Table
BRX - Read Binary Subroutines
CKL - Check Missing Subroutines
MTU - Name Tables Up
SCT - Scan Table
WNX - Write Coded Record

Temporaries/Flags: CAS - Word of Blank Display Codes
CSA - Common Starting Address
ICM - Incomplete Compile Mode Indicator
TBI -
TBS - Table Parameters
TBT -
TBU -

ZAA - Relative Start of Current Program or
Subprogram

ZAB - Short File Start

Tables Referenced:

Argument Name	(I)
Subroutine Name	(S)
Subroutine Tag	(T)
Subroutine Parameters	(U)

Entry/Exit Register Conditions: None

PPG - PROCESS NAME AND ARGUMENTS

Upon encountering a header card, PROGRAM, SEGMENT, SUBROUTINE, FUNCTION, or BLOCKDATA, PPG is called to compile initialization instructions. Whether or not the routine being compiled is Fortran, the arguments are counted, the name is saved, and the relative start of the routine is saved. Inconsistencies in the calling of a subprogram with more arguments than specified or declaring a function a different type than a previous call are checked in this routine.

In the case of a Fortran program card entry, the name of the program is saved. Each I/O file declared has a word reserved for it beginning at RA+2. The first two words, RA and RA+1, are system communication words and are given location tags. For every file designated an I/O buffer is reserved except for equivalenced files. The file appearing on right side of the equals for equivalencing must have already been defined because the file being equated to it must share the buffer. Also a buffer may be given an individual length which would appear on the right side of an equals sign. Each file is given a beginning address which will point to the parameter list of its own buffer or its equivalenced file buffer. This beginning address along with the file name is entered into the file name table (W). A buffer length of 2010_8 is assigned to each file if no length was specified on the "RUN" card or the file was not equated to a number. Either of these specified lengths must be greater than 1001_8 or that amount of space is saved anyway. Eight buffer parameters are saved for each buffer. These are used by CIO¹ (circular input/output). The first of these parameters contains the name of the file (in left adjusted display code) onto which the transfer of data is to be made. This name will always correspond to the file on which reading or writing is to be done for this execution. The names may be changed on the program call card, used to call a compiled program for another execution, to transfer the data to a file different than the one named in the compilation.

A word is saved in the constant value table for use during initialization. When a record has been compiled, the END processor fills this word with the field length, the beginning address of blank or numbered common (or the beginning address of the buffers is no common has been defined) and the

1. Chippewa Operating System, Internal Reference, E012, November 1965.

local length of the program. Instructions are generated to initialize,

B1 - local length

B2 - beginning address of common or buffers

B3 = compiled field length

X2 - requested field length

The field length requested for this execution of the program may not be less than the compiled field length or an error exit is taken. The area reserved for common and the buffers is cleared to zero and the unused program space (area between the local length and common) is set to indefinites.

When a program is ready for execution, the names of the files requested appear in RA+2 through RA+n+2. The names may change from one execution to another so the originally compiled file name along with the beginning address of its buffer is saved in a tagged location. The name from RA+2 is transferred to the first word of the buffer parameters and the compiled file name replaces it at RA+2. Whenever an I/O request is made on an original file, the information will be transferred to the corresponding file named on the program call card. For example: If a program was compiled with the data entering it via INPUT, the program card would look like PROGRAM BIG (INPUT). All read requests would be compiled to take the data from the input file. If the compiled program is called for execution again and the data is to be read from an input tape, the call could be BIG(TAPE5). The name, TAPE5, would be set in RA+2, but the program initialization instructions would transfer the name to the buffer parameter list and set the name INPUT and the beginning address pointing to TAPE5 in RA+2. Whenever CIO is called to make a transfer, the file name in the parameter list identifies the file. The remaining I/O parameters are initialized. The line limit which is the seventh argument on the RUN card is transferred to the eighth word of the parameter list. This limit applies to the number of lines of listable output and is set to 20000₈ if no special allotment is made. Instructions to set up the buffer parameters in this way are repeated for each file designated.

The SEGMENT card processing saves two words for system communication before the reserved words for the arguments. Each file name along with a beginning address for the buffer is entered into the file name table (W). Changing the file names on the SEGMENT card will have the same effect as calling a

FL

033770

031760

027750

RA+6
RA+5
RA+4
RA+3
RA+2
RA+1
RA

INPUT BS
OUTPUT BS
TAPE25 BS
first executable instruction
0-----0
TAPE25 027750
OUTPUT 031760
INPUT 033770

INPUT BS
OUTPUT BS
TAPE25 BS
0-----0
TAPE25 027750
TAPE6
TAPE5

TAPE5 BS
TAPE6 BS
TAPE25 BS
0-----0
TAPE25 027750
OUTPUT 031760
INPUT 033770

Program - compiled and executed with header card:
PROGRAM A (INPUT,OUTPUT,TAPE25)

Program loaded with program call card:
A (TAPE5,TAPE6)

Program executed after being loaded with program call card:
A (TAPE5,TAPE6)

FILE BUFFER ASSIGNMENTS

program with different file names as was previously described. No buffer space is relinquished from segment to segment. All of the files used by the program and the segments must be declared on the PROGRAM card. An entry/exit word is reserved with a 200001 tag after all the arguments have been processed. Instructions are generated to set the index registers B1-B3 to the same values as the PROGRAM initialization. No memory is cleared or set to indefinites and the I/O buffers are not initialized.

Two system communication words are reserved when a Fortran SUBROUTINE card is encountered. One word for each argument is also saved and each argument is given a location tag (A). An argument list error is generated whenever a variable is used more than once for an argument. The entry/exit word is given a 200001 tag (first location tag). An entry is made into the subroutine name table (S), subroutine tag table (T) and subroutine parameter table (U) if the name has not already been entered. The relative start of the subroutine along with the number of arguments are set in the subroutine parameter entry. If the name appears in the subroutine name table, that is the subroutine that has previously been called, then the number of arguments used by the call must be equal to or less than the number of arguments being compiled or an argument count diagnostic results. Instructions are generated to pack the addresses of the arguments passed to the subroutine in index registers into ten temporary tagged words. B1-B3 are set into the first word and B4-B6 into the second.

The only difference between processing a FUNCTION card and a SUBROUTINE card is that the mode of the function must be checked. If the compiled type is different from the called type, a function type error results. The function name is entered into the variable name table and it is given a V-type tag. This tag along with the mode is entered into the variable tag table. An entry of the same type is made into the subroutine name table except a L-tag is inserted in the subroutine tag table. Since there is no difference in compiling a subroutine or a function, the RETURN statement processor checks the name of the routine for an entry in the variable name table. If this entry is formed, then the subprogram must be a function and the answer will be set into X6.

A BLOCKDATA statement causes three system communication words to be reserved and tagged. The name BLKDAT is entered into the subroutine name table and given an L-type tag. No other processing of this statement is done.

The arguments defined on an ascent or machine subprogram header card are entered into the variable name table but no word is reserved for it. The name is entered into the subroutine name table and the number of arguments are checked. No special initialization instructions are generated. Table entries are made so that subroutine linkage between the Fortran program and the coded routine can be made.

SUBROUTINES CALLED:	ADF	Advance Tables
	ALX	Get Register Assignment
	KON	Convert Octal Argument
	SCM	Scan Tables with Mask
	SCT	Scan Table
	TAB	Normalize Statement
	TRV	Translate Variable
TEMPORARIES/FLAGS	ARG	Argument Count
	CAS	Space Codes
	FTY	Function Type
	ICB	Argument Count
	ICK	Block-Data indicator
	ICY	Line Limit
	INQ	Name for Dayfile
	INT	First Instruction Address
	INV	Segment Indicator
	INW	Chain-mode Indicator
	IPS	Program Indicator
	JPS	Current Subprogram
	LBA	Latest Indicator Buffer Address
	PNM	Program/Subprogram name
	STG	Compile mode Indicator
	TJP	Subprogram Type
TABLES REFERENCES:	Constant Name (A)	
	Constant Tag (B)	
	Variable Name (M)	
	Variable Tag (N)	
	Subroutine Name (S)	
	Subroutine Tag (T)	

Subroutine Parameter (U)

File name (W)

PRR - PROCESS FUNCTION/SUBPROGRAM REFERENCE

When a FUNCTION or SUBROUTINE is called, PRR handles the passing of the arguments between the calling program and the subprogram. All arithmetic expressions have been stripped of their outermost parenthesis so that a somewhat simplified expression is evaluated in PRR. Each argument except constants have been replaced with appropriate tags. Further processing is required for a subscripted variable or an arithmetic expression.

Any argument that is not followed by either a comma or a right parenthesis must be a subscripted variable or an arithmetic expression. SAD (Sense and Process Single Array Address) makes the decision as to which it is. An array will have as its second character a left parenthesis and also a comma-right parenthesis or two right parentheses sequence following it. CSR (Compile Array Address) gets the address of the word within the array and returns it to SAD. The variable and its subscript are replaced with a new tag in the string buffer. If SAD did not locate a subscripted variable, then a zero in B6 is returned to PRR. CXP (Compile Expression) will evaluate the expression with the result in X6. Upon return to PRR, the result is stored in a temporary tagged location.

If the argument in the string has a mode indicator of 3 in the lower six bits, then the argument is a constant whose value is less than $2^{16}-1$. This value is entered into the Constant Value Table (A) and is given a constant tag. A simple variable argument remains in the string buffer with no operations being performed on it.

All of the arguments in the call have now been processed, so the next step is to generate instructions to pass them to the subprogram. Any argument in the call that was passed to the routine as an argument has a location tag. Therefore, the address in the location tag must be used as the address of the argument. In this case, GAT (Compile Argument Address Pick) retrieves the address from the location tag and returns it to PRR. The addresses of the first six arguments are set into B1-B6. When the index registers are exhausted, the addresses of the remaining

arguments are stored in the reserved word of the subprogram via external tags. Instructions are generated to set the tag in X6 or X7 and then it is stored by an external tag (400000). This tag will be linked with the word reserved in the subprogram for the argument.

When the arguments have been set in either index registers or external tags, then a return jump will pass control to the subprogram. A call to DUMP/PDUMP also causes the number of arguments to be set in B7 and the program total field length to be sent in X0. If the subroutine being called was used as an argument to this routine, then it will not be entered by a return jump. Into the entry/exit line of the subprogram is stored a jump back to the calling routine and the subprogram is entered by a jump to the word after the entry/exit line.

A subprogram which is being called but was not used as an argument is entered with a return jump. The return jump instruction will be forced upper and the lower 18 bits will contain the number of arguments in the call and a location tag pointing to the name of the calling routine.

Example: 0100 S00600

0715 L00002

where S00600 is the location of the entry/exit word of the subroutine

15 is the number of arguments

L00002 is the location of the name of the subroutine

No more than 60 parameters may be passed to a subroutine. If the number of arguments in this call to the subprogram is greater than the number of any previous call, then the new number is saved in the argument count byte of the Subroutine Parameter Table.

CRI (Compile Restore Instructions) is called if the subprogram being referenced had been previously used as an argument. The location to which control is returned by this called subprogram is given a location tag. This tag will be the same one that was stored in the entry/exit line of the called subprogram.

PRR is called by CLL (Process Call Statement) and CRF (Compile Function

Reference)'.

Subroutines Called: ADF - Advance Table
 ALX - Get Long Register Assignment
 CLA - Clear Tables I and J
 CRI - Compile Restore Instruction
 CXP - Compile Expression
 GAT - Compile Argument Address Pick
 SAD - Process Single Array Address
 SCT - Scan Table

Temporaries/Flags: ARF - Argument Reference Count
 FLT - Program Total Field Length
 FSR - Function Statement Reference Count
 IGX - Current Index Register
 INF - DUMP/PDUMP Indicator
 SRI - Subroutine Reference Count
 TML - Argument Count
 TMM - Subprogram Name
 TMN - Subprogram Tag

Tables Referenced: Constant Value (A)
 Constant Tag (B)
 Subroutine Name (S)
 Subroutine Parameter (U)

PSC - POSITION CONSTANTS

PSC is called to position the constants into the program after the instructions have been packed. It first sets the base address for the constants (BAK) to the short file start (ZAA) + the number of instruction words (IWC). It then sets the base address for the temporaries (BAT) to the constants base address plus the number of constants. If there is room for the constants, the base address for indirects is set to the base address of temporaries plus the number of temporaries and the base address for variables (BAV, ICO) is set to the base address for indirects plus the number of indirects.

The constants are then transferred to the program area and the program is set up as follows:

PROGRAM (PACKED INSTRUCTIONS)	CONSTANT SECTION	INDIRECT SECTION	TEMPORARY SECTION	VARIABLE SECTION . . .
	BAK	BAI	BAT	BAV

Subroutines Called: None

Temporaries/Flags:

- BAK - Base Address for Constants
- BAI - Base Address for Indirects
- BAT - Base Address for Temporaries
- BAV - Base Address for Variables
- FST - File Start
- ICO - Base Address for Variables
- IWC - Instruction Word Count
- TGI - Indirect Tag
- TGK - Constant Tag
- TGT - Temporary Tag
- ZAA - Short File Start

PST - PROCESS LOCATION TAG

The PST subroutine processes the location tag for all Ascent or Machine records. The Location Tag is assembled by the ASV (Assemble Variable) subroutine and if the tag is non-alphabetic, the only acceptable value is a plus sign. The PST Subroutine will also process the blank location field if parcel 3 of the current word is not full. The running address is set to blanks. When a plus sign has been detected, the running address is stored and incremented by one. The check for an alphabetic tag involves a search in the Argument Name Table (Table I) and a find in this table causes a search of the Argument Tag Table (Table J) to see if the variable has been doubly defined. If the variable was not in the Argument Name Table, it is stored there and a Statement Tag (H-tag) is generated and stored in the corresponding tag table. In generating the entry for the tag table, a check is made for common relocation and a bit is set if necessary. Once the location tag has been processed, the PST subroutine moves the machine operation field if the string buffer had blanks beginning in column 7 and tags as the end of the string at the first blank, thus the machine instructions must not have blanks in the address field.

Subroutines Called: ASV - Assemble Variable
 ARA - Adjust Running Address and Write Register
 SCM - Scan Tables With Masking
 ADF - Advance Tables

Temporaries/Flags: ICT - Intraword Counter
 ADM - Current Running Address
 IPS - Program Mode
 STG - Compile Mode
 TGH - Statement Tag (set)

Tables Referenced: TBI - Argument Name
 TBJ - Argument Tag

Entry/Exit Register Conditions: n/a

PSC - POSITION CONSTANTS

PSC is called to position the constants into the program after the instructions have been packed. It first sets the base address for the constants (BAK) to the short file start (ZAA) + the number of instruction words (IWC). It then sets the base address for the temporaries (BAT) to the constants base address plus the number of constants. If there is room for the constants, the base address for indirects is set to the base address of temporaries plus the number of temporaries and the base address for variables (BAV, ICO) is set to the base address for indirects plus the number of indirects.

The constants are then transferred to the program area and the program is set up as follows:

PROGRAM (PACKED INSTRUCTIONS)	CONSTANT SECTION	INDIRECT SECTION	TEMPORARY SECTION	VARIABLE SECTION . . .
	BAK	BAI	BAT	BAV

Subroutines Called: None

Temporaries/Flags:

- BAK - Base Address for Constants
- BAI - Base Address for Indirects
- BAT - Base Address for Temporaries
- BAV - Base Address for Variables
- FST - File Start
- ICO - Base Address for Variables
- IWC - Instruction Word Count
- TGI - Indirect Tag
- TGK - Constant Tag
- TGT - Temporary Tag
- ZAA - Short File Start

PST - PROCESS LOCATION TAG

The PST subroutine processes the location tag for all Ascent or Machine records. The Location Tag is assembled by the ASV (Assemble Variable) subroutine and if the tag is non-alphabetic, the only acceptable value is a plus sign. The PST Subroutine will also process the blank location field if parcel 3 of the current word is not full. The running address is set to blanks. When a plus sign has been detected, the running address is stored and incremented by one. The check for an alphabetic tag involves a search in the Argument Name Table (Table I) and a find in this table causes a search of the Argument Tag Table (Table J) to see if the variable has been doubly defined. If the variable was not in the Argument Name Table, it is stored there and a Statement Tag (H-tag) is generated and stored in the corresponding tag table. In generating the entry for the tag table, a check is made for common relocation and a bit is set if necessary. Once the location tag has been processed, the PST subroutine moves the machine operation field if the string buffer had blanks beginning in column 7 and tags as the end of the string at the first blank, thus the machine instructions must not have blanks in the address field.

Subroutines Called: ASV - Assemble Variable
 ARA - Adjust Running Address and Write Register
 SCM - Scan Tables With Masking
 ADF - Advance Tables

Temporaries/Flags: ICT - Intraword Counter
 ADM - Current Running Address
 IPS - Program Mode
 STG - Compile Mode
 TGH - Statement Tag (set)

Tables Referenced: TBI - Argument Name
 TBJ - Argument Tag

Entry/Exit Register Conditions: n/a

PTC - PROCESS TAG AND CONSTANT

The PTC subroutine processes tags and constants in the Ascent or Machine coded routines. Upon entry into the routine from MAA, X5 contains the tag and/or X4 contains the constant. If a tag does not exist and the constant is in the range of $-2^{16}-1$ to $2^{16}-1$, the number is left-justified and placed in the X5 register. If the constant is greater than $2^{16}-1$ and less than $2^{17}-1$, a Statement Tag (H-tag) is generated and the constant and tag are stored in the Argument Tag Table (Table J). Then the tag is returned in the X5 register.

If there is a tag in the X5 register upon entry, the Variable Name Table (Table M), Common Name Table (Table O), and the Equivalence Name Tables (Table X and Y) are scanned. Should the name not appear in any of the tables, a jump to ISL (Identify Symbolic Tag) for a tag is executed, and the tag is returned in the X5 register and the constant, if it exists, is processed as above, but is returned in the X4 register. If the variable is in the common or equivalence tables, the variable and a Variable Tag (V-tag) are stored in the Variable Name Table and the V-tag is returned in the X5 register. If the variable is already in the Variable Name Table (Table M) the previously stored tag is returned in the X5 register.

Subroutines Called: ADF - Advance Tables
ISL - Identify Symbolic Tag
SCT - Scan Table

Temporaries/Flags: IPS - Program Type
TGH - Statement Tag (set)
TGV - Variable Tag (set)

Tables Referenced:

- TBJ - Argument Tag
- TBN - Variable Tag
- TBM - Variable Name
- TBY - Equivalence Primary Name
- TBX - Equivalence Secondary Name
- TBO - Common Name

Entry/Exit Register Conditions:

Entry: X4 - constant or zero

X5 - tag or zero

Exit: if X5 = 0 on entry

X5 = constant $-2^{16-1} - 2^{16-1}, -0$
 = H-tag $2^{16-1} - 2^{17-1}$

if X5 \neq 0, X4 = 0

X5 = Variable Tag

if X5 \neq 0, X4 = 0

X5 = Variable Tag

X4 = constant

Statement Tag (H-tag)

PUA - PROCESS UNIQUE VARIABLE ASSIGNMENTS

After all blank and numbered common locations have been assigned, PUA is entered to make unique assignments. If the mode of compilation is FORTRAN IV, the MCA routine is called to make labeled common assignments. The equivalence tables are then examined and the PXG routine which processes equivalence groups is called for each primary name that has not yet been processed. After all equivalences have been handled, the Variable Name Table is searched to assign core locations for all variables that have not yet been assigned. The tag for the variable along with the starting address is entered into Table J. The length of the array or variable is added to the starting address in order to determine the starting address of the next array or variable. When all variables have been assigned, the starting address for the next one is set as the relative start of the next program and the routine exits.

Subroutines Called: ADF - Advance Tables
 MCA - Make FORTRAN IV Relative Assignments
 SCT - Scan Table

Temporaries/Flags: BAV - Base Address for Variables
 CTY - Common Block Type Indicator
 IPS - Program/Subprogram Indicator
 MOD - Subprogram Mode
 MOE - Program Mode
 TBN -
 TBP -
 TBX - Table Parameters
 TBY -
 TBZ -
 TMC - Free Temporary
 ZAA - Relative Start of Current Program or Subroutine

<u>Tables Referenced:</u>	Variable Tag	(N)
	Array Tag	(P)
	Equivalence Secondary Name	(X)
	Equivalence Primary Name	(Y)
	Equivalence Bias	(Z)

Entry/Exit Register Conditions: None

PXG - PROCESS EQUIVALENCE GROUP

PUA (Process Unique Variable Assignments) calls this routine to process one equivalence group at a time. The primary name for the equivalence is specified upon entry and any variables declared equivalent to this primary one are assigned memory locations.

The length of the primary array is determined and the tag along with the starting address is entered into the J Table. The equivalence tables are searched for a variable equivalenced to the specified primary one. When one is found, its starting address is determined by adding the corresponding entry in the Equivalence Bias Table to the base address of the primary variable. This address along with the secondary tag is entered into the J Table. When no more variables are found that are equivalenced to the specified primary entry, this routine exits.

Subroutines Called: ADF - Advance Table
SCT - Scan Table

Temporaries/Flags: TBJ -
TBM - Table Parameters
TBP -
TMR -

Tables Referenced: Argument Name (J)
Variable Name (M)
Array Tag (P)

Entry/Exit Register Conditions:

Entry: X4 - primary name to be processed
Exit: None

Tables Referenced: Argument Tag Table (TBJ)
(used for address only)

Entry/Exit Register Conditions: None are utilized

RAD - REPLACE TAGS WITH ADDRESSES

RAD is called twice for each program or subprogram that is compiled for the purpose of replacing the compiler generated tags with memory addresses. The first time it is called is during the processing of the END statement of each program/subprogram. At this time the base address of the constants, the temporaries, and the indirects has been determined. The assignment of all variables in the program has been made and the tags for the variables along with their assigned memory address has been entered into the J Table. RAD will examine the object code, one word at a time, and any K portion of a 30 bit instruction that is a tag will be replaced by a memory address and the instruction word is stored back into the object program. Since the address of subroutines is not known at this time, subroutine tags are ignored at this time. If the compilation mode is incomplete, the modified word is not stored back into the object program. If subroutines are being assembled separately to be executed at a later time, the memory addresses are flagged as program or common relocatable before being stored.

RAD is entered a second time after all compiler input has been processed, and the library routines have been loaded. At this time, all library tags along with their corresponding memory addresses have been entered into the J Table and RAD will again search the object code of the program and replace any subroutine tags with memory addresses. RAD will be entered once for each program/subprogram as it will process only one routine at a time. Thus, RAD will examine the object code generated by a program twice, once to replace variable tags, and once to replace subroutine tags with absolute or relocatable memory addresses.

Subroutines Called: RAX - Translate Tag (local routine to RAD entered via a return jump)

Temporaries/Flags: BAI - Base Address for Indirects
BAK - Base Address for Constants
BAT - Base Address for Temporaries

FST - Long File Start
ICM - Incomplete Compile Mode Indicator
INT - First Instruction Address
IPS - Program/Subprogram Indicator
IWC - Instruction Word Count
MSN - Missing Statement Indicator
MST - System Error Indicator
TBI - Table Parameters
ZAB - Short File Start

Tables Referenced: Argument Name (I)

Entry/Exit Register Conditions: None

RDA - REDUCE ASCENT INSTRUCTION

When the MAA (Process Machine and Ascent Records) subroutine encounters an Ascent mnemonic other than a pseudo-opcode, the RDA subroutine is called. RDA first determines if the instruction is a two letter mnemonic (i.e. opcodes 00-07 or 46) which are further processed in the RJI (Reduce Jump Instruction) subroutine or a three digit mnemonic, in which case the third digit is the resultant register. Here the resultant register is stored in the III constant. Then these instructions are further divided into the Set instructions (i.e. 50-77) which are further processed in the RSI (Reduce Set Instruction) subroutine and the X-register instructions which are processed in the main loop of RDA. In further processing these instructions, RDA generates an intermediate language in the string buffer for the Ascent Source Card. This language is shown in detail in Figure RDA-1. Before transferring control to RJI for two digit processing, RDA compares the instruction to a NO or PS, in which case the string is flagged by RDA. Both RSI and RJI flagged the string (See RSI and RJI write-up). In the processing of the address field RDA will also store the operation registers (j and k) into the JJJ and KKK constants. Before exiting RDA will flag the string buffer with three consecutive zeros and sets the B6 register to a 1) -1 if the instruction has a six bit constant or no address field; to a 2) 0 if the instruction has been completely formatted and to a 3) +1 if there is a constant or tag to be processed.

Subroutines Called: RSI - Reduce Set Instructions
RJI - Reduce Jump Instructions

Temporaries/Flags: III - i portion of Machine Instruction (set)
JJJ - j portion of Machine Instruction (set)
KKK - k portion of Machine Instruction (set)

Tables Referenced: None

SOURCE LANGUAGE		STRING ENTRIES GENERATED BY RDA								OPERATION CODE
<u>INSTRUCTION</u>		<u>Col. 7</u>	<u>Col. 8</u>	<u>Col. 9</u>	<u>Col. 10</u>	<u>Col. 11</u>	<u>Col. 12</u>	<u>Col. 13</u>	<u>Col. 14</u>	<u>GENERATED BY FIN</u>
RJ	K	R	=	G	0					01
JP	Bi + K	P	=	B	+	G				02
JP	K + Bi	P	=	G	+	B				02
JP	Bi	P	=	B	0					02
ZR	Xj + K	P	=	G	,	A	.	=	0	030
NZ	Xj + K	P	=	G	,	A	.	/	0	031
PL	Xj + K	P	=	G	,	A	.	(0	032
NG	Xj + K	P	=	G	,	A	.)	0	033
IR	Xj + K	P	=	G	,	A	.	I	0	034
OR	Xj + K	P	=	G	,	A	.	O	0	035
DF	Xj + K	P	=	G	,	A	.	D	0	036
ID	Xj + K	P	=	G	,	A	.	N	0	037
ZR	Bi K	P	=	G	0					04
EQ	Bi Bj K	P	=	G	,	B	=	B	0	04
NZ	Bi K	P	=	G	,	B	/	B		05
NE	Bi Bj K									
GE	Bi Bj K	P	=	G	,	B)	B		06
PL	Bi K									
LT	Bi Bj K	P	=	G	,	B	(B		07
NG	Bi K									
BXi	Xj	0	0	0	0	0	A	A	0	10
BXi	Xj*Xk	A	.	L	=	A	*	A	0	11
BXi	Xj + Xk	A	.	L	=	A	+	A	0	12
BXi	Xj - Xk	A	.	L	=	A	-	A	0	13
BXi	-Xk	A	,	-	A					14
BXi	-Xk*Xj	A	.	C	=	A	*	A	0	15
BXi	-Xk + Xj	A	.	C	=	A	+	A	0	16
BXi	-Xk - Xj	A	.	C	=	A	-	A	0	17

SOURCE LANGUAGE

STRING ENTRIES GENERATED BY RDA

OPERATION CODE
GENERATED BY FIN

INSTRUCTION	Col. 7	Col. 8	Col. 9	Col. 10	Col. 11	Col. 12	Col. 13	Col. 14	OPERATION CODE GENERATED BY FIN
LXi jk	A	,	A	(G)	0		
AXi jk	A	,	A	(-	G)	0	20
LXi Bj Xk	A	,	A	(B)	0	0	21
AXi Bj Xk	A	,	A	(-	B)	0	22
NXi Bj Xk	A	,	B	=	A	-	0	0	23
ZXi Bj Xk	A	,	B	=	A	+	0		24
UXi Bj	A	,	B	=	A		0		25
PXi Bj	A	,	B	,	A		0		26
FXi Xj + Xk	A	.	N	=	A	+	A	0	27
FXi Xj - Xk	A	.	N	=	A	-	A	0	30
DXi Xj + Xk	A	.	D	=	A	+	A	0	31
DXi Xj - Xk	A	.	D	=	A	-	A	0	32
RXi Xj + Xk	A	.	R	=	A	+	A	0	33
RXi Xj - Xk	A	.	R	=	A	-	A	0	34
IXi Xj + Xk	A	.	I	=	A	+	A	0	35
IXi Xj - Xk	A	.	I	=	A	-	A	0	36
FXi Xj * Xk	A	.	N	=	A	*	A	0	37
RXi Xj * Xk	A	.	R	=	A	*	A	0	40
DXi Xj * Xk	A	.	D	=	A	*	A	0	41
MXi jk	A	,	*	G			A	0	42
FXi Xj / Xk	A	.	N	=	A	/	A	0	43
RXi Xj / Xk	A	.	R	=	A	/	A	0	44
NO /PS	\$							0	45
CXi Xk	A	,	*	A					46/0
SAi Aj + K	C	=	C	+	G	0			47
Bj + K	C	=	B	+	G	0			50
Xj + K	C	=	A	+	G	0			51
Xj + Bk	C	=	A	+	B	0			52
Aj + Bk	C	=	C	+	B	0			53
Aj - Bk	C	=	C	-	B	0			54
Bj + Bk	C	=	B	+	B	0			55
Bj - Bk	C	=	B	-	B	0			56
									57

SOURCE LANGUAGE

STRING ENTRIES GENERATED BY RDA

OPERATION CODE

<u>INSTRUCTION</u>		<u>Col. 7</u>	<u>Col. 8</u>	<u>Col. 9</u>	<u>Col. 10</u>	<u>Col. 11</u>	<u>Col. 12</u>	<u>Col. 13</u>	<u>Col. 14</u>	<u>GENERATED BY FIN</u>
SBI	Aj + K	B	=	C	+	G	0			60
	Bj + K	B	=	B	+	G	0			61
	Xj + K	B	=	A	+	G	0			62
	Xj + Bk	B	=	A	+	B	0			63
	Aj + Bk	B	=	C	+	B	0			64
	Aj - Bk	B	=	C	-	B	0			65
	Bj + Bk	B	=	B	+	B	0			66
	Bj - Bk	B	=	B	-	B	0			67
SXI	Aj + K	A	=	C	+	G	0			70
	Bj + K	A	=	B	+	G	0			71
	Xj + K	A	=	A	+	G	0			72
	Xj + Bk	A	=	A	+	B	0			73
	Aj + Bk	A	=	C	+	B	0			74
	Aj - Bk	A	=	C	-	B	0			75
	Bj + Bk	A	=	B	+	B	0			76
	Bj - Bk	A	=	B	-	B	0			77

Entry/Exit Register Conditions:

- X2 - Character following opcode
- X6 - Opcode (2 digits)
- B2 - Number of digits in opcode
- B4 - String address of the opcode +1

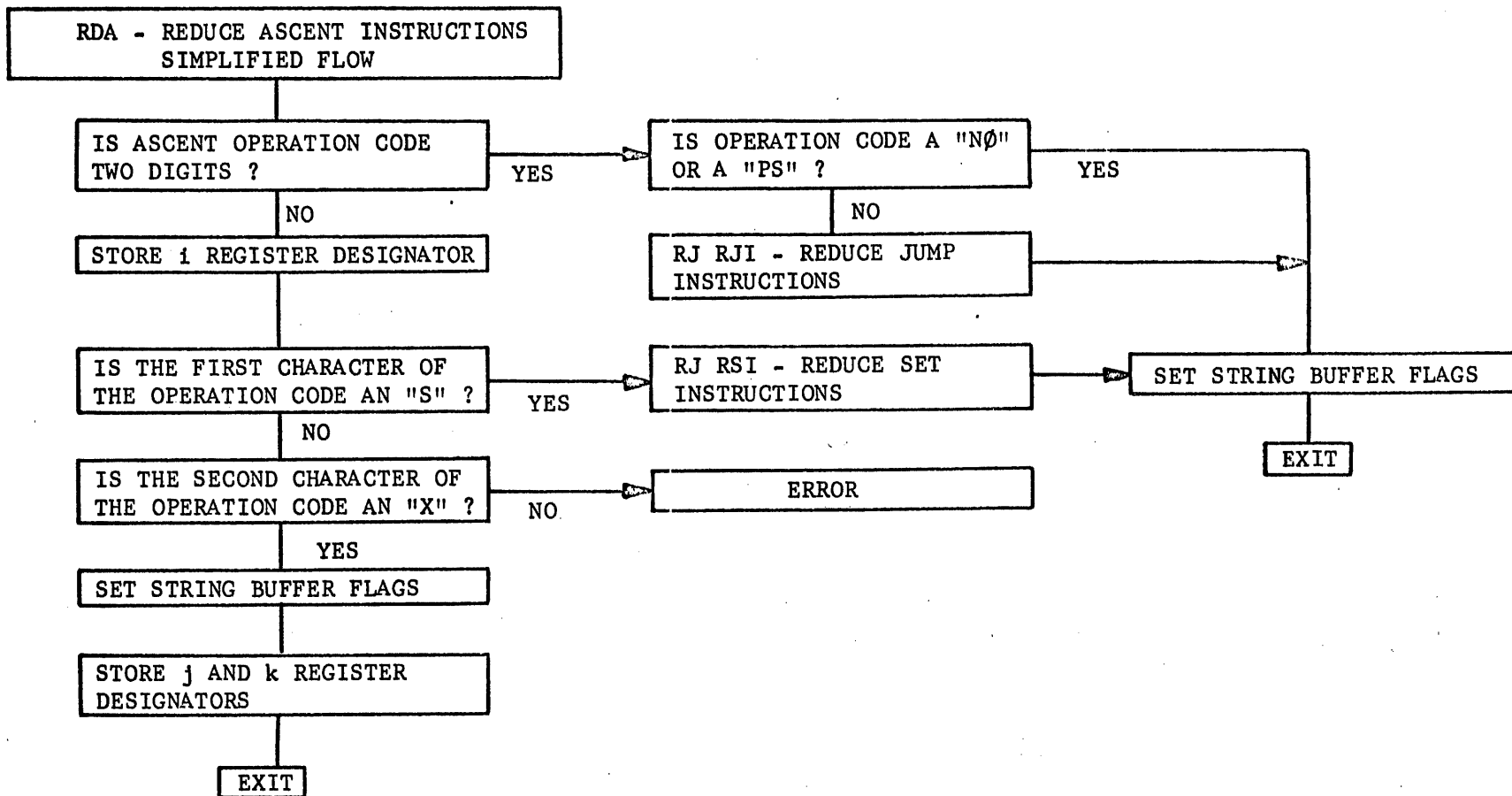

RES - PROCESS RESERVE LIST

When the MAA (Process Assembly Record) subroutine encounters a RES opcode, the RES (Process Reserve List) subroutine is called. The RES declarative permits block reservations with the number of words on the right of the equal sign and the identifier associated with the first word on the left. An example of the RES declarative together with the basic steps in processing the list is shown in Figure RES-1.

On entering the RES subroutine, the TAB (Normalize Statement) subroutine is called. The identifier is checked to insure that the first character is alphabetic. The Variable Name Table (Table M) is scanned to determine if the identifier has been entered and, if not, the identifier is entered into the Variable Name Table. If the variable has been previously entered in the Variable Name Table, an error exit (Duplicate Tag Error) occurs.

Next, a check is made for an equal sign. If one does not appear, or if the end of statement is encountered, a machine-format error exit is taken. The CVN routine is called to convert the constant which signifies the number of words to reserve. Should the constant be negative or greater than $2^{17}-1$ an error exit (Machine-Constant Error) is taken. If the constant is in the proper range, it is entered into the Array Parameters Table (Table Q), and an array tag is assigned and stored into the corresponding Variable Tag Table (Table N) and Array Tag Table (Table P).

Processing of list entries continues in the manner described above until a right parenthesis, indicating the end of list, is encountered.

Subroutines Called: TAB - Normalize Statement
SCT - Scan Table
CVN - Convert Octal or Decimal
ADF - Advance Table

RES DECLARATIVE PROCESSING

EXAMPLE : RES (K1=10, K2=100B, L3=1000)

1. STORE VARIABLE NAME (e.g., k1) IN VARIABLE NAME TABLE
2. CHECK FOR AN EQUAL SIGN
3. CONVERT CONSTANT
4. STORE CONSTANT IN THE DIMENSION TABLE
5. IF THE NEXT ENTRY IS A COMMA, REPEAT 1-4
6. CHECK FOR A RIGHT PARENTHESIS
7. RETURN FOR THE NEXT SOURCE CARD

Temporaries/Flags: TGW - Array Tag (set)

Tables Referenced: TBM - Variable Name Table
TBN - Variable Tag Table
TBQ - Array Parameters
TBP - Array Tag

Entry/Exit Register Conditions: DNA

RJI - REDUCE JUMP INSTRUCTION

The RSI subroutine is entered from RDA whenever an Ascent jump instruction is encountered. RUA (Reduce Additive Field) is called to collect and check the terms in the address field. Then a check is made for the "RJ" and "JP" instructions. These are the only jumps which may contain a single term in the address field. JP is also checked with the multi-term group. This group is further divided into those containing X registers in the address and those containing B registers. Each of these groups are further subdivided. The X register group is divided into ZR, NZ, PL and NG and IR, OR, DF and ID. The B register group has the same subgroupings the first group being identical to the X register group and the second being EQ, NE, GE and LT. RJI also checks for the correct number of terms.

Subroutines Called: RUA - Reduce Additive Field

Temporaries/Flags: INJ - Ascent Mnemonic Code (S)
III - i Portion of Machine Word
JJJ - j Portion of Machine Word
KKK - k Portion of Machine Word

Tables Referenced: None

Entry/Exit Register Conditions:

B2 - Number of digits in code
X2 - Opcode

RSI - REDUCE SET INSTRUCTION

The RSI subroutine is entered from RDA whenever an Ascent Set Instruction (50-77) is encountered. RSI determines the resultant register (i) for SAI, SBI, SXI and SBO. Next the routine examines the first character of the address field for a left parenthesis. If a left parenthesis is found, the next character must be a ".", "-", number or letter. If a letter appears, the RUA (Reduce Additive Field) subroutine will be called to check the terms within the parenthesis. Should the character following the left parenthesis not be a letter, then a scan for a right parenthesis ")" is initiated. The B6 register is set to indicate a constant has not been processed.

If the address field had not contained a left parenthesis, then RUA is called and a check is made for operation registers to determine the "j" and "k" operational registers. Since these registers have been stored in RUA, the RSI subroutine merely checks for legality in the number of terms.

Subroutines Called: RUA - Reduce Additive Field

Temporaries/Flags: INJ - Ascent mnemonic code or register Number (set)
 JJJ - j Portion of Machine Instruction (set)
 KKK - k Portion of Machine Instruction (set)
 III - i Portion of Machine Instruction (set)

Tables Referenced: RCD - Operational Register Codes

Entry/Exit Register Conditions:

X3 contains Sx ~~X~~ =B
 X
 A

X1 contains i register designators

RTN - PROCESS RETURN STATEMENT

A RETURN statement is primarily used in a function or subroutine to indicate the end of logic flow and return control to the calling program. Any subprogram may contain more than one RETURN statement. If used in the main program, terminating instructions are compiled.

Encountering a RETURN statement in a main program, SPR (Handle Stop, Pause, and End) is called to compile terminating instructions. Essentially, the statement has the same effect as an END card.

If the RETURN statement is the terminator of a DO loop, then the next instruction to be compiled will be tagged. A subroutine will have the jump to the entry/exit line tagged and a function will have the fetch instruction tagged.

RTU (Compile Return Instructions) checks the routine name to see if it is a function or not. In the processing of the FUNCTION statement (PPG), the name of the routine was entered into the Variable Name Table and also the Subroutine Name Table. In this way a function and a subroutine subprogram can be distinguished from one another. If the routine is a function, then CIR (Compile Read Instructions) fetches the value of the variable. This value is transferred to X6 and if it is double or complex the less significant portion is set into X7.

Both subroutines and functions, exit through their entry/exit line. This word always receives the location tag, 200001, so a jump to this tag is compiled.

Subroutines Called: ASL - Assemble Letters
CIR - Compile Read Instructions
CLT - Clear Tables I and J
PSN - Process Statement Number
RTU - Compile Return Instructions
SCT - Scan Table
SPR - Compile Terminating Instructions

Temporaries/Flags: CTG - Current Location Tag
 DTI - DO Termination Indicator
 JPS - Current Program Indicator
 PNM - Routine Name

Tables Referenced: Variable Name (M)

Entry/Exit Register Conditions:

Entry: X6 = RETU (display code)

Exit: None

RUA - REDUCE ASCENT ADDITIVE FIELDS

The RUA subroutine is entered for processing of an Ascent address field. RUA scans to the address field, if an A, X, or B register is detected; the register is stored in the JJJ constant. If the term in the address field is not a register, a call to ASV (Assemble Variable) is generated. Next, ASN (Assemble Number) is called to isolate the second term and if it is a constant CVN (Convert Number) is called. If the second term is a register, the register is saved in the KKK constant. Then the next term is selected, examined and processed. As each term is processed, a check for too many terms is made. The B6 register is set to a 1, if necessary, to relay information to MAA (see RDA write-up) subroutine.

Subroutines Called: ASV - Assemble Variable
ASN - Assemble Number
CVN - Convert Octal or Decimal Number

Temporaries/Flags: III - i Portion of Machine Word
JJJ - j Portion of Machine Word
KKK - k Portion of Machine Word

Tables Referenced: RCD - Operational-Register Codes

Entry/Exit Register Conditions:

B6 register - 1 variable or constant not processed.

SCS - SCAN SPECIAL TABLE

The SCS subroutine scans a specified table to determine if the high-order 42 bits are a given value. If the value is found, the low-order 18 bits of that entry are returned in the X6 register. On entering the SCS routine, B4 contains the number of entries in the table to be scanned, B5 contains the starting address of this table, and X6 contains the value right-justified. The value in X6 is shifted 18 places to left-justify it and it is compared to bits 18-59 of the table until either all table entries have been examined or a match is found. In the first case, an error exit occurs, the latter case brings the low-order 18 bits into X6 right-justified and returns.

Subroutines Called: None

Temporaries/Flags: None

Tables Referenced: Specified in B5 register

Entry/Exit Register Conditions:

Entry: B4 - number of entries to search

B5 - table address

X6 - value to be compared

Exit: B4 - relative position of entry from beginning of table

X6 - low-order 18 bits of the table entry

Exit: B1 = relative address of argument in table if found

B1 = negative if not found or table is empty

X2, X6 = contents of corresponding entry in succeeding table

X1 = argument

SUB - PROCESS SUBROUTINE LIST

When the MAA (Process Machine or Ascent Records) subroutine encounters a SUB declarative, the SUB subroutine (Process Subroutine List) is called. The SUB declarative permits a programmer to assemble a subprogram into his program and to reference this subprogram by a name of his choice. An example of the SUB declarative together with the basic steps in processing the list is shown in Figure SUB-1.

On entering the SUB subroutine, the TAB subroutine is called to normalize the list. The Variable Name Table (Table M) is scanned to determine if the variable which has been equated to the subroutine name has been entered and, if not, the variable is entered in the Variable Name Table. If the variable has previously been entered in the Variable Name Table, an error exit (Duplicate Tag Error) occurs. The variable name is also checked to insure that the first character is alphabetic and that the name is composed of two or more characters.

Next, a check is made for the equal sign, and the Subroutine Name Table (Table S) scanned to determine if the subroutine name has previously been entered: if not, the subroutine name is entered in the Subroutine Name Table and the corresponding entry in the Subroutine Parameter Table (Table U) is reserved. If the subroutine name was a previous entry in the Subroutine Name Table, the corresponding Library Tag (L-tag) from the Subroutine Tag Table (Table T) is entered in the Variable Tag Table (Table N). If the subroutine name was not a previous entry in the Subroutine Name Table, a Library Tag is generated and entered in the Variable Tag Table.

Processing of list entries continues in the manner described above until a right parenthesis, indicating the end of the list, is encountered.

Subroutines Called: TAB - Normalize Statement
SCT - Scan Tables
ADF - Advance Tables

SUB DECLARATIVE PROCESSING

EXAMPLE: SUB (SI = SUB5, \emptyset UT = \emptyset UTPTC, LG = L \emptyset G)

1. STORE VARIABLE NAME (e.g., SI) IN VARIABLE NAME TABLE
2. CHECK FOR EQUAL SIGN
3. CHECK SUBROUTINE NAME TABLE: ENTER SUBROUTINE NAME (e.g., SUB5) IF NOT PREVIOUSLY ENTERED
4. RESERVE ENTRY IN SUBROUTINE ARGUMENT TABLE
5. ENTER LIBRARY TAG IN VARIABLE TAG TABLE
6. IF NEXT ENTRY IS A COMMA, REPEAT 1 - 5
7. CHECK FOR RIGHT PARENTHESIS
8. RETURN FOR NEXT SOURCE CARD

Temporaries/Flags: TGL - Library Tag (set)

Tables Referenced: Variable Name Table (Table M)
Variable Tag Table (Table N)
Subroutine Name Table (Table S)
Subroutine Tag Table (Table T)
Subroutine Parameter Table (Table O)

Entry/Exit Register Conditions: n/a

TAB - NORMALIZE STATEMENT

When the Assemble FORTRAN Subroutine, AFS, transferred a statement (or statements, if there were multiple statements on the card) from the card buffer to the string buffer, successive characters on the card were packed in successive words in the string buffer, one character per word. The TAB routine examines a specified statement, packing variables and constants as one-word string buffer entries. Separators, such as parentheses, commas, etc., remain packed one per word. Figure 1 illustrates how a statement in the string buffer would appear before and after normalization by the TAB subroutine.

A simplified flow chart of the TAB subroutine is shown in Figure 2. A string buffer entry is read, beginning at the specified address. The entry may be a space, a letter, a number, or a separator. The steps in processing each of these is described below.

Space: if the entry is a space, it is ignored, and the next entry is read.

Letter: if the entry is a letter, the ASV subroutine is called to assemble the variable. The variable, packed in a single word, is then written back in the string buffer.

Number: if the entry is a number, the ASN subroutine is called to assemble the digits (up to 7) in the number. The digits, packed in a single word, are then written back in the buffer. The next entry in the string buffer is then read and examined to determine if it is an H, L, or R; if it is not, the entry is processed in the normal manner. If the entry following the number was an H, L, or R, then a literal of the form nHddd...d is being processed. The number just assembled is converted to decimal to provide a count of the number of characters in the literal. The data statement indicator is then examined to determine if a DATA statement is processed. If so, the specified number of characters following the H, L, or R are packed, ten per word, and written back into the string buffer. A comma is entered in the string after each full

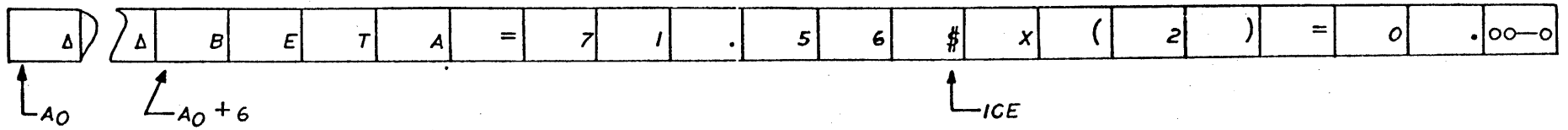

STRING BUFFER LOADING BY THE AFS SUBROUTINE

Figure TAB-1

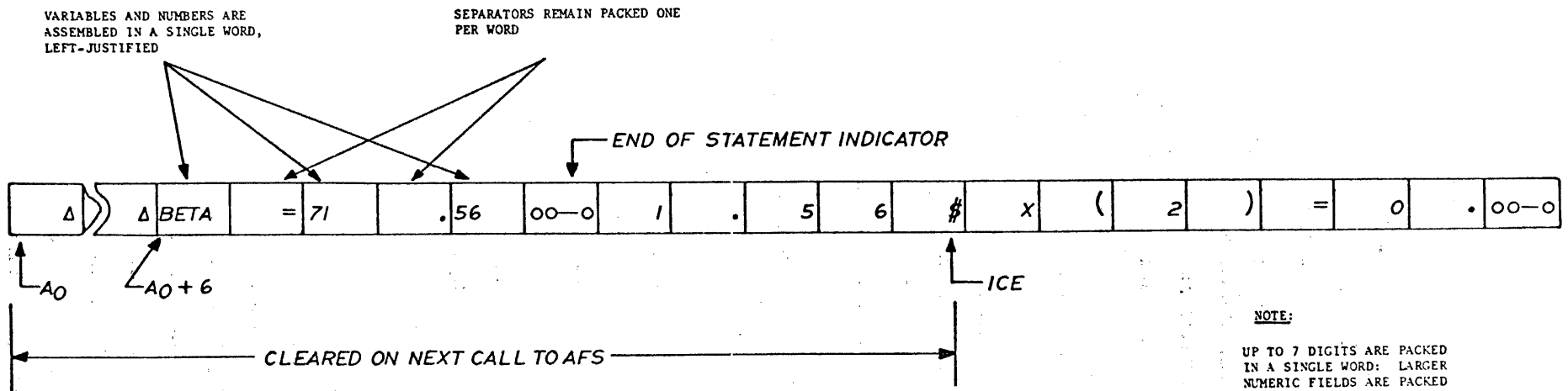

NOTE:

UP TO 7 DIGITS ARE PACKED IN A SINGLE WORD: LARGER NUMERIC FIELDS ARE PACKED IN CONSECUTIVE WORDS, 7 DIGITS PER WORD

STRING BUFFER AFTER NORMALIZATION BY THE TAB SUBROUTINE

word processed. If, after the specified number of characters have been processed, a partly filled word remains, it is filled with spaced (55_8) if the descriptor was an H, or is zero-filled if the descriptor was an L or R. If the descriptor was an R, the characters are right-justified. The literal end indicator is then set in the rightmost six bits (R descriptor) or leftmost six bits (L descriptor), and the next entry is processed.

If the literal was not in a data statement, the specified number of characters are packed, ten per word, and stored as consecutive entries in the Constant Value Table (table A). For each table A entry, a constant tag (K-tag) is entered in the Constant Tag Table (table B). The tag corresponding to the first word entered in the Constant Value Table is also entered in the string buffer. A partly filled entry is completed and justified in a manner similar to that for a literal in a DATA statement. After the last word of characters in the literal has been stored in the Constant Value Table, an end flag (zero word) is entered in the Constant Value Table: a constant tag is generated and stored in the Constant Tag Table entry corresponding to the literal end flag. The next string buffer entry is then processed.

Separator: When AFS detected the first \$ on a card, it replaced the \$ with a zero word and set the multiple statement indicator to the address of the \$ in the string buffer. When the Sense Formula (SFO) subroutine compiles a statement on a card containing multiple statements, the \$ is replaced and the multiple statement indicator cleared. TAB therefore senses for a \$: when found, the multiple statement indicator is set to the original location of the \$ in the buffer and the \$ replaced with a zero word. Note that this process is required because the compression of the statement as it is normalized by TAB changes the location of the statement end.

If the separator is an open or close parenthesis, the parenthesis counter is incremented or decremented, and the parenthesis written back into the string buffer.

Figure TAB-2

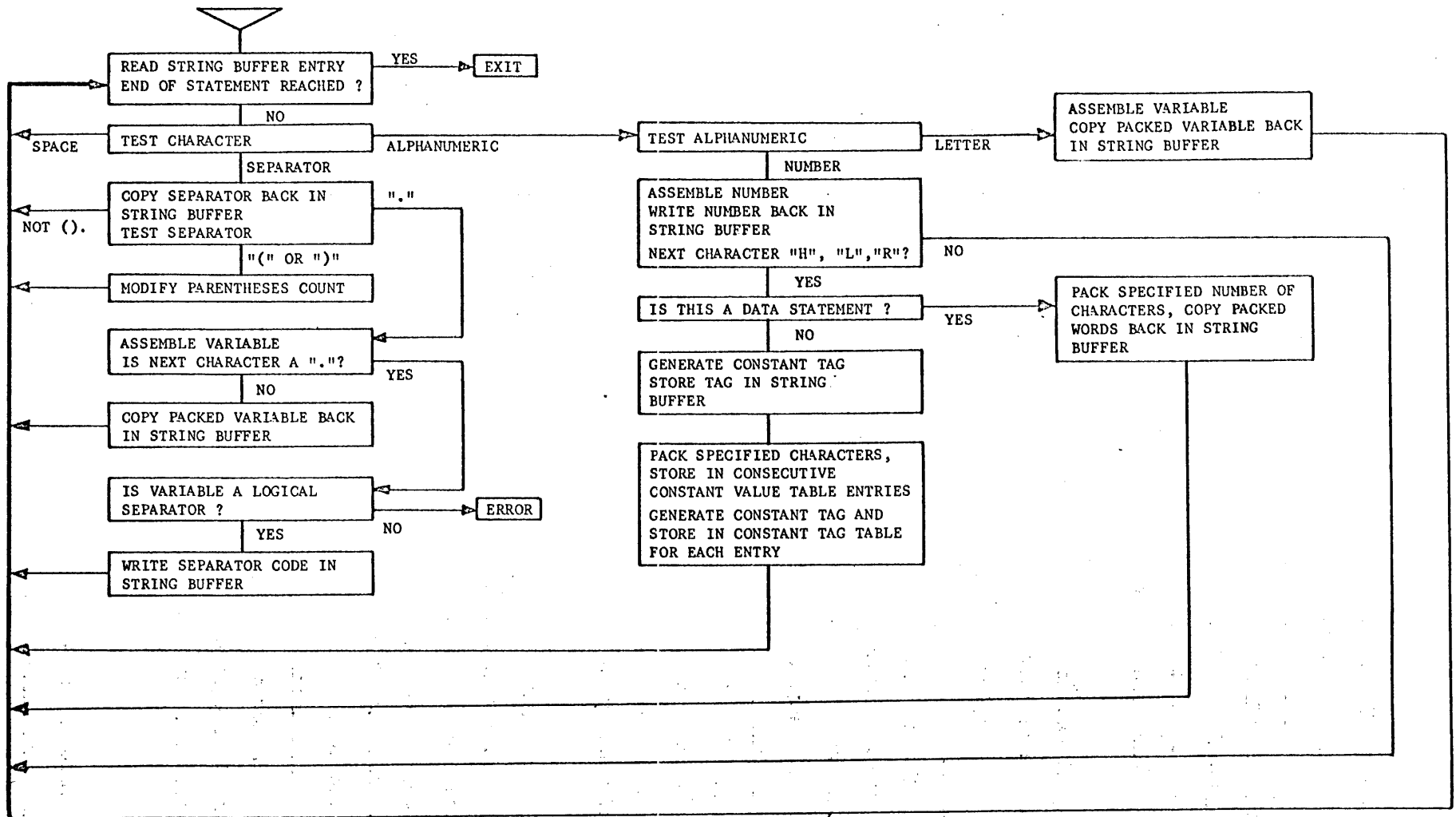

NORMALIZE STATEMENT SUBROUTINE
MAIN FUNCTIONS

If the separator is a period, the variable which follows it is assembled, and the character following the variable is examined to determine if it is a period. If it is, then the variable must be a logical separator, and the appropriate flag or code is stored in the string buffer (see below).

<u>Separator</u>	<u>Code/Flag</u>	
.LT.	60	} right-justified
.LE.	61	
.EQ.	62	
.NE.	63	
.GE.	64	
.GT.	65	
.N. or .NOT.	66	
.A. or .AND.	67	} right-justified
.O. or .OR.	70	
.F. or .FALSE.	00000000	—————07
.T. or .TRUE.	77777000	—————07

Processing continues until the end of the statement (indicated by a zero word or a \$) is encountered. The parentheses counter is then checked and, if zero, control is returned to the calling program.

Subroutines Called: ASV - Assemble Variable
 ASN - Assemble Number
 DEC - Convert Decimal Number
 ADF - Advance Tables

Temporaries/Flags: ICE - Multiple Statement Indicator (set)
 ILG - Logical Relation Count (set)
 INR - Justify Indicator (set)
 DFG - Data Statement Indicator
 TGK - Constant Tag (set)

Tables Referenced: Constant Value Table (Table A)
 Constant Tag Table (Table B)

Entry/Exit Register Conditions

Entry: B3, B4 = address in string buffer where normalization
is to begin

Exit: n/a -

Note: B4 is advanced as entries are read from the string buffer and processed. B3 is advanced as entries are written back into the string buffer.

TIQ - TRANSLATE INDIVIDUAL QUANTITIES

The Translate Individual Quantities (TIQ) subroutine is called by various statement processing routines to translate all or a portion of the string into a series of tags, constants, and separators. On entrance to the TIQ subroutine, the B4 register contains the string buffer address of the location in the string where translation is to begin: translation is terminated on detecting the end of the statement.

TIQ examines each string buffer entry to determine if it is a separator. If the entry is a separator and is not a period (i.e., a decimal point), the next entry in the string is examined. If the separator is a right parenthesis, it is assumed that the end of a list of arguments has been reached, and so the use of a function name as an argument is inhibited by setting the Inhibit Function Argument flag to zero (see Translate Variable description). If the entry is a period or is not a separator, it is assumed that this entry (and possibly succeeding entries) constitutes a variable or constant. If this entry is followed by a left parenthesis, it is either a function name or an array name. If this entry is not followed by a left parenthesis, it is a simple variable, a constant, or an argument, and the Translate Variable (TRN) subroutine is called to perform the translation. If the entry is a constant, TRV will call TNK to translate the constant, and, depending on the type of constant, either TNK or TRV will replace the string entry with a Constant Tag (K-tag) or, depending on the mode and magnitude of the constant, with the translated constant. In translating the constant, further compression of the string (i.e., beyond that performed by TAB) may be required, since a constant may occupy several entries. This will be performed by TNK. If the string entry being examined is not a constant but is a variable, and function argument use is not allowed, TRV searches the Variable Name Table for the variable and, if not found, enters the variable in this table. In either case, the corresponding entry from the Variable Tag Table is entered in the string. If function argument use is allowed (i.e., if the string entry is part of an argument list), TRV searches the Subroutine Name Table as well as the

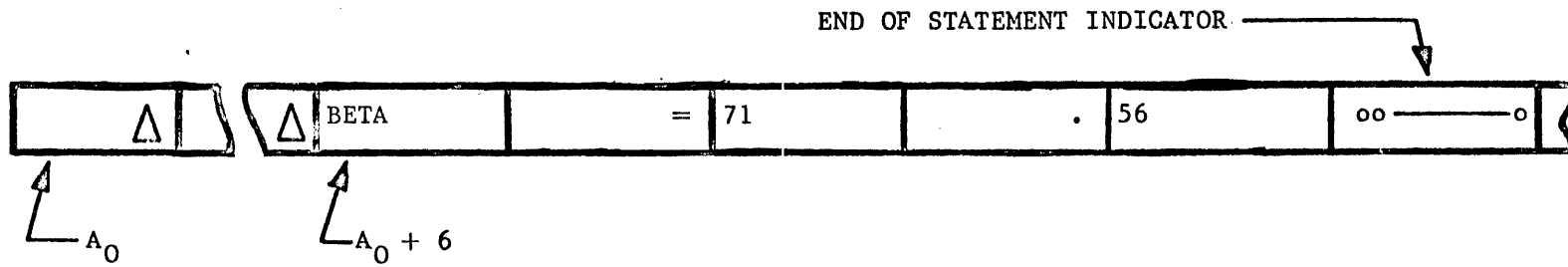

STRING BUFFER AFTER NORMALIZATION BY THE TAB SUBROUTINE

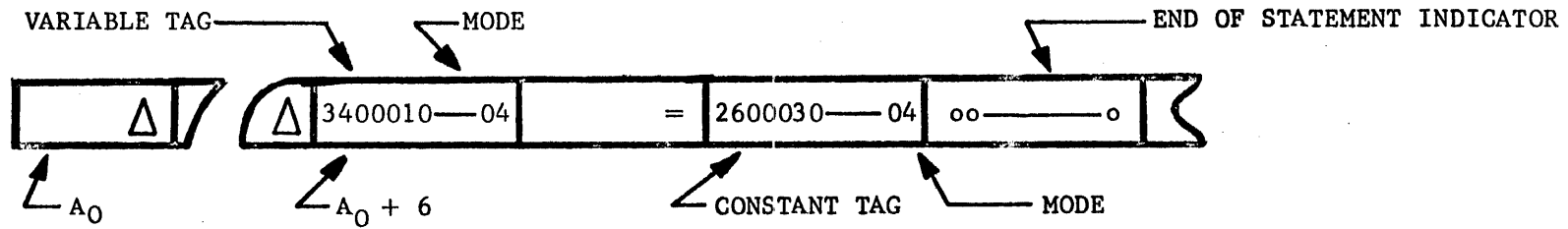

STRING BUFFER AFTER TRANSLATION BY THE TIQ SUBROUTINE

Figure TIQ-1

Variable Name Table.

If the entry being examined is followed in the string by a left parenthesis, it may be a function name or an array name. If it is an array name, the name will have been entered in the Variable Name Table during processing of the DIMENSION statement, and so the absence of the name from this table indicates that variable is a function name. However, a function name may also be in the Variable Name Table (e.g., if specified in a Type statement). Therefore, in order to ascertain that entry is indeed an array name, TIQ scans the Array Tag Table to determine if it contains the Variable Tag for this entry. If the variable is an array name, this tag will have been entered in the Array Tag Table during processing of the DIMENSION statement. If the variable is an array name, TIQ enters the tag from the Variable Tag Table in the string, and goes on to examine the next entry.

If the variable was not in the Variable Name Table, or if it was in the Variable Name Table and the corresponding tag was not in the Array Tag Table (and was not a program tag), TIQ calls the Translate Special Function (TSF) subroutine to tag the variable, which must be a function name. TSF searches the Function Name Table, the Subroutine Name Table, and the library function tables for the function name and, if not found, enters the name in the Subroutine Name Table and generates a Library Tag for it. TSF returns a Library Tag to TIQ in all cases except that in which the function was one for which in-line code is generated: in the case, the function name is returned. The tag or name returned by TSF is entered in the string by TIQ.

Subroutines Called: SCT - Scan Tables
TRV - Translate Variable
TSF - Tag Special Function

Temporaries/Flags: FAG - Inhibit Function Argument Use flag (set)
ARF - Argument Reference Count (set)
ARI - Array Reference Count (set)

Tables Referenced: Variable Name Table (Table M)
Array Tag Table (Table P)

Entry/Exit Register Conditions

Entry: B4 = Address in string buffer where translation is
to begin

Exit: n/a

TNK - TRANSLATE CONSTANT

The Translate Constant subroutine is called by the Translate Variable subroutine when the latter encounters a period (i.e., a decimal point) or a numeric entry in the string, or when the variable to be processed by TRV turns out to be an octal constant of the form Onnnnnn. On entrance to TNK, the B4 register contains the string buffer address of the constant to be translated.

TNK first checks column 1 to see if it contains a "B": if so, then the constant to be translated is an octal constant and the OCT subroutine is called to convert the number to its binary equivalent. Note that TRV, on detecting an octal constant of the form Onnnnnn, deletes the 0, writes a "B" in the column 1 position of the string buffer, and calls TNK to translate the constant.

If column 1 did not contain a B, TNK examines the entries preceding and following the constant to determine if the constant is of the form

$$\left[\begin{array}{c} = \\ , \end{array} \right] \text{ constant S } \left[\begin{array}{c}) \\ , \end{array} \right]$$

The RUN compiler permits a statement number followed by the letter S to be used as a subroutine argument, so when the form described above is encountered, the Identify Statement Number (ISN) subroutine is called to determine if this statement number has already been tagged and, if not, to enter the statement number in the Statement Number Table (Table K) and a Statement Tag (H-tag) in the Statement Tag Table (Table L). If the statement was already tagged with a Program Tag (A-tag), the Program Tag is entered in the Permanent Tag Table (Table D) and a Statement Tag entered in the Temporary Tag Table (Table C).

If the number is neither an octal number nor a statement number, TNK calls DEC to convert the number to its binary equivalent: DEC returns the converted number in X6 and a mode indicator in B6. If the number was a double precision number, both words of the number are entered in the Constant Value Table (Table A). Constant Tags (K-tags) are generated

for both entries and stored in the Constant Tag Table (Table B). The tag corresponding to the first word is entered in the string buffer.

If the number was not double precision, TNK performs additional analysis of the constant in an attempt to eliminate a constant-associated plus or minus sign (i.e., as opposed to a sign indicating an arithmetic operation), to determine if the constant value itself can be entered in the string (eliminating the necessity of generating a tag), to determine if the constant is part of a complex constant, and finally to determine if a constant of this value has previously been entered in the Constant Value Table. This processing is summarized in figure TNK-1.

TNK will store a constant whose value is in the range -2^{16} to $2^{16}-1$ in the buffer in the form shown below if the constant is an integer or octal constant. Also, a floating-point zero preceded by an equal sign and followed by an end of statement indicator is entered directly in the string.

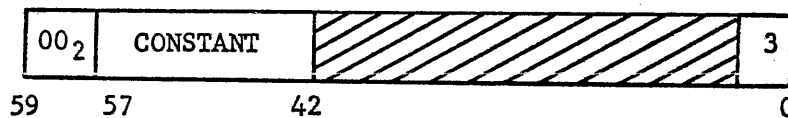

A flag (3) is set in the low-order 3 bits of the string entry to indicate that the entry is a constant and not a Constant tag: the constant itself is shifted to the high-order bit positions.

Floating-point, double precision, and complex constants, as well as integer and octal constants not in the range -2^{16} to $2^{16}-1$ are entered in the Constant Value Table (Table A) and a Constant Tag (K-tag) is generated and entered in the Constant Tag Table (Table B). The mode indicator is then set in the low-order bits of the tag, and the tag entered in the string buffer. The tag format in the string is as follows:

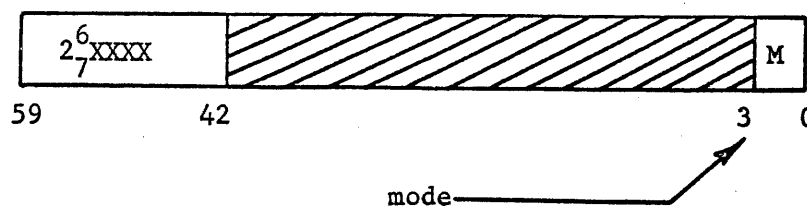

TNK PROCESSING SUMMARY

Note: Brackets are used to indicate entries preceding/following the constant

FORM	ACTION
<p>1. constant where constant = -0</p>	<p>Store constant in the Constant Value table, generate a constant tag and store it in the string and in the Constant Tag table</p>
<p>2. [=] constant [ES] where constant = 0 and ES represents the end of the statement</p>	<p>Enter the constant in the string</p>
<p>3. $\begin{bmatrix} ** \\ (\\ = \\ , \\ L \end{bmatrix} \begin{bmatrix} + \\ - \end{bmatrix}$ constant where L represents a logical operator</p>	<p>Delete the plus sign. If the constant is not followed by **, delete the minus sign and complement the number</p>
<p>4. $-2^{16} < \text{constant} < 2^{16} - 1$ where constant is integer or octal</p>	<p>Enter the constant in the string</p>
<p>5. [(] constant [,] where constant is a floating-point number</p>	<p>Set complex mode indicator and delete the left parenthesis from the string. Store constant in the Constant Value table, generate a constant tag and store it in the string and in the Constant Tag table</p>
<p>6. $\begin{bmatrix} \text{complex-} \\ \text{constant-} \\ \text{tag} \end{bmatrix} [,]$ constant [)] where constant is a floating-point number</p>	<p>Set complex mode indicator and delete the comma, the constant, and the right parenthesis from the string. Store the constant in the Constant Value table, generate a constant tag and store it in the Constant Tag table but not in the string</p>
<p>7. constant where constant is not double precision, not the first word of complex constant, and cannot be entered directly in the string (as per 1 or 4 above)</p>	<p>If the constant cannot be misinterpreted as part of a format, search the Constant Value table: if this constant is already entered, write the corresponding tag in string. If not already entered, enter it, generate a constant tag and store the tag in the string and Constant Tag table</p>

Figure TNK-1

The mode indicator may take on the following values.

<u>Constant Type</u>	<u>Mode Indicator</u>
1	Logical
2	Integer
4	Floating-Point
5	Double Precision
6	Complex

In certain cases, the Constant Value Table is searched to determine if a constant of the same value has been previously entered. If it has, then the tag corresponding to this entry will be used. Prior to searching the Constant Value Table, the constant is checked to insure that it cannot be misinterpreted as part of a format statement: in other words, considering the constant as a sequence of 2-digit octal numbers, it is checked to see that at least one number falls outside the range 0 - 57₈. If this is not the case, the Constant Value Table search is bypassed, and the constant entered in the table.

Note that in the case of a double precision or complex constant, both words are entered in the Constant Value Table and tags generated for each word. However, only the tag corresponding to the first word is entered in the string.

A constant may occupy several words in the string prior to translation: furthermore, in the translation of the constant, separators may be deleted from the string. Therefore, on exiting from the TNK routine, a check is made to determine if more than one entry has been translated and, if so, the entire statement is shifted down in the buffer.

Subroutines Called: OCT - Convert Octal Number
 ISN - Identify Statement Number
 ADF - Advance Tables
 DEC - Convert Decimal Number

Temporaries/Flags: TGH - Statement Tag (set)

TGK - Constant Tag (set)

Tables Referenced: Permanent Tag Table (Table D)
Temporary Tag Table (Table C)
Constant Value Table (Table A)
Constant Tag Table (Table B)

Entry/Exit Register Conditions

Entry: B4 = address in string buffer of constant to be translated

Exit: X6 = tag or constant value entered in the string
B4 = address in string buffer of tag or constant value entered

TRV - TRANSLATE VARIABLE

The TIQ subroutine (Translate Individual Quantities) translates string buffer entries other than separators into tags and constants. When TIQ encounters a string buffer entry which is not a separator and is not followed by a right parenthesis, it calls the Translate Variable (TRV) subroutine to translate the entry. On entrance to TRV, the address of the string buffer entry to be translated is contained in the B4 register.

The entry to be translated is examined: if it is a period, or begins with a number, it is assumed that this entry and possibly succeeding entries comprise a constant, and so the Translate Constant (TNK) subroutine is called to process the constant. TNK will enter either a constant tag in the string or, in the case of integer and octal constants in the range -2^{16} to $+2^{16}-1$, will enter the constant value itself in the string.

If the entry is a variable (i.e., begins with a letter) TRV searches several tables to see if the variable has previously been tagged and, if it has, enters the corresponding tag in the string buffer in place of the variable. The first such table searched is the Argument Name Table (Table I). Next, the Inhibit Function Argument flag is examined. This flag is set in TIQ when a function has been encountered, and is also set when processing the list of arguments in a CALL statement: it is cleared when the left parenthesis terminating the argument list is encountered. The Inhibit Function Argument flag is used to permit the use of a subroutine name as an argument only in a CALL or function statement.

If the Inhibit Function Argument flag is set, the Variable Name Table (Table M) is scanned: if the variable is found in this table, the corresponding tag is entered in the string buffer. If the variable was not found in the Variable Name Table, the Subroutine Name Table (Table S) is searched: if the variable is found in this table, the corresponding subroutine tag (L-tag) is entered in the string. If the variable was preceded by a comma or left parenthesis and is followed by

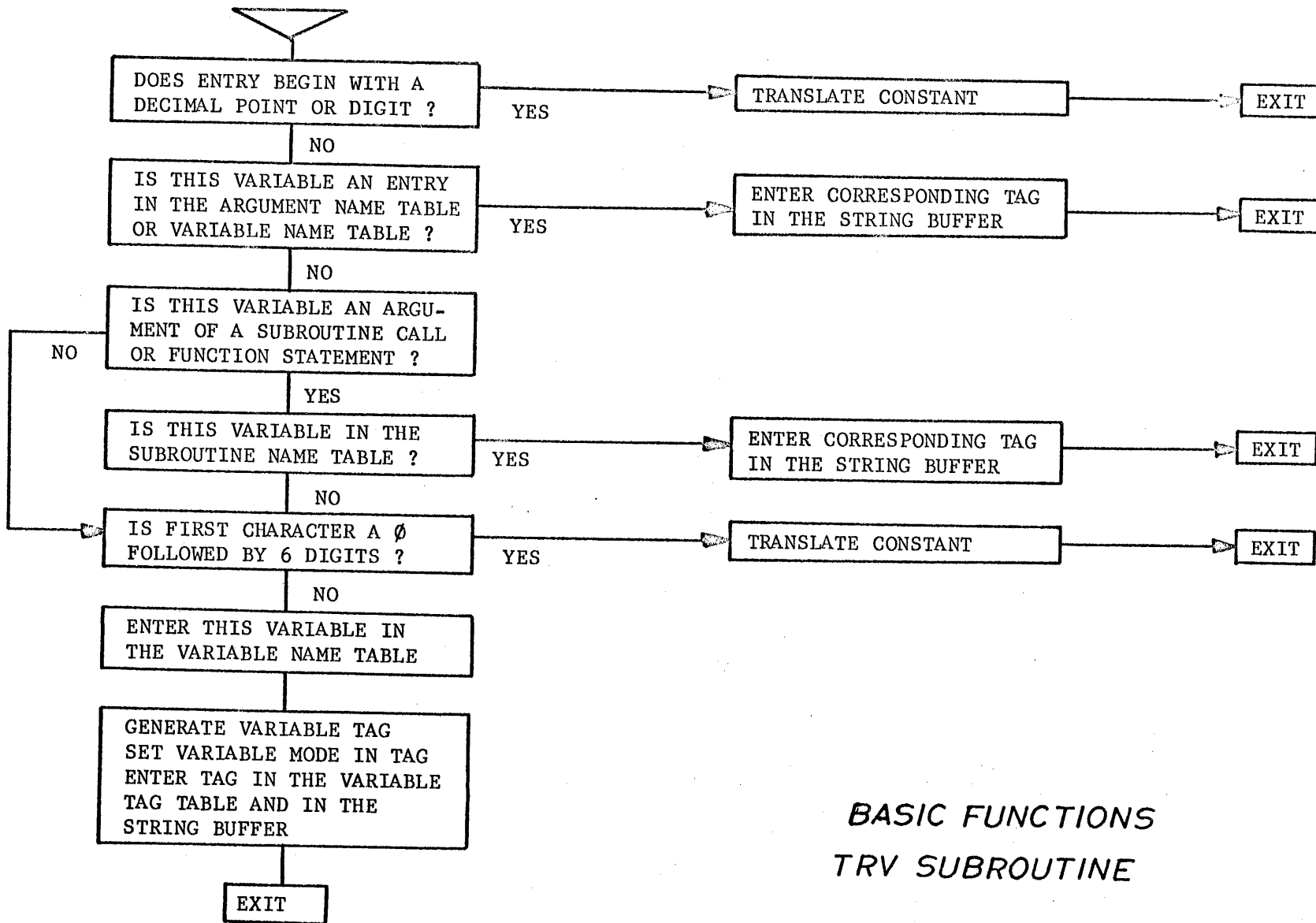

*BASIC FUNCTIONS
TRV SUBROUTINE*

a comma, equal sign, or right parenthesis, then the variable is assumed' to have been an argument, and so control is returned to the calling program.

If the Inhibit Function Argument flag is not set, the Variable Name Table only is searched for the variable: if found, the corresponding tag is entered in the string buffer and control is returned to the calling program. If the variable is not found in the Variable Name Table or, for the special cases described earlier, in the Subroutine Name Table, the variable is examined to see if it could be an octal constant of the form Onnnnnn. If it is, the "0" is deleted, and the digits written back into the buffer. A "B" is then written in the column 1 position of the string buffer, and the Translate Constant subroutine called to translate the number. The tag/constant returned by TNK is then entered in the string, and control returned to the calling program.

If the variable was not an octal constant, it is entered in the Variable Name Table and a Variable tag (V-tag) is generated. Column 1 is sensed to see if it contains a "D" (double-precision) or an "I" (complex) and, if so, the tag is advanced by 2: otherwise, the tag is advanced by 1. The first letter of the variable name is then examined to determine if it is an I, J, K, L, M, or N, and the mode indicator set accordingly. The mode indicator in the low-order three bits of the tag is set as follows:

<u>Mode Indicator</u>	<u>Variable Type</u>
2	Fixed Point
4	Floating Point
5	Double Precision
6	Complex

The variable tag is then entered in the Variable Tag Table (Table N) and in the string buffer.

Subroutines Called: TNK - Translate Constant

SCT - Scan Tables

ADF - Advance Tables

Temporaries/Flags: FAG - Inhibit Function Argument Flag (set)

INH - Column 1 Temporary (set)

TGU - Variable Tag (set)

Tables Referenced: Variable Name Table (Table M)

Subroutine Name Table (Table S)

Variable Tag Table (Table N)

Entry/Exit Register Conditions

Entry: B4 = address in string buffer of variable to be translated

Exit: B4 = address in string buffer of tag/constant

X6 = tag/constant

TSF - TAG SPECIAL FUNCTION

The Tag Special Function (TSF) subroutine is called by various routines (e.g., TIQ, NDC, LST, FUN, etc.) to provide a tag for a function or subroutine name. On entrance to TSF, the variable to be tagged is contained in the X6 register. TSF first searches the Function Name Table (Table E) to determine if the variable is the name of a previously defined arithmetic statement function. If it is, the corresponding Function Tag (F-tag) is returned to the calling routine. If the variable is not found in the Function Name Table, the Subroutine Name Table (Table S) is searched. If the variable is found in this table and is not the first entry, the corresponding Subroutine Tag (L-tag) is returned to the calling program. The first entry in the Subroutine Name Table is the program name: if a function subprogram attempts to call a subprogram with the same name as the main program, an error exit occurs.

The mode of a function subprogram may be specified in a Type statement. When a function name is encountered in a Type statement, the name is entered in the Variable Name Table, and a Variable tag containing the mode of the function is entered in the Variable Tag Table. Thus, when a function name is not found in the Function Name Table or in the Subroutine Name Table, TSF searches the Variable Name Table. If the name is found in this table, a Library tag is generated and the mode extracted from the Variable Tag and inserted in the Library Tag. The function name is then entered in the Subroutine Name Table, and the Library Tag entered in the Subroutine Tag Table (Table T) and returned to the calling program. A zero word is entered in the corresponding location in the Subroutine Parameter Table (Table U) to reserve space for the subroutine parameters.

If the variable was not found in the Variable Name Table, the tables of FORTRAN II and FORTRAN IV library function names are searched. If the variable name is found in these tables, a check is made (by determining the relative position within the table) to determine if in-line code is generated for this function. If so, control is returned to the calling

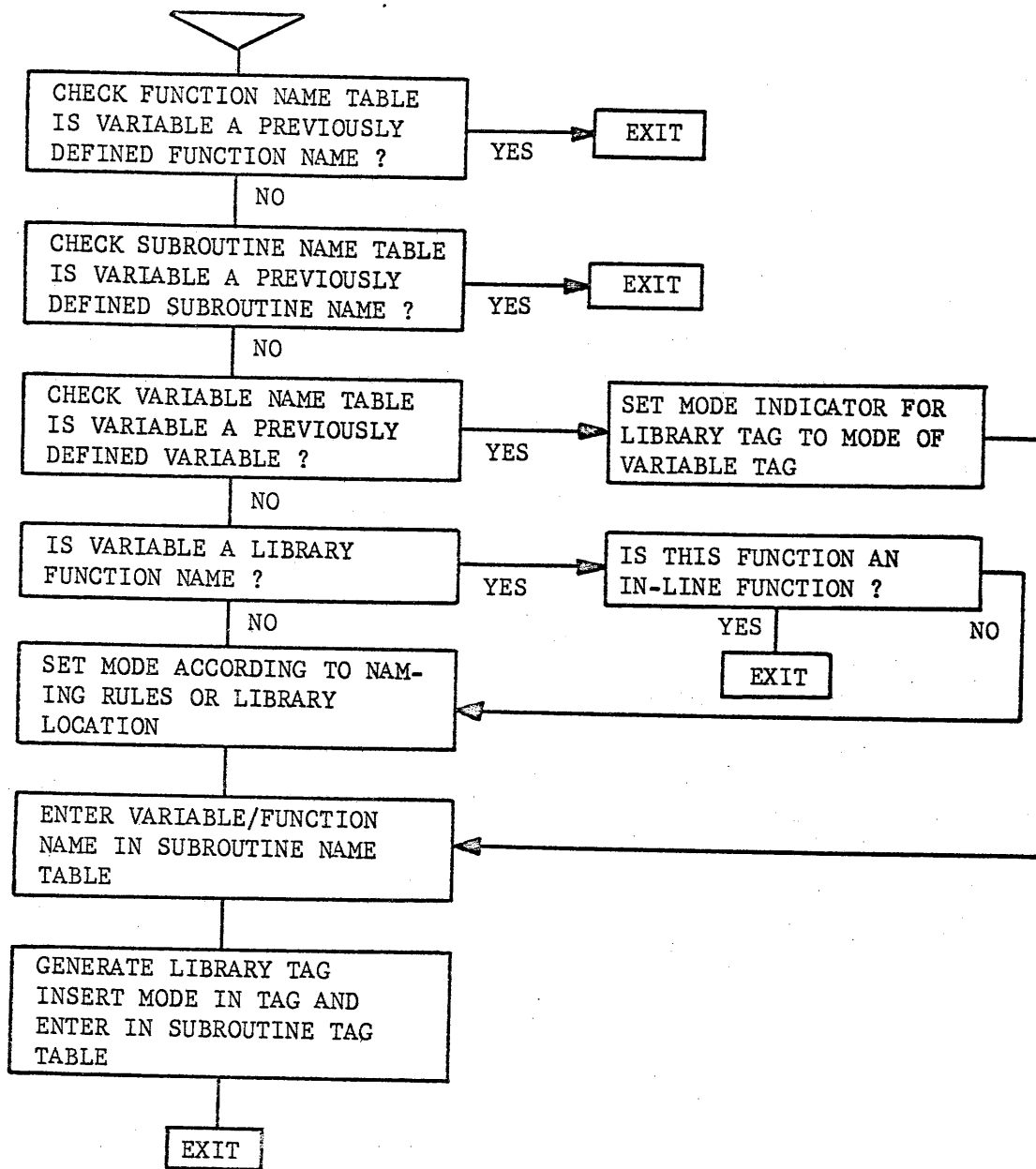

*BASIC FUNCTIONS
TSF SUBROUTINE*

Figure TSF-1

routine: the function is returned in place of a tag.

In order to avoid unnecessary duplication of library subroutines, a FORTRAN II function name is replaced by the equivalent FORTRAN IV function name. Since the FII and FIV names may differ, TSF searches the Subroutine Name Table again to determine if it contains the FIV function name. If it does, the corresponding Subroutine Tag is returned to the calling program. If it does not, the function name is entered in the Subroutine Name Table and the corresponding entry reserved in the Subroutine Parameter Table. A Library Tag is generated, the function mode inserted, and the tag entered in the Subroutine Tag Table and returned to the calling program. If the function name was not found in the tables of FORTRAN II and FORTRAN IV function names, the table of double precision function names is searched: if the variable name is found in this table, it is processed in a manner very similar to that for FII or FIV function names.

If the variable name was not found in the Function, Subroutine, or Variable Name Tables, and was not a library function, then it is the first reference to a programmer-defined function subprogram, and so the variable name is entered in the Subroutine Name Table. The mode of the variable is determined by the FII or FIV naming rules, and inserted in a generated Library Tag. The Library Tag is entered in the Subroutine Tag Table and returned to the calling routine.

The mode indicator set in the low-order bits of the Library Tag has the same connotation as the mode indicator in Variable or Constant Tags: a 2 indicates integer mode, a 4 indicates floating-point mode, and so on.

Subroutines Called: SCT - Scan Tables
ADF - Advance Tables

Temporaries/Flags: RJC - Return Jump Count (set)
 FSR - Function Statement Reference Count (set)
 IPS - Program/Subprogram Indicator
 SRI - Subroutine Reference Count (set)
 MOD - Subprogram Mode
 TGL - Library Tag (set)

Tables Referenced: Variable Name Table (Table M)
 Function Name Table (Table E)
 Subroutine Name Table (Table S)
 Subroutine Tag Table (Table T)
 Subroutine Parameter Table (Table U)

Entry/Exit Register Conditions

Entry: X6 = Variable to be tagged

Exit: X6 = Library tag or, in the case of an in-line
 FII or FIV function, the FIV function name

TTT - REPLACE TEMPORARY TAGS

This routine is called during the processing of the END statement in order to replace any temporary tags that were generated during compilation with corresponding permanent tags. The K portion of each thirty bit instruction is examined to see if it is a temporary tag. If it is, the Temporary Tag Table is searched to see if the tag is there and the permanent tag replaces the temporary tag in the object code. If the tag is not there, the reference is ignored. Temporary tags are used to tag a referenced location that has not yet been defined such as in the GO TO 10 statement. If 10 is not yet defined, a temporary tag is generated for it. When it becomes defined, the assembled location tag for the statement number is entered into the corresponding location in the Permanent Tag Table. Also temporary array reference tags may also be generated in the evaluation of the left member of an arithmetic expression. For instance, in the evaluation of $A(I+5) = \dots$ an Array Tag along with an address increment is entered into the Temporary Tag Table and the Array Tag for the A array is entered into Permanent Tag Table. These are handled in the process special array tags routine.

Subroutines Called: SCT - Scan Tables

Temporaries/Flags: ZAB - Short File Start

Tables Referenced: Temporary Tag Table (Table C)
Permanent Tag Table (Table C)

Entry/Exit Register Conditions: None Used

UNP - UNPACK PARENTHESIS

UNP controls the processing of an arithmetic statement until all portions of the statement that appear within parenthesis have been evaluated.

The statement is searched backwards, starting with a specified location, until either a left parenthesis or column 6 is found. When a left parenthesis is detected, the entry previous to it is examined to see if it is a separator. If it is, an arithmetic expression imbedded in parenthesis has been found. CXP is called to compile instructions to evaluate the expression; the expression itself is replaced by a temporary tag in the string and an instruction is compiled to save the result of the evaluation in this temporary. The search backwards for another left parenthesis is resumed. If the entry previous to the left parenthesis was not a separator, the parenthesis could be for an array reference or could be used to set off the arguments to a subroutine or function. In the case of an array reference, the rest of the statement is searched back to column 6 to see if this same array reference appears again. If it does not, the reference is not processed at this time. Otherwise, the CSR routine is called to compile instructions to bring the address of the specified array entry to an index register. This address is then saved in an indirect and all of the array references in the statement are replaced by this indirect tag.

The last case is the subroutine or function reference. The CRF routine is called to compile the instructions to make the call to the function/subprogram. It will take care of built-in functions, statement functions, and function-subprogram references. The function/subprogram reference in the string is replaced by a temporary tag, and instructions are compiled to store the result of the function/subprogram in this temporary.

If the left member of the expression is a dimensioned variable, UNP will call CSR to compile the instructions to bring the address of the entry to an index register. The string entry will be replaced by an indirect tag and the address of the array entry will be stored in this indirect.

UNP will exit once column 6 has been reached.

Subroutines Called: ALX - Assign Long Register
ANO - Analyze Address Generating Instruction
for Left Member
CRF - Compile Function Reference
CSR - Compile Subscripted Reference
CXP - Compile Expression

Temporaries/Flags: ARI - Array Reference Count
ICD - Subroutine Reference Tag
IGX - Current Index Assignment
INY - Complete Unpack Indicator
SRI - Subroutine Reference Count
TBP - P Table Parameters
TGI - Indirect Tag
TGT - Temporary Tag
TMF - Start of Array Reference
TOT - Temporary for Unpack
VTA - A Register Associate
VTY - X Register Associate

Tables Referenced: Array Tag (P)
Array Parameters (Q)

Entry/Exit Register Conditions:

Entry: B4 - Location at which Scan should start
Exit: None

WVM - WRITE VARIABLE MAP

This routine is called during the processing of an END card just before the return to the main loop for the next subprogram is made. If there were any program errors, the map is not printed. Otherwise, the Function Name Table, the Statement Number Table, and the Variable Name Table are used to help form the map. The corresponding tag in each table is examined to see if it has been equated to a memory location. If so, the name of the function, the statement number, or the variable name along with its memory location extracted from the J Table entry, is listed. If the tag is not in the J Table, it is ignored.

After all functions, statement numbers, and variable assignments have been listed, the base address of the constants and indirects are converted to display code and listed.

Subroutines Called: PNI - Print Item
 SCM - Scan Table With Masking
 WNX - Write Coded Record

Temporaries/Flags: BAI - Base Address for Indirects
 BAK - Base Address for Constants
 BAT - Base Address for Temporaries
 FLG - Program Error Flag
 MOD - Subprogram Mode
 MPI -
 MPF -
 MPK - Map Headers
 MPN -
 MPT -
 MPV -
 PNM - Program/Subprogram Name
 TBE -
 TBF -
 TBJ - Table Parameters
 TBK -

TBL -

TBM - Table Parameters

TBN -

TMA - Pseudo-Statement Number for Indexed Lists

<u>Tables Referenced:</u>	Function Name	(E)
	Function Tag	(F)
	Argument Name	(J)
	Statement Number	(K)
	Statement Tag	(L)
	Variable Name	(M)
	Variable Tag	(N)

Entry/Exit Register Conditions: None

CHIPPEWA FORTRAN COMPILER - RUN

APPENDIX A

FLOW CHARTS

December, 1965

CHIPPERA FORTRAN COMPILER - RUN

CLEAR CHAIN INDICATOR
CLEAR ERROR INDICATOR

CALL CHK PACKAGE TO PPU
REQUEST OUTPUT FILE STATUS

IS FIELD LENGTH ADEQUATE
FOR COMPILATION?

STOP

YES

INITIALIZE FOR INPUT/OUTPUT

TRANSFER RECORD FROM
CIRCULAR BUFFER TO CARD
BUFFER

INITIALIZE PROGRAM TABLES

INITIALIZE SUBPROGRAM
TABLES

IS THIS A BINARY DECK ?
(+ OR - IN COLUMN 1)

YES

PROCESS END STATEMENT

ASSEMBLE STATEMENT FROM
CARD BUFFER IN STRING
BUFFER

ARE THERE MULTIPLE
STATEMENTS ON THIS CARD ?

NO

YES

REPLACE \$ IN STRING BUFFER
WITH END OF STATEMENT
INDICATOR (ZERO WORD)

SET FUNCTION TYPE
BLANK OUT THIS PORTION OF
STRING

B

ASSEMBLE NEXT 7 LETTERS

ARE LETTERS "ASCENTF" ?

YES

NO

SET SUBPROGRAM MODE
INDICATOR TO -2

B

ARE LETTERS "MACHINE" ?

YES

NO

SET SUBPROGRAM MODE
INDICATOR TO -1

B

ARE LETTERS "FORTRAN" ?

YES

NO

ASSEMBLE NEXT 2 LETTERS

SET SUBPROGRAM MODE
INDICATOR TO 1
ARE LETTERS "II" ?

YES

NO

B

SET SUBPROGRAM MODE
INDICATOR TO 0
ARE LETTERS "IV" ?

YES

NO

B

SET SPECIAL MODE INDICATOR
ARE LETTERS "VI" ?

YES

NO

B

NAME CARD ERROR

SAVE SUBPROGRAM TYPE
SAVE CURRENT PROGRAM -
SUBPROGRAM INDICATOR

IS THIS THE FIRST PROGRAM
OR SUBPROGRAM ?

YES

NO

SET PROGRAM MODE INDICATOR
EQUAL TO SUBPROGRAM MODE
INDICATOR

SAVE PROGRAM TYPE
SET PROGRAM/SUBPROGRAM
INDICATOR

IS THIS STATEMENT LISTED
IN PROGRAM TITLE TABLE ?

NO

C

NEXT PAGE

IS THE FIRST LETTER OF
THIS STATEMENT AN "R" ?

YES

NO

IS THE FIRST LETTER OF
THIS STATEMENT A "D" ?

NO

YES

ASSEMBLE FIRST 10 LETTERS

IS THIS STATEMENT
"DOUBLEPREC" ?

YES

NO

ASSEMBLE LETTERS

IS THIS STATEMENT LISTED
IN THE TITLE TABLE ?

NO

B

IS THIS STATEMENT
"DOUBLE" ?

YES

NO

NAME CARD ERROR

RUN

A-1

A

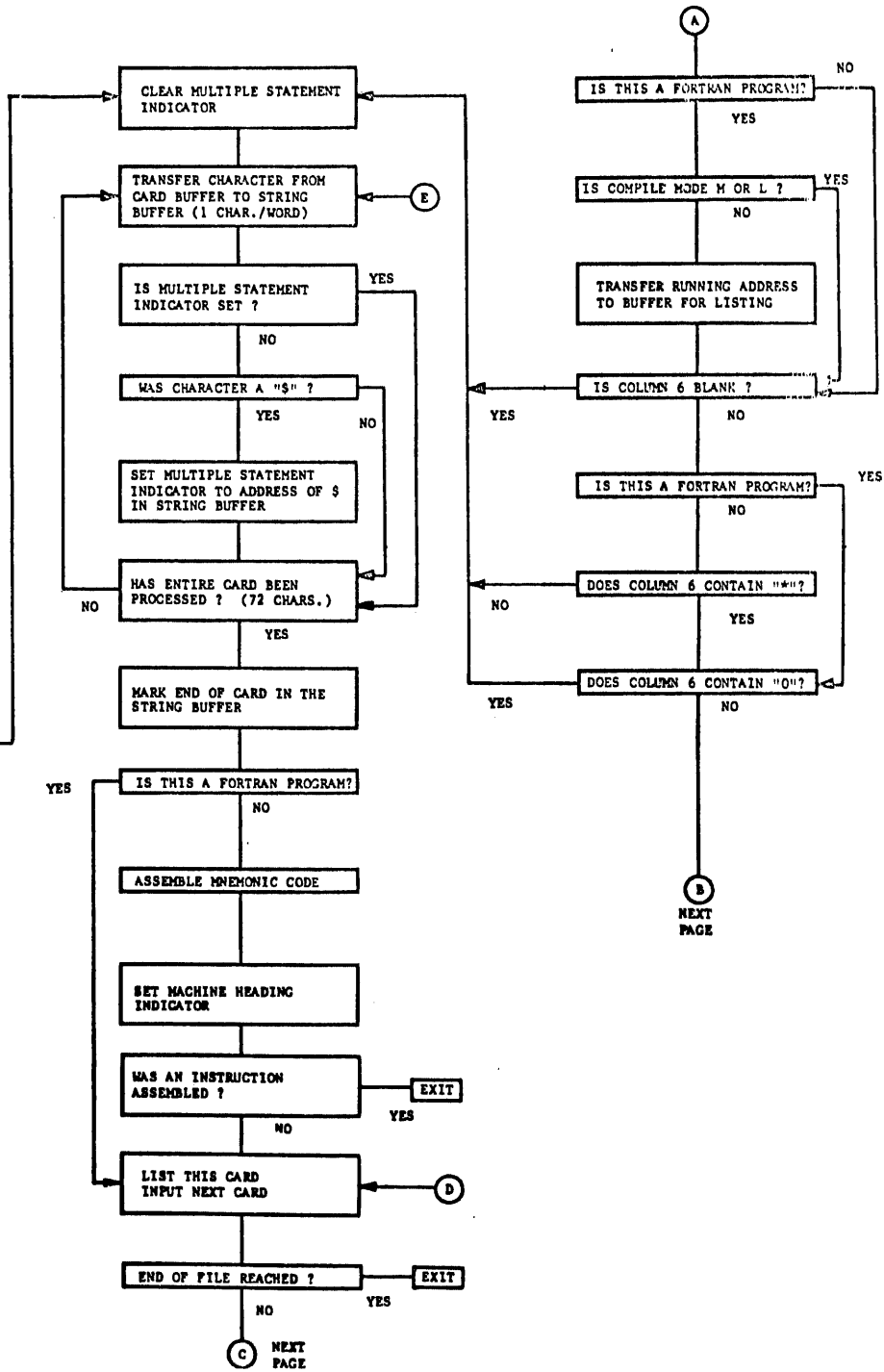
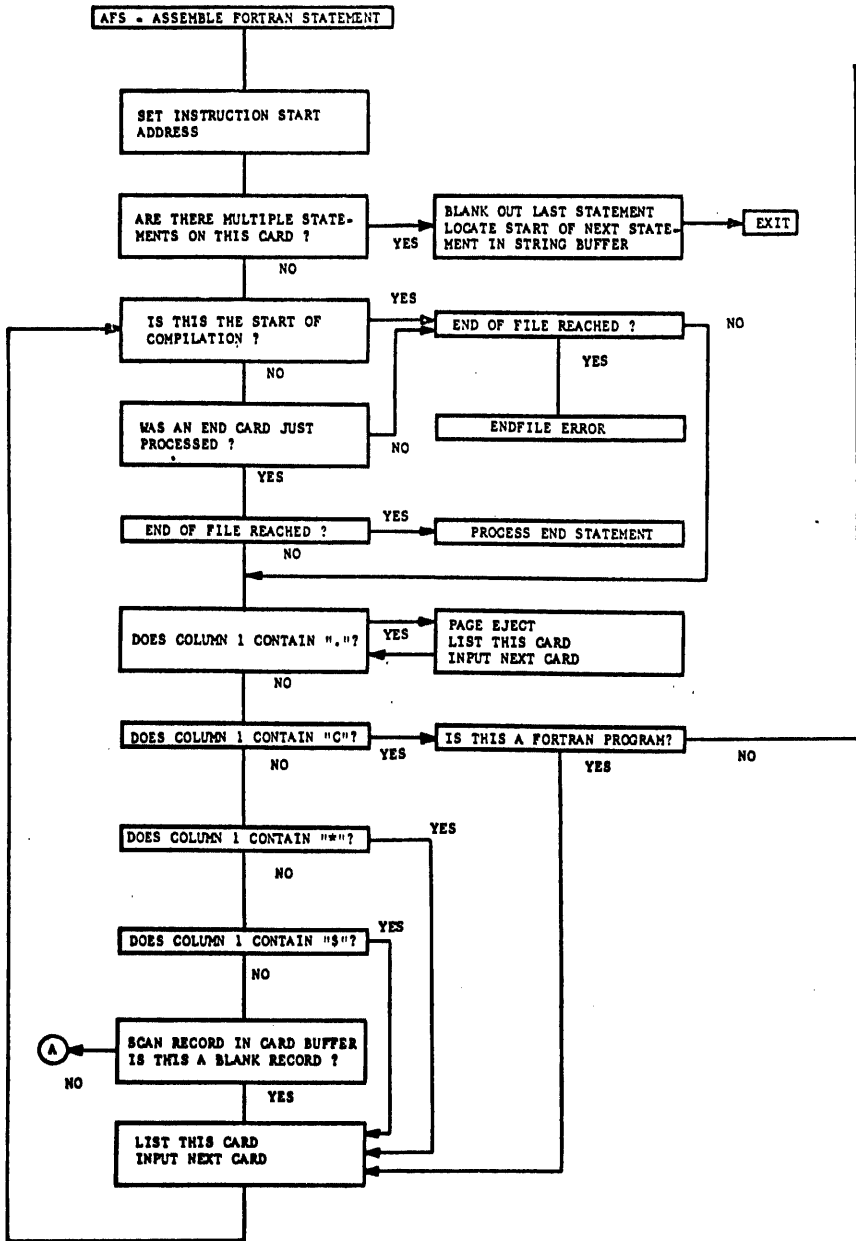

PREVIOUS PAGE

(C)

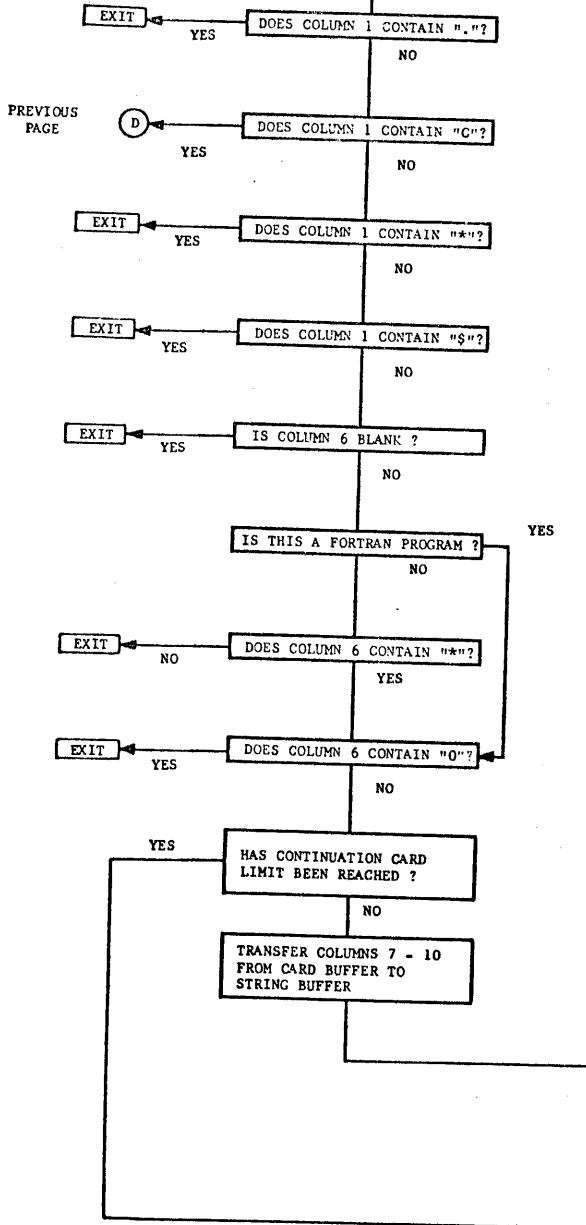

FROM PREVIOUS PAGE

(B)

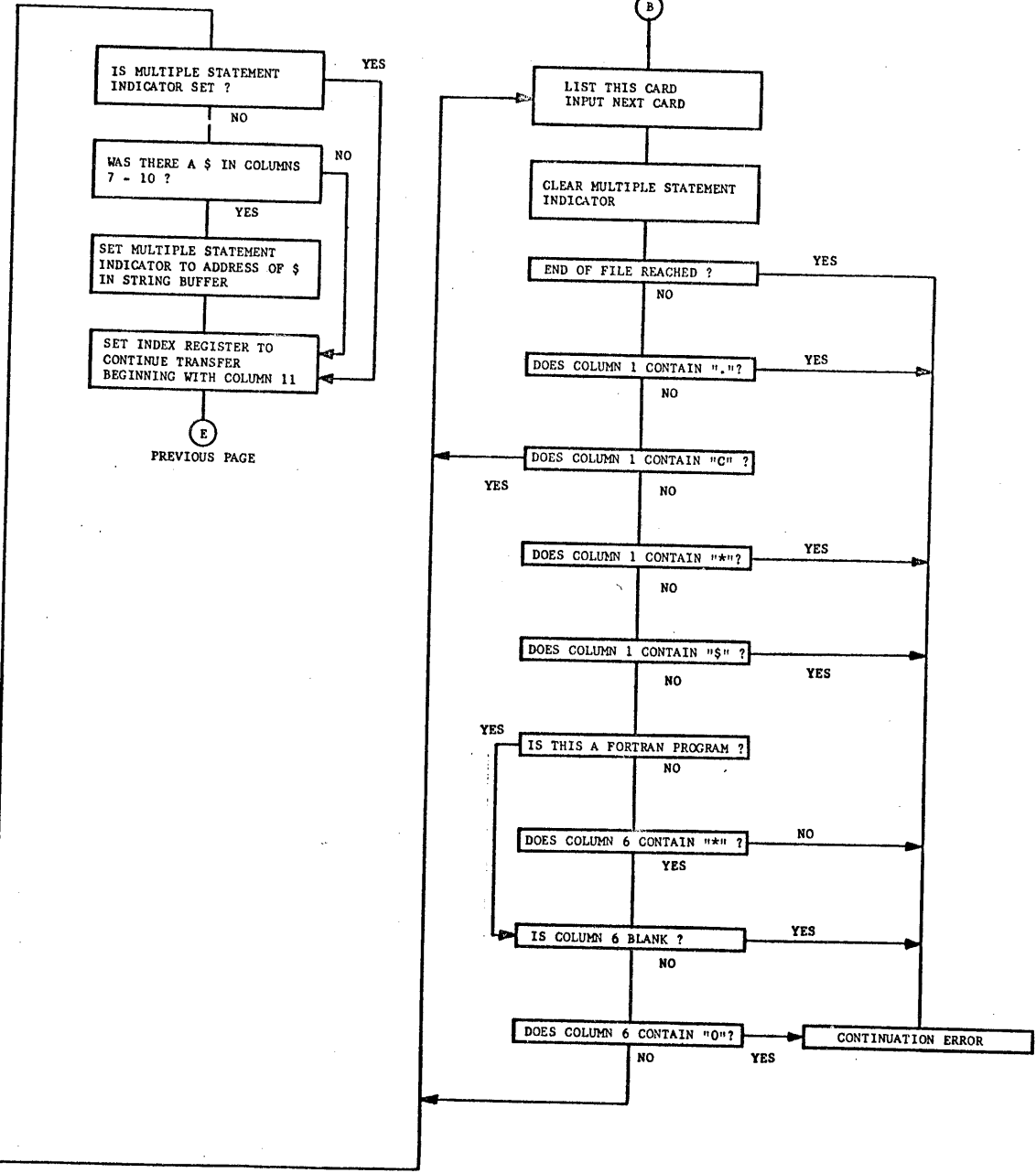

PREVIOUS PAGE

(E)

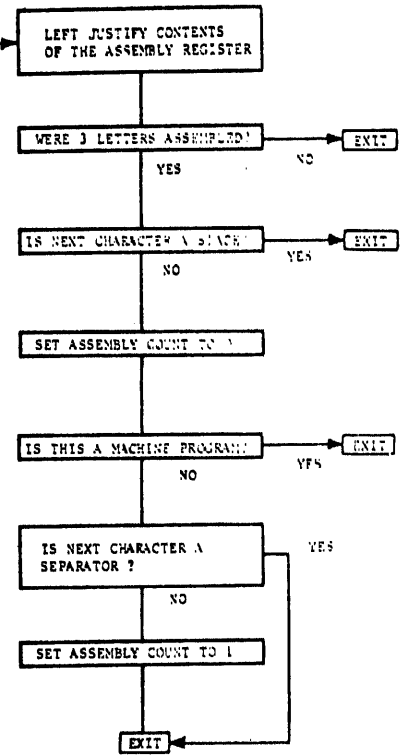
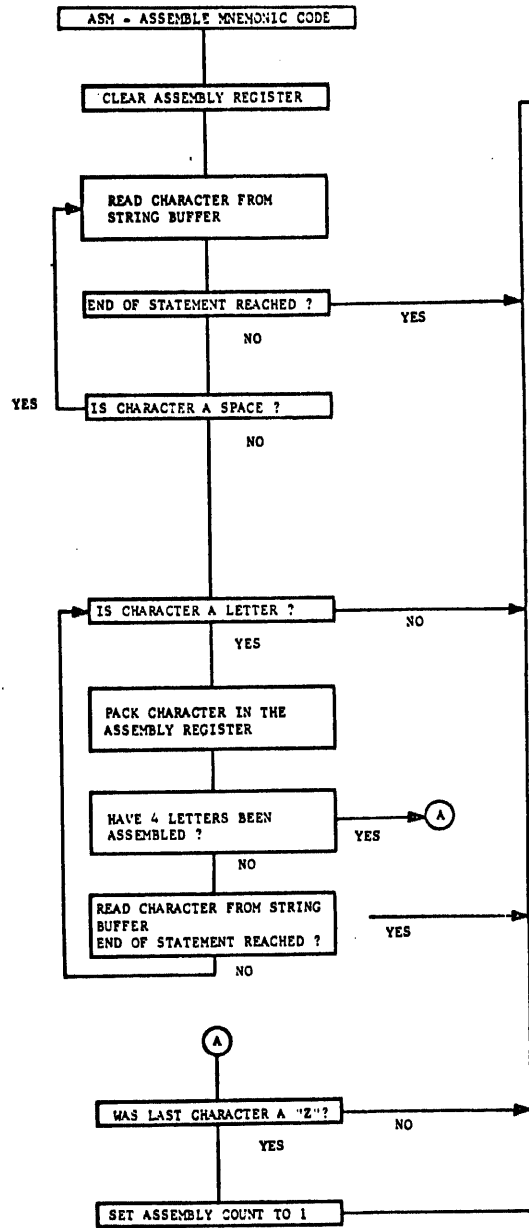
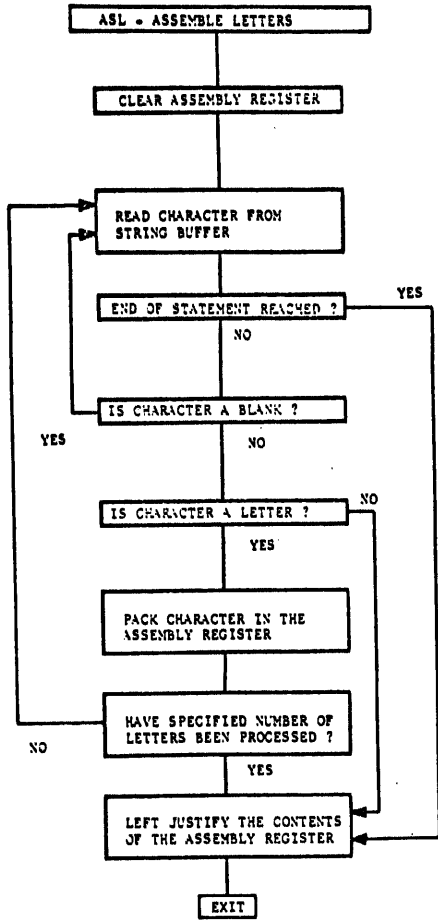

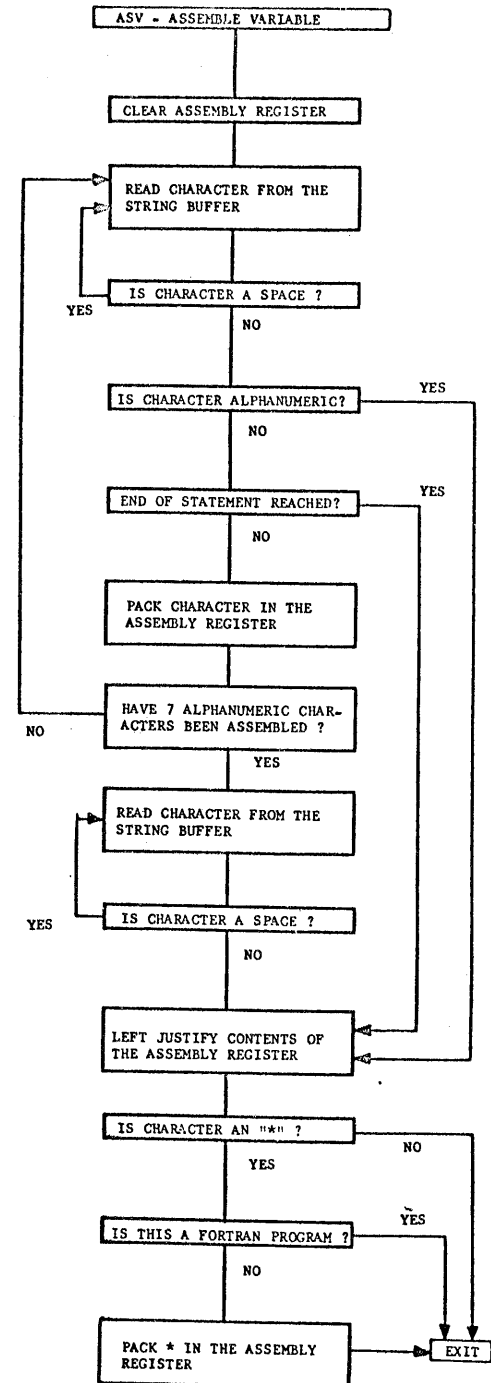
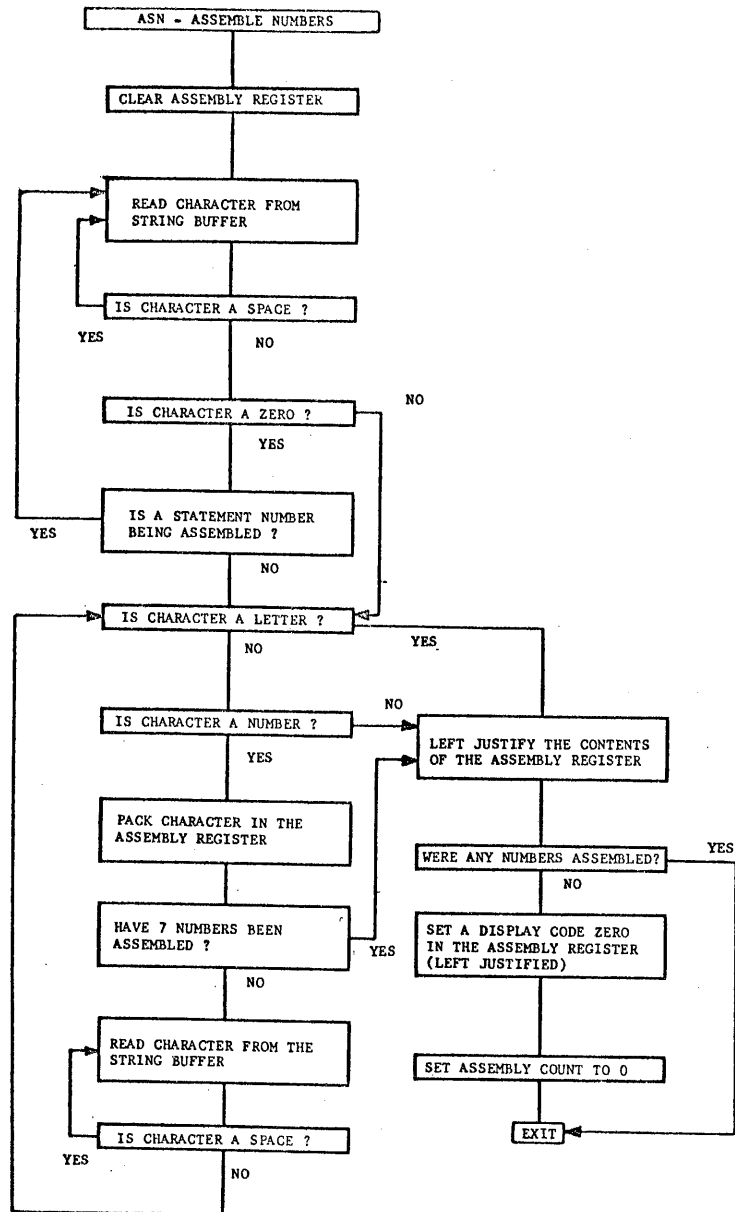

CDI - COMPILER DØ INITIAL INSTRS.

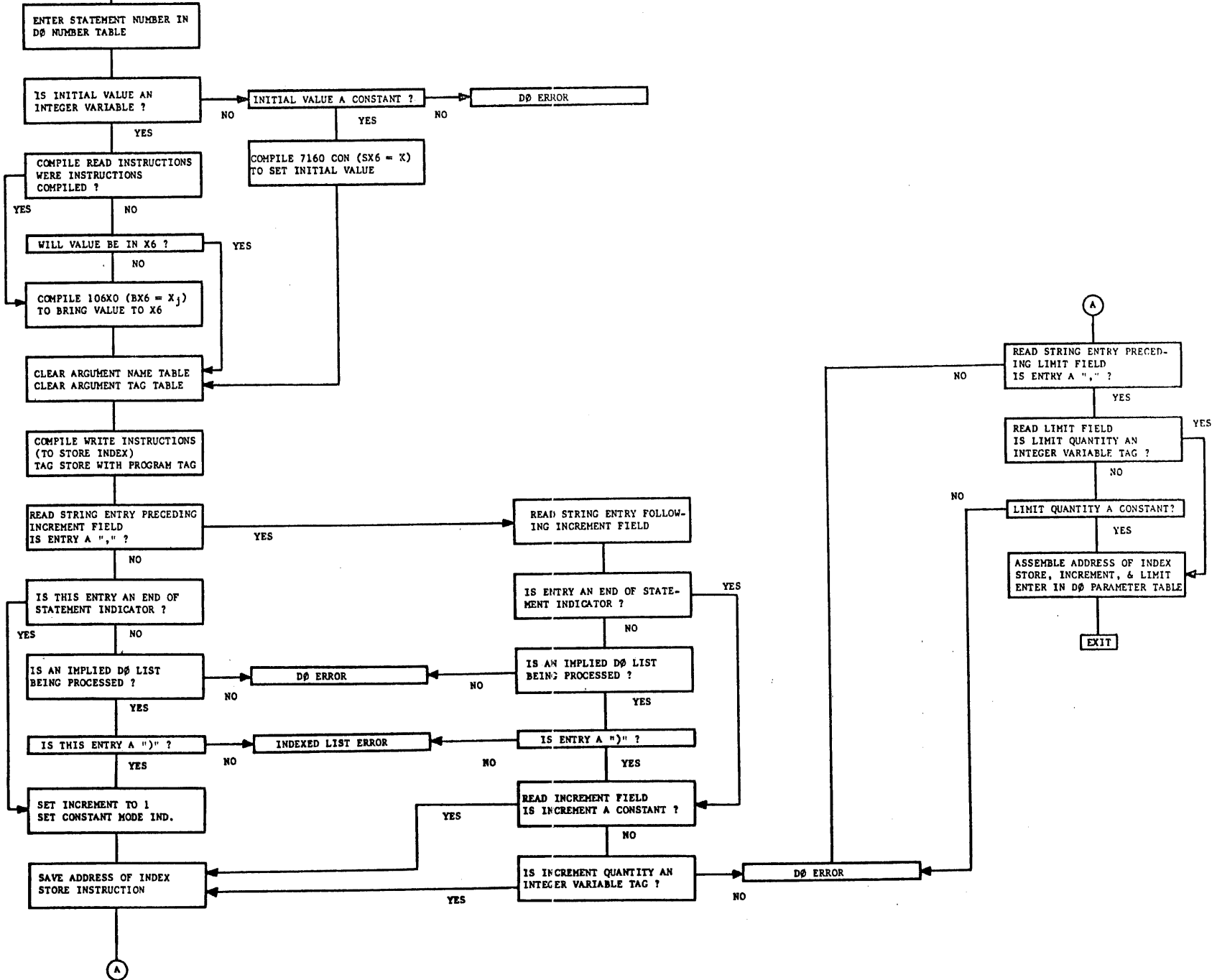

A-7

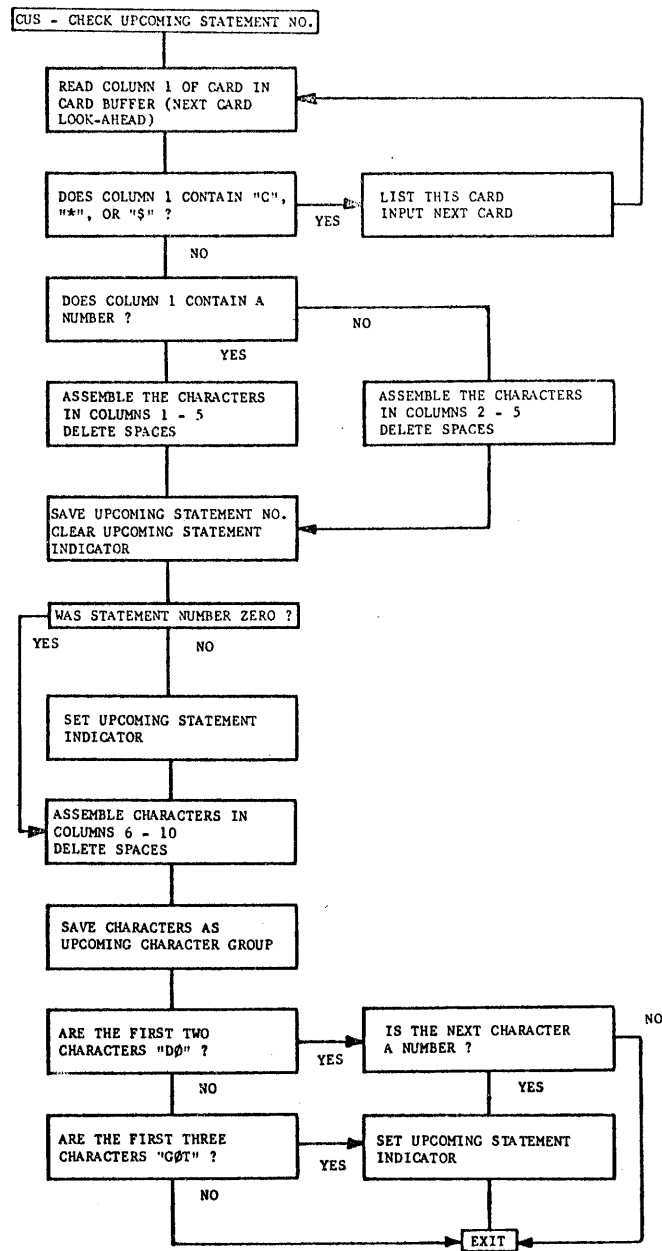
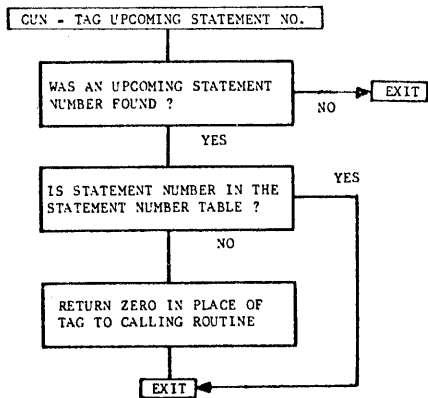
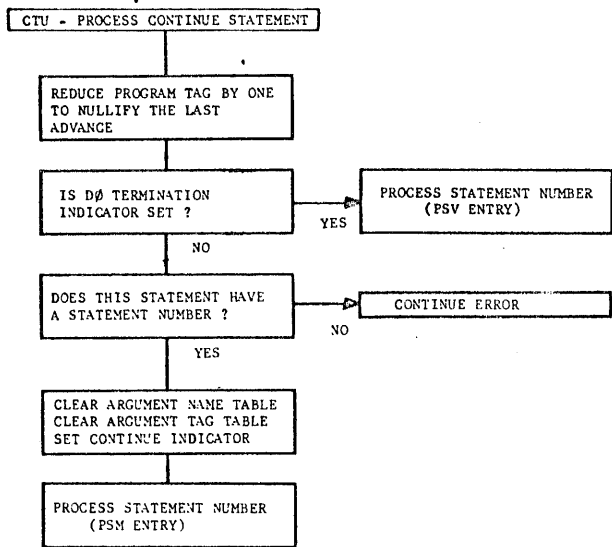

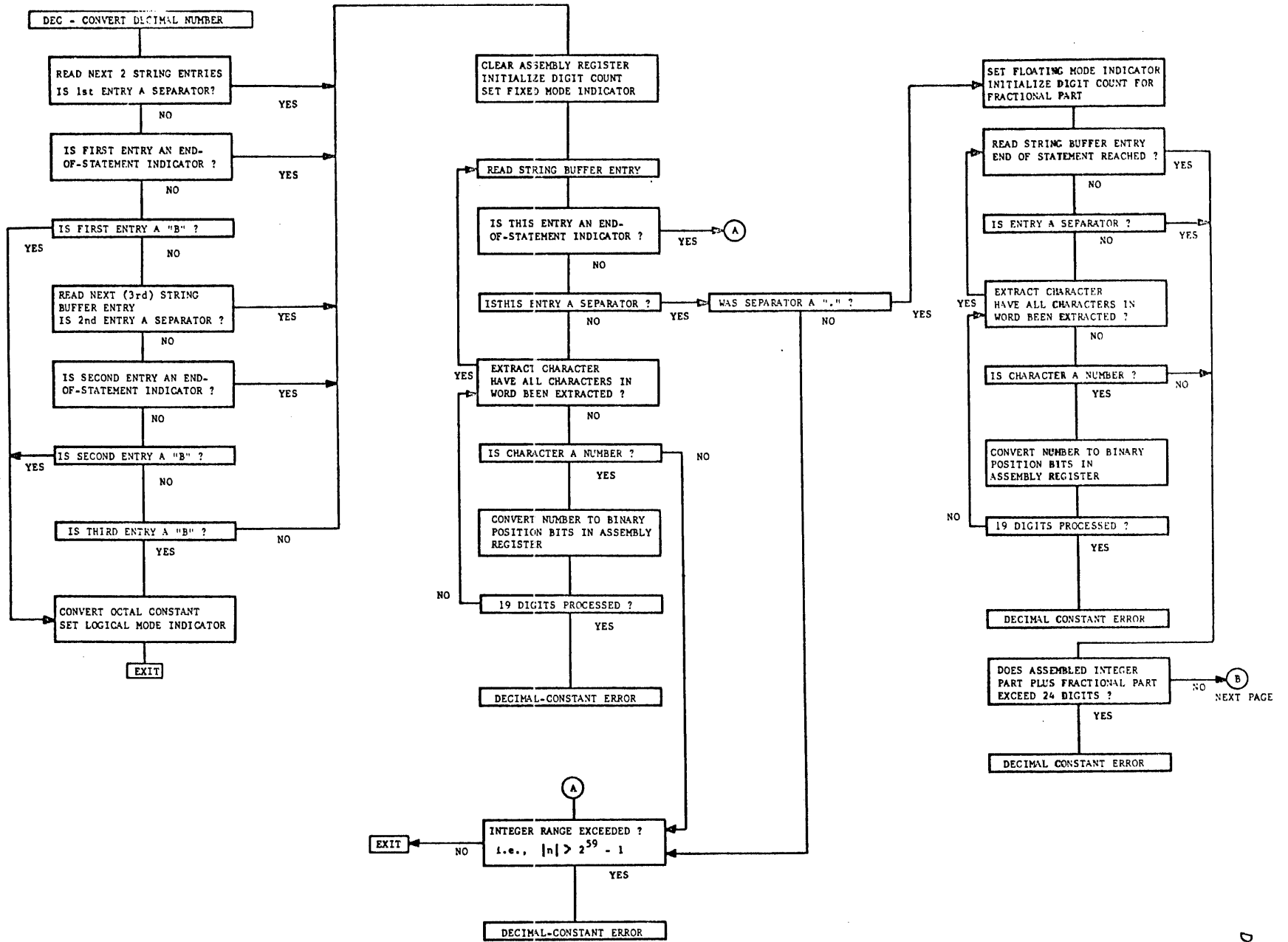

FROM PREVIOUS PAGE

(B)

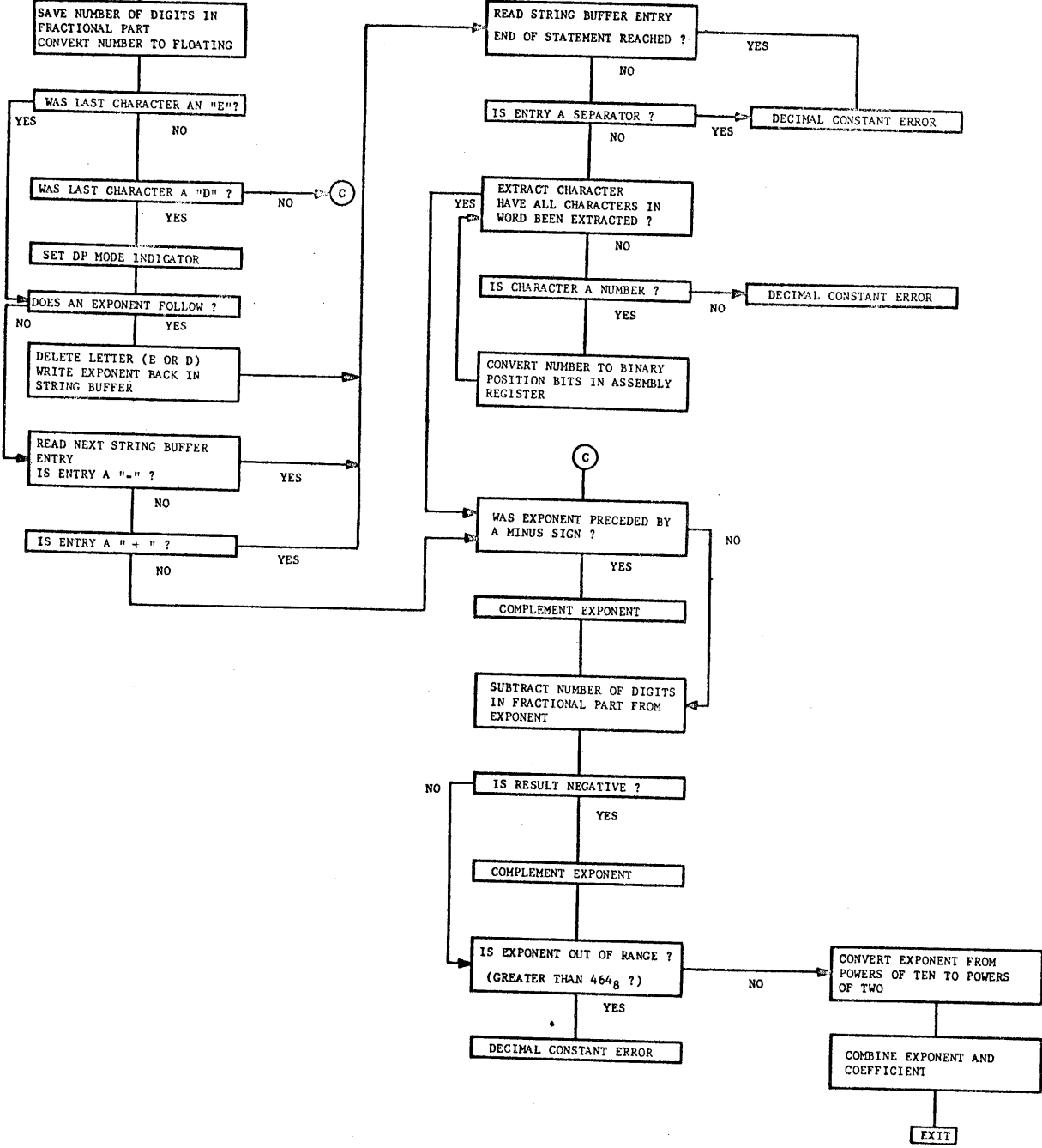

A-10

DEC

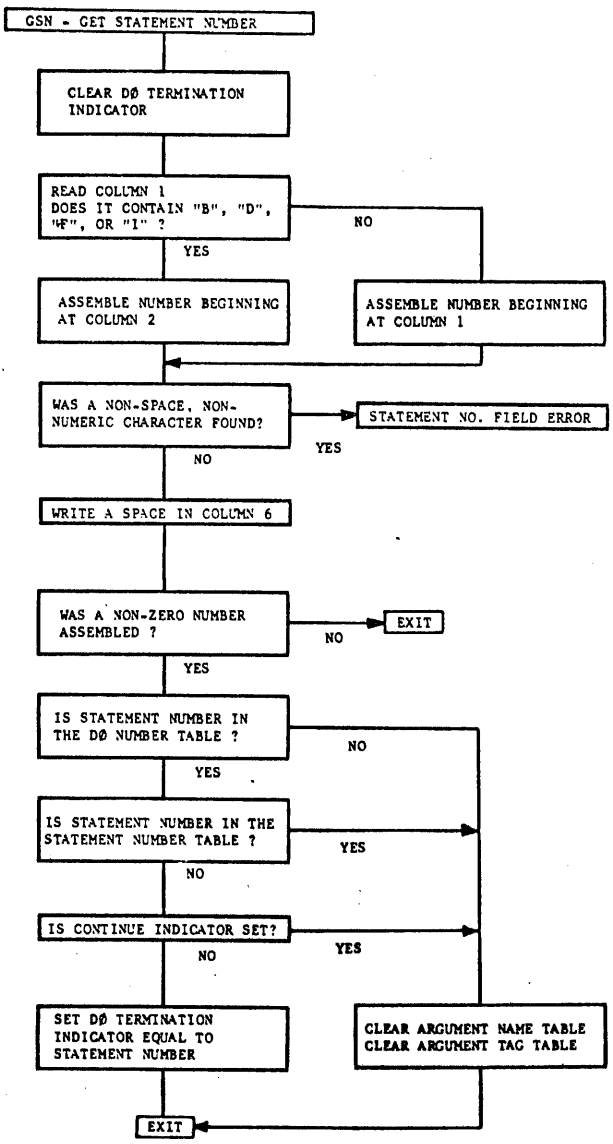

A-11

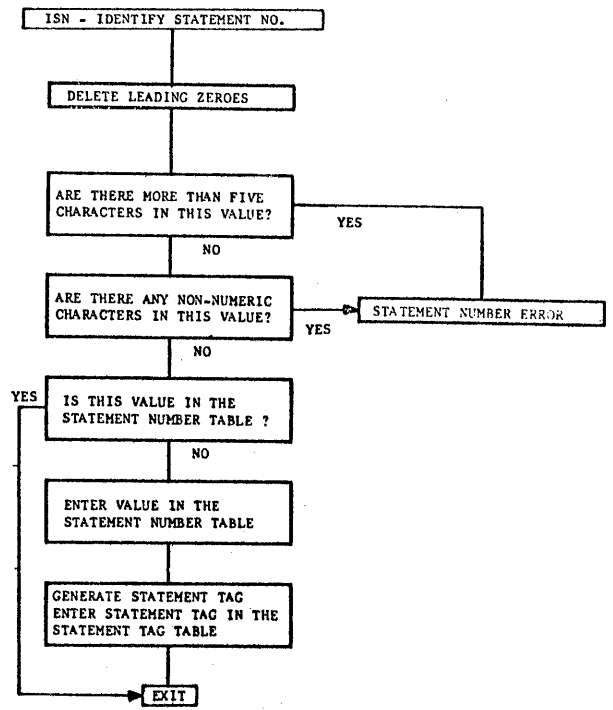
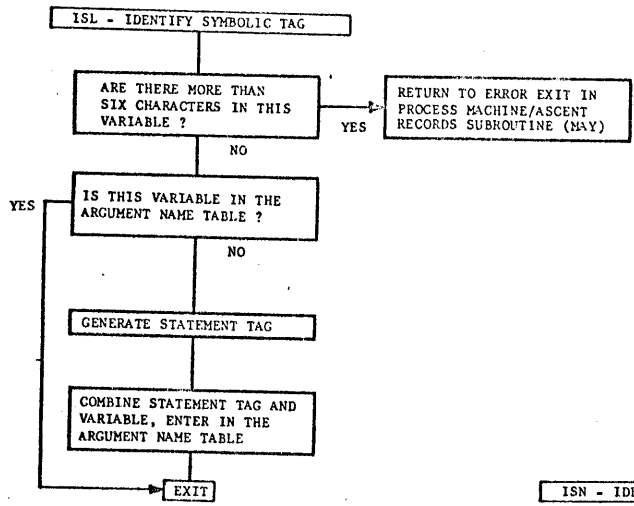
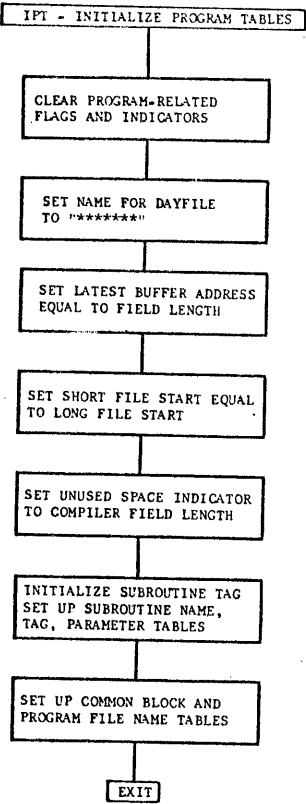

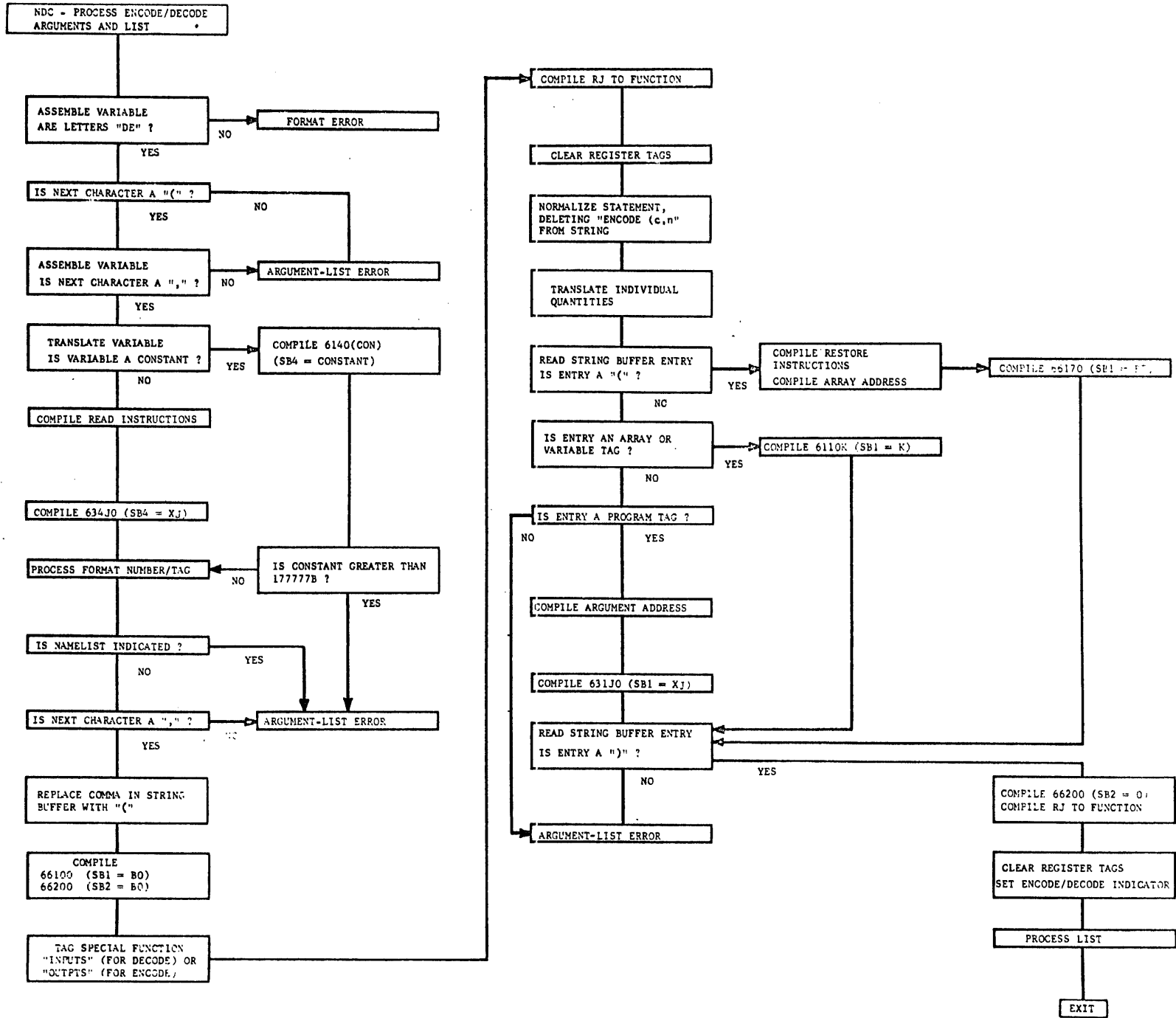

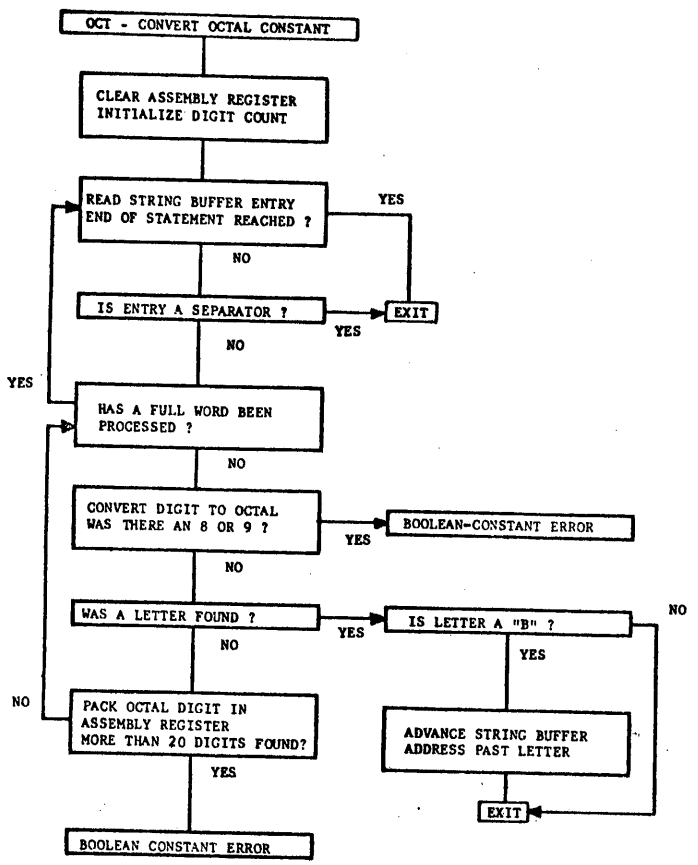

A-14

OCT

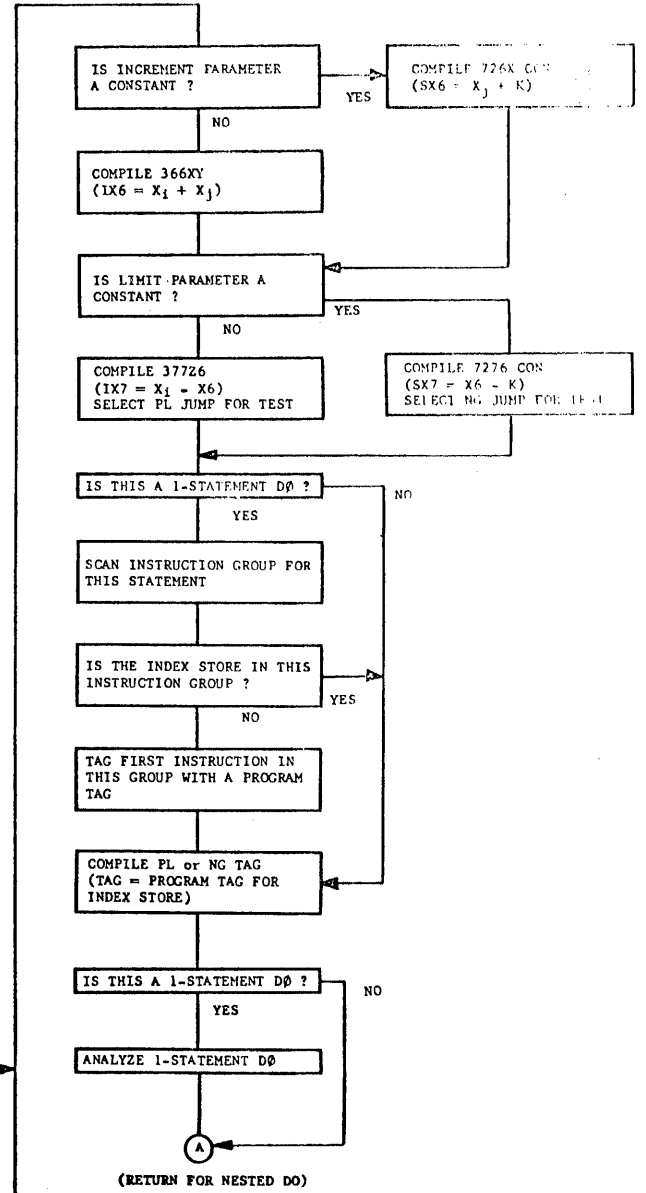
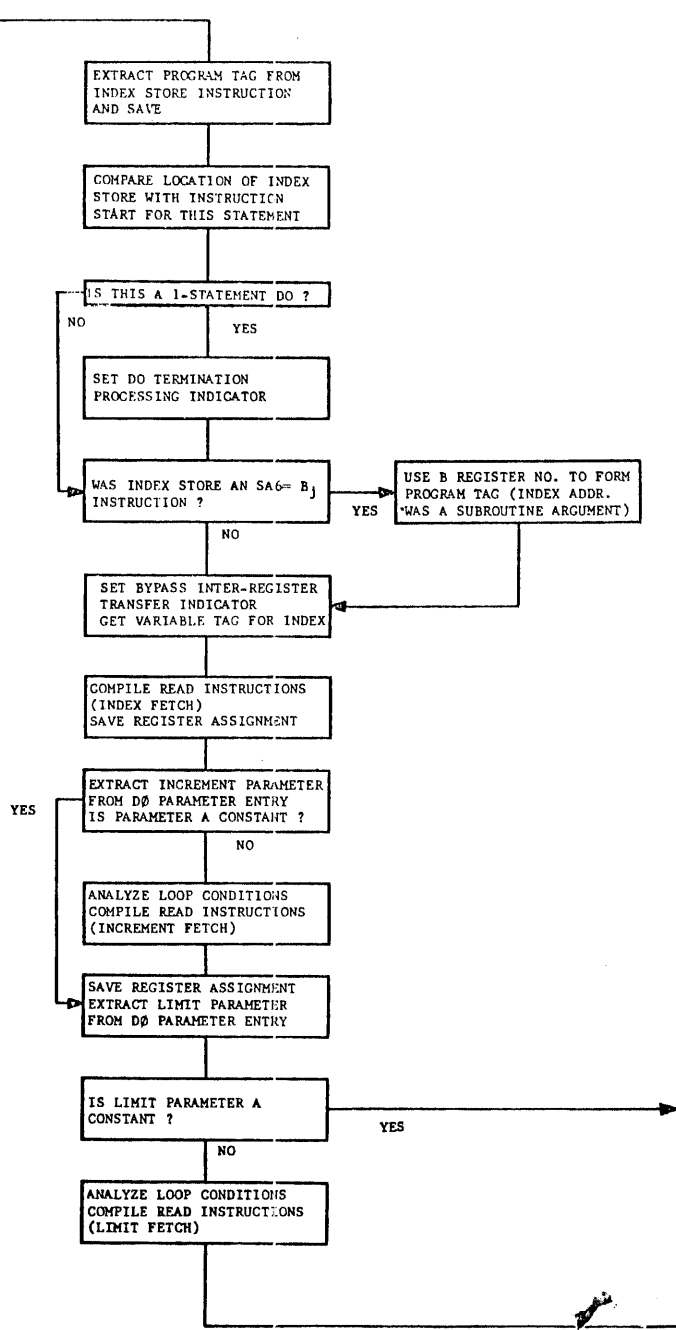
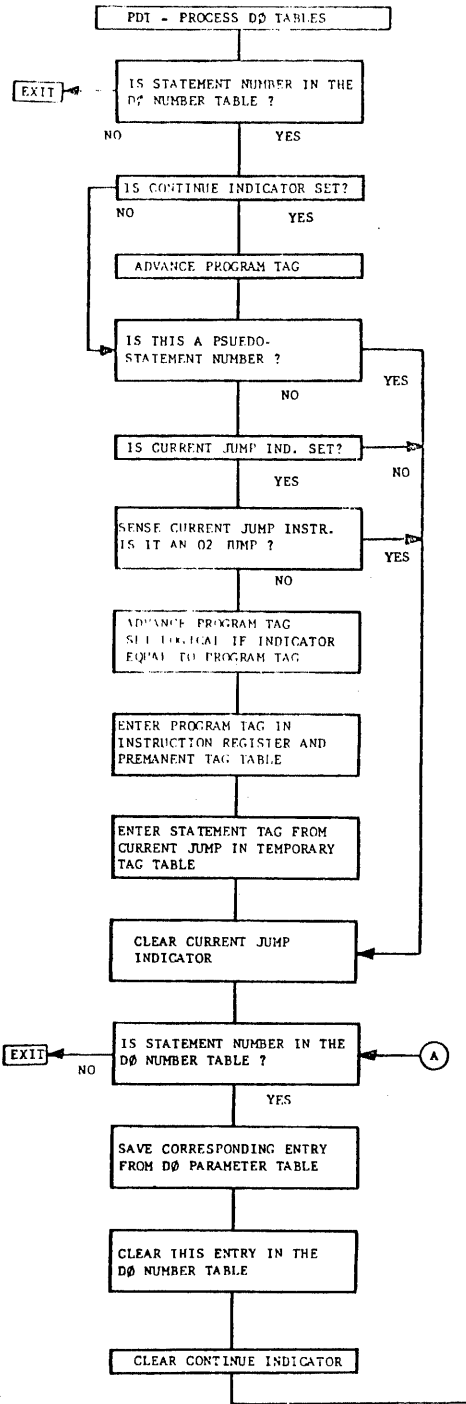

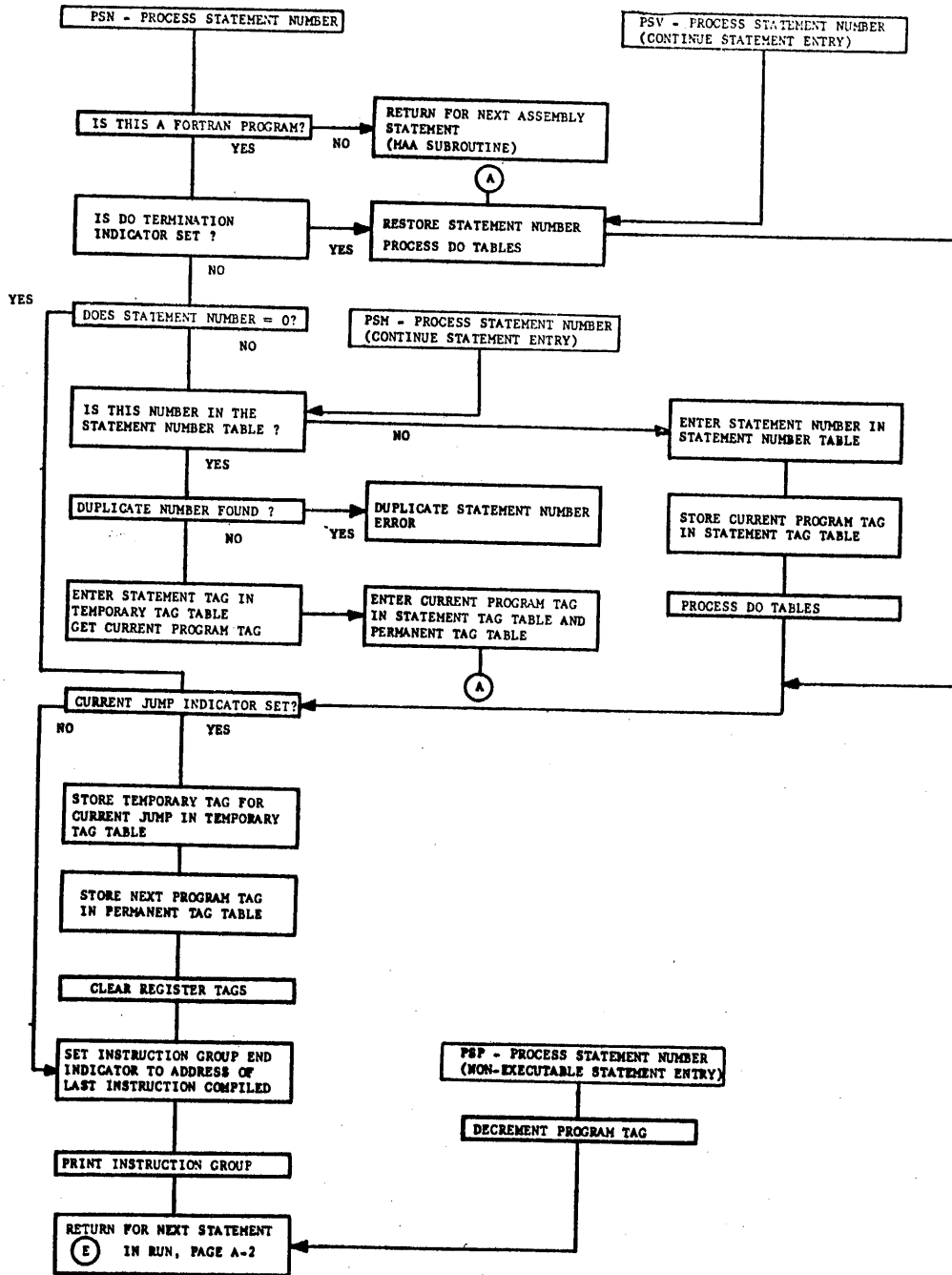

PSN (PSN), (PSM), (PSV)

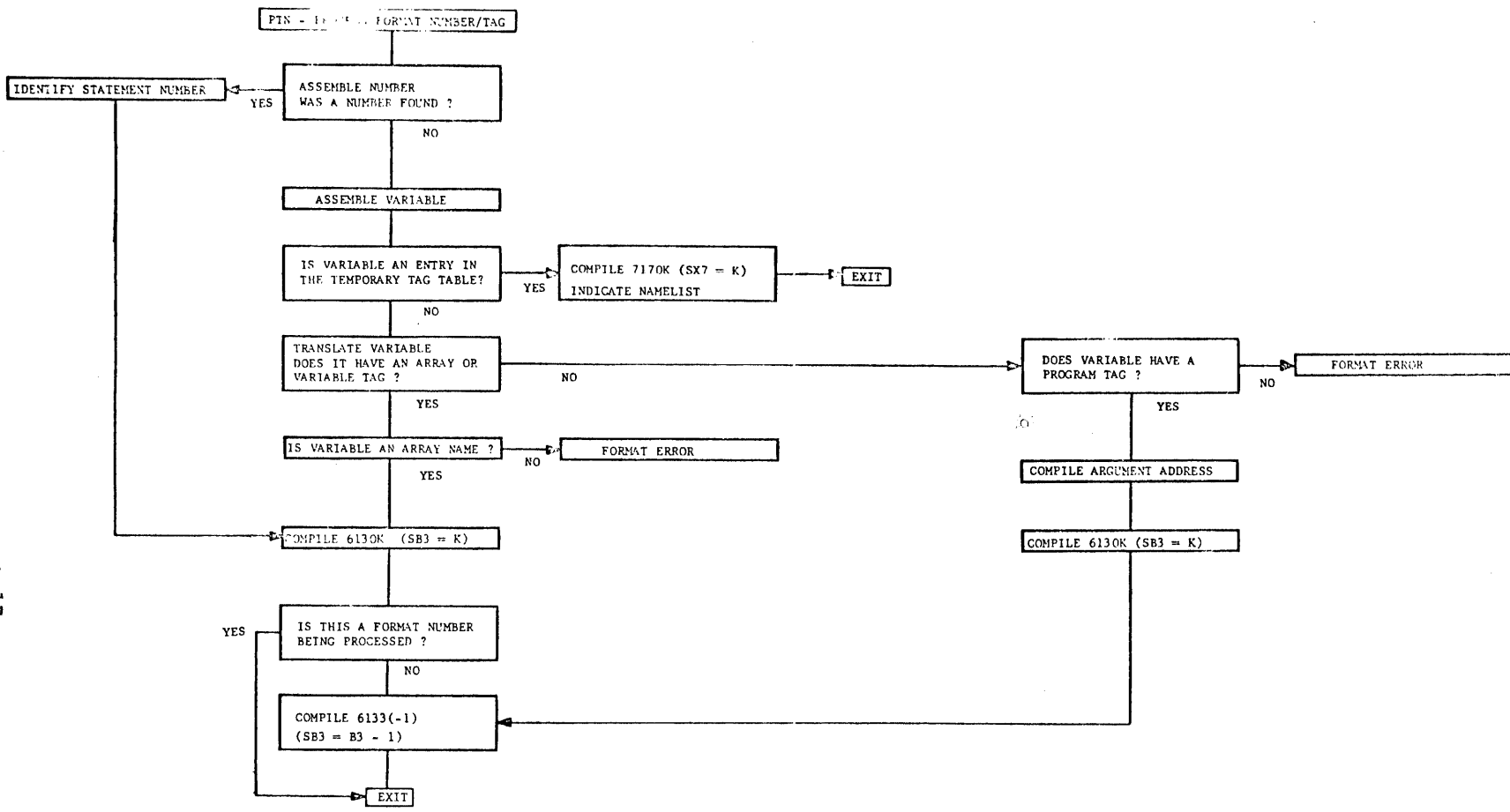

A-17

PTN

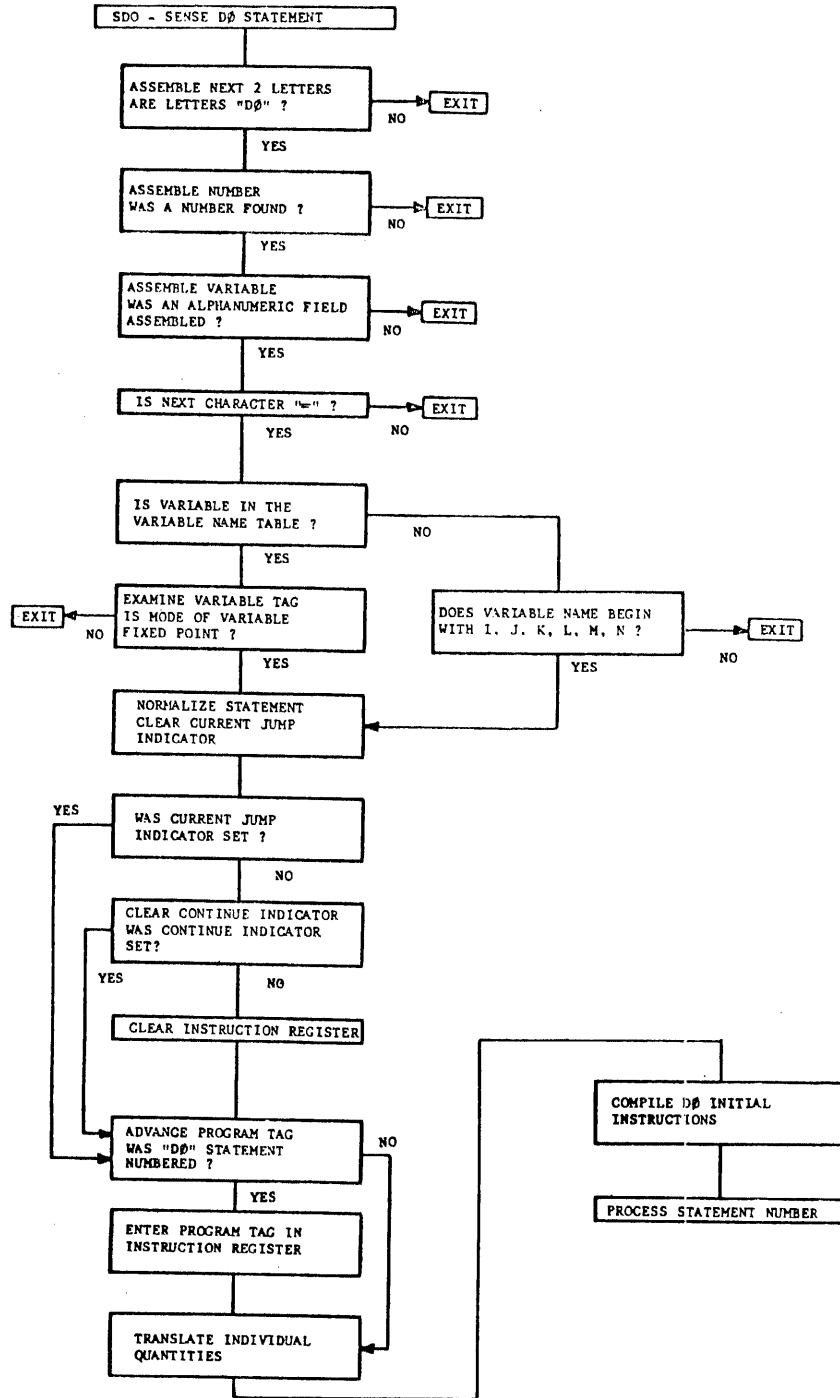

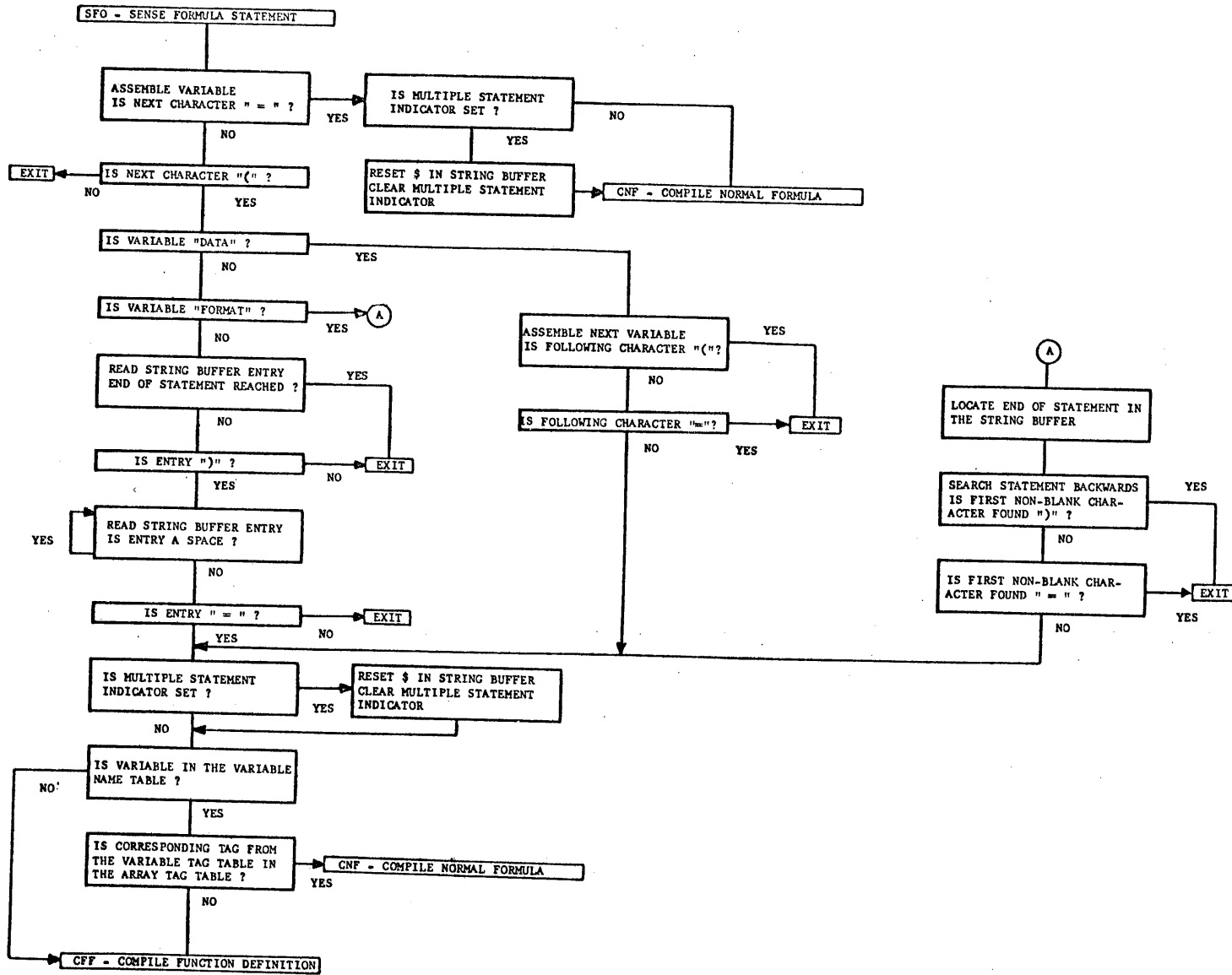

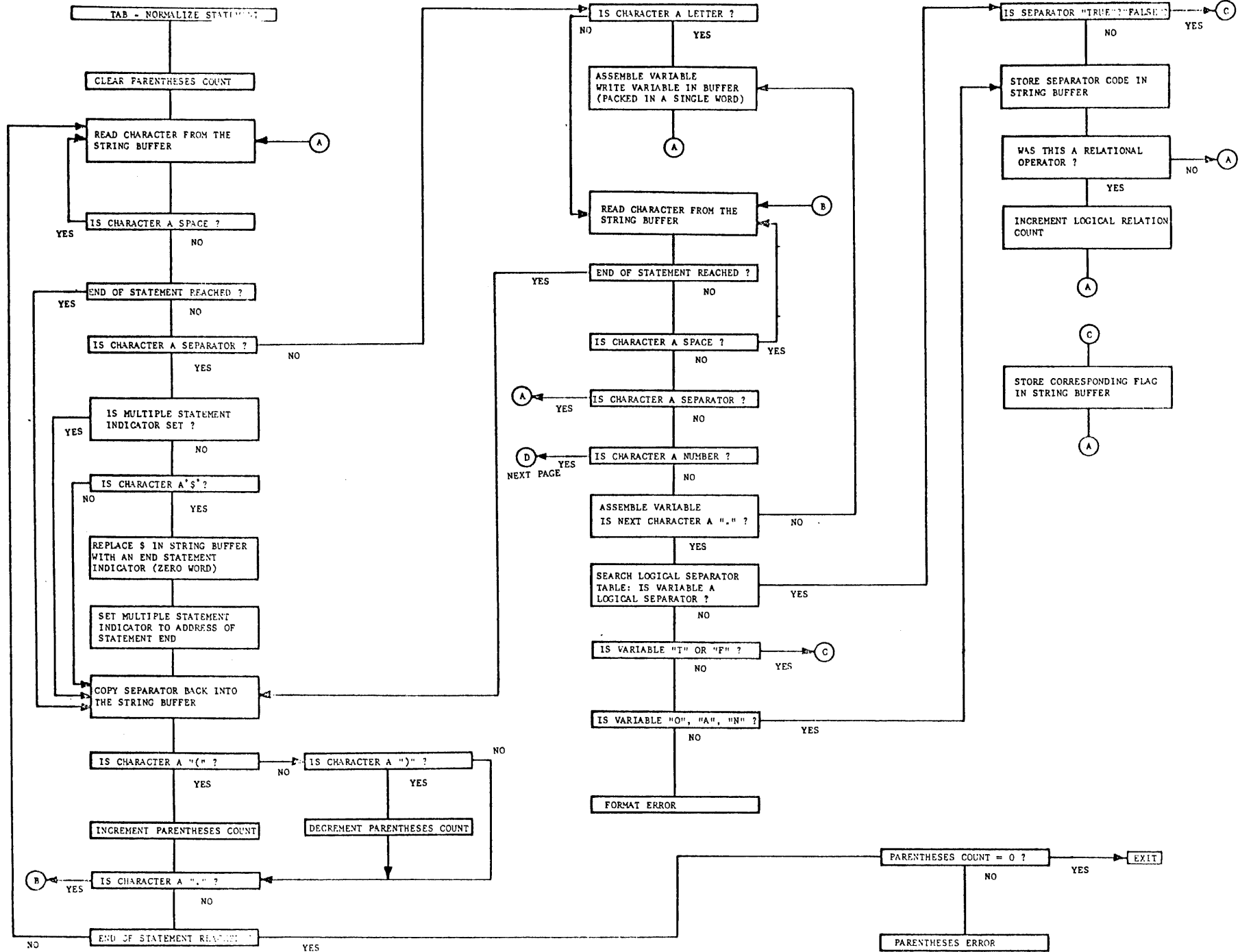

FROM PREVIOUS PAGE

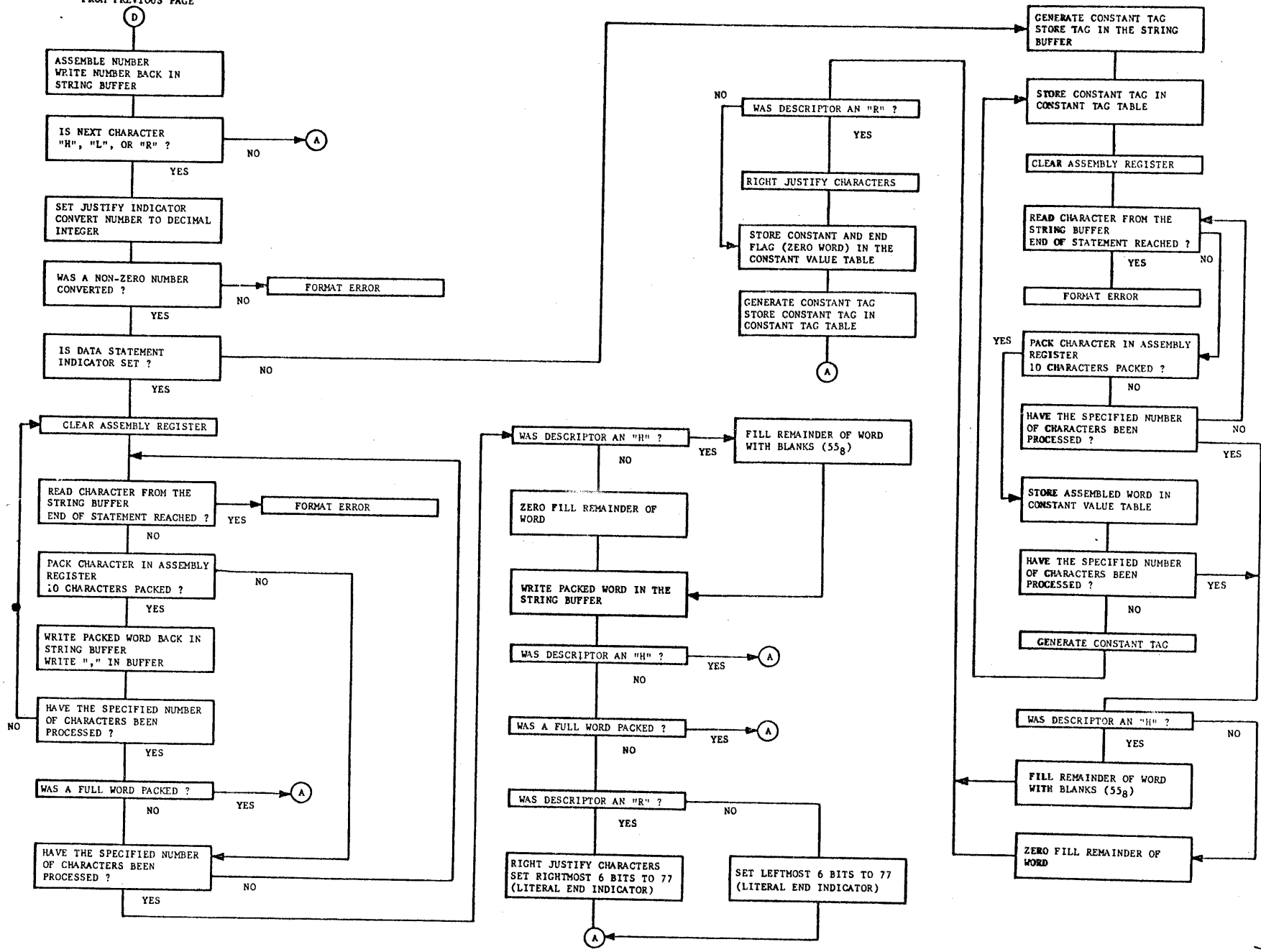

A-22

TAB

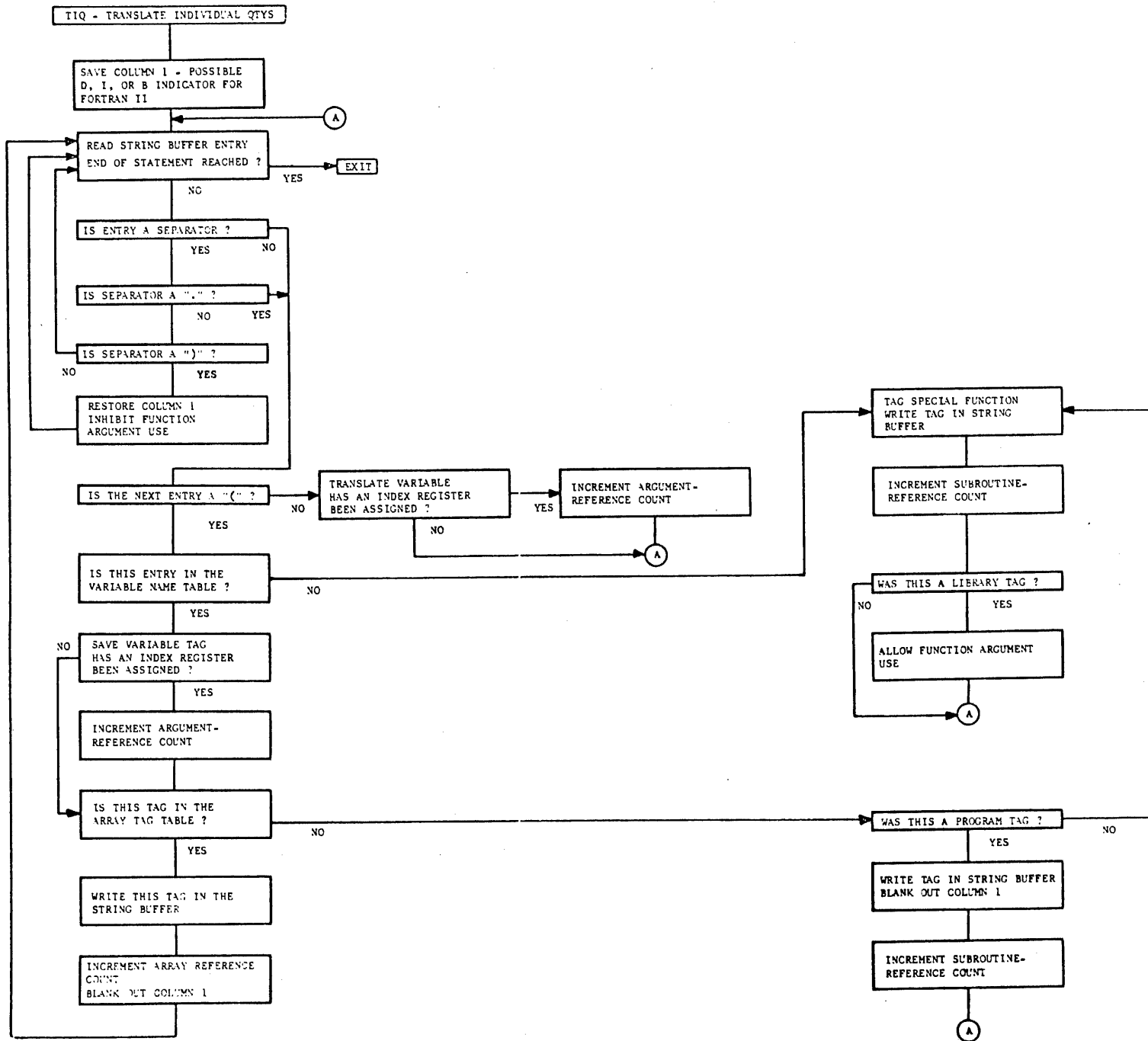

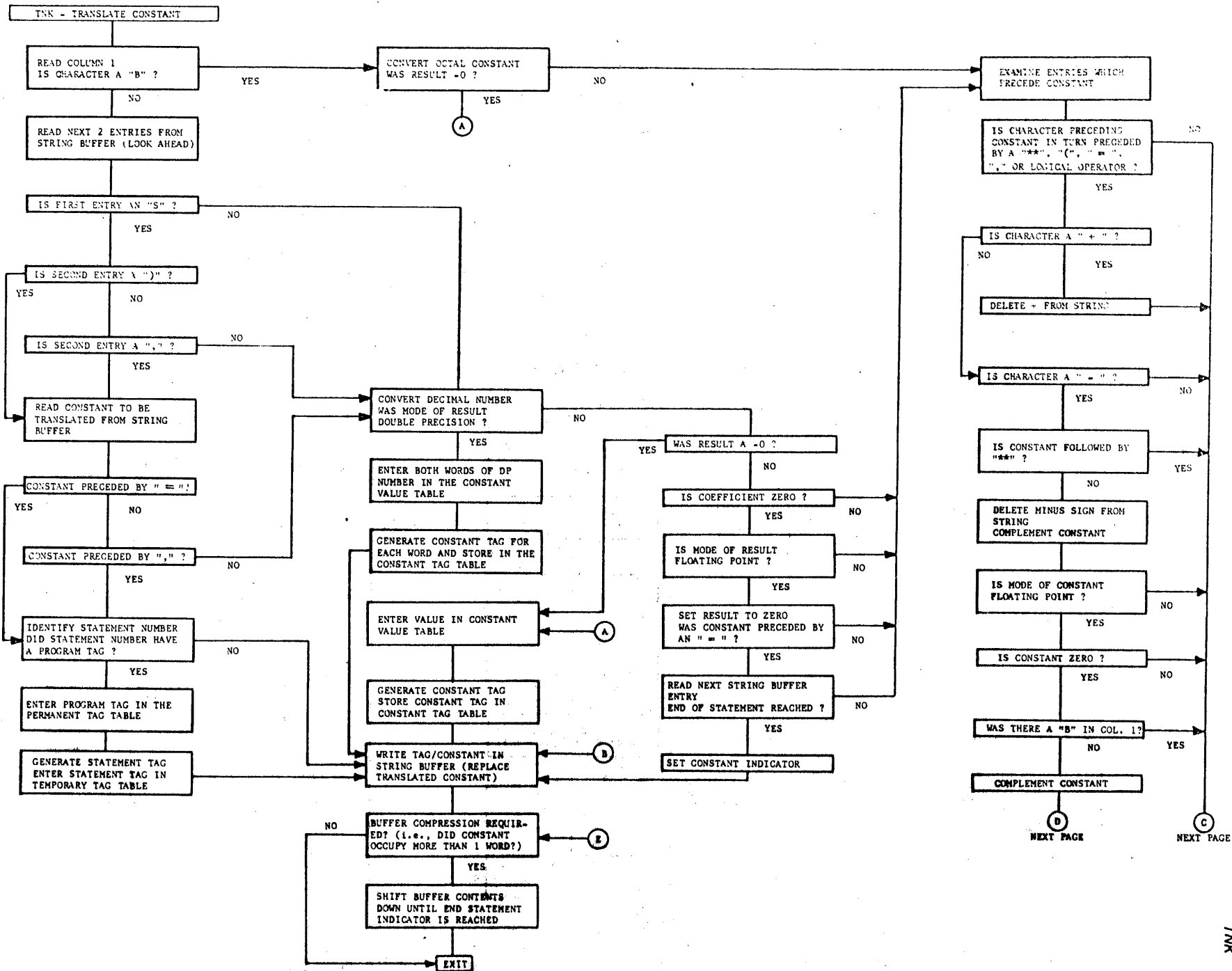

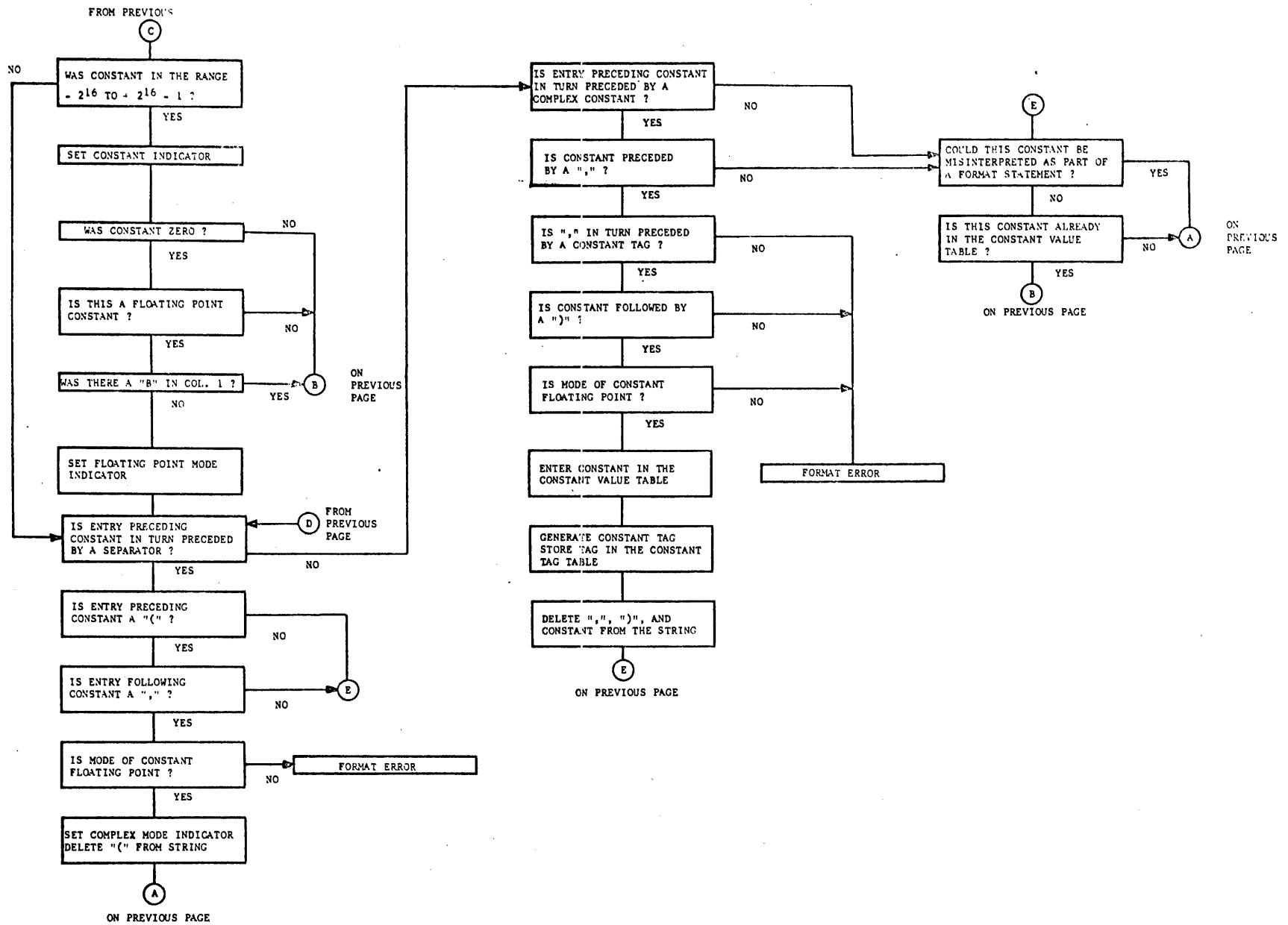

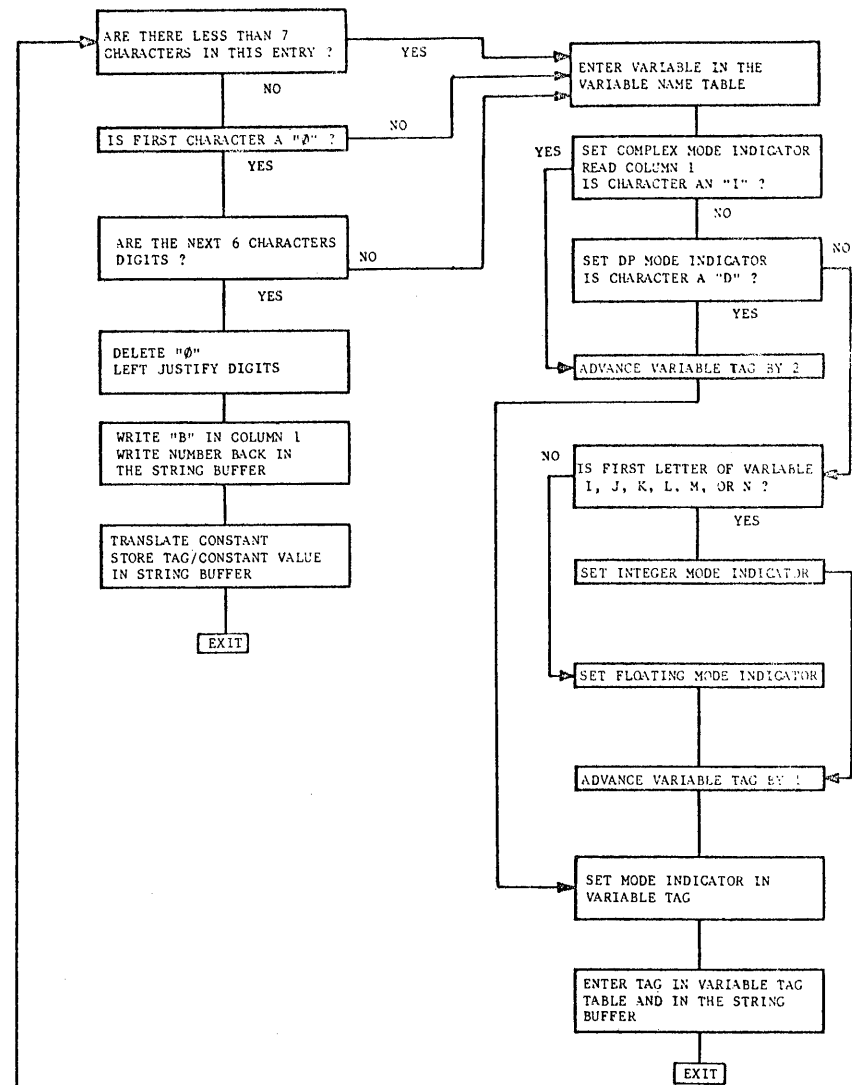
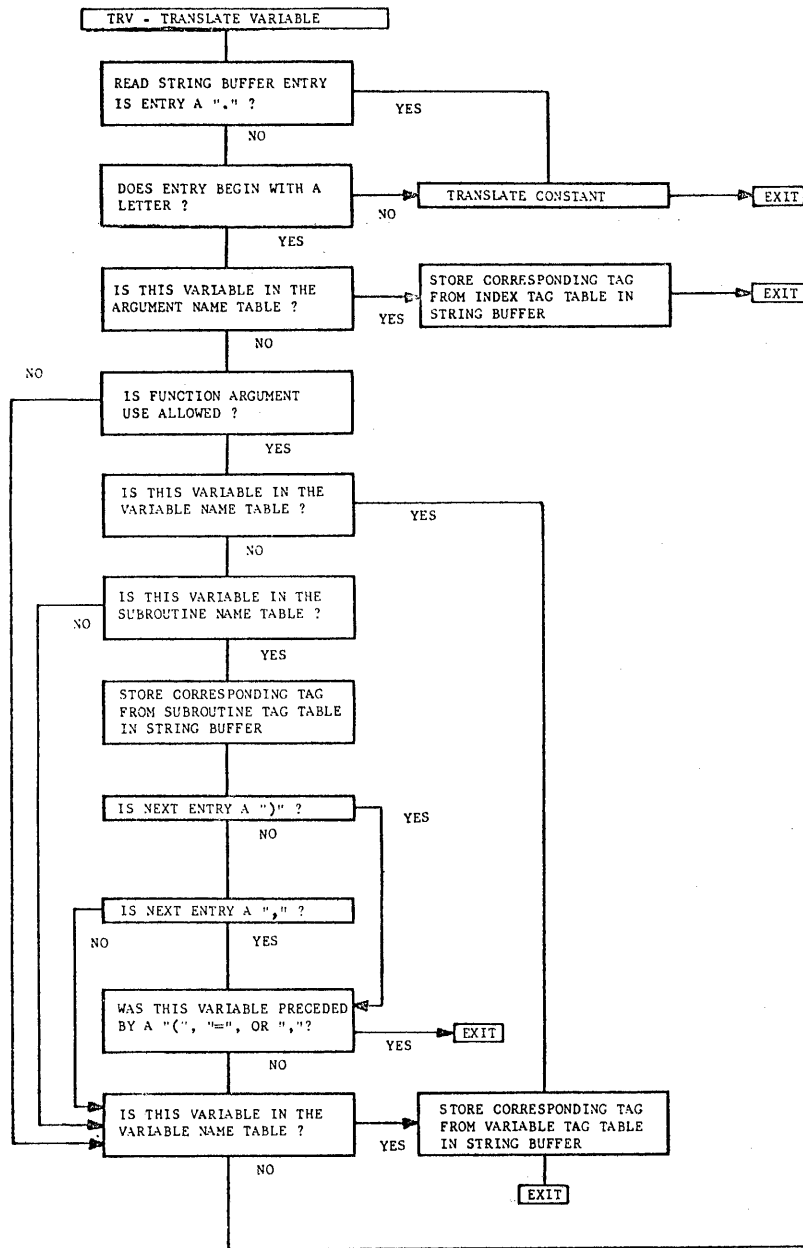

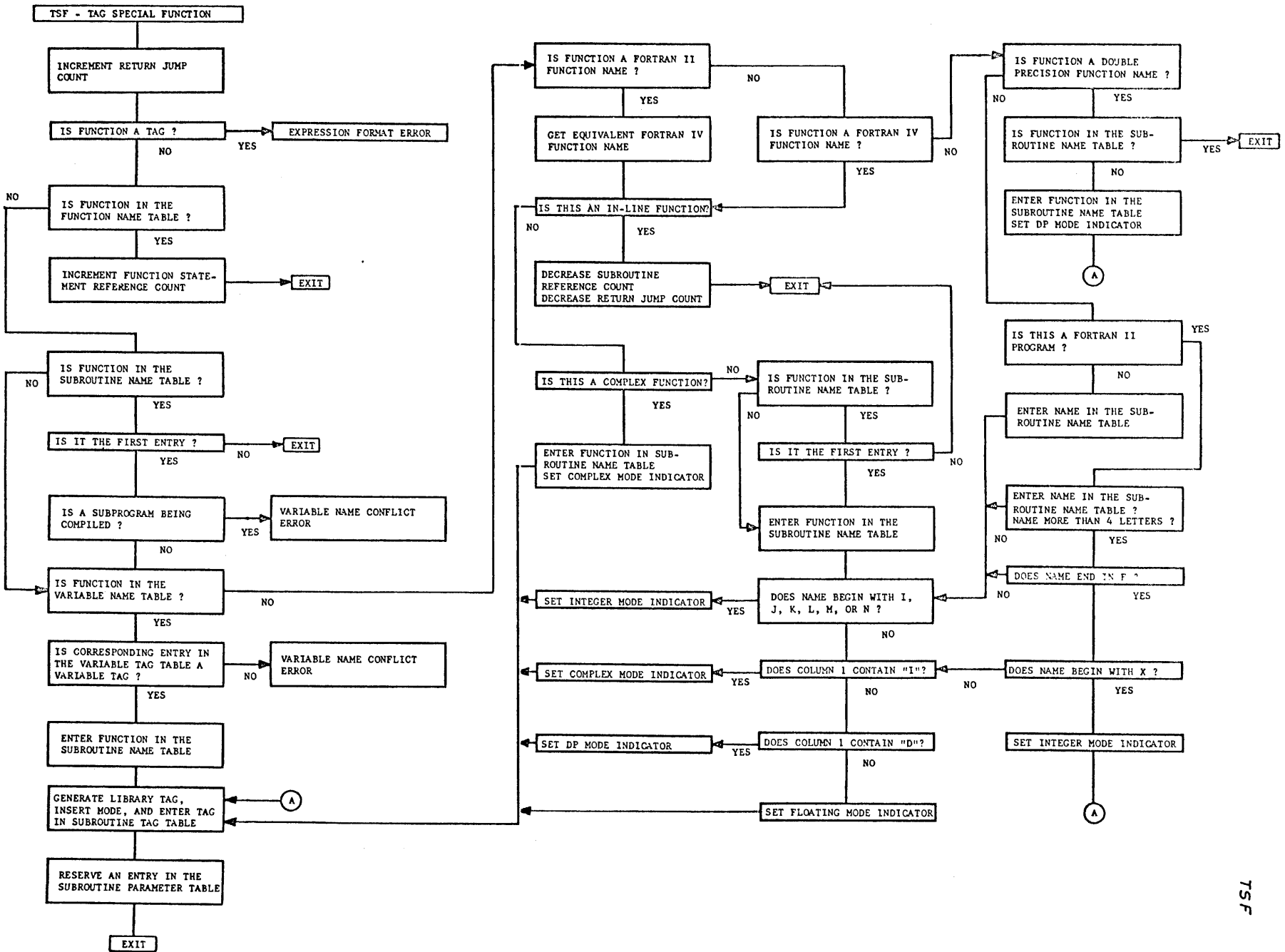

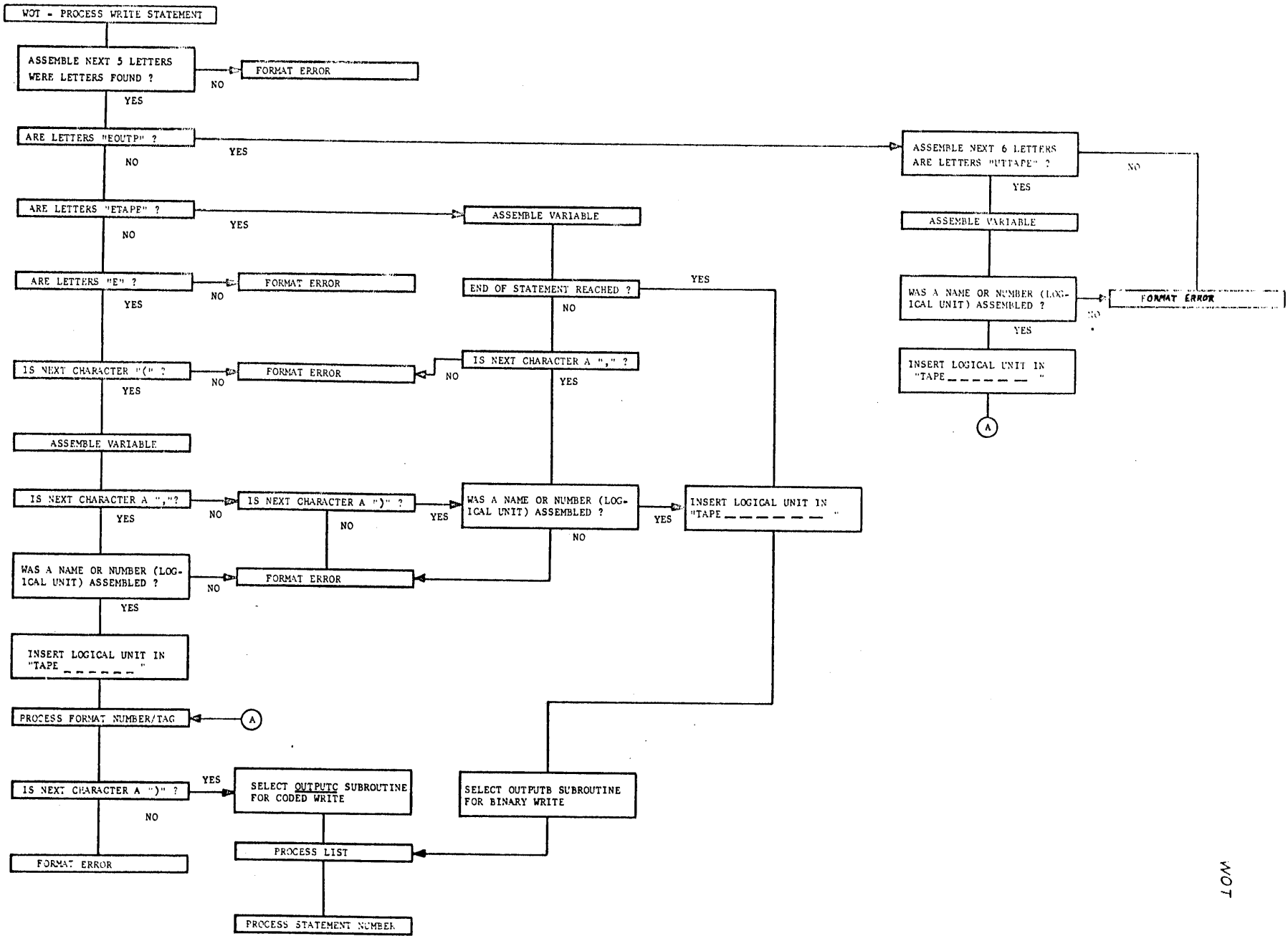

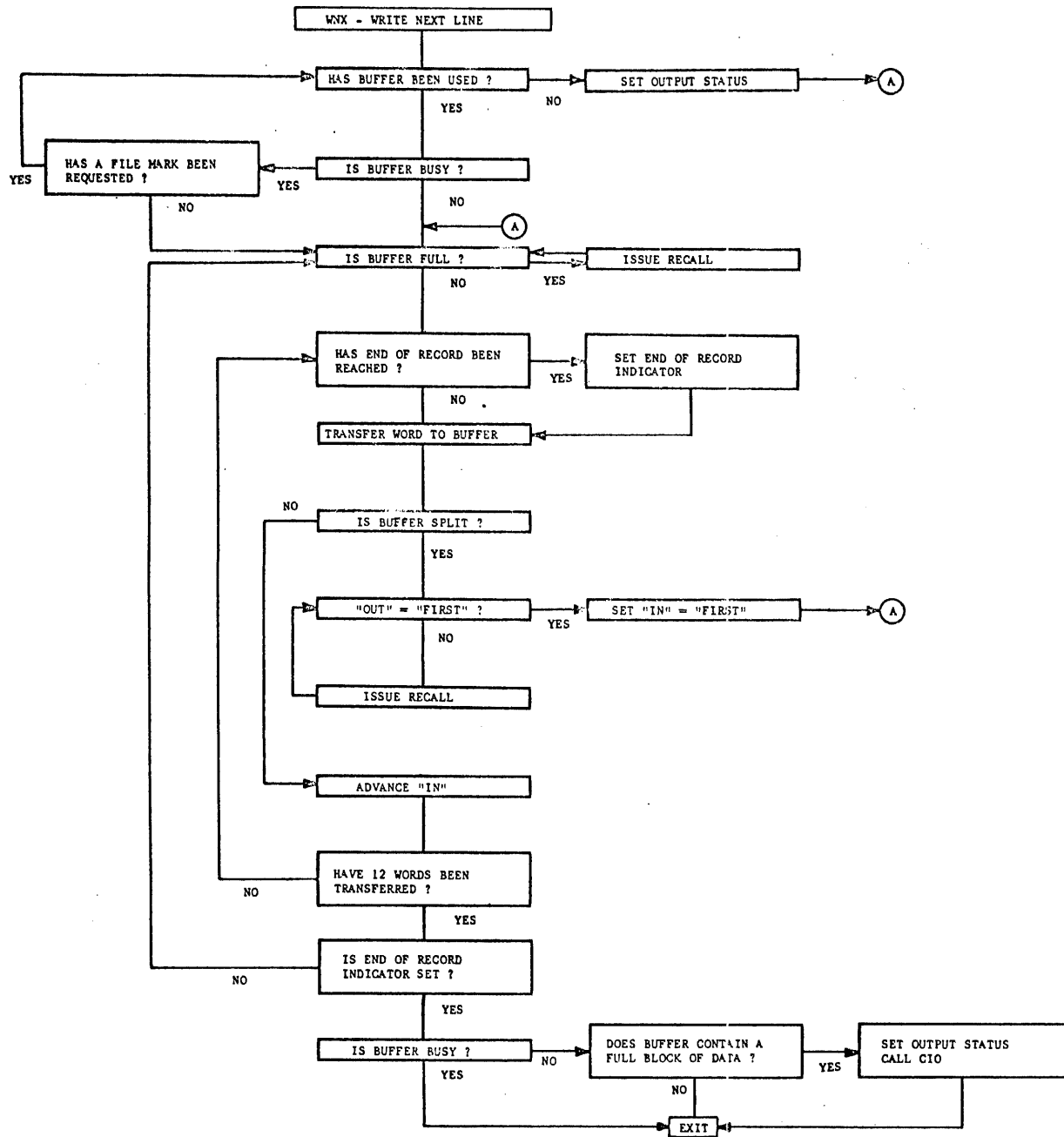

CHIPPEWA FORTRAN COMPILER - RUN

APPENDIX B

CONSTANTS, TEMPORARIES, AND NAME TABLES

December, 1965

CHIPPEWA FORTRAN COMPILER - RUN

CONSTANTS

<u>TAG</u>	<u>CONSTANT</u>
CAA	RAM
CAB	FORTRAN
CAC	CUMULATOR
CAD	OVERFLOW
CAE	OTIENT
CAF	VALENCE
CAG	3 NO (No Operation) Instructions
CAH	ASCENTF
CAI	NSION
CAJ	LEPRECISION
CAK	RNAL
CAL	TION
CAM	VIDECHECK
CAN	SENSELIGHT
CAO	SENSESWITC
CAP	ELIGHT
CAQ	OUTINE
CAR	DOUBLEPREC
CAS	10 Blanks
CAT	8 Blanks Right-Adjusted
CAU	FORMAT
CAV	1000010000010B (Used to Generate A-Z Tables)
CAW	OP5
CAX	INPUTC
CAY	INPU
CAZ	TTAPE
CCA	TAPE
CCB	INPUTB
CCC	INPUT
CCD	PUNCH
CCE	OUTPUT
CCF	EOUTP
CCG	UTTAPE

TAG

CONSTANT

CCH

ETAPE

CCI

OUTPUA

CCJ

OUTPUC

CCK

REWIND

CCL

BACKSP

CCM

ENDFIL

CCN

SPACE

CCO

IBAIEX

CCP

RBAIEX

CCQ

Zero Word

CCR

RTRANbbERR

CCS

ORSbbINbbb

CCT

Zero Word

CCU

CCV

MACHINE

CCW

4 NO (No Operation) Instructions

CCX

CCY

ACGOEP

CCZ

IFENDF

CHIPPEWA FORTRAN COMPILER - RUN

BINARY OUTPUT ARGUMENTS*

<u>TAG</u>	<u>VALUE</u>
BOA	Output File Name
BOB	Start of Buffer
BOC	Input Pointer
BOD	Output Pointer
BOE	End of Buffer

CODED INPUT ARGUMENTS*

<u>TAG</u>	<u>VALUE</u>
INA	Input File Name
INB	Start of Buffer
INC	Input Pointer
IND	Output Pointer
INE	End of Buffer

CODED OUTPUT ARGUMENTS*

<u>TAG</u>	<u>VALUE</u>
OUA	Output File Name
OUB	Start of Buffer
OUC	Input Pointer
OUD	Output Pointer
OUE	End of Buffer

* All value initialized to zero

CHIPPEWA FORTRAN COMPILER - RUN

DBL - Table of Double Precision Function Names

<u>ENTRY</u>	<u>FUNCTION NAMES (Left-Justified)</u>
0	DBLE
1	DABS
2	DSIGN
3	DMOD
4	DEXP
5	DLOG
6	DLOG10
7	DATAN
10	DATAN2
11	DSIN
12	DCOS
13	DSORT
14	DTANH

CHIPPEWA FORTRAN COMPILER - RUN

FII - Table of FORTRAN II Function Names

<u>ENTRY</u>	<u>FUNCTION NAMES</u>
0	MAXOF
1	MAXIF
2	MINOF
3	MINIF
4	XMAXOF
5	XMAXIF
6	XMINOF
7	XMINIF
10	ABSF
11	XABSF
12	XINTF
13	XFIXF
14	FLOATF
15	INTE
16	REAL
17	AIMAG
20	CONJG
21	DMAX1
22	DMIN1
23	DBLE
24	SNGL
25	SIGN
26	XSIGNF
27	DIMF
30	XDIMF
31	MODF
32	XMODF
33	LOGF
34	LOG1OF
35	ATANF
36	SINF
37	COSF

ENTRYFUNCTION NAMES

40

SQRTF

41

TANF

42

SINHF

43

ASINF

44

ACOSF

45

ATAN2F

46

SINGL

47

IDINT

CHIPPEWA FORTRAN COMPILER - RUN

FIV - Table of FORTRAN IV Function Names

<u>ENTRY</u>	<u>FUNCTION NAME</u>
0	AMAXO
1	AMAX1
2	AMINO
3	AMIN1
4	MAXO
5	MAX1
6	MIXO
7	MIX1
10	ABS
11	IABS
12	INT
13	IFIX
14	FLOAT
15	AINT
16	REAL
17	AIMAF
20	COMJF
21	DBLE
22	SNGL
23	SIGN
24	ISIFN
25	DIM
26	IDIM
27	AMOD
30	MOD
31	CMPLX
32	EXP
33	ALOG
34	ALOG10
35	ATAN
36	SIN
37	COS

<u>ENTRY</u>	<u>FUNCTION NAME</u>
40	SQRT
41	TAN
42	TANH
43	ASIN
44	ACOS
45	ATAN2
46	SNGL
47	IDINT
50	77B - Right-Justified
51	CABS
52	CEXP
53	GLOF
54	CSIN
55	CCOS
56	CSQRT

CHIPPEWA FORTRAN COMPILER - RUN

HDD - Table of Program Title Types

<u>ENTRY</u>	<u>NAME (Left-Justified)</u>
0	PROGRAM
1	SEGMENT
2	SUBROUT
3	FUNCTIO
4	END
5	BLOCKDA

HDF - Table of Variable Declaration Types

<u>ENTRY</u>	<u>NAME (Left-Justified)</u>	<u>CODE*</u>
0	LOGICAL	1
1	INTEGER	2
2	REAL	4
3	ISION	5
4	COMPLEX	6

*Type code appears in low-order 3 bits.

CHIPPEWA FORTRAN COMPILER - RUN

LGR - Table of Statement Letter Groups

<u>ENTRY</u>	<u>STATEMENT LETTER GROUP (Left-Justified)</u>
0	RETU
1	ASSI
2	IF
3	IFQU
4	IFDI
5	IFAC
6	SENS
7	STOP
10	PAUS
11	GOTO
12	CALL
13	READ
14	PUNC
15	PRIN
16	WRIT
17	REWI
20	ENDF
21	BACK
22	ENCO
23	DECO
24	BUFF
25	END
26	PROG
27	SEGM
30	SUBR
31	FUNC
32	CONT
33	BLOC
34	FREQ
35	FORM

CLASSED AS
EXECUTABLE
STATEMENTS

ENTRY

STATEMENT LETTER GROUP (Left-Justified)

36	NAME
37	ENTR
40	DOUB
41	REAL
42	INTE
43	LOGI
44	COMP
45	DIME
46	EXTE
47	EQUI
50	DATA
51	COMM

CHIPPEWA FORTRAN COMPILER - RUN

LTB - Table of Logical Separators and Constants

<u>WORD</u>	<u>ENTRY (Left-Justified)</u>
0	LT
1	LE
2	EQ
3	NE
4	GE
5	GT
6	NOT
7	AND
10	OR
11	FALSE
12	TRUE

CHIPPEWA FORTRAN COMPILER - RUN

Map Headlines

MPF	OFUNCTIONb ASSIGNMENT S
MPN	OSTATEMENT bASSIGNMEN TS
MPV	OVARIALEb ASSIGNMENT S
MPK	OSTARTbOFb CONSTANTSb O
MPT	OSTARTbOFb TEMPORARIE S
MPI	OSTARTbOFb INDIRECTS O
MPS	OSUBROUTIN EbASSIGNME NTS
MPR	OBLOCKbASS IGNMENTS
MPM	OBUFFERbAS SIGNMENTSb O
MPL	OLOCALbLEN GTH
MPC	OCOMMONbL ENGTH
MPB	OBUFFERbLE NGTH
MPP	OUNUSEDbPR

	OGRAMbSPAC
	E
MPU	OUNUSEDbCO
	MPILERbSPA
	CE
MPD	UNUSEDbJOB
	bSPACEbbbb

CHIPPEWA FORTRAN COMPILER - RUN

MTA - Table of ASCENT Pseudo-Operations

<u>ENTRY</u>	<u>NAME (Left-Justified)</u>
0	BSS
1	BSSZ
2	EQU
3	DPC
4	BCD
5	CON

MTB - Table of Tag - Defining Operation Codes

<u>ENTRY</u>	<u>NAME (Left-Justified)</u>
0	CON
1	ABS
2	HOL
3	COM
4	RES
5	SUB

CHIPPEWA FORTRAN COMPILER - RUN

RCD - TABLE OF OPERATIONAL-REGISTER CODES

<u>ENTRY</u>	<u>REGISTER TYPE</u> <u>(left-justified)</u>	<u>REGISTER NUMBER</u> <u>(right-justified)</u>
0	7**	7**
1	C	0
2	C	1
3	C	2
4	C	3
5	C	4
6	C	5
7	C	6
8	C	7
9	B	1
10	B	2
11	B	3
12	B	4
13	B	5
14	B	6
15	B	7
16	D*	0*
17	E*	0*
18	F*	0*
19	A	0
20	A	1
21	A	2
22	A	3
23	A	4
24	A	5
25	A	6
26	A	7

* Used in Machine processing only

** Unused

C = A registers, B = B registers, A = X registers

CHIPPEWA FORTRAN COMPILER - RUN

REG - POWERS OF 10^{2^0} - 10^{2^8}

<u>ENTRY</u>	<u>VALUE</u>
0	$10^{2^0} = 10$
1	$10^{2^1} = 100$
2	$10^{(2)^2} = 10^4$
3	$10^{(2)^3} = 10^8$
4	$10^{(2)^4} = 10^{16}$
5	$10^{(2)^5} = 10^{32}$
6	$10^{(2)^6} = 10^{64}$
7	$10^{(2)^7} = 10^{128}$
8	$10^{(2)^8} = 10^{256}$

<u>Table Parameter Tag</u>	<u>Table</u>	<u>Tags Entered</u>
TBT	SUBROUTINE TAG	LIBRARY TAG
TBU	SUBROUTINE PARAMETERS	
TBV	COMMON BLOCK NAME AND ADDRESS	
TBW	PROGRAM FILE NAME AND ADDRESS	

CHIPPEWA FORTRAN COMPILER - RUN

Program Tags

<u>TAG</u>	<u>FUNCTION</u>	<u>TYPE</u>
TGL	LIBRARY TAG (L-TAG)	40xxxxx
TGA	PROGRAM TAG (A-TAG)	20xxxxx
TGI	INDIRECT TAG (I-TAG)	22xxxxx
TGT	TEMPORARY TAG (T-TAG)	24xxxxx
TGK	CONSTANT TAG (K-TAG)	26xxxxx
TGF	FUNCTION TAG (F-TAG)	30xxxxx
TGW	ARRAY TAG (W-TAG)	32xxxxx
TGV	VARIABLE TAG (V-TAG)	34xxxxx
TGH	STATEMENT TAG (H-TAG)	36xxxxx

CHIPPEWA FORTRAN COMPILER - RUN

TOI - TABLE FOR CHECK ON INSTRUCTIONS 50-77

<u>ENTRY</u>	<u>FLAG</u>	<u>INSTRUCTION</u>
0	C + G	00
1	B + G	01
2	A + G	02
3	A + B	03
4	C + B	04
5	C - B	05
6	B + B	06
7	B - B	07

CHIPPEWA FORTRAN COMPILER - RUN

TOP - TABLE OF IDENTIFYING CHARACTERS

<u>ENTRY</u>	<u>FLAG</u>	<u>INSTRUCTIONS</u>
0	O A D = A + A	32
1	O A D = A - A	33
2	O A D = A * A	42
3	O A C = A * A	15
4	O A C = A + A	16
5	O A C = A - A	17
6	O A I = A + A	36
7	O A I = A - A	37
8	O A L = A * A	11
9	O A L = A + A	12
10	O A L = A - A	13
11	O A R = A + A	34
12	O A R = A - A	35
13	O A R = A * A	41
14	O A R = A / A	45
15	O A N = A + A	30
16	O A N = A - A	31
17	O A N = A * A	40
18	O A N = A / A	44

CHIPPEWA FORTRAN COMPILER - RUN

TOS - TABLE OF SPECIAL FORMATS

<u>ENTRY</u>	<u>FLAG</u> (left-justified)	<u>SHORT/LONG*</u> (bit-18)	<u>REGISTER FLAG**</u> (bits 6-7)	<u>INSTRUCTION</u> (right-justified)
0	O A B = A .	1	0	26
1	O A B = A +	1	0	25
2	O A B = A -	1	0	24
3	O A B , A .	1	0	27
4	O A (- B)	1	2	57
5	O A A (B)	1	2	22
6	O A A (- B)	1	2	23
7	O A - A . A	1	2	15
8	O A - A A	1	2	16
9	O A A (G)	1	3	20
10	O A A (- G)	1	3	21
11	O O A (G)	0	0	51
12	O O A (C)	1	0	54
13	O O A (B)	1	0	56
14	O O A (A)	1	0	53
15	O O A A + A	1	0	36
16	O O A A - A	1	0	37
17	O O A A * A	1	0	40
18	O O A A / A	1	0	44
19	O O A A . A	1	0	11
20	O O A A A	1	0	12
21	O O O A * G	1	1	43
22	O O O A * A	1	2	47
23	O O O A - B	1	2	77
24	O O O B - B	1	2	67
25	O O O C - B	1	2	57
26	O O O A - A	1	2	14
27	O O O O A G	0	0	71
28	O O O O B G	0	0	61
29	O O O O C G	0	0	51
30	O O O O C C	1	0	54

ENTRY	FLAG (left-justified)	SHORT/LONG* (bit-18)	REGISTER FLAG** (bits 6-7)	INSTRUCTION (right-justified)
31	0 0 0 0 C B	1	0	56
32	0 0 0 0 A C	1	0	74
33	0 0 0 0 A B	1	0	76
34	0 0 0 0 B C	1	0	64
35	0 0 0 0 B B	1	0	66
36	0 0 0 0 C A	1	0	53
37	0 0 0 0 B A	1	0	63
38	0 0 0 0 A A	1	0	10

* 0 = long instruction

1 = short instruction

** 0 = operation registers are contained in I, J and K constants

1 = masking instruction

2 = J and K values should be interchanged

3 = shift instruction

CHIPPEWA RUN COMPILER - RUN

VTA - TABLE OF REGISTER-ASSOCIATED TAGS

<u>TAG</u>	<u>REGISTER ASSOCIATED</u>
VTA	A0
VTB	A1
VTC	A2
VTD	A3
VTE	A4
VTF	A5
VTI	B1
VTJ	B2
VTK	B3
VTL	B4
VTM	B5
VTN	B6
VTO	B7
VTY	X6
VTT	X1
VTU	X2
VTV	X3
VTW	X4
VTX	X5

CHIPPEWA FORTRAN COMPILER - RUN

TEMPORARIES/FLAGS

<u>TAG</u>	<u>TEMPORARY</u>
ADM	RUNNING RELATIVE ADDRESS
ARF	ARGUMENT-REFERENCE COUNT
ARG	ARGUMENT COUNT
ARI	ARRAY-REFERENCE COUNT
BAI	BASE ADDRESS FOR INDIRECTS
BAK	BASE ADDRESS FOR CONSTANTS
BAT	BASE ADDRESS FOR TEMPORARIES
BAV	BASE ADDRESS FOR VARIABLES
BIT	BYPASS-INTERREGISTER-TRANSFER INDICATOR
BLN	BUFFER LENGTH FOR INPUT/OUTPUT
CBA	CURRENT COMMON-BLOCK RELATIVE-ADDRESS
CJP	CURRENT JUMP ADDRESS
CSA	COMMON STARTING ADDRESS
CTG	CURRENT PROGRAM TAG
CTY	COMMON-BLOCK-TYPE INDICATOR
DFG	DATA-STATEMENT INDICATOR
DSN	DO STATEMENT-NUMBER
STI	DO-TERMINATION INDICATOR
FAG	INHIBIT FUNCTION-ARGUMENT FLAG
FLC	PROGRAM COMMON FIELD-LENGTH
FLF	JOB ERROR FLAG
FLG	PROGRAM ERROR FLAG
FLH	SUBPROGRAM ERROR FLAG
FLT	PROGRAM TOTAL FIELD-LENGTH
FSR	FUNCTION-STATEMENT-REFERENCE COUNT
FST	LONG-FILE START
FTY	FUNCTION TYPE
HIC	HIGHEST-INDEX COUNT
ICA	DISPLAY-CODED RUNNING-ADDRESS
ICB	ARGUMENT COUNT
ICC	RELATIVE SUBROUTINE START
ICD	SUBROUTINE REFERENCE TAG

<u>TAG</u>	<u>TEMPORARY</u>
ICE	DOLLAR-SIGN POINTER
ICF	I-TAG MAXIMUM
ICG	T-TAG MAXIMUM
ICH	DATA-REPEAT INDICATOR
ICI	INCOMPLETE-READBACK INDICATOR
ICJ	COMPILER FIELD LENGTH
ICK	BLOCK-DATA INDICATOR
ICL	SIMPLE-LOGICAL-RELATION INDICATOR
ICM	INCOMPLETE-COMPILE-MODE INDICATOR
ICN	TABLE LENGTH FOR INCOMPLETE-COMPILE MODE
ICO	BASE ADDRESS FOR VARIABLES
ICP	BINARY-SUBROUTINE REGION END
ICQ	UPCOMING STATEMENT-NUMBER
ICR	UPCOMING CHARACTER-GROUP
ICS	ERROR-HANDLER TAG
ICT	INTRAWORD INSTRUCTION COUNTER
ICU	INDEX TAG
ICV	UPCOMING-STATEMENT AND UNPACK INDICATOR
ICW	DO-TERMINATION-PROCESSING INDICATOR
ICX	BUILT-IN-FUNCTION POINTER
ICY	LINE LIMIT
ICZ	FREE TEMPORARY
IGE	INSTRUCTION-GROUP END
IGS	INSTRUCTION-GROUP START
IGX	CURRENT INDEX ASSIGNMENT
ILG	LOGICAL-RELATION COUNT
INF	DUMP-PDUMP INDICATOR
ING	SUBSCRIPT COUNT
INH	FIRST CHARACTER OF STATEMENT WITH O-TYPE CONSTANT
INI	MAP-ITEM COUNT
INJ	ASCENT MNEMONIC CODE OR REGISTER NUMBER
INK	CONTINUE INDICATOR
INL	LOGICAL-IF INDICATOR
INM	LOGICAL-RELATION INDICATOR
INN	MODE INDICATOR FOR READ

<u>TAG</u>	<u>TEMPORARY</u>
INO	DOMINANT-MODE INDICATOR
INP	OUTPUT-FILE STATUS
INQ	NAME FOR DAYFILE
INR	H OR L OR R INDICATOR
INS	ARRAY-REFERENCE MODE
INT	FIRST INSTRUCTION ADDRESS
INU	UNUSED COMPILER SPACE
INV	SEGMENT INDICATOR
INW	CHAIN-MODE INDICATOR
INX	UPCOMING-STATEMENT INDICATOR
INY	COMPLETE-UNPACK INDICATOR
INZ	EXPRESSION-TERM COUNT
IPS	PROGRAM-SUBPROGRAM INDICATOR
IWC	NUMBER OF INSTRUCTION WORDS
JPS	CURRENT PROGRAM-SUBPROGRAM INDICATOR
LBA	LATEST BUFFER ADDRESS
IMD	ADDRESS OF LAST MULTIPLY OR DIVIDE INSTRUCTION
LRC	CURRENT LOGICAL RELATION
MHI	MACHINE-HEADING INDICATOR
MOD	SUBPROGRAM MODE
MOE	PROGRAM MODE
MOF	SPECIAL COMPILE-MODE INDICATOR
MSN	MISSING-STATEMENT INDICATOR
MST	SYSTEM-ERROR INDICATOR
PNM	PROGRAM/SUBPROGRAM NAME
RGC	REGISTER-ASSIGNMENT COUNT
RGX	LONG-REGISTER ASSIGNMENT
RJC	RETURN-JUMP COUNT
RNZ	READ-ENTRY COUNTER
SAR	SINGLE-ARRAY-REFERENCE COUNT
SBA	ADDRESS OF BASE-SETTING INSTRUCTION
SBP	LATEST INDEX-DIMENSION
SRI	SUBROUTINE-REFERENCE COUNT
STG	COMPILE-MODE INDICATOR
STN	STATEMENT NUMBER
TIP	PROGRAM TYPE

<u>TAG</u>	<u>TEMPORARY</u>
TJP	SUBPROGRAM TYPE
TMA	PSEUDO-STATEMENT-NUMBER FOR INDEXED LISTS
TMB	DO STATEMENT-NUMBER
TMC	FREE TEMPORARY
TMD	INPUT/OUTPUT SUBROUTINE TAG
TME	START OF LOGICAL RELATION
TMF	START OF ARRAY REFERENCE
TMG	EXPRESSION INDEX ASSIGNMENT
TMH	START OF EXPRESSION
TMI	FIRST STATEMENT NUMBER
TMJ	SECOND STATEMENT NUMBER
TMK	THIRD STATEMENT NUMBER
TML	ARGUMENT COUNT FOR CALL
TMM	NAME TAG FOR CALL
TMN	ARGUMENT TAG FOR CALL
TMO	START OF CONDITIONAL STATEMENT
TMP	CURRENT EXTENDED COMMON BLOCK-LENGTH
TMQ	CURRENT COMMON BLOCK-NAME
TMR	BASE ADDRESS FOR EQUIVALENCE GROUP
TMS	END OF RECORD FLAG
TMT	DIMENSION COUNTER
TMU	CONSTANT PORTION OF ARRAY ADDRESS
TMV	MULTIPLIER FOR SECOND SUBSCRIPT
TMW	MULTIPLIER FOR THIRD SUBSCRIPT
TMX	SECOND OR THIRD SUBSCRIPT MULTIPLIER
TMY	INDEX REGISTER ASSIGNMENT FOR ARRAY ADDRESS
TMZ	ARGUMENT POINTER FOR FUNCTION REFERENCE
TPT	TEMPORARY FOR UNPACK
WNZ	WRITE-ENTRY COUNTER
ZAA	RELATIVE START OF CURRENT PROGRAM OR SUBROUTINE
ZAB	SHORT-FILE START
III	I-PORION OF MACHINE INSTRUCTION
JJJ	J-PORION OF MACHINE INSTRUCTION
KKK	K-PORION OF MACHINE INSTRUCTION

CHIPPEWA FORTRAN COMPILER - RUN

APPENDIX C

FLOW CHARTS FOR EXECUTION TIME ROUTINES

December, 1965

C-1

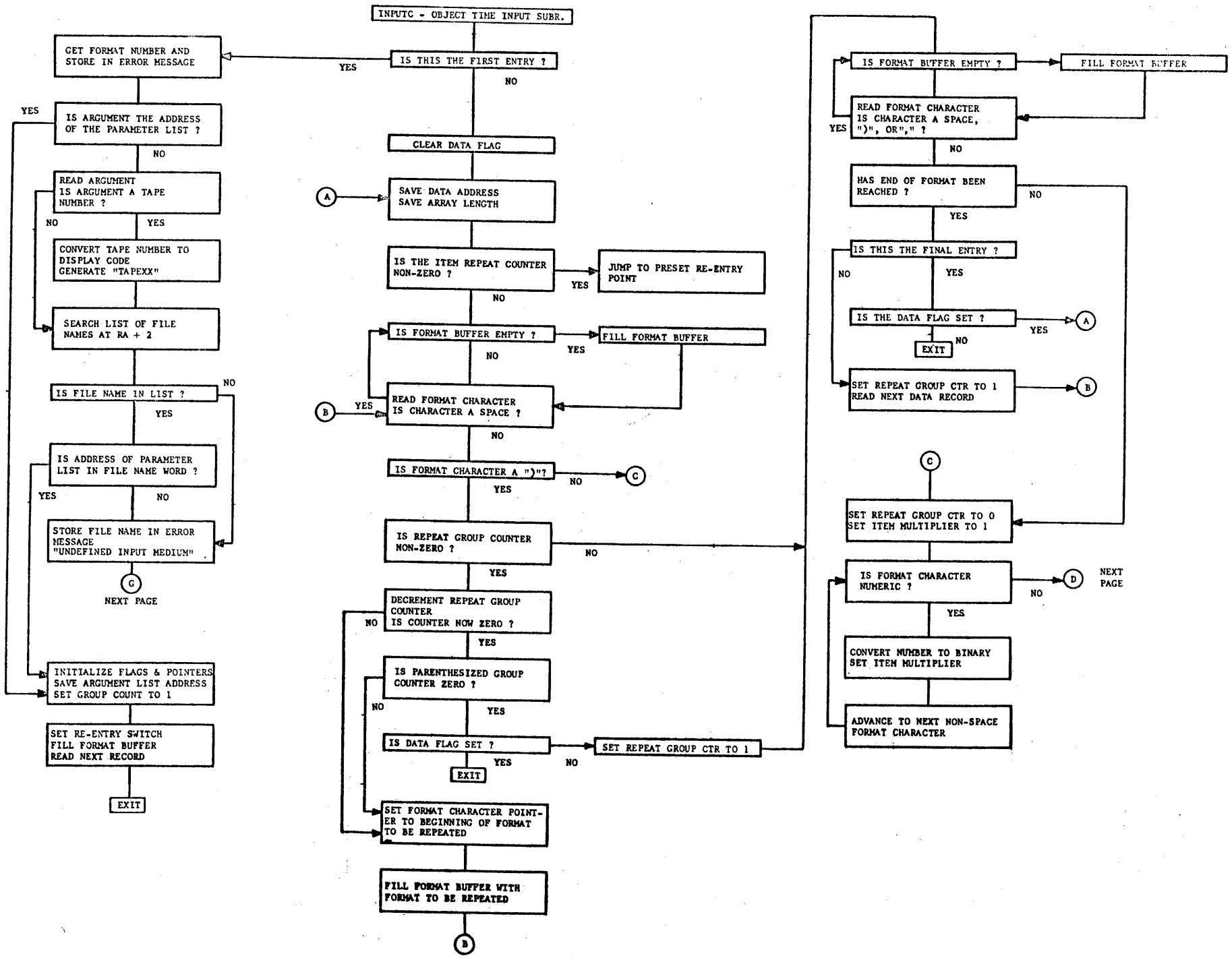

INPUTC

C-2

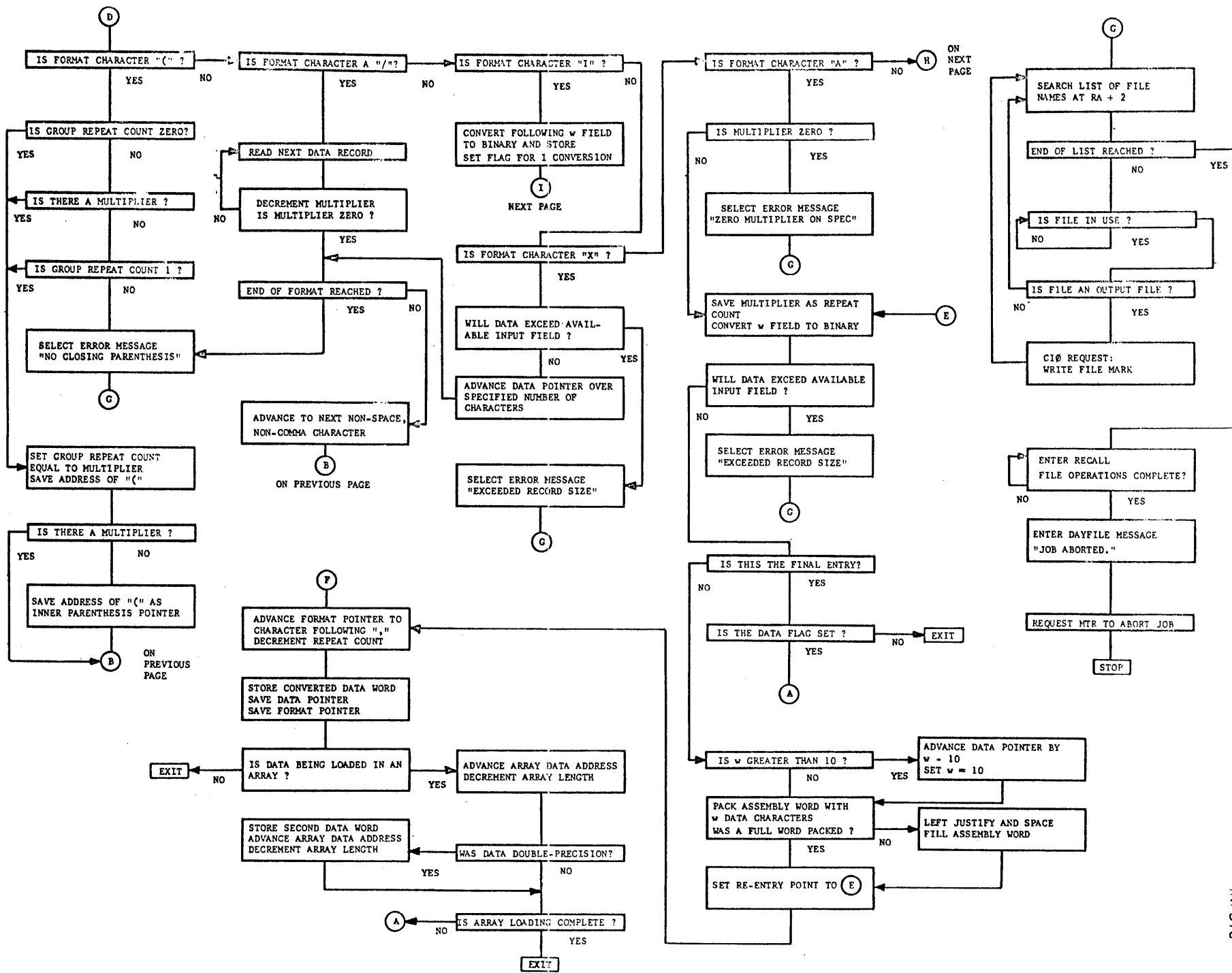

INPUT

C 3

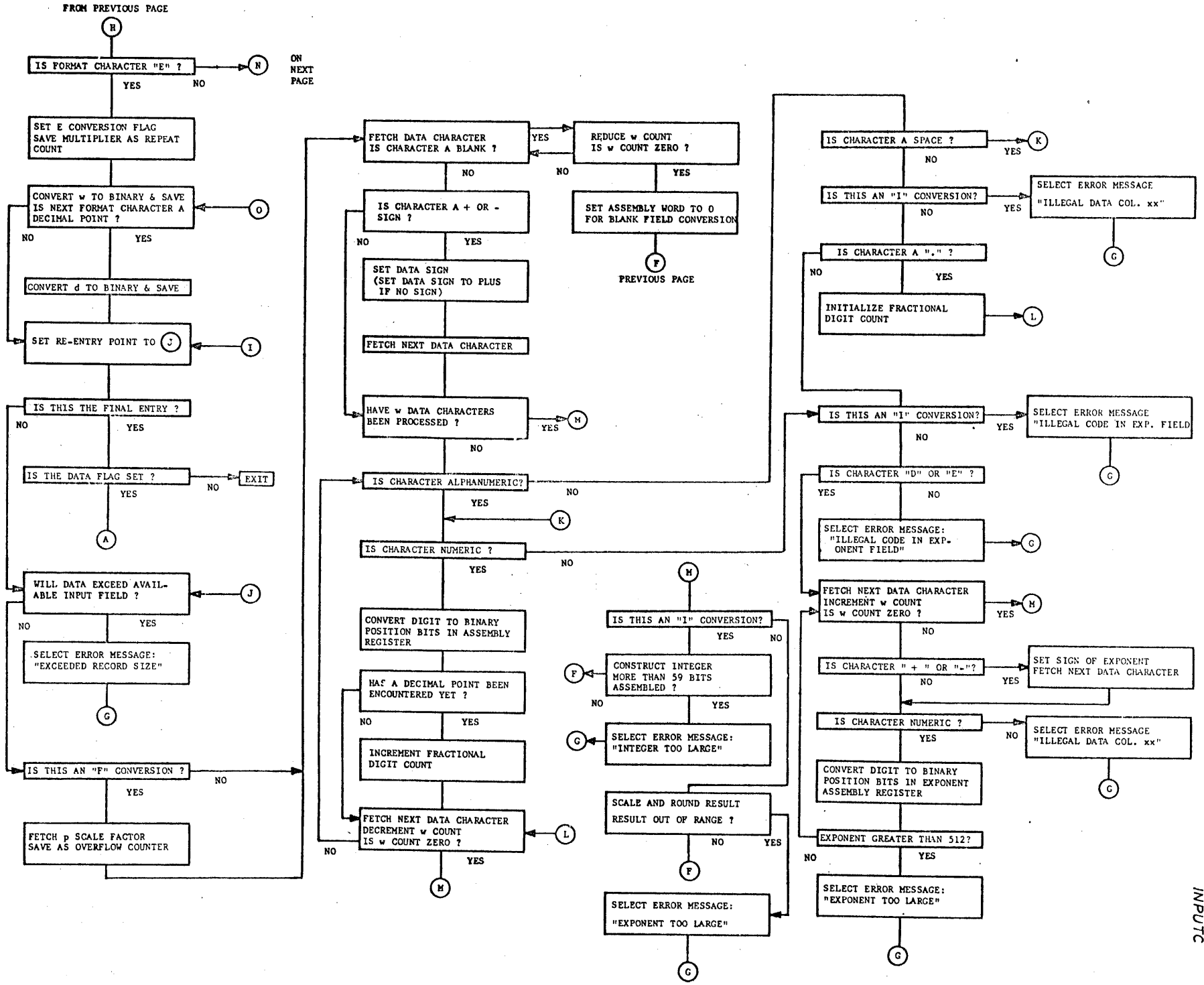

INPUTC

FROM PREVIOUS PAGE

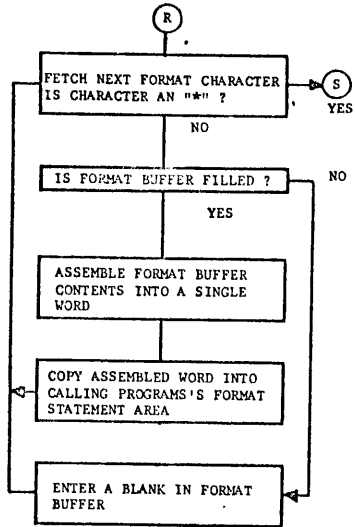

FROM PREVIOUS PAGE

ON
PREVIOUS
PAGE

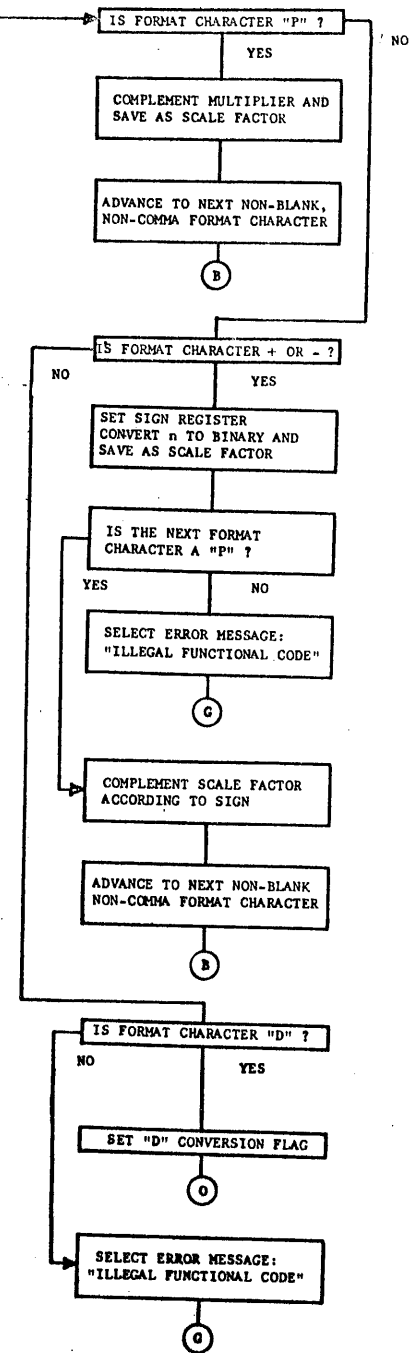
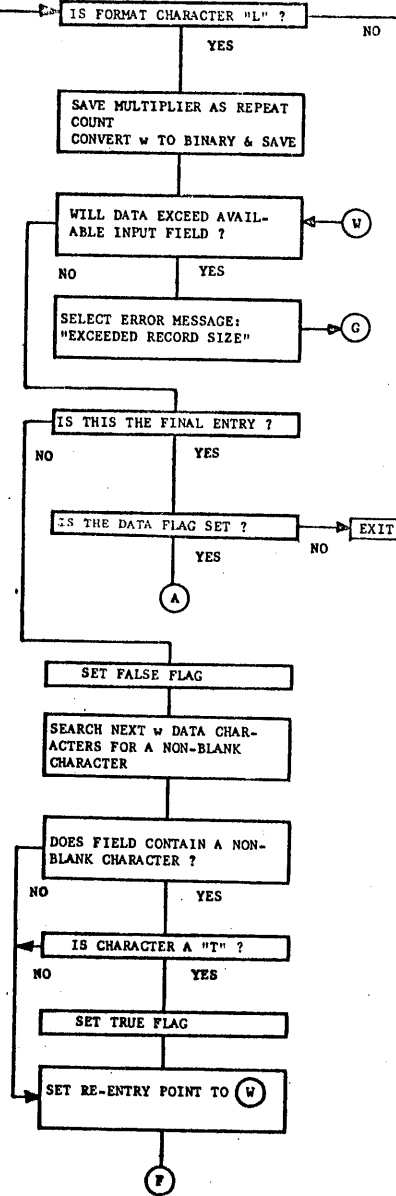
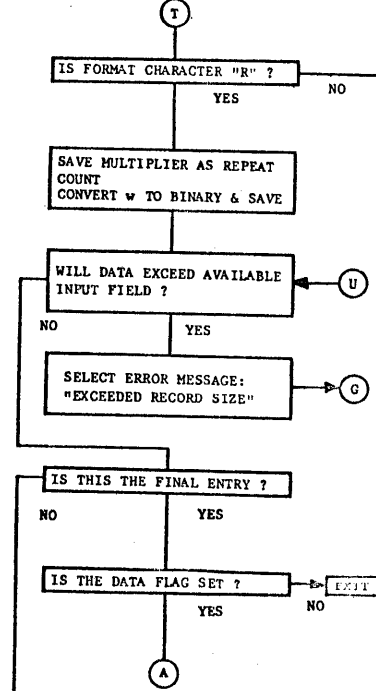

CONTROL DATA

CORPORATION

8100 34th AVE. SO., MINNEAPOLIS, MINN. 55440

PRINTED IN U.S.A.