

**APPLICATION NOTE**

**5.25 INCH FDD FORMAT CONSIDERATIONS  
AND  
CONTROLLER COMPATIBILITIES**

**MAGNETIC PERIPHERALS INC.**

 a subsidiary of  
**CONTROL DATA CORPORATION**

**COPYRIGHT © 1984**  
**by MAGNETIC PERIPHERALS INC.**  
**ALL RIGHTS RESERVED**

**Printed in the United States of America**

**This publication may contain application, high technology,  
or product specification data, or any combination thereof,  
is considered advance technical information by the  
producer, and is subject to change without prior notice.**

APPLICATION NOTE  
5.25-INCH FDD FORMAT CONSIDERATIONS  
AND  
CONTROLLER COMPATIBILITIES

This application note discusses the relationships between head styles, 5-25-inch FDD formats and LSI controllers. It is intended that this document be used as a reference either when designing one's controller for 5.25-inch FDD products or when planning the drive's application particularly if media interchange is to be exercised.

The tunnel erase head as used on the CDC 9408 FDD and the straddle erase type of Shugart head are described as well as their impact on 5.25-inch FDD formats. It is shown how the head style and drive tolerances determine the minimum gap lengths of the 5.25-inch FDD format. The modified IBM and Shugart single-density 5.25-inch FDD formats are described as well as their compatibility with the head styles and LSI controller chips. Double density formats are also examined as well as the capability of the double density LSI controller chips. The constraints placed on hard sectored formats and recommended hard sectored formats are defined.

The Intel 8271, Western digital 1771 and 1791, and NEC 765 LSI controller chips were examined as well as the Intel iSB0204<sup>1</sup>, SD sales Versafloppy<sup>2</sup>, Micropolis 1071, North star controller, and the Wameco FDC-1 single board 5.25-inch FDD controllers.

For additional information, contact your local CDC sales representative.

---

<sup>1</sup> Registered Trademark, Intel Corporation

<sup>2</sup> Registered Trademark, S.D. Computer Products (SD Systems)

## FORMAT SUMMARY

1. For single density soft sector formatting, a "modified IBM format" is evolving as a 5.25-inch FDD industry standard. This format, with which the CDC 9408 is fully compatible, is the single density 8-inch IBM format modifier for use on 5.25-inch media by eliminating Gap 5 and Index Address Mark, shortening Gap 1 (Post-Index Gap) from 26 bytes to 16 bytes, and reducing the number of sectors.
2. An industry-standard double-density 5.25-inch FDD format has not been defined; however, a de facto standard format has resulted from the LSI controllers being designed for 5.25-inch FDD data rates as well as full-sized data rates. The full-sized IBM double density format is modified to 5.25-inch FDD use by the same procedure used for the single density format, and the 9408 is similarly compatible with the resultant format.
3. 10 and 16 sectors per track hard-sectored 5.25-inch FDD diskettes are available, and the 9408 is capable of 256 and 128 byte sectors, respectively, using a format at least similar to that shown later in Figure 5.
4. The LSI controllers investigated are not compatible with the Shugart 18-sector 5.25-inch FDD format due primarily to Shugart's use of non-standard ID Records, although their reduced Gap 2 is also incompatible. While the 9408 drive itself should theoretically be able to read reliably single density diskettes prepared in the 18-sector format, the tunnel erase head characteristics, coupled with drive tolerances, can introduce incompatibilities in attempting to write data fields on 18-sector format diskettes.

# TABLE OF CONTENTS

		<u>PAGE</u>
1.0	INTRODUCTION .....	5
1.1	References .....	6
2.0	9408 and SA400 FORMAT CAPABILITY AND COMPATIBILITY .....	7
2.1	Head Styles .....	7
2.2	Single Density Soft Sector Formats .....	9
2.2.1	Minimum Gap Lengths .....	9
2.2.2	LSI Controller Capability .....	13
	(Single Density, Soft Sector)	
2.3	DOUBLE DENSITY SOFT SECTOR FORMATS .....	13
2.4	HARD SECTOR FORMAT CONSTRAINTS .....	15
2.5	SINGLE-BOARD 5.25-INCH FDD CONTROLLERS .....	16
2.5.1	Intel iSBC 204 .....	16
2.5.2	SD Sales Versafloppy .....	16
2.5.3	Micropolis 1071 Controller .....	19
2.5.4	North Star Controller .....	19
2.5.5	Wameco FDC-1 .....	20
APPENDIX A	SINGLE DENSITY AND DOUBLE DENSITY FORMATS	
A.1	MODIFIED IBM AND SHUGART SINGLE DENSITY FORMATS .....	21
A.2	ECMA SINGLE DENSITY FORMATS .....	23
A.3	DOUBLE DENSITY FORMATS .....	23
APPENDIX B	MINIMUM GAP LENGTHS	
B.1	AFFECT OF HEAD STYLE ON GAP LENGTH .....	26
B.2	DRIVE PARAMETER AND VARIABLE DEFINITIONS .....	26
B.3	MINIMUM GAP 2 LENGTH .....	27
B.3.1	Factors Determining Minimum Gap 2 Length .....	27
B.3.2	Minimum Gap 2 Length Equations .....	30
B.4	MINIMUM GAP 3 LENGTH	
B.4.1	Factors Determining Minimum Gap 3 Length .....	31
B.4.2	Minimum Gap 3 Length Equations .....	36
B.5	MINIMUM GAP 1 AND GAP 4 .....	38
B.6	HARD SECTOR FORMATS .....	38
B.6.1	Minimum Preamble for Postamble Left Blank .....	39
B.6.2	Minimum Postamble for Postamble Left Blank .....	40
B.6.3	Maximum User Data Per Sector .....	41
B.6.4	For Postamble Written With Gap Characters .....	41
B.6.5	Straddle Erase Head Capability .....	43
B.6.6	Hard Sector Format Calculations .....	43

LIST OF FIGURES AND TABLES :

Figure	1.	Head Styles .....	8
	2.	General Form of the Modified IBM and Shugart 5.25-Inch FDD Formats .....	10
	3.	Breakdown of Minimum Gap Lengths (For Tunnel Erase Head) .....	12
	4.	Typical Hard Sector Format .....	15
	5.	Recommended Minimum Hard Sector Format .....	18
	6.	Micropolis Hard Sector Double Density Format .....	19
	7.	North Star Hard Sector Format .....	20
	8.	Modified IBM Format and Shugart Suggested Format for Single Density 5.25-Inch FDD Diskettes .....	22
	9.	Micropolis Double Density (GCR) 5.25-Inch FDD Format .....	24
	10.	Possible Modified IBM Double Density 5.25-Inch FDD Format .....	25
	11.	Minimum and Maximum Time to Pass Under Head (Gap 2) .....	28
	12.	Side View of the Media and Head at the Inner Track (Gap 2) .....	29
	13.	Minimum and Maximum Time to Pass Under Head (Gap 3) .....	32
	14.	Affect of Data Record Length Variation .....	34
	15.	Minimum Preamble Length (For Postamble Left Blank) .....	39
	16.	Minimum Postamble Length (For Postamble Left Blank) .....	40
	17.	Minimum Postamble and Preamble Length (For Postamble Written With Gap Characters) .....	42
Table	1.	Single Density 5.25-Inch FDD minimum Gap Sizes .....	11
	2.	Sectors Per Track With Double Density Format .....	14
	3.	Hard Sector Format Parameters .....	17
	4.	Minimum Gap 3 Length .....	37

APPLICATION NOTE  
5.25-INCH FDD FORMAT CONSIDERATIONS  
AND  
CONTROLLER COMPATIBILITIES

1.0 INTRODUCTION

This report discusses the relationships between head styles, 5.25-inch FDD formats and LSI controllers. The tunnel erase and straddle erase heads are described as well as their impact upon 5.25-inch FDD formats. It is shown how the head style and drive tolerances determine the minimum gap lengths of the 5.25-inch FDD formats. The format capability of the LSI controllers is shown for both single density and double density formats. The constraints placed on hard sector board controllers as recommended hard sector formats are defined. Several single board controllers are examined to determine the compatibility of the 9408 and the formats used.

This report is organized so that the general concepts and results are presented in Sector 2, with the detailed discussion and analysis presented in appendices at the end. This results in some material being presented twice at different levels of detail. A different level of detail is used in the hard sector format discussion because most of the parameters involved are defined in the soft sector format discussion. The word "gap" is used with two different meanings and to prevent confusion they are defined here: 1. when used as "read/write gap" or "erase gap", it refers to the physical space between ferrite pieces of the head where read, write, or erase operations occur; and 2. when used as "gap" refers to the spaces between information areas of the format, such as the Gap 2 between the ID Record and the Data Record.

## 1.1 REFERENCES

The following documents were used in the preparation of this report.

Reference Document	Organization	Document #
9408 Engineering Specification	CDC	75896747
9404 Product Specification	CDC	83464400
Application Note - Hard Sector Formatting	CDC	75888303
SA400 OEM Manual	Shugart	54102
SA800 OEM Manual	Shugart	50574-1
SA400 Track Format Manual	Shugart	NA
Track Format Manual	Shugart	NA
SA800 Double Density Design Guide	Shugart	39000
IBM Compatibility Reference Manual	Shugart	39002
SA400/450 - 8080A/1771 Application Note	Shugart	NA
Hard Sector Formatting For FD400 FDD	Pertec	NA
Model 82 Microfloppy <sup>1</sup> Product Description	Wangco	620325-001A
IBM One-Sided Diskette OEM Information	IBM	GA21-9190-3
IBM Two-Sided Diskette OEM Information	IBM	GA21-9257-1
ECMA 130 mm Media Standard	ECMA	TC19/78/17
ANSI Draft 5 5.25" Media Standard	ANSI	X3B8/78-150
Western Digital 1771, 1791 Data Sheets and Application Notes	Western Digital	NA
Intel Peripheral Design Handbood	Intel	NA
NEC Microcomputers, Inc. 1979 Catalog and 765 Application Notes	NEC	NA
Micropolis 1055/1035 Engineering Specification	Micropolis	100127
iSBC 204 FDC Hardward Reference Manual	Intel	9800568A
North Star FDC Theory of Operation	North Star	NA
SD Sales Versafloppy Users Manual	SD Sales	NA
Micropolis 1071 Theory of Operation	Micropolis	NA

<sup>1</sup> Registered Trademark, Wangco, Inc.



## 2.0 9408 AND SA400 FORMAT CAPABILITY AND COMPATIBILITY

The 9408 and SA400 are examined to determine the 9408's compatibility with the various 5.25-inch FDD formats being used. The heads used by the two drives are examined to determine their impact upon the formats being used. Using the respective drive parameters and head characteristics, the minimum Gap length requirements are presented; associated LSI controller capabilities are also included. Several single board controllers are examined to determine the compatibility of their format and the 9408.

### 2.1 HEAD STYLES

The two head styles used by flexible disk drive manufacturers are the "tunnel erase" and the "straddle erase" heads. The tunnel erase head is an industry standard head used by IBM and most drive manufacturers. The straddle erase head is a proprietary product of Shugart and is only used by Shugart. Both head styles have as common parts a read/write (R/W) gap and two erase gaps. The R/W gap is the point at which the actual reading and writing occurs. The two erase gaps are used to erase guard bands on both sides of the data being written. These guard bands are necessary to eliminate noise caused by old data that had been written slightly off track. See Figure 1. A major difference between the two heads is the placement of the erase gaps. The erase gaps of the tunnel erase head are 36 mils behind the R/W gap whereas with the straddle erase head the erase gaps are on both sides of the R/W gap and extend approximately 11 mils behind it. With the straddle erase head, the erase gaps can be turned on and off at the same time as the write gap, but because the erase gaps of the tunnel erase head are so far from the write gap they must be turned on and off separately; this is normally done by one-shots on the drive but some manufacturers can allow this to be done by the controller. The affect of the head style on the minimum gap length of the formats is discussed more in Appendix B.

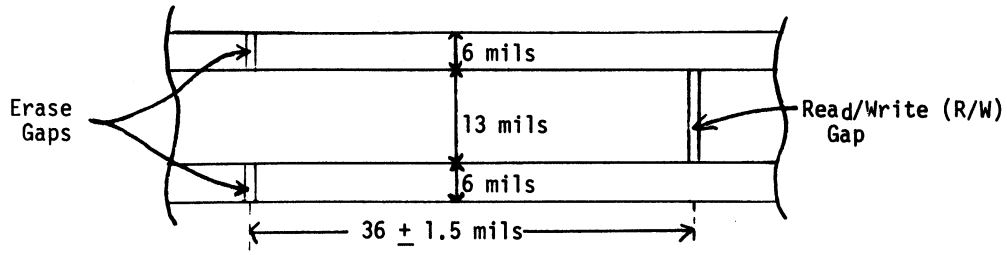

Tunnel Erase Head (Used by IBM and most drive manufacturers)

← MEDIA ROTATION ←

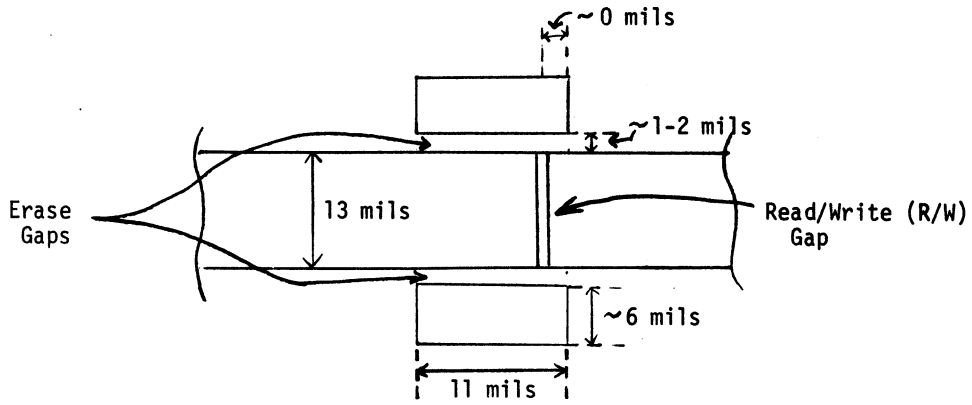

Straddle Erase Head (Used by Shugart)

Figure 1. Head Styles

Figure 1. Head Styles

## 2.2 SINGLE DENSITY SOFT SECTOR FORMATS

The modified IBM format and the Shugart format (see Appendix A for details) have the same basic form as shown in Figure 2. The modified IBM format is the full-sized "8-inch" IBM format that has been adapted by users for use with the "5.25-inch" FDD. The differences between the modified IBM format and the full-sized format are:

1. Gap 5 eliminated
2. Index Address Mark eliminated
3. Gap 1 shortened
4. Number of sectors per track reduced
5. Side address and Sector Length bytes sometimes defaulted to zeroes

The differences between the modified IBM format and the Shugart format are:

1. number of sync bytes
2. number of bytes in Gap 2 (ID Gap), Gap 3 (Data Gap), and Gap 4 (Pre-Index Gap)
3. ID Record format
4. Sizes and numbers of sectors per track

Since the Gap 2 and Gap 3 lengths of the Shugart format are less than those of the modified IBM format, the minimum gap lengths required by the straddle erase head and the tunnel erase head are now found.

### 2.2.1 Minimum Gap Lengths

The minimum gap lengths required by the tunnel erase head and the straddle erase head are shown in Table 1. The equations, variables, and drive parameters used to calculate the minimum gap lengths are defined in Appendix B.

A breakdown of the gap lengths for the tunnel erase head (Figure 3) shows the relative magnitude of the various parameters on the minimum length of Gap 2 and 3.

The two major components of Gap 2 are due to the difference in time to pass from the R/W gap to the erase gap at the innermost versus outmost track, and the circuit tolerance of the erase turn-on delay.

Gap 3 also consists of inner/outer track differences and circuit tolerance, but it additionally has two larger components: 1. a speed tolerance component, effective over the entire sector length; and 2. a component derived from delaying reliable read data processing for sector N+1 until the erase gap over sector N has been turned off.

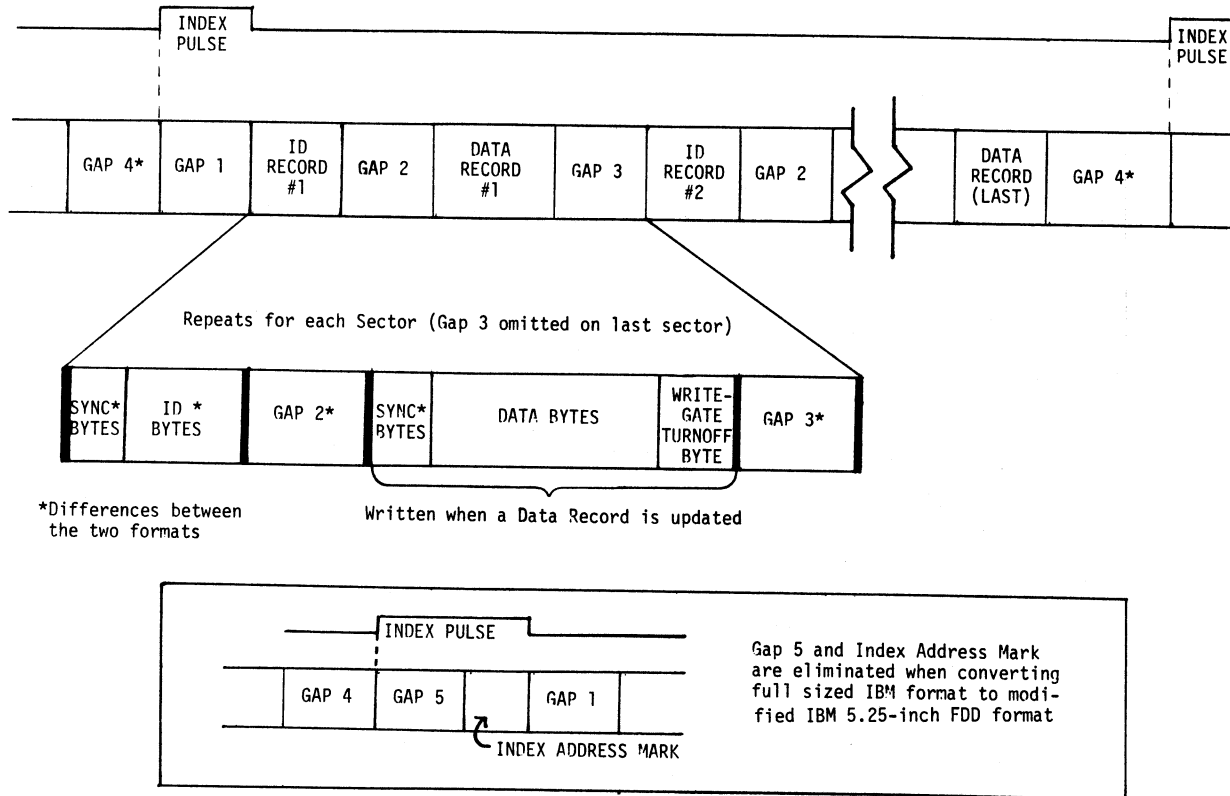

Figure 2. General Form of the Modified IBM and Shugart 5.25-Inch FDD Formats

TABLE 1. SINGLE-DENSITY 5.25-INCH FDD MINIMUM GAP SIZES

FORMAT TYPE	IBM ID (7 bytes) AND SYNC (6 bytes)								SHUGART ID (5 bytes) AND SYNC (4 bytes)			
	TUNNEL ERASE				STRADDLE ERASE				STRADDLE ERASE			
SECTOR SIZE	128	256	512	1024	128	256	512	1024	128	256	512	1024
MINIMUM GAP 1	15.6	15.6	15.6	15.6	1.6	1.6	1.6	1.6	1.6	1.6	1.6	1.6
MINIMUM GAP 2	7.6	7.6	7.6	7.6	3.7	3.7	3.7	3.7	3.7	3.7	3.7	3.7
MINIMUM GAP 3	25.6	34.8	53.2	90.1	11.5	20.7	39.1	76.0	11.5	20.7	39.1	76.0
MINIMUM GAP 4	112.5	112.5	112.5	112.5	112.5	112.5	112.5	112.5	112.5	112.5	112.5	112.5
MAX. SECTORS PER TK/ CORRESPONDING GAP 4	16/175	9/246	5/178	2/908	18/129	9/408 <sup>④</sup>	5/258	2/945	18/237	10/164	5/298	2/957
LSI CONTROLLER CAPABILITY												
W.D. 1771 GAP 1	0-*	0-*	0-*	0-*	0-*	0-*	0-*	0-*				
GAP 2	11	11	11	11	11	11	11	11				
GAP 3	0-*	0-*	0-*	0-*	0-*	0-*	0-*	0-*				
GAP 4	0-#	0-#	0-#	0-#	0-#	0-#	0-#	0-#				
MAX. SECTORS PER TK/ CORRESPONDING GAP 4	16/127	9/219	5/163	2/902	17/177	9/345	5/233	2/931				
INTEL 8271GAP 1	0-255	0-255	0-255	0-255	0-255	0-255	0-255	0-255				
GAP 2	11	11	11	11	11	11	11	11				
GAP 3	0-255	0-255	0-255	0-255	0-255	0-255	0-255	0-255				
GAP 4	0-#	0-#	0-#	0-#	0-#	0-#	0-#	0-#				
MAX. SECTORS PER TK/ CORRESPONDING GAP 4	16/127	9/219	5/163	2/902	17/177	9/345	5/233	2/931				
NEC 765 <sup>①</sup> GAP 1	26	26	26	26	26	26	26	26				
GAP 2	11	11	11	11	11	11	11	11				
GAP 3	0-255	0-255	0-255	0-255	0-255	0-255	0-255	0-255				
GAP 4	0-#	0-#	0-#	0-#	0-#	0-#	0-#	0-#				
MAX. SECTORS PER TK/ CORRESPONDING GAP 4	15/258 <sup>⑤</sup>	9/162	4/708 <sup>⑤</sup>	2/845	16/280 <sup>④</sup>	9/274	5/162	2/860				
W.D. 1791 <sup>②</sup> GAP 1	16-*	16-*	16-*	16-*	16-*	16-*	16-*	16-*				
GAP 2	11	11	11	11	11	11	11	11				
GAP 3	10-*	10-*	10-*	10-*	10-*	10-*	10-*	10-*				
GAP 4	16-#	16-#	16-#	16-#	16-#	16-#	16-#	16-#				
MAX. SECTORS PER TK/ CORRESPONDING GAP 4	16/127	9/219	5/163	2/902	17/163	9/331	5/219	2/917				

#WRITES UNTIL INDEX PULSE IS SENSED

\* UPPER LIMIT DETERMINED BY SOFTWARE WHEN FORMATTED

- ① 765 CAN'T OMIT GAP 5 AND INDEX ADDRESS MARK
- ② SOME VERSIONS HAVE THE 1771 GAP CAPABILITY
- ③ DELETED NOTE.
- ④ BORDERLINE CASE THAT COULD INCLUDE ANOTHER SECTOR
- ⑤ ADDITIONAL SECTOR PER TRACK CAN BE OBTAINED IF RMS VALUE OF GAP 3 is used.

ZZ133a

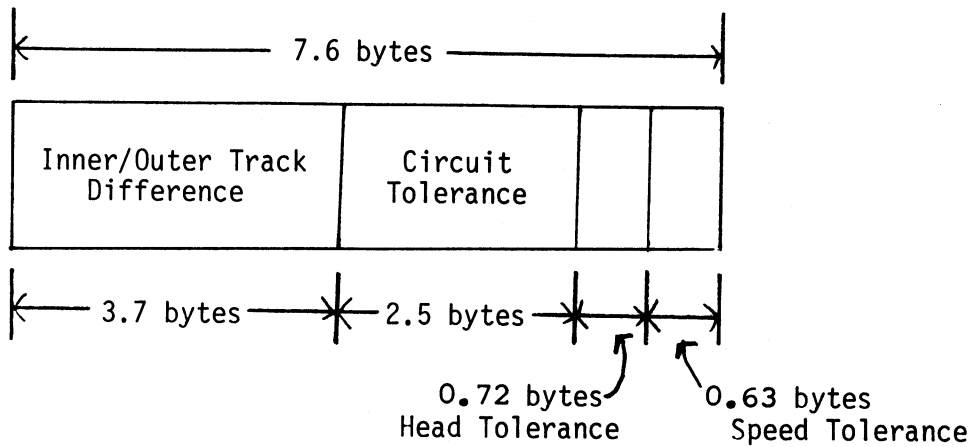

Gap 2

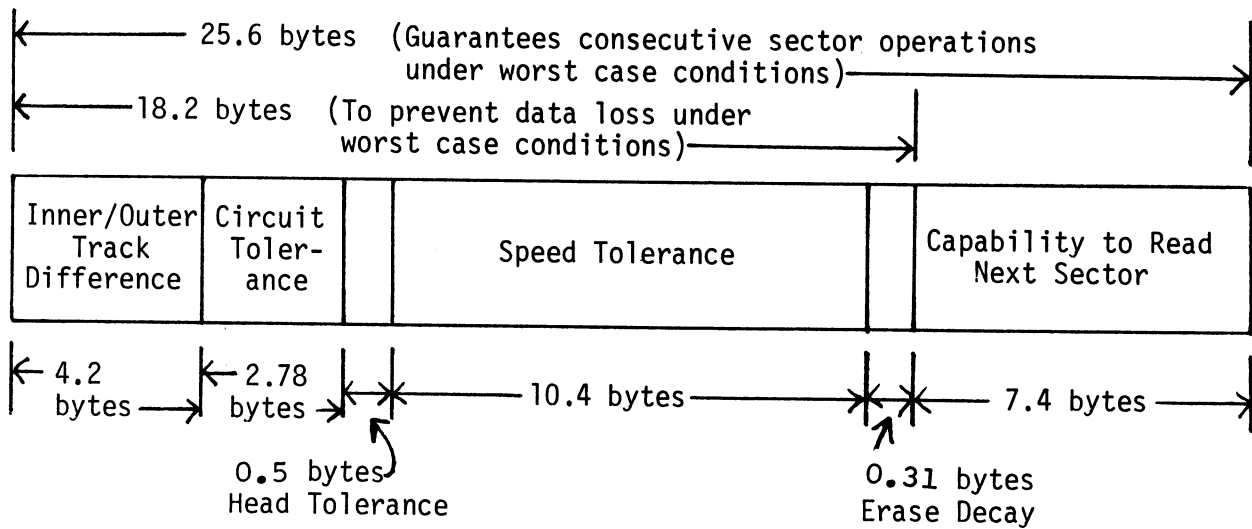

Gap 3

Figure 3. Breakdown of Minimum Gap Lengths (For Tunnel Erase Head)

### 2.2.2 LSI Controller Capability (Single Density, Soft Sector)

The LSI controllers are not capable of handling the 18-sector Shugart format recommended for their SA400 because of one or more of the differences between the Shugart and the modified IBM formats. None of the controllers are compatible with the Shugart ID Record format. The gap length variability and maximum sectors-per-track capacity for the four LSI controller chips computed for the two head styles, are shown in Table 1; also shown are the minimum gap lengths and respective sector counts. Because Gap 5 can't be eliminated by the NEC765, the RMS value of Gap 3 min must be used to obtain the same number of sectors per track that the other controllers obtain with the tunnel erase head and worst case gap lengths. The NEC 765 also obtains one sector less when used with the straddle erase head and 128-byte sectors, when compared with the straddle erase head and the other LSI controllers, but this is a borderline situation that could be done either way. That is, if another sector per track was added, the resultant Gap 4 length would not meet the worst case value, although it is so close that no significant change in reliability of format operations would be noticed.

These calculations show that, except for 128-byte sectors the straddle erase head and tunnel erase head obtain the same number of sectors per track when using the LSI controller chips.

### 2.3 DOUBLE DENSITY SOFT SECTOR FORMATS

There is very little information available about double density formats for 5.25-inch FDD's. IBM doesn't have a 5.25-inch FDD production, and there was no information found about a unique double density 5.25-inch FDD format recommended by Shugart comparable to their unique 18-sector SA400 single density format. The LSI controller data sheets make very little mention of a double density 5.25-inch FDD format other than it must basically be derived from the full-sized IBM format. Reducing the number of sectors per track and the lengths of Gap 3 and Gap 4 are the only variations from the IBM full-sized double density format that are within the capability of all the LSI controllers. As in the case of the single density format, the NEC 765 is the only controller that is not capable of deleting Gap 5. If the full-sized IBM double density format is modified in the same manner as the IBM single density format is modified, the format shown in Figure 10 (Appendix A) results. If this format and the values obtained by doubling the Table 1 minimum gap lengths (unless restricted by the LSI controllers) are used, then the sectors per track shown in Table 2 results.

TABLE 2 - SECTORS PER TRACK WITH DOUBLE DENSITY FORMAT

HEAD	TUNNEL ERASE			STRADDLE ERASE		
Sector Length	256	512	1024	256	512	1024
Sector per track with min gaps	16	9	5	18	10	5
Using NEC 765	16	9	5	17	9	5
Using 1791	16	9	5	17	9	5



## 2.4 HARD SECTOR FORMAT CONSTRAINTS

Hard sector formats will be examined and the constraints placed upon them by the drive will be defined. Detailed discussion of the drive parameters and derivation of the equations is in Appendix B.

Hard sector formats use sector holes in the diskette to separate the track into sectors. The mechanical and electrical parameters of flexible disk drives and media require the format to consist of three parts: 1. Preamble, 2. User Data, 3. Postamble.

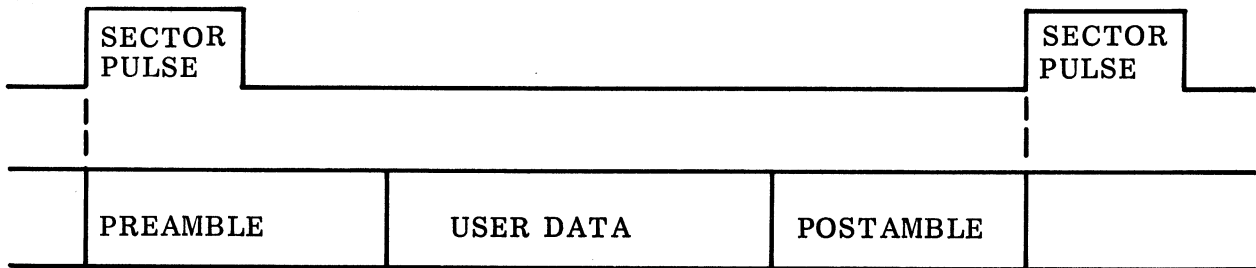

FIGURE 4 - TYPICAL HARD SECTOR FORMAT

The Preamble consists of a defined number of gap bytes that are written starting at the beginning of the sector pulse. The Preamble length is defined so that under worst case conditions User Data will not be lost due to sector pulse jitter or erase turn-off or on.

User Data consists of data and whatever overhead (sync bytes, ID bytes, CRC bytes, or write-gate turn-off bytes) used by the particular format. It and the Preamble are both written each time a sector is updated.

A buffer zone, or Postamble is required at the end of a sector between the User Data and the earliest sector pulse. The Postamble can be either left blank (controller stops writing at end of User Data), or it can be written with gap characters (controller stops writing at next sector pulse).

The lengths of the Preamble, User Data, and Postamble are dependent upon which head type is used and which method is used to terminate sector writing. Leaving the Postamble blank permits a larger User Data space per sector and is recommended. Table 3 summarizes the hard sectored format parameters. Three cases are shown for the tunnel erase head: 1. read-after-write operation guaranteed under worst case conditions; 2. only guaranteed that no data will be lost under worst case conditions; and 3. a compromise between the other two cases which uses RMS values of sector length variation due to speed tolerances and sector pulse jitter. If a case 3 value is less than a case 2 value, it is defaulted to a case 2 value. Therefore when case 3 values are used, it can be guaranteed that no data will be lost under worst case conditions although a read-after-write operation can't be guaranteed as worst case conditions are approached. Ten 256-byte sec-

tors can be easily obtained when using the minimum recommended format (see Table 3 and Figure 5) however, when the Postamble is written with zeroes the RMS values must be used to obtain 10 256-byte sectors. Case 1 values can be used in all other situations.

## 2.5 SINGLE-BOARD 5.25-INCH FDD CONTROLLERS

Several single board controllers were studied to determine their format compatibility with the 9408. Both hard and soft formats were found in use. The controllers using soft sector formats are based on LSI controllers and are capable of varying the gap lengths as required by the user. They are therefore compatible with the 9408. The controllers using hard sector formats do not have programmable parameters but are compatible with the 9408 although in one case a latency could occasionally occur when a read of the sector following the sector being written is attempted under worst case conditions. Detailed discussion of each controller studied follows.

### 2.5.1 Intel iSBC 204

The SBC 204 single density controller is based on the Intel 8271 which is not capable of handling the Shugart 5.25-inch FDD format because of the differences in the ID Record, number of sync bytes and length of Gap 2. The SBC 204 is designed for the IBM format; however, the format shown in the SBC 204 reference manual has 18 sectors with Gap 3 and 4 lengths of 11 and 24 bytes, respectively. This is not a practical format because 112.5 bytes are required for Gap 4 with a typical 3.6% drive rotational speed tolerance. Therefore, this format is not compatible with either the SA400 or the 9408.

### 2.5.2 SD Sales Versafloppy

The Versafloppy is based on the WD 1771 which does not process the Shugart 5.25-inch FDD format. The I/O driver software listing supplied by SD Sales uses an 18-sector format similar to the modified IBM format. The differences are:

1. "00"s used as gap bytes
2. Gap 1 equals 14 bytes (versus 16 bytes recommended)
3. Gap 3 equals 14 bytes (including sync bytes versus 26 bytes recommended plus sync bytes)
4. Gap 4 equals 77 bytes nominal (versus 112.5 bytes recommended)

Use of these Gap 1 and 3 parameters may introduce hard error when used with a tunnel erase head. The Gap 4 length of 77 bytes is not within the 112.5 byte worst case requirement of the 9408 or SA400. This will occasionally prevent a track format operation from being successfully completed, and which may or may not be completed after retries. However, the above format parameters are software constants and can be easily changed by the user if so desired.

TABLE 3. Hard Sector Format Parameters <sup>①</sup>

Head Style		Straddle Erase		Tunnel Erase					
				Case 1		Case 2		Case 3	
Postamble		Blank	Zeroes	Blank	Zeroes	Blank	Zeroes	Blank	Zeroes
④ 16 sectors per track	Minimum Preamble	8.3	9.9	8.3	23.9	8.3	16.6	8.3 <sup>②</sup>	21.5
	Maximum User Data	170.0	166.7	156.0	148.4	163.4	155.7	160.5	153.2
	Minimum Postamble	8.6	10.4	22.7	14.7	15.3	14.7	20.6	14.7 <sup>②</sup>
10 sectors per track	Minimum Preamble	8.3	9.9	8.3	23.9	8.3	16.6	8.3 <sup>②</sup>	21.5
	Maximum User Data	283.1	297.7	269.0	261.4 <sup>③</sup>	276.4	268.7	274.7	266.2
	Minimum Postamble	12.8	14.6	26.9	18.9	19.5	18.9	23.6	18.9 <sup>②</sup>

- ① Number of bytes given for single density. Double for double density.
- ② Defaulted to corresponding worst-case-without-read value since RMS result is smaller.
- ③ Unable to use recommended hard sector format.
- ④ Hard-sectored 5.25 inch FDD diskettes only available with 10 or 16 sectors per track.

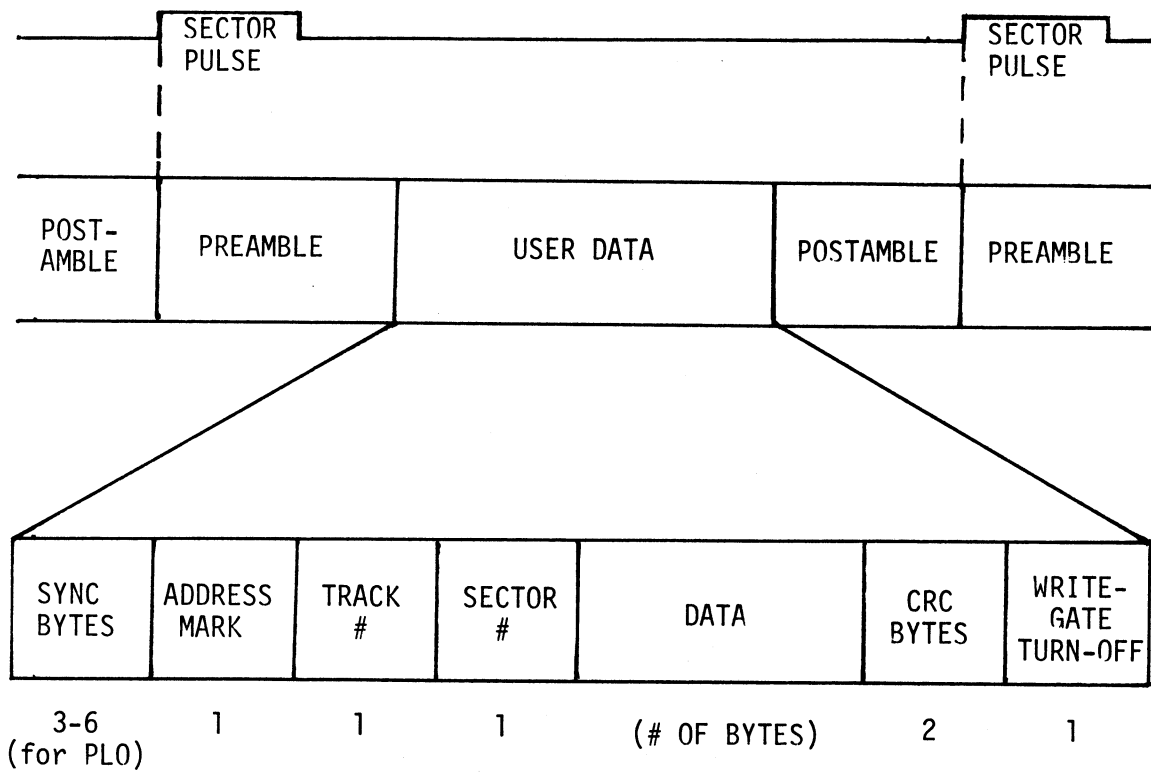

Figure 5. Recommended Minimum Hard Sector Format

### 2.5.3 Micropolis 1071 Controller

The 1071 controller is capable of single density and double density (MFM) operation using a 16-sector hard sectored format. The double density format is shown in Figure 6. There is not a gap between the ID and the Data so the ID must be written each time the Data is written. This format is compatible with the 9408 only by the fact that under worst-case conditions no data will be destroyed, although the Preamble length could have easily been increased to effect full worst-case compatibility. A read of the sector following the sector being written can not be guaranteed under worst case conditions or even RMS conditions of sector pulse jitter and speed tolerance. Note however, that: 1. it is not know whether a read of the sector following the sector being written is attempted by the software supplied by Micropolis; and 2. even if it is, only an occasional latency would be introduced. Consequently, very satisfactory performance by the 9408 could be expected when used with the 1071 (at least from the standpoint of the parameters considered herein).

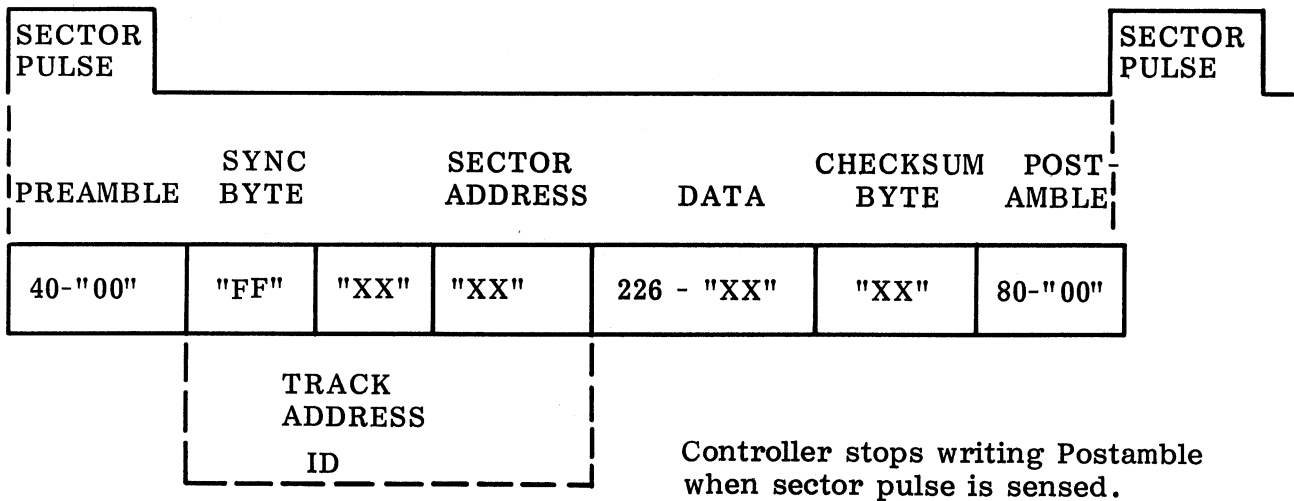
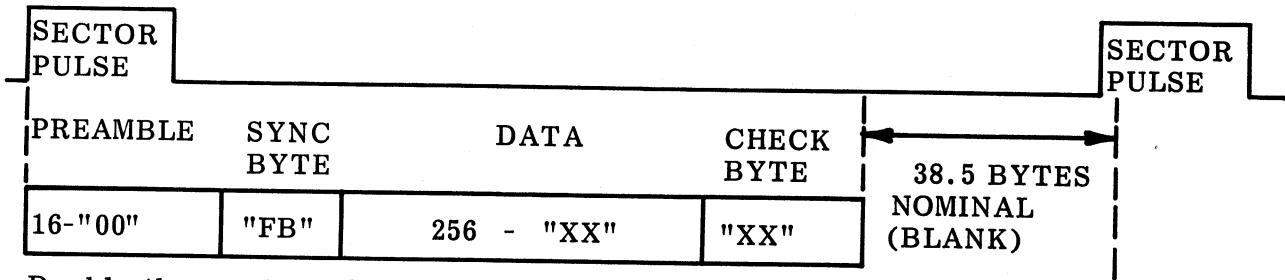

FIGURE 6 MICROPOLIS HARD SECTOR DOUBLE DENSITY FORMAT

### 2.5.4 North Star Controller

The North Star controller is a S-100 bus compatible hard sector format controller. It is capable of 256 bytes, single density, or 512 bytes, double density, per sector with 10 sectors per track. Their format which is compatible with the 9408, is

shown below:



Double the number of bytes for Double Density (except Check Byte)

FIGURE 7 - NORTH STAR HARD SECTOR FORMAT

### 2.5.5 Wameco FDC-1

This controller, to be available sometime in 1979, will be based on the 1771. The 1771 is limited to the IBM style format (see Table 1) with variation of gap 1,3, and 4 lengths allowed. Compatibility with the 9408 would be determined by the user's choice of gap lengths.

## APPENDIX A - SINGLE DENSITY AND DOUBLE DENSITY FORMATS

### A.1 Modified IBM and Shugart Single Density Formats

IBM has not defined a 5.25-inch FDD format but users have modified the IBM full size floppy format for use with the 5.25-inch FDD. The changes made are:

1. eliminating Gap 5 (gap preceding the Index Address Mark)
2. eliminating the Index Address Mark
3. shortening Gap 1 (Post Index Gap) to 16 bytes
4. reducing to 16 sectors per track when using 128 bytes per sector
5. Side address and Sector Length bytes are sometimes defaulted to zeroes.

The difference between the modified IBM format and the Shugart format are:

1. number of sync bytes
2. number of bytes in Gap 2 (ID Gap), Gap 3 (Data Gap), and Gap 4 (Pre-Index Gap)
3. sizes and numbers of sectors per tracks
4. ID Record format

Although 128 bytes per sector is normally used in the modified IBM format, sector lengths of 256, 512, and 1024 bytes are also used. The Shugart format allows for a wide range of sector lengths varying from 128 to 2971 bytes per sector.

The modified IBM format and the Shugart format are shown and compared in Figure 8. The 9408 is capable of the modified IBM format but is not capable of the Shugart format.

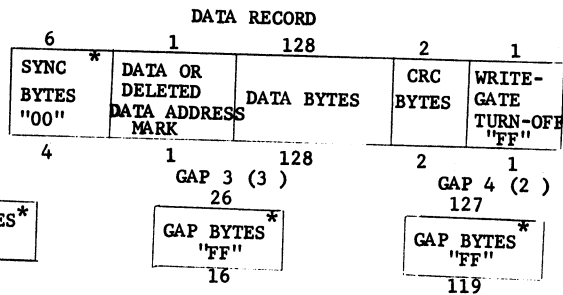
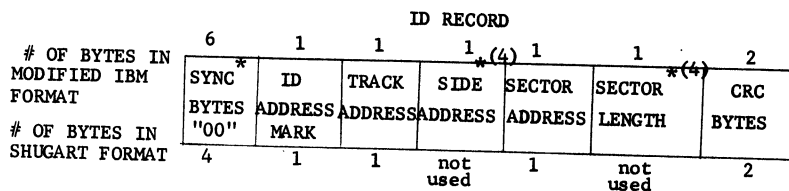
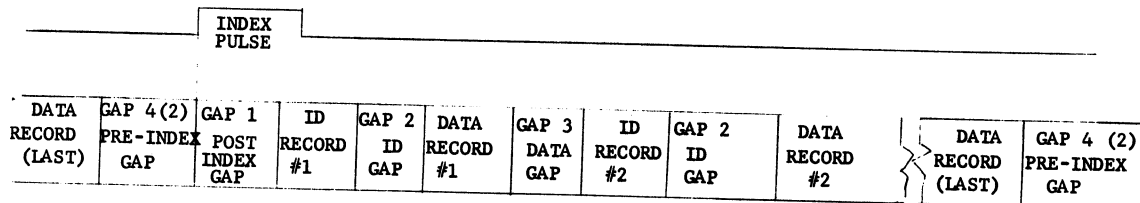

- 1. Shown for 128 bytes per sector. Modified IBM format has 16 sectors per track, Shugart format has 18 sectors per track.
- 2. Gap 4 length varies due to speed tolerances.
- 3. The length of Gap 3 varies due to speed tolerances whenever a data record is rewritten.
- 4. The Side Address and Sector Length bytes are sometimes defaulted to zeroes.
- \*. Differences between the two formats

**FIGURE 8. MODIFIED IBM FORMAT AND SHUGART SUGGESTED FORMAT FOR SINGLE DENSITY 5.25-INCH FDD DISKETTES (1.)**



## A.2 ECMA SINGLE DENSITY FORMAT

The ECMA single density format is very similar to the modified IBM 256 bytes per sector single density format. The ECMA format is different in that it allows a limited amount of variation in the length of Gap 1, 3, and 4. The ECMA format contains 204 bytes that may be distributed among the 3 gaps as desired. This is in addition to the 32 bytes minimum for Gap 3 and 64 bytes minimum for Gap 4. There is no minimum length defined for Gap 1. The 9408 is capable of this format if the 204 bytes are distributed so that Gap 4  $\geq$  113 bytes, Gap 1  $\geq$  16 bytes and Gap 3  $\geq$  35 bytes using worst case values. Gap 3 equal to 32 bytes can also be used when the RMS value of minimum Gap 3 length is used.

## A.3 DOUBLE DENSITY FORMATS

There is very little information available about double density soft sector 5.25-inch FDD formats. A unique Micropolis double density 5.25-inch FDD format is shown in Figure 9, but details were unavailable. Shugart has not defined a unique double density 5.25-inch FDD format, as they did for the single density format.

If the 8-inch IBM double-density format is adapted to 5.25-inch FDD use in the same manner that the IBM single-density format was (see section A.1), the format in Figure 10 results. The number of sectors per track with this format and with the LSI controllers is shown in Table 2 Section 2.3. The minimum gap lengths used are double the gap lengths shown in Table 1 (unless restricted by the LSI controllers).

Several hard sector double density formats were found and are described in Section 2.5. The 9408 can be used with them although with the Micropolis format an occasional latency would occur.

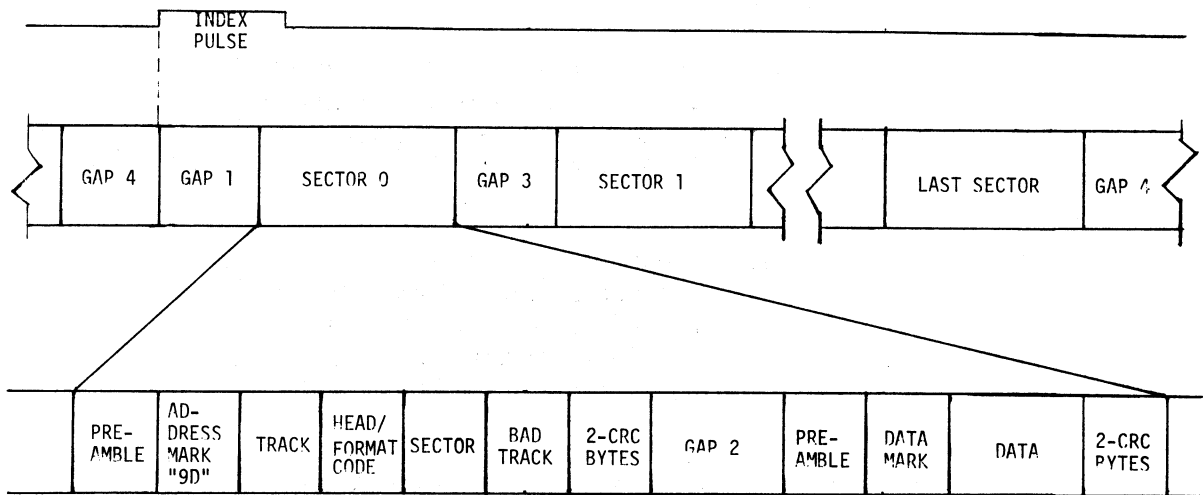

The lengths and contents of the Gaps and preamble were unavailable.

Format codes 4-7 allow an extra 12 bytes of data.

FORMAT CODE	# OF SECTORS	SECTOR LENGTH
0	32	128
1	20	256
2	11	512
3	6	1024
4	32	140
5	20	268
6	11	524
7	6	1036

Figure 9. Micropolis Double Density (GCR) 5.25-Inch FDD Format

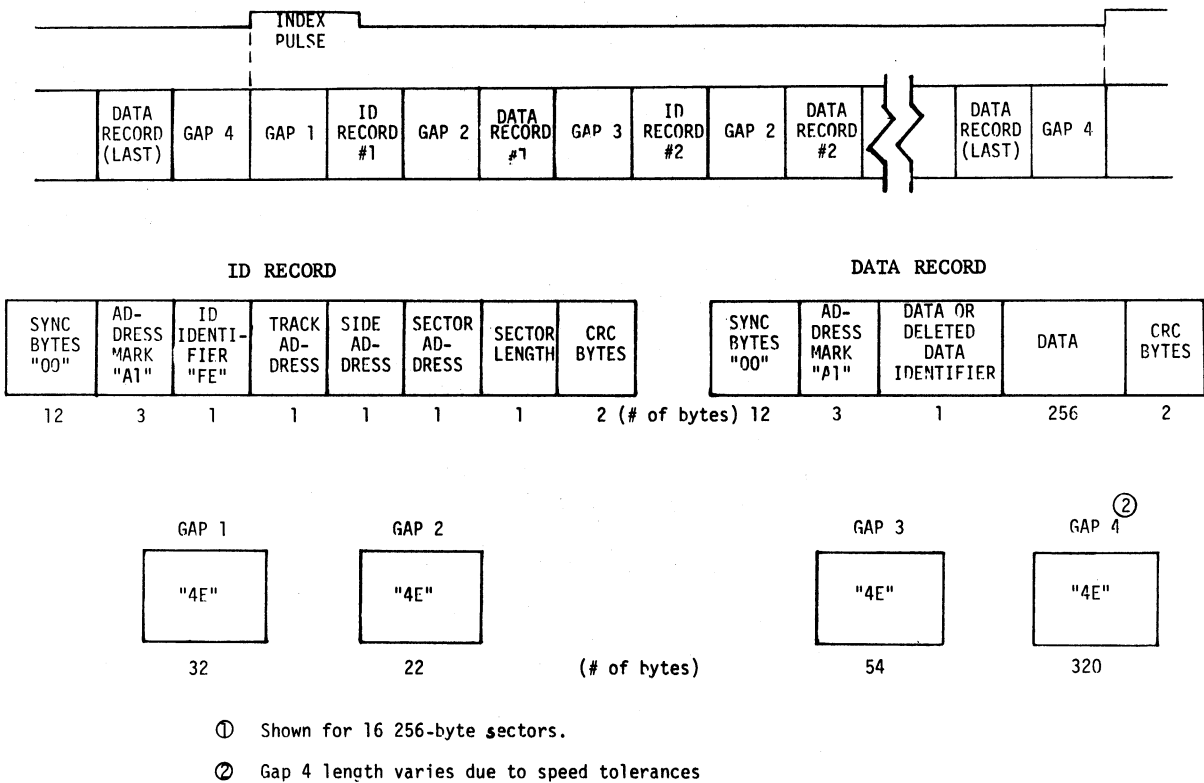

Figure 10. Possible Modified IBM Double-Density 5.25-Inch FDD Format <sup>①</sup>

## Appendix B Minimum Gap Lengths

The factors determining the minimum gap lengths required for both soft sector and hard sector formats will be defined. Each of the four gaps used in the modified IBM format will be discussed and equations for calculating the minimum gap length will be derived. The minimum Preamble and Postamble lengths are defined for several possible formats. All equations are derived for the tunnel erase head and then converted for use with the straddle erase head.

### B.1 AFFECT OF HEAD STYLE ON GAP LENGTH

Because the erase gaps of the straddle erase head are beside, or straddling, the R/W gap, more compact formats can be obtained than with the tunnel erase head where the erase gaps trail 36 mils behind the R/W gap. This is because the erase gaps can be turned on and off at the same time as the R/W gap when using the straddle erase head, whereas the turn-off of the erase gaps for the tunnel erase head must be delayed to ensure that all the data just written is tunnel erased, and a turn on delay is also required for the tunnel erase head so that the ID Record of the Data Record being written is not affected by the trailing erase gap. The minimum gap length for the straddle erase head must only take into account the maximum time to travel the length of the erase gaps, whereas for the tunnel erase head the circuit tolerances of the drive's delay logic must also be included.

### B-2 DRIVE PARAMETER AND VARIABLE DEFINITIONS

The drive parameters and variables used in the derivation and calculation of the format requirements of the drives are defined below.

GSEP	R/W gap to erase gap for tunnel erase head length of erase gap for straddle erase head
	0.036"±0.0015" tunnel erase head 0.011 straddle erase head
R	Track radius (tolerances have no significant affect)
	1.542" R inner trk 2.25" R outer trk
RPM,STOL	Diskette rotational speed, and tolerance (index pulse to index pulse) 300 r/min ± 3.6%
CTOL	Circuit Tolerance of turn-on and off delays
	±20% turn-on tunnel erase head ±10% turn-off NA straddle erase head

## B.2 (CONTINUED)

$T_{ERD}$	Erase gap decay (maximum time between erase gap turn-off to valid read signal)
	$T_{ERDT} = 20 \mu s$ tunnel erase head
	$T_{ERDS} = 100 \mu s$ straddle erase head
DRL	Data Record Length (Data plus overhead bytes)
TRKL	Track length
RMS	Root Mean Square - an accepted multiplier for obtaining a practical approximation of worst case tolerances. 0.707
$T_D$	Erase gap turn-on or off delay

## B.3 MINIMUM GAP 2 LENGTH

### B.3.1 Factors Determining Minimum Gap 2 Length

The factors that determine the minimum Gap 2 length are:

1. Head R/W gap to erase gap distance and tolerance
2. Rotational speed tolerance
3. Inner track versus outer track media speed differences
4. Circuit tolerances

The first three factors determine  $T_{max}$  and  $T_{min}$ .  $T_{max}$  is the maximum time for a point on the media to travel from the R/W gap to the erase gaps and occurs when the head is over the inner track (see Figure 11), whereas the minimum time ( $T_{min}$ ) for a point on the media to travel from the R/W gap to the erase gaps occurs when the head is over the outer track. If the erase gaps are turned on at the same time as the write gap, then Gap 2 must be at least  $T_{max} = 803 \mu s$  (12.5 bytes single density) long to avoid erasing the end of the ID Record that was just read. This is greater than the 11 bytes and 6 bytes specified in the modified IBM and Shugart 5.25-inch FDD formats, respectively, and it is also greater than the 11 bytes allocated by the LSI controllers. Therefore, an erase turn-on delay is required.

When an erase turn-on delay is used the maximum turn-on delay must be less than  $T_{min}$  to ensure that all of the data being written is tunnel erased. This defines the maximum turn-on delay ( $T_{Don\ max}$ ) so the nominal turn-on delay ( $T_{Don}$ ), with 20% circuit tolerance, can now be easily found.

$$T_{Don} = \frac{T_{min}}{1 + \text{circuit tolerance}} = \frac{471}{1 + 0.2} \mu s = 392.5 \mu s.$$

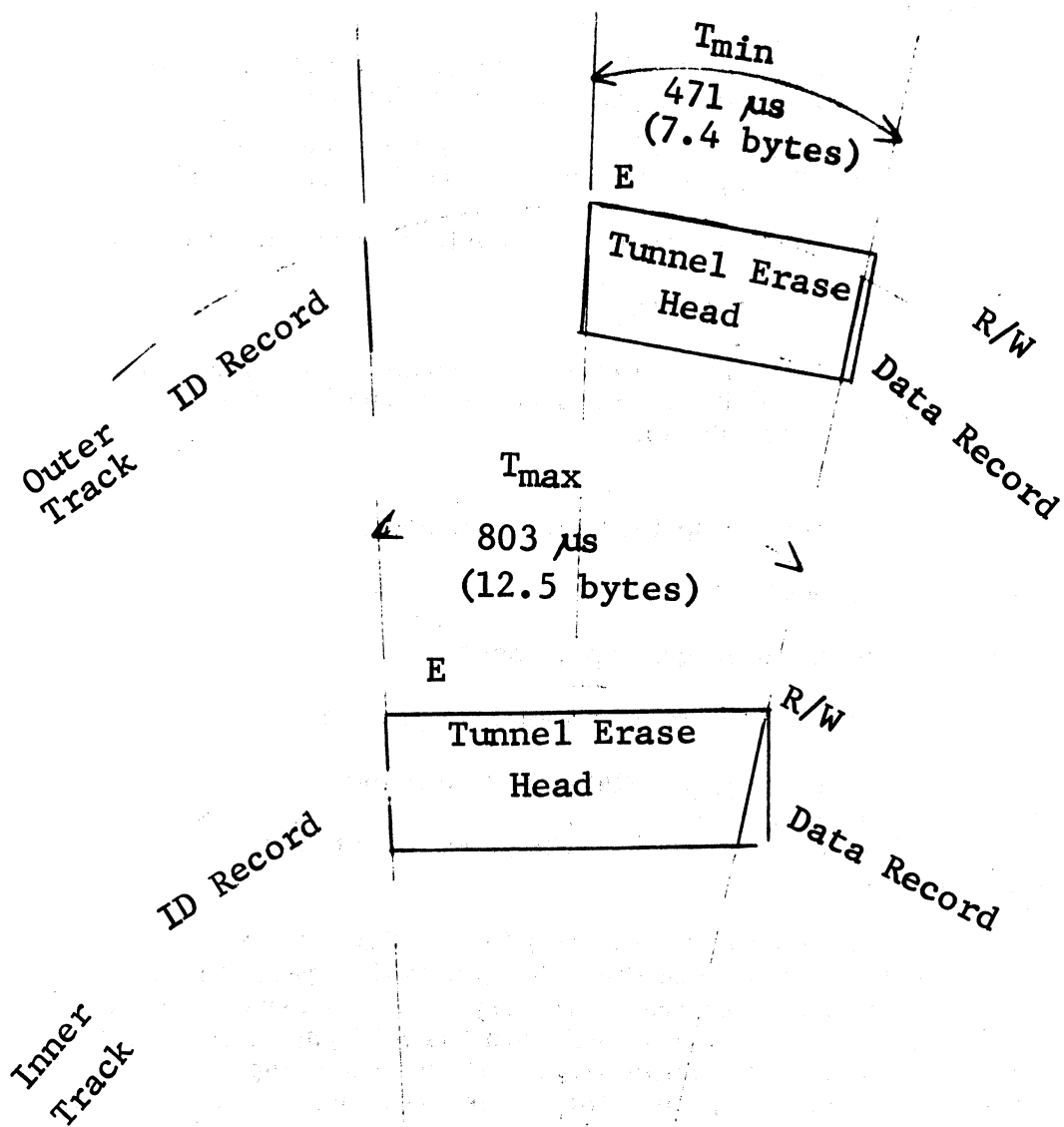

FIGURE 11. Minimum and Maximum Time to Pass Under Head (Gap 2)

B.3.1 (Continued)

With a  $\pm 20\%$  circuit tolerance applied to the nominal turn-on delay  $314 \mu\text{s} \leq$  turn-on delay  $\leq 471 \mu\text{s}$ .

With the turn-on delay determined, the minimum Gap 2 length can be found. In Figure 12 it is shown that with the head positioned over the inner track the erase gaps turn on before they reach the point at which writing started. The minimum erase turn-on delay and the maximum time ( $T_{\text{max}}$ ) to travel from the R/W gap to the erase gaps determine the minimum Gap 2 length. The minimum Gap 2 length is found by subtracting  $T_{\text{Don min}}$  from  $T_{\text{max}}$ :

$$\text{Gap 2 min} = 803 - 314 = 489 \mu\text{s} \quad (7.6 \text{ bytes single density})$$

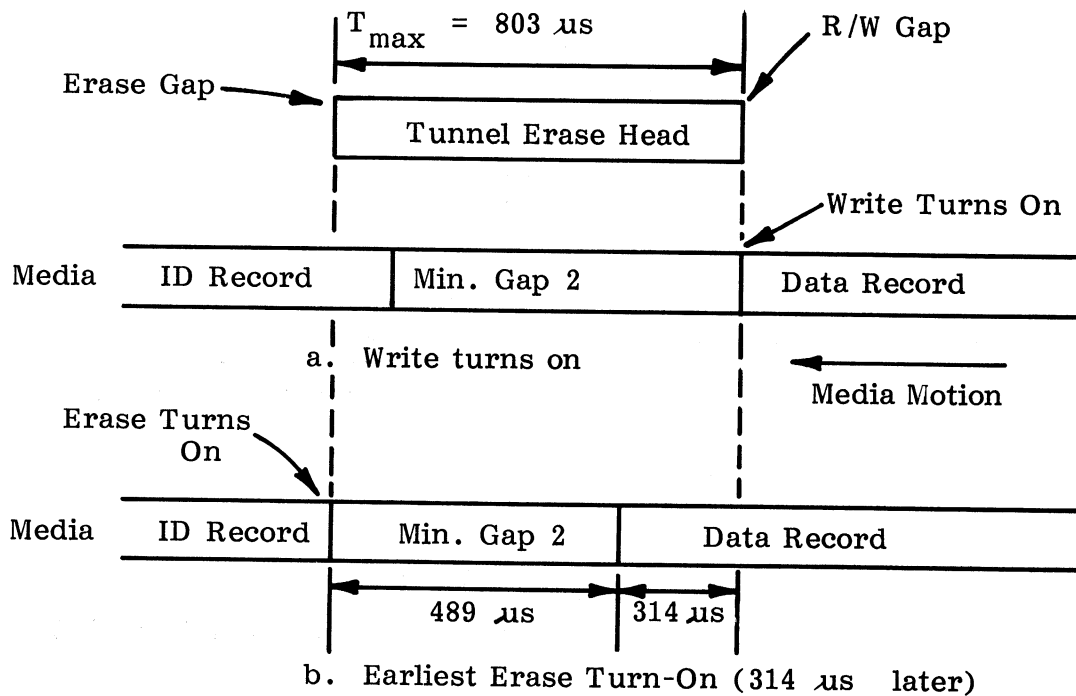

FIGURE 12. Side View of the Media and Head at the Inner Track (Gap 2)

### B.3.2 Minimum Gap 2 Length Equations

A general equation is now derived that can be used to find the minimum Gap 2 length in terms of the parameters that determine it. Starting with the result just found:

$$\begin{aligned} \text{Gap 2 min} &= T_{\text{max}} - T_{\text{Don min}} \\ &= T_{\text{max}} - (T_{\text{min}} - 2 (T_{\text{min}} - T_{\text{Don}})) \\ &= T_{\text{max}} - T_{\text{min}} + 2 T_{\text{min}} - \frac{2 T_{\text{min}}}{1 + \text{CTOL}} \end{aligned}$$

CTOL = circuit tolerance

$$\begin{aligned} &= T_{\text{max}} + T_{\text{min}} \left( 1 - \frac{2}{1 + \text{CTOL}} \right) \\ &= T_{\text{max}} + T_{\text{min}} \left( \frac{\text{CTOL} - 1}{1 + \text{CTOL}} \right) \end{aligned}$$

$$\text{Gap 2 min} = T_{\text{max}} - T_{\text{min}} \left( \frac{1 - \text{CTOL}}{1 + \text{CTOL}} \right)$$

Tmax and Tmin are now found:

$$T_{\text{max}} = \frac{\text{max head gap separation}}{\text{min velocity}} = \frac{\text{GESP max}}{(2\pi) \frac{(r/\text{min})}{60} (R_{\text{inner trk}}) (1-\text{STOL})}$$

STOL = speed tolerance  
R = track radius

$$T_{\text{min}} = \frac{\text{min head gap separation}}{\text{max velocity}} = \frac{\text{GESP min}}{(2\pi) \frac{(r/\text{min})}{60} (R_{\text{outer trk}}) (1+\text{STOL})}$$

Substituting in the Tmax and Tmin and factoring:

$$\begin{aligned} \text{Gap 2 min} &= \left[ \frac{60}{(2\pi) r/\text{min}} \right] \left[ \frac{\text{GSEP max}}{(R_{\text{inner trk}}) (1-\text{STOL})} \right. \\ &\quad \left. - \left( \frac{\text{GSEP min}}{(R_{\text{outer trk}}) (1+\text{STOL})} \right) \left( \frac{1 - \text{CTOL}}{1 + \text{CTOL}} \right) \right] \end{aligned}$$



### B.3.2 (Continued)

Substituting in the 9408 FDD and its tunnel erase head parameters:

$$\text{Gap 2 min} = \left[ \frac{60}{(2\pi)(300)} \right] \left[ \frac{0.0375}{(1.542)(1-0.036)} - \left( \frac{0.0345}{(2.25)(1+0.036)} \right) \left( \frac{1-0.2}{1+0.2} \right) \right]$$

$$\text{Gap 2 min} = 489 \mu\text{s} \quad (7.6 \text{ bytes single density})$$

(tunnel erase)

This is well within the 11-byte Gap 2 normally allocated by the LSI controller and the modified IBM format.

Substituting in the advertised Shugart parameters appropriate to their use of a straddle erase head:

$$\text{Gap 2 min} = \left[ \frac{60}{(2\pi)(300)} \right] \left[ \frac{0.011}{(1.542)(1-0.036)} - \left( \frac{0}{(2.25)(1+0.036)} \right) \left( \frac{1-X^*}{1+X^*} \right) \right]$$

$$\text{Gap 2 min} = 236 \mu\text{s} = 3.7 \text{ bytes}$$

(straddle erase)

\*The value of X, Shugart's drive circuit tolerance, is not important to this calculation since the T<sub>min</sub> term goes to zero with the R/W gap and erase gap leading edges being essentially coincidental.

## B.4 MINIMUM GAP 3 LENGTH

### B.4.1 Factors Determining Minimum Gap 3 Length

The same factors that determine the minimum Gap 2 length also influence the minimum Gap 3 length but there are additional considerations. As shown in Figure 13, the erase gaps must stay on at least T<sub>max</sub> μs after the last data is written to ensure that all data is tunnel erased. Therefore, the minimum turn-off delay must be greater than T<sub>max</sub>. An additional constraint that must be considered is the proposed ANSI Flexible Disk Interface Standard specification of 1000 μs maximum allowed between Write Gate turn-off and valid Read Data. Because a valid Read Data signal is not available until 20 μs after erase turn-off, the maximum erase turn-off delay is reduced to 980 μs. To meet these min/max constraints requires a circuit tolerance considerably less than 20%:

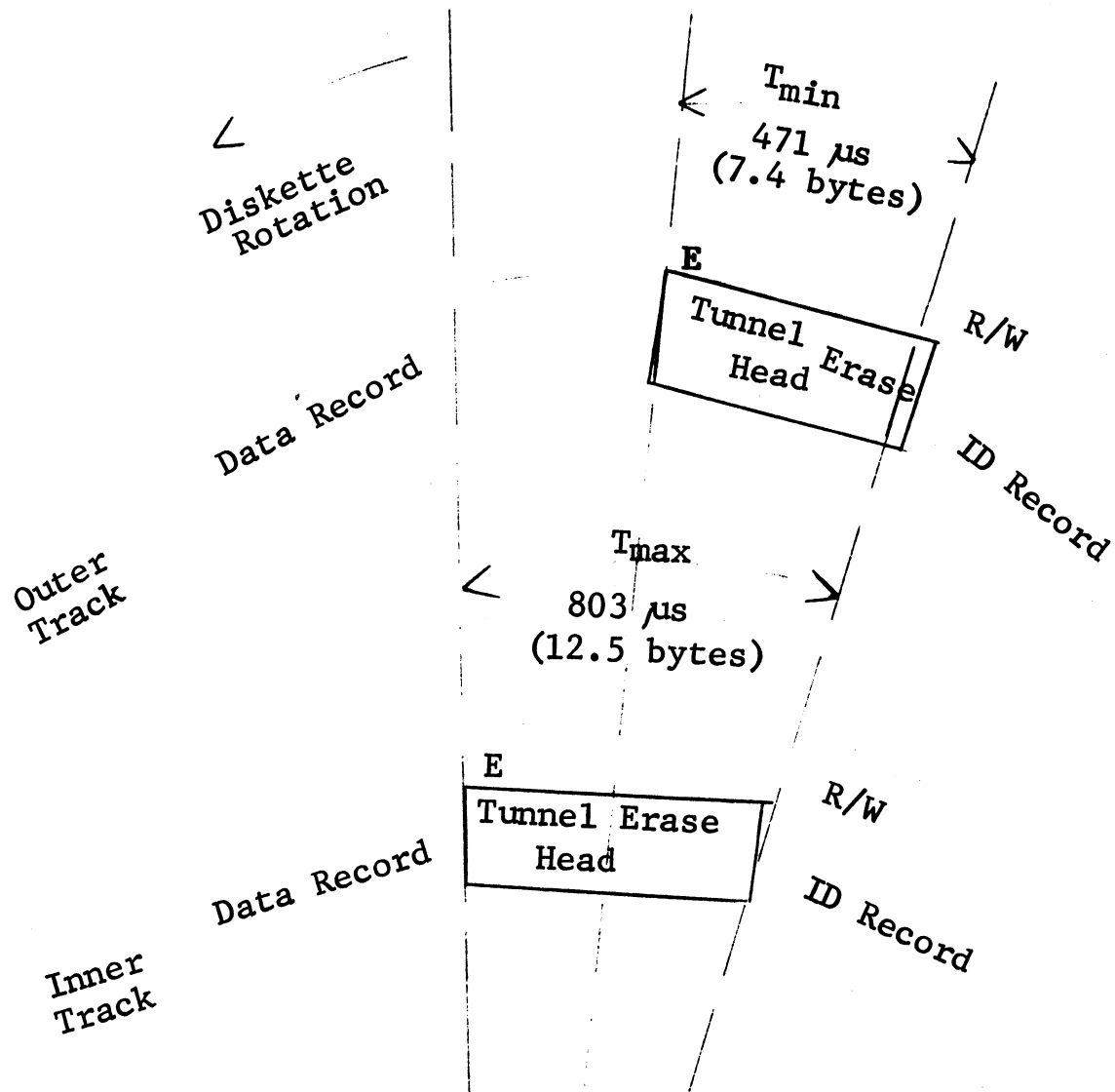

FIGURE 13. Minimum and Maximum Time to Pass Under Head (Gap 3)

B.4.1 (Continued)

$$\text{CTOL} \quad \frac{T_{\text{Doff max}} - T_{\text{Doff min}}}{T_{\text{Doff max}} + T_{\text{Doff min}}}$$

$$\text{CTOL} \quad 0.0993 = 10\%$$

and the turn-off delay

$$T_{\text{Doff}} = \frac{T_{\text{Doff max}} + T_{\text{Doff min}}}{2} = 892 \mu\text{s}$$

$$803 \mu\text{s} \leq \text{turn-off delay} \leq 980 \mu\text{s}$$

The above turn-off delay then requires Gap 3 to be at least 1000  $\mu\text{s}$  (15.6 bytes) long for the tunnel erase head.

Another factor that must be considered is the variation of the sector length due to speed tolerances. The worst case condition occurs when the diskette has been formatted at minimum rotational speed and then is updated at maximum rotational speed. (See Figure 14) When the diskette is formatted at minimum rotational speed, the end of the Data Record is shifted forward of the nominal position by DL (DL = Data Record length times the speed tolerance) and the next ID Record is also shifted forward by approximately the same amount. When the Data Record is updated at maximum rotational speed the end of the Data Record is shifted to DL past the nominal position while the beginning of the next ID Record remains fixed. Therefore, 2DL for speed tolerance impact must be added to the previously derived 1000 usec Gap 3 length.

For 128 byte sectors:

$$\begin{aligned} \text{DL} &= (\text{Data Record length}) (\text{speed tolerance}) (\text{byte time}) \\ \text{DL} &= (138) (0.036) (64) (128 \text{ bytes data} + 10 \text{ bytes overhead}) \\ &= 318 \mu\text{s} \end{aligned}$$

$$\text{or } 2\text{DL} = 636 \mu\text{s} \quad (9.9 \text{ bytes})$$

Therefore, to guarantee under worst case conditions that the next ID Record can be read requires a minimum Gap 3 of 1636  $\mu\text{s}$  (25.6 bytes) for the tunnel erase head.

(If a potential performance degradation is acceptable, a Gap 3 length less than that derived above can be used in some cases to increase the number of sectors per track. The absolute minimum requirement in Gap 3 is that the erase gap remain on long enough to tunnel-erase all the data that has been written in Sector N without the erase gap moving into the ID record of sector  $N \pm 1$ , recognizing that speed tolerances can also move the end of the Sector N Data Record toward the sector  $N \pm 1$  ID record. Referring to Figure 13, one sees that the 1000  $\mu\text{s}$  maximum erase turn-off delay and decay occurring at the outer track, will cause the erase gap to be effective up to 529  $\mu\text{s}$  past the write turnoff point, whereas at the inner track the 1000  $\mu\text{s}$  maximum is adequate to insure the 803  $\mu\text{s}$  tunnel

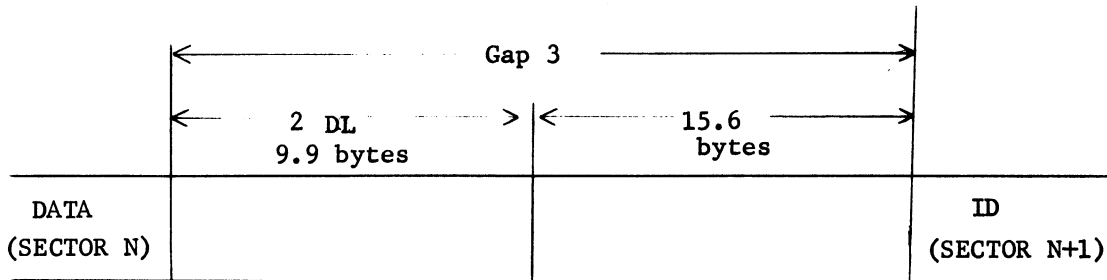

a) Nominal Positions

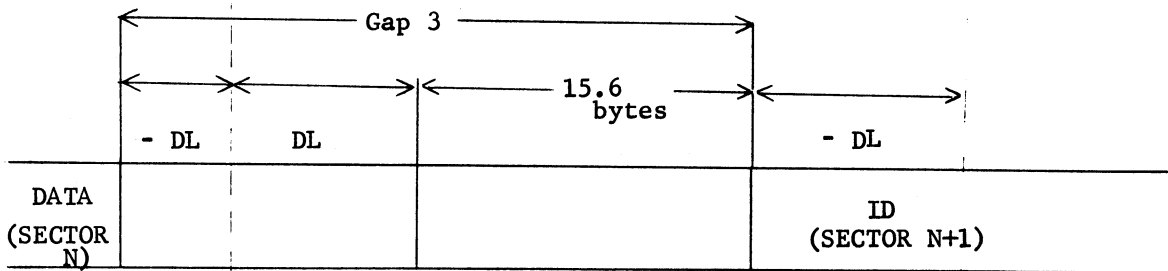

b) Positions after Format at Min. Speed

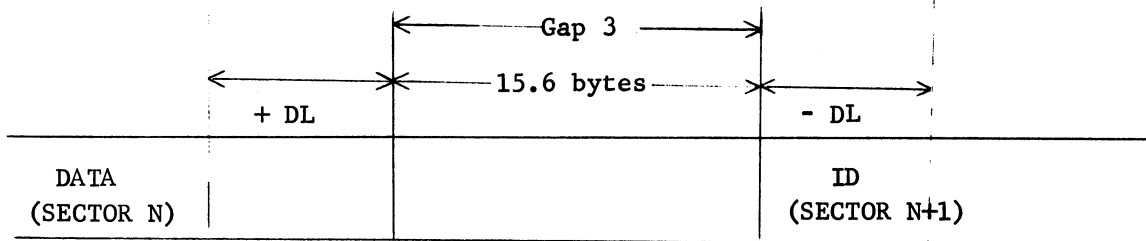

c) Positions after an Update at Max. Speed

FIGURE 14. Affect of Data Record Length Variation

#### B.4.1 (Continued)

erasure. Consequently, Gap 3 can be reduced to the 529  $\mu$ s worst-case travel beyond the write turnoff point, plus the sector length variation for speed tolerance; for the 128-byte single density example, this reduces the 1636  $\mu$ s result to 1165  $\mu$ s.

Referring again to Figure 13, it can be seen that as the head moves closer to the inner track, the probability of the read gap moving into the ID record of sector  $N\pm 1$  is reduced. Consequently, the degree to which performance is degraded is dependent upon the track number, the amount and direction of speed variation at the time of diskette formatting, the amount and direction of speed variation at the time of writing sector N, and the frequency of consecutive sector transfers. Using RMS values of the speed variation components is a compromise between such an absolute Gap 3 minimum and the worst-case Gap 3 previously discussed. Table 4 presents all cases for various record lengths.)

An erase turn-off delay is not used with the straddle erase head so only the erase turn-off decay time and the Data Record length variation determine the minimum Gap 3 length.

The minimum Gap 3 for the straddle erase head is then the sum of the erase decay time and the Data Record length variation.

#### B.4.2 Minimum Gap 3 Length Equations

The general equations for the minimum Gap 3 can now be derived and summarized. The minimum Gap 3 equation for the tunnel erase head is:

$$\begin{aligned}
 \text{Gap 3}_{\min} &= \text{max turn-off delay and decay} + \text{Data Record length variation} \\
 &\text{(tunnel erase)} \\
 &= T_{\text{Doff max}} + T_{\text{ERDT}} + 2 (\text{DRL}) (\text{STOL}) \\
 &= T_{\text{max}} + 2 (T_{\text{Doff nom}} - T_{\text{max}}) + T_{\text{ERDT}} + 2(\text{DRL}) (\text{STOL}) \\
 &= T_{\text{max}} \left( \frac{1 + \text{CTOL}}{1 - \text{CTOL}} \right) + T_{\text{ERDT}} + 2 (\text{DRL}) (\text{STOL}) \\
 \\
 \text{Gap 3}_{\min} &= \left( \frac{(60) (\text{GSEP max})}{(2\pi) (r/\text{min}) (R_{\text{inner trk}}) (1-\text{STOL})} \right) \left( \frac{1+\text{CTOL}}{1-\text{CTOL}} \right) + \\
 &\text{(tunnel erase)} \quad T_{\text{ERDT}} + 2 (\text{DRL}) (\text{STOL})
 \end{aligned}$$

The minimum Gap 3 equation for the straddle erase head is:

$$\begin{aligned}
 \text{Gap 3}_{\min} &= \text{erase decay} + \text{Data Record length variation} \\
 &\text{(straddle erase)} \\
 &= T_{\text{ERDS}} + 2 (\text{DRL}) (\text{STOL})
 \end{aligned}$$

Substituting in the 5.25-inch FDD and head parameters give:

$$\begin{aligned}
 \text{Gap 3}_{\min} &= \left( \frac{(60) (0.0375)}{(2\pi) (300) (1.542) (1-0.036)} \right) \left( \frac{1+0.1}{1-0.1} \right) + \\
 &\text{(tunnel erase)} \quad 20 + 2 (\text{DRL}) (0.036) \mu\text{s} \\
 &= 1000 + (0.072) (\text{DRL}) \mu\text{s} \\
 \\
 \text{Gap 3}_{\min} &= 100 + (0.072) (\text{DRL}) \mu\text{s} \\
 &\text{(straddle erase)}
 \end{aligned}$$

Calculations for various situations are summarized in the following table.

TABLE 4. Minimum Gap 3 Length<sup>①</sup>

SECTOR LENGTH	STRADDLE ERASE HEAD	TUNNEL ERASE HEAD		
		UNDER WORST-CASE CONDITIONS	WITH POSSIBLE PERFORMANCE LOSS; NO INTEGRITY LOSS	RMS COMPROMISE
128	11.5	25.6	18.2	22.6
256	20.7	34.8	27.4	29.2
512	39.1	53.2	45.8	45.8 <sup>②</sup>
1024	76.0	90.1	82.4	82.4 <sup>②</sup>

①. Gap lengths given in bytes for single density; double for double density.

②. RMS value less than the Possible-Performance-Loss value, so defaulted to latter.

## B.5 MINIMUM GAP 1 and GAP 4

Gap 1 precedes the first sector of the track and is required so that format operations or updates of the last sector of the track will not destroy or prevent reading the first sector of the track. A format operation is similar to the situation shown in Figure 15 for the Preamble and write turn-off. However, since the index pulse ending the format operation will occur at the same point that the index pulse started the format operation, the index pulse jitter is not required. Therefore, the minimum Gap 1 is equal to:

$$\begin{aligned}\text{GAP 1 min} &= \text{erase turn-off delay and decay.} \\ &= T_{\text{Doff max}} + T_{\text{ERDT}} \\ &= 980 + 20 \mu\text{s} \\ &= 1000 \mu\text{s} \quad (15.6 \text{ bytes})\end{aligned}$$

Gap 4 follows the last sector of the track and must account for the speed variation over the entire track. Gap 4 must be long enough that when the diskette is turning at maximum speed the last Data Record can be written before the index pulse is sensed. The minimum Gap 4 is then:

$$\begin{aligned}\text{GAP 4 min} &= (\text{track length}) (\text{speed tolerance}) \\ &= (2 \times 10^5) (0.036) \mu\text{s} \\ &= 7200 \mu\text{s} \quad (112.5 \text{ bytes})\end{aligned}$$

## B.6 HARD SECTOR FORMATS

Hard sector formats must take into account sector pulse jitter, speed variation, erase turn-on and erase turn-off in order to provide reliable operation. These factors will be examined as far as determining the minimum Preamble and Postamble and maximum User Data that is within the capability of 5.25-inch FDD.

Two types of hard sector formats will be considered:

1. Postamble left blank (controller stops writing at the end of User Data,
2. Postamble written with gap characters (controller stops writing at next sector pulse).

The case of the Postamble left blank will be considered first and the resultant equation will then be converted to the case of Postamble written with gap characters. This, and the assumption that the controller uses the leading edge of the sector pulse are the only controller parameters that will be considered.

The equations will be derived for the tunnel erase head and then will be applied to the straddle erase head for comparison purposes.



### B.6.1 Minimum Preamble for Postamble Left Blank

The minimum Preamble length is defined by a worst case condition shown in Figure 15. The condition results when a write operation is started by a sector pulse occurring early, and then later a read operation started by a late sector pulse. The minimum Preamble length must be twice the sector pulse jitter (D S) in order to read all User Data that was written.

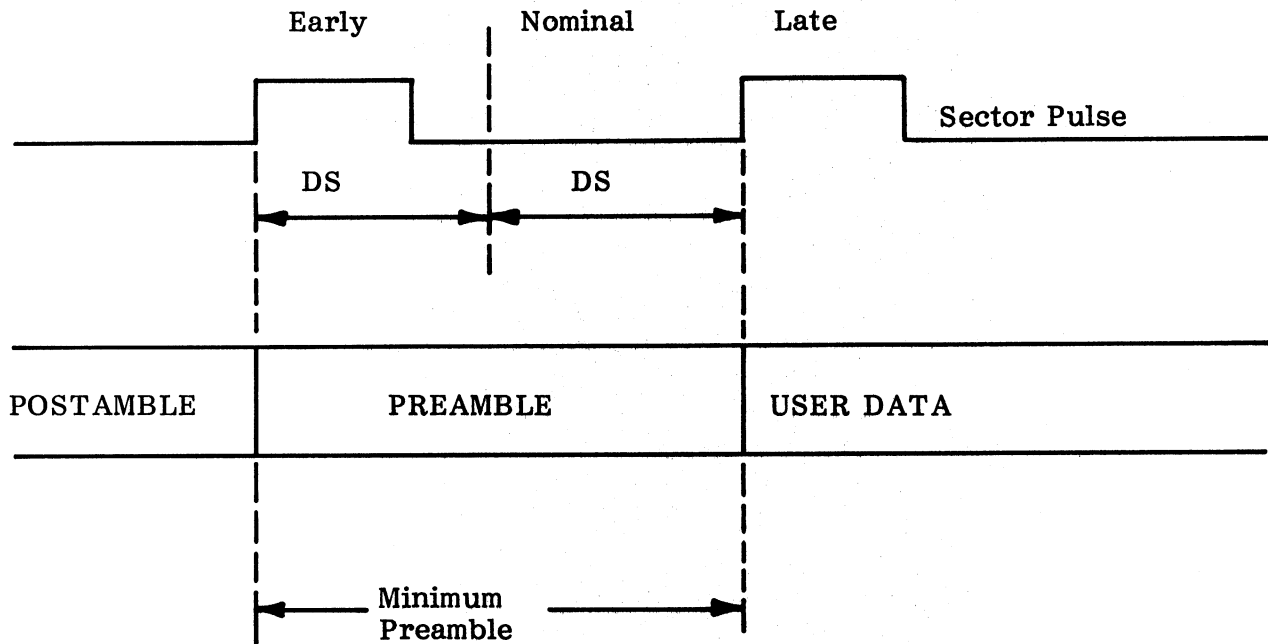

FIGURE 15. Minimum Preamble Length (For Postamble Left Blank)

$$\text{minimum Preamble} = 2 \left( \begin{array}{c} \text{sector} \\ \text{pulse} \\ \text{jitter} \end{array} \right)$$

$$T_{PR \text{ min}} = 2 T_{DS}$$

### B.6.2 Minimum Postamble for Postamble Left Blank

The minimum Postamble length is determined by the sector length variation and the erase turn-off delay and decay as shown in Figure 16. The Postamble must account for the variation of the sector length caused by the speed tolerances of the drive. The Postamble must also allow time for the erase turn-off delay and decay calculated in Section B.4.1 so that a valid read of the next sector can be performed. The minimum Postamble length is then the sum of the sector length variation and the erase turn-off delay and decay.

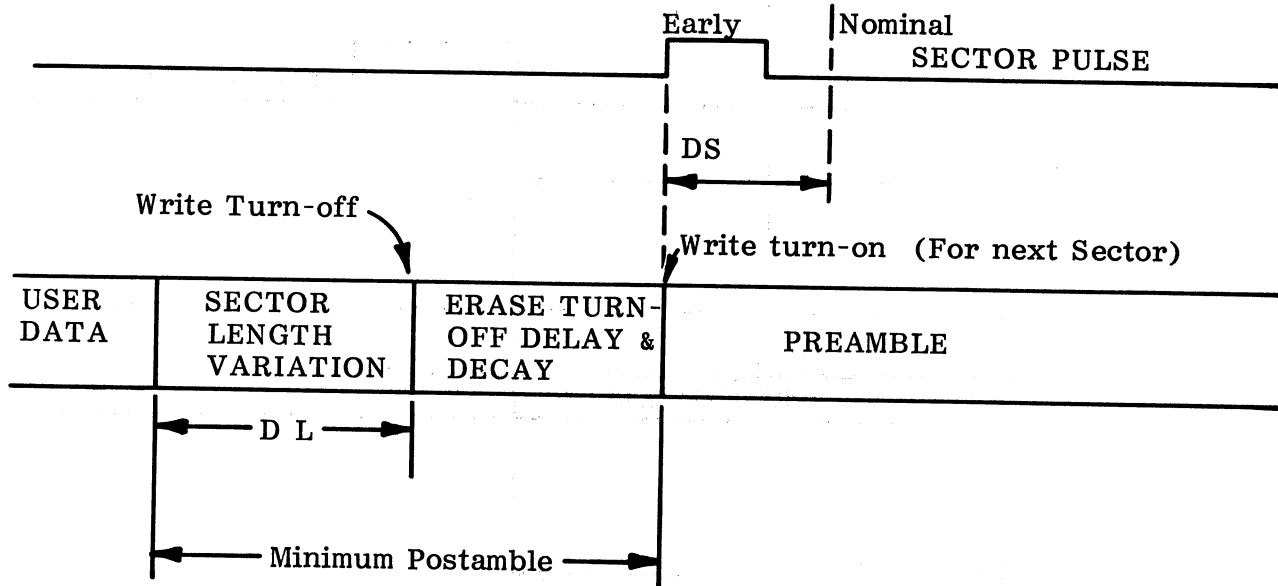

FIGURE 16. Minimum Postamble Length (For Postamble Left Blank)

minimum Postamble = sector length variation + erase turn-off delay and decay

$$T_{\text{POST min}} = T_{\text{DL}} + (T_{\text{D off max}} + T_{\text{ERDT}})$$



B.6.4 (Continued)

$$\begin{aligned} \text{minimum Preamble} &= 2 \text{ sector pulse jitter} + \text{erase turn-off delay and decay} \\ T_{PR \text{ min}} &= 2 T_{DS} + (T_{Doff \text{ max}} + T_{ERDT}) \\ \text{minimum Postamble} &= \text{sector length variation} + \text{erase turn-on} \\ T_{POST \text{ min}} &= T_{DL} + \text{Gap 2 min} \\ \text{maximum User Data} &= \text{nominal sector length} - 2 \text{ sector pulse jitter} - \text{minimum Preamble} - \text{minimum Postamble} \\ T_{UD} &= T_{SL} - 2T_{DS} - T_{PR \text{ min}} - T_{POST \text{ min}} \end{aligned}$$

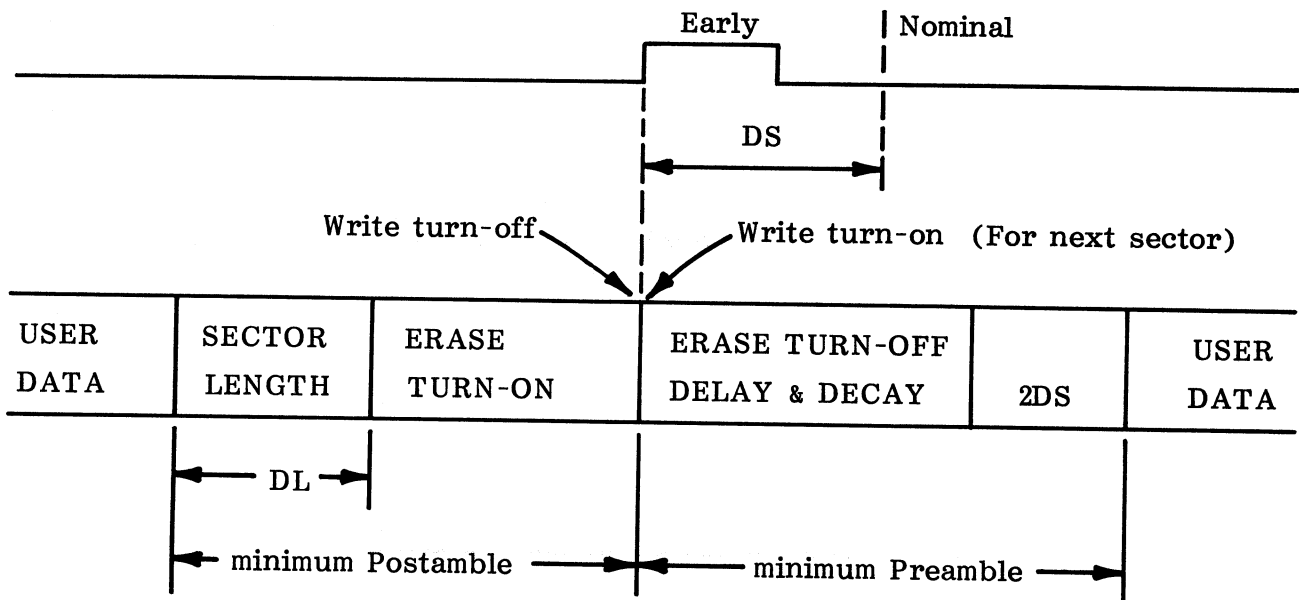

FIGURE 17. Minimum Postamble and Preamble Length (For Postamble Written with Gap Characters)

### B.6.5 Straddle Erase Head Capability

When the equations derived above for the tunnel erase head are used for the straddle erase head, three changes must be made. The erase turn-off delay is omitted because it is not used with the straddle erase head. The erase gap decay time for the straddle erase head ( $T_{HERDS}$ ) must be used instead of the erase gap decay time for the tunnel erase head. The minimum erase turn-on allowance (Gap 2 min) for the straddle erase head must be used instead of the value for the tunnel erase head. With these changes made, the results for the straddle erase head are shown in Table 3.

### B6.6 Hard Sector Format Calculations

The definition of the 5.25-inch FDD parameters involved in the equations already derived are shown as well as an example of the calculated values summarized in Table 3. The values used for the three cases

1. Worst case Conditions
2. With Possible Performance Loss but no Integrity Loss and
3. Compromise using RMS values of sector length variation due to speed tolerance and sector pulse jitter) with the tunnel erase head are also defined.

The components that make up the worst case sector pulse jitter are calculated using the proposed ANSI 5.25-inch FDD media Standard specifications and the alignment tolerances of the present full-sized drive. The worst case sector pulse jitter is then:

sector hole location tolerance	$\pm 33.6 \mu\text{s}$
sector hole radius tolerance	$\pm 33.0 \mu\text{s}$
diskette centering (diskette and drive tolerances)	$\pm 79.6 \mu\text{s}$
index transducer alignment	$\pm 100 \mu\text{s}$
alignment diskette tolerance	$\pm 20 \mu\text{s}$
<hr/>	
Total sector pulse jitter	$\pm 266.2 \mu\text{s}$

The sector length variation is calculated by dividing the track length variation due to the 3.6% speed tolerance by the number of sectors per track.

The values for the tunnel erase turn-on gap and the erase turn-off delay and decay are calculated in Sections B.3.1 and B.3.4.1 and are  $489 \mu\text{s}$  and  $1000 \mu\text{s}$  respectively. This erase turn-on gap is used because this is the minimum time required to prevent the erase gap turn-on from destroying User Data of the previous sector. The erase turn-off delay and decay is the minimum time between write turn-off and a valid read signal. If a potential performance degradation is acceptable (see insert in section B.4.1)  $529 \mu\text{s}$  can be used instead of the  $1000 \mu\text{s}$  allowance for erase turn-off delay and decay. A compromise between these two cases can be obtained by using the RMS of the sector length variation due to sector pulse jitter and speed tolerance. (The RMS values are defaulted to the absolute minimum values if they are less.) Using the RMS values may increase

B.6.6 (continued)

the soft error rate.

The values for the straddle erase head turn-on gap and turn-off decay are discussed in Section B.3.1 and B.4.1 and are 214  $\mu\text{s}$  and 100  $\mu\text{s}$  respectively. The RMS values can't be used with straddle erase head because hard errors could occur under worst case conditions.

An example of the calculations used to derive Table 3 is shown below. It is for the case of the tunnel erase head and Postamble left blank. The number of bytes are given for single density and must be doubled for double density.

$$\begin{aligned}
 T_{\text{PR min}} &= 2 T_{\text{DS}} \\
 &= 2 (266.2) \mu\text{s} \\
 &= 532.4 \mu\text{s} \quad (8.3 \text{ bytes}) \\
 T_{\text{POST min}} &= T_{\text{DL}} + (T_{\text{Doff max}} + T_{\text{ERDT}}) \\
 &= \frac{7200}{N} + (980 + 20) \mu\text{s}
 \end{aligned}$$

$N = \#$  of sectors

$$= 1450 \mu\text{s} \quad (22.7 \text{ bytes}), N = 16$$

$$= 1720 \mu\text{s} \quad (26.9 \text{ bytes}), N = 10$$

$$\begin{aligned}
 T_{\text{UD}} &= T_{\text{SL}} - 2 T_{\text{DS}} - T_{\text{PR min}} - T_{\text{POST min}} \\
 &= \frac{2 \times 10^5}{N} - 2(266.2) - 532.4 - T_{\text{POST min}} \mu\text{s}
 \end{aligned}$$

$$= 9985 \mu\text{s} \quad (156.0 \text{ bytes}), N = 16$$

$$= 17215 \mu\text{s} \quad (269.0 \text{ bytes}), N = 10$$



STAPLE

STAPLE

FOLD

FOLD

**BUSINESS REPLY MAIL**  
 No Postage Stamp Necessary If Mailed in the United States

POSTAGE WILL BE PAID BY

**MAGNETIC PERIPHERALS, INC.**

P.O. BOX 12313

OKLAHOMA CITY, OKLAHOMA 73157

FIRST CLASS  
 Permit Number 1332  
 OKLAHOMA CITY,  
 OKLAHOMA

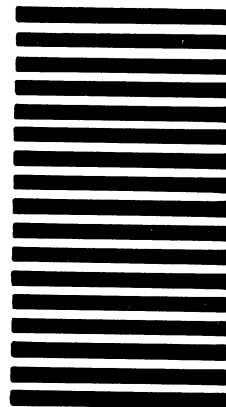

CUT ALONG LINE

Attention: *Flexible Disk Applications Engineering, OKM269*

FOLD

FOLD