

**INTERFACE SPECIFICATION
FOR
WREN II - SCSI
(SASITM SUBSET)
MODEL 94151**

Section and right
license information
and other details
related to the license

COPYRIGHT © 1985
by MAGNETIC PERIPHERALS INC.

ALL RIGHTS RESERVED

Printed in the United States of America

This publication may contain application, high technology, or product specification data, or any combination thereof, is considered advance technical information by the producer, and is subject to change without prior notice.

SECRET

TOP SECRET

SECRET

NOVEMBER 1954

SECRET



SECRET

INTERFACE SPECIFICATION
FOR
WREN II - SCSI
(SASITM SUBSET)
MODEL 94151

TABLE OF CONTENTS

1.0	SCOPE.....	4
2.0	APPLICABLE DOCUMENTS.....	5
3.0	GLOSSARY AND CONNECTIONS.....	5
3.1	GLOSSARY.....	5
4.0	PHYSICAL CHARACTERISTICS.....	7
4.1	PHYSICAL DESCRIPTION.....	7
4.2	CABLE REQUIREMENTS.....	8
4.2.1	Single-Ended Cable.....	8
4.3	CONNECTOR REQUIREMENTS.....	10
4.4	ELECTRICAL DESCRIPTION.....	10
4.5	SASI BUS.....	12
4.6	SASI BUS SIGNALS.....	13
4.6.1	Signal Values.....	15
4.6.2	Signal Sources.....	15
4.7	SASI BUS TIMING.....	16
4.7.1	Bus Settle Delay.....	17
4.7.2	Cable Skew Delay.....	17
4.7.3	Deskew Delay.....	17
4.7.4	Reset Hold Time.....	17
5.0	LOGICAL CHARACTERISTICS.....	17
5.1	SASI BUS PHASES.....	17
5.1.1	Bus Free Phase.....	18
5.1.2	Intentionally Not Used.....	18
5.1.3	Selection Phase.....	18
5.1.4	Intentionally Not Used.....	20
5.1.5	Information Transfer Phases.....	20
5.1.6	COMMAND Phase.....	24
5.1.7	DATA Phase.....	24
5.1.8	STATUS Phase.....	24
5.1.9	MESSAGE Phase.....	24
5.1.10	Signal Restrictions between Phases.....	25
5.2	SASI BUS CONDITIONS.....	25
5.2.1	Reset Condition.....	25
5.3	SASI BUS PHASE SEQUENCES.....	26
5.4	MESSAGE SYSTEM SPECIFICATION.....	28

TABLE OF CONTENTS (continued)

6.0	SASI COMMANDS.....	28
6.1	COMMAND IMPLEMENTATION REQUIREMENTS.....	29
6.1.1	Reserved (RSV or R) and Not Applicable (NA or X).....	29
6.2	COMMAND DESCRIPTOR BLOCK (CDB).....	29
6.2.1	Operation Code.....	30
6.2.2	Logical Unit Number (LUN).....	31
6.2.3	Logical Block Address.....	31
6.2.4	Command Perimeter Byte.....	32
6.2.5	Control Byte.....	32
7.0	COMMAND DESCRIPTIONS.....	35
7.1	GROUP 0 COMMAND DESCRIPTIONS.....	35
7.1.1	Test Drive Ready Command.....	36
7.1.2	Recalibrate.....	37
7.1.3	Request Sense Command Code.....	37
7.1.4	Format Unit Command.....	44
7.1.5	Check Track Format Command.....	46
7.1.6	Format Track Command.....	46
7.1.7	Format Bad Track Command.....	47
7.1.8	Read Command.....	48
7.1.9	Read Verify Command.....	52
7.1.10	Write Command.....	52
7.1.11	Seek Command.....	55
7.1.12	Initialize Drive Characteristics Command.....	56
7.1.13	Read ECC Burst Error Length Command.....	58
7.1.14	Format Alternate Track Command.....	59
7.1.15	Write Sector Buffer Command.....	60
7.1.16	Read Sector Buffer.....	61
7.2	GROUP 7 COMMAND DESCRIPTIONS.....	62
7.2.1	Ram Diagnostics.....	62
7.2.2	Drive Diagnostics.....	63
7.2.3	Internal Diagnostics.....	64
7.2.4	Read Long Command.....	65
7.2.5	Write Long Command.....	66
7.2.6	Retry Statistics Command.....	67
8.0	COMPLETION STATUS.....	69

1.0 SCOPE

This specification describes the Control Data Corporation SASI™ (Shugart Associates System Interface) subset of the SCSI (Small Computer Systems Interface) as implemented on the 94151 WREN II Disk Drive. This SASI interface is implemented via electronics contained within the drive and represents the user interface to the drive. The 94151 WREN II Drive Interface is defined for functional compatibility with existing host adapters and host software which exist to attach SASI devices to various computer systems.

The SASI subset of the SCSI interface described in this document consists of a local 8 bit bidirectional bus which is to be utilized for controlling a direct access rigid disk drive containing only fixed media. A primary objective of this interface is to provide host computers with device independence within a class of disk drives. To this extent, the interface uses "Logical" rather than "Physical" addressing for all data blocks. This document will define the bus protocol and information which is transferred via the bus in order to interface to the 94151 WREN II Disk Drive.

This document will also define the physical aspects of the 94151 WREN II interface necessary to support cable lengths up to 6 metres and a bus interface transfer rate of up to 1.0 MBytes per second. The physical interface consists of single ended drivers and receivers and asynchronous communication techniques.

The 94151 WREN II will not implement the SCSI ARBITRATION, RESELECTION or MESSAGE OUT protocols.

The 94151 WREN II will be referred to simply as the "WREN" in subsequent discussions within this document.

The specific WREN device capabilities are defined in the WREN II SCSI (SASI™ Subset) Disk Drive Product Specification, 77738208.

The Product Specification references this document for clarification of SASI Interface material. Both documents are recommended to provide the reader a comprehensive understanding of the 94151 WREN and it's capabilities.

2.0 APPLICABLE DOCUMENTS

- ANSI Small Computer System Interface (SCSI) document: Document #X3T9/84-40 (or X3T9.2/82-2) Revision 14B.
- WREN II SCSI (SASI™ Subset) Product Specification 77738208.

3.0 GLOSSARY AND CONVENTIONS

3.1 GLOSSARY

Byte	An 8-bit (Octet)
Command Descriptor Block (CDB)	The structure used to communicate COMMAND requests from an Initiator to the WREN Drive.
Connect	The function that occurs when an INITIATOR selects the drive to start an operation.
Disconnect	The function that occurs when the drive releases control of the bus, allowing it to go to the BUS FREE phase.
Data Bus (DB)	Refers to the SCSI (or SASI) DATA BUS signal lines.
Don't Care (X)	May be either a 0 or 1.
H	Hexadecimal data (e.g., 6CH).
Initiator	A SCSI (or SASI) device (usually a host system) that requests an operation to be performed by the drive.
Logical Unit	This designation is intended to be used to identify one of several physical devices which may be attached to a SCSI (or SASI) device. Since the WREN only consists of one physical disk drive, this drive only consists of one LOGICAL UNIT.

3.1 continued

Logical Unit Number (LUN)	An encoded three-bit identifier for the LOGICAL UNIT. The only valid LUN for the WREN is zero.
LSB	Least Significant Byte
MM	Millimeter
ms	Millisecond
MSB	Most Significant Byte
ns	Nanosecond
One	A true signal value
Reserved	The term used for bits, bytes, fields and code values that are set aside for future standardization.
SCSI(or SASI)Address	The octal representation of the unique address (0-7) assigned to a SCSI(or SASI) device. This address is assigned to a WREN at system installation.
SCSI(or SASI) ID	The bit-significant representation of the SCSI(or SASI) address referring to one of the signal lines DB (7-0).
SCSI(or SASI) Device	A host computer adapter, peripheral controller or an intelligent peripheral that can be attached to the SCSI (or SASI) bus. The WREN is an intelligent peripheral.

3.1 continued

Signal Assertion	The act of driving a signal to the true state.
Signal Negation	The act of driving a signal to the false state or allowing the cable terminators to bias the signal to the false state (by placing the drivers in a high impedance condition).
Signal Release	The act of allowing the cable terminators to bias the signal to the false state (by placing the drivers in a high impedance condition).
Target	An SASI device that performs an operation requested by an Initiator. The WREN is always a target.
μ s	Microsecond

4.0 PHYSICAL CHARACTERISTICS

This section contains the physical definition of the WREN interface. The connectors, cable, signals, terminators and bus timing needed to communicate with the WREN are covered.

4.1 PHYSICAL DESCRIPTION

SASI WRENs may be daisy chained together or with other SASI devices using a common cable. Both ends of the cable must be terminated. All signals are common between all SASI devices. The WREN may be daisy chained only with SASI devices with single ended drivers and receivers. A maximum of eight SASI devices may be daisy chained together.

4.2 CABLE REQUIREMENTS

An ideal impedance match with cable terminators implies a cable characteristic impedance of 132 ohms (single-ended option). In general, cables with this high of a characteristic impedance are not available; however, impedances which are somewhat lower are satisfactory. A characteristic impedance of 100 ohms \pm 10% is recommended for unshielded flat or twisted pair ribbon cable. A characteristic impedance greater than 90 ohms is preferred for shielded cables. However, most available cables have a somewhat lower characteristic impedance. It is desirable to minimize the use of cables of different impedances in the same bus in order to minimize discontinuities and signal reflections. Implementations may require tradeoffs in shielding effectiveness, cable length, the number of loads, transfer rates, and cost to achieve satisfactory system operation.

A minimum conductor size of 28 AWG should be employed to minimize noise effects.

4.2.1 Single-Ended Cable

A 50 conductor flat cable or 25 twisted pair cable shall be used. The maximum cable length shall be 6.0 metres.

Each drive shall have a 0.1 metre maximum stub length.

Bus termination capability will be internal to the drive.

The cable pin assignment is as shown in Table 4.2.1-1.

4.2.1 continued

TABLE 4.2.1-1. SINGLE-ENDED CABLE PIN ASSIGNMENTS

SIGNAL [4]	PIN NUMBER [3]
-DB(0)	2
-DB(1)	4
-DB(2)	6
-DB(3)	8
-DB(4)	10
-DB(5)	12
-DB(6)	14
-DB(7)	16
RESERVED [2]	18
GROUND	20
GROUND	22
GROUND	24
RESERVED [1]	26
GROUND	28
GROUND	30
RESERVED [2]	32
GROUND	34
-BSY	36
-ACK	38
-RST	40
-MSG	42
-SEL	44
-C/D	46
-REQ	48
-I/O	50

NOTES:

- [1] Pin 26 is reserved. This pin will not be terminable by the drives interface terminating resistors.
- [2] Pins 18 & 32 are reserved. These pins will be terminable by the drives interface terminating resistors.
- [3] All odd pins except pin 25 will be connected to ground. Pin 25 will be left open.
- [4] The minus sign next to the signals indicates active low.

4.3 CONNECTOR REQUIREMENTS

The nonshielded cable connector shall be a 50 conductor connector consisting of two rows of 25 female contacts with adjacent contacts 100 mils apart.

Recommended Flat Cable Connector Part Numbers are:

Closed	3M-3425-7000	W/O Strain Relief
End	3M-3425-7050	With Strain Relief
Open	3M-3425-6000	W/O Strain Relief
End	3M-3425-6050	With Strain Relief

(Daisychain)

The nonshielded WREN device connector is a 50 conductor connector consisting of two rows of 25 male pins with adjacent pins 100 mils apart. This connector is not a keyed connector.

Drive Connector Part Number:

BERG - 65624 - 150

4.4 ELECTRICAL DESCRIPTION

The WREN uses single ended drivers and receivers.

All assigned signals are terminable with 220 ohms to +5 volts (nominal) and 330 ohms to ground at each end of the cable. See Figure 4.4-1.

All output signals use open collector drivers (type SN7438).

Each signal driven by the drive shall have the following output characteristics when measured at the drives connection:

Signal Assertion = 0.0 VDC to 0.4 VDC
Minimum driver output capability = 48 mA (sinking) @
0.5 VDC
Signal Negation = 2.5 VDC to 5.25 VDC

4.4 continued

Each signal received by the drive shall have the following input characteristics when measured at the drives connector.

- Signal True = 0.0 VDC to 0.8 VDC
- Maximum total input load = -0.4 mA @ 0.4 VDC
- Signal False = 2.0 VDC to 5.25 VDC
- Minimum input hysteresis shall be 0.2 VDC

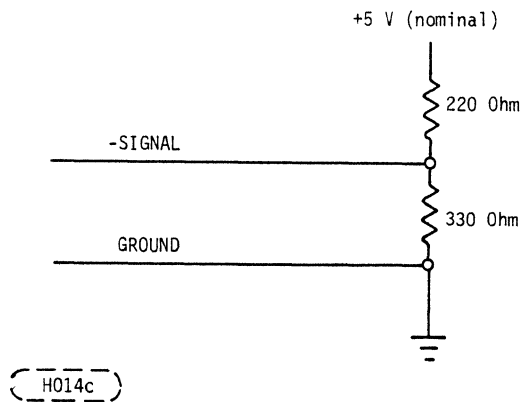

FIGURE 4.4-1. TERMINATION FOR INTERFACE SIGNALS

4.5 SASI BUS

Communication on the SASI Bus is allowed between only two SASI devices at any given time. There is a maximum of eight SASI devices permitted. Each SASI device has an SASI ID bit assigned as shown in Figure 4.5-1. The drives SASI ID is assigned and strapped in the drive during system configuration.

When two SASI devices communicate on the SASI Bus one acts as an Initiator and the other acts as a Target. The Initiator (typically a host computer) originates an operation and the Target performs the operation. The drive will operate only as a Target.

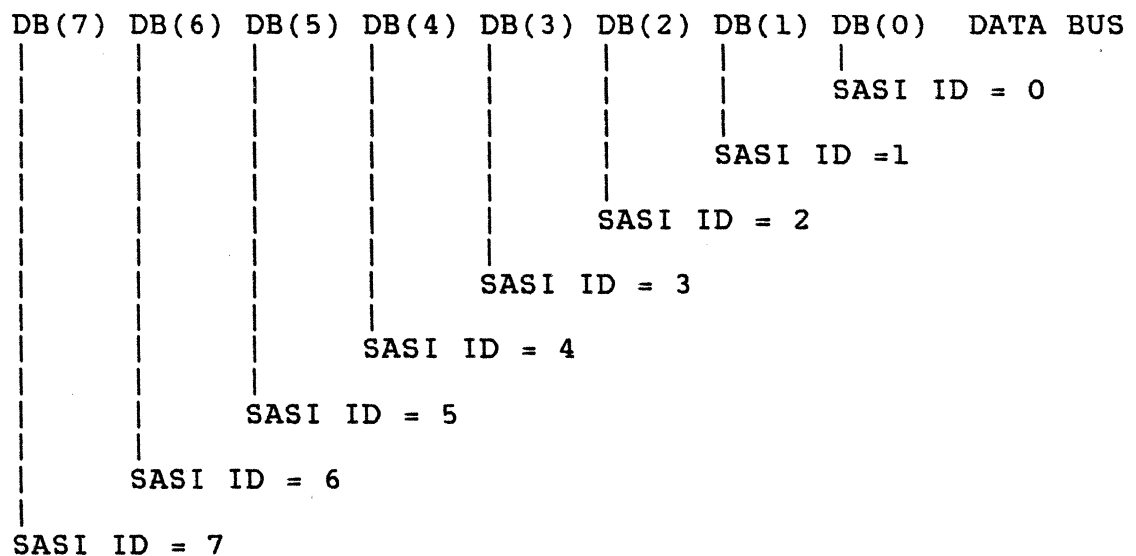

FIGURE 4.5-1. SASI ID BITS

4.5 continued

Certain SASI Bus functions are assigned to the Initiator and certain SASI Bus functions are assigned to the drive. The Initiator will select a particular drive. The drive will request the transfer of COMMAND, DATA, STATUS or other information on the DATA BUS.

Information transfers on the DATA BUS are asynchronous and follow a defined REQ/ACK handshake protocol. One byte of information will be transferred with each handshake.

4.6 SASI BUS SIGNALS

There are eight control signals and eight data signals, as listed below:

BSY
SEL
C/D
I/O
MSG
REQ
ACK
RST
DB(7-0)

These signals are described as follows:

BSY (BUSY)	An "or-tied" signal which indicates that the bus is being used.
SEL (SELECT)	A signal used by an Initiator to select a drive.
C/D (CONTROL/DATA)	A signal driven by a drive; it indicates whether CONTROL or DATA information is on the data bus. True indicates CONTROL.

4.6 continued

I/O (INPUT/OUTPUT)	A signal driven by a drive which controls the direction of data movement on the data bus with respect to an Initiator. True indicates input to the Initiator.
MSG (MESSAGE)	A signal driven by a drive during the MESSAGE phase.
REQ (REQUEST)	A signal driven by a drive to indicate a request for a REQ/ACK data transfer handshake.
ACK (ACKNOWLEDGE)	A signal driven by an Initiator to indicate an acknowledgement for a REQ/ACK data transfer handshake.
RST (RESET)	An "or-tied" signal which indicates the RESET condition. The drive will only receive and interpret this signal.
DB(7-0)(DATA BUS)	Eight data bit signals which form a Data Bus. DB(7) is the most significant bit. A data bit is defined as one when the signal value is true and is defined as zero when the signal value is false.

4.6.1 Signal Values

Signals may assume the values true or false. Signals will be actively driven true, or asserted by the drive. The drive does not drive the signal to the false state, rather the bias circuitry of the bus terminators pulls the signal false whenever it is released by the drives drivers. If any driver is asserted, then the signal is true.

4.6.2 Signal Sources

Table 4.6-1 indicates the drives implementation with respect to driving, receiving or no action of the SASI signals. No attempt is made to show if a drive signal is in the true or false state. All SASI drivers that are not active drivers will be in the passive state.

TABLE 4.6-1 SIGNAL IMPLEMENTATION

SIGNALS						
BUS PHASE	BSY	SEL	C/D, I/O MSG, REQ	ACK	DB(7-0,)	RST
BUS FREE	R	R	NA	NA	NA	R
SELECTION	D (1)	R (1)	NA	NA	R	R
COMMAND	D	NA	D	R	R	R
DATA IN	D	NA	D	R	D	R
DATA OUT	D	NA	D	R	R	R
STATUS	D	NA	D	R	D	R
MESSAGE	D	NA	D	R	D	R

NA - NO action - i.e., the signal is neither driven or received.

R - Received - The drive will receive and interpret this signal.

D - Driven - The drive may drive this signal to the true or false state.

- (1) The drive will enter the SELECTION phase when SEL is true. If the drive is selected in the SELECTION phase then the drive will drive BSY true to indicate that the drive has been selected.

4.7 SASI BUS TIMING

Timing values specified are at the drives SASI connector.

4.7.1 Bus Settle Delay (400 ns)

The minimum time the drive will wait for the bus to settle after changing certain control signals as called out in the protocol definitions.

4.7.2 Cable Skew Delay (10 ns)

The maximum difference in propagation time between any two SASI bus signals measured between any two SASI devices.

4.7.3 Deskew Delay (45 ns)

The minimum time required for deskew of certain signals.

4.7.4 Reset Hold Time (100 ns)

The minimum time for which RST is asserted. There is no maximum time.

5.0 LOGICAL CHARACTERISTICS

5.1 SASI BUS PHASES

The WREN drive will respond to 6 distinct phases:

BUS FREE phase
SELECTION phase
COMMAND phase
DATA (In and Out)
STATUS (In Only)
MESSAGE (In Only)

These phases are collectively termed the Information Transfer phases.

The SASI Bus can never be in more than one phase at any given time. Unless otherwise noted in the following description, signals that are not mentioned shall not be asserted.

5.1.1 BUS FREE Phase

The BUS FREE phase is used to indicate that no SASI device is actively using the Bus and that the Bus is available for subsequent users.

The drive will detect the BUS FREE phase whenever SEL and BSY are false while the RST signal is false.

5.1.2 Intentionally Not Used

5.1.3 SELECTION Phase

The SELECTION phase allows an Initiator to select the drive for the purpose of initiating some drive function (e.g. Read or Write command).

The drive timing and required protocol for the SELECTION phase for systems without arbitration is shown in Figure 5.1-1.

5.1.3.1 Nonarbitrating Systems:

The SELECTION phase is entered directly from the BUS FREE phase. The Initiator initiates the SELECTION phase by asserting the desired drives SASI ID bit on the Data Bus and then asserting SEL per Figure 5.1-1 (the drive will allow the Initiator to assert its own initiator SASI ID on the Data Bus as well). The selected drive will then assert BSY to signify selection. The selected drive will assert BSY within 150 nanoseconds of its detection of its SASI ID bit with SEL true. After the Initiator detects the drives activation of BSY, the Initiator shall deactivate SEL and release the Data Bus to terminate the SELECTION phase.

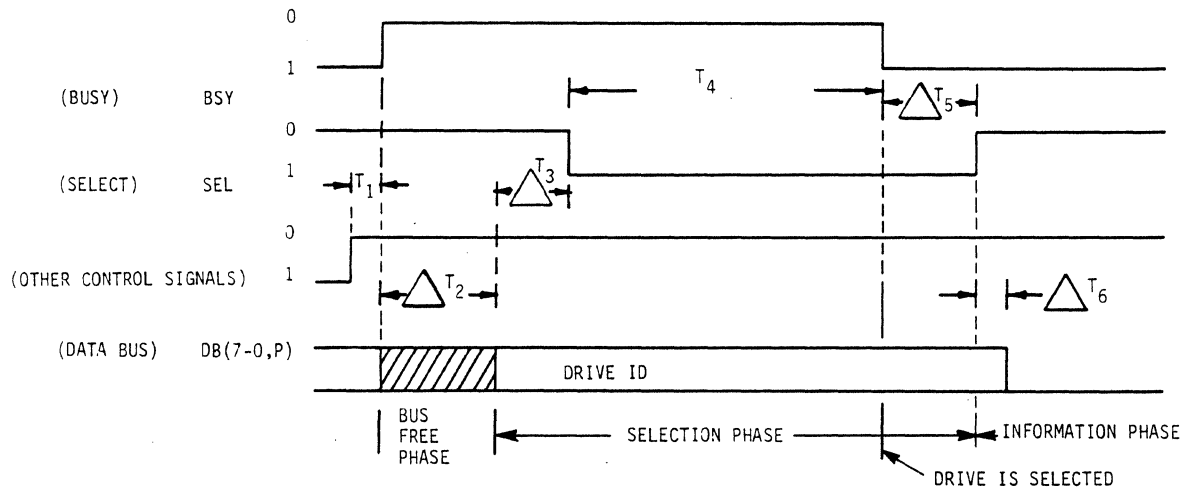

- $T_1 \geq 0$ - DRIVE DEACTIVATES OTHER CONTROL SIGNALS AND DATA BUS PRIOR TO DESELECTING ITSELF FROM THE INITIATOR.
 - $\Delta T_2 \geq 0$ - INITIATOR DETECTS BUS FREE PHASE AND SETS UP TO SELECT A DRIVE.
 - $\Delta T_3 \geq 90 \text{ ns}$ - DATA BUS SET UP TIME.
 - $T_4 \leq 150 \text{ ns}$ - DRIVE SELECTION TIME.
 - $\Delta T_5 \geq 0$ - INITIATOR TERMINATES THE SELECTION PHASE BY DEACTIVATING SEL.
 - $\Delta T_6 \leq 90 \text{ ns}$ - INITIATOR RELEASES BUS.
 - ΔT_i - INITIATOR CONTROLLED TIME
 - T_j - DRIVE CONTROLLED TIME
- NOTE: ALL OTHER CONTROL SIGNALS ARE DEACTIVATED BY THE DRIVE DURING THE BUS FREE AND SELECTION PHASES.

H271

FIGURE 5.1.-1 DRIVE SELECTION TIMING ASSUMING SYSTEMS WITH NO ARBITRATION

5.1.4 Intentionally Not Used

5.1.5 Information Transfer Phases

The COMMAND, DATA, STATUS and MESSAGE phases are all grouped together as the Information Transfer phases because they are all used to transfer data or control information via the Data Bus. The actual contents of the information is covered in future sections of this specification.

The C/D, I/O and MSG signals are used to distinguish between the different Information Transfer phases. See Table 5.1-1. The drive drives these three signals and therefore controls all changes from one phase to another after selection. The drive causes the BUS FREE phase by releasing MSG, C/D, I/O, and BSY.

TABLE 5.1.-1 Information Transfer Phases

SIGNAL			PHASE NAME	DIRECTION OF TRANSFER	COMMENT
MSG	C/D	I/O			
0	0	0	DATA OUT	(Initiator to Drive)	DATA Phases
0	0	1	DATA IN	(Initiator from Drive)	
0	1	0	COMMAND	(Initiator to Drive)	
0	1	1	STATUS	(Initiator from Drive)	
1	0	0	*		
1	0	1	*		
1	1	0	*		MESSAGE
1	1	1	MESSAGE IN	(Initiator from Drive)	Phase

Notes: 0 = False 1 = True * = RESERVED for future standardization.

5.1.5 continued

The Information Transfer phases use one or more REQ/ACK handshakes to control the information transfer. Each REQ/ACK allows the transfer of one byte of information. During the Information Transfer phases, BSY shall remain true and SEL shall remain false. Additionally, during the Information Transfer phases, the drive shall continuously envelope the REQ/ACK handshake(s) with C/D, I/O and MSG in such a manner that these control signals are valid for 400 ns minimum before the REQ of the first handshake and remain valid until the negation of ACK at the end of the last handshake.

5.1.5.1 Asynchronous Information Transfer

The drive shall control the direction of information transfer by means of the I/O signal. When I/O is true, information shall be transferred from the drive to the Initiator. When I/O is false, information shall be transferred from the Initiator to the drive.

The Information Transfer timing when the I/O line is False (Initiator to Drive) is shown in Figure 5.1-3. The drive initiates each byte transferred by activating the REQ line. The Initiator must then send the drive the requested information byte and activate its ACK line. The drive has no maximum limit on this Initiator response time, thus if the Initiator is not going to respond to the drives REQ line, the Initiator can only clear the drive by activating the RST line.

The Information Transfer timing when the I/O line is true (drive to Initiator) is shown in Figure 5.1-4. The drive initiates each byte transferred by putting valid data on the BUS and then activating the REQ line. The Initiator must accept the information and activate its ACK line. The drive has no maximum limit on this Initiator response time, thus if the Initiator is not going to respond to the drives REQ line, the Initiator can only clear the drive by activating the RST line.

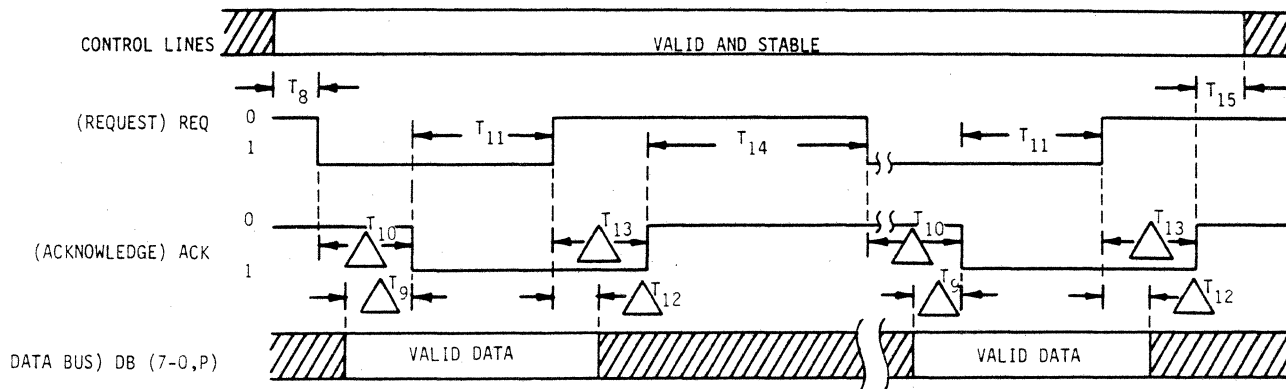

- | | |
|---|--|
| $400 \text{ ns} \leq T_8$ | CONTROL LINE SETTLE TIME (MIN.) |
| $55 \text{ ns} + 2L \leq T_9$ | DATA SET UP TIME |
| $0 \text{ ns} + 2L \leq T_{10}$ | INITIATOR RESPONSE TIME |
| $400 \text{ ns} \leq T_{11} \leq 1200 \text{ ns}$ | DRIVE RESPONSE TIME |
| $0 \text{ ns} + 2L \leq T_{12}$ | DATA HOLD TIME |
| $0 \text{ ns} + 2L \leq T_{13}$ | INITIATOR RESPONSE TIME |
| $0 \leq T_{14} \leq 200 \text{ ns}$ | DRIVE NEXT BYTE REQUEST RESPONSE TIME |
| $0 \text{ ns} \leq T_{15}$ | CONTROL LINE HOLD TIME AFTER LAST BYTE TRANSFERRED |

NOTES:

- ALL TIMING MEASURED AT CONNECTOR
- L = DELAY TIME (ns) FOR AMOUNT OF CABLE USED.
- $\triangle T_i$ - INITIATOR CONTROLLED TIME
- T_j - DRIVE CONTROLLED TIME

H272a

FIGURE 5.1-3. INFORMATION PHASE BYTE TRANSFER TIMING-
OUT CYCLES (INITIATOR TO DRIVE TRANSFERS)

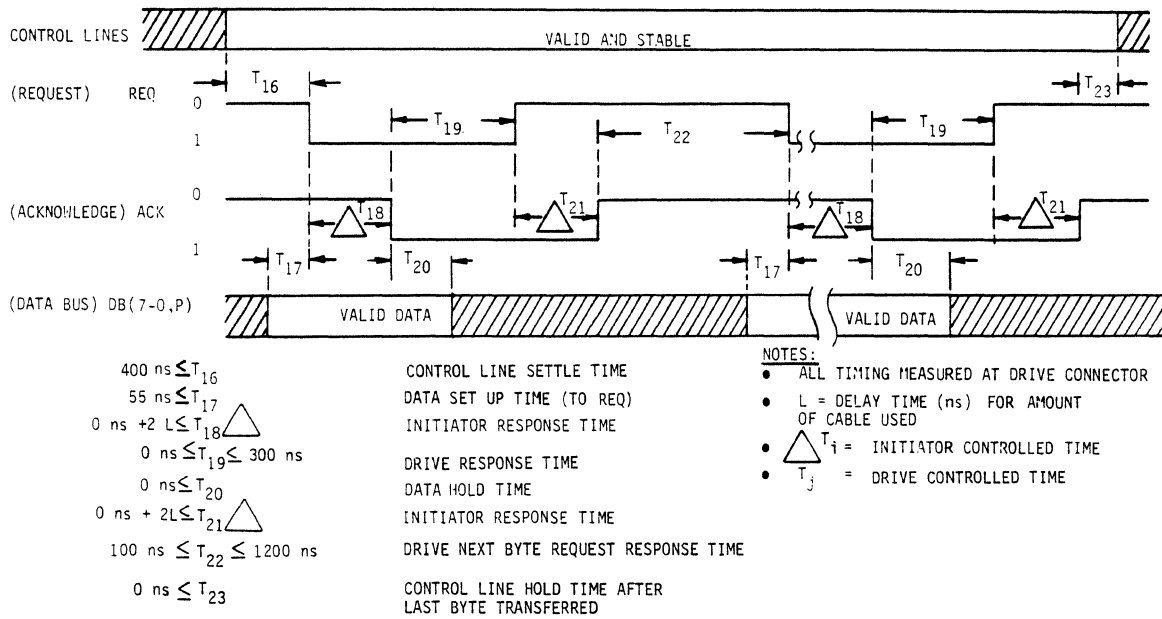

H272b

FIGURE 5.1-4. INFORMATION PHASE BYTE TRANSFER TIMING-
IN CYCLES (DRIVE TO INITIATOR TRANSFERS)

5.1.6 COMMAND Phase

The COMMAND phase allows the drive to request command information from the Initiator.

The drive will assert the C/D signal and negate the I/O and MSG signals during the REQ/ACK handshake(s) of this phase.

5.1.7 DATA Phase

The DATA phase is a term that encompasses the DATA IN phase and the DATA OUT phase.

5.1.7.1 DATA IN Phase

The DATA IN phase allows the drive to request that data be sent to the Initiator from the drive.

The drive will assert the I/O signal and negate the C/D and MSG signals during the REQ/ACK handshake(s) of this phase.

5.1.7.2 DATA OUT Phase

The DATA OUT phase allows the drive to request that data be sent from the Initiator to the drive.

The drive shall negate the C/D, I/O and MSG signals during the REQ/ACK handshake(s) of this phase.

5.1.8 STATUS Phase

The STATUS phase allows the drive to request that status information be sent from the drive to the Initiator.

The drive will assert C/D and I/O and negate the MSG signal during the REQ/ACK handshake of this phase.

5.1.9 MESSAGE Phase

The MESSAGE phase is a term that references a MESSAGE IN phase. The transfer in this phase will be a single byte message.

5.1.9.1 MESSAGE IN Phase

The MESSAGE IN phase allows the drive to request that messages be sent to the Initiator from the drive.

The drive will assert C/D, I/O and MSG during the REQ/ACK handshake of this phase.

5.1.10 Signal Restrictions Between Phases.

When the SASI Bus is between two Information Transfer phases, the following restrictions shall apply to the SASI Bus signals:

- (1) The BSY, SEL, REQ, and ACK signals shall not change.
- (2) The C/D, I/O, MSG, and DATA BUS signals may change.
- (3) The RST signal may change as defined under the description for the RESET condition. See Section 5.2.2.

5.2 SASI BUS CONDITIONS

The drive will recognize one asynchronous Bus condition; the Reset condition. This condition causes the drive to perform certain reset actions and alters the phase sequence. See Section 5.2.2.

5.2.1 Reset Condition

The Reset condition is used to immediately clear the drive from the bus. This condition will take precedence over all other phases and conditions. The Initiator creates the Reset condition by asserting RST for a minimum of 100 nanoseconds. During the Reset condition, the state of all SASI bus signals other than RST is not defined.

All drives on a SASI Bus will release all SASI Bus signals within 800 ns of the transition of RST to True. The BUS FREE phase always follows the Reset condition.

5.2.1 continued

Upon detection of the interface RST signal, the drive will perform a "HARD" reset operation which includes:

- (1) Generate a power on reset to the microprocessor
- (2) Termination and cancellation of all received commands
- (3) Reset all status and operating modes to the power turn on default condition
- (4) Recalibrate (Return to Zero) the drive to track 0, head 0

The Initiator should wait a minimum of 2 seconds before attempting to communicate with the drive. The Initiator should retransmit any desired operating mode parameters after the reset function is completed by the drive.

5.3 SASI BUS PHASE SEQUENCES

The drive sequences through the various SASI Bus phases in a prescribed sequence. However, the Reset Condition will prematurely abort any phase and is always followed by the BUS FREE phase.

The drive will operate in/create one of the two phase sequences shown in Figures 5.3-1 or 5.3-2 depending on the command code received. Figure 5.3-1 defines the phase sequencing for received commands which do not require additional data transfers (e.g.; Recalibrate, Seek, etc). Figure 5.3-2 defines the phase sequencing for received commands which do require additional Data Transfers (e.g.: Read, Request Sense, Write, etc.).

The drive will remain in the BUS FREE phase until an Initiator generates a SELECTION Phase. When a drive is selected via the SELECTION phase, the drive will create the phase sequences per either Figure 5.3-1 or 5.3-2. An Initiator may change these phase sequences by creating the RESET condition. Otherwise, the Initiator must respond and support the phase sequencing shown.

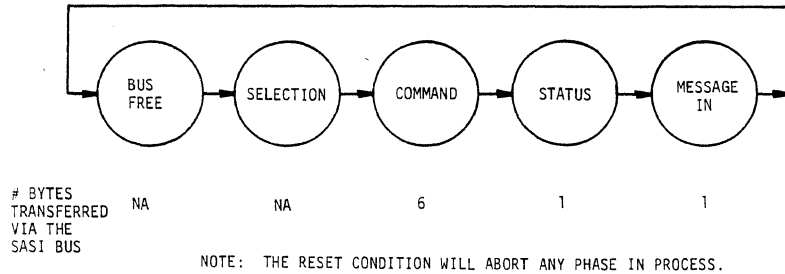

H230a

FIGURE 5.3-1. BUS PHASE SEQUENCING WITH NO DATA TRANSFERS

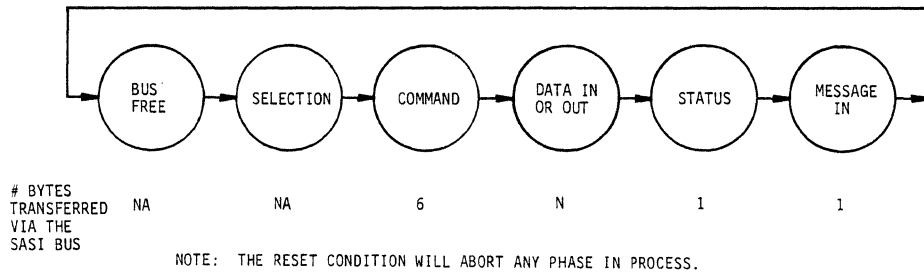

H230b

FIGURE 5.3-2. BUS PHASE SEQUENCING WITH DATA TRANSFERS

5.4 MESSAGE SYSTEM SPECIFICATION

The drive only implements the Command Complete Message In. The MESSAGE IN phase will always follow the STATUS phase and precede the BUS FREE phase and informs the Initiator that the drive is going to deselect itself and enter the BUS FREE phase. The Command Complete Message In will be a byte of all zeros transferred to the Initiator via the SASI Bus.

6.0 SASI COMMANDS

The sequence of events (Bus Phases) for a drive to receive and execute a command are defined by either Figure 5.3-1 or 5.3-2.

After selection, the drive will request a 6 byte Command Descriptor Block (CDB) from the Initiator. This CDB will define the command to be performed and also provide relevant command parameters.

If data transfers are required as part of the command execution the drive will enter the DATA IN or DATA OUT phase until all of the data has been transferred. Data may be either data which is to be written onto or read from the disk media or may be data which defines additional command parameters, or sense data requested by the Initiator, etc. Data to be written to or read from the disk media is defined as logical blocks where one logical block is either a 256 byte or 512 byte sector of data. (The byte length of a sector i.e. either 256 or 512 bytes is determined at installation time via a jumper setting within the drive). The Initiator specifies a logical block address as a contiguous block number (not a physical disk address such as a cylinder, head, and sector number). The drive converts the logical block number to a physical disk address. The Initiator and drive remain selected and connected to the Bus while the drive prepares for and during data transfers (or while a command is being executed).

Upon command completion (successful or unsuccessful), the drive returns a Status Byte (during the STATUS phase) to the Initiator. Since most error and exception conditions cannot be adequately described with a single Status Byte, one Status Code (Check Condition) indicates that additional information is available. The Initiator may issue a Request Sense command to retrieve this additional information. See Section 8 for the Status Byte encoding.

6.0 continued

After sending the Status Byte the drive will send a Command Complete Message to the Initiator (during the MESSAGE phase) and then deselect itself and enter the BUS FREE phase. See Section 5.5.

6.1 COMMAND IMPLEMENTATION REQUIREMENTS

A Command Descriptor Block is required to specify any command to be performed by the drive. See Section 6.2.

6.1.1 Reserved (RSV or R) and Not Applicable (NA or X)

Reserved bits, bytes, fields and code values are set aside for future definitions. A reserved bit, byte or field should be set to zero by an Initiator but the drive will not check or interpret these reserved bits, bytes or fields. The drive will set to zero any information sent to an Initiator labeled as reserved.

Not Applicable bits, bytes, fields and code values are "not required" bits, bytes and fields. Any Not Applicable bit, byte or field should be set to zero by an Initiator but the drive will not check or interpret Not Applicable bits, bytes or fields. The drive will set to zero any information sent to an Initiator labeled as Not Applicable.

6.2 COMMAND DESCRIPTOR BLOCK (CDB)

A request for a drive to execute a command is performed by the Initiator sending a Command Descriptor Block to the drive. The drive will always request a 6 Byte CDB. For several commands the request is also accompanied by a list of parameters sent during the DATA OUT phase. See the specific commands for detailed information.

The Command Descriptor Block (Figure 6.2-1) always has an Operation Code as the first byte of the CDB. This is followed by a Logical Unit Number, Command Parameters, and a Control Byte.

6.2 continued

BIT BYTE	7	6	5	4	3	2	1	0
0	Operation Code							
1	Logical Unit Number				Log Blk Addr (if req) (MSB)			
2	Log Blk Addr (if Req)							
3	Log Blk Addr (if Req) (LSB)							
4	Command Parameter (if Req)							
5	Control Byte							

FIGURE 6.2-1 COMMAND DESCRIPTOR BLOCK
 FOR SIX-BYTE COMMANDS

6.2.1 Operation Code

The Operation Code (Figure 6.2-2) of the Command Descriptor Block has a Group Code field and a Command Code field. The Group Code field is a three bit field. The drive will accept commands with a Group Code of 0 or 7. The Command Code field is a five bit field which provides for thirty-two command codes in each group. See Section 7.1 and 7.2 for the command codes accepted by the drive.

BIT BYTE	7	6	5	4	3	2	1	0
0	Group Code			Command Code				

FIGURE 6.2-2. OPERATION CODE

6.2.2 Logical Unit Number (LUN)

The three bit Logical Unit Number (first 3 bits of byte 1 of the CDB of Figure 6.2-1) is provided to allow addressing of more than one physical device per SASI device. Since the drive consists of only one physical device, the LUN address must be zero. If the LUN is not zero, the drive will not attempt to execute the CDB but will proceed to the STATUS phase with the "CHECK CONDITION" bit activated in the Status byte and the "Illegal Disk Address" code set in Sense Status.

6.2.3 Logical Block Address (Log. Blk. Addr.)

The 21 bit Logical Block Address (located in bytes 1, 2 and 3 of the CDB) specifies a Logical Block Address in the drive. The Logical Address shall begin with block zero and be contiguous up to the last Logical Block Address on the drive.

A block is defined as one sector of disk data. The number of bytes per block (sector) is determined at drive installation time and will be either 256 or 512 bytes per sector. Normally the number of bytes per block is set at installation to agree with the Initiator operating systems block size and will not need to be changed thereafter.

The logical address of a Block (sector) in the drive is computed by using the following equation:

$$\text{Logical Address} = (\text{CYADR} \times \text{HDCYL} + \text{HDADR}) \times \text{SETRK} + \text{SEADR}.$$

Where: CYADR = Cylinder Address
HDADR = Head Address
SEADR = Sector Address
HDCYL = Number of Heads per Cylinder
SETRK = Number of Sectors per Track

The maximum Logical address which may be specified by the Initiator is dependent on the selected Block Size (Number of bytes per sector) and the drive model number (installed number of heads) and may be calculated from the following drive parameters.

6.2.3 continued

Maximum number of cylinders * = 921
 Maximum number of heads * = 5, 7 or 9
 (depending on model number)
 Maximum number of sectors per track * = 19 (512 byte sectors)
 or 36 (256 byte sectors)

* Address value is one less than maximum number (e.g., allowable cylinder addresses are 0 to 920)

6.2.4 Command Parameter Byte

The Command Parameter byte (byte 4 of the CDB) usually either defines either the Transfer Length, Format Interleave Factor or a Command Modifier depending on the operation code received. The Command Parameter byte will be defined in the section describing its operation codes.

A Command Parameter byte defined as an Interleave Factor refers to the number of physical sectors separating each logical sector on a track. The number of physical sectors separating each logical sector is equal to the Interleave Factor value minus one (e.g.; a value of 1 indicates 0 physical sectors between each logical sector, a value of 2 indicates 1 physical sector between each logical sector, etc.). For 512 byte sectors the valid range of Interleave Factors is 2 to 18. For 256 byte sectors the valid range of Interleave Factors is 2 to 35.

6.2.5 Control Byte

The Control byte (byte number 5 of the CDB) is the last byte in the CDB and is mainly utilized to define if retries should be applied if an error is detected by the drive. This byte is not applicable for all commands. Applicability will be specified in each command definition.

The Control byte (if applicable) is defined as follows:

BIT	7	6	5	4	3	2	1	0
	r	a	p	NA	S	S	S	S

6.2.5.1 Control Byte Bit 7 (r) - Retry

.If this bit is applicable and activated (1), the drive will not attempt retries for the command specified. All errors detected will immediately be reported. If this bit is applicable and deactivated (0), the drive will perform automatic retries. This bit should always be zero unless special testing or drive/media evaluation is being done. If this bit is defined as not applicable (X) in a CDB, it will not be interpreted or checked by the drive. Additional details are provided in the individual command descriptions and section 9.0.

6.2.5.2 Control Byte Bit 6 (a) - Retry Option On Data ECC Error

If this bit is applicable and activated (1), the drive will not try a reread of a sector (block) read with a detected data ECC error before attempting error correction of the data. If this bit is applicable and deactivated (0), the drive will try a reread of a sector (block) read with a detected data ECC error before attempting error correction of the data. If the data ECC error was caused by a transient condition (i.e. noise, power supply fluctuation, etc.), a reread will usually result in a successful read of the data field and is faster and potentially more reliable than applying ECC. If a data field ECC error occurs twice in succession, the read error is usually caused by a media defect so ECC is used to recover the data. It is recommended that this bit should always be a zero unless special testing or drive evaluation is being performed. If this bit is defined as NA (X) (i.e., Not Applicable) in a CDB, this bit is not interpreted (or checked) for this command. Additional details are provided in the applicable individual command descriptions and in Section 9.0

NOTE

To inhibit ECC Data Correction see section 7.1.12 "Initialize Drive Characteristics Command".

6.2.5.3 Control Byte Bit 5 (p) - Format Pattern

If this bit is applicable and activated (1), the drive will utilize the format data pattern written into the drives internal data buffer via the Write Buffer command as the data field written during a Format command. If this bit is applicable and deactivated (0), the drive will write a repetitive Hexadecimal 6C data pattern as the data field written during a Format command. If this bit is defined as Not Applicable for a CDB, this bit is not interpreted (or checked) for this command.

6.2.5.4 Control Byte Bits 4

This bit is never interpreted (or checked) by the drive for any CDB received.

6.2.5.5 Control Byte Bits 3, 2, 1 and 0 (s)

These bits are only interpreted or applicable for the Seek command (section 7.1.11). The state of these bits determine when the Completion Status for a Seek Command is sent to the Initiator. The following describes the drives interpretation of these bits.

<u>BITS</u>				<u>DRIVE INTERPRETATION</u>
<u>3</u>	<u>2</u>	<u>1</u>	<u>0</u>	
0	0	0	0	Send Completion Status when the seek function is completed in its entirety.
0	0	0	1	
0	0	1	0	
0	0	1	1	
0	1	0	0	Send Completion Status when the seek function is initiated
0	1	0	1	
0	1	1	0	
0	1	1	1	
1	0	0	0	Send Completion Status when the seek function is completed in its entirety.
1	0	0	1	
1	0	1	0	
1	0	1	1	
1	1	1	1	

These bit definitions allow the Initiator to implement overlapped seek operations when two or more SASI Disk Drives are present in a SASI system via the Seek command. If overlapped seek capability is not required, these bits should be zero.

7.0 COMMAND DESCRIPTION

7.1 GROUP 0 COMMAND DESCRIPTIONS

Group Zero Command Codes and names are listed in
Table 7.1-1.

TABLE 7.1-1. COMMAND CODES GROUP 00 COMMANDS

HEX OP CODE *	DESCRIPTION
00	TEST DRIVE READY
01	RECALIBRATE
02	RESERVED
03	REQUEST SENSE
04	FORMAT UNIT
05	CHECK TRACK FORMAT
06	FORMAT TRACK
07	FORMAT BAD TRACK
08	READ
09	READ VERIFY
0A	WRITE
0B	SEEK
0C	INITIALIZE DRIVE CHARACTERISTICS
0D	READ ECC BURST ERROR LENGTH
0E	FORMAT ALTERNATE TRACK
0F	WRITE SECTOR BUFFER
10	READ SECTOR BUFFER
11	RESERVED
12	RESERVED
13	RESERVED
14	RESERVED
15	RESERVED
16	RESERVED
17	RESERVED
18	RESERVED
19	RESERVED
1A	RESERVED
1B	RESERVED
1C	RESERVED
1D	RESERVED
1E	RESERVED
1F	RESERVED

*Group Code plus Command Code.

7.1.1.1 Test Drive Ready Command (Code 00 Hex)

BIT	7	6	5	4	3	2	1	0
Byte 0	0	0	0	0	0	0	0	0
Byte 1	0	0	0	X	X	X	X	X
Byte 2	X	X	X	X	X	X	X	X
Byte 3	X	X	X	X	X	X	X	X
Byte 4	X	X	X	X	X	X	X	X
Byte 5	X	X	X	X	X	X	X	X

X = Not Applicable

FIGURE 7.1-1 CDB FOR TEST DRIVE READY CMD

This command causes the drive to check if the spindle motor is up to speed and ready to seek, read or write. This command does not initiate a drive self test. If the drive is up to speed and ready to seek, read or write, a Completion Status of all zeros will be returned in the STATUS phase. If the drive is not up to speed and ready, the "Check Condition" status will be returned in the STATUS phase. If a "Check Condition" status is returned the Initiator should issue a Request Sense command to determine the state of the drive.

This command is usually only used for the following two occasions:

- 1) When initially powered on, the Initiator should issue this command continuously (after 1 second) with an appropriate time out delay to insure that the drive spins up to speed and becomes ready. The drives spin up time is 35 seconds maximum.
- 2) When implementing overlapped Seeks, the Initiator can issue this command in a "polling manner" to determine which SASI Drive has completed its seek function in its entirety (see also section 7.1.11).

7.1.2 Recalibrate (Code 01 Hex)

BIT	7	6	5	4	3	2	1	0
BYTE 0	0	0	0	0	0	0	0	1
BYTE 1	0	0	0	X	X	X	X	X
BYTE 2	X	X	X	X	X	X	X	X
BYTE 3	X	X	X	X	X	X	X	X
BYTE 4	X	X	X	X	X	X	X	X
BYTE 5	r	X	X	X	X	X	X	X

X = Don't care

FIGURE 7.1-2. CDB FOR THE RECALIBRATE COMMAND

This command will position the read/write heads to cylinder zero and select head zero (i.e. Logical Block Address zero). The Recalibrate command should only be used for error recovery procedures or during test procedures in which retries are disabled. If retries are enabled, the drive will recalibrate automatically in case of an error.

7.1.3 Request Sense Command (Code 03 Hex)

BIT	7	6	5	4	3	2	1	0
BYTE 0	0	0	0	0	0	0	1	1
BYTE 1	0	0	0	X	X	X	X	X
BYTE 2	X	X	X	X	X	X	X	X
BYTE 3	X	X	X	X	X	X	X	X
BYTE 4	X	X	X	X	X	X	X	X
BYTE 5	X	X	X	X	X	X	X	X

X = Don't care

FIGURE 7.1-3. CDB FOR REQUEST SENSE COMMAND

7.1.3 continued

This command causes the drive to send its current four bytes of Sense Data to an Initiator. Sense Data contains additional information relating to the reason that a "Check Condition" status was sent during the previous STATUS phase for the last command received. Sense Data is cleared to all zeros upon successful receipt of any command other than the Request Sense command. Sense Data is normally only valid if a "Check Condition" status was sent for the last command received. The individual command descriptions will define if Sense Data is possibly valid after execution of a command and no "Check Condition" status was sent. A "Check Condition" status will not be sent for a valid and successfully received CDB containing this Request Sense command.

After the drive receives the CDB for this command, the drive WILL enter the DATA phase and request the INITIATOR to accept four bytes of Sense Data.

7.1.3.1 Sense Data

The Sense Data bytes for the drive are retrieved using the Request Sense command. The format of these bytes are shown in Table 7.1.3-1.

TABLE 7.1.3-1. SENSE DATA BYTES FORMAT

BIT BYTE	7	6	5	4	3	2	1	0
00	AD VALID		ERROR CLASS (0-6)		ERROR CODE			
01	RESERVED			LOGICAL BLOCK ADDRESS (MSB)				
02	LOGICAL BLOCK ADDRESS							
03	LOGICAL BLOCK ADDRESS (LSB)							

7.1.3.1 continued

The AD VALID bit (bit 7 of byte 00) indicates that the Logical Block Address bytes contain valid information.

The ERROR CLASS (bits 6, 5, 4 of byte 00) indicates an error class and will always be between 0 and 3.

The ERROR CODE (bits 3, 2, 1, 0 of byte 00) indicates the particular error code for this error class.

The Logical Block Address (bits 0-4 of byte 01 and bytes 2 and 3) indicate the Logical Address of the last block (sector) accessed. These bytes are only valid if the AD VALID bit is a 1.

Table 7.1.3-2 is a summary of the error codes returned as the result of the Request Sense command.

7.1.3.1 continued

TABLE 7.1.3-2. SENSE BYTE ERROR CODE SUMMARY

ERROR CODE (HEX)	MEANING
00	No Error Detected (command completed OK).
01	No Index or Sector pulse detected.
02	No Seek Complete.
03	Write Fault.
04	Drive Not Ready.
05	Not Used.
06	Not Used.
07	Not Used.
08	Drive Still Seeking.
09-0F	Not Used.
10	ID Field Read Error.
11	Uncorrectable Read Error in the Data Field.
12	Sync Byte Error.
13	Not Used.
14	Target Sector Not Found.
15	Seek Error.
16	Not Used.
17	Not Used.
18	Correctable Data Error.
19	Not Used.
1A	Format Error.
1B - 1F	Not Used.
20	Invalid Command.
21	Illegal Disk Address.
22	Invalid Parameter.
23-2F	Not Used.
30	Ram Diagnostic Failure.
31	Program Memory Checksum Error.
32	ECC Diagnostic Failure.
33-3F	Not Used.

NOTE: The Address Valid Bit (bit 7) may or may not be set and is not included here for clarity.

7.1.3.1 continued

TABLE 7.1.3-3. CLASS 0 SENSE BYTE ERROR CODES

<u>HEX CODE</u>	<u>DEFINITION</u>
00	No Error Occurred. This code is returned if no error was detected during the previous command execution.
01	No Index or Sector Signal. This error occurs during any data transfer or format command if the drive is ready, but the Index signal or the desired Sector pulse signal is not detected within two revolutions of the disk.
02	No Seek Complete. This error occurs on seek processing if the seek does not complete within one second following the initiation of the seek.
03	Write Fault. This error occurs if the drive detects a drive write fault at the completion of a sector data transfer or initially before the data transfer is started.
04	Drive Not Ready. This error occurs if the drive spindle is not up to speed or if the drive is not ready to seek, read or write.
05	Not used.
06	Not used.
07	Not used.
08	Drive Still Seeking. This code is returned in response to a Test Drive Ready command if the drive had previously been issued a Seek command that has not yet completed.
09 to 0F	Not used.

7.1.3.1 continued

TABLE 7.1.3-4. CLASS 1 SENSE BYTE ERROR CODES

<u>HEX CODE</u>	<u>DEFINITION</u>
10	ID Field Read Error. During a data transfer or Format command, Sector pulses and Byte Sync characters were detected, but the desired sector was not found and an ECC error occurred on one or more ID plus Data fields.
11	Uncorrectable Read Error in the Data Field. The drive detected a data error that could not be corrected using ECC.
12	Sync Byte Error. The drive did not detect a Byte Sync byte within its timing window from a Sector pulse and the desired sector was not found. The Sync Byte is a byte which defines the start of an ID plus Data field and allows the drive to obtain byte synchronization with the serial disk data. The error may occur during any data transfer or format command. The error may mean that no Sync Bytes were detected on the track, or the target sectors Sync Byte was not detected.
13	Not used.
14	Target Sector Not Found. The desired sector was not located within two revolutions of the disk and no error code 10 or 12 errors were detected.
15	Seek Error. After a seek, the desired disk address did not match the ID address read from the disk. Either the cylinder or head bytes did not match.
16 to 17	Not used.
18	Correctable Data Error. The drive detected a read data error while reading that was corrected by ECC. This error code informs the Initiator software that error correction has taken place.
19	Not Used

7.1.3.1 continued

TABLE 7.1.3-4. CLASS 1 SENSE BYTE ERROR CODES -continued

<u>HEX CODE</u>	<u>DEFINITION</u>
1A	Format Error. The drive detected an unformatted track, the wrong interleave on disk, or an ECC error on at least one sector.
1B-1F	Not used.

TABLE 7.1.3-5. CLASS 2 AND 3 SENSE BYTE ERROR CODES
(COMMAND AND MISCELLANEOUS)

<u>HEX CODE</u>	<u>DEFINITION</u>
20	Invalid Command: The drive has received an invalid command from the Initiator.
21	Illegal Disk Address: In the CDB the specified Logical Block Address was beyond the maximum drive limit or the LUN address was not equal to zero.
22	Invalid Parameter: The drive detected an invalid parameter value or an invalid combination of parameters.
23 to 2F	Not used.
30	RAM Diagnostic Error: The drive detected a data error during the RAM sector-buffer diagnostic.
31	Program Memory Checksum Error: During its internal diagnostic, the drive detected a program-memory checksum error. This is caused by a defect in the program memory chip.
32	ECC Diagnostic Error: During the internal diagnostic, the ECC logic failed its test.
33 to 3F	Not used.

7.1.4 FORMAT UNIT COMMAND (CODE 04 HEX)

BIT	7	6	5	4	3	2	1	0
BYTE 0	0	0	0	0	0	1	0	0
BYTE 1	0	0	0	Log. Blk. Addr. (MSB)				
BYTE 2	Log. Blk. Addr.							
BYTE 3	Log. Blk. Addr. (LSB)							
BYTE 4	0	0	0	Interleave				
BYTE 5	r	X	p	X	X	X	X	X

Control Byte:

p (Bit 5) = 0 Format data pattern is defaulted to 6C Hex.

p (Bit 5) = 1 Use format pattern previously written to the drive via the Write Sector Buffer command.

FIGURE 7.1-4. CDB FOR THE FORMAT UNIT COMMAND

This command recalibrates the drive and then seeks to the starting track address specified in bytes 1, 2 and 3 of the CDB. It will write header plus data fields for all sectors. The Format data pattern is defaulted to 6C Hex if the p bit in the Control Byte is a 0. The Format data pattern written will equal the contents of the drives sector buffer if the p bit in the Control byte is a 1.

The format operation always start at the first sector of a track, even though the address specified in the CDB did not point to a track boundary. The format operation will terminate at the max. track and max. head value unless an unrecoverable error is detected. At the successful termination of a Format Unit command, the Sense Data will contain the logical address of the next sector just beyond the last sector accessed to be formatted. If the format operation is terminated due to an unrecoverable error, the Sense Data will contain the logical address of the last sector accessed to be formatted.

7.1.4 continued

When the Format Unit command is issued, any interleave value from zero and up to the number of sectors-per-track minus one may be specified in the Command Parameter Byte (CDB byte 4). An interleave value of zero will default to the most efficient interleave of two. The interleave factor should be adjusted for maximum system performance. Interleaving allows logical contiguous sectors of data on a given track to be mapped onto non-adjacent physical sectors. In general, if the Initiator cannot transfer a full sector of data during and including the time interval separating logical sectors on the disk then the drive may have to wait a full revolution before the next logical sector can be transferred. If this happens, the interleave factor is too low and should be increased until an increase in system speed is noticed.

In order to take full advantage of the interleaving feature of the drive, the operating system should perform multiple sector data transfers. If single sector transfers are employed, the difference in speed with various interleave factors will probably not be noticeable.

A minimum interleave factor of 2 is required in order for the drive to be able to transfer more than the drives Data Buffer capacity per disk revolution. If the interleave factor is one (i.e., logically and physically adjacent sectors) the drive may only be capable of transferring the drives Data Buffer capacity of data per disk revolution.

The drive format consists of a single field per sector which contains a sector address field and the user data field. Data integrity is maintained by a 4 byte ECC (Error Correcting Code). The Format Unit command will format (write) the entire drive on a track at a time basis. After a track has been formatted, the drive will read verify the track. If a read verify error occurs, one reformat attempt will be made and reverified. The drive will automatically deallocate and then automatically reallocate all sectors which fail the format read verify test plus all sectors defined as defective by the factory recorded Error Track Entries (ETF Data), thereby presenting a defect free disk memory space to the user at the completion of a Format Unit command.. This automatic reallocation of sectors will not require any of the Initiator addressable disk space.

7.1.5 Check Track Format Command (Code 05 Hex)

BIT	7	6	5	4	3	2	1	0
BYTE 0	0	0	0	0	0	1	0	1
BYTE 1	0	0	0	NA				
BYTE 2	NA							
BYTE 3	NA							
BYTE 4	NA							
BYTE 5	X	X	X	X	X	X	X	X

FIGURE 7.1.-5. CDB FOR CHECK TRACK FORMAT COMMAND

Upon receipt of this command, the drive will enter the STATUS phase and return a "good" (all zeros) Completion Status for SASI compatibility. Due to the drives automatic media flaw handling feature, this command is not applicable and could create a track addressing error if executed. SASI addressing incompatibilities would occur with initiators which are unable to adapt to the drives increased number of sectors per track.

7.1.6 Format Track Command (Code 06 Hex)

BIT	7	6	5	4	3	2	1	0
BYTE 0	0	0	0	0	0	1	1	0
BYTE 1	0	0	0	NA				
BYTE 2	NA							
BYTE 3	NA							
BYTE 4	NA							
BYTE 5	X	X	X	X	X	X	X	X

FIGURE 7.1-6. CDB FOR THE FORMAT TRACK COMMAND

7.1.6 continued

Upon receipt of this command, the drive will enter the STATUS phase and return a "good" (all zeros) Completion Status for SASI compatibility. Due to the drives automatic media flaw handling feature, this command is not applicable and could create a track addressing error if executed. SASI addressing incompatibilities would occur with initiators which are unable to adapt to the drives increased number of sectors per track.

7.1.7 Format Bad Track Command (Code 07 Hex)

BIT	7	6	5	4	3	2	1	0
BYTE 0	0	0	0	0	0	1	1	1
BYTE 1	0	0	0	NA				
BYTE 2	NA							
BYTE 3	NA							
BYTE 4	NA							
BYTE 5	X	X	X	X	X	X	X	X

FIGURE 7.1-7. CDB FOR THE FORMAT BAD TRACK COMMAND

Upon receipt of this command, the drive will enter the STATUS phase and return a "good" (all zeros) Completion Status for SASI compatibility. Due to the drives automatic media flaw handling feature, this command is not applicable and could create a track addressing error if executed. SASI addressing incompatibilities would occur with initiators which are unable to adapt to the drives increased number of sectors per track.

7.1.8 Read Command (Code 08 Hex)

BIT	7	6	5	4	3	2	1	0
BYTE 0	0	0	0	0	1	0	0	0
BYTE 1	0	0	0	Log. Blk. Addr.				
BYTE 2	Log. Blk. Addr.							
BYTE 3	Log. Blk. Addr.							
BYTE 4	Block Count							
BYTE 5	r	a	X	X	X	X	X	X

Control Byte:

Bit 7 and 6 are Interpreted per Section 6.2.6

FIGURE 7.1-8. CDB FOR THE READ COMMAND

This command allows the Initiator to read up to 256 logically contiguous blocks (sectors) from the disk media starting at the Logical Block Address specified in bytes 1, 2 and 3 of the CDB with a single CDB transfer to the drive. The number of blocks to be transferred is specified in byte 4 of the CDB. A Block Count of 1 to 255 indicates the number of blocks that will be transferred. A Block Count of zero indicates 256 blocks. If required, a seek to the specified Logical Block Address will be performed by the drive prior to initiating the reading of data from the disk media.

Read data transfers with the Initiator will not be initiated unless at least one full sector of data is available in the drives data buffer. For multiple sector reads, the transfer of data will continue until the number of blocks specified by byte 4 of the CDB has been read and transferred to the Initiator or until an unrecoverable error is detected. The Sense Data will contain the address of the last sector access.

This command will interpret Bits 6 and 7 of Byte 5 of the CDB. Delays may be encountered during the Read command while the retries or ECC correction are being performed. (See Section 6.2.6 and Section 9.0).

7.1.8 continued

The Initiator must accept all data presented to the Initiator after sending this command and until the drive sends Completion Status to the Initiator during the STATUS phase (The Initiator may prematurely terminate this command by creating the RESET condition as described in Section 5.2.2).

The drive will attempt to the maximum extent possible to automatically maintain an error free disk memory space to the user. As previously stated, the drive will reallocate all known and found defective sectors during execution of a Format Unit command. To insure that a high level of data integrity is continually maintained the drive may automatically reallocate any additional defective sectors that develop after the format function has been performed. The drive will automatically reallocate any sector which requires any of the following actions during execution of the Read command:

- a) ECC correction of data in this sector to successfully recover data.
- b) Attempted ECC correction of data in this sector to attempt to successfully recover data (i.e., if an uncorrectable data error occurs).

If a sector is reallocated, the recovered (or uncorrectable) data will also be automatically written at the reallocation sector location.

7.1.8 continued

Sense Data will always be valid after this command is executed and Completion Status has been sent. (i.e., Sense Data will be valid even if the Completion Status did not indicate a "Check Condition"). If the Address Valid bit in the Sense Data is true (1), the Sense Data Logical Block Address will point to the last logical block (Sector) accessed by the drive. If the Address Valid bit in the Sense Data is false (0), then the Sense Data Logical Block Address bytes are not valid and signifies that the drive did not attempt to access the starting block address specified in the CDB. In normal operation, (i.e., bit 7 and 6 both zero in the Control byte of the CDB), the drive will not send a "Check Condition" status during the STATUS phase if retries, ECC data correction or retrieval of any data from an alternate track or sector was required to successfully recover any of the requested data blocks. All of the requested data will be sent to the Initiator, but if a ECC data correction was ever applied, the Sense Data will contain a "Correctable Data Error" (Code 18 Hex) error code. The Sense Data Logical Block Address will still point to the last block (sector) accessed and sent to the Initiator.

If an "abnormal" operating mode is selected (i.e., bit 6 equal to 1 in the Control byte of the CDB which signifies no retries prior to applying ECC data correction to a read data block with a resultant detected ECC error), the drive will send a "Check Condition" status during the STATUS phase after prematurely terminating the Read command, applying the ECC data field correction process to the data field and sending the ECC corrected data to the initiator. The resultant Sense Data will contain the "Correctable Data Error" (Code 18 Hex) error code and the Sense Data Logical Block Address will point to the logical block address of the data field which was corrected by the ECC data correction process and sent to the Initiator. If the Initiator wishes to resume reading data fields from where it was terminated, a new Read command containing an updated starting Logical Block Address and Block Count must be sent to the drive. The drive will not prematurely terminate or send a "Check Condition" Status during the STATUS phase if retries or access to an alternate track or sector was required to successfully recover the data.

7.1.8 continued

Regardless of the state of either bit 7 or bit 6 in the Control byte of the CDB, the drive will always prematurely terminate a Read command and send a "Check Condition" status during the STATUS phase, and update the Sense Data bytes if a requested data block cannot be successfully read from the disk media. A data block which cannot be successfully recovered or a data block with an "Uncorrectable ECC error" will not be sent to the Initiator and the Sense Data Logical Block Address will point to this block address.

7.1.8.1 Disk Data Read and Transfer Times

The drive is capable of transferring data to the Initiator after the data has been read from the disk media into the drives internal data buffer. The drive is also capable of simultaneously reading a sector of data into its data buffer while also transferring a previously read sector to an Initiator. Thus, the rate at which the Initiator can transfer data with the drive may greatly affect the sustainable data transfer rate for reading more than one sector per CDB. The 8 bits allocated in the CDB for Block Count limits the maximum number of blocks to be transferred for a single CDB to 256 blocks.

The drive will not attempt to send any data in a sector to the Initiator unless the entire sector is successfully read error free into its internal data buffer. The drives maximum sustainable data transfer rate with an Initiator is attained with an interleave of 2 (i.e., one physical sector separating each logical sector recorded on the disk media). The drive will also require one rotational latency (16.67 ms) whenever a cylinder change and/or a single track Seek is required to access the next logical sector.

7.1.9 Read Verify Command (Code 09 Hex)

BIT	7	6	5	4	3	2	1	0
BYTE 0	0	0	0	0	1	0	0	1
BYTE 1	0	0	0	Log. Blk. Addr.				
BYTE 2	Log. Blk. Addr.							
BYTE 3	Log. Blk. Addr.							
BYTE 4	Block Count							
BYTE 5	r	a	X	X	X	X	X	X

Control Byte:

Bits 7 and 6 are interpreted per Section 6.2.6

FIGURE 7.1-9. CDB FOR READ VERIFY COMMAND

This command functions the same as a Read command, except that no data is transferred to the Initiator. This command may be used to insure data integrity following a Write command.

7.1.10 Write Command (Code 0A Hex)

BIT	7	6	5	4	3	2	1	0
BYTE 0	0	0	0	0	1	0	1	0
BYTE 1	0	0	0	Log. Blk. Addr.				
BYTE 2	Log. Blk. Addr.							
BYTE 3	Log. Blk. Addr.							
BYTE 4	Block Count							
BYTE 5	r	X	X	X	X	X	X	X

FIGURE 7.1-10. CDB FOR WRITE COMMAND

7.1.10 continued

This command allows the Initiator to write up to 256 logically contiguous blocks (sectors) to the disk media starting at the Logical Block Address specified in bytes 1, 2 and 3 of the CDB with a single CDB transfer to the drive. The number of blocks to be written is specified in byte 4 of the CDB. A Block Count of 1 to 255 indicates the number of blocks that will be transferred and written. A Block Count of zero indicates 256 blocks. If required, a seek to the specified Logical Block Address will be performed by the drive prior to initiating the requests for the data to be written from the Initiator and the writing of this data to the disk media.

This command will interpret bit 7 of byte 5 of the CDB. If bit 7 is a zero, delays may be encountered during the Write command execution while retries are being performed. (See Section 6.2.6 and Section 9.0).

The Initiator must send the drive write data after sending this command until the drive sends Completion Status to the Initiator during the STATUS phase. (The Initiator may prematurely terminate this command by creating the RESET condition as described in Section 5.2.2).

Data will be requested from the Initiator by the drive prior to initiating a write data operation to the media. Since the drive can potentially write a sector faster than an Initiator can supply data, a sector write will not be initiated unless at least one full sector of data is ready to be written from the drive's internal data buffer. For multisector writes, the drive will continue to request data from the Initiator until the specified number of data blocks has been received or until an unrecoverable error is detected. When the specified number of blocks of data have been transferred to the drives internal data buffer, the drive will have one or more blocks of data to write to the drive media. The Completion Status will not be sent to the Initiator until the last block of data has been written to the disk media (or an unrecoverable error is detected).

7.1.10 continued

The drive does not perform an automatic read verify of data written on the media by this Write command (Therefore, no ECC errors will be reported).

If an unrecoverable error is detected, the drive will prematurely terminate and send the "Check Condition" status during the STATUS phase. The Sense Data will contain the applicable error code. If a disk drive access was ever attempted, the Sense Data Address Valid bit will be true and the Sense Data Logical Block Address bytes will point to the logical block address of the last sector accessed (i.e., The sector where the error occurred). The Sense Data Address Valid bit will be false only if no attempt to access the disk was made.

As with the Read command, no indication will be provided to the Initiator if retries or access to reallocated tracks or sectors are required to successfully execute the command.

7.1.10.1 Disk Data Transfer and Write Times

The time to receive and write specified number of sectors is basically the same as the time to read and transfer data to the Initiator for the Read command except that the direction of data flow is reversed. For the Write command, complete sectors of data must be received from the Initiator prior to being written on the disk media. The drive is capable of simultaneously writing a previously received sector of data onto the disk media while it is receiving from the Initiator future sectors of data to be written.

7.1.1.11 Seek Command (Code 0B Hex)

BIT	7	6	5	4	3	2	1	0
BYTE 0	0	0	0	0	1	0	1	1
BYTE 1	0	0	0	Log. Blk. Addr.				
BYTE 2	Log. Blk. Addr.							
BYTE 3	Log Blk. Addr.							
BYTE 4	X	X	X	X	X	X	X	X
BYTE 5	r	X	X	X	S	S	S	S

FIGURE 1.1-11. CDB FOR THE SEEK COMMAND

This command requests the drive to seek to the Logical Block Address specified in bytes 1, 2 and 3 of the CDB. Seek retries will be determined by the state of the retry bit in the Control byte (Bit 7 of Byte 5 in the CDB). The utilization of this command is limited since most commands involving data transfer to/from the drive media contain implied seek addresses.

The S bits (bits 0, 1, 2 and 3 of Byte 5 of the CDB) are interpreted per section 6.2.5.5. for this command.

7.1.12 Initialize Drive Characteristics Command (Code 0C Hex)

BIT	7	6	5	4	3	2	1	0
BYTE 0	0	0	0	0	1	1	0	0
BYTE 1	0	0	0	X	X	X	X	X
BYTE 2	X	X	X	X	X	X	X	X
BYTE 3	X	X	X	X	X	X	X	X
BYTE 4	X	X	X	X	X	X	X	X
BYTE 5	X	X	X	X	X	X	X	X

FIGURE 7.1-12A. CDB FOR THE INITIALIZE DRIVE CHARACTERISTICS COMMAND

This command may be utilized to define the maximum data burst error length which will be corrected by the drive's ECC error correction routines. When the drive is powered up or receives a RESET from the Initiator, the drive characteristics will be initialized to the drive's default values. This command is not required if the drive's default value for max ECC burst length is acceptable for system usage.

After the drive receives the CDB for this command, the drive will enter the DATA phase and request 8 bytes of drive characteristics data from the Initiator. The format of these bytes are shown in Figure 7.1.12B.

7.1.12 continued

BIT	7	6	5	4	3	2	1	0	
BYTE 0	X	X	X	X	X	X	X	X	N/A
BYTE 1	X	X	X	X	X	X	X	X	N/A
BYTE 2	X	X	X	X	X	X	X	X	N/A
BYTE 3	X	X	X	X	X	X	X	X	N/A
BYTE 4	X	X	X	X	X	X	X	X	N/A
BYTE 5	X	X	X	X	X	X	X	X	N/A
BYTE 6	X	X	X	X	X	X	X	X	N/A
BYTE 7	O	O	O	O	E	E	E	E	Max. ECC Data Burst Lg.

FIGURE 7.1-12B. PARAMETER DATA FOR INITIALIZE
DRIVE CHARACTERISTICS COMMAND

When the drive is powered on or reset, the default value listed below are set.

Max. ECC Data Burst Length = 5 (decimal) bits

The value of the Max. ECC Data Burst Length parameter should be between 0 and 11 (decimal). If the E value is zero then the drive will treat all data field ECC detected errors as uncorrectable data errors. If the E value is between 1 and 11 the drive will treat all single burst data errors greater than 5 bits as uncorrectable data errors.

7.1.13 Read ECC Burst Error Length Command (Code OD Hex)

BIT	7	6	5	4	3	2	1	0
BYTE 0	0	0	0	0	1	1	0	1
BYTE 1	0	0	0	X	X	X	X	X
BYTE 2	X	X	X	X	X	X	X	X
BYTE 3	X	X	X	X	X	X	X	X
BYTE 4	X	X	X	X	X	X	X	X
BYTE 5	X	X	X	X	X	X	X	X

FIGURE 7.1-13. CDB FOR READ ECC BURST
 ERROR LENGTH COMMAND

This command is only valid following a "Correctable Data Error" (Code 18 Hex) error code is detected in the Sense Data. The drive will transfer one byte to the Initiator indicating the length of the data error corrected. The error length is determined by counting the number of bits between the first and the last bit in error, including the first and the last bits.

7.1.14 Format Alternate Track Command (Code 0E Hex)

BIT	7	6	5	4	3	2	1	0
BYTE 0	0	0	0	0	1	1	1	0
BYTE 1	0	0	0			NA		
BYTE 2				NA				
BYTE 3				NA				
BYTE 4				NA				
BYTE 5	X	X	X	X	X	X	X	X

FIGURE 7.1-14A. CDB FOR FORMAT ALTERNATE TRACK COMMAND

BIT	7	6	5	4	3	2	1	0
BYTE 0				NA				
BYTE 1				NA				
BYTE 2				NA				

FIGURE 7.1-14B. ADDITIONAL PARAMETER BYTES (ALTERNATE TRACK ADDRESS) FOR FORMAT ALTERNATE TRACK COMMAND

Upon receipt of this command, the drive will enter the DATA phase and request three additional parameter bytes from the Initiator. The drive will enter the STATUS phase and return a "good" (all zeros) Completion Status for SASI compatibility. Due to the drives automatic media flaw handling feature, this command is not applicable and could create a track addressing error if executed. SASI addressing incompatibilities would occur with initiators which are unable to adapt to the drives increased number of sectors per track.

7.1.15 Write Sector Buffer Command (Code OF Hex)

BIT	7	6	5	4	3	2	1	0
BYTE 0	0	0	0	0	1	1	1	1
BYTE 1	X	X	X	X	X	X	X	X
BYTE 2	X	X	X	X	X	X	X	X
BYTE 3	X	X	X	X	X	X	X	X
BYTE 4	X	X	X	X	X	X	X	X
BYTE 5	X	X	X	X	X	X	X	X

FIGURE 7.1-15 CDB FOR WRITE SECTOR BUFFER COMMAND

Upon receipt of this command, the drive will enter the DATA phase and request one block (Sector) of data from the Initiator and store this data in its internal data buffer.

This command is not to be used with the Write command to write data onto the disk media (the Write command automatically requests the data to be written on the media). This command is provided as a diagnostic tool or to define the data field pattern for the Format commands.

7.1.16 Read Sector Buffer (Code 10 Hex)

BIT	7	6	5	4	3	2	1	0
BYTE 0	0	0	0	1	0	0	0	0
BYTE 1	X	X	X	X	X	X	X	X
BYTE 2	X	X	X	X	X	X	X	X
BYTE 3	X	X	X	X	X	X	X	X
BYTE 4	X	X	X	X	X	X	X	X
BYTE 5	X	X	X	X	X	X	X	X

FIGURE 7.1-16. CDB FOR READ SECTOR BUFFER COMMAND

Upon receipt of the command, the drive will enter the DATA phase and transfer one block (sector) of data from the drive's internal data buffer to the Initiator. This command will send the last block of data that was written into the buffer.

This command is not generally to be used with the Read command to read data from the disk media (The Read command automatically requests the transfer of data read from the media to the Initiator). This command is provided as a diagnostic tool when used in conjunction with the Write Sector Buffer command. This command may also be used to recover data from the media which had an "Uncorrectable Read Error" when read from the disk. (With a Read command, data blocks read which had an uncorrectable data error are not transferred to the Initiator and the error is reported. Thus, if the Initiator desires the erroneous data, the Read Sector Buffer command may be utilized to retrieve this data).

7.2 Group 7 Command Descriptions.

Group Seven Command Codes and Names are listed in Table 7.2-1.

TABLE 7.2-1. COMMAND CODES FOR GROUP 07 COMMANDS

HEX OP CODE*	DESCRIPTION
E0	RAM DIAGNOSTIC
E1	RESERVED
E2	RESERVED
E3	DRIVE DIAGNOSTIC
E4	INTERNAL DIAGNOSTIC
E5	READ LONG
E6	WRITE LONG
E7	RETRY STATISTICS
E8 thru EF	RESERVED

*Group Code plus Command Code.

7.2.1 Ram Diagnostics (Code E0 Hex)

BIT	7	6	5	4	3	2	1	0
BYTE 0	1	1	1	0	0	0	0	0
BYTE 1	X	X	X	X	X	X	X	X
BYTE 2	X	X	X	X	X	X	X	X
BYTE 3	X	X	X	X	X	X	X	X
BYTE 4	X	X	X	X	X	X	X	X
BYTE 5	X	X	X	X	X	X	X	X

FIGURE 7.2-1. CDB FOR RAM DIAGNOSTICS COMMAND.

This command verifies that the drive internal data buffer is operational by writing, reading and verifying various data patterns to and from all locations.

7.2.2 Drive Diagnostics (Code E3 Hex)

BIT	7	6	5	4	3	2	1	0
BYTE 0	1	1	1	0	0	0	1	1
BYTE 1	0	0	0	X	X	X	X	X
BYTE 2	X	X	X	X	X	X	X	X
BYTE 3	X	X	X	X	X	X	X	X
BYTE 4	X	X	X	X	X	X	X	X
BYTE 5	r	X	X	X	X	X	X	X

FIGURE 7.2-2. CDB FOR DRIVE DIAGNOSTIC COMMAND.

This command causes the drive to recalibrate to cylinder 0, head 0. The drive will then read the ID area of the first sector on the track and verify that the formatted cylinder, head and sector number equals the track number. The drive will seek to all tracks and verify the first sector on each track. If this diagnostic passes, it implies that the drive has been formatted and that the first ID area of each track is good. Tracks formatted as defective tracks will not be checked. If an alternate track has been assigned then the alternate track will be checked.

7.2.3 Internal Diagnostics (Code E4 Hex)

BIT	7	6	5	4	3	2	1	0
BYTE 0	1	1	1	0	0	1	0	0
BYTE 1	X	X	X	X	X	X	X	X
BYTE 2	X	X	X	X	X	X	X	X
BYTE 3	X	X	X	X	X	X	X	X
BYTE 4	X	X	X	X	X	X	X	X
BYTE 5	X	X	X	X	X	X	X	X

FIGURE 7.2-3. CDB FOR INTERNAL DIAGNOSTICS COMMAND.

This test causes the drive to verify its program memory and ECC detection circuits. The program memory is validated by performing a program memory checksum verification. The ECC circuitry is verified by writing a data field with a data error then reading this data field and verifying that the ECC circuitry detects the error. The drive will also read a good data field and verifying that no error is reported by the ECC circuitry.

7.2.4 Read Long Command (Code E5 Hex)

BIT	7	6	5	4	3	2	1	0
BYTE 0	1	1	1	0	0	1	0	1
BYTE 1	0	0	0	Log. Blk. Addr.				
BYTE 2	Log. Blk. Addr.							
BYTE 3	Log. Blk. Addr.							
BYTE 4	X	X	X	X	X	X	X	X
BYTE 5	r	0	X	X	X	X	X	X

FIGURE 7.2-4. CDB FOR THE READ LONG COMMAND.

This command is used to allow the Initiator to check the drives ECC logic. This command will cause a read of the data block (sector) and 4 byte ECC field specified in bytes 1, 2 and 3 of the CDB and a transfer of this data plus the 4 recorded ECC bytes to the Initiator. Using this command the Initiator may read a known good data field and its ECC field, modify the data field and then use the Write Long command to write the erroneous data and original ECC field back on the disk media. The Initiator may then use a normal Read command to read this data block. The drive should detect an ECC error and if the error is correctable, be able to correct the data field.

7.2.5 Write Long Command (Code E6 Hex)

BIT	7	6	5	4	3	2	1	0
BYTE 0	1	1	1	0	0	1	1	0
BYTE 1	0	0	0	Log. Blk. Addr.				
BYTE 2	Log. Blk. Addr.							
BYTE 3	Log. Blk. Addr.							
BYTE 4	X	X	X	X	X	X	X	X
BYTE 5	r	0	0	0	X	X	X	X

FIGURE 7.2-5. CDB FOR THE WRITE LONG COMMAND.

This command causes the drive to seek to the Logical Block Address specified in bytes 1, 2 and 3 of the CDB, request a data block (sector) plus 4 ECC bytes from the Initiator and then write this received data block plus 4 ECC bytes on the disk media. For this command the drives internal ECC Logic will not be utilized to calculate and write the data field ECC bytes. When used in conjunction with the Read Long command as discussed in section 7.2.4, the drives internal ECC logic operation may be diagnosed by the Initiator.

7.2.6 Retry Statistics Command (Code E7 Hex)

BIT	7	6	5	4	3	2	1	0
BYTE 0	1	1	1	0	0	1	1	1
BYTE 1	0	0	0	X	X	X	X	X
BYTE 2	X	X	X	X	X	X	X	X
BYTE 3	X	X	X	X	X	X	X	X
BYTE 4	X	X	X	X	X	X	X	X
BYTE 5	X	X	X	X	X	X	X	X

FIGURE 7.2-6A. CDB FOR RETRY STATISTICS COMMAND.

BIT	7	6	5	4	3	2	1	0	
BYTE 0	N	N	N	N	N	N	N	N	# of non-recoverable media or drive errors
BYTE 1	N	N	N	N	N	N	N	N	
BYTE 2	R	R	R	R	R	R	R	R	# of recoverable media or drive errors
BYTE 3	R	R	R	R	R	R	R	R	
BYTE 4	S	S	S	S	S	S	S	S	# of "soft" ECC errors
BYTE 5	S	S	S	S	S	S	S	S	
BYTE 6	C	C	C	C	C	C	C	C	# of correctable errors
BYTE 7	C	C	C	C	C	C	C	C	

FIGURE 7.2-6B. STATISTICS DATA SENT TO THE INITIATOR AS A RESULT OF RECEIVING THE RETRY STATISTICS COMMAND.

7.2.6 continued

This command causes the drive to transfer 8 bytes of statistics information to the Initiator. The statistics information are counts of the number of times the drive has detected certain error conditions. The counts are set to zero when the drive is powered on (or off), a SASI RESET condition is received or when this 8 Bytes of statistics information has been read by an Initiator using this command. If a maximum count is reached prior to resetting, the count will stay at the maximum value.

The 8 Bytes of statistics data is defined in Figure 7.2-6B.

The first two bytes (N) are the number of non-recoverable media or drive errors that occurred. A non-recoverable error is an error that cannot be overcome even after all retries are exhausted, except correctable data errors. The second two bytes (R) are the number of recoverable media or drive errors that occurred. A recoverable error is an error that occurred at least once, but did not occur again after one or more retries, except correctable data errors. The third parameter is the number of "soft" ECC errors that occurred. A "soft" ECC error is an ECC error that occurs on the first read attempt, but no error occurs on the retry read. The error is not due to a media defect. The last two bytes (C) are the number of errors that were correctable using error correction (ECC).

8.0 COMPLETION STATUS

A status byte referred to as Completion Status will be sent from the drive to the Initiator during the STATUS phase at the termination of each command unless the command is cleared by the drive being powered down or by a SASI interface RESET condition.

The status byte format is shown in Figure 8.1.

BIT	7	6	5	4	3	2	1	0
-----	----	----	----	----	----	----	-----	----
BYTE 0	0	0	0	0	0	0	CK.COND.	0

FIGURE 8.1

If the Completion Status byte equals all zeros the command was successfully executed with no detected error.

If the "Check Condition" bit (bit 1) equals a 1 then a possible error was detected while attempting to execute the command. When this bit is a 1 then the drives Sense Data is valid and will explain the reason for the "Check Condition". The Request Sense command should be issued following a "Check Condition" to determine the nature of the condition.



STAPLE

STAPLE

FOLD

FOLD



NO POSTAGE
NECESSARY
IF MAILED
IN THE
UNITED STATES

BUSINESS REPLY MAIL
FIRST CLASS PERMIT NO. 1332 OKLAHOMA CITY, OKLA.

POSTAGE WILL BE PAID BY ADDRESSEE

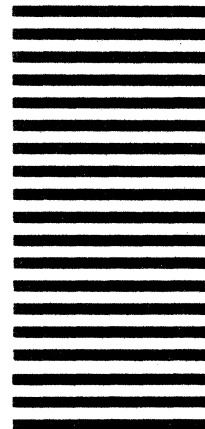

CUT ALONG

MAGNETIC PERIPHERALS, INC.

P.O. BOX 12313

OKLAHOMA CITY, OKLAHOMA 73157

Attention *Rigid Disk Applications Engineering, OKM 272*

FOLD

FOLD

TRAINING INQUIRY

FILE REFERENCE

FROM:

Date _____

Name _____

Address _____

City _____

State _____ Zip Code _____

Area Code _____ Phone _____

FOR ADDITIONAL INFORMATION CONTACT:

Customer Training
Mail Station: OKM 154
Phone: (405) 324-3001

Magnetic Peripherals, Inc.
P.O. BOX 12313
Oklahoma City, Oklahoma
73157

FOR INFORMATION CONCERNING OEM MAINTENANCE TRAINING ON THIS EQUIPMENT MAIL THIS INQUIRY FORM OR CALL MAGNETIC PERIPHERALS, INC. (405) 324-3001

PLEASE SUPPLY THE FOLLOWING INFORMATION:

EQUIPMENT IDENTIFICATION _____

DOCUMENT / MANUAL IDENTIFICATION _____

INDICATE INTEREST / CHECK APPROPRIATE BOX(S).

CLASS SCHEDULE

COURSE DESCRIPTION

OTHER _____

STAPLE

STAPLE

FOLD

FOLD



NO POSTAGE
NECESSARY
IF MAILED
IN THE
UNITED STATES

BUSINESS REPLY MAIL
FIRST CLASS PERMIT NO. 1332 OKLAHOMA CITY, OKLA.

POSTAGE WILL BE PAID BY ADDRESSEE

MAGNETIC PERIPHERALS, INC.

P.O. BOX 12313

OKLAHOMA CITY, OKLAHOMA 73157

Attention *Customer Training, OKM154*

FOLD

FOLD

CUT ALONG