

**ILLUSTRATED PARTS LIST
FOR THE
4046 MOVING HEAD DISK CONTROLLER
AND
4047 & 4049 DISK CARTRIDGE ADAPTERS**

VOLUME II

Ordering No. 016-000018

© Data General Corporation 1971

All Rights Reserved.

Printed in the United States of America

Rev. 00, August 1972

016-000018-00

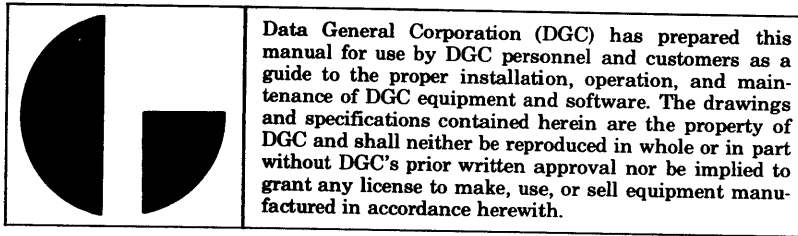

TABLE OF CONTENTS

ILLUSTRATED PARTS LIST

<u>Paragraph</u>		<u>Page</u>
1	INTRODUCTION	1-1
1-1	Reference Designations and Parts Numbering System.....	1-3
1-2	Identification of Parts From Reference Numbers.....	1-3
1-3	Inter-Assembly Wiring Information.....	1-3
1-4	Logic Diagram to IPL Cross Reference	1-5

LIST OF ILLUSTRATIONS

<u>Figure</u>	<u>Title</u>	<u>Page</u>
1-1	Example of PCB Component Reference Numbering System.....	1-4
1-2	4046 Disk Controller PCB Assembly.....	1-7/1-8
1-3	4047 or 4049 Disk Adapter.....	1-17-1-18
1-4	Logic Interface PCB Assembly for the 4047 or 4049 Disk Adapter unit.....	1-23/1-24
1-5	Plug Interface PCB Assembly for the 4047 or 4049 Disk Adapter unit.....	1-31/1-32
1-6	Disk Adapter Power Supply for the 4047 or 4049 Disk Adapter unit.....	1-36
1-7	Type 4047 Power Supply PCB Assembly.....	1-39/1-40

LIST OF TABLES

<u>Table</u>		<u>Page</u>
1-1	List of Manufacturers	1-1
1-2	Logic Diagram to IPL Cross Reference Listing	1-5

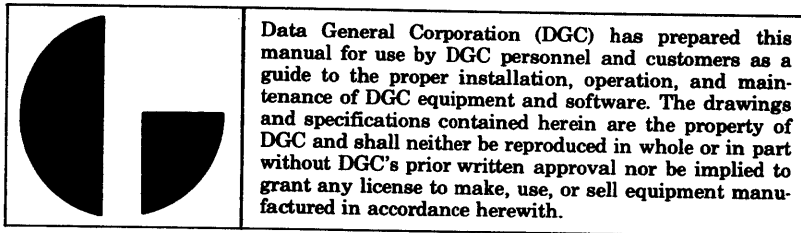

ILLUSTRATED PARTS LIST

1 INTRODUCTION

This chapter contains a complete list of replaceable parts for the 4046 Disk Controller and the Disk Adapter units type 4047 and type 4049. To facilitate the procurement of parts not manufactured by Data General, the descriptions for such parts include an associated manufacturer's reference code number. Each number indexes the corresponding manufacturer's name and address as listed in Table 1-1 of this chapter. Manufacturer index numbers assignments are for reference purposes only and do not correspond to codes assigned by the Federal Supply Code. Personnel involved in provisioning from this document may consult the Federal Supply Code for Manufacturers, Cataloging Handbook H4-1, for the proper Federal reference codes for manufacturers listed in this chapter. The original manufacturer's part number is listed for all items including commercially available hardware to facilitate exact replacement of substitute parts.

Table 1-1. List of Manufacturers

Code Number	Manufacturer's Name and Address
0010	Data General Corp. Southboro, Massachusetts
0011	Allen Bradley Milwaukee, Wisconsin
0013	Fairchild Semiconductors Mountainview, California
0014	Signetics, Inc. Sunnyvale, California
0015	Sprague Products Co. North Adams, Massachusetts
0017	Microswitch, Division Honeywell Freeport, Illinois
0019	Erie Technological Prod. State College, Pennsylvania
0021	Belden Wire Chicago, Illinois
0026	Motorola Phoenix, Arizona
0034	Continental Device Corp. Hawthorne, California

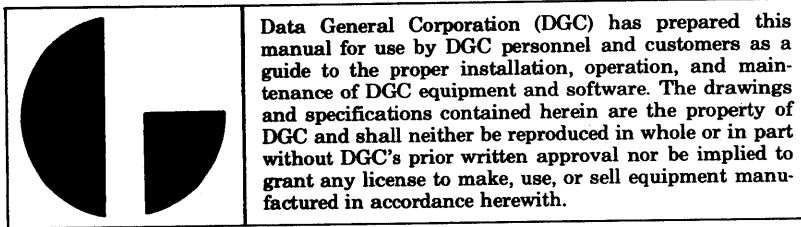
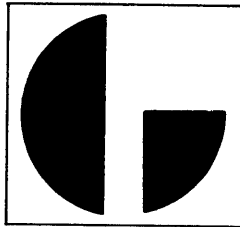

Table 1 -1. List of Manufacturers (Continued)

Code Number	Manufacturer's Name and Address
0036	Cornell-Dublier Newark, New Jersey
0037	Valpey-Fisher Corp. Holliston, Massachusetts
0038	Texas Instruments, Inc. Dallas, Texas
0047	Dickson Electronics Corp. Scottsdale, Arizona
0048	South Co., Inc. Lester, Pennsylvania
0051	Chicago Lock Company Chicago, Illinois
0052	Elmenco Willimantic, Connecticut
0056	Sangamo Electrical Braintree, Massachusetts
0059	Mallory Capacitor Div. of P. R. Mallory & Co. Indianapolis, Indiana
0060	Bussmann Mfg. Div. of McGraw-Edison Co. St. Louis, Missouri
0061	Tel Lab, Inc. Manchester, New Hampshire
0063	Rotron Inc. Woodstock, New York
0064	General Electric Co. Semiconductor Products Div. Syracuse, New York
0066	Nytronics, Inc. Darlington, South Carolina
0070	Winchester Electronics Inc. Division of Litton Industries Oakville, Connecticut



Data General Corporation (DGC) has prepared this manual for use by DGC personnel and customers as a guide to the proper installation, operation, and maintenance of DGC equipment and software. The drawings and specifications contained herein are the property of DGC and shall neither be reproduced in whole or in part without DGC's prior written approval nor be implied to grant any license to make, use, or sell equipment manufactured in accordance herewith.

1-1.1 Reference Designations and Parts Numbering System

All reference designators appearing in the Group Assembly Parts List have been assigned in accordance with USA Standard USAS Y32.16-1968. The general procedure for assigning reference designators to printed circuit board assemblies having high component density is to number components in discrete rows from left to right across the assembly, with the number sequence of the rows increasing from the bottom toward the top of the assembly. Under these conditions the components with the lowest reference numbers will be found at the bottom left-hand side of the assembly, with the highest reference numbered components located on the top right-hand side of the assembly. (The bottom of any printed circuit board assembly is defined as the Printed Circuit Connector end of the board. The top of the printed circuit board assembly is defined by the handle.) This numbering convention is maintained wherever possible. Components with different part numbers are also called out as required by the figure indexing. Component row boundaries are defined as follows: From the printed connector up to the edge of the first Integrated Package (IC) row is defined as the connector row. From the edge of the first IC row to the edge of the second IC row is defined as COMPONENTS ROW 1. From the edge of the second IC row to the edge of the third IC row is defined as COMPONENTS ROW 2, ... etc. Figure 1-1 is an example of the PCB Component Reference Numbering System showing the Components Row layout.

Alternate vendor items are listed in the Group Assembly Parts List immediately after the item for which it is an alternate. Alternate parts so listed are not assigned as index number, and are designed by a \diamond symbol immediately preceding the Manufacturer's part number.

1-1.2 Identification of Parts from Reference Numbers

The reference designator assigned to each part appears both on the logic diagram showing the electrical position of the corresponding component, and in the Group Assembly Parts list. To locate a part simply note its reference number appearing on the logic diagram, then reference the corresponding assembly or subassembly figure list in the Group Assembly Parts list for the corresponding reference designator. Note the figure index number listed opposite the reference designator, and find the corresponding indexed call-out on the figure. Index numbers are called out parenthetically on the figure to identify a part which is the same as the one referenced, and hence provides visual identification. To find the exact (electrical) component referenced in the logic diagram look for the reference number called out on the figure.

1-1.3 Inter-Assembly Wiring Information

(Reference the Installation Drawing 010-000012 bound into the Illustrated Parts List.) The 4046 Disk Controller is mounted in the Processor, and is connected with the Disk Adapter unit via the computer I/O cable (Data General #005-000468). The signal bus between the Disk Adapter unit and the Disk Drive unit is established by the ribbon type cable (Data General #118-000098) connected between the Adapter and the Drive. A terminator card (Data General #118-000100) must be installed in the last Drive connected with the disk signal bus; which is the last unit of the daisy-chain in a multiple drive installation, or the first and only unit of a single drive installation. DC power is supplied to each Drive from the Disk Adapter unit by a special dc cable. The internal and external cablings are listed below with their respective function and Data General Drawing number.

<u>Connector</u>	<u>Function</u>	<u>Drawing No.</u>
Adapter Connector P2 or P3	External Cable, Adapter (4047 or 4049) to Computer	005-000468
Disk unit Input/Output Connector (Receptacle Type)	Signal Cable for Drive units 4047A and 4047B	118-000098 (See Note 1 below)
Disk unit Power Connector	Cable DC Power Supply for Drive units 4047A and 4047B	118-000099
Disk unit Input/Output Connector (Pin Type)	Terminator, Signal Bus for units 4047A and 4047B	118-000100

Note 1: 118 series Drawing numbers denote items purchased by Data General, and hence are specification drawings rather than wire lists.

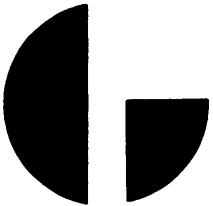
 Data General Corporation (DGC) has prepared this manual for use by DGC personnel and customers as a guide to the proper installation, operation, and maintenance of DGC equipment and software. The drawings and specifications contained herein are the property of DGC and shall neither be reproduced in whole or in part without DGC's prior written approval nor be implied to grant any license to make, use, or sell equipment manufactured in accordance herewith.

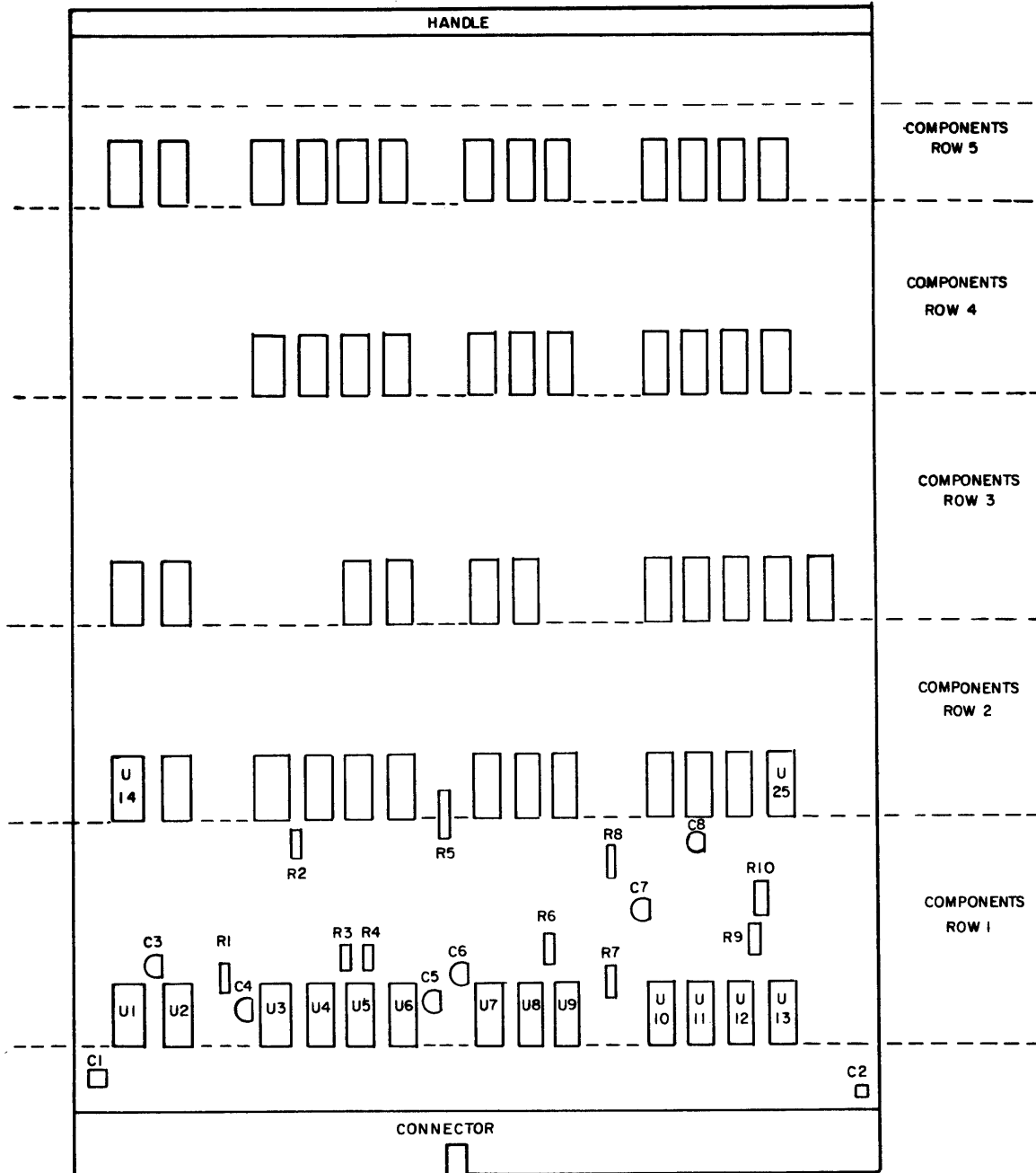
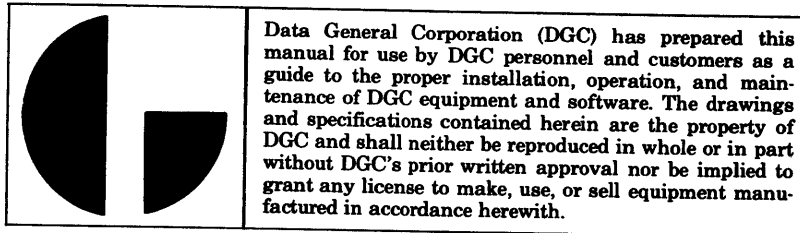

Figure 1-1. Example of PCB Component Reference Numbering System



The wiring connections between the 4046 Disk Controller slot of the Multiple PCB Connector panel (of the Processor) and the 50 pin output connector (also mounted towards the rear of the Processor enclosure) are listed in DGC Drawing No. 005-000469 titled: "4046 Option-Internal Cable Assembly." The wiring connections within the Disk Adapter unit for the cable run from the power supply PCB subassembly to both the Adapter Plug Interface PCB assembly and the Adapter lock-switch assembly (on the Adapter front panel) are listed in DGC Drawing No. 005-000584, titled: "Adapter Internal Cable Assembly (Adapters 4047 and 4049)". Internal cabling information for the Disk Drive unit is presented in the Maintenance Manual for the Drive supplied under separate cover.

1-1.4 Logic Diagram to IPL Cross Reference

The logic diagrams for the 4046 Controller, the 4047 Plug Interface and the 4047 Logic Interface are listed in Table 1-2 where each is cross referenced to its corresponding figure in the Illustrated Parts List.

Table 1-2. Logic Diagram to IPL Cross Reference Listing

<u>LOGIC DIAGRAM TITLE</u>	<u>DRAWING NO.</u>	<u>IPL FIGURE No.</u>
Disk Pack Control I/O	001-000122 (Sheet 1)	1-2
Disk Pack Control Timing	001-000122 (Sheet 2)	1-2
Disk Pack Control Registers	001-000122 (Sheet 3)	1-2
4047 Plug Interface	001-000142	1-5
4047 Logic Interface	001-000143	1-4

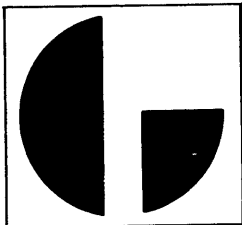
	<p>Data General Corporation (DGC) has prepared this manual for use by DGC personnel and customers as a guide to the proper installation, operation, and maintenance of DGC equipment and software. The drawings and specifications contained herein are the property of DGC and shall neither be reproduced in whole or in part without DGC's prior written approval nor be implied to grant any license to make, use, or sell equipment manufactured in accordance herewith.</p>
--	---

4046 DISK CONTROLLER
AND
4047 & 4049 DISK ADAPTER UNITS
GROUP ASSEMBLIES PARTS LIST

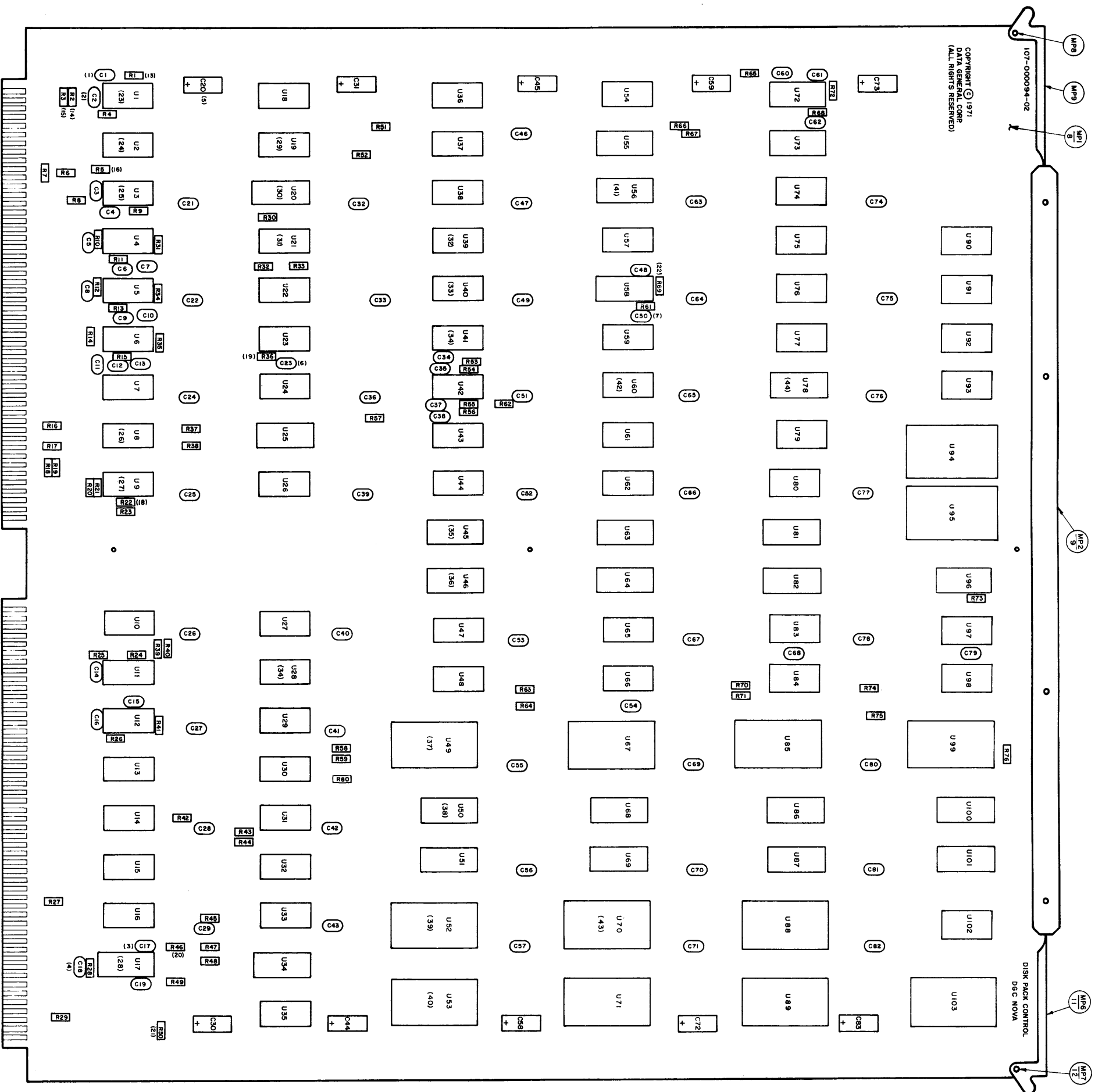
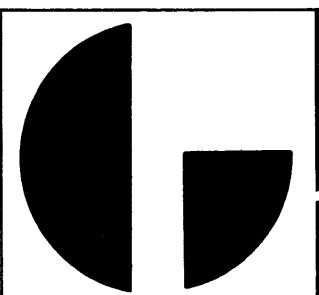

Figure 1-2. 4046 Disk Controller PCB Assembly



Data General Corporation (DGC) has prepared this manual for use by DGC personnel and customers as a guide to the proper installation, operation, and maintenance of DGC equipment and software. The drawings and specifications contained herein are the property of DGC and shall neither be reproduced in whole or in part without DGC's prior written approval nor be implied to grant any license to make, use, or sell equipment manufactured in accordance herewith.

Data General Corporation (DGC) has prepared this manual for use by DGC personnel and customers as a guide to the proper installation, operation, and maintenance of DGC equipment and software. The drawings and specifications contained herein are the property of DGC and shall neither be reproduced in whole or in part without DGC prior written approval nor be implied to grant any license to make, use, or sell equipment manufactured in accordance herewith.

Fig. & Index No.	Reference Designator	MFR Part No.	1	2	3	4	5	6	7	8	9	DESCRIPTION	Qty. Per Assy.	Qty. Per Unit
1-2	See Note Below	005-000472	.	.								DISK CONTROLLER PCB ASSEMBLY, Model 4046 (See First Figure of the PROCESSOR Group Assembly Parts Listing for NHA).		Qty Per Unit is Configuration Dependent See Figures 1-2 and 1-4 of this manual.
-1	C1, C3 thru C16, C34, C35, C37, C38, C48	DM-15-101J	.	.	.							CAPACITOR, 100pf, 500 VDC (0052).	20	
-2	C2	CD15ED330J	.	.	.							CAPACITOR, 33pf, 500 (0036).	1	
-3	C17, C19	DM-15-221J	.	.	.							CAPACITOR, 220pf, 500 VDC (0052).	2	

NOTE: Reference Designator for this particular optional assembly is unassigned. The Reference Designator relates to the Assembly slot (Multiple PCB Connector) wired for the Disk Controller, and the slot assignments for optional assemblies are customer specified. Therefore each customer must assign the Reference Designation for this option relative to the specified configuration.

Data General Corporation (DGC) has prepared this manual for use by DGC personnel and customers as a guide to the proper installation, operation, and maintenance of DGC equipment and software. The drawings and specifications contained herein are the property of DGC and shall neither be reproduced in whole or in part without DGC prior written approval nor be implied to grant any license to make, use, or sell equipment manufactured in accordance herewith.

Fig. & Index No.	Reference Designator	MFR Part No.	1	2	3	4	5	6	7	8	9	DESCRIPTION	Qty. Per Assy.	Qty. Per Unit
1-2 -4	Continued C18, C21, C22, C24 thru C29, C32, C33, C36, C39, thru C43, C46, C47, C49, C51 thru C57, C63 thru C71, C74 thru C82	Y5FO503M	CAPACITOR, .05 μ fd, 12VDC (0019).	45	
-5	C20, C30, C31, C44, C45, C58, C59, C72, C73, C83	D6R8B35K	CAPACITOR, 6.8 μ fd, 35VDC (0047).	10	
-6	C23, C61	DM-15-122J	CAPACITOR, 1200pf, 100 VDC (0052).	2	
-7	C50, C60, C62	CD15FD471J	CAPACITOR, 470pf, 500VDC (0036).	3	
-8	MP1	107-000094-01	PRINTED CIRCUIT BOARD DISK PACK CONTROL (0010).	1	
-9	MP2	002-000126	HANDLE, PCB(0010).	1	
-10	MP3, MP4 MP5	DELETED												

Data General Corporation (DGC) has prepared this manual for use by DGC personnel and customers as a guide to the proper installation, operation, and maintenance of DGC equipment and software. The drawings and specifications contained herein are the property of DGC and shall neither be reproduced in whole or in part without DGC prior written approval nor be implied to grant any license to make, use, or sell equipment manufactured in accordance herewith.

Fig. & Index No.	Reference Designator	MFR Part No.										Qty. Per Assy.	Qty. Per Unit
			1	2	3	4	5	6	7	8	9		
1-2	Continued												
-11	MP6, MP9	90-0-6503-11											
-12	MP7, MP8	90-0-5858-24											
*	MP10	002-000159											
-13	R1, R4, R8 thru R15, R24, R26, R31, R34, R35, R39, R41 thru R45, R47, R48, R52 thru R56, R58 thru R60, R63, R64, R70, R71, R73 thru R76	CB1025											
-15	R3, R7, R25, R30, R51	CB2715											
-16	R5, R6, R16 thru R19, R27, R28, R29, R32, R33, R37, R38, R57, R62, R65, R67	CB4715											

*RF SHIELD (Reference Designator MP10) not shown on this figure.

Data General Corporation (DGC) has prepared this manual for use by DGC personnel and customers as a guide to the proper installation, operation, and maintenance of DGC equipment and software. The drawings and specifications contained herein are the property of DGC and shall neither be reproduced in whole or in part without DGC prior written approval nor be implied to grant any license to make, use, or sell equipment manufactured in accordance herewith.

Fig. & Index No.	Reference Designator	MFR Part No.	1	2	3	4	5	6	7	8	9	DESCRIPTION	Qty. Per Assy.	Qty. Per Unit
1-2 -17	Continued R20, R21	CB3915	RESISTOR, 390Ω, 1/4W, 5% (0011).	2	
-18	R22, R23	CB3315	RESISTOR, 330Ω, 1/4W, 5% (0011).	2	
-19	R36, R61, R68, R72	CB1035	RESISTOR, 10K, 1/4W, 5% (0011).	4	
-20	R46, R49	CB6825	RESISTOR, 6.8K, 1/4W, 5% (0011).	2	
-21	R50, R66	CB1815	RESISTOR, 180Ω, 1/4W, 5% (0011).	2	
-22	R69	CB1235	RESISTOR, 12K, 1/4W, 5% (0011).	1	
-23	U1, U4, U5, U6, U12, U90	9003	INTEGRATED CIRCUIT PACKAGE, Three 3-Input NAND Gates(0013).	6	
		◇8879	INTEGRATED CIRCUIT PACKAGE, Three 3-Input NAND Gates(0014)		
-24	U2, U7, U10, U30 thru U33, U74, U80	8H90	INTEGRATED CIRCUIT PACKAGE, Hex Inverter (0014).	9	

Data General Corporation (DGC) has prepared this manual for use by DGC personnel and customers as a guide to the proper installation, operation, and maintenance of DGC equipment and software. The drawings and specifications contained herein are the property of DGC and shall neither be reproduced in whole or in part without DGC prior written approval nor be implied to grant any license to make, use, or sell equipment manufactured in accordance herewith.

Fig. & Index No.	Reference Designator	MFR Part No.	1	2	3	4	5	6	7	8	9	DESCRIPTION	Qty. Per Assy.	Qty. Per Unit
1-2 -25	Continued U3, U18, U24, U36, U57, U76, U79	9002	INTEGRATED CIRCUIT PACKAGE, Quad 2-Input Gates(0013).	7	
		◇8889	INTEGRATED CIRCUIT PACKAGE, Quad 2-Input Gates(0014)		
-26	U8, U91	9007	INTEGRATED CIRCUIT PACKAGE, Single 8-Input Gate(0013).	2	
-27	U9, U11, U13 thru U16, U23, U29	USN7438	INTEGRATED CIRCUIT PACKAGE, Quad 2-Input NAND Gates(0015).	8	
-28	U17, U58, U72	9602	INTEGRATED CIRCUIT PACKAGE, One Shot (0013).	3	
-29	U19, U22, U26, U27, U28, U37, U38, U43, U44, U54, U61, U62, U75, U102	7474	INTEGRATED CIRCUIT PACKAGE, D-Flop(0038).	14	
		◇8828	INTEGRATED CIRCUIT PACKAGE, D-Flop(0014)		

Data General Corporation (DGC) has prepared this manual for use by DGC personnel and customers as a guide to the proper installation, operation, and maintenance of DGC equipment and software. The drawings and specifications contained herein are the property of DGC and shall neither be reproduced in whole or in part without DGC prior written approval nor be implied to grant any license to make, use, or sell equipment manufactured in accordance herewith.

Fig. & Index No.	Reference Designator	MFR Part No.	1	2	3	4	5	6	7	8	9	DESCRIPTION	Qty. Per Assy.	Qty. Per Unit
1-2	Continued													
-30	U20, U25, U34, U55, U73	9015	INTEGRATED CIRCUIT PACKAGE, Triple 3-Input NOR Gates with One 4-Input NOR Gate(0013).	5	
-31	U21, U35, U42, U93	MC3001	INTEGRATED CIRCUIT PACKAGE, Quad 2-Input AND Gates(0026).	4	
-32	U39	9009	INTEGRATED CIRCUIT PACKAGE, Buffer(0013).	1	
		◇8859	INTEGRATED CIRCUIT PACKAGE, Buffer(0014)		
-33	U40	314A	INTEGRATED CIRCUIT PACKAGE, Single 7-Input NOR Gate(0014).	1	
-34	U41, U47, U48, U59, U65, U66, U77, U83, U84, U92, U97, U98	8281DC	INTEGRATED CIRCUIT PACKAGE, 4-Bit Binary Counter(0014).	12	
-35	U45	8266	INTEGRATED CIRCUIT PACKAGE, 2-Input, 4-Bit Digital Multiplexer(0014).	1	
-36	U46, U64, U82, U96	8267	INTEGRATED CIRCUIT PACKAGE, 2-Input, 4-Bit Digital Multiplexer, (Bare Collector)(0014).	4	

Data General Corporation (DGC) has prepared this manual for use by DGC personnel and customers as a guide to the proper installation, operation, and maintenance of DGC equipment and software. The drawings and specifications contained herein are the property of DGC and shall neither be reproduced in whole or in part without DGC prior written approval nor be implied to grant any license to make, use, or sell equipment manufactured in accordance herewith.

Fig. & Index No.	Reference Designator	MFR Part No.	1	2	3	4	5	6	7	8	9	DESCRIPTION	Qty. Per Assy.	Qty. Per Unit
1-2 -37	Continued U49, U67, U85, U99	8264	INTEGRATED CIRCUIT PACKAGE, 3-Input, 4 Bit Digital Multiplexer(0014).	4	
-38	U50, U51, U63, U68, U69, U81, U86, U87, U100, U101	9322	INTEGRATED CIRCUIT PACKAGE, Quad 2-Input Multiplexer(0013).	10	
-39	U52, U88, U94, U95	8202	INTEGRATED CIRCUIT PACKAGE, 10-Bit Buffer Register(0014).	4	
-40	U53, U71, U89, U103	74198	INTEGRATED CIRCUIT PACKAGE, 8 Bit, Parallel Access, Left-Shift, Right-Shift Register(0038).	4	
-41	U56	8271	INTEGRATED CIRCUIT PACKAGE, 4-Bit Shift Register(0014).	5	
-42	U60	MC3003	INTEGRATED CIRCUIT PACKAGE, Quad 2-Input OR Gate(0026).	1	
-43	U70	8200	INTEGRATED CIRCUIT PACKAGE, Dual 5-Bit Buffer Register(0014).	1	

Data General Corporation (DGC) has prepared this manual for use by DGC personnel and customers as a guide to the proper installation, operation, and maintenance of DGC equipment and software. The drawings and specifications contained herein are the property of DGC and shall neither be reproduced in whole or in part without DGC prior written approval nor be implied to grant any license to make, use, or sell equipment manufactured in accordance herewith.

Fig. & Index No.	Reference Designator	MFR Part No.	1 2 3 4 5 6 7 8 9 DESCRIPTION	Qty. Per Assy.	Qty. Per Unit
1-2 -44	Continued U78	9321 INTEGRATED CIRCUIT PACKAGE, Dual One of Four Decoders(0013). .	1	

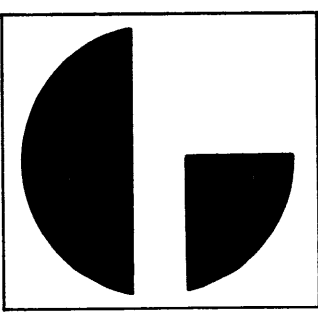
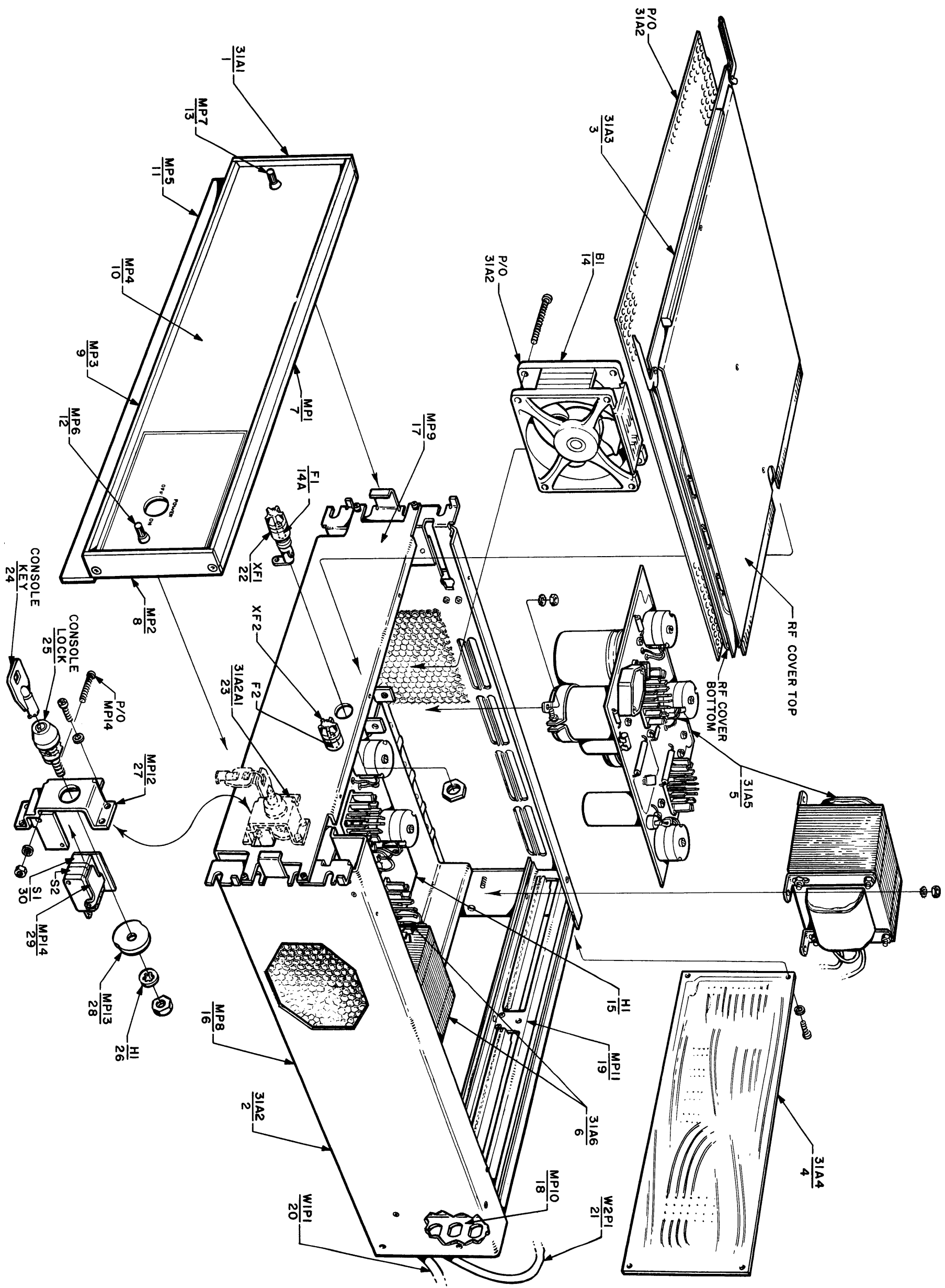

Data General Corporation (DGC) has prepared this manual for use by DGC personnel and customers as a guide to the proper installation, operation, and maintenance of DGC equipment and software. The drawings and specifications contained herein are the property of DGC and shall neither be reproduced in whole or in part without DGC's prior written approval nor be implied to grant any license to make, use, or sell equipment manufactured in accordance herewith.

Figure 1-3. Disk Adapter Unit Type 4047 or 4049
1-17/1-18

Data General Corporation (DGC) has prepared this manual for use by DGC personnel and customers as a guide to the proper installation, operation, and maintenance of DGC equipment and software. The drawings and specifications contained herein are the property of DGC and shall neither be reproduced in whole or in part without DGC prior written approval nor be implied to grant any license to make, use, or sell equipment manufactured in accordance herewith.

Fig. & Index No.	Reference Designator	MFR Part No.	1	2	3	4	5	6	7	8	9	DESCRIPTION	Qty. Per Assy.	Qty. Per Unit
1-3	31	005-000586	DISK CARTRIDGE ADAPTER UNIT, Model 4047		
		OR										OR		
		005-000605	DISK CARTRIDGE ADAPTER UNIT, Model 4049*		
-1	31A1	005-000599-00	DISK ADAPTER CONSOLE ASSEMBLY(See Figure 1-3 for detailed breakdown).		1
-2	31A2	005-000817-00	DISK ADAPTER ENCLOSURE ASSEMBLY(See Figure 1-3 for detailed breakdown).		1
-3	31A3	005-000587-00	DISK ADAPTER LOGIC INTERFACE PCB ASSEMBLY (See Figure 1-4 for detailed breakdown).		1
-4	31A4	005-000600-00	DISK ADAPTER BACK PANEL PCB ASSEMBLY (See Figure 1-5 for detailed breakdown).		1
-5	31A5	005-000588-00	DISK ADAPTER POWER SUPPLY ASSEMBLY(See Figure 1-6 for detailed breakdown).		1
-6	31A6	005-000588-00	DISK ADAPTER POWER SUPPLY ASSEMBLY. 4049 ADAPTER OPTION ONLY (See Figure 1-6 for detailed breakdown).		1

*Model 4049 differs from Model 4047 only in that Model 4049 contains two identical Power Supply Assemblies (DGC#005-000588). The optional supply is referenced in the Figure by designator callout 31A.

Data General Corporation (DGC) has prepared this manual for use by DGC personnel and customers as a guide to the proper installation, operation, and maintenance of DGC equipment and software. The drawings and specifications contained herein are the property of DGC and shall neither be reproduced in whole or in part without DGC prior written approval nor be implied to grant any license to make, use, or sell equipment manufactured in accordance herewith.

Fig. & Index No.	Reference Designator	MFR Part No.	1	2	3	4	5	6	7	8	9	DESCRIPTION	Qty. Per Assy.	Qty. Per Unit
1-3 **	Continued **	002-000177-02	CHASSIS GUIDE ASSEMBLY (With 4 mounting screws 10/32 X 3/8 Phillips Pan Head and 4 mounting nuts 10/32)(0010).	.	1
**	**	005-000468-00	CABLE ASSEMBLY, COM- PUTER TO ADAPTER(0010).	.	1
	31A1	005-000599-00	DISK ADAPTER CONSOLE ASSEMBLY(See Figure 1-3-1 for NHA).	.	REF
-7	MP1	002-000187	RAIL, HORIZONTAL, FRAME, TOP(0010).	1	
-8	MP2	002-000474	RAIL, VERTICAL, FRAME, (0010).	1	
-9	MP3	002-000475	RAIL, HORIZONTAL, FRAME, BOTTOM(0010).	1	
-10	MP4	002-000472	FRONT PANEL, TOP (0010).	1	
-11	MP5	002-000473	FRONT PANEL, BOTTOM (0010).	1	
-12	MP6	123-000010	FASTENER, PAWL, RIGHT (0010).	1	
-13	MP7	123-000011	FASTENER, PAWL, LEFT (0010).	1	

**CHASSIS GUIDE & CABLE ASSEMBLIES not shown in Group Assemblies Parts List, are shipped with each Disk Adapter Unit for attachment when the Unit is installed.

Data General Corporation (DGC) has prepared this manual for use by DGC personnel and customers as a guide to the proper installation, operation, and maintenance of DGC equipment and software. The drawings and specifications contained herein are the property of DGC and shall neither be reproduced in whole or in part without DGC prior written approval nor be implied to grant any license to make, use, or sell equipment manufactured in accordance herewith.

Fig. & Index No.	Reference Designator	MFR Part No.	1	2	3	4	5	6	7	8	9	DESCRIPTION	Qty. Per Assy.	Qty. Per Unit
1-3	Continued 31A2	005-000817-00	DISK ADAPTER ENCLOSURE ASSEMBLY(See Figure 1-3-2 for NHA).	.	REF
-14	B1	M747	FAN, AXIAL(0063).	1	
-14a	F1, F2	ABC10	FUSE, 10 Amperes(0060).	2	
-15	H1	123-000023	TERMINAL BLOCK(0010).	1	
-16	MP8	002-000341	FRAME, CONTROL (Weldment)(0010).	1	
-17	MP9	002-000386	BAY, POWER SUPPLY (0010).	1	
-18	MP10	002-000480	BRACKET, AC/DC POWER (0010).	1	
-19	MP11	002-000366	FRAME, PCB SUPPORT (0010).	1	
-20	W1P1	17405BSJT	ELECTRICAL POWER CABLE W/Male Plug Connector(0021).	1	
-21	W2P1 thru W5P1***	118-000099	DISK DRIVE DC POWER CABLE(0010).	***	
-22	XF1, XF2	HKP	FUSE HOLDER(0060).	2	

***Number of DC Power Cables depends on number of Disk Drives energized by the Adapter and whether the Adapter unit is a 4047 or a 4049. A 4047 Adapter will have a maximum of two Cables, whereas a 4049 Adapter will have a maximum of four Cables.

Data General Corporation (DGC) has prepared this manual for use by DGC personnel and customers as a guide to the proper installation, operation, and maintenance of DGC equipment and software. The drawings and specifications contained herein are the property of DGC and shall neither be reproduced in whole or in part without DGC prior written approval nor be implied to grant any license to make, use, or sell equipment manufactured in accordance herewith.

Fig. & Index No.	Reference Designator	MFR Part No.	1	2	3	4	5	6	7	8	9	DESCRIPTION	Qty. Per Assy.	Qty. Per Unit
1-3 -23	Continued 31A2A1	005-000427	LOCK SWITCH SUBASSEMBLY(0010).	1	
-24	Console Key	122-000002	CONSOLE KEY(0051).	2	
-25	Console Lock	122-000001	CONSOLE LOCK(0051).	1	
-26	H1	002-000234	WASHER, Lock switch (0010).	1	
-27	MP12	002-000231	BRACKET, Lock switch (0010).	1	
-28	MP13	002-000233	CAM, Lock switch(0010).	1	
-29	MP14	JV-91	ACTUATOR Kit, Micro-switch(0017).	1	
-30	S1, S2	J323D8	SWITCH, Micro(0017).	2	

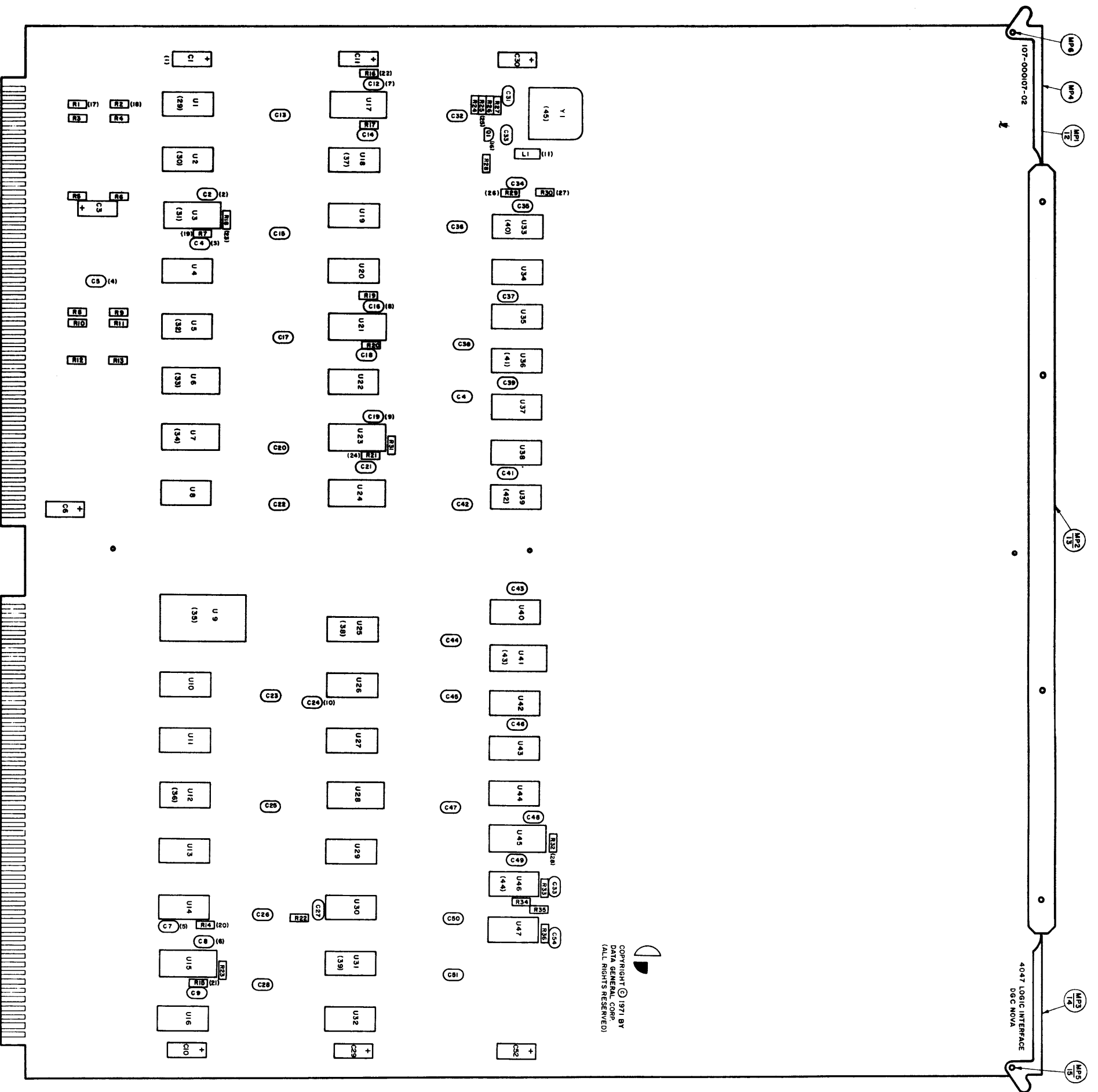

Data General Corporation (DGC) has prepared this manual for use by DGC personnel and customers as a guide to the proper installation, operation, and maintenance of DGC equipment and software. The drawings and specifications contained herein are the property of DGC and shall neither be reproduced in whole or in part without DGC's prior written approval nor be implied to grant any license to make, use, or sell equipment manufactured in accordance herewith.

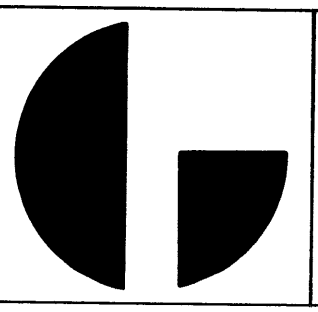

Figure 1-4. Logic Interface PCB Assembly for the 4047 or 4049 Disk Adapter Unit

Data General Corporation (DGC) has prepared this manual for use by DGC personnel and customers as a guide to the proper installation, operation, and maintenance of DGC equipment and software. The drawings and specifications contained herein are the property of DGC and shall neither be reproduced in whole or in part without DGC prior written approval nor be implied to grant any license to make, use, or sell equipment manufactured in accordance herewith.

Fig. & Index No.	Reference Designator	MFR Part No.										Qty. Per Assy.	Qty. Per Unit		
			1	2	3	4	5	6	7	8	9			DESCRIPTION	
1-4	31A3	005-000587-00	DISK ADAPTER LOGIC INTERFACE PCB ASSEMBLY(See Figure 1-3-3 for NHA).	1	REF
-1	C1, C3, C6, C10, C11, C29, C30, C52	D6R8B35K	CAPACITOR, 6.8 μ fd, 35VDC (0047).	8	
-2	C2	CD15FD471J	CAPACITOR, 470pf, 500VDC(0036).	1	
-3	C4, C14, C18, C48, C53, C54	8121-100-W5RO-682K	CAPACITOR, 680pf, 100VDC(0019).	6	
-4	C5, C13, C15, C17, C20, C22, C23, C25, C26, C28, C32, C34 thru C47, C49 thru C51	Y5FO503M	CAPACITOR, .05 μ fd, 12VDC (0019).	28	
-5	C7, C27	CD15ED330J	CAPACITOR, 33pf, 500VDC (0036).	2	
-6	C8, C9	DM-15-820J	CAPACITOR, 82pf, 500VDC (0052).	2	
-7	C12	DM-15-122J	CAPACITOR, 1200pf, 100VDC(0052).	1	

Data General Corporation (DGC) has prepared this manual for use by DGC personnel and customers as a guide to the proper installation, operation, and maintenance of DGC equipment and software. The drawings and specifications contained herein are the property of DGC and shall neither be reproduced in whole or in part without DGC prior written approval nor be implied to grant any license to make, use, or sell equipment manufactured in accordance herewith.

Fig. & Index No.	Reference Designator	MFR Part No.										Qty. Per Assy.	Qty. Per Unit				
			1	2	3	4	5	6	7	8	9			DESCRIPTION			
1-4 -8	Continued C16	DM-15-331-J	CAPACITOR, 330pf, 500VDC (0052).	1	
-9	C19, C21, C31, C33	DM-15-101J	CAPACITOR, 100pf, 500VDC (0052).	4	
-10	C24	Y5U0103Z	CAPACITOR, .01 μ fd, 50VDC (0019).	1	
-11	L1	07-4100-3000	COIL, RADIO FREQUENCY, 100 μ Henries(0066).	1	
-12	MP1	107-000107-02	PRINTED CIRCUIT BOARD 4047 LOGIC INTERFACE (0010).	1	
-13	MP2	002-000126	HANDLE, PCB(0010).	1	
-14	MP3 MP4	90-0-6503-11	INJECTOR(0048).	2	
-15	MP5, MP6	90-0-5858-24	RIVET(0048).	2	
*	*	002-000159	SHIELD, RF, TOP(0010).	1	
*	*	002-000443	SHIELD, RF, BOTTOM (0010).	1	

*RF SHIELDS, Top and Bottom not shown on this Figure.
See Figure 6-3 for location of Shields on PC Board.

Data General Corporation (DGC) has prepared this manual for use by DGC personnel and customers as a guide to the proper installation, operation, and maintenance of DGC equipment and software. The drawings and specifications contained herein are the property of DGC and shall neither be reproduced in whole or in part without DGC prior written approval nor be implied to grant any license to make, use, or sell equipment manufactured in accordance herewith.

Fig. & Index No.	Reference Designator	MFR Part No.	1	2	3	4	5	6	7	8	9	DESCRIPTION	Qty. Per Assy.	Qty. Per Unit
1-4	Continued													
-16	Q1	MPS3640	TRANSISTOR(0026).	1	
-17	R1, R3, R5, R8, R10, R12, R24	CB2215	RESISTOR, 220Ω, 1/4W, 5% (0011).	7	
-18	R2, R4, R6, R9, R11, R13	CB2715	RESISTOR, 270Ω, 1/4W, 5% (0011).	6	
-19	R7, R31	CB2735	RESISTOR, 27K, 1/4W, 5% (0011).	2	
-20	R14, R22, R33 thru R36	CB1025	RESISTOR, 1K, 1/4W, 5% (0011).	6	
-21	R15, R23	CB5625	RESISTOR, 5.6K, 1/4W, 5% (0011).	2	
-22	R16, R17, R20	CB3335	RESISTOR, 33K, 1/4W, 5% (0011).	3	
-23	R18, R19	CB1035	RESISTOR, 10K, 1/4W, 5% (0011).	2	
-24	R21	CB1235	RESISTOR, 12K, 1/4W, 5% (0011).	1	
-25	R25 thru R28	CB3915	RESISTOR, 390Ω, 1/4W, 5% (0011).	4	
-26	R29	CB4715	RESISTOR, 470Ω, 1/4W, 5% (0011).	1	

Data General Corporation (DGC) has prepared this manual for use by DGC personnel and customers as a guide to the proper installation, operation, and maintenance of DGC equipment and software. The drawings and specifications contained herein are the property of DGC and shall neither be reproduced in whole or in part without DGC prior written approval nor be implied to grant any license to make, use, or sell equipment manufactured in accordance herewith.

Fig. & Index No.	Reference Designator	MFR Part No.	1	2	3	4	5	6	7	8	9	DESCRIPTION	Qty. Per Assy.	Qty. Per Unit
1-4 -27	Continued R30	CB1815	RESISTOR, 180-, 1/4W, 5% (0011).	1	
-28	R32	CB5635	RESISTOR, 56K, 1/4W, 5% (0011).	1	
-29	U1, U16, U20, U22, U26, U29, U32, U34, U42, U44, U47	7474	INTEGRATED CIRCUIT PACKAGE, D-Flop(0038).	1	
		◇8828	INTEGRATED CIRCUIT PACKAGE, D-Flop(0014)		
-30	U2, U4, U8, U10, U35	9016	INTEGRATED CIRCUIT PACKAGE, Hex Inverter (0013).	5	
		◇8H90	INTEGRATED CIRCUIT PACKAGE, (0014)		
-31	U3, U15, U17, U21, U23, U45	9602	INTEGRATED CIRCUIT PACKAGE, One Shot(0013)	6	
-32	U5, U11, U13, U30, U37	9002	INTEGRATED CIRCUIT PACKAGE, Quad 2-Input Gates(0013).	5	
		◇8889	INTEGRATED CIRCUIT PACKAGE, Quad 2-Input Gates(0014)		

Data General Corporation (DGC) has prepared this manual for use by DGC personnel and customers as a guide to the proper installation, operation, and maintenance of DGC equipment and software. The drawings and specifications contained herein are the property of DGC and shall neither be reproduced in whole or in part without DGC prior written approval nor be implied to grant any license to make, use, or sell equipment manufactured in accordance herewith.

Fig. & Index No.	Reference Designator	MFR Part No.										Qty. Per Assy.	Qty. Per Unit			
			1	2	3	4	5	6	7	8	9			DESCRIPTION		
1-4 -33	Continued U6, U24, U28	9015	INTEGRATED CIRCUIT PACKAGE, Triple 2-Input NOR Gates with One 4-Input NOR Gates(0013).	3	
-34	U7	9321	INTEGRATED CIRCUIT PACKAGE, Dual One of Four Decoder(0013).	1	
-35	U9	8202	INTEGRATED CIRCUIT PACKAGE, 10-Bit Buffer Register(0014).	1	
-36	U12, U14, U19, U43	MC3001	INTEGRATED CIRCUIT PACKAGE, Quad 2-Input AND Gates(0026).	4	
-37	U18, U27	MC3003	INTEGRATED CIRCUIT PACKAGE, Quad 2-Input OR Gates(0026).	2	
-38	U25, U40	7486	INTEGRATED CIRCUIT PACKAGE, Quad 2-Input Exclusive-OR Gates(0038).	2	
-39	U31, U39	9008	INTEGRATED CIRCUIT PACKAGE, Single 4-Wide AND-OR-Invert Gates (0013).	2	
		◇8848	INTEGRATED CIRCUIT PACKAGE, Single 4-Wide AND-OR-Invert Gates (0014)		
-40	U33	MC3061	INTEGRATED CIRCUIT PACKAGE, Dual J-K Flip-Flop(0026).	1	

Data General Corporation (DGC) has prepared this manual for use by DGC personnel and customers as a guide to the proper installation, operation, and maintenance of DGC equipment and software. The drawings and specifications contained herein are the property of DGC and shall neither be reproduced in whole or in part without DGC prior written approval nor be implied to grant any license to make, use, or sell equipment manufactured in accordance herewith.

Fig. & Index No.	Reference Designator	MFR Part No.	1	2	3	4	5	6	7	8	9	DESCRIPTION	Qty. Per Assy.	Qty. Per Unit
1-4 -41	Continued U36	8281	INTEGRATED CIRCUIT PACKAGE, 4-Bit Binary Counter(0014).	1	
-42	U38	9004	INTEGRATED CIRCUIT PACKAGE, Dual 4-Input Gates(0013).	1	
		◇8819	INTEGRATED CIRCUIT PACKAGE, Dual 4-Input Gates(0014)		
-43	U41	9328	INTEGRATED CIRCUIT PACKAGE, Dual 8 Bit Shift Register(0013).	1	
-44	U46	USN7438	INTEGRATED CIRCUIT PACKAGE, Quad 2-Input NAND(OC) Gates(0015).	1	
-45	Y1	No Number	CRYSTAL, 11.500MHz(0037)	1	

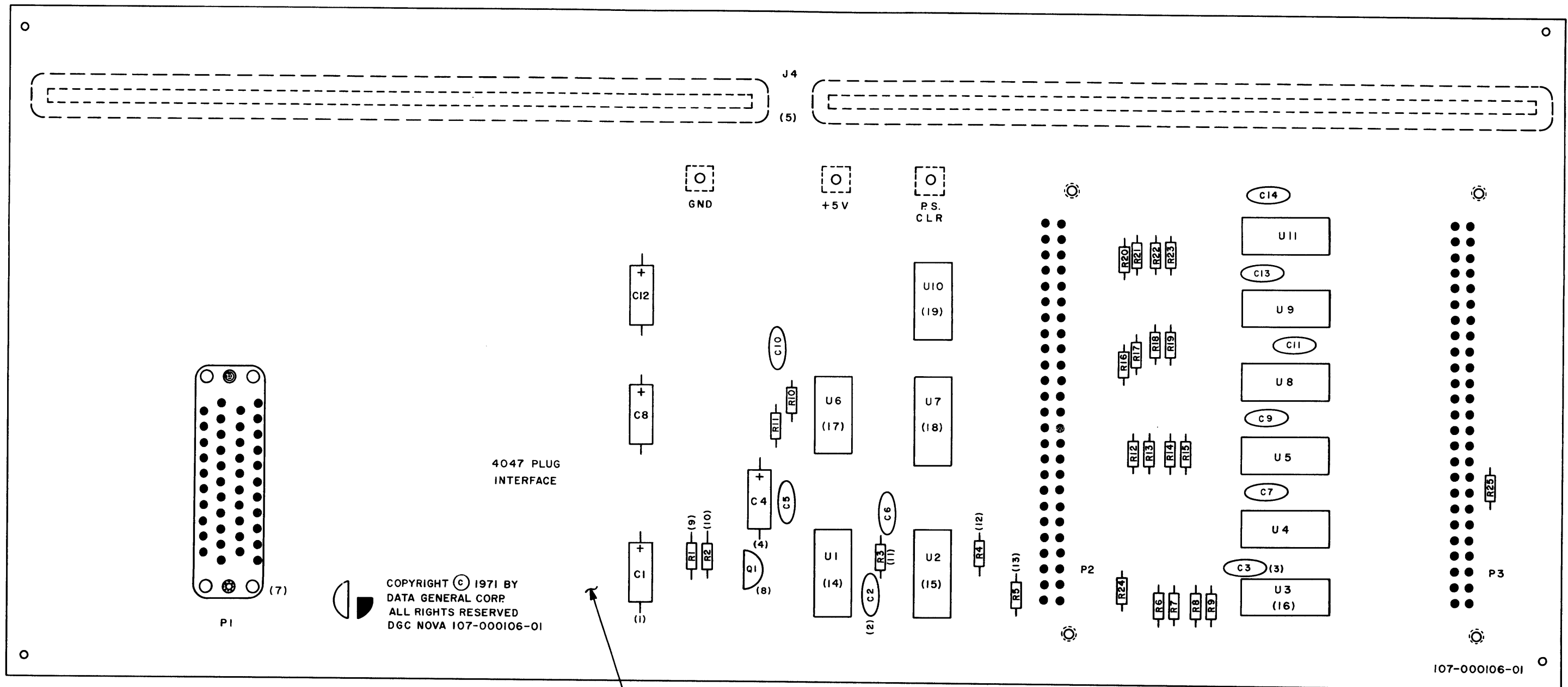

	<p>Data General Corporation (DGC) has prepared this manual for use by DGC personnel and customers as a guide to the proper installation, operation, and maintenance of DGC equipment and software. The drawings and specifications contained herein are the property of DGC and shall neither be reproduced in whole or in part without DGC's prior written approval nor be implied to grant any license to make, use, or sell equipment manufactured in accordance herewith.</p>
--	---

Figure 1-5. Back Panel PCB Assembly for the 4047 or 4049 Disk Adapter Unit

Data General Corporation (DGC) has prepared this manual for use by DGC personnel and customers as a guide to the proper installation, operation, and maintenance of DGC equipment and software. The drawings and specifications contained herein are the property of DGC and shall neither be reproduced in whole or in part without DGC prior written approval nor be implied to grant any license to make, use, or sell equipment manufactured in accordance herewith.

Fig. & Index No.	Reference Designator	MFR Part No.										Qty. Per Assy.	Qty. Per Unit		
			1	2	3	4	5	6	7	8	9			DESCRIPTION	
1-5	31A4	005-000600-00	DISK ADAPTER BACK PANEL PCB ASSEMBLY (See Figure 1-3-4 for NHA).	REF
-1	C1, C8, C12	D6R8B35K	CAPACITOR, 6.8 μ fd, 35VDC (0047).	3
-2	C2	DM-15-471J	CAPACITOR, 470pf, 500VDC (0052).	1
-3	C3, C5, C6, C7, C9, C10, C11, C13, C14	Y5FO503M	CAPACITOR, .05 μ fd, 12VDC (0019).	9
-4	C4	D47B6K	CAPACITOR, 47 μ fd, 6VDC (0047).	1
-5	J4	HW50D2-111	CONNECTOR, PRINTED CIRCUIT, EDGE, 50 CONTACT(0070).	2
-6	MP1	107-000106-01	PRINTED CIRCUIT BOARD, 4047 PLUG INTERFACE (0010).	1
-7	P1	MRAC 42PJ	CONNECTOR, 42 PIN, Male (0070).	1
-8	Q1	MPS3646	TRANSISTOR(0026).	1
-9	R1	CB4735	RESISTOR, 47K, 1/4W, 5% (0011).	1
-10	R2	CB4745	RESISTOR, 470K, 1/4W, 5% (0011).	1
-11	R3	CB1035	RESISTOR, 10K, 1/4W, 5% (0011).	1

Data General Corporation (DGC) has prepared this manual for use by DGC personnel and customers as a guide to the proper installation, operation, and maintenance of DGC equipment and software. The drawings and specifications contained herein are the property of DGC and shall neither be reproduced in whole or in part without DGC prior written approval nor be implied to grant any license to make, use, or sell equipment manufactured in accordance herewith.

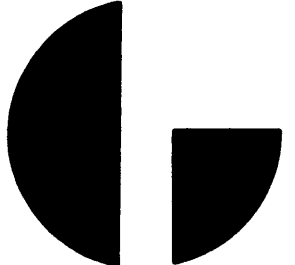
Fig. & Index No.	Reference Designator	MFR Part No.										DESCRIPTION	Qty. Per Assy.	Qty. Per Unit	
			1	2	3	4	5	6	7	8	9				
1-5 -12	Continued R4, R8, R9, R10, R14, R15, R18, R19, R22, R23,	CB2215	RESISTOR, 220Ω, 1/4W, 5% (0011).	10	
-13	R5 thru R7, R11 thru R13, R16, R17, R20, R21, R24, R25	CB2715	RESISTOR, 270Ω, 1/4W, 5% (0011).	12	
-14	U1	9602	INTEGRATED CIRCUIT PACKAGE, One Shot(0013).	1	
-15	U2	8271	INTEGRATED CIRCUIT PACKAGE, 4-Bit Shift Register(0014).	1	
-16	U3, U4, U5, U8, U9, U11	9322	INTEGRATED CIRCUIT PACKAGE, Quad 2-Input Digital Multiplexer(0013).	6	
-17	U6	7474	INTEGRATED CIRCUIT PACKAGE, D-Flop(0038)		
		◇8828	INTEGRATED CIRCUIT PACKAGE, D-Flop(0014)		
-18	U7	9015	INTEGRATED CIRCUIT PACKAGE, Triple 2-Input NOR Gates, With One 4- Input NOR Gate(0013).	1	

Data General Corporation (DGC) has prepared this manual for use by DGC personnel and customers as a guide to the proper installation, operation, and maintenance of DGC equipment and software. The drawings and specifications contained herein are the property of DGC and shall neither be reproduced in whole or in part without DGC prior written approval nor be implied to grant any license to make, use, or sell equipment manufactured in accordance herewith.

Fig. & Index No.	Reference Designator	MFR Part No.	1 2 3 4 5 6 7 8 9 DESCRIPTION	Qty. Per Assy.	Qty. Per Unit
1-5 -19	Continued U10 9002 ◇8889 INTEGRATED CIRCUIT PACKAGE, Quad 2-Input Gates(0013). INTEGRATED CIRCUIT PACKAGE, Quad 2-Input Gates(0014)	1	

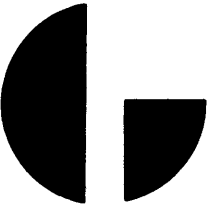
 Data General Corporation (DGC) has prepared this manual for use by DGC personnel and customers as a guide to the proper installation, operation, and maintenance of DGC equipment and software. The drawings and specifications contained herein are the property of DGC and shall neither be reproduced in whole or in part without DGC's prior written approval nor be implied to grant any license to make, use, or sell equipment manufactured in accordance herewith.

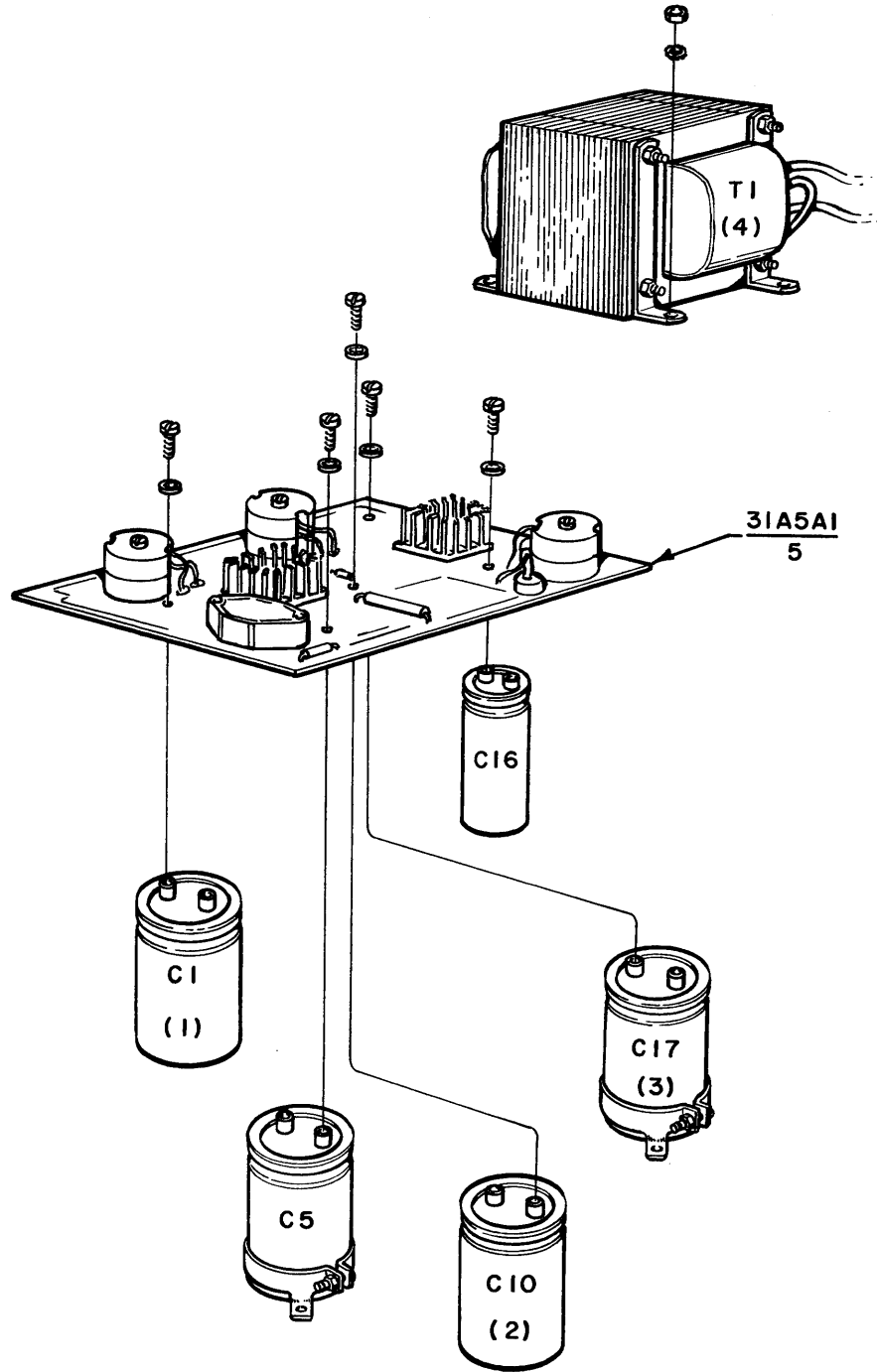
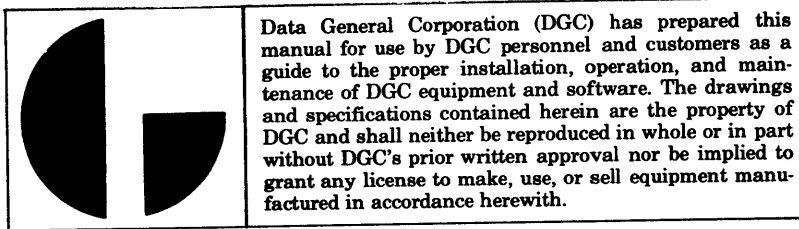

Figure 1-6. Power Supply Assembly for the 4047 or 4049 Disk Adapter Unit

Data General Corporation (DGC) has prepared this manual for use by DGC personnel and customers as a guide to the proper installation, operation, and maintenance of DGC equipment and software. The drawings and specifications contained herein are the property of DGC and shall neither be reproduced in whole or in part without DGC prior written approval nor be implied to grant any license to make, use, or sell equipment manufactured in accordance herewith.

Fig. & Index No.	Reference Designator	MFR Part No.	1 2 3 4 5 6 7 8 9 DESCRIPTION	Qty. Per Assy.	Qty. Per Unit	
1-6	31A5	005-000588-00	. . . DISK ADAPTER POWER SUPPLY ASSEMBLY(See Figure 1-3-5 and/or 1-3-6 for NHA).	. .	REF	
-1	C1, C5	DCM243U040C-B2B	. . . CAPACITOR, 2400 μ fd, 40 VDC(0056).	2		
-2	C10, C17	103-000049-00	. . . CAPACITOR, 38000 μ fd, 20VDC(0059).	2		
	C11	NOT USED ON THIS ASSEMBLY				
-3	C16	DCM203U010-AB2B	. . . CAPACITOR, 15000 μ fd, 10VDC(0056).	1		
-4	T1	104-000017-03	. . . TRANSFORMER, LOW VOLTAGE, POWER(0010).	1		
-5	31A5A1	005-000597-02	. . . POWER SUPPLY PCB SUB-ASSEMBLY(See Figure (1-7 for Detailed Break-down).	1		



This Page

Left Blank

Intentionally

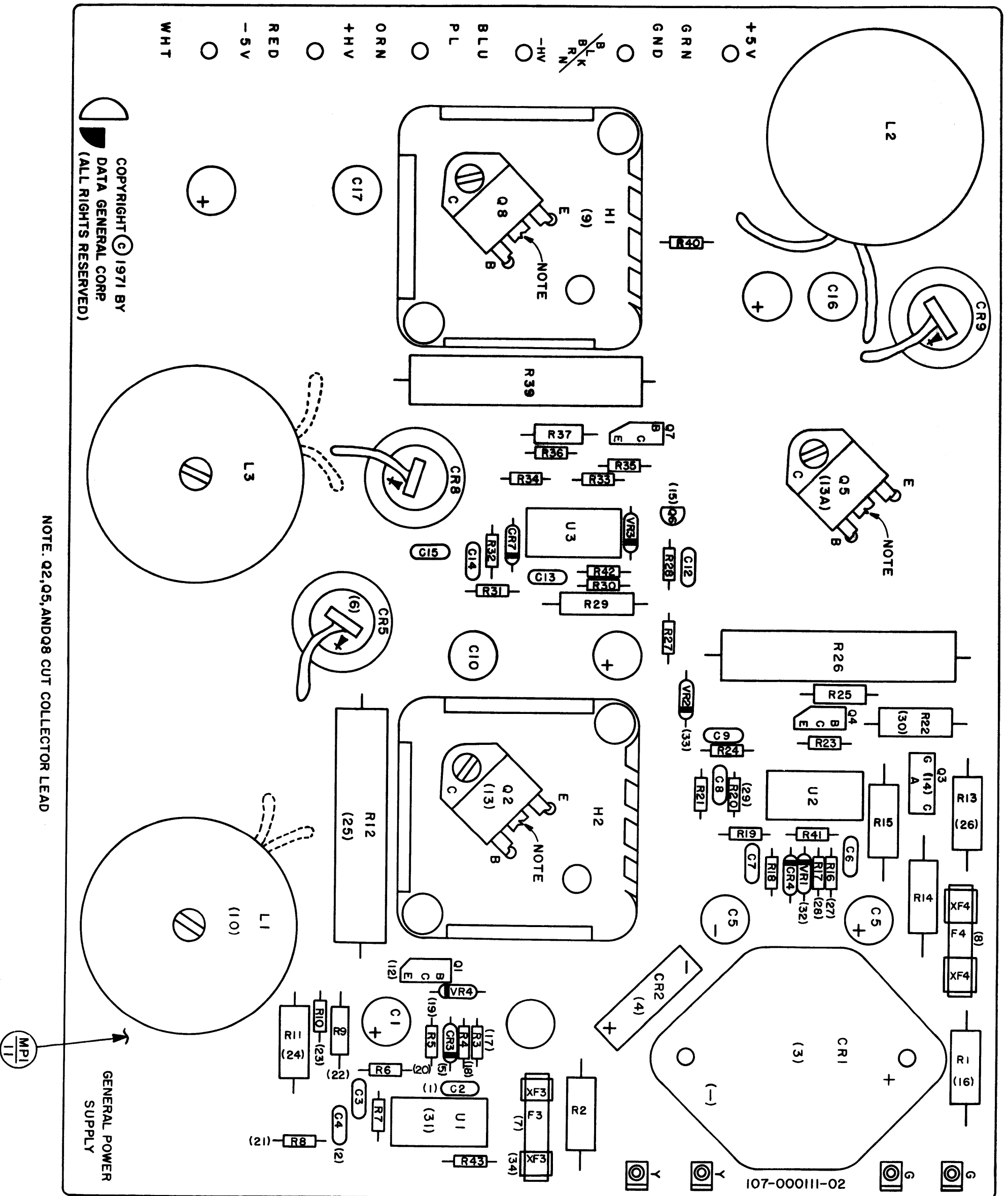

COPYRIGHT © 1971 BY
DATA GENERAL CORP
(ALL RIGHTS RESERVED)

NOTE: Q2, Q5, AND Q8 CUT COLLECTOR LEAD

Data General Corporation (DGC) has prepared this manual for use by DGC personnel and customers as a guide to the proper installation, operation, and maintenance of DGC equipment and software. The drawings and specifications contained herein are the property of DGC and shall neither be reproduced in whole or in part without DGC's prior written approval nor be implied to grant any license to make, use, or sell equipment manufactured in accordance herewith.

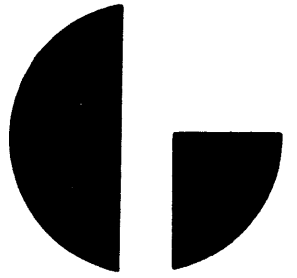

Figure 1-7. Type 4047 Power Supply PCB Subassembly

Data General Corporation (DGC) has prepared this manual for use by DGC personnel and customers as a guide to the proper installation, operation, and maintenance of DGC equipment and software. The drawings and specifications contained herein are the property of DGC and shall neither be reproduced in whole or in part without DGC prior written approval nor be implied to grant any license to make, use, or sell equipment manufactured in accordance herewith.

Fig. & Index No.	Reference Designator	MFR Part No.										Qty. Per Assy.	Qty. Per Unit	
			1	2	3	4	5	6	7	8	9			DESCRIPTION
1-7	31A5A1	005-000597-00	.	.	.	POWER SUPPLY PCB SUB-ASSEMBLY(See Figure 1-6-5 for NHA).						.	REF	
-1	C2, C3, C6, C7, C8, C12, C14, C15	Y5FO503M	CAPACITOR, .05 μ fd, 12VDC(0019).						8	
-2	C4, C9, C13	DM-15-820J	CAPACITOR, 68pf, 500 VDC(0052).						3	
-3	CR1	MDA 962A-1	DIODE(0026).						1	
-4	CR2	MDA 970-1	DIODE(0026).						1	
-5	CR3, CR4, CR7	CD81148	DIODE(0034).						3	
-6	CR5, CR8, CR9	IN3899R	DIODE(0026).						3	
-7	F3	AGC4	FUSE, 4 Amperes(0060).						1	
-8	F4	ABC10	FUSE, 10 Amperes(0060).						1	
-9	H1, H2	123-000038	HEAT SINK(0010).						2	
-10	L1, L2, L3	005-000800	CHOKE COIL(0010).						3	
-11	MP1	107-000111-00	PRINTED CIRCUIT BOARD GENERAL POWER SUPPLY(0010).						1	

Data General Corporation (DGC) has prepared this manual for use by DGC personnel and customers as a guide to the proper installation, operation, and maintenance of DGC equipment and software. The drawings and specifications contained herein are the property of DGC and shall neither be reproduced in whole or in part without DGC prior written approval nor be implied to grant any license to make, use, or sell equipment manufactured in accordance herewith.

Fig. & Index No.	Reference Designator	MFR Part No.										Qty. Per Assy.	Qty. Per Unit
			1	2	3	4	5	6	7	8	9		
1-7	Continued		
-12	Q1, Q4, Q7	D43C5	3	
-13	Q2, Q8	2N4399	2	
-13a	Q5	TIP36	1	
-14	Q3	2N4441	1	
-15	Q6	2N4400	1	
-16	R1, R2	EL21-600Ω	2	
-17	R3, R19, R21, R27, R32, R40	CB1025	6	
-18	R4, R18, R28, R30	CB1035	4	
-19	R5, R24, R36	CB2245	3	
-20	R6, R7, R33, R34	CB2715	4	
-21	R8, R31	CB3015	2	
-22	R9, R25 R37	EB1005	3	

Data General Corporation (DGC) has prepared this manual for use by DGC personnel and customers as a guide to the proper installation, operation, and maintenance of DGC equipment and software. The drawings and specifications contained herein are the property of DGC and shall neither be reproduced in whole or in part without DGC prior written approval nor be implied to grant any license to make, use, or sell equipment manufactured in accordance herewith.

Fig. & Index No.	Reference Designator	MFR Part No.										Qty. Per Assy.	Qty. Per Unit		
			1	2	3	4	5	6	7	8	9			DESCRIPTION	
1-7	Continued														
-23	R10, R23, R35	CB3915											RESISTOR, 390Ω, 1/4W, 5%(0011).	3	
-24	R11, R29	GB1815											RESISTOR, 180Ω, 1W, 5%(0011).	2	
-25	R12, R26, R39	EL10A-.2Ω											RESISTOR, 0.2Ω, 10W, 5%(0061).	3	
-26	R13 thru R15	EL2-1.5Ω											RESISTOR, 1.5Ω, 3W, 5%(0061).	3	
-27	R16, R41, R42, R43	CB1015											RESISTOR, 100Ω, 1/4W, 5%(0011).	4	
-28	R17	CB1005											RESISTOR, 10Ω, 1/4W, 5%(0011).	1	
-29	R20	CB2725											RESISTOR, 2.7K, 1/4W, 5%(0011).	1	
-30	R22	GB2715											RESISTOR, 270Ω, 1W, 5%(0011).	1	
-31	U1, U2, U3	μA723											INTEGRATED CIRCUIT PACKAGE, Precision Voltage Regulator(0013).	3	
-32	VR1, VR3, VR4	1N5234B											DIODE, BREAKDOWN (0026).	3	

Data General Corporation (DGC) has prepared this manual for use by DGC personnel and customers as a guide to the proper installation, operation, and maintenance of DGC equipment and software. The drawings and specifications contained herein are the property of DGC and shall neither be reproduced in whole or in part without DGC prior written approval nor be implied to grant any license to make, use, or sell equipment manufactured in accordance herewith.

Fig. & Index No.	Reference Designator	MFR Part No.										Qty. Per Assy.	Qty. Per Unit				
			1	2	3	4	5	6	7	8	9			DESCRIPTION			
1-7 -33	Continued VR2	1N5252	DIODE, BREAKDOWN (0026).	1	
-34	XF3, XF4	5680-05	CLIP, FUSE HOLDER (0060).	4	