

CHAPTER 5

TROUBLESHOOTING

5.1 An Introduction to Troubleshooting	5- 1
5.2 Test Program	5- 1
5.3 Check-out Procedure	5-15
5.4 Unit Troubleshooting	5-19

5.1 An Introduction to Troubleshooting

Troubleshooting is usually too easy; varied symptoms appear depending on points of failure. This section describes two procedures which may allow easier troubleshooting and subsequent repair:

1. Check-out procedure

Objective: To guide the user through a problem isolation process when symptoms do not indicate a specific component malfunction.

Fault isolation level: Repair by unit replacement, repair can be accomplished with a basic knowledge of computer hardware.

2. Unit repair flowchart

Objective: To guide the user through a component level repair process.

Allow a component-level repair of an individual faulty unit.

Fault isolation level: Component level – Requires an advanced knowledge of computer hardware engineering, and electronics.

General troubleshooting procedure

- First, isolate and replace the faulty unit according to the check-out procedure faulty each time a unit is replaced, to make sure the new unit is not faulty. This process will prevent confusion with a problem caused by poor connector contacts.
- Second, isolate and replace the faulty component in the unit according to the appropriate unit flowchart or the trouble table.

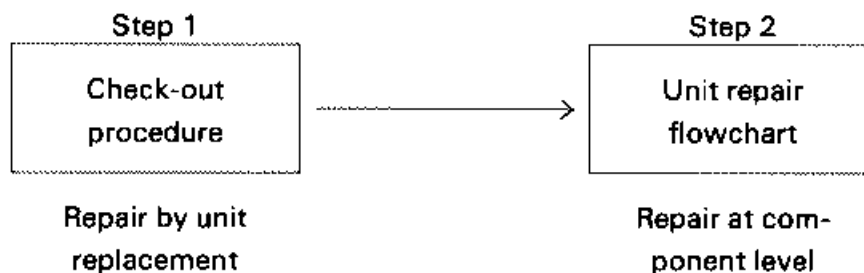

Note 1) All checks indicated on the flowchart must be made.

Should any unit or component be replaced disregarding any check, the newly installed one might be damaged.

Note 2) Whenever you are lost in the repair procedure, return to the entry and restart the procedure.

Note 3) When no exit is found, during a diagnostic procedure (e.g., the test process has resulted in repeating a diagnostic loop), proceed with the repair according to the trouble table.

5.2 Test Program

A test program is supplied stored in an E-PROM with carrier which can be installed in the computer ROM capsule. The test program provides tests for the ten functions listed in Table 5.1. It allows either one of the following two execution modes

● AUTO Mode

In this mode, the program automatically performs a six test cycle. If desired, the cycle may be repeated up to 99 times. The number of cycles may be selected after loading the program. This mode is suitable for an aging test after repair or a test on a problem of very low reproducibility.

- **MANUAL Mode**

The manual mode allows the user to select any one test from those listed in Table 5-1 and is an aid to component level troubleshooting.

Table 5-1 Functions Tested by the Test Program

No.	Tested Functions
1	RAM CHECK
2	BUZZER CHECK
3	RS, SER CHECK
4	LCD CHECK
5	MCMT CHECK
6	DIP-SW READ CHECK
7	KEY BOARD CHECK
8	ANALOG INPUT CHECK
9	BARCODE CHECK
10	CLOCK CHECK

5.2.1 Repairing Tools

Table 5-2 lists necessary repair tools which are available from EPSON.

Table 5-2 Repaired Repair Tools

	Tool	Q'ty
1	Test program ROM	1
2	RS-232C interface mini-wrapping connector	1
3	Serial interface mini-wrapping connector	1
4	Microcassette tape	1
5	Cable assembly (P/N B778400201)	1
6	DC regulator or dry-cell battery	1
7	Low-resolution barcode reader	1

The wrapping connector, internal pin connections, and the external power supply set-up, etc. are illustrated in Fig. 5-1.

Wrapping connector pin arrangement

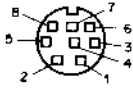

Internal pin connections

Serial interface

4 ↔ 5

2 ↔ 3

RS-232C interface

6 ↔ 7

2 ↔ 3

4 ↔ 5 ↔ 8

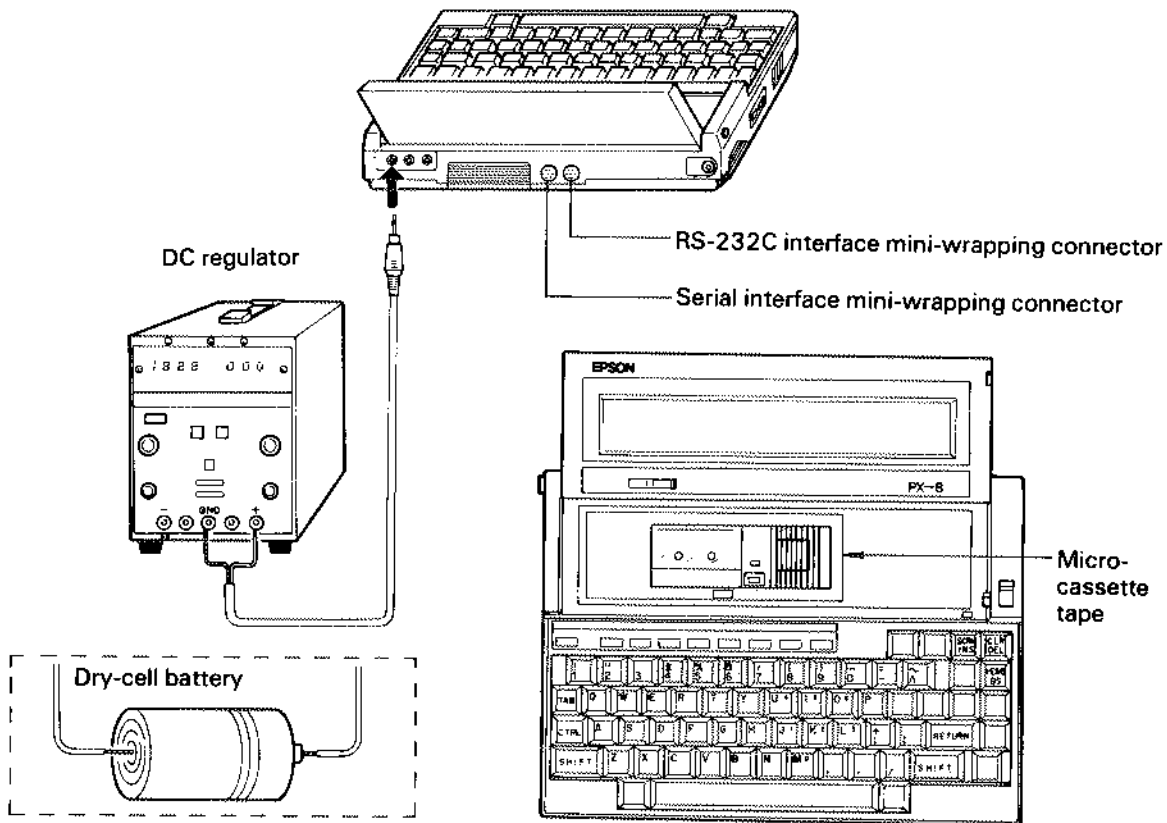

Fig. 5-1 Set-up for Repair

5.2.2 Installing the Test Program ROM

To install the test program ROM in the ROM capsule of the computer, perform the following steps:

Step (1): Reset the POWER switch OFF.

Step (2): Remove the ROM capsule cover from the bottom panel.

Step (3): When two ROMs are already installed in the capsule, remove either one by alternately lifting up on the tabs at both ends of the ROM.

* If the ROM is difficult to remove, alternately raise both the ends with a flat screw driver.

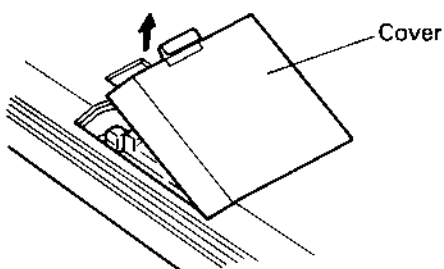

Fig. 5-2 ROM Capsule Cover Removal

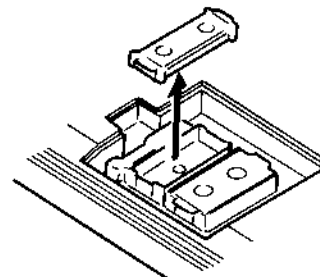

Fig. 5-3 ROM Removal

Step 4: Insert the test program ROM in the capsule. Make sure that the ROM pins are properly inserted into the socket.

Note: When neither ROM capsule is empty, the test program ROM may be inserted in either ROM socket; ROMB or ROMC. When one ROM is already installed, insert the test program ROM in the empty socket.

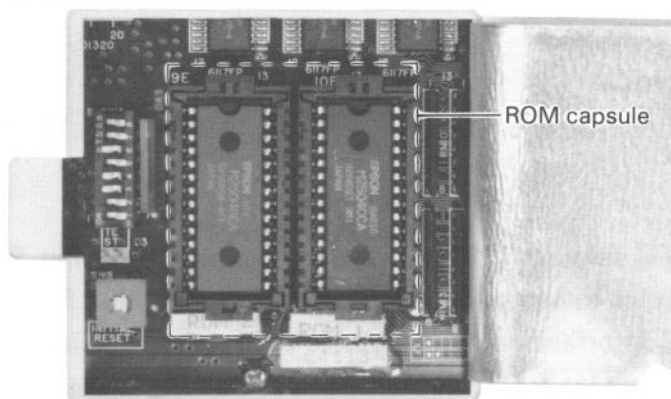

Fig. 5-4 ROM Capsule Sockets

Step 5: Replace the ROM capsule cover.

5.2.3 Loading the Test Program

Set the POWER switch ON and check to see that the menu shown in Fig. 5-5 appears on the LCD panel. The display varies depending on the inserted ROM. If nothing appears on the panel, press the RESET switch.



Fig. 5-5 Tet Program Menu

- Move the cursor so that "MAPTST" blinks, and then press the RETURN key.

Note: One of the messages shown in Fig. 5-6 will be displayed, depending on the ROM capsule socket in which the program ROM is inserted.

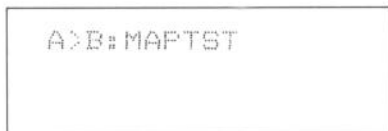

1. Message displayed when test program ROM is inserted in ROM 1 socket.



2. Message displayed when test program ROM is inserted in ROM 2 socket.

Fig. 5-6 Test Program ROM Location Information Messages

- After the above preparation, the following menu will appear on the LCD panel.

```

TEST PROGRAM MENU MODE Ver 1.0

1 : AUTO
2 : MANUAL
  
```

Fig. 5-7 AUTO and MANUAL Mode Selection Menu

5.2.4 Selecting a Test Mode

In response to the menu in Fig. 5-7, key in "1" or "2", respectively, to select the AUTO or MANUAL test mode.

- AUTO Mode

When the AUTO mode is selected ("1" is keyed in), the prompt of Fig. 5-8 should appear. Specify a number of test cycles to be run by responding with a number from 1 to 99.

RAM, buzzer, RS-232C interface, serial interface, LCD unit, microcassette tape drive, and DIP switch tests make up one test cycle. When the AUTO mode is selected, this cycle is repeated according to the number of times specified in response to the prompt.

```

CHECK COUNT ?
  
```

Fig. 5-8 Prompt for Number of Test Cycles

- MANUAL Mode

```

TEST PROGRAM SELECT
1. RAM CHECK           2. BUZZER CHECK
3. RS, SER CHECK      4. LCD CHECK
5. MGMT CHECK         6. DIP-SW READ CHECK
7. KEY BOARD CHECK   8. ANALOG INPUT CHECK
9. BARCODE CHECK     10. CLOCK CHECK
  
```

Fig. 5-9 Menu for an Individual Test

Select a test by keying in the number preceding the test. When the test is completed, the display stops. To repeat the test again, press the spacebar, otherwise, press the RETURN key.

To stop the test after the keyboard check has been selected, key in "Break".

* If any error message appears, refer to section 5.2.6.

5.2.5 Test Run Procedure and Display Information

This section describes the procedure for running the individual tests and display information given by them.

```

MEMORY & V-RAM CHECK
  
```

Fig. 5-10 RAM Check Test Information Message

(1) RAM Check

- The information message displayed in Fig. 5-11 appears.
- The RAM and V-RAM check tests are performed in succession and the following messages are displayed when the tests are completed.

```
RAM CHECK END !!
VRAM CHECKING !!
VRAM CHECK END NOW !!
```

Fig. 5-11 RAM Check Test End Messages**(2) Buzzer Check**

- The buzzer sounds for approximately three seconds.
- The buzzer further sounds at two different tones and then the following prompt is displayed:

```
BUZZER OK ?
```

Fig. 5-12 Buzzer Check Test Prompt

* Adjust the sound level and do another check.

(3) RS-232C and Serial Interface Check

- Step 1: Insert the RS-232C serial interface connector, which is connected according to the instructions in section 5-1. (The RS-232C socket is labeled on the PX-8 case.)
- Step 2: Key in "3" for the test menu (TEST PROGRAM SELECT). The RS-232C and Serial Interface Check test will be selected. The program runs the RS-232C interface test first, displaying the following information:

```
RS232C CHECKING
RS232C CHECK END NOW
```

Fig. 5-13 RS-232 Interface Check Phase Information Messages

- Step 3: The program then runs the serial interface test the display should appear as in Fig. 5-14.

```
HIGH SPEED SERIALIZING
HIGH SPEED SERIAL END NOW !!
```

Fig. 5-14 Serial Interface Check Phase Information Messages

- Step 4: These messages indicate the end of the test.

(4) LCD Check

- The entire LCD panel display is reversed.
- The LCD panel display is reversed every other dot and then the black and white combination is reversed.
- The LCD panel display is reversed every four dots and then the black and white combination is reversed.

The following character pattern appears (Fig. 5-15) and the test ends.

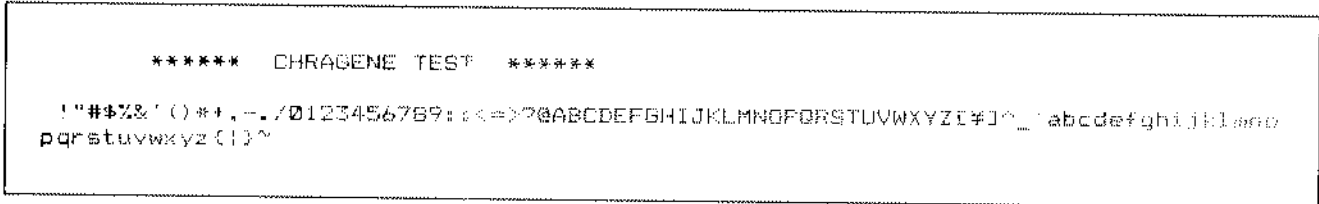

Fig. 5-15 LCD Check Test Character Pattern

(5) MCMT (Microcassette Tape Drive) Check

- The following prompt appears:

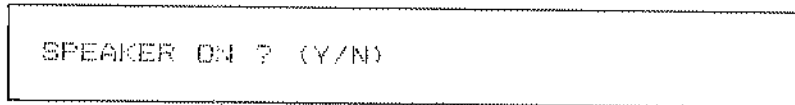

Fig. 5-16 First MCMT Check Test Prompt

If speaker sound output is desired depress "Y" (YES); if not, press "N" (NO), respond by inputting "Y" (YES) or "N" (NO) as desired.

- The next prompt will appear as follows:

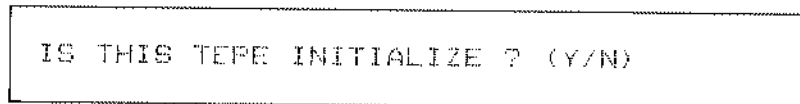

Fig. 5-17 Second MCMT Check Test Prompt

Examine the tape and respond with "Y" to this prompt if the tape data may be destroyed. Otherwise, key in "N".

- A Rewind/Fast Feed and Read/Write check tests are performed after the following information message is displayed:

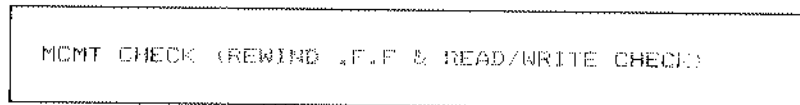

Fig. 5-18 MCMT Check Test Information Message

- The third prompt appears as follows:

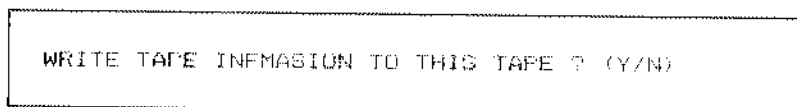

Fig. 5-19 Third MCMT Check Test Prompt

- The test ends with the following information message:

```
WRITE DATA & STOP
HEAD OFF
```

Fig. 5-20 MCMT Check Test End Message

(6) DIP SW Read Check

- The following information is displayed:

```
87654321 ← DIP switch SW4 elements 1 through 8
INITIAL=00101111 } ← Element setting
00101111 }
```

Fig. 5-21 DIP SW Read Check Test Data

- Make sure that the DIP switch setting agrees with the following table.

Table 5-3 DIP Switch of Settings

SW4 Setting	SW4							
	1	2	3	4	5	6	7	8
Character set specification								
ASCII (USA)	1	1	1	1	0	1	0	0
French	0	1	1	1	0	1	0	0
German	1	0	1	1	0	1	0	0
English	0	0	1	1	0	1	0	0
Danish	1	1	0	1	0	1	0	0
Swedish	0	1	0	1	0	1	0	0
Norwegian	0	1	1	0	0	1	0	0
Italian	1	0	0	1	0	1	0	0
Spanish	0	0	0	1	0	1	0	0
HASCI	0	0	0	0	0	1	1	0
Japanese (Japanese language)	1	0	0	0	0	1	0	0
Japanese (kana)	0	0	0	0	0	0	0	0
Japanese (touch 16)	1	0	0	0	0	0	0	0

(7) Keyboard Check

Step 1: Select your keyboard type by responding with the number following the specification of your unit.

The following display data prompt will appear:

```

THEN DSP DATA KEY-IN !!

```

Fig. 5-22 Keyboard Test Display Data Prompt

Step 2: In response to the above prompt, key in characters to be displayed in the following order:

STOP	1	2	3	4	5	6	7	8	9	10	11	12		
13	15	17	19	21	23	25	27	29	31	33	35	37	39	
14	16	18	20	22	24	26	28	30	32	34	36	38	40	41
42	43	45	47	49	51	53	55	57	59	61	63	65	67	
44	46	48	50	52	54	56	58	60	62	64	66	(68)	(69)	
	69					70				71				
	(70)					(71)				(72)				

Fig. 5-23 Keyboard Check Test Character Data Entry

* The numbers within the parentheses are for a 73-key keyboard.

- When the key data entry ends, the following prompt appears.

```

ONCE MORE KEY-BOARD CHECK ? (Y/N)

```

Fig. 5-24 Keyboard Check Part 2 Test Entry Prompt

Step 3: If the keyboard check, part 2, test is desired, respond with "N" to this prompt. Otherwise, key in "Y". The above part 1 test will be repeated.

- The program enters the part 2 test and displays the following prompt:

```

KEY-BOARD CHECK Part 2
PUSH KEY-IN !!

```

Fig. 5-25 Keyboard Check Part 2 Test Prompt

Step 4: Key in the same characters as randomly displayed, following the above prompt.

Step 5: To terminate the test, key in "Break". The program will end the test leaving the following information message:

```
KEY-BOARD CHEK Part 2 END !!
```

Fig. 5-26 Keyboard Check Test End Message

(8) Analog Input Check

Step 1: Connect a DC voltage regulator (output voltage range should be from 0V to +2.0V) and a dry-cell battery. Use the cable assembly P/N B778400201 according to the instructions in section 5.1.

- The program displays the connected voltage at an accuracy of $\pm 0.02V$.

Step 2: When a DC voltage regulator is used, compare the displayed value with the reading. If a dry-cell battery is used, measure and compare its voltage.

(9) Barcode Check

- The following is displayed:

```
INPUT
```

Fig. 5-27 Barcode Check Test Prompt

Step 1: Read the barcode pattern using a reader.

- If the pattern and read data agree, "OK" appears on the LCD panel.

(10) Clock Check

- The following prompt appears:

```
TIME SET ? (Y/N)
```

Fig. 5-28 Time Setting Prompt

Step 1: If you would like to set the time, respond with "Y" to this prompt; otherwise, key in "N".

- When "Y" is keyed in above, the time setting guide message is displayed:

```
INPUT DATA Year/ Month/ Day/ Hour: Minute: Sec / Week
Week Data Code
Sun:00 Mon:01 Tue:02 Wed:03 Thu:04 Fri:05 Sta:06
```

Fig. 5-29 Time Setting Guide Message

Step 2: Key in the date and time as follows: year, month, day, week day, hour, minute, and second.

- The set time should be updated every one second.

5.2.6 Test Program Messages

The test program displays a message on the LCD panel when it terminates normally. When any malfunction is found, a diagnostic code indicates the problem area.

Major error messages are explained in the following:

(1) Return codes from slave CPU 6303

The slave CPU operation being performed when an error occurs is indicated on the LCD panel as a one-byte return code as shown in Fig. 5-30. Table 5-4 lists all the available return codes and summarizes their meaning.



Fig. 5-30 Error Message Format

Table 5-4 Slave CPU Return Codes and Their Meaning

Device	Code	Meaning
SYS	00	Normal processing termination
SYS	01	Break ACK – Indicates that a break took place.
SYS	02	Command error – Indicates that a command has been input which is not included in the defined system
SYS	03	Communication error – Indicates that a command is received when data was to be received/sent or vice versa.
2CD	11	Illegal size – Indicates that a screen-over occurred which is attributable to an illegal size specification.
2CD	12	An undefined graphic alphabetic character was used.
2CD	13	An alphabetic character code was used. Or, an attempt was made to define any other than that for alphabetic character.
MCT	41	Head error – Indicates that the head failed to operate normally.
MCT	42	The tape stopped during processing.
MCT	43	Write protect error – An attempt was made to write a tape with no write protect pin.
MCT	44	Data error – Indicates that the data could not be determined to be either 1 or 0 because the data pulse is wider or narrower than the standard value.
MCT	45	CRC error
ESPS	61	A linkage failed.
ESPS	62	Communication error – Overrun or framing error.
ESPS	63	Timer over
BEEP	71	BEEP already in progress – Indicates that a BEEP or MELODY was attempted when another BEEP or MELODY was already in progress.
MCT	46	Block mode error – A block whose identifier is other than that specified.

(2) RAM error messages

```

ERROR !! ADDRESS ****H
        WRITE DATA **H READ DATA **H

```

Fig. 5-31

D-RAM compare error – Written and read-back data did not agree.

```

ERROR !! BEFORE ADDRESS ****H
        SAVE DATA ** READ DATA **H

```

Fig. 5-32

D-RAM compare error – The RAM test was attempted on a program area (including OS, TPA, and RAM files) where no read/write test is allowed.

```

VRAM ERROR ADDRESS ****H
        WRITE **H READ **H

```

Fig. 5-33

V-RAM compare error – Written and read-back data did not agree.

(3) RS-232C and Serial Interface error messages

```

RS232C CHECK TIME OUT !!

```

Fig. 5-34

RS-232C transmission/reception failure – DIR → DSR, RTS → CTS → CD, TXD → RXD

```

RS232C ERROR TRANSMIT ****H RECIVE ****H

```

Fig. 5-35

RS-232C transmitted/received data failed to agree.

```

ERROR CODE **

```

Fig. 5-36

An RS-232C error code XX –

08: Parity error
10: Overrun error
20: Framing error

```

HIGH SPEED SERIAL I/C ERROR !!
        TRANSMIT DATA ****H RECIVE DATA ****H

```

Fig. 5-37

Data transmitted/received via the serial interface failed to agree.

(4) Microcassette tape drive error messages

```
MCMT INITIALIZE (READ ERROR) TIME UP !!
```

Fig. 5-38

Microcassette tape initialization failure – possibly a mechanical fault.

```
MCMT WIND &F.F TEST CHECK COUNT ****
                      RESULT COUNT ****
```

Fig. 5-39

Tape count (photo-reflector output) error during rewind/fast feed.

```
MCMT READ/WRITE CHECK HEAD ERROR !!
```

Fig. 5-40

Read/write head loading/unloading failure.

```
MCMT READ/WRITE CHECK TAPE STOP ERROR !!
```

Fig. 5-41

Tape feed failure during read/write – the reel stops rotating.

```
MCMT READ/WRITE CHECK ERROR !!
RDC ERROR !! CODE **
```

Fig. 5-42

Read/write error – possibly an abnormal tape feed speed or improper read/write pulse width.

```
MCMT READ/WRITE CHECK READ ERROR !!
READ **      WRITE 25
BLOCK COUNT **** 70 ****
```

Fig. 5-43

Compare error – written and read-back data failed to agree.

```
THIS TAPE CAN'T WRITE
CHANGE ANOTHER TAPE !!
```

Fig. 5-44

Write failure.

```
LET'S CHAGE THE MC-TAPE !!
```

Fig. 5-45

Read failure.

(5) Keyboard error message

```
ONCE MORE KEY-IN !!
KEY-CODE ERROR !!
```

Fig. 5-46

Key entry code mismatch – a key code other than the specified one was input. Up to five key entry retrials are allowed.

(6) Barcode error message

```
FOUND *****
BARCODE ERROR CHECK ERROR
TRY ONCE MORE !!
```

Fig. 5-47

Barcode pattern read failure.

Unit Level Troubleshooting

When trouble-shooting a faulty unit, first find the entry routine for that unit from the entry table. In such a case where there are more than one symptom is observed and symptoms vary during the course of troubleshooting, make it a practice to enter the troubleshooting procedures according to the symptom that occurred first.

Notes on using the flowcharts

- 1) The troubleshooting flowcharts do not necessarily include all information required for troubleshooting such as check modes, etc. Thus, the flowchart context and trouble symptoms should be closely examined.
- 2) If the troubleshooting flowchart instructions lead you into a loop or to the end of a procedure and the problem is not resolved, refer to the schematic drawings or proceed by troubles shooting according to the following procedure:

- Step 1:** Replace the faulty unit with a good one and make sure that the faulty unit is really malfunctioning.
- Step 2:** If the problem is difficult to reproduce or occurs so briefly that it is hard to examine the symptom, vary the supply voltage according to the following instructions:
- (a) Disconnect the battery from the battery connector CN2.
 - (b) Prepare a variable (0 – 10) DC voltage regulator and make sure that the output is turned off.
 - (c) Connect the regulator to the CN2 connector in place of the battery.
 - (d) Adjust the regulator output voltage to +5V.
 - (e) Turn the regulator output on.

After the above setup is completed, vary the regulator output in a range from 4.8V to 6.0V and examine the unit operation at each voltage level. If this voltage margin test is successful maintain the voltage and proceed with troubleshooting, using the check-out procedure and troubleshooting flowchart.

5.3 Check-out Procedure

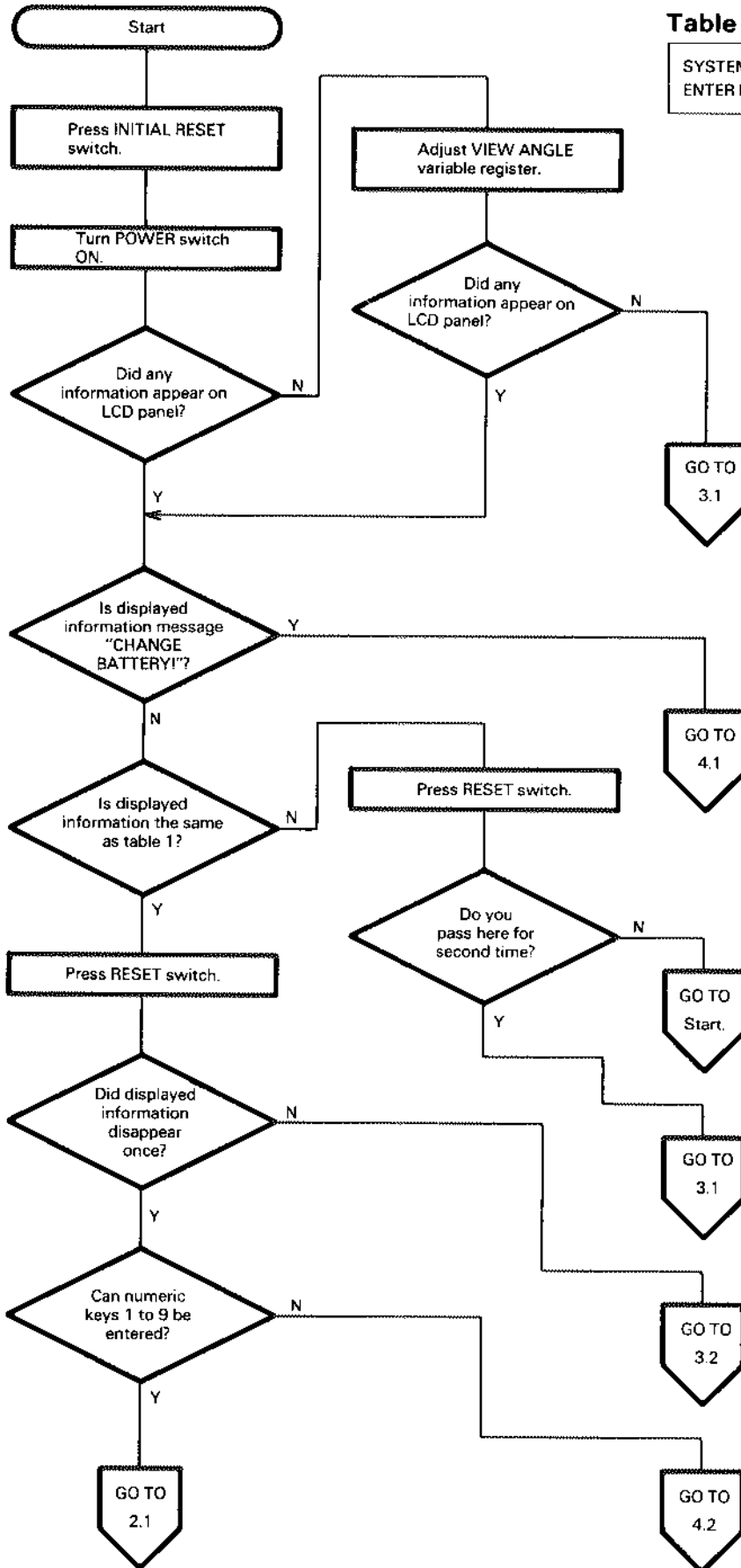
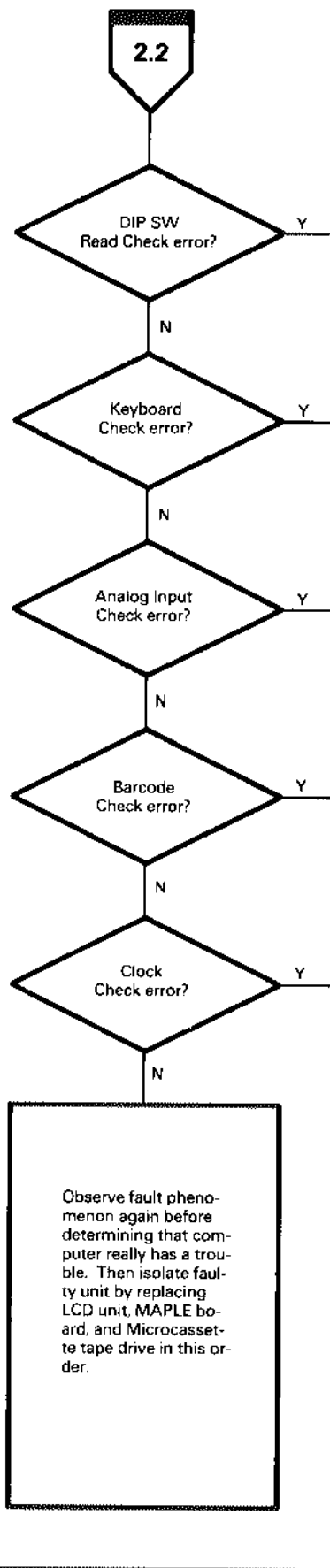
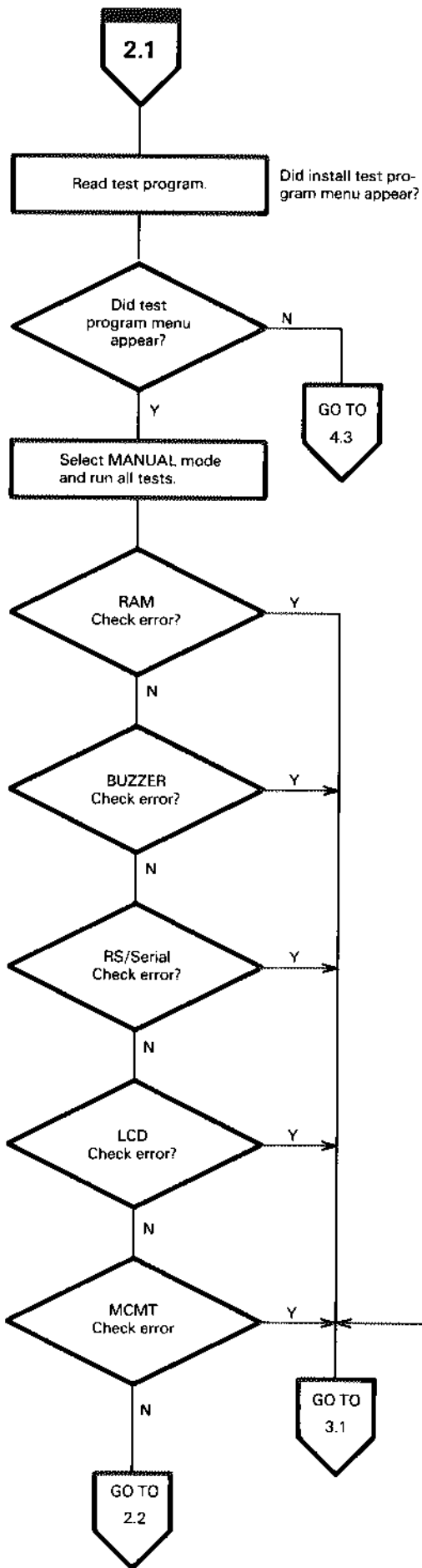
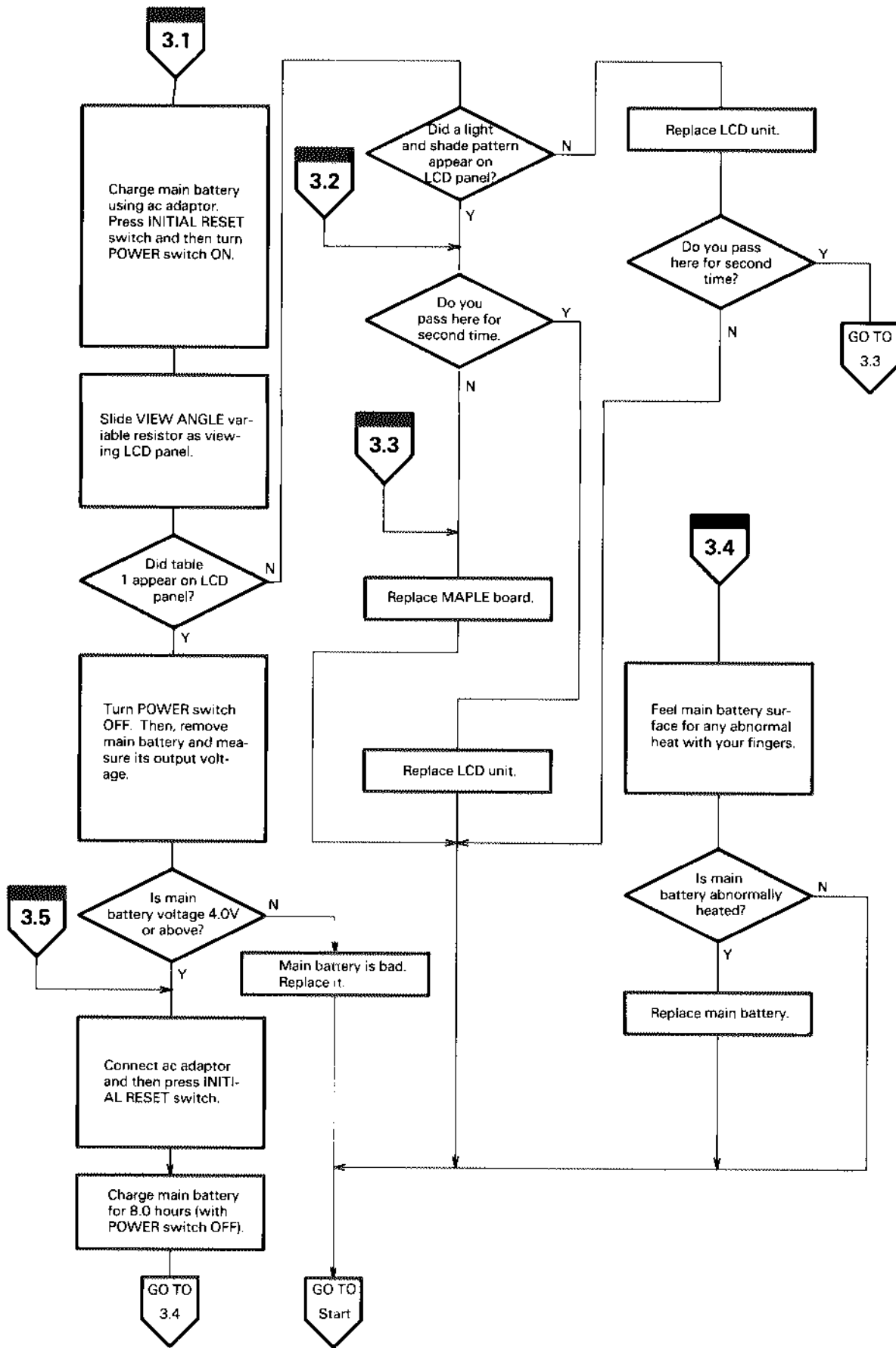
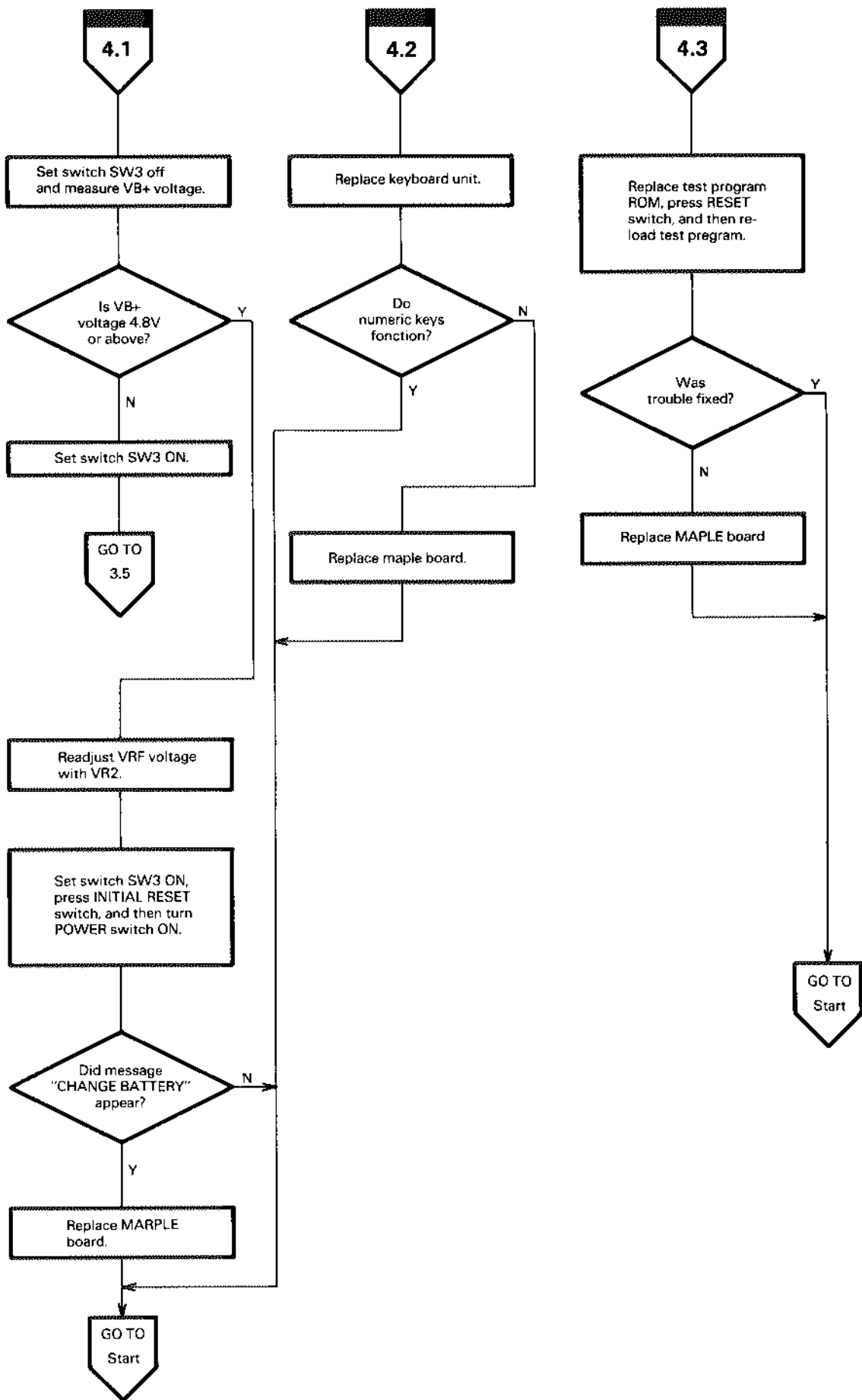

Table 5-1

SYSTEM INITIALIZE	
ENTER DATE TIME (YYMMDDhhmmss)	000000000000







5.4 Unit Troubleshooting

5.4.1 Repairing The MAPLE Board

The following should be noted when repairing the MAPLE board:

- 1) Check to see that the jumpers and switches are correctly set before proceeding with the repair.
- 2) Measure the voltage of the main and auxiliary batteries and verify whether the trouble is caused by insufficient voltage.
- 3) Care must be used to avoid short circuits on either side of the board. Any short circuit will short circuit the auxiliary battery resulting in damage to other circuits.
- 4) Before testing circuit continuity or element function with a circuit tester, make sure that the line or element to be tested is not backed up by battery. Whenever the battery backed-up line has to be checked, remove the auxiliary battery from the board before the test.

(Others)

Depending on location of the problem, a MAPLE board failure may present various symptoms and troubleshooting is harder. Check the computer for any basic problem according to the procedure below, first. If no problem is found by these checks, use the troubleshooting and repair the test program and repair flowchart.

- (1) Check the jumpers and switches for any improper setting.
- (2) Check the logic circuit voltage and clock signal. (Also check fuse F1).
- (3) Check the connectors for any imperfect contact.

MAPLE BOARD REPAIR ENTRY TABLE

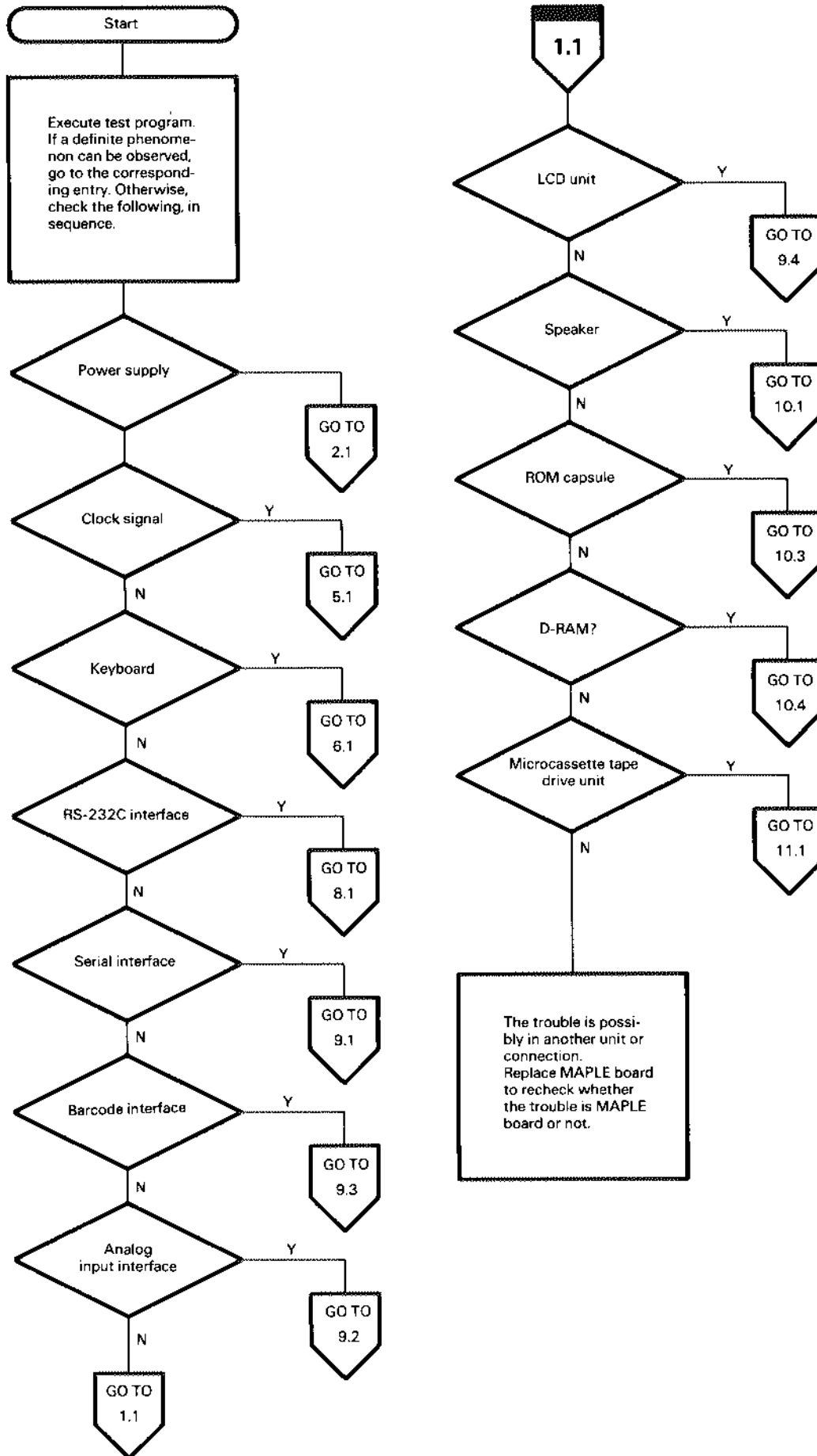

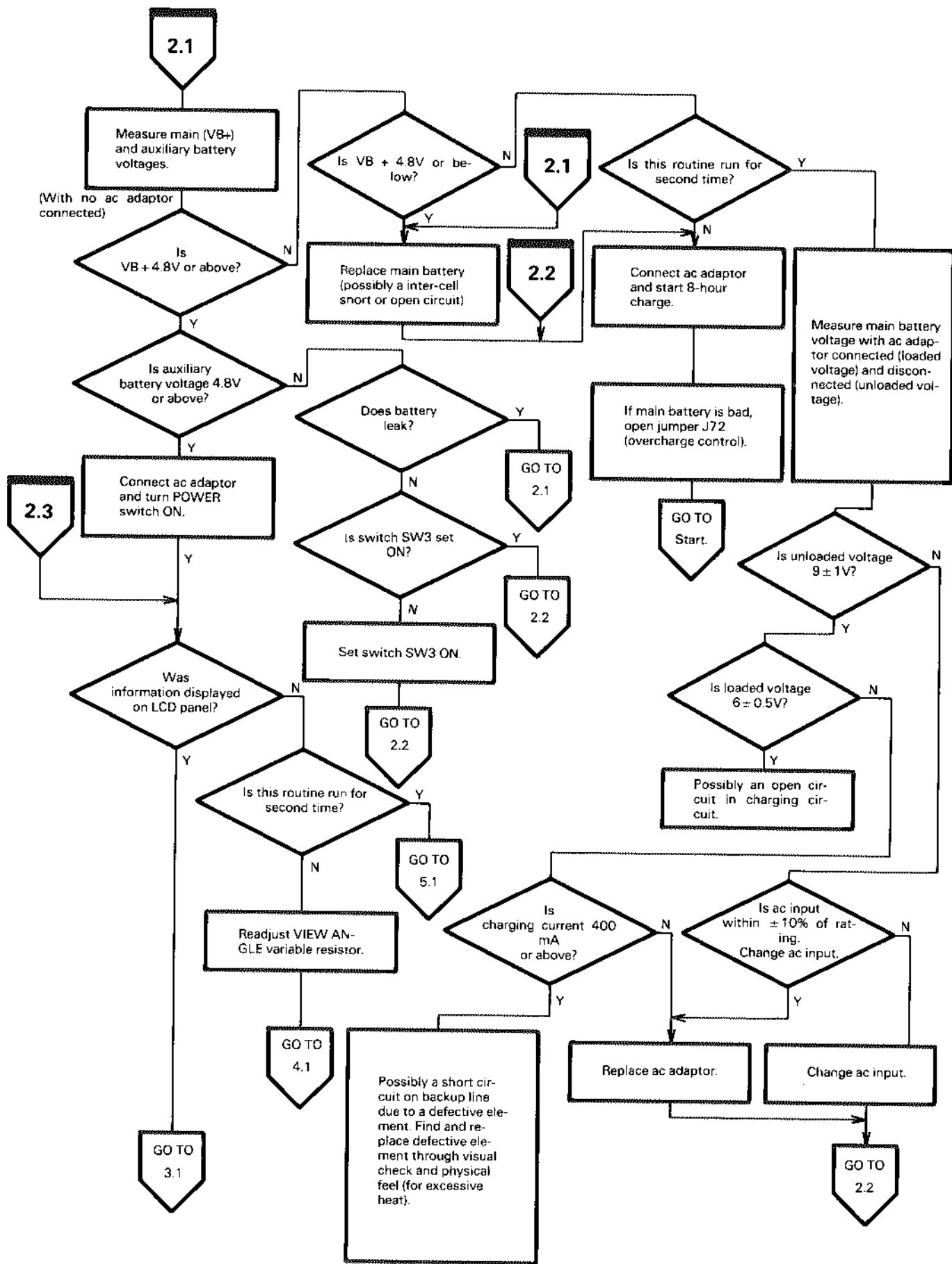

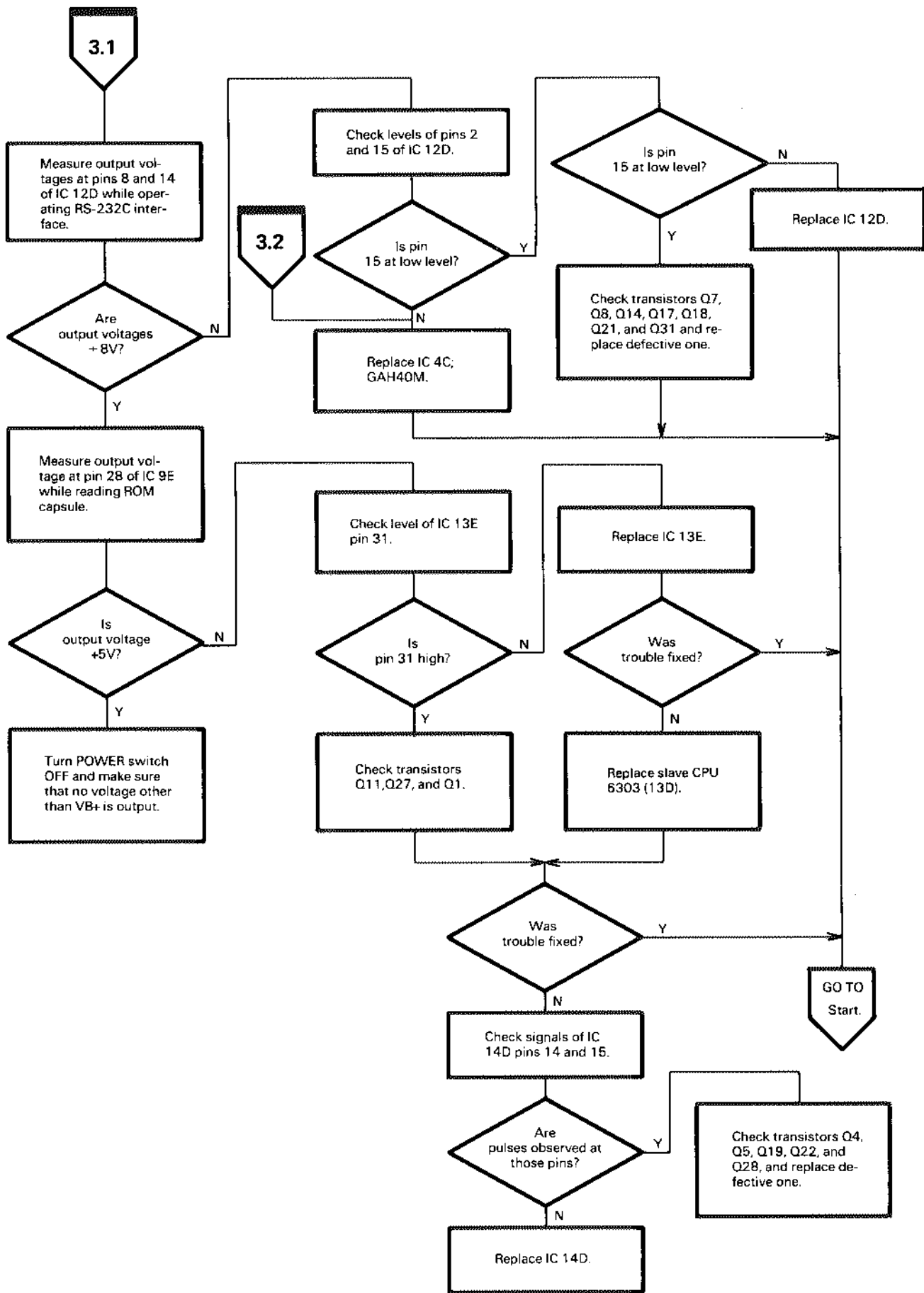

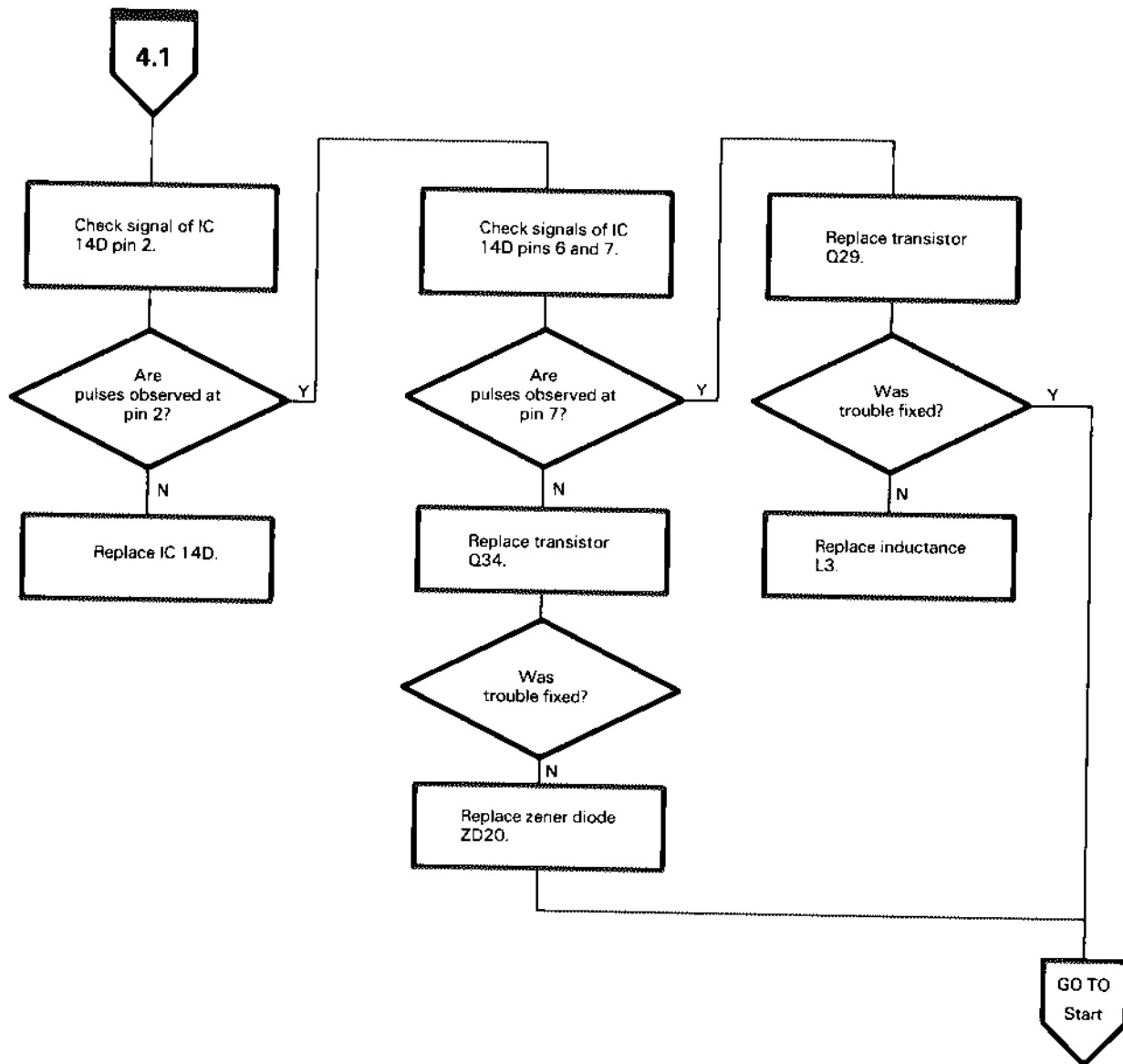

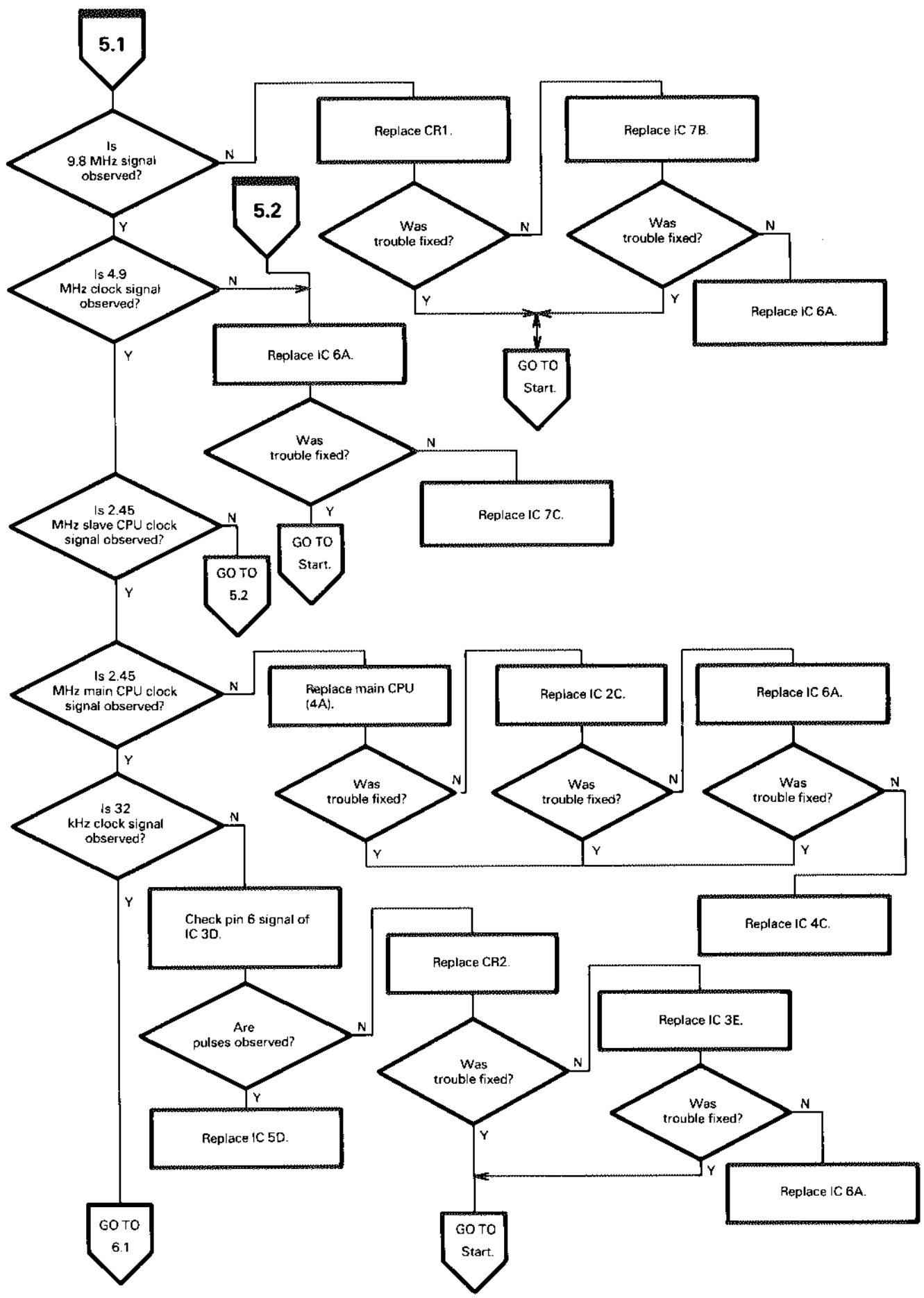

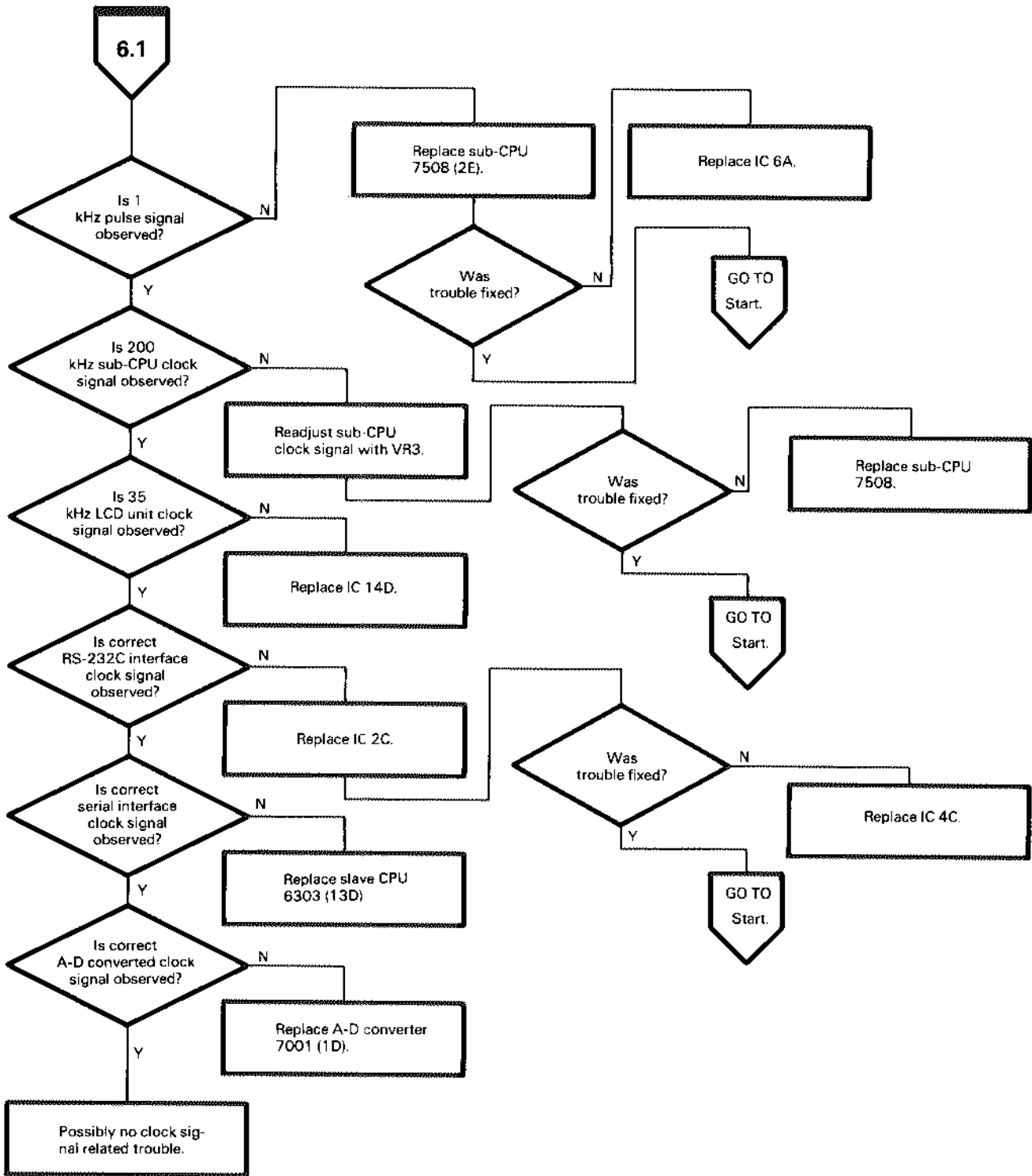

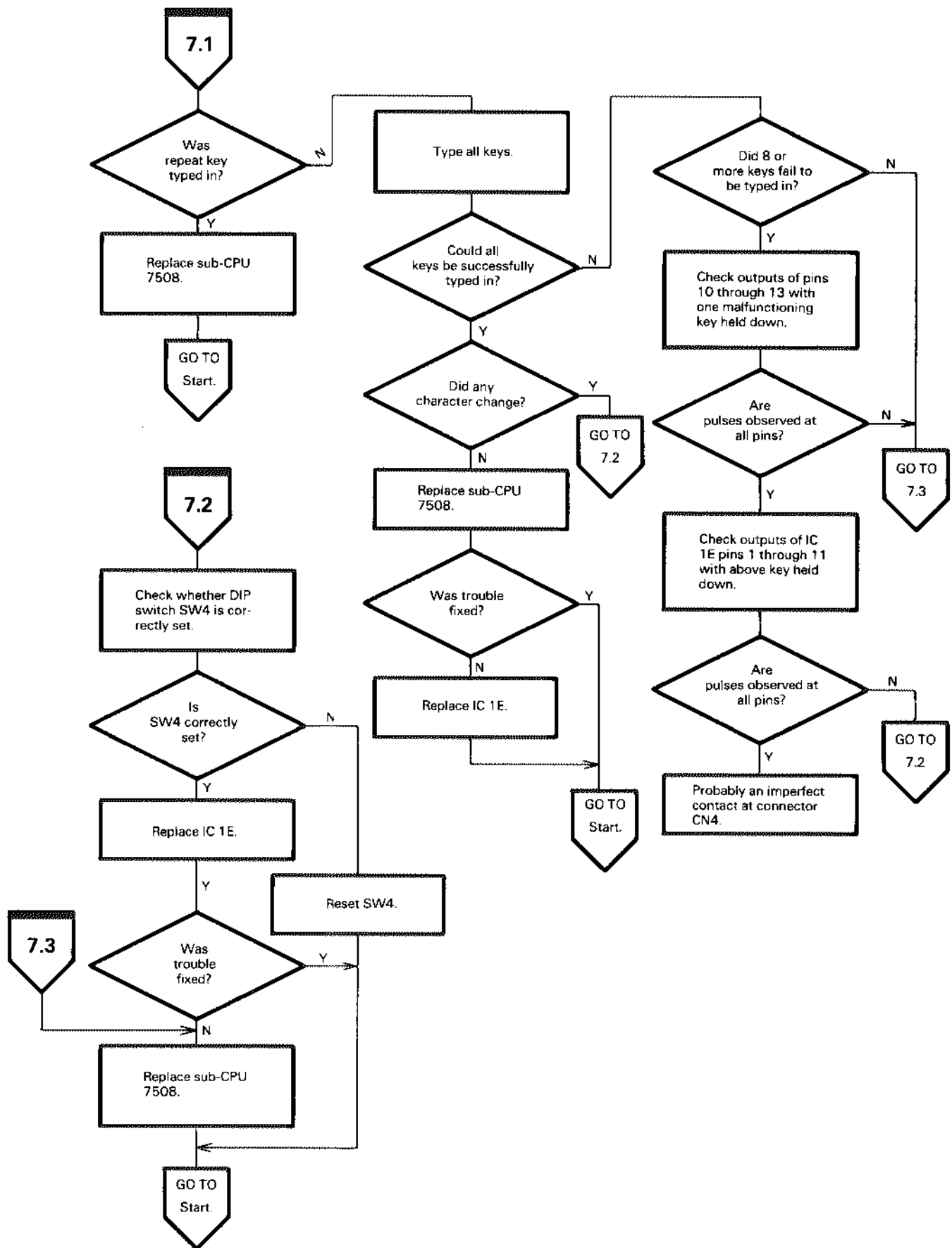

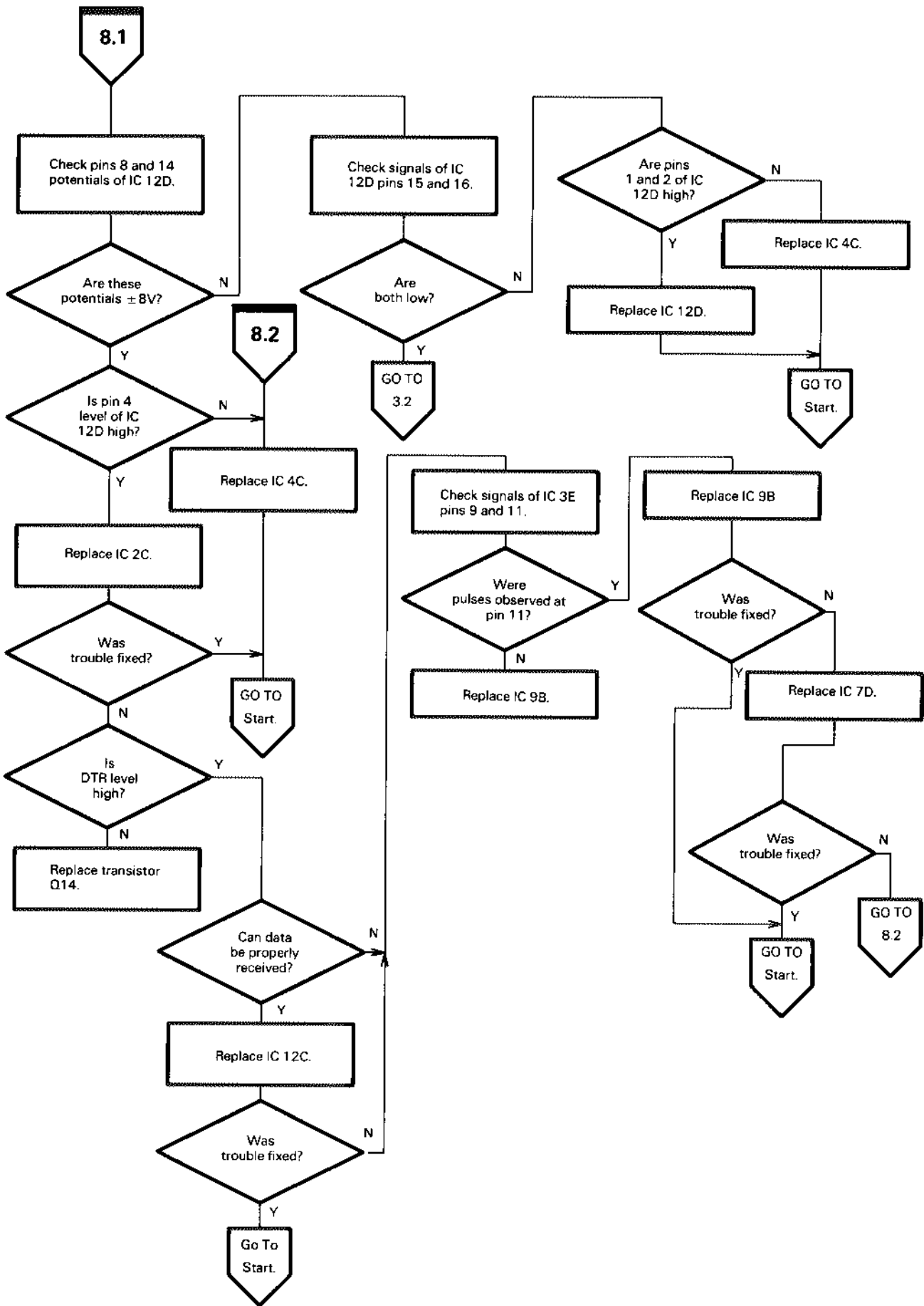

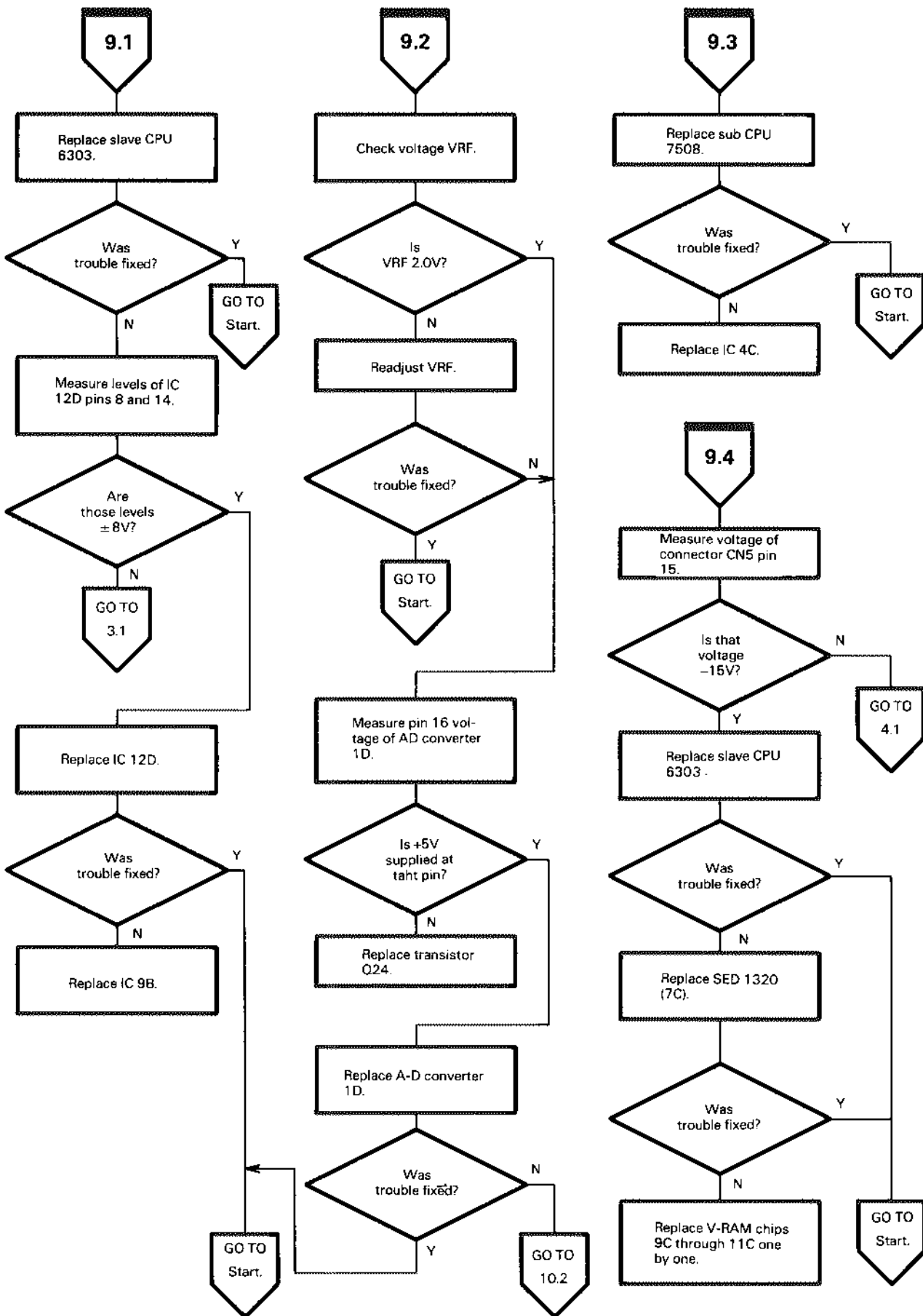

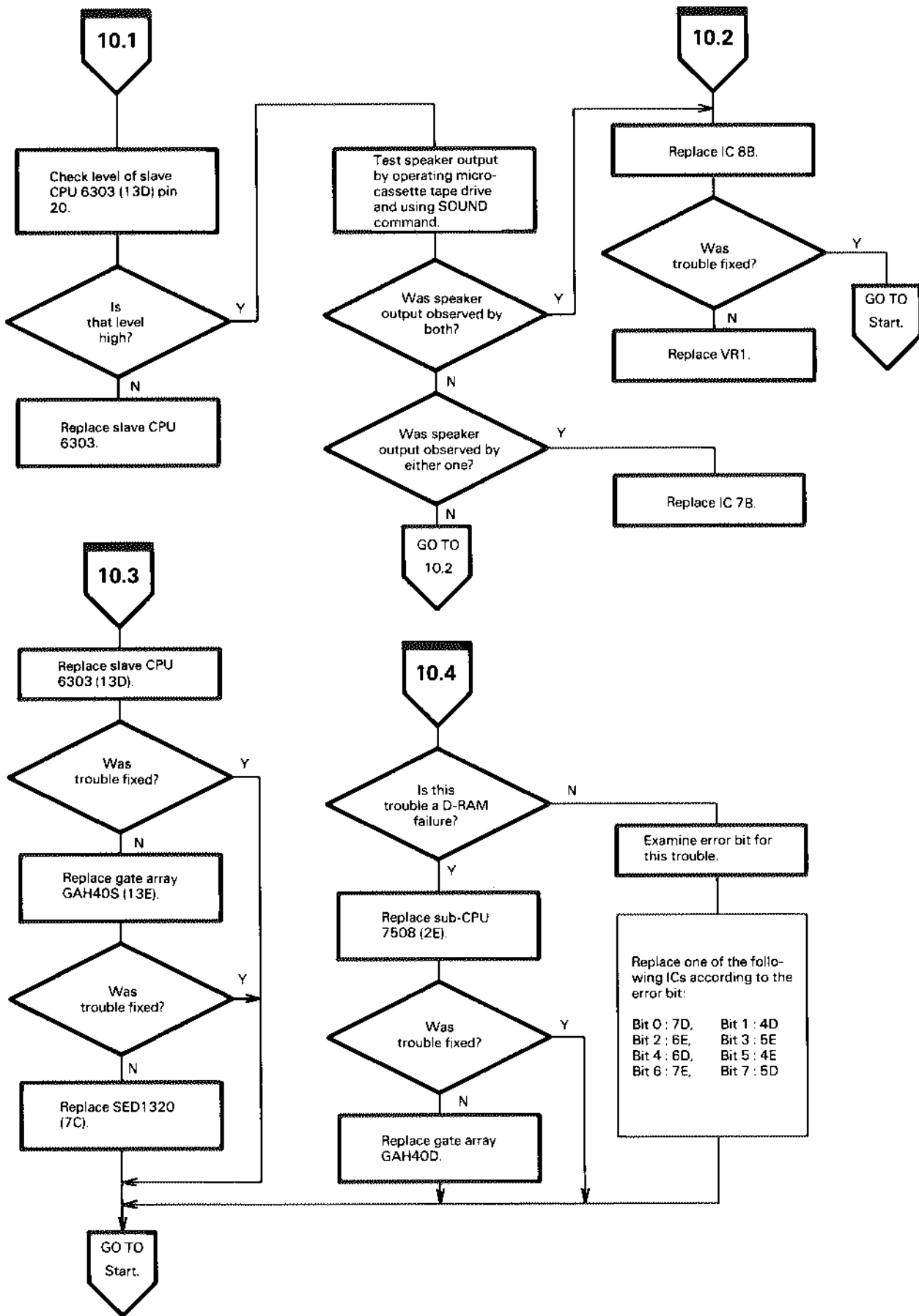

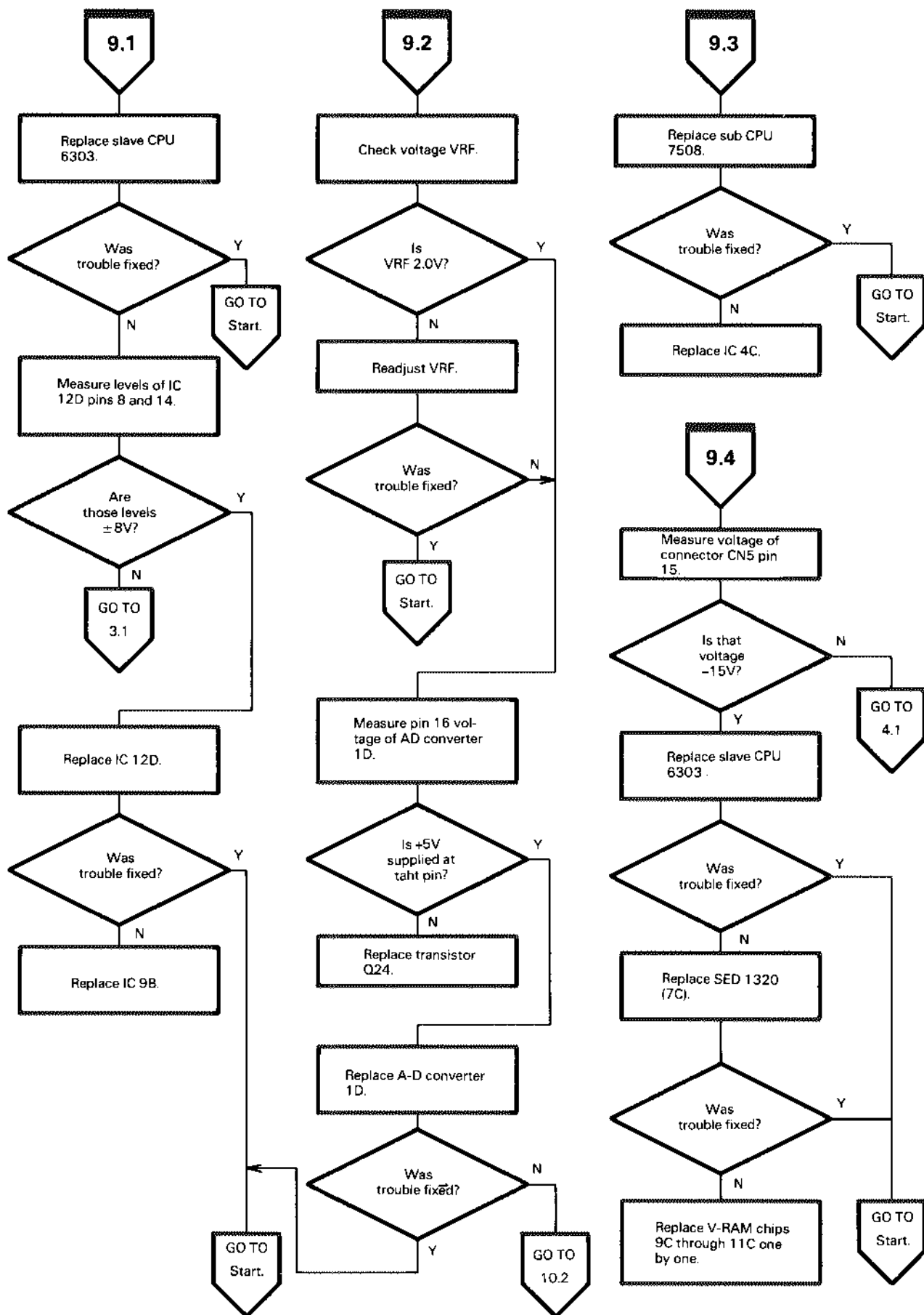

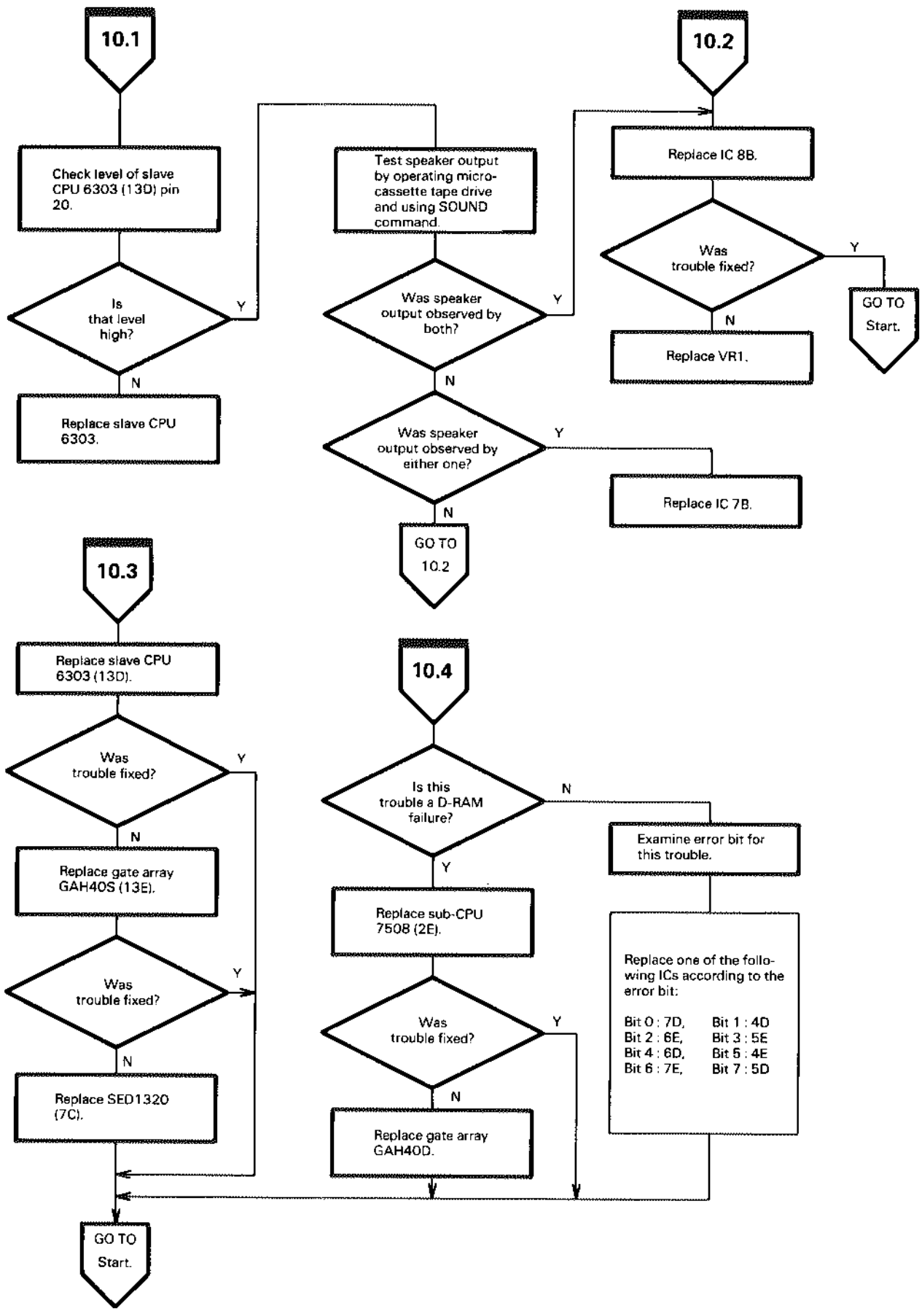

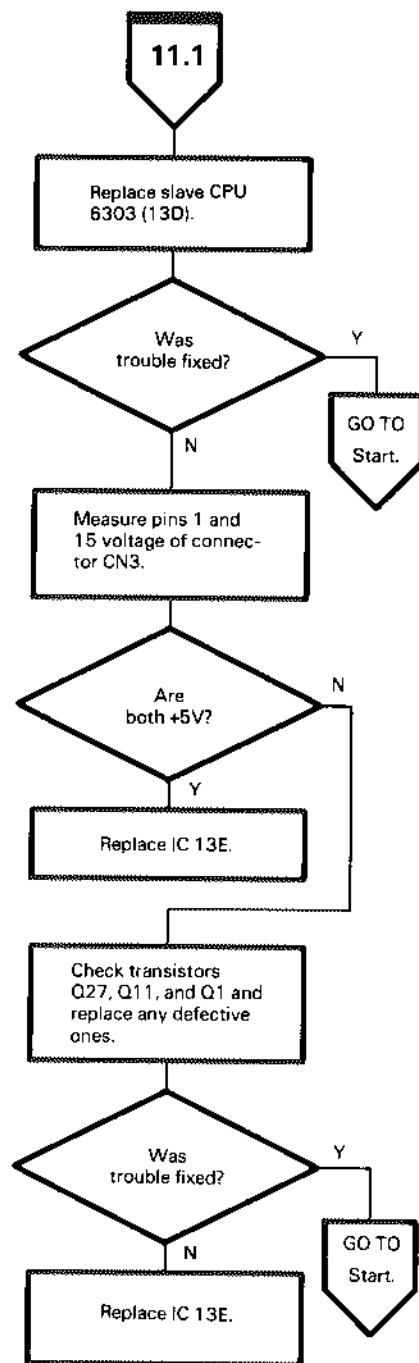

5.4.2 Repairing The LCD Unit

Before repairing the LCD unit, check the following:

- 1) Check the LCD panel surface for damage.
- 2) Check for any shade on the LCD panel when power is off.
- 3) Check the LCD board for any damage.

If a defect is found during the above checks, the LCD unit cannot be repaired. Replace the unit.

* When replacing a flat-package IC, follow the procedure below.

- (1) Remove the solder from the IC terminal leads with a Solderwick.
- (2) Lightly push the IC up with a precision screw driver.
(Do not force the IC; otherwise, the printed circuit pattern may come off the board and the repair may become impossible).
- (3) Remove the IC and remove the remaining solder from the pattern with the solderwick.
- (4) Bend the new IC terminal leads so that they fit to the pattern holes.
(The terminal leads are bent downward when the IC is mounted on the head of the board and upward when mounted on the tail.)
- (5) Resolder the new IC terminal leads.
- (6) Remove the flux from the soldered area.

LCD UNIT REPAIR ENTRY TABLE

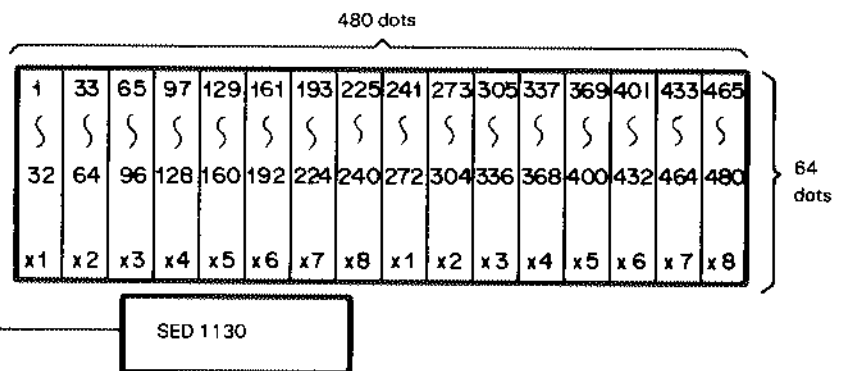
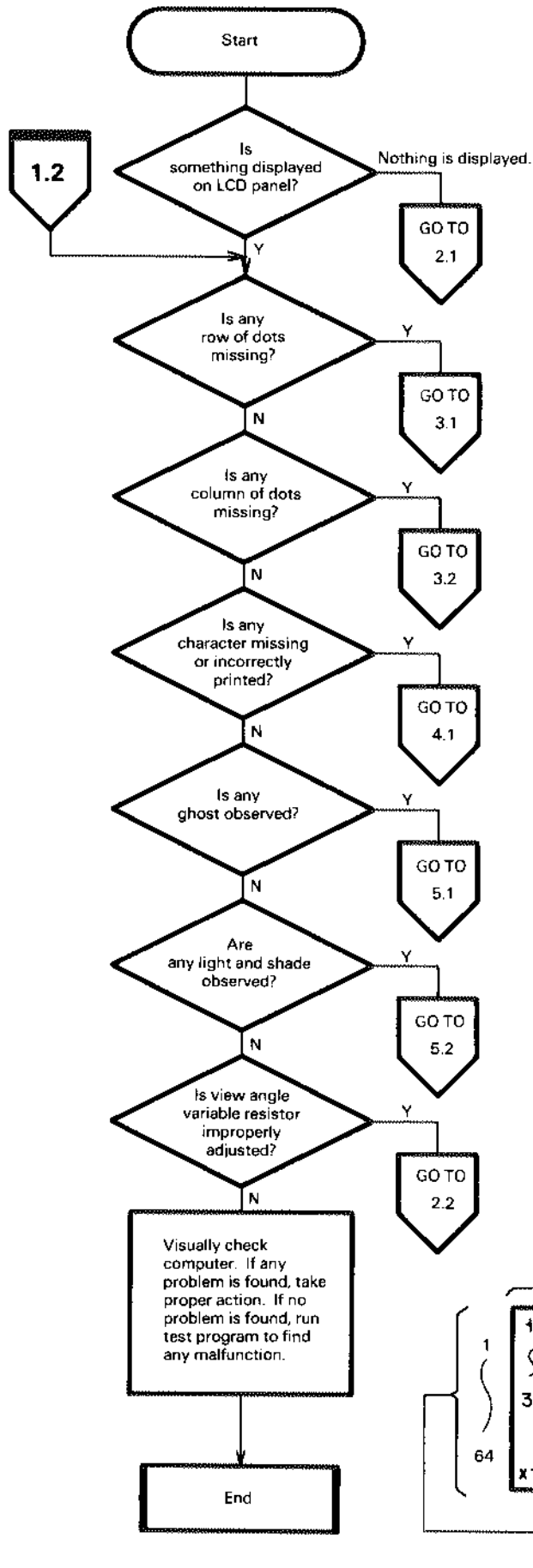

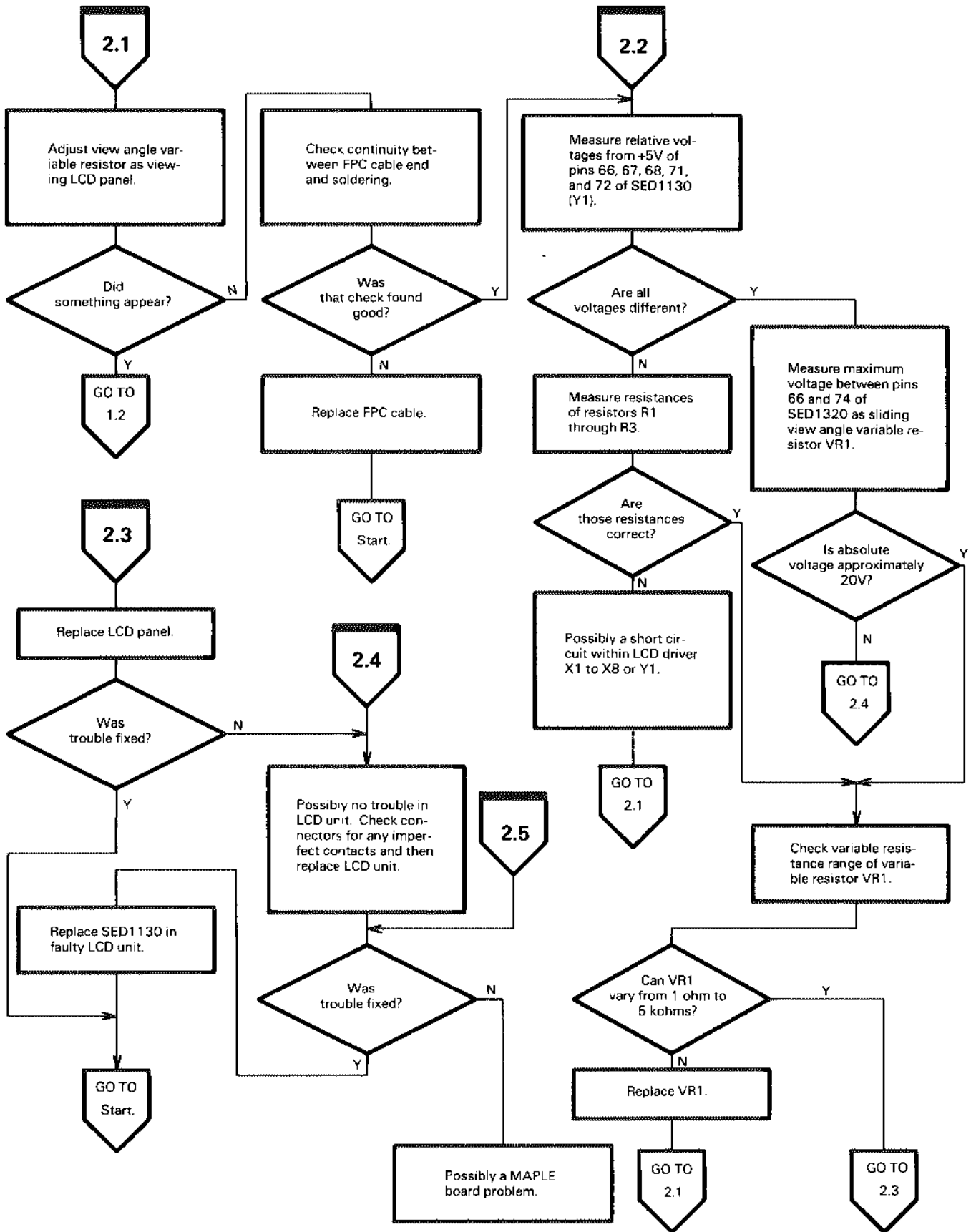

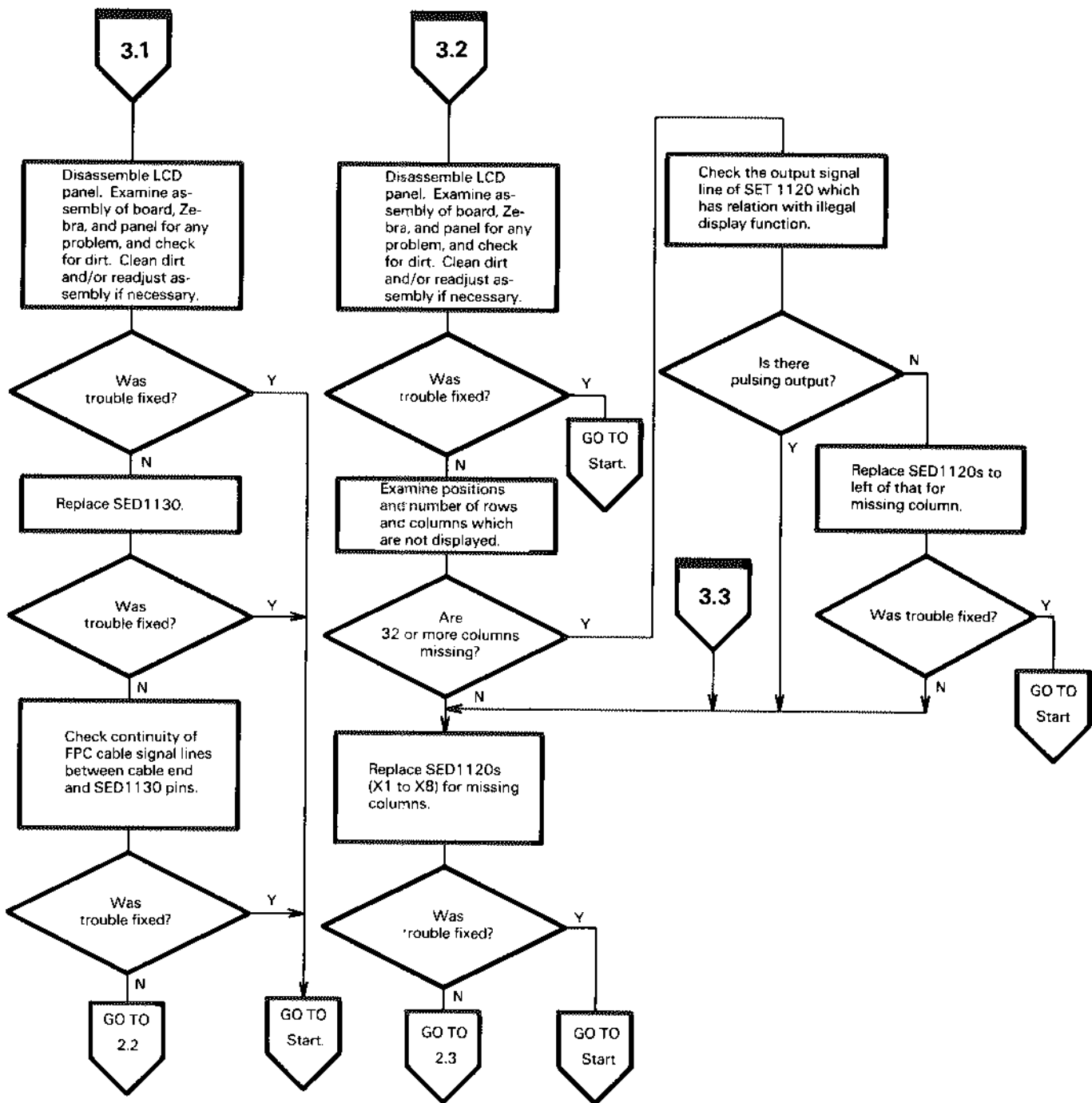

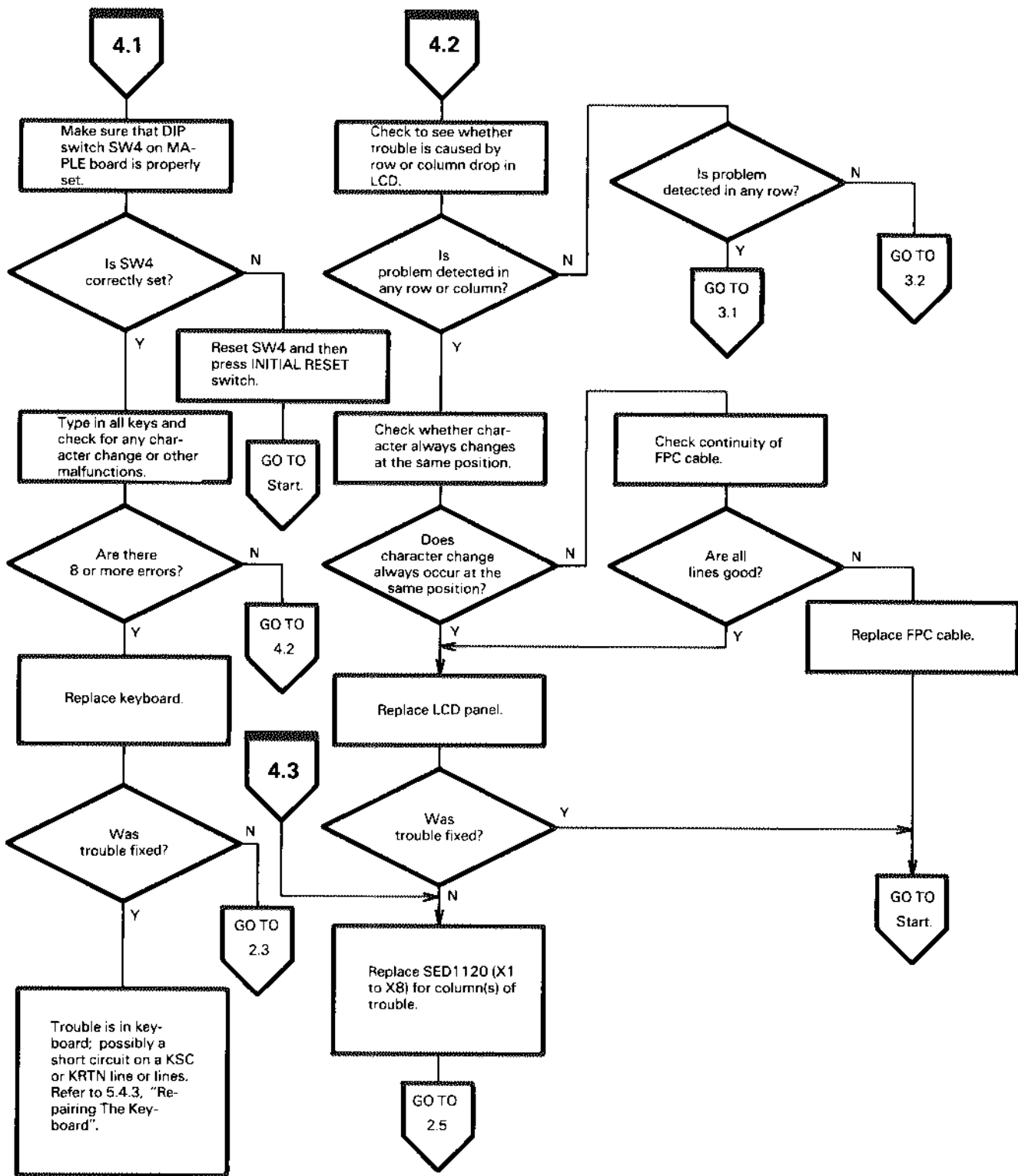

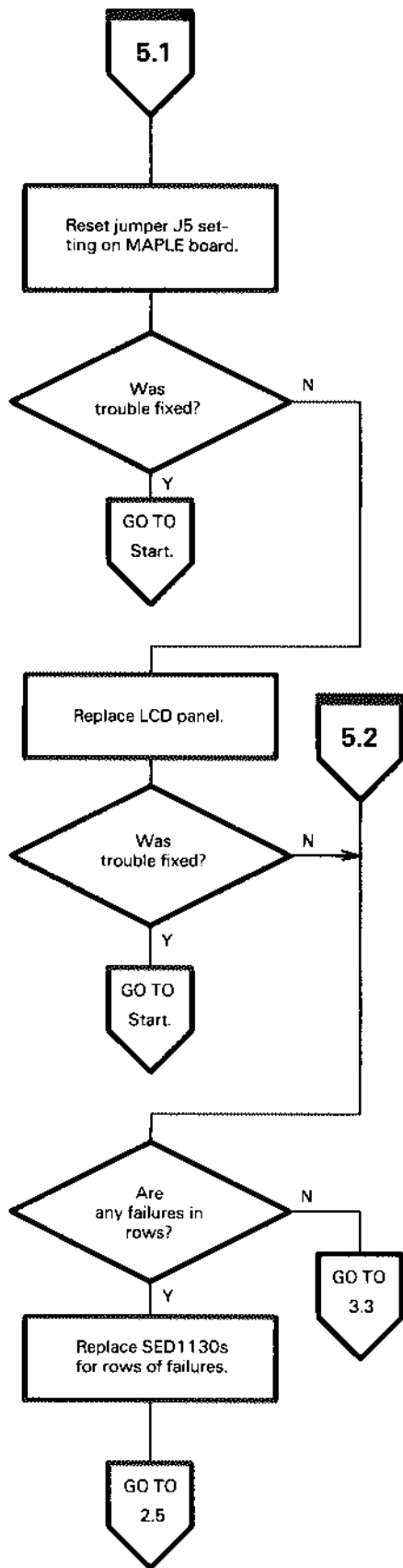

5.4.3 Repairing The Keyboard

Before repairing the keyboard, perform the following checks:

- 1) Visually check the keyboard circuit board for any damage.
- 2) Visually check the keyboard information cable connectors for any damage.
- 3) Visually check the keyboard's internal components such as the circuit board, FPC pattern, and switches, for any foreign matter such as water drops.
- 4) Visually check the circuit board for any FPC pattern separation.

If damaged components which cannot be repaired are found in steps 1 or 2, replace the keyboard. If any foreign matter was found in check 3), clean and dry the components at the normal temperature. After components are dry, test the keyboard functions again.

If a problem still exists, replace the keyboard.

(Even if the trouble disappears, it is possible that it may reoccur at another time due to oxidation of the circuit board patterns. If this occurs the keyboard may have to be replaced.

Printed circuit pattern separations may be fixed by a combination of a hot press and adhesive. If unrepairable, replace the unit.

KEYBOARD UNIT REPAIR ENTRY TABLE

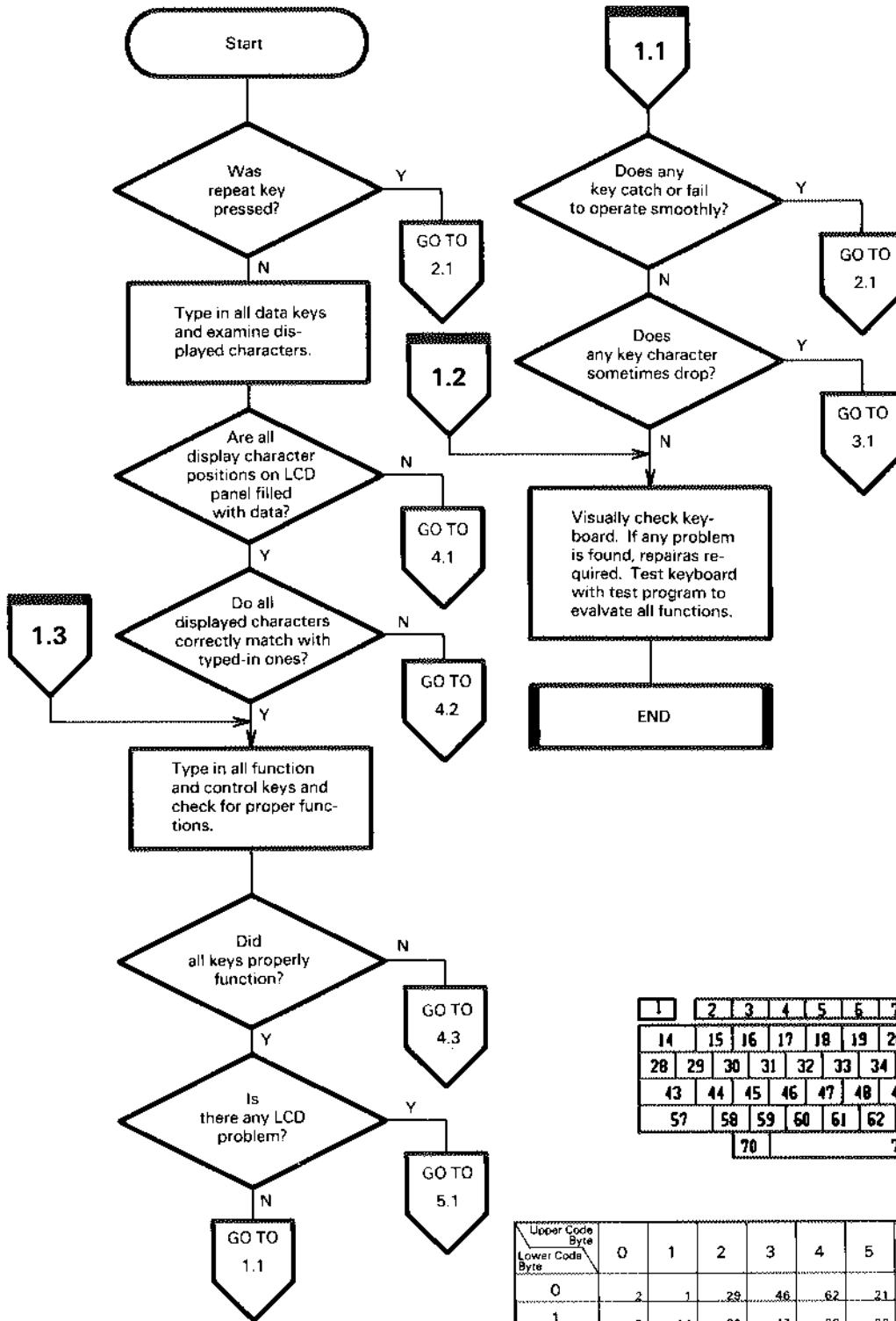

1	2	3	4	5	6	7	8	9	10	11	12	13		
14	15	16	17	18	19	20	21	22	23	24	25	26	27	
28	29	30	31	32	33	34	35	36	37	38	39	40	41	42
43	44	45	46	47	48	49	50	51	52	53	54	55	56	
57	58	59	60	61	62	63	64	65	67	68	69			
	70					71				72				

Upper Code Byte Lower Code Byte	0	1	2	3	4	5	6	7	8	9	A	B
0	2	1	29	46	62	21	37	54	12			
1	3	14	30	47	63	22	38	55	13			
2	4	15	31	48	64	23	39	56		OFF 43	ON 43	
3	5	16	32	49	65	24	40	71		OFF 57	ON 57	
4	6	17	33	50	66	25	41	58		OFF 70	ON 70	
5	7	18	34	51	67	26	42	59		OFF 72	ON 72	
6	8	19	35	52	10	27	44	60		OFF 68	ON 68	
7	9	20	36	53	11	28	45	61		OFF 69	ON 69	
8												
9												

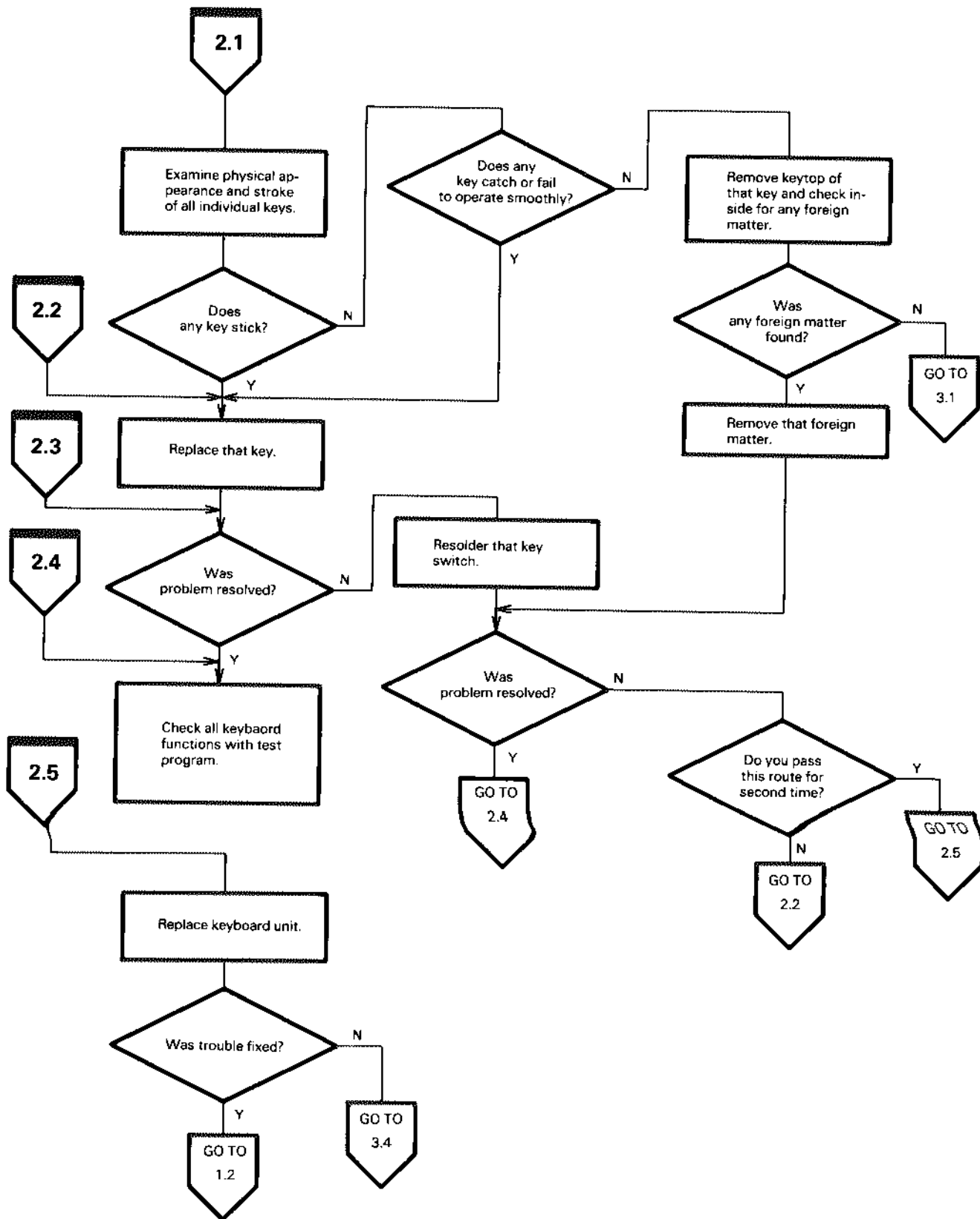

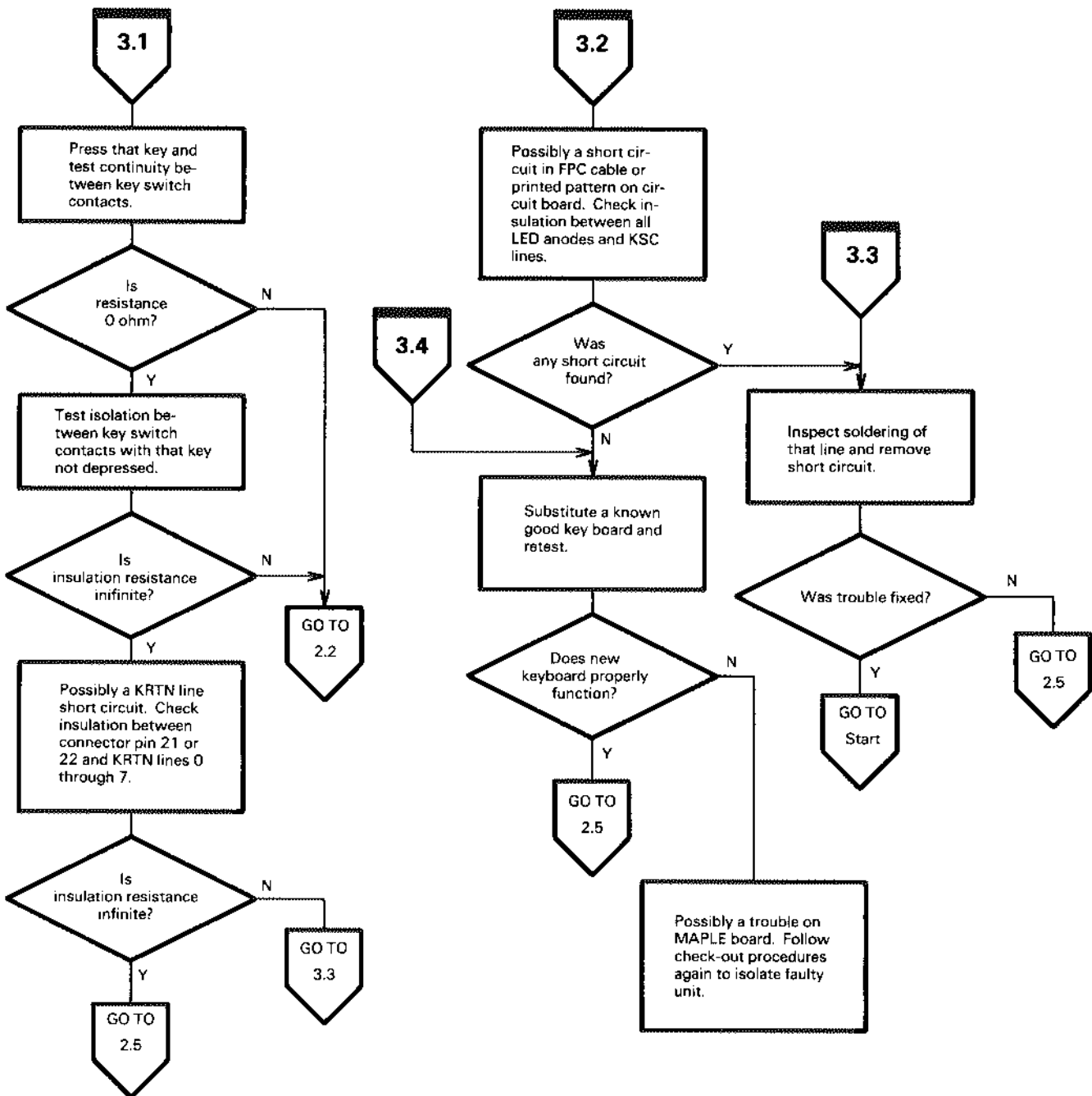

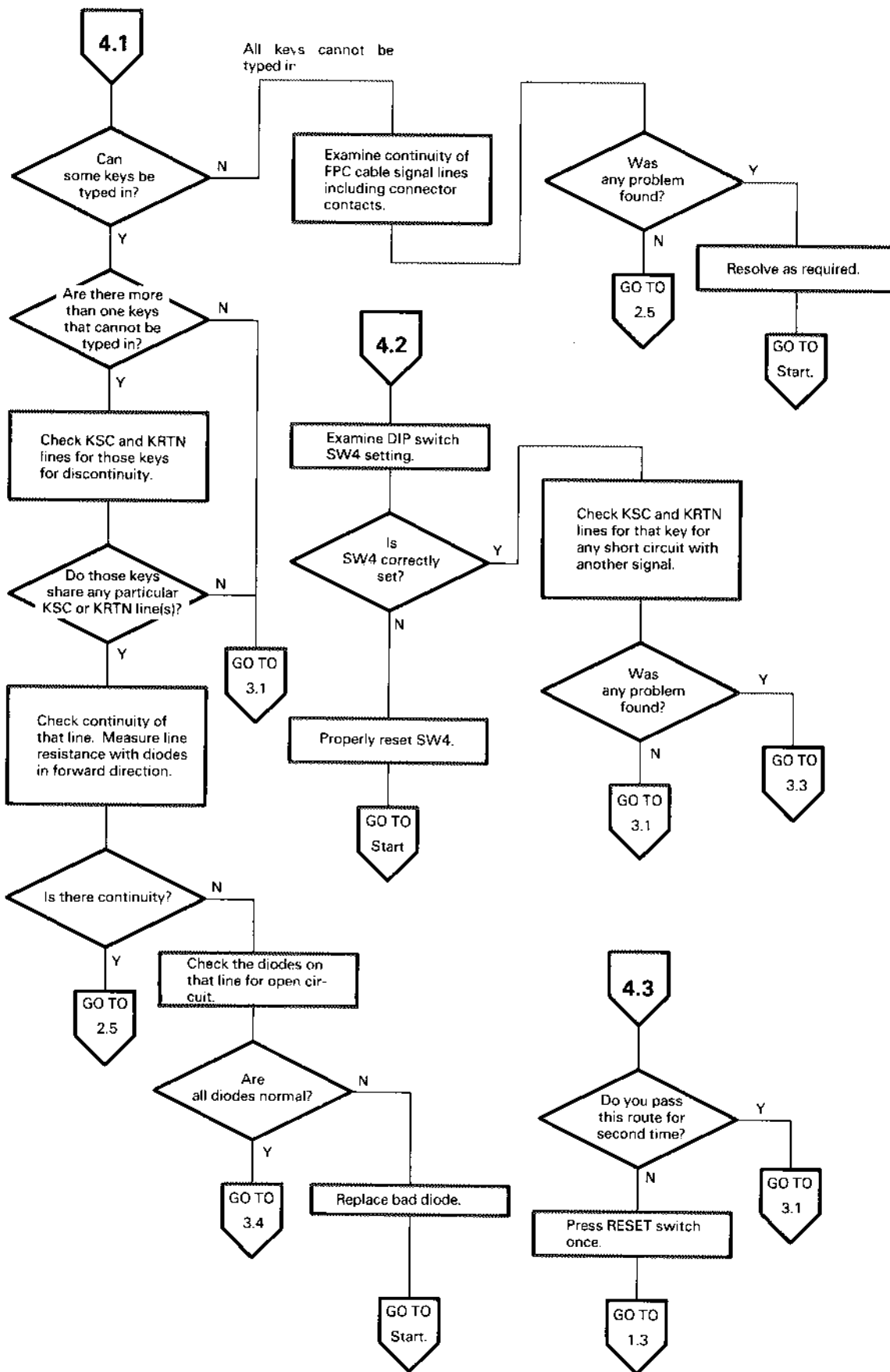

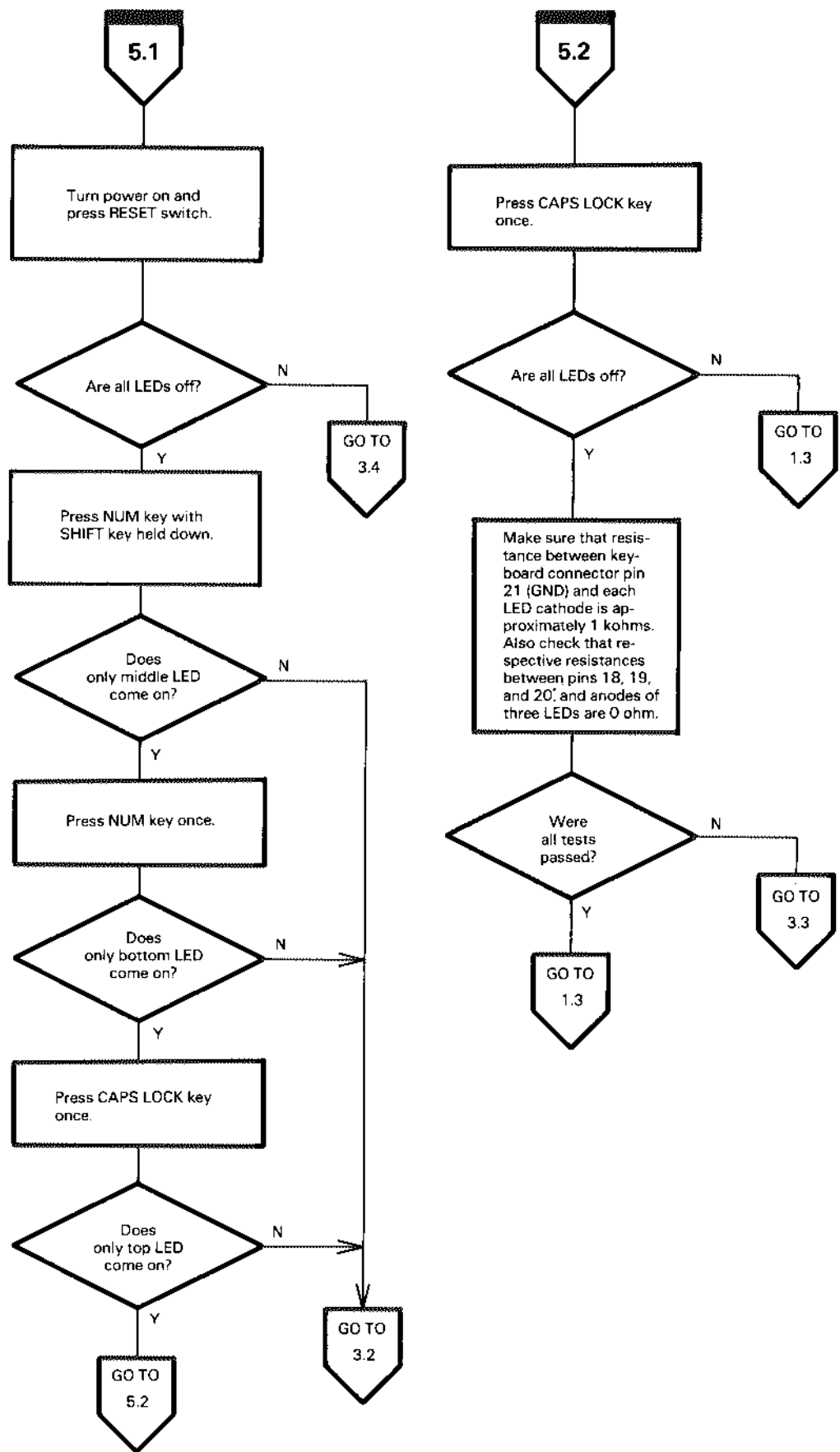

5.4.4 Repairing The Microcassette Tape Drive Unit

Before repairing the microcassette tape drive unit, check the following:

- 1) Check the read/write and pinch roller for dirt.
- 2) Exchange the microcassette tape for known good one and test to make sure malfunction is not due to a damaged tape.
- 3) Make sure that the lead wires from the mechanical section are perfectly soldered.
- 4) Examine the error message on the LCD panel to find whether the trouble is a directory-related problem. Tapes written by other computers may contain no directory and cannot be read by this computer.

Problems 1) and 2), above, are interrelated so that both the checks should be performed at the same time.

MICRO CASSETTE UNIT REPAIR ENTRY TABLE

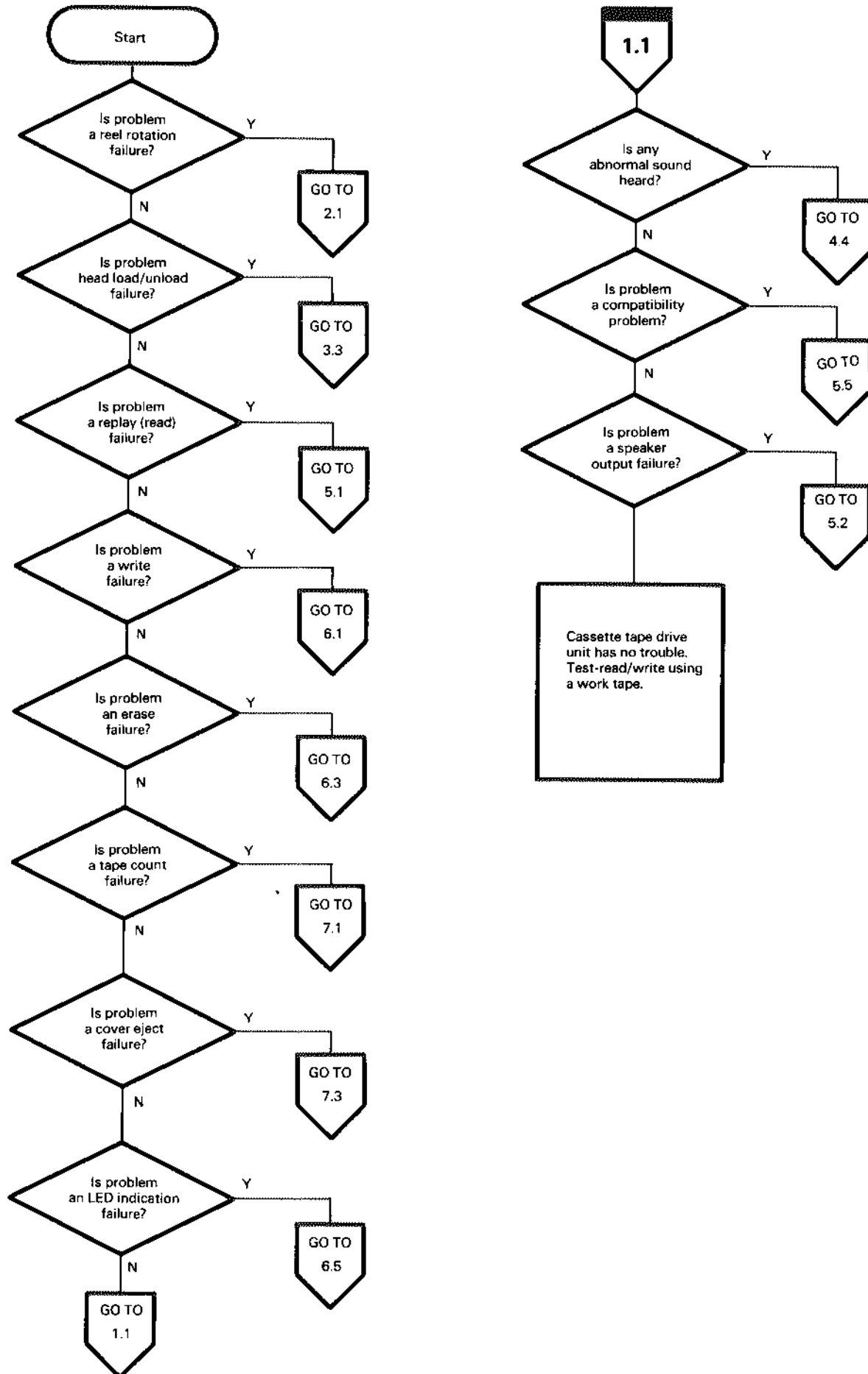

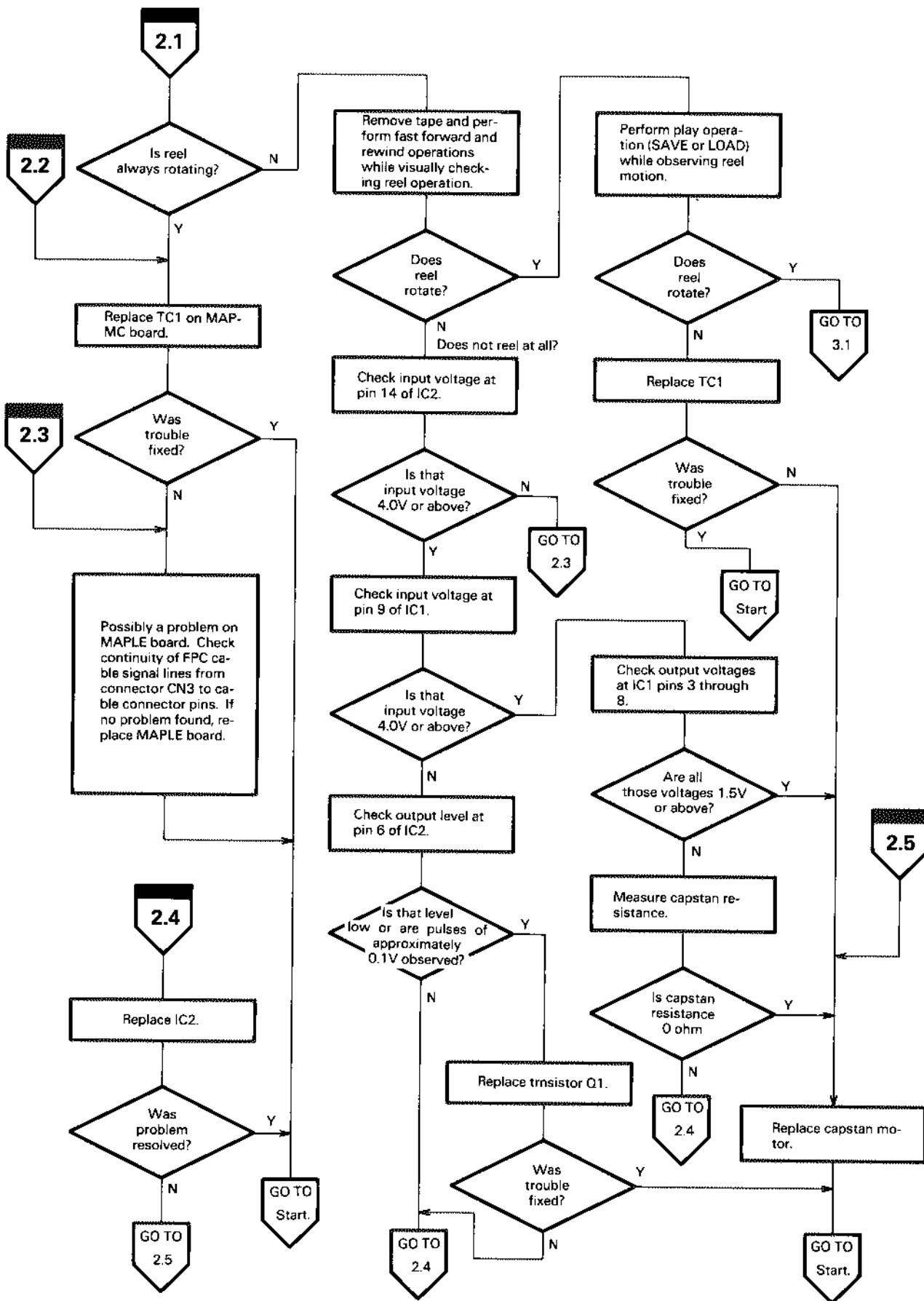

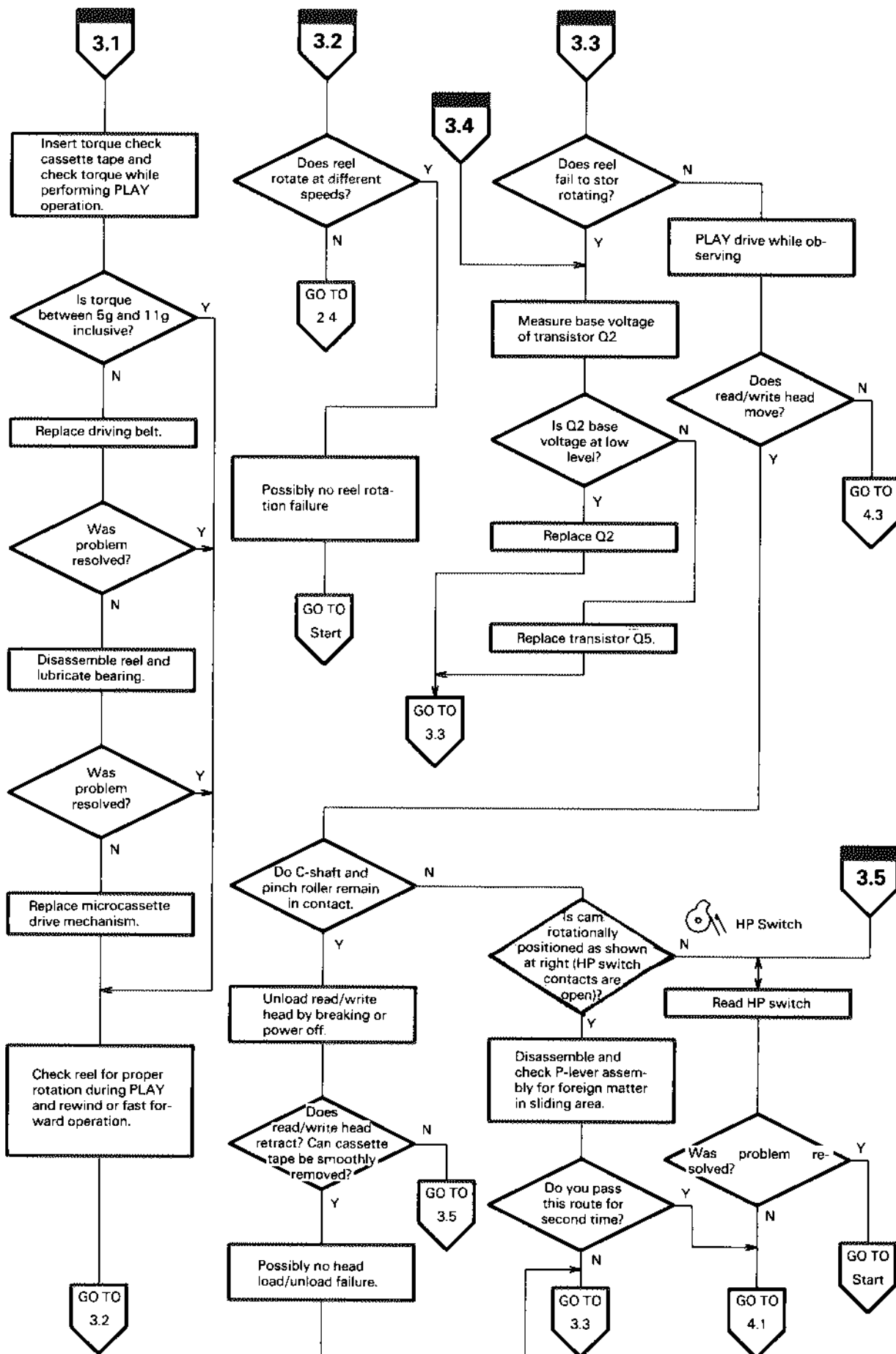

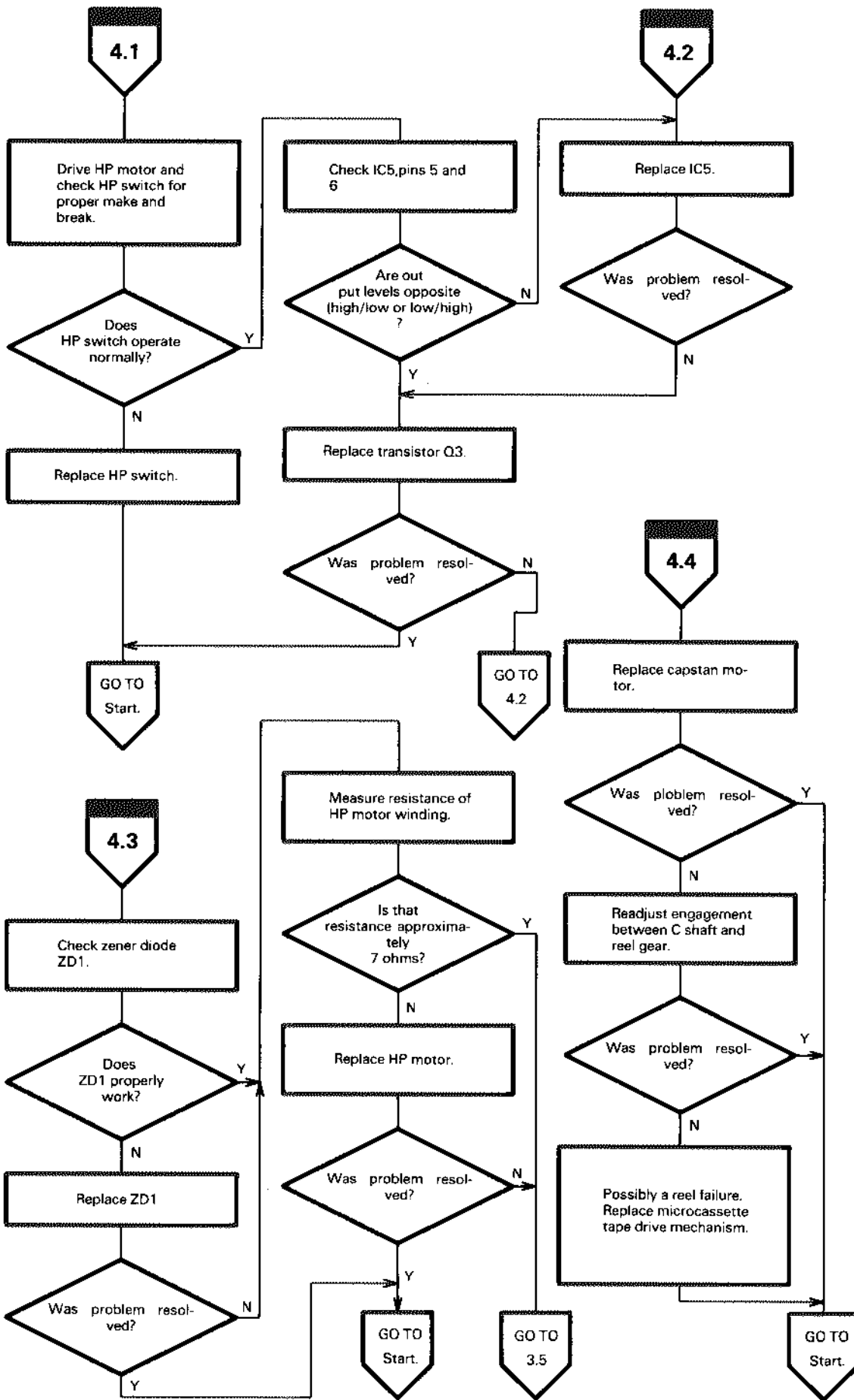

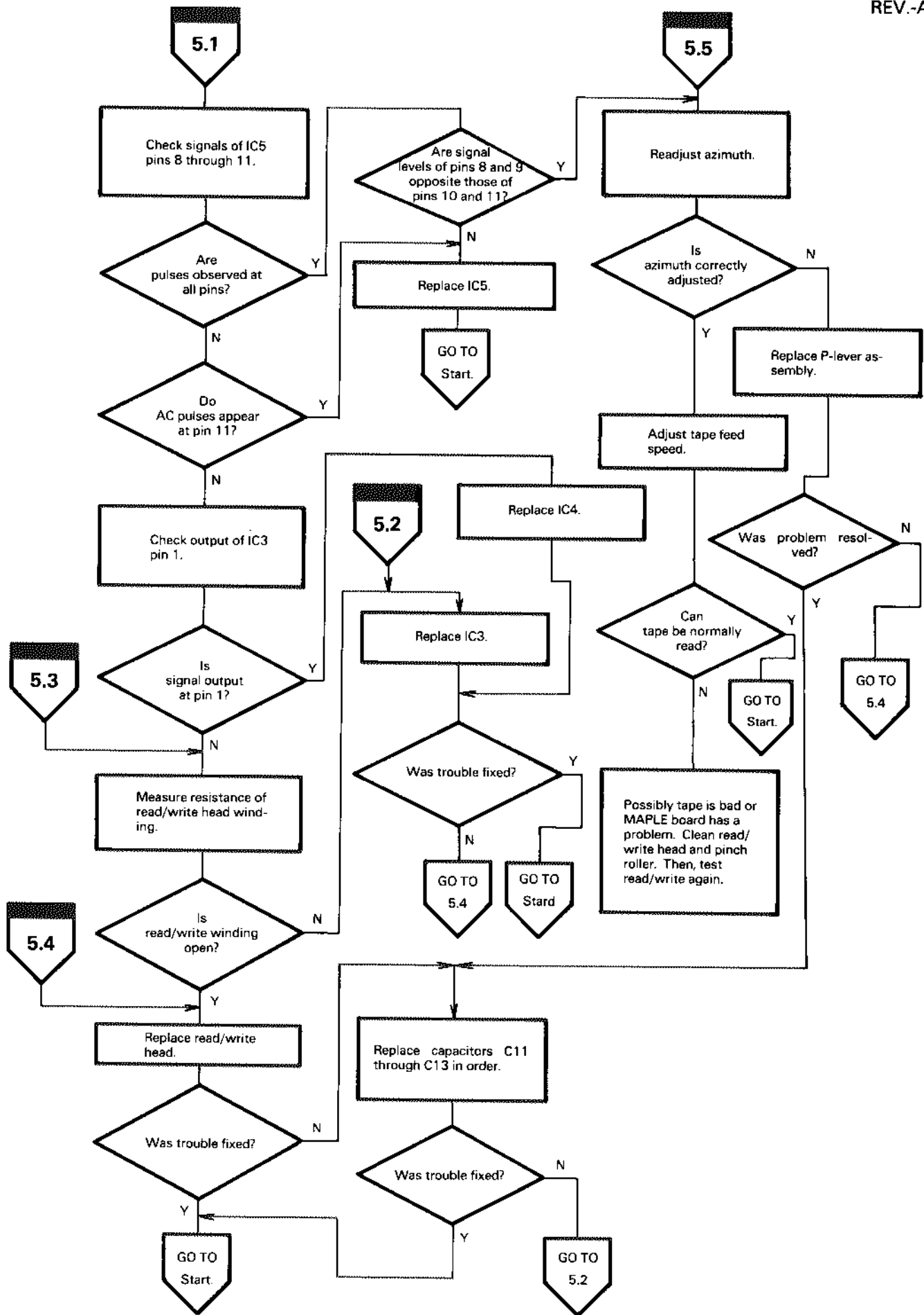

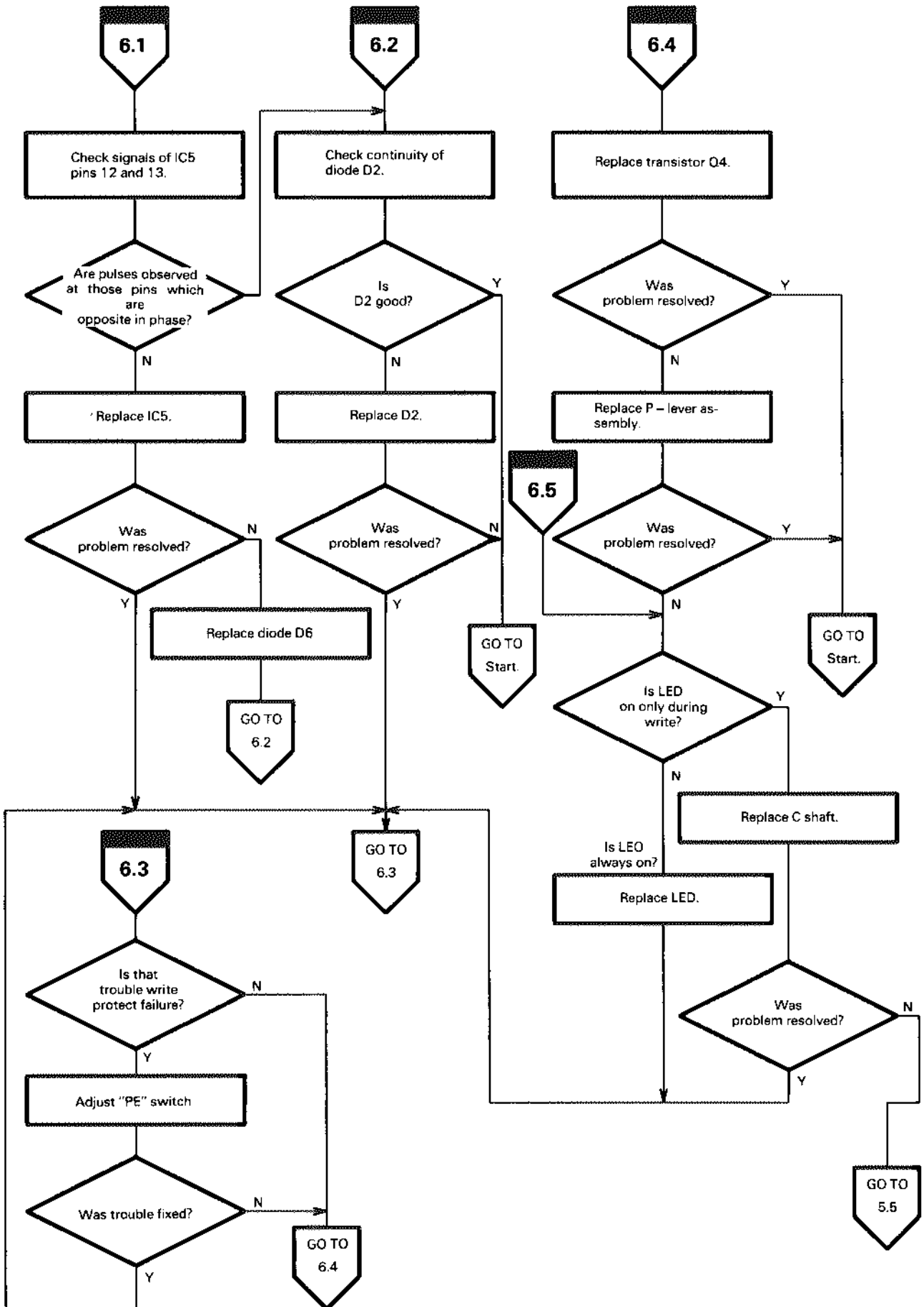

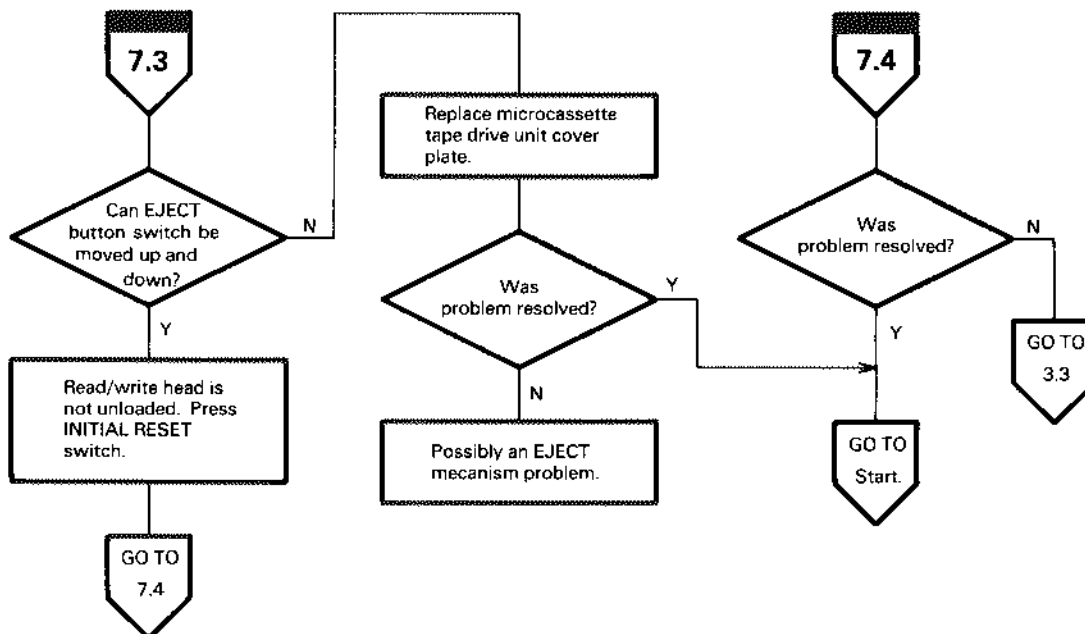
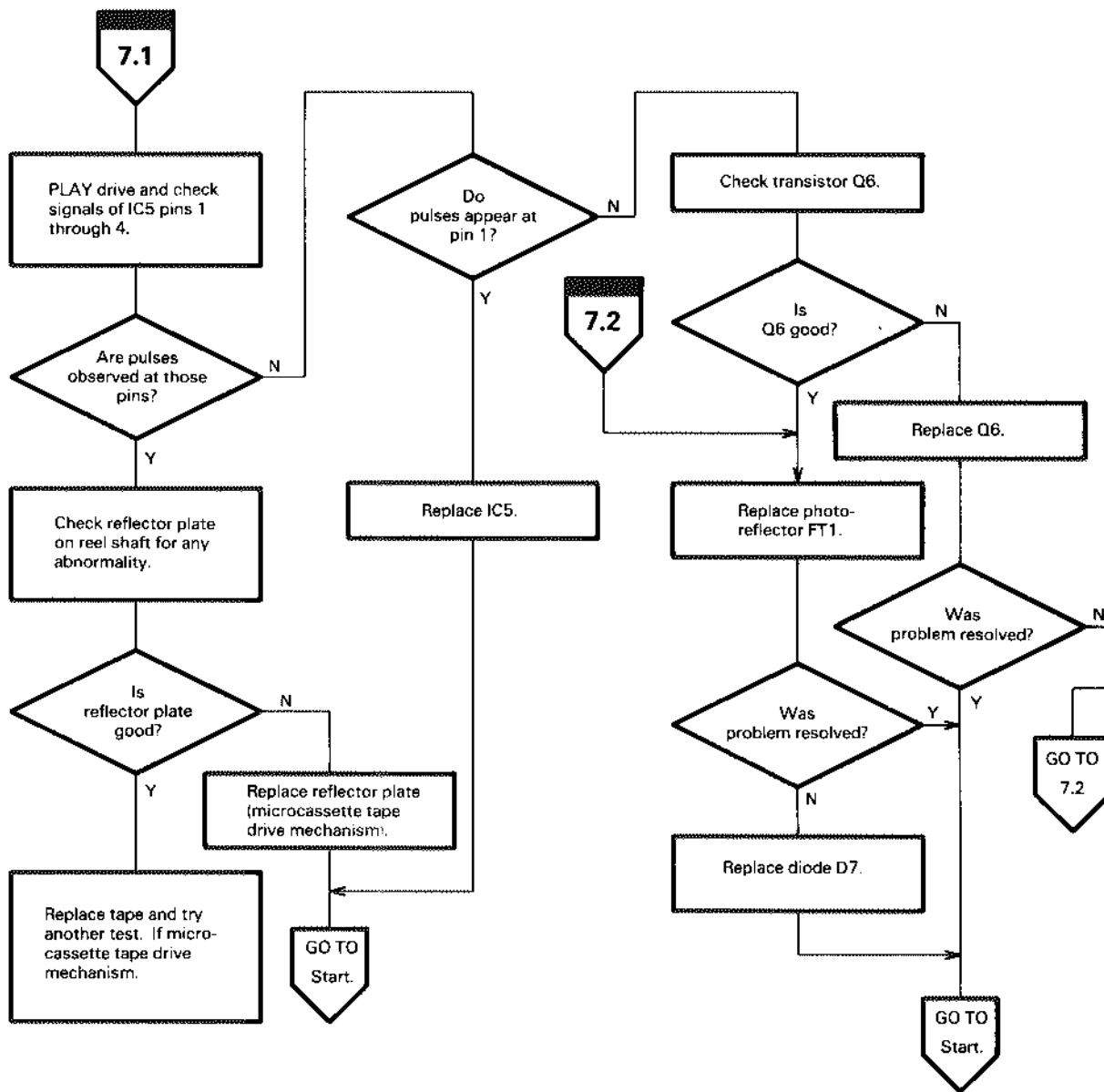

How to adjust the HP switch

Before mounted

1. Nominal separation: approximately twice the fixed spring plate thickness - 0.35 ± 0.1 (Unit: mm)

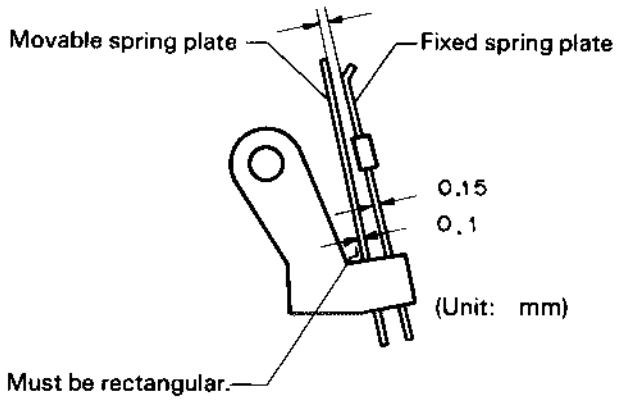

After mounted

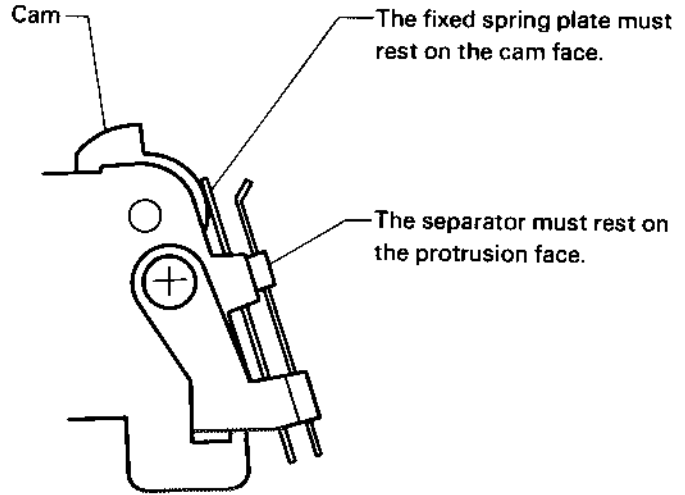

How to adjust the PE switch

(1) Mounting position

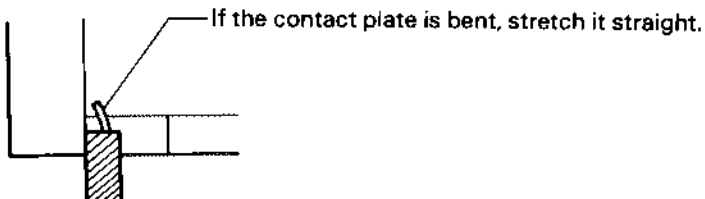
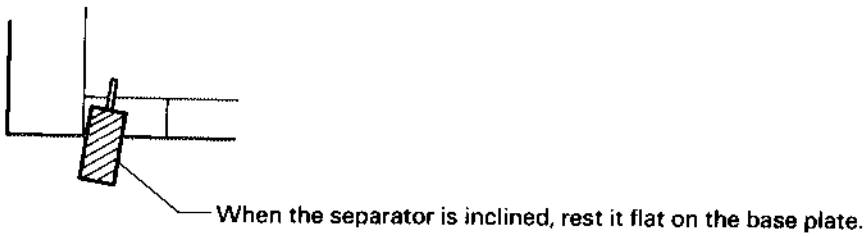
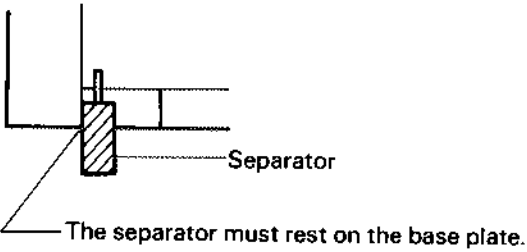

(2) Inspection

(a) When a MIN cassette tape is inserted.

(Unit: mm)

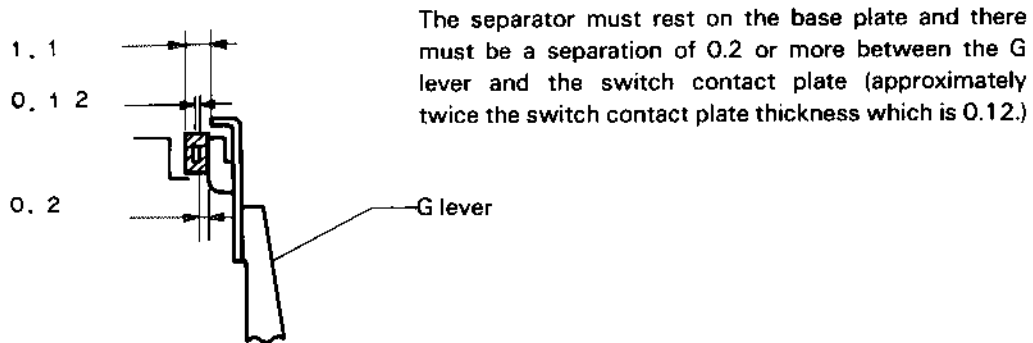

(b) When a rug-bent cassette tape is inserted.

(Unit: mm)

