

DO NOT DESTROY



WARRANTY REGISTRATION CARD

**IMPORTANT—WARRANTY
INFORMATION**

**TO BE ELIGIBLE FOR
WARRANTY SERVICE THIS
WARRANTY REGISTRATION
CARD MUST BE MAILED TO
ESI WITHIN 10 DAYS
OF DATE OF PURCHASE.
ONLY REGISTERED UNITS
WILL RECEIVE WARRANTY
SERVICE.**

**FOR SERVICE
CALL 800-645-5300
NEW YORK STATE
(6)293-5775**

Terminal Serial Number _____

Date Purchased _____

Company Name _____

Address _____

City _____

Contact/phone _____

**WARRANTY REGISTRATION CARD
APPLIES ONLY TO END USER
AND DISTRIBUTOR/OEM PURCHASERS
WITHIN THE UNITED STATES**

CUSTOMER COPY.

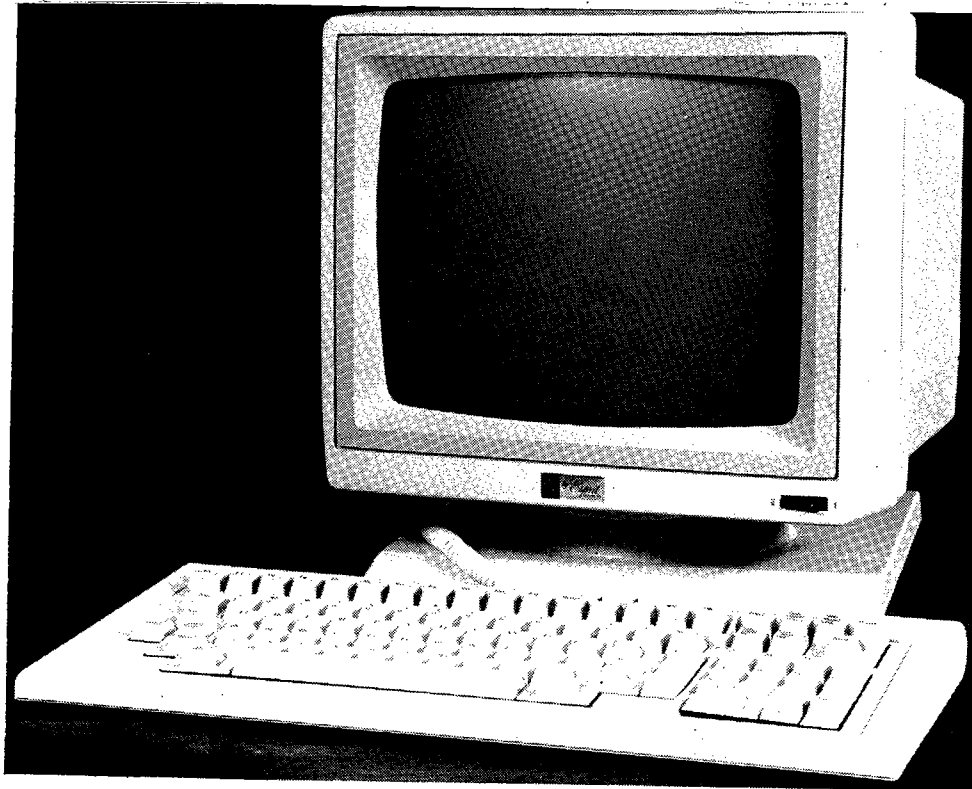

SAFETY SUMMARY

WARNING

Dangerous voltages (13,500 vdc, 600 vdc, and 100 to 240 vac) are present in the Video Display Terminal. Some voltage may remain present in monitor circuits after power is removed. Use caution when working on internal circuits. Do not work alone.

The terminal power cord should always be unplugged before the cover is removed. Use caution when handling the cathode-ray tube (e.g., wear safety goggles) to avoid risk of implosion. The internal phosphor coating is toxic; if the tube breaks and skin or eyes are exposed to phosphor, rinse with water immediately and consult a physician.

FCC NOTICE

This equipment generates and uses radio frequency energy and if not installed and used properly, i.e., in strict accordance with the instruction manual, may cause harmful interference to radio communications. It has been tested and found to comply with the limits for a Class A computing device, pursuant to subpart J of part 15 of FCC Rules, which are designed to provide reasonable protection against such interference when operated in a commercial environment.

Operation of this equipment in a residential area is likely to cause interference, in which case the user, at his own expense, will be required to take whatever measures may be required to correct the interference.

CONTENTS

| Section | | Page |
|---------|---|------|
| I | INTRODUCTION AND DESCRIPTION | 1-1 |
| | 1.1 INTRODUCTION | 1-1 |
| | 1.2 DESCRIPTION | 1-1 |
| II | INSTALLATION, SETUP AND TURN-ON | 2-1 |
| | 2.1 INSTALLATION | 2-1 |
| | 2.1.1 Voltage Setting | 2-1 |
| | 2.1.2 Attaching Pedestal to Console | 2-1 |
| | 2.1.3 Keyboard Connection | 2-1 |
| | 2.1.4 Input/Output Connection | 2-1 |
| | 2.2 TURN-ON AND SELF TEST | 2-7 |
| | 2.3 SETUP | 2-2 |
| | 2.4 USER MAINTENANCE | 2-8 |
| | 2.4.1 Troubleshooting | 2-8 |
| | 2.4.2 Cleaning | 2-8 |
| III | OPERATION | 3-1 |
| | 3.1 MODES OF OPERATION | 3-1 |
| | 3.1.1 Introduction | 3-1 |
| | Normal (Interactive) | 3-1 |
| | Monitor (Transparent) | 3-1 |
| | Local | 3-1 |
| | Block Page | 3-1 |
| | Line | 3-1 |
| | 3.1.2 Foreground/Background | 3-1 |
| | 3.2 KEYBOARD OPERATION | 3-2 |
| | 3.2.1 Introduction | 3-2 |
| | 3.2.2 Qwerty Cluster | 3-3 |
| | 3.2.3 Numeric Cluster | 3-5 |
| | 3.3 EMULATIONS | 3-7 |
| | 3.3.1 General | 3-7 |
| | 3.3.2 Limitations | 3-10 |
| | 3.4 VIDEO ATTRIBUTES AND GRAPHICS | 3-10 |
| | 3.4.1 Introduction | 3-10 |
| | 3.4.2 Field Attributes | 3-10 |
| | 3.4.3 Half Intensity | 3-10 |
| | 3.4.4 Graphics | 3-10 |
| | 3.4.5 Character Attributes | 3-11 |
| | 3.5 AUX PORT OPERATION | 3-11 |
| | 3.5.1 On Line with Display | 3-11 |
| | 3.5.2 On Line/No Display | 3-11 |

CONTENTS (Continued)

| Section | Page |
|----------|---|
| IV | REMOTE COMMANDS 4-1 |
| | 4.1 INTRODUCTION 4-1 |
| | 4.2 CURSOR CONTROLS 4-1 |
| | 4.3 EDITING COMMANDS 4-3 |
| | 4.4 MODE AND TRANSMIT COMMANDS 4-5 |
| | 4.5 AUXILIARY PORT COMMANDS 4-7 |
| | 4.6 KEYBOARD AND MISCELLANEOUS COMMANDS 4-8 |
| | 4.6.1 Loading Function Keys 4-10 |
| | 4.7 USER/STATUS LINE COMMANDS 4-10 |
| | 4.8 SCROLLING COMMANDS 4-10 |
| | 4.9 VIDEO ATTRIBUTE COMMANDS 4-11 |
| V | INTERFACE 5-1 |
| | 5.1 COMMUNICATIONS INTERFACE 5-1 |
| | 5.1.1 ASCII Code 5-1 |
| | 5.1.2 Asynchronous Data 5-1 |
| | 5.1.3 EIA Input/Output Connector 5-1 |
| | 5.1.4 Auxiliary Input/Output Connector 5-2 |
| | 5.1.5 Current Loop Interface 5-2 |
| | 5.1.6 Hardwired Interface 5-2 |
| | 5.1.7 Interactive Full Duplex Operation 5-3 |
| | 5.1.8 Half Duplex Operation 5-3 |
| | 5.1.9 Block Mode Operation 5-4 |
| | 5.2 FLOW CONTROL 5-4 |
| | 5.2.1 Host to Terminal 5-4 |
| | 5.2.2 Terminal to Host 5-4 |
| | 5.2.3 Terminal to Aux 5-4 |
| | 5.2.4 Host to Aux 5-5 |
| | 5.3 EXPANSION CAPABILITIES 5-5 |
| | 5.3.1 Internal Modem 5-5 |
| | 5.3.2 External Video 5-5 |
| Appendix | Page |
| A | ASCII CODE A-1 |
| B | CURSOR ADDRESS TABLES B-1 |
| C | SUMMARY OF REMOTE COMMANDS C-1 |

ILLUSTRATIONS

| Figure | | Page |
|--------|--|------|
| 2-1 | Attaching Pedestal to Console | 2-1 |
| 2-2 | Keyboard Connection | 2-1 |
| 3-1 | Terminal Modes of Operation | 3-2 |
| 3-2 | Keyboard | 3-3 |
| 5-1 | Rear of Terminal | 5-1 |
| 5-2 | Current Loop Interface | 5-4 |
| 5-3 | Main Port and Auxiliary Port Signal Flow | 5-6 |

TABLES

| Table | | Page |
|-------|--|------|
| 1-1 | Technical Characteristics | 1-2 |
| 2-1 | Status Line Fields | 2-2 |
| 2-2 | Menu Screens | 2-3 |
| 3-1 | Functions Key Code Transmission | 3-4 |
| 3-2 | Numeric Cluster Function | 3-5 |
| 3-3 | Interactive Mode Cursor Movement and Clear Operations | 3-8 |
| 3-4 | TeleVideo/ESP 6310 Keyboard Differences | 3-9 |
| 3-5 | Recommended Setup Selections for Existing Applications | 3-11 |
| 5-1 | EIA Interface | 5-2 |
| 5-2 | Auxiliary Interface | 5-3 |



Section I

INTRODUCTION AND DESCRIPTION

1.1 INTRODUCTION

The ESP 6310 Video Display Terminal combines microprocessor and large scale integrated circuit technologies to provide an exceptionally versatile instrument with outstanding ergonomic features. Its ball and socket tilt and swivel, 14-inch non-glare screen, menu Set-Up mode, and low profile sculptured keyboard make the terminal comfortable and easy to use. The ability to emulate several popular terminals permits its use with existing programs while allowing upgrading to use the additional features provided.

Highlights of the emulations included and features added:

Eleven user-programmable function keys (22 functions with Shift) for up to 255 characters are provided in all emulations. Up to 88 characters may be stored in nonvolatile memory, and the keys can be programmed to transmit only, display only, or both. It also adds smooth scrolling, line drawing graphics characters, and the capability for expansion to four pages of display memory.

The ESP 6310 can be set up to emulate the Esprit/Esprit II/Hazeltine 1500 terminals. It adds the capability of operator selection and remote control of full video attributes (Reverse Video, High/Low Intensity, Blink, Underline, and Blank). Attribute selections do not occupy space in the display.

This terminal may also be set up to emulate the TeleVideo 925/910 Plus¹ terminals. It adds an optional selection of "Hidden Attributes" to these emulations.

It can be set up to emulate the Lear Siegler ADM3A² terminal, with provision for operator selection and remote control of video attributes.

It can also be set up to emulate the ADDS Regent 25/Viewpoint³ terminals with provision for multiple video attributes displayed simultaneously.

This manual describes the features and characteristics of the ESP 6310 Terminal:

Installation, setup and turn-on instructions are in Section II.

Data for operators, describing keyboard functions and modes of operation is in Section III.

Data for programmers describing the many remote commands is in Section IV.

Interface details for installation planning are in Section V.

Technical assistance or additional information may be obtained from:

ESPRIT SYSTEMS INC.
100 Marcus Drive
Melville, NY 11747

Telephone: (516) 293-5774

1.2 DESCRIPTION

The ESP 6310 terminal includes a high resolution video monitor, a detached keyboard with its own microprocessor to scan the keys, and two serial input/output ports. The two ports may be independently configured in Set-up mode and the auxiliary port may be configured by remote command. The technical characteristics of the terminal are summarized in table 1-1.

¹ Trademarks of TeleVideo Systems, Inc.

² Trademark of Lear Siegler

³ Trademarks of Applied Digital Data Systems

Table 1-1. Technical Characteristics (Sheet 1 of 2)

DISPLAY FORMAT

| | |
|------------------|---|
| Screen | 14-inch diagonal P31 green phosphor. |
| Display Area | 7-inch height by 9.4-inch width |
| Capacity | 80 characters perline by 24 lines plus 25th status/message line. |
| Character Format | 7 X 9 character in 9 X 12 window. |
| Cursor* | Block or underline, steady or blinking cursor can be selected in set-up mode. |
| Character Set | 128 Alphanumeric ASCII characters plus 15 line drawing graphics. |
| Refresh Rate* | 60 or 50 Hz, no interlace. |

INTERFACE

| | |
|---------------|--|
| Input/Output | EIA Standard RS232 or 20mA current loop at 50, 75, 110, 135, 150, 300, 600, 1200, 1800, 2400, 3600, 4800, 7200, 9600 or 19,200 baud* |
| Auxiliary I/O | RS232 with keyboard or remote output enable/disable |
| Parity* | Odd, Even, One (Mark), Zero (Space), or None. |
| Modes* | Half or full duplex interactive or batch. |

PHYSICAL/ENVIRONMENTAL DATA

| | |
|-------------|---|
| Dimensions | Console: 13.8" (350 mm) H, 13.6" (346 mm) W, 13" (335 mm) D, 21 lbs (9.5 kg) Keyboard: 1.7" (45 mm) H, 17.8" (452 mm) W, 7.6" (195 mm) D, 3.2 lbs (1.4 kg) |
| Power | 115 or 230 V, 50 or 60 Hz, 50 watts (170 btu/hr) |
| Environment | Operating: 10° to 40°C (50° to 104°F), humidity 5% to 95% non-condensing. Storage: 0° to 65°C (32° to 150°F) |

*Menu selection retained in nonvolatile memory

Table 1-1. Technical Characteristics (Sheet 2 of 2)

ADDITIONAL FEATURES

| | |
|---------------|---|
| Keyboard | Detached typamatic keyboard with 14 key numeric pad. Key click* selected or cancelled from keyboard. Menu selection of alternative layouts for National Character Sets. |
| Screen Saver* | The Terminal has provisions for blanking the screen except the status line if data is not received from either the keyboard or the I/O for a period of twenty minutes. Receipt of characters or commands from either the I/O or the keyboard after a screen blank has taken place will cause the display to be redisplayed with no loss of information. |
| Ergonomics | Tilt and swivel display, low profile keyboard, self test at power turn on. |

*Menu selection retained in nonvolatile memory

Section II

INSTALLATION, SETUP AND TURN-ON

2.1 INSTALLATION

2.1.1 Voltage Setting. After unpacking the terminal, check that it is set for the proper mains voltage. A slide switch on the bottom of the display console selects either 115 or 230 volt operation. To change the selection, remove the screw holding the security link, change the switch setting, and replace the security link on the other side of the switch.

The terminal is normally shipped with a U.S. standard 115 VAC power plug. For other power sources this may have to be changed. If so, replace the plug with an "Eagle" type 6-15P plug or equivalent Underwriters Laboratory listed device. The brown wire is the "hot" lead and the blue wire is neutral. Make sure the green lead is securely connected to the ground terminal of the new plug. This may already have been done by your dealer or distributor.

2.1.2 Attaching Pedestal to Console. To attach pedestal to console, place console on a sturdy flat surface with bottom facing out and protruding slightly over the edge. Place slotted center of pedestal over large tab of console and line up two smaller tabs on console with grooves on pedestal. Turn pedestal clockwise so that the two small tabs enter grooves. See figure 2-1.

2.1.3 Keyboard Connection. To connect the keyboard to the display console, orient the connector so that the small tab is toward the front of the terminal, and press the connector into the mating jack at the bottom left side (figure 2-2) until it latches in place.

2.1.4 Input/Output Connection. The two EIA standard RS 232 serial I/O connectors are located at the rear of the terminal. Connect the host computer, directly or through a data set, to the EIA/CL connector. A serial peripheral device, such as a printer, may be connected to the "AUXILIARY EIA" connector.

Interface details are provided in Section V.

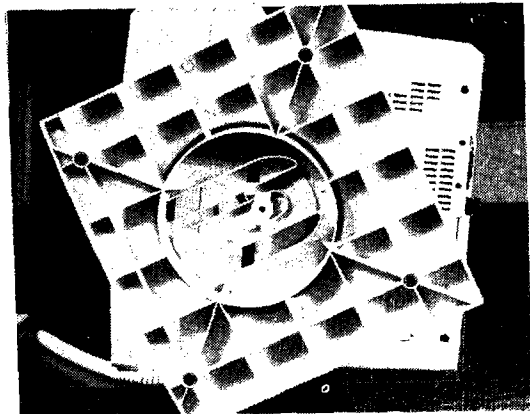

Figure 2-1. Attaching Pedestal to Console

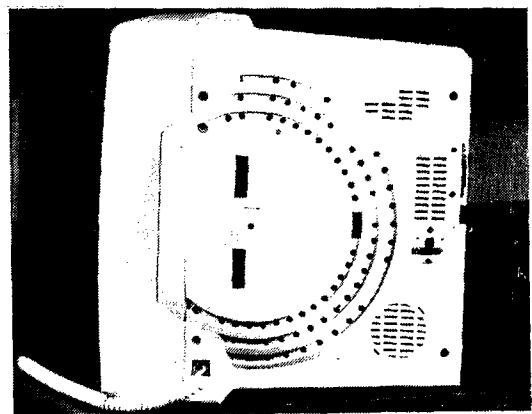

Figure 2-2. Keyboard Connection

2.2 TURN-ON SELF TEST

Power On Diagnostics

On power up, the CPU will write and then read from all RAM and accessible LSI registers in order to confirm proper operation. This operation takes less than five seconds and results in a failure number in the appropriate status line position if all tests are not passed successfully. No message will be displayed if all tests are passed

| | ROM ERROR | RAM ERROR | NVR ERROR |
|-------|-----------|-----------|-----------|
| ERR 1 | * | | |
| 2 | | * | |
| 3 | * | * | |
| 4 | | | * |
| 5 | * | | * |
| 6 | | * | * |
| 7 | * | * | * |

a. Place the terminal in the desired work area. Insure that air can circulate freely around the rear, base and top of the display console.

b. Plug the power cord into a properly grounded outlet. Do not use adapters that prevent the terminal from being properly grounded or a shock hazard may result.

c. Set the power switch at the rear of the terminal to ON. The terminal should sound a short beep and the red LED on the keyboard should come on. The terminal will automatically perform a memory test at this point. After a brief warmup, the steady block cursor should appear at the home position and the status line should be displayed with no error message. If the display fails to come on or an Error Message is displayed on the Status line, set the power switch to off, wait 30 seconds and set the power switch on ON again. If the fault recurs, the terminal is defective.

2.3 SETUP

Upon Power Up, the ESP 6310 Terminal defaults into the previously saved or factory programmed

setup mode. To make changes in setup mode, simultaneously depress the FUNC and SET-UP keys. The Status line is used to select configuration changes where protection of the display data is required. The status line fields used for this purpose are:

Communication mode (Half Duplex, Full Duplex or Block)
 Main Baud rate (50 to 19,200)
 Aux status (on/off)
 Aux baud rate (50 to 19,200)
 Line mode (On Line/Local)
 Monitor mode (on/off)

These fields are defined in table 2-1. To select a status line field, move cursor left or right to the desired field then depress the T key to step through the field. Once the Status line changes are made, the operator has the option of performing a SAVE operation which automatically exits the SETUP mode, depressing the ENTER key which will display the three setup menu screens or exiting Setup mode by depressing FUNC and SETUP simultaneously. Alternately depressing the ENTER key causes the display to alternate between the three

Table 2-1. Status Line Fields

| FIELD FUNCTION | MESSAGES |
|----------------------------|---|
| 1. Cursor location | Pc RaaCbb aa=Row position 0-23 bb=Column position 0-79 cc=Page 1-4 |
| 2. Diagnostics | ERR n(1-7) Blank Field |
| 3. Transmission in Process | Send Blank Field |
| 4. Main port status | MPT busy Blank Field |
| 5. Communication Mode | HD FD Blk |
| 6. Baud Rate | 50 through 19200 |
| 7. Aux Status | Aux On Aux Off Aux Busy BDir |
| 8. Aux Baud Rate | 50 - 19,200 |
| 9. Mode | Local On Line |
| 10. Monitor Mode | Mont Blank Field |
| 11. Insert Char | InsCh Blank Field |
| 12. Keyboard Lock | KBlock Blank Field |

setup menu screens. These screens are described in table 2-2. Depressing keys 0 through 9 on the numeric keypad or F1 through F10 sequentially steps through the available settings. For example: by alternately depressing key 0 on the numeric pad in screen 1, the operator will see HAZ, TVI 925, ADM3A, VP/R25. Once the desired features have been selected, the terminal will function per the new configuration. The new configuration will be considered temporary unless a SAVE operation is performed. If the set-up mode is exited without a SAVE (by FUNC/SETUP) operation, the terminal will default to the previously saved characteristics on reset or power up. The SAVE operation is used to store all current set-up features and is performed by a shift/ENTER.

NOTES

1. Contrast can be adjusted in setup mode using the cursor up and cursor down keys.
2. Care must be taken as to when a save is performed in Setup mode. Many of the Setup selections, including the function key contents, can be temporarily changed by remote command. If a "save" is performed after changes have been made by an application program, all conditions currently in effect will be saved. As a rule, it is best to setup and save the desired selections immediately after turning on the terminal and before any program has been run.

Table 2-2. Menu Screens (Sheet 1 of 5)

SCREEN #1

| | | |
|-------------------------|--------|--------|
| EMUL | HAZ | 0 |
| AUTO WRAP | ON | 1 |
| CLICK | OFF | 2 |
| EOM | CR | 3 |
| AUTO LF | ON | 4 |
| SCROLL | JMP | 5 |
| TAB | FLD | 6 |
| HIDDEN FIELD ATTRIBUTES | OFF | 7 |
| RTS CNTRL | ON | 8 |
| KEYBOARD EDIT | DUPLEX | 9 |
| UNPROT. CHAR. ATT. | HI | F1-F5 |
| PROTEC. CHAR. ATT. | NONE | F6-F10 |
| NEXT MENU | | ENTER |

SCREEN #2

| | | |
|-----------------|--------|-------|
| STATUS LINE | ON | 0 |
| CURSOR | BLOCK | 1 |
| PAR | ODD | 2 |
| WORD LN | 7 | 3 |
| XON/XOFF | OFF | 4 |
| LANG. | U.S.A. | 5 |
| FREQ. | 60 | 6 |
| VIDEO | NORM | 7 |
| LEAD-IN | TILDE | 8 |
| SCREEN SAVER | OFF | 9 |
| STOP BIT | 1 | F1 |
| VIDEO ATTRIBUTE | PAGE | F2 |
| NEXT MENU | | ENTER |

SCREEN #3

| | | |
|-------------------------|--|---------|
| ANSWER BACK | | 0 |
| TAB | | 1 |
| RESET ALL FUNCTION KEYS | | SHIFT 2 |
| FUNCTION KEY MESSAGES | | F1-F22 |
| NEXT MENU | | ENTER |

Selections shown in above menus will be the default conditions shipped from the factory.

Table 2-2. Menu Screens (Sheet 2 of 5)

Screen #1

EMUL (0) - Depressing key 0 on the numeric pad sequentially steps through the available emulations.

ADM3A - (LEAR SIEGLER ADM3A)

TV1925 - (TELEVIDEO 925)

VP/R25 - (ADDS VIEWPOINT/REGENT 25)

HAZ - (HAZELTINE 1500/ESPRIT/ESPRIT II)

Auto Wrap (1) - The cursor will automatically wrap around from the last column of the display to the first column of the next line.

CLICK (2) - Key click on or off

EOM (3) (End of Message) - The selected character (CR ETX EOT or NUL) will be added at the end of each batch transmission.

Auto LF (4) - When enabled in SETUP, each carriage return causes the terminal to perform a line feed also (new line) eliminating the need to type both RETURN and LF. Line feeds are ignored. If not enabled, carriage returns move the cursor to the start of the present line, and line feeds move it down.

Scroll (5) - JMP (JUMP), SM (SMOOTH)

TAB (6) - FLD Field tab
- COL Columnar tab

Hidden Field Attribute (7) - This feature should be OFF for precise TV1925 emulation, causing a space to be displayed for each new field attribute. When this feature is ON, attribute command will not take up display positions. Character attributes are always hidden.

Valid in TV1925 mode only

RTS CNTRL (8) - On-interactive modes - Raise and lower Request to send on each transmitted character.

Off-interactive modes - Request to send held high.

Keyboard Edit (9) - Local Edit function keys will be performed locally with no transmission

- Duplex Edit function keys transmit command sequence only

Table 2-2. Menu Screens (Sheet 3 of 5)

Screen #1 (continued)

Unprotected Character Attributes (F1-F5) - Blink/Reverse/High Intensity/
Underline/Blank - any combinations.

| | | |
|-----------|----|-----------|
| Blink | F1 | on or off |
| Reverse | F2 | on or off |
| High Int | F3 | on or off |
| Underline | F4 | on or off |
| Blank | F5 | on or off |

Protected Character Attributes (F6-F10) - Blink/Reverse/High Intensity/
Underline/Blank - any combinations.

| | | |
|-----------|-----|-----------|
| Blink | F6 | on or off |
| Reverse | F7 | on or off |
| High Int | F8 | on or off |
| Underline | F9 | on or off |
| Blank | F10 | on or off |

Screen #2

Status Line (0) - Display/Blank

Cursor (1) - Block/BLK Block/Underline/BLK Underline/BLANK

Par (2) - Parity - Odd, even, mark(1), space(0), none

Word Length (3) - 7 bits, 8 bits

XON/OFF (4) - OFF - Disabled
ON - Enabled

LANG (5) - Provides the optionally available national character set keyboard
layouts

SWD - Sweden

NOR - Norway

FR - French

DN - Denmark

GER - Germany

US - United States

SP - Spanish

FREQ (6) - (Refresh Rate) Should normally be 60 Hz. However, if the local power
frequency is 50 Hz, interference from nearby equipment may cause waviness in
the display. In this case, a better display may be obtained by selecting 50 Hz.

VIDEO (7) - NORM - Normal, REV - Reverse video

Lead-In (8) - ESC, Tilde

Screen Saver (9) - On or off

STOP BIT - 1 - One stop bit
2 - Two stop bit

Video Attributes - In field attribute mode only, this selection determines whether
an attribute selection propagates to end-of-line or end-of-page in the absence of
another attribute selection.

Table 2-2. Menu Screens (Sheet 4 of 5)

Screen #3

Answer Back - The answer back message will automatically be transmitted in response to an ENQuiry character (05 Hex or Decimal).

Answer back (O) - Results in A = at first position on 24th line of display. Keyboard entry of up to 16 characters. The load operation will terminate automatically on entry of the 17th character or depression of ENTER. The SAVE operation will be done, if desired, by depressing SHIFT-ENTER on returning to the setup menu.

Tab (1) - Causes the screen presentation shown in figure 3-3 to be displayed.

The location of each columnar tab stop is indicated by a "T" in figure 3-3.

All tab stops may be cleared by depressing the shift tab key. To set or clear tab stops on an individual basis the following procedure is used:

1. Position the cursor, using tab and cursor control keys, to the tab stop to be set or cleared.
2. Depress the "T" key to select/clear the tab stop at the cursor location.

Subsequent depressions of the "T" key will alternately CLEAR/SET the tab at the cursor location.

NOTE

Tab stops indicated by "T" apply in column mode only. Tab set up mode is exited by depressing the ENTER key on the keyboard, which will load but not save columnar tab selections. SHIFT-ENTER in setup menu will save tab selections. Preprogrammed columnar tab stops in Esprit II mode will continue to be the default condition (increments of 8 positions).

T T T T T T T T
1234567890123456789012345678901234567890123456789012345678901234567890123...

Tab SET-UP

RESET ALL FUNCTION KEYS (SHIFT-2) Will clear all previously stored function key messages.

Function key messages (F1-F22) - In addition to the remote programmable function key operation as defined in Section IV, the ESP6310 will support nonvolatile function keys with a memory pool of 88 characters. The partitioning of the memory pool can be in any combination as long as the memory pool is not exceeded. The default message for any function key will be the operator selected sequence if a save operation has taken place. Function keys which are not programed will generate the default sequences as defined for the selected emulation.

The operator will enter function key message load by depressing the desired function key (F1-F22 with F12-F22 corresponding to shifted F1-F11 respectively). The F number will be displayed. The operator will then enter in sequence the

Table 2-2. Menu Screens (Sheet 5 of 5)

Screen #3 (continued)

required characters which will be displayed as if the terminal was in monitor mode. Correction of errors will be done by exiting the load operation and re-entering the message. Termination of an individual function key message load will be done by depressing ENTER. Any number of function keys can be loaded as long as the nonvolatile memory pool is not exceeded. Depression of SHIFT-ENTER will save the desired messages after return to screen 3. As shown in the following table entries can be local and/or I/O.

$F_{n_1} = (n_2)ABC.....$

$n_1 = 1-22$

$n_2 = 1$ -transmit only

2-local only

3-both (half duplex)

There is no need for entry of DLE to enter control codes.

2.4 USER MAINTENANCE

WARNING

Repair or adjustment of internal components should be performed only by a qualified technician.

Dangerous voltages (13,500 VDC, 600 VDC, and 100 to 240 VAC) are present in the terminal. Some voltage may remain present after power is disconnected.

The internal phosphor coating on the cathode ray tube is toxic; if skin or eyes are exposed to phosphor due to a broken tube, rinse with water immediately and consult a physician.

2.4.1 Troubleshooting. If the unit fails to turn on (beep does not sound and red LED on keyboard does not light) check the following:

- Power cord connected to a working outlet and power switch on.
- Fuse not blown.

The fuse holder is at the bottom rear of the terminal. Use only a 1A, 250V type 3AG fuse. Use of a higher rated fuse may cause damage to the terminal. If the unit comes on with no error message but fails to operate properly, check the following:

- Connectors at rear of terminal are tight.
- If possible, substitute another terminal to insure that the problem is not in the interface.

2.4.2 Cleaning. The exterior of the terminal may be cleaned by wiping it with a damp cloth. The CRT may be cleaned with a household glass cleaner.

Section III

OPERATION

3.1 MODES OF OPERATION

3.1.1 Introduction. The Esprit ESP 6310 terminal has three modes of operation which apply to all emulations and two which apply to Hazeltine Esprit II emulation. The three are:

Normal (Interactive) in which keyboard data is transmitted when entered, and in half duplex, is displayed if character data and performed if a command. In full duplex, only received or echoed data is displayed acted upon. Received control characters ignored except for valid remote commands.

In normal mode the emulation selected from menu screen 1 in setup mode (paragraph 2.2) determines the characteristics of the terminal. When HAZ emulation is selected, it is an enhanced emulation of the Hazeltine 1500.

When Televideo, ADM3A or Regent 25 emulation is selected the remote command set for the selected terminal applies.

Monitor (Transparent) in which all characters, including control codes, are displayed. Control characters display as a two character mnemonic in a single character window (Appendix A). The only function which is executed is a Carriage Return, which is both displayed and performed. Auto Line Feed must be selected in setup to use this mode. It may also be necessary to select Auto New Line (wraparound) to prevent data from overrunning the line length.

Local mode, in which received data is ignored and keyboard data is displayed but not transmitted. Local may be Normal (commands executed and control characters ignored) or Monitor (control characters displayed as described above).

The two modes applicable to Hazeltine only are:

Block/Page in which keyboard data is stored but not transmitted until the ENTER key is depressed

with or without SHIFT. ENTER causes all foreground data on the display to be transmitted. SHIFT/ENTER causes all data in the foreground field the cursor is in, to be transmitted.

This is a partial emulation of the Hazeltine 1510/1520 "Format" mode.

Line is a special case of block mode in which keyboard data is stored, and all foreground data on the line the cursor is on, is transmitted when either RETURN or ENTER is depressed. This is a partial emulation of the Hazeltine 1510/1520 "Format/Line Transmit" mode.

If one of the "Keypad Function Modes" described in paragraph 4.6 is used, the numeric pad keys become an exception. A special sequence is transmitted immediately and not displayed even though the terminal is in Block/Page or Line mode.

As shown in figure 3-1, there are limitations on changing operating modes. Local may be entered from normal or Monitor modes and will retain the characteristic (display control codes or not) but there is no Local/Block mode. Block/Page mode can only be entered when Hazeltine emulation is selected and Line mode can only be entered if the terminal is already in Block/Page mode. The remote "Reset Block Mode" command or "BLOCK" keyboard entry will return the terminal to Normal (interactive) mode from either Block/Page or Line mode.

As shown in figure 3-1, in Hazeltine Block mode, C₃ (must be 3 in qwerty pad, not numeric pad) places terminal in line mode. All foreground data on the line the cursor is on will be transmitted when RETURN, ENTER or SEND is typed.

3.1.2 Foreground/Background. All data on the display (including blank spaces) is classified as foreground fields for background fields.

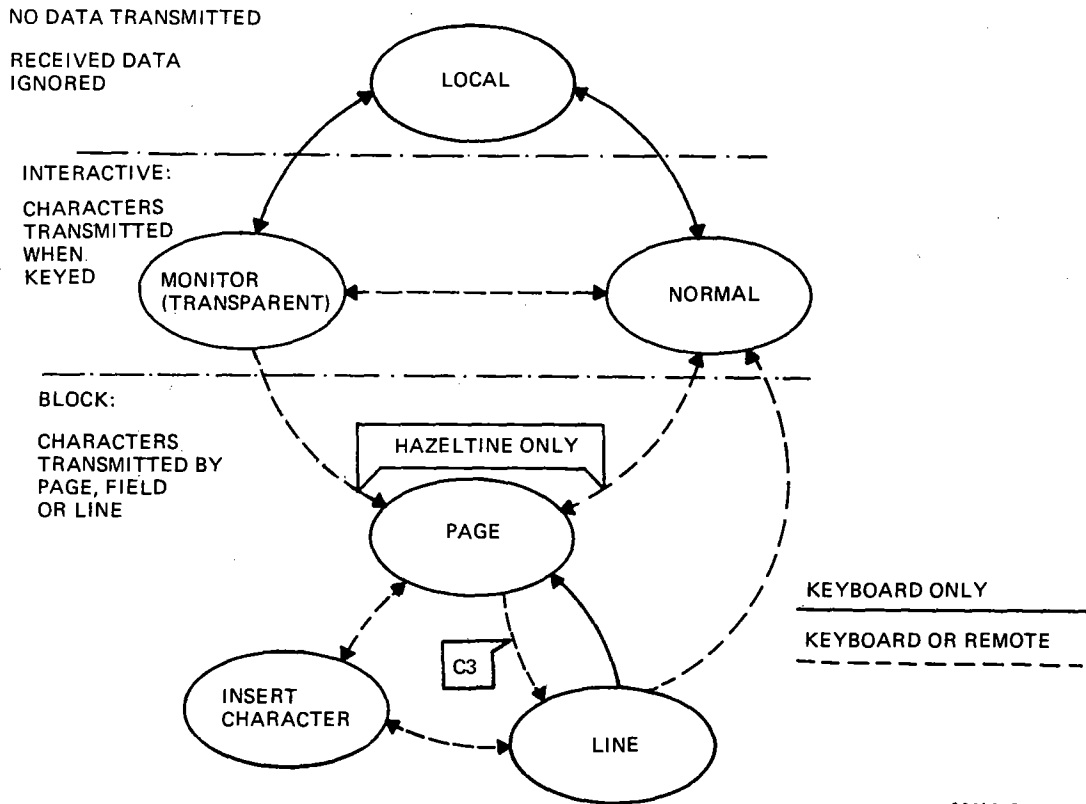

8204157

Figure 3-1. Terminal Modes of Operation

| Foreground | Background |
|--|---|
| Cleared by FGD CLEAR key or remote command | Not cleared keyboard or remote HGF CLEAR |
| Tabbed "to" by field tab | Tabbed "over" by field tab |
| Unprotected (can be overwritten from keyboard) | Protected (except in Normal mode) |
| Transmitted when batch transmission is initiated | Not transmitted when batch transmission is initiated. |

A "field" is any contiguous group of foreground data or background data. At turn-on or after a "clear screen", the display consists of one field of foreground spaces.

The foreground and background characters may be displayed in high intensity and/or underlined and/or reverse video as selected by set-up mode menu screens (paragraph 2.2). The terminal fills display with foreground spaces and defaults to the background follows state at turn on.

NOTE

A superscript ^C or ^S is used throughout this manual to indicate holding the CTRL and/or SHIFT key down while making an entry.

3.2 KEYBOARD OPERATION

3.2.1 Introduction. The keyboard contains 2 clusters, the Qwerty Cluster and the Numeric Cluster as shown in figure 3-2. The typewriter and cursor keys automatically repeat if they are held down for longer than 3/4 second. This feature is called the typamatic mode. Depression

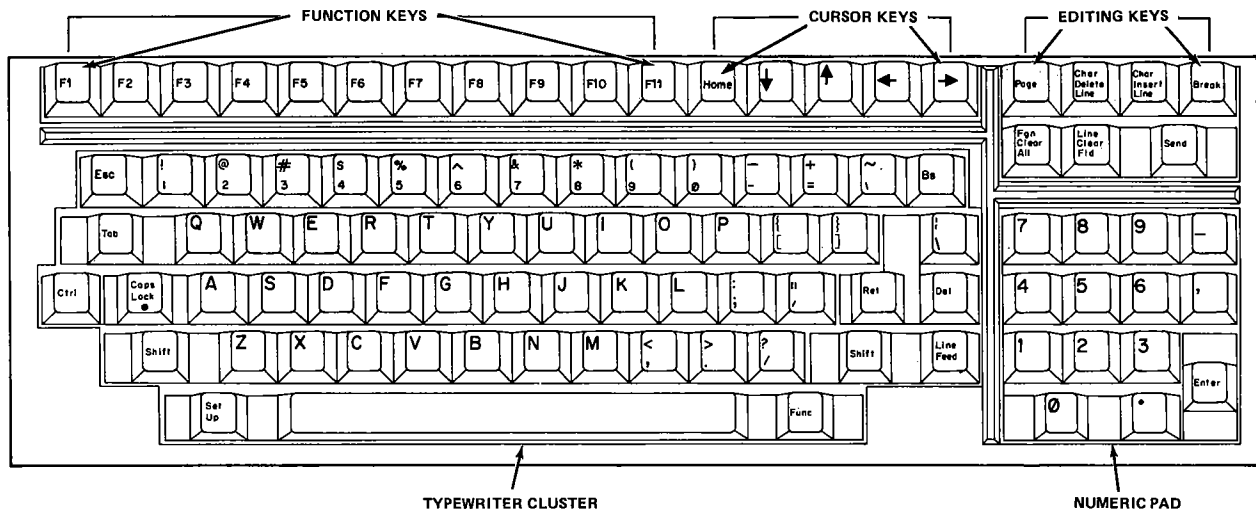

Figure 3-2. Keyboard

of an additional key while typamatic mode is in process will terminate typamatic mode and the new key depression will be processed in the normal manner.

3.2.2 Qwerty Cluster. The Qwerty Cluster consists of the typewriter, 11 function keys and the cursor keys. The typewriter portion of the keyboard is used to generate all 128 possible ASCII codes to be either displayed on the screen for editing in block modes or for direct transmission in interactive modes. Generation of the full ASCII code set is accomplished by depressing various combinations of the alphanumeric keys in conjunction with shift and or control keys. The configuration of the key stations as assigned to the ASCII table varies as a function of the country selected in the setup menu in Section II. The terminal will support (7) different arrangement of the alphanumeric keys in order to satisfy international requirements. The appropriate ASCII tables and keycap arrangements for the seven countries are shown in Appendix A. Depression of the caps lock key will cause the CAPS LOCK LED to be on until such time as the caps lock key is redepressed and this keyboard feature is disabled. The terminal has 11 pre-programmed function keys which will generate the multicharacter sequences defined in

table 3-1. These keys are not typamatic. As defined in the remote command section and in the set-up area, these 11 function keys can be programmed with any desired sequences. The function keys, depressed in conjunction with the shift key, allows for the generation of 22 unique sequences. Pre-programmed into the terminal will be 3 different combinations of the 22 sequences - the selections being accomplished by remote command. As described in the Remote Command section, these function keys when programmed shall transmit data through the I/O and/or display data to the display screen only. Function key transmission to the display or the I/O will be made independent of the communications mode of the terminal but will obey data I/O control sequences. As defined in Section II on Setup, the operator will have the ability to store alternate default conditions in non-volatile memory up to a maximum of 88 characters. The default character strings transmitted by the Function keys (Table 3-1) can be changed by entering Set-Up mode, advancing to menu screen #3, and then the following sequence:

| <u>Keystroke</u> | <u>Display</u> |
|--------------------|---|
| F key to be loaded | F# (1 to 11 without shift 12 to 22 with shift |

Table 3-1. Default Function Key Code Transmission

| <u>NORMAL</u> | <u>925 PLUS/ADM3A</u> | | | <u>ADDS</u> | | <u>HAZELTINE</u> | | | |
|--------------------|-----------------------|---|----|-------------|----|------------------|---------|---|----|
| F1 | SOH | @ | CR | STX | 1 | CR | LEAD-IN | @ | CR |
| F2 | | A | | | 2 | | | A | |
| F3 | | B | | | 3 | | | B | |
| F4 | | C | | | 4 | | | C | |
| F5 | | D | | | 5 | | | D | |
| F6 | | E | | | 6 | | | E | |
| F7 | | F | | | 7 | | | F | |
| F8 | | G | | | 8 | | | G | |
| F9 | | H | | | 9 | | | H | |
| F10 | | I | | | . | | | I | |
| F11 | SOH | J | CR | STX | , | CR | LEAD-IN | J | CR |
| <u>SHIFTED</u> | | | | | | | | | |
| F1 | SOH | ' | CR | STX | ! | CR | LEAD-IN | | CR |
| F2 | | a | | | " | | | a | |
| F3 | | b | | | # | | | b | |
| F4 | | c | | | \$ | | | c | |
| F5 | | d | | | % | | | d | |
| F6 | | e | | | & | | | e | |
| F7 | | f | | | ' | | | f | |
| F8 | | g | | | (| | | g | |
| F9 | | h | | |) | | | h | |
| F10 | | i | | | * | | | i | |
| F11 | SOH | j | CR | STX | + | CR | LEAD-IN | j | CR |

Note

If the selected key has been loaded previously and saved, the string will be displayed, but can be cancelled by entering a new character string.

1, 2 or 3 F# (mode) 1 = transmit only
(not numeric) 2 = display only
pad) 3 = both

Character F# (mode) Character String
String

ENTER Menu Screen # 3

Additional function keys may now be loaded by repeating the sequence.

The strings loaded may be saved in non-volatile memory by typing SHIFT/ENTER before exiting from Set-Up mode.

All previously loaded strings may be cleared by typing SHIFT 2 while menu Screen #3 is displayed.

CURSOR CLUSTER. In all interactive modes the cursor control keys consisting of ←, →, ↑, ↓ and home key will follow operator selected local/duplex control. In block modes, the cursor key operations will be performed but no transmission will take place.

Cursor up key - will cause the cursor to move up one line remaining in the same column for each key depression but will be inactive if the cursor is located on the top line.

Cursor down key - will move the cursor down one line in the same column, once for each key depression, but will perform no function if the cursor is located on the 24th line.

Cursor right key - will move the cursor right one position for each depression and will move from the end of each line to the beginning of the following line. The cursor right key will perform no function if the cursor is located at the 80th position on the 24th line.

Cursor left key - will cause the cursor to move left one position for each depression. If the cursor is located at the first column of any line on depression of the cursor left key the cursor will move to the last position of the next highest row. If the cursor is located in the first position of the first line, this key will perform no function.

All cursor keys are typamatic.

HOME KEY. Depression of the home key will move the cursor to the first position on the first line except in the VP/R25 mode where it will be positioned to the first location on the 24th line. The home key is not typamatic.

3.2.3 Numeric Cluster. The numeric cluster as shown in figure 3-2 is designed like a calculator pad and is used for easy numeric entries. All keys are in the numeric cluster are typamatic with the exception of the enter key. As defined in table 3-2, the 14 keys of the numeric pad can be selected to be an alternate pre-programmed function key cluster.

Table 3-2. Numeric Cluster Function
Key Modes, Sequence Transmitted

| Key Stroke | Mode 1 | Mode 2 | Mode 3 |
|------------|--------|-----------|--------|
| 0 | LI 0 | STX 0 CR | LI ? p |
| 1 | LI 1 | STX 1 CR | LI ? q |
| 2 | LI 2 | STX 2 CR | LI ? r |
| 3 | LI 3 | STX 3 CR | LI ? s |
| 4 | LI 4 | STX 4 CR | LI ? t |
| 5 | LI 5 | STX 5 CR | LI ? u |
| 6 | LI 6 | STX 6 CR | LI ? v |
| 7 | LI 7 | STX 7 CR | LI ? w |
| 8 | LI 8 | STX 8 CR | LI ? x |
| 9 | LI 9 | STX 9 CR | LI ? y |
| . | LI . | STX . CR | LI ? n |
| ' | LI ' | STX ' CR | LI ? 1 |
| - | *LI - | *STX - CR | LI ? m |
| ENTER | | | LI ? M |

* - Extension to Esprit II

The numeric cluster also includes 7 control and editing keys which perform unique functions which are defined in the following paragraphs. Except where noted, these keys perform a local operation with no transmission in block modes, cause transmission of the appropriate emulation sequence in depends on menu selection and in half duplex interactive automatically perform the function.

Page key - Upon depression of the page key if the multi-page option is installed, the next page of memory will be displayed when the key is depressed. Multiple depressions of the page key will cause the display pages to alternately be displayed. Shift page key depression will display the previous page.

Delete key - The delete key when depressed will perform the delete line function as described in the remote command section. The delete key when depressed simultaneously with the shift key will perform the delete character function as described in the remote command section.

Insert key - The insert key when depressed will perform the insert line function as described in the remote command section. The insert key when depressed simultaneously with the shift key in HAZ, VP/R25, and ADM3A modes will cause the terminal to enter into the insert character mode and the insert command field will be displayed on the Status line. Once in insert character mode, depression of alphanumeric keys will cause the same functions as described in the remote commands for insert character mode. Redepression of the Shift, Insert keys will end Insert mode. In TVI925 mode, insert character will operate on one character basis.

Break key - Depression of the break key will cause the transmission of a 250-300 millisecond space code on the data line of the host RS232 port line. This transmission is independent of mode. The no scroll feature of the Esprit III will be supported on depression of control break. Shift Break, Break will cause power up reset without diagnostic.

Clear key - In all modes except TVI925 when the clear key is depressed, it will cause the entire page (24 lines of the display in standard configuration) to be cleared to high intensity unprotected spaces. When the clear key is depressed simultaneously

with the shift key, it will cause all unprotected display positions to be cleared to high intensity unprotected spaces. The cursor will be located at the home position for clear and at the first unprotected position for shift clear (clear FGN).

Clear Field key - Upon depression of the clear field key if the cursor is located in an unprotected field, the entire field will be cleared to high intensity unprotected spaces. If the clear field key is depressed simultaneously with the shift key, the line from the cursor to the end of the line or end of the unprotected field, whichever comes first will be cleared.

Send key - Depression of the send key will function only in block oriented modes and will institute the appropriate multiple character transmission. When the send key is depressed simultaneously with the shift key, it will cause in any mode the generation of a local print operation through the auxiliary port.

ESC key - Depression of shift ESC keys will allow the local entry of remote commands as done on the Esprit III in all emulation modes.

TAB key - As selected in SETUP mode depression of the tab key will result in either columnar or field tab operation. Shift TAB will result in the associated back tab operation. Forward columnar tab will result in the cursor moving to the first tab stop on the next line when located at the last tab stop of a line. Tab operation will move to home position when the cursor is located at the last tab stop of the 24th line. Back columnar tab will act in a similar manor with no operation at the first columnar tab stop of the first line. Columnar tab will not line wrap in TVI925 mode but instead will emulate the line limited operation of the TVI925.

In TVI925 mode clear operation only effects unprotected characters as controlled by protect commands. Therefore, operation of clear and clear FGN will be the same in TVI 925 mode. In clear operation all unprotected characters will be written as high or low intensity as defined by the last remote command.

Send key - The send key will follow the local/doplex edit key in interactive modes and perform the function in block modes. The following TRANSMIT and PRINT functions are assigned to each SEND key operation in each emulation.

| | TVI925 | HAZ | OTHERS |
|--------------------|--------|-------|--------|
| SEND | PAGE | PAGE | PAGE |
| ^S SEND | LINE | LINE | LINE |
| ^C SEND | PRINT | PRINT | PRINT |
| ^{CS} SEND | NA | FIELD | NA |

Field delimiter operation will be the same as for the Esprit III with the following default conditions. Unprotected graphic fields will be transmitted as codes in ASCII column 4 bracketed by start and end graphic commands shown below in non-TVI modes.

| | TVI | HAZ | ADM3A | UP/R25 |
|---------------|----------|-------|--------|--------|
| EOM | SETUP CR | SETUP | SETUP | SETUP |
| EOL | US | NUL | NUL | NUL |
| FIELD | FS | HT | HT | HT |
| DEL. | | | | |
| START PROT. | ESC) | LI EM | ESC) | SI |
| END PROT. | ESC (| LI US | ESC (| SO |
| START GRAPHIC | ESC \$ | LI ↑ | ESC \$ | ESC \$ |
| STOP GRAPHIC | ESC % | LI % | ESC % | ESC% |

Local/Duplex Control - In interactive mode the following edit keys.

Edit keys = (13 keys)

1. HOME
2. Cursor Up
3. Cursor Down
4. Cursor Right
5. Cursor Left
6. PAGE
7. CHAR/DELETE/LINE
8. CHAR/INSERT/LINE
9. FGN/CLEAR/ALL
10. LINE/CLEAR/FLD
11. SEND
12. BS
13. TAB

will be operator selectable to operate in local or duplex modes. Operation will be to send the appropriate remote command or perform the function as follows:

IN LOCAL EDIT MODE:

| | |
|--------------|----------------------------------|
| FULL DUPLEX: | EXECUTE ONLY (IN ALL EMULATIONS) |
| HALF DUPLEX: | EXECUTE ONLY (IN ALL EMULATIONS) |

IN DUPLEX EDIT MODE:

FULL DUPLEX: SEND ONLY (IN ALL EMULATIONS)
HALF DUPLEX: EXECUTE AND SEND (IN TVI MODE) HAZELTINE MODE WILL FOLLOW ESPRIT II ADM3A MODE WILL FOLLOW ESPRIT II ADDS MODE WILL FOLLOW ESPRIT II (Refer to table 3-3.)

Refer to table 3-4 for TeleVideo and ESP 6310 Keyboard Differences.

3.3 EMULATIONS

3.3.1 General. Only the remote commands for the Hazeltine emulation are described in detail in this manual. In other emulation modes the ESP 6310 will generally operate like the terminal being emulated, but adds additional commands. These are summarized in Appendix C. When a command not available on the terminal being emulated is added, it will operate as described herein for the Hazeltine emulation.

ADM3A, Regent 25/Viewpoint. These terminals have only very basic features and the ADM3A and Regent 25 have neither video attributes nor dual intensity. Application programs written for these units will make no distinction between foreground and background characters, and the menu selection for foreground character video attributes will apply to all characters; high intensity is recommended.

The Viewpoint has video attributes and the commands will be recognized by the ESP 6310 when this emulation is selected. However, when a change in video attributes is made on the Viewpoint, all **"tagged data"** is changed to the new attribute selection. **This will not happen on the ESP 6310;** data already entered will retain its original attributes, only new data entered after the change will take on the new attributes. Unlike the Viewpoint, therefore, it is possible to have multiple video attributes displayed at the same time.

The "No Scroll" mode of the Regent 25 and Viewpoint is not available on the ESP 6310.

TeleVideo. Except for half intensity, the TeleVideo emulation uses "Field Attributes". Attribute tags are stored in display memory and take up a space on the display each time a change occurs. In order to obtain the proper display for application programs already written, the ESP 6310 will also display a space if the "Hidden Field Attributes" selection in Set-Up menu Screen #1 is OFF. By setting this selection ON, or by using the remote "Hidden Field Attributes On" command, the option of not having the attributes occupy space on the display is available. The advantage of field attributes, versus the character attributes used in the other emulations, is that the field attributes are more easily changed; rewriting the attribute selection at the start of a field changes the video attributes of the entire field. With character attributes, the entire field to be changed must be rewritten. The disadvantage is that if the start of a field is lost, due to scrolling, being overwritten, insertion or deletion e.g., the remainder of the field changes attributes. This emulation therefore, provides a much higher degree of protection than the others. When protection is in effect, inserting or deleting characters will not move attributes, nor can attributes or protected characters be overwritten, either from the computer or the keyboard (the other emulations guard against keyboard entry only). In addition, when Vertical Wrap/Auto Page is enabled the display will not scroll; the cursor will wrap from the bottom of the display to the top line on one page units, or jump from the bottom of one page to the top of the next on four page units. In order to rearrange attributes and scroll data in this emulation protection must be turned off by remote command. Typically, formatted screens are set up with protection off, and keyboard entries are then made with protection on.

This is the only emulation which provides data compression. Commands are available (Appendix C) to clear to spaces or to nulls. If an area is cleared to nulls and nothing is subsequently entered in it, nothing will be transmitted in batch transmissions.

The ESP 6310 also adds down loadable function keys. The command to load a key is compatible with the TeleVideo 950 terminal.

The time of day clock feature of the TVI925 is not available in the ESP 6310 emulation.

Table 3-3. Interactive Mode Cursor Movement and Clear Operations (Hazeltine Only) (Sheet 1 of 2)

| KEYSTROKE | ACTION | HALF DUPLEX CHAR(S) SENT | FULL DUPLEX CHAR(S) SENT |
|-----------------------------------|---|-----------------------------|-----------------------------|
| TAB | Tab to first column of next foreground field | HT | HT |
| ^S TAB | Back tab to first column of field cursor is in or previous foreground field | LI ² DC4 | LI DC4 |
| BACKSPACE ← | Cursor left Cursor left | BS None | BS BS |
| ^S BACKSPACE → | Cursor right Cursor right | DLE None | DLE DLE |
| LINE FEED ↓ | Cursor down or more ¹ Cursor down | LF None | LF LI VT |
| ^S LINE FEED or ↑ | Cursor up | None | LI FF |
| RETURN or ENTER | Carriage return or carriage return and line feed ¹ | CR | CR |
| HOME | Homes cursor | None | LI DC2 |
| ^S CLEAR | Clears screen | None | LI FS |
| CLEAR FLD | Clears the foreground field the cursor is in | None | LI SYN |
| ^S FGD CLEAR | Clears all foreground data | None | LI GS |
| ^C FGD CLEAR FLD | Clears to end of line | None | LI SI |
| ^{CS} FGD CLEAR FLD | Clears to end of screen | None | LI CAN |
| LINE INS | Insert line | None | LI SUB |

¹ Action depends on auto line feed selection (paragraph 2.3)

² LI = ESC or ~ depending on selection (paragraph 2.3)

Table 3-3. Interactive Mode Cursor Movement and Clear Operations (Hazeltine Only) (Sheet 2 of 2)

| KEYSTROKE | ACTION | HALF DUPLEX CHAR(S) SENT | FULL DUPLEX CHAR(S) SENT |
|--------------------------|-------------|--------------------------|--------------------------|
| ^S DEL LINE | Delete line | None | LI DC3 |
| SEND | Send Page | None | LI SO |
| ^S SEND | Send Line | None | LI 4 |
| ^C SEND | Print | None | LI RS |
| ^{CS} SEND | Send Field | None | LI) |

Table 3-4. TeleVideo/ESP 6310 Keyboard Differences

| TVI KEYSTROKE | ESP KEYSTROKE | FUNCTION | COMMAND |
|--------------------------|--------------------------|--------------------|---------|
| BACK TAB | ^S TAB | REVERSE TAB | ESC I |
| CLEAR SPACE | ^S CLEAR FGN | CLEAR UNPROTECTED | SUB |
| ^S CLEAR SPACE | CLEAR ALL | CLEAR PAGE (NUL) | ESC * |
| PRINT | ^C SEND | LOCAL PRINT | ESC P |
| LINE ERASE | ^S CLEAR LINE | CLR TO END OF LINE | ESC T |
| ^S LINE ERASE | ^{CS} CLEAR LINE | CLR EOL (NUL) | ESC t |
| PAGE ERASE | CLEAR FIELD | CLR TO END OF PAGE | ESC Y |
| ^S PAGE ERASE | ^C CLEAR FIELD | CLR EOP (NUL) | ESC y |
| NO SCROLL | ^C BREAK | STOP/START INPUT | DC3/DC1 |

3.3.2 Limitations

ADM3A —

- The ESP 6310 terminal neither generates nor responds to secondary channel signals.

Regent 25/Viewpoint —

- Store control character command (ESC Z) is not executed.
- Consul 580 compatible keyboard lock and unlock control codes are not available.
- Numeric pad acts as function keys by remote command only; not by hardware switch setting.
- No keyboard entries are processed when keyboard is locked out.
- There is no "CASE" key.
- When a "break" is transmitted no * will be displayed to show the interface is disconnected.

TeleVideo 925 —

Attributes and Tabs cannot be used in "User Line"

3.4 VIDEO ATTRIBUTES AND GRAPHICS

3.4.1 Introduction. The ESP 6310 terminal permits displaying data in half intensity, reverse video, blinking, underlined, blank, and combinations thereof. It also provides the capability of displaying continuous line graphics.

3.4.2 Field Attributes. Field attributes are used in TeleVideo mode only. An attribute is assigned by the command ESC G followed by one of the following selection parameters;

| Attribute | Char. (ASCII) | Char. (Hex) |
|-----------------------|---------------|-------------|
| Normal | 0 | 30 |
| Blank | 1 | 31 |
| Blink | 2 | 32 |
| Blank | 3 | 33 |
| Reverse | 4 | 34 |
| Reverse, Blank | 5 | 35 |
| Reverse, Blink | 6 | 36 |
| Reverse, Blank | 7 | 37 |
| Underline | 8 | 38 |
| Underline, Blank | 9 | 39 |
| Underline, Blink | : | 3A |
| Underline, Blank | ; | 3B |
| Underline, Reverse | < | 3C |
| Underline, Rev, Blank | = | 3D |
| Underline, Rev, Blink | > | 3E |
| Underline, Rev, Blank | ? | 3F |

An attribute tag will be stored in display memory and the attribute will apply from the cursor location to the next attribute tag or end of line or end of page, depending on the "Attribute" extent selection in Setup Screen #2. When the "Hidden Field Attributes" selection is OFF the tag will display as a half intensity space and will be protected when protection is in effect. When the Hidden Field Attributes selection is taken the attribute tag will not take a space in the display.

3.4.3 Half Intensity. In the TeleVideo emulation only protection is keyed to intensity, which is a character attribute. All data entered after a "Half Intensity On" command, (ESC) will display in half normal intensity. This data will be protected when protection is in effect. Half intensity entry will be discontinued by the "Half Intensity Off" command: ESC.

3.4.4 Graphics. The terminal has fifteen line drawing graphics characters as shown in figure 3-5. Unlike the normal characters, which always have at least one dot clear on all sides, the graphics extend to the edge of the character window so

continuous lines can be formed. The "graphics On" command causes all subsequent characters to be converted to graphics. Figure 3-5 shows a selector character for each graphic element; F will display an upper left corner, N as a horizontal line; etc. In the TeleVideo emulation graphics are protected although displayed in high intensity.

3.4.5 Character Attributes. All emulation modes except TeleVideo employ character attributes, and protection is not keyed to any visible attribute. Each character entered as a foreground character will take whatever combination of attributes has been selected for "Unprotected" character attributes in Setup Screen #1, or as selected by the most recent "Set Foreground Attribute" command (Section IV). Each character entered as a background character will take whatever combination of attributes has been selected for "Protected" character attributes, or as selected by the most recent "Set Background Attribute" command. Changing the selected foreground or background attribute selection will affect subsequent data entered but will not change data already displayed. It is possible, therefore, to have both foreground and background data in all combinations of intensity, reverse video, blink, underline and blank. Data entered as background will not be cleared by a clear foreground command and will be tabbed over by a field tab. In Hazeltine

Block mode it is protected against being overwritten by received data.

3.5 AUX PORT OPERATION

3.5.1 "On Line With Display" (Copy Print)

- Full Duplex - Received data goes to aux port and to display. Command to take aux port off line does not go to aux port.
 - Keyboard data goes only to host.
- Half Duplex - Received data same as FD.
 - Keyboard alphanumeric data goes to host and aux.
- Block - Received data same as FD.
 - Data transmitted goes to host and aux.

3.5.2 "On Line/No Display" (Buffered Print)

Received data goes only to aux port. Only command to cancel mode will be honored by terminal. Command does not go to aux.

Transmitted data goes only to host.

Refer to table 3-5 for recommended Setup selections for existing applications.

Table 3-5. Recommended Setup Selections for Existing Applications (Sheet 1 of 2)

| EMULation | HAZeltine | TVI925 | Regent 25/ Viewpoint | ADM3A |
|---------------------|-----------|--------|-------------------------|-------|
| AUTO WRAP | ON or (2) | ON | (2) | (2) |
| key CLICK | (1) | (1) | (1) | (1) |
| End Of Message Char | (2) | CR | | |
| AUTO LineFeed | (2) | (2) | (2) | (2) |
| SCROLL | (1) | (1) | (1) | (1) |
| TAB MODE | FIELD | X | | |
| HIDDEN FIELD ATTR. | X | OFF | X | X |

Notes: X = Not applicable, selection has no effect in this emulation.

(1) = Operator preference; has no effect on communication.

(2) = Set to match same choice as offered on unit emulated. On Hazeltine terminals which do not offer a switch selection, wraparound is always ON and lead in is always Tilde.

Table 3-5. Recommended Setup Selections for Existing Applications (Sheet 2 of 2)

| EMULation | HAZeltine | TVI925 | Regent 25/ Viewpoint | ADM3A |
|------------------------|--------------|---------|-------------------------|---------|
| RTS CONTROL | (4) | (4) | (4) | (4) |
| KEYBOARD EDIT | DUPLex | (2) | DUPLex | DUPLex |
| UNPROTECTED CHAR ATTR. | HIGH | X | (3) | (3) |
| PROTECTED CHAR ATTR. | NONE | X | X | X |
| STATUS LINE | (1) | (1) | (1) | (1) |
| CURSOR | (1) | (1) | (1) | (1) |
| PARity | (4) | (4) | (4) | (4) |
| WORD LeNgtH | 7 | (2) (4) | (2) (4) | (2) (4) |
| X ON/X OFF | (4) | (4) | (4) | (4) |
| VIDEO | (1) | (1) | (1) | (1) |
| LEAD IN character | (2) or TILDE | X | X | X |
| SCREEN SAVER | (1) | (1) | (1) | (1) |
| STOP BITS | (4) | (2) (4) | (2) (4) | (2) (4) |
| VIDEO ATTR. extent | X | (2) | X | X |

Notes: X = Not applicable, selection has no effect in this emulation.

(1) = Operator preference; has no effect on communication.

(2) = Set to match same choice as offered on unit emulated. On Hazeltine terminals which do not offer a switch selection, wraparound is always ON and lead in is always Tilde.

(3) = Set for "NONE" to match unit being emulated but may be set for operator preference without affecting communication.

(4) = Must be set according to system requirements.

Section IV

REMOTE COMMANDS

4.1 INTRODUCTION

This section describes the ESP 6310 remote command set. The emulation (paragraph 2.2) must be set for Hazeltine for these commands to apply. Refer to Appendix C for the remote command set for other emulations. The remote command repertoire of the ESP 6310 provides the user with the capability of controlling the terminal via the host computer software. For the terminal to execute a remote command, the command code must be preceded by a lead in code (except as noted). The lead-in code may be either a tilde

(ASCII, decimal 126, hexadecimal 7E) or an escape (ASCII ESC, decimal 27, hex 18). The lead-in menu selection (paragraph 2.2) must be set to agree with the code selected. The lead-in code is not displayed when received and does not advance the cursor. The command code must follow the lead-in without intervening characters. If the code following the lead-in is not one of the valid command codes requiring a lead-in (a second lead-in is valid), both the lead-in character and the character following it will be ignored. Some commands apply only in certain modes as noted herein.

4.2 CURSOR CONTROLS

| Command | Lead-in | ASCII | Description |
|--------------------------|---------|-------|---|
| Cursor Home | Yes | DC2 | The cursor moves to the upper left character (HOME) position. The display is unchanged. |
| Cursor Up | Yes | FF | The cursor moves up one row in the same column without altering the display. If the cursor is on the top row, it does not move. |
| Cursor Down | Yes | UT | The cursor moves down one row in the same column without altering the display. If the cursor is on the bottom row, it does not move. |
| Cursor Left Backspace | No | BS | The cursor moves left one column in the leftmost column, it moves to the rightmost column and up one row unless it is on the HOME position. |
| Cursor Right | No | DLE | The cursor moves right one column in the same row without altering the display. If the cursor is in the rightmost column, it moves to the leftmost column of the next row unless it is on the bottom row. |
| Line Feed | No | LF | The cursor moves down one row in the same column; if AUTO LF is ON (paragraph 2.2), Line Feed command is ignored. |

| Command | Lead-in | ASCII | Description |
|------------------------------|---------|----------|--|
| Carriage Return | No | CR | The cursor moves to the leftmost column of the present row. If the AUTO LF is set to ON (paragraph 2.2) the cursor also moves down one row; if it is on the bottom row, the display scrolls up. |
| Field Tab | No | HT | The cursor tabs to the first character position in the next foreground field. If there is no new foreground down screen from the present cursor position the cursor remains in the original location. A warning alarm is heard in this condition. |
| Columnar Tab | Yes | : | The cursor tabs to the next tab stop on the present row. Tab stops are located in columns 0, 8, 16, 24... (steps of 8)...72 (numbering columns from 0 to 79). If there are no more tab stops in the present row the cursor moves to the leftmost column of the next row or to the home position if it was on the bottom row. |
| Back Columnar Tab | Yes | L | The cursor tabs to the previous tab stop on the present row. |
| Back Tab | Yes | DC4 | The cursor is repositioned to the first foreground position in the field in which it is located. In the event that the cursor is located in the first position of a foreground field or within a background field, the cursor will move back to the first position of the previous foreground field. This command will be ignored if the cursor is in the first position of the first foreground field on the display. A warning alarm is heard in this condition. |
| Cursor Address | Yes | DC1, X,Y | The Cursor Address command is a four character sequence: Lead-in, DC1, X-coordinate, Y-coordinate. The 80 character columns are designated X and range from 0 to 79. The rows are designated Y and range from 0 to 23. The four characters in the sequence must be received without intervening characters, such as NUL and DEL. Appendix B list all possible addresses and the key strokes for generating them. |
| Read Cursor Address | Yes | ENQ | The terminal responds with the sequence X-Coordinate, Y-Coordinate, EOM sequence. The coordinate system is the same as described for Direct Cursor Address above. The coordinates transmitted are listed appendix B. |
| Transmit Character at Cursor | Yes | ! | The terminal transmits the character at the present cursor position followed by the selected EOM code. The cursor is not advanced. When used in conjunction with the cursor up, down, right, left and direct cursor address commands, this permits reading any character previously entered on the display. |

| Command | Lead-in | ASCII | Description | | | | | | | | | | | | | | | | | | | | | | | | | | | | |
|------------------------------------|---------|-------|--|--|----|--|--|-------|-----|-----|--------|---|----|----|------------|---|----|----|---------------------|---|----|----|--------------|---|----|----|-------------------------|---|----|----|------------------|
| Set Cursor Attribute | Yes | cN | The cursor will be blanked or displayed as defined by the parameter. | | | | | | | | | | | | | | | | | | | | | | | | | | | | |
| | | | <table border="1"> <thead> <tr> <th></th> <th>Ps</th> <th></th> <th></th> </tr> <tr> <th>ASCII</th> <th>Dec</th> <th>Hex</th> <th>Cursor</th> </tr> </thead> <tbody> <tr> <td>0</td> <td>48</td> <td>30</td> <td>No Display</td> </tr> <tr> <td>1</td> <td>49</td> <td>31</td> <td>Slow Blinking Block</td> </tr> <tr> <td>2</td> <td>50</td> <td>32</td> <td>Steady Block</td> </tr> <tr> <td>3</td> <td>51</td> <td>33</td> <td>Slow Blinking Underline</td> </tr> <tr> <td>4</td> <td>52</td> <td>34</td> <td>Steady Underline</td> </tr> </tbody> </table> | | Ps | | | ASCII | Dec | Hex | Cursor | 0 | 48 | 30 | No Display | 1 | 49 | 31 | Slow Blinking Block | 2 | 50 | 32 | Steady Block | 3 | 51 | 33 | Slow Blinking Underline | 4 | 52 | 34 | Steady Underline |
| | Ps | | | | | | | | | | | | | | | | | | | | | | | | | | | | | | |
| ASCII | Dec | Hex | Cursor | | | | | | | | | | | | | | | | | | | | | | | | | | | | |
| 0 | 48 | 30 | No Display | | | | | | | | | | | | | | | | | | | | | | | | | | | | |
| 1 | 49 | 31 | Slow Blinking Block | | | | | | | | | | | | | | | | | | | | | | | | | | | | |
| 2 | 50 | 32 | Steady Block | | | | | | | | | | | | | | | | | | | | | | | | | | | | |
| 3 | 51 | 33 | Slow Blinking Underline | | | | | | | | | | | | | | | | | | | | | | | | | | | | |
| 4 | 52 | 34 | Steady Underline | | | | | | | | | | | | | | | | | | | | | | | | | | | | |
| Set Column Stop | Yes | 1 | With protection off, a column tab stop is set in the position the cursor is in for all pages. With protection on, a half intensity space is written into the column the cursor is in for each row from the cursor position to the bottom of the page or the first protected character encountered. | | | | | | | | | | | | | | | | | | | | | | | | | | | | |
| Clear Column Tab | Yes | 2 | The tab stop in the column the cursor is in, is cleared. | | | | | | | | | | | | | | | | | | | | | | | | | | | | |
| Clear All Tabs | Yes | 3 | All column tab stops are cleared in all pages. | | | | | | | | | | | | | | | | | | | | | | | | | | | | |
| Read Cursor Address (Page/Row/Col) | Yes | z | The terminal will respond with page number, row parameter, column parameter and a CR. | | | | | | | | | | | | | | | | | | | | | | | | | | | | |
| Cursor Address (Page/Col/Row) | Yes | PCR | The cursor will move to the specified page, column, and row | | | | | | | | | | | | | | | | | | | | | | | | | | | | |

4.3 EDITING COMMANDS

| | | | |
|------------------------------------|-----|-----|--|
| Clear All to Full Intensity Blanks | Yes | FS | The entire screen is cleared to foreground spaces and the cursor moves to the HOME position. |
| Erase EOP with Blank | Yes | CAN | All characters from and including the present cursor position to the end of the screen are cleared to foreground spaces. |
| Clear EOP (Background) | Yes | ETB | All characters from and including the present cursor position to the end of the screen are cleared to background spaces. |
| Erase EOL with Blank | Yes | SI | All characters from and including the present cursor position to the end of the cursor row are cleared to foreground spaces. |

| Command | Lead-in | ASCII | Description |
|--------------------------------------|----------------|--------------|---|
| Clear Field | Yes | SYN | The terminal will cause the contents of the foreground field in which the cursor is currently positioned to be cleared. The cursor will be repositioned to the beginning of the field. Nothing will be cleared if the cursor is positioned within a background field, and the cursor will be repositioned to the first position of the next foreground field unless there is no new foreground field down screen. |
| Clear Unprotected to blank Character | Yes | GS | All foreground characters on the display are replaced with foreground spaces and the cursor moves to the first character position of the first foreground field. |
| Line Insert (Interactive mode only) | Yes | SUB | A new row of all foreground spaces is inserted at the present cursor position. The row the cursor was on, and all rows below it move down. The cursor is placed in the first column of the new row. |
| Line Delete (Interactive mode only) | Yes | DC3 | The row the cursor is on is deleted from the display and all rows below it scroll up one row. The cursor moves to the first column of the present row. |
| Character Insert (Block mode only) | Yes | P | This command alternately puts the terminal into and out of the insert mode. All characters received after the first occurrence of the command are inserted at the cursor location, with the characters at that location and to the right, to the end of field or end of line, whichever comes first, being moved to the right. |
| Character Delete (Block mode only) | Yes | T | The character at the cursor location is deleted and all characters to the right, to the end of field or end of line, are moved left one position. |
| Write Protect (Half Int.)On | Yes | US | All subsequent data is entered as a background field until cancelled by the following Set Foreground command. Data entered as background is not cleared by a Clear Foreground Field command, and tabbed over by a Field Tab command. The terminal defaults to this state at turn-on. |
| Write Protect (Half Int.)Off | Yes | EM | All subsequent data is entered as a foreground field until cancelled by the Set Background (Write Protect On) command; all foreground data is displayed high reverse as selected in the rear setup menu. |

| Command | Lead-in | ASCII | Description |
|--------------------|---------|-------|--|
| Graphic Mode On | Yes | M | Received characters are transposed to one of sixteen graphics characters (including space) as shown in paragraph 3.4. |
| Graphic Mode Off | Yes | % | Graphics characters are always high intensity, regardless of the state of the "Half Intensity" command. However, they are protected when the protect mode is in effect. |
| Reverse Background | Yes | b | The reverse video command causes all video on the display to be reversed. Areas where a reverse video attribute already applies (the status line for example) revert to normal (green on black) video. |
| Normal Background | Yes | d | |
| Blank Screen On | Yes | O | The "Blank" command causes the entire display, including the cursor and the status line, to be blank. |
| Blank Screen Off | Yes | N | Received data is entered in display memory and is displayed when the "Restore" command is received. |

4.4 MODE AND TRANSMIT COMMANDS

| | | | |
|---|-----|---|---|
| Field Transmit | Yes |) | The data in the foreground field in which the cursor is currently positioned will be transmitted and the end of transmission is indicated by a selected End of Message sequence. The cursor will be repositioned to the beginning sequence of the field. Nothing will be transmitted if the cursor is within a background field, and the cursor will be repositioned to the first position of the next foreground field, unless there is no new foreground field down screen. |
| Send Page (All) | Yes | 7 | All data (protected and unprotected) from the home position to the cursor location is transmitted. Protected fields are bracketed by start and end delimiters. Line delimiter characters are inserted after each row, and an end of text character is appended at the end of the transmission. |
| This is the default mode for the SEND Key (Unshifted) | | | |
| Send Line (All) | Yes | 6 | All data on the line the cursor is on, from column 1 to the cursor location, is transmitted. Protected field and line delimiters and end of text character are inserted as in the "Send Page" command above. |
| This is the default mode for shift "SEND" in TVI mode | | | |
| Send Message (All) | Yes | s | All data from the stored start of text character (STX), or home position if there is no STX, to the stored end of text character (ETX), or end of page if there is no ETX, is transmitted. Protected field delimiters, line delimiters and end of text character are inserted as in the commands described above. The cursor is placed over the EXT character, or in the home position if there is no EXT character. |

| Command | Lead-in | ASCII | Description | | | | | | | | | | | | |
|---|-----------------------|------------------|--|---|-------|---|------|---|-----------------------|---|---------------------|---|-------------|--|--|
| Send Page Unprotected Only | Yes | SO | These three commands are the same as the corresponding commands above except that protected data is not transmitted. A field delimiter is inserted for each protected field. | | | | | | | | | | | | |
| Send Line Unprotected Only | Yes | 4 | | | | | | | | | | | | | |
| Send Message Unprotected | Yes | S | | | | | | | | | | | | | |
| Store STX | Yes | STX | An STX character is stored at the cursor location. (For use with the "Send Message" command). | | | | | | | | | | | | |
| Store ETX | Yes | ETX | An ETX character is stored at the cursor location. | | | | | | | | | | | | |
| Monitor Mode On | Yes | U | In monitor mode, all characters received or entered at the keyboard, including control codes, are displayed in consecutive locations on the screen. Control codes are displayed as a two character mnemonic in a single character window. The only command executed is the "Exit" command. | | | | | | | | | | | | |
| Monitor Mode Off | Yes | u | | | | | | | | | | | | | |
| Program Send Delimiters | Yes | xnnn | This command permits overriding the default characters for each of the five delimiters inserted by the terminal during batch transmissions. The first parameter selects the delimiter as shown to the left. The second and third parameters (p1 p2) are the new delimiters characters. To change the end of line delimiters to LF CR, for example, the command is: | | | | | | | | | | | | |
| <table border="1"> <thead> <tr> <th><u>Ps</u></th> <th><u>Delimiter</u></th> </tr> </thead> <tbody> <tr> <td>0</td> <td>field</td> </tr> <tr> <td>1</td> <td>line</td> </tr> <tr> <td>2</td> <td>start protected field</td> </tr> <tr> <td>3</td> <td>end protected field</td> </tr> <tr> <td>4</td> <td>end of text</td> </tr> </tbody> </table> | <u>Ps</u> | <u>Delimiter</u> | | 0 | field | 1 | line | 2 | start protected field | 3 | end protected field | 4 | end of text | | |
| <u>Ps</u> | <u>Delimiter</u> | | | | | | | | | | | | | | |
| 0 | field | | | | | | | | | | | | | | |
| 1 | line | | | | | | | | | | | | | | |
| 2 | start protected field | | | | | | | | | | | | | | |
| 3 | end protected field | | | | | | | | | | | | | | |
| 4 | end of text | | | | | | | | | | | | | | |
| Advance Page | Yes | K | The next page is displayed with the cursor in the same location it was in when the page was last displayed or home). Action wraps from the last page to the first page. | | | | | | | | | | | | |
| Back Page | Yes | J | The preceding page is displayed as described above. | | | | | | | | | | | | |
| Enter Block Mode | Yes | # | The terminal will enter the Block (editing) mode. Subsequent keyboard entries will be stored on the display without being transmitted until a Page, Line or Field transmission is initiated by keyboard or remote command. | | | | | | | | | | | | |
| Exit Block Mode | Yes | \$ | The terminal reverts to the Normal (Interactive) mode. | | | | | | | | | | | | |

| Command | Lead-in | ASCII | Description |
|------------------------------------|---------|----------|--|
| Set Line Mode (Block mode only) | Yes | (period) | Line transmit is defined as transmission of all foreground characters on the line which the cursor is located. Transmission will be invoked by depressing the CR or ENTER key and terminated by insertion of the selected End of Message sequence. The cursor will be relocated to the first position of the next line. If the cursor is located on the bottom line, line transmit causes the screen to roll up. |
| Send Answer Back | No | ENQ | The Answerback message entered in Setup Screen #3 is transmitted. If nothing has been loaded, nothing is transmitted. |
| Select Emulation | Yes | n | The terminal will enter the selected emulation mode with all pages cleared. |

4.5 AUXILIARY PORT COMMANDS

| | | | |
|------------------------|-----|------------------|---|
| Remote Print | Yes | RS | All data from the home position to the cursor location is output as the auxiliary port with a carriage return and line feed (if auto line feed is not selected) or carriage return only (if auto line feed is selected) inserted after each line. |
| Configure Printer Port | Yes | { p1 p2 p3 p4 | This command overrides the selection for the auxiliary port baud rate, parity, word length and stop bits. The four parameters are detailed below: |

| ASCII | p1 Dec | Hex | Baud Rate | ASCII | p2 Dec | Hex | No of Stop Bits |
|-------|-----------|-----|-----------|-------|-----------|-----|--------------------|
| 0 | 48 | 30 | 9,600 | 0 | 48 | 30 | 1 |
| 1 | 49 | 31 | 50 | 1 | 49 | 31 | 2 |
| 2 | 50 | 32 | 75 | | | | |
| 3 | 51 | 33 | 110 | ASCII | p3 Dec | Hex | Parity |
| 4 | 52 | 34 | 135 | 0 | 48 | 30 | None |
| 5 | 53 | 35 | 150 | 1 | 49 | 31 | Odd |
| 6 | 54 | 36 | 300 | 3 | 51 | 33 | Even |
| 7 | 55 | 37 | 600 | 5 | 53 | 35 | Mark (One) |
| 8 | 56 | 38 | 1,200 | 7 | 55 | 37 | Space (Zero) |
| 9 | 57 | 39 | 1,800 | | | | |
| : | 58 | 3A | 2,400 | ASCII | p4 Dec | Hex | Word Length |
| ; | 59 | 3B | 3,600 | 0 | 48 | 30 | 8 bits |
| < | 60 | 3C | 4,800 | 1 | 49 | 31 | 7 bits |
| = | 61 | 3D | 7,200 | | | | |
| > | 62 | 3E | 9,600 | | | | |
| ? | 63 | 3F | 19,200 | | | | |

For example: To set the aux port to 1200 baud, 1 stop bit, even parity, 7 bit word, Send: ESC { 8 0 3 1

| | | | |
|--------------|-----|---|--|
| Copy Mode On | Yes | 1 | All data received via the primary port is displayed, processed and output at the auxiliary port. In half duplex operation, keyboard entries are also transmitted via the auxiliary port. |
|--------------|-----|---|--|

| Command | Lead-in | ASCII | Description |
|------------------------------------|---------|-------------|---|
| Buffer Print On | Yes | * | This command permits transmission to an auxiliary device without affecting the screen. On receipt of this command, data received via the primary port is output to the auxiliary port without processing or display by the terminal. When using this feature in half-duplex systems, it is recommended that data sent to the terminal be preceded by a keyboard lock-out (lead-in, ctrl U) and followed by keyboard unlock (lead-in ctrl F). This will prevent interruption of received data by transmission of the keyboard entry. |
| Copy Mode Off/ Buffer Print Off | Yes | ? | The auxiliary output is disabled and no data is output at the auxiliary port. Input remains enabled. |
| Enable Bidirectional Port | Yes | { | Refer to paragraph 5.2.4 |
| Disable Bidirectional Port | Yes | (Underline) | Refer to paragraph 5.2.4 |

4.6 KEYBOARD AND MISCELLANEOUS COMMANDS

| | | | |
|------------------------------|-----|-----|---|
| Bell | No | BEL | The terminal sounds an audible alarm for approximately 0.3 seconds. |
| Lock Keyboard | Yes | NAK | The keyboard is locked out and no operator entries may be made. This command may be cancelled by the Keyboard Unlock command. |
| Unlock Keyboard | Yes | ACK | The keyboard is unlocked. The terminal defaults to this condition at power-on. |
| Keypad Function Mode | | | The numeric keypad keys 0 through 9, period and comma (also - and ENTER for Mode 3) are converted to function keys. They transmit a sequence of two or three characters as listed in table 3-2. In interactive mode, this capability may be used to permit the host computer to distinguish between numeric pad entries and entries made on the main alphanumeric keys. In block mode, it permits communication without transmission from the display as these sequences are transmitted immediately without effecting the display (unless echoed). Note that Mode 3 can be used in Block/Page mode only if the "Remote Transmit" commands are used; with the ENTER key converted to a function key, there is no way to transmit from the keyboard. |
| Mode 1 | Yes | ; | |
| Mode 2 | Yes | < | |
| Mode 3 | Yes | = | |
| Exit Keypad Function Mode | Yes | > | |

| Command | Lead-in | ASCII | Description |
|---------------------------|-----------------------------|----------------|--|
| Display Test Pattern "H" | Yes | " | A test pattern of all background "H" characters is displayed with the cursor in the HOME position. |
| Display Character Font | Yes | 8 | A pattern of all ASCII characters is displayed with the cursor in the HOME position. |
| Load Function Key (p1 p2) | Yes | I | The sequence for loading a function key is: ESCI p1 p2 text string EM |
| <u>Key</u> | <u>p1 (ASCII) Unshifted</u> | <u>Shifted</u> | Where p1 selects the function key to be loaded, p2 selects the transmission mode, and the End of Medium (EM) character denotes the end of the string to be loaded. |
| F1 | 1 | < | |
| F2 | 2 | = | |
| F3 | 3 | > | |
| F4 | 4 | ? | Transmit Only (Full Duplex) |
| F5 | 5 | @ | Local only |
| F6 | 6 | A | Both (Half Duplex) |
| F7 | 7 | B | |
| F8 | 8 | C | |
| F9 | 9 | D | |
| F10 | : | E | |
| F11 | ; | F | |
| Clear All Function Keys | Yes | V | The function key pool (but not the non-volatile memory) is cleared and all functions revert to the default condition. |

4.6.1 Loading Function Keys. There are 256 character slots available in the function key memory pool. The terminal uses one slot for each key loaded for internal control. If only one key is loaded, it may contain up to 255 characters. If all 22 keys are loaded, a maximum total of 234 characters (256 - 22) may be loaded, distributed in any manner. Keys may be loaded in any order, and loading a new string in a key automatically cancels the previous string.

To load an ASCII control code, it must be preceded by a DLE character, which tells the terminal to accept the one character following it literally

(including another DLE character or an EM character).

The second parameter in the command sequence controls how the data will be handled when the key is depressed. Transmit only (p2 = 1) may be used in full duplex systems, with the data going to the terminal processor when echoed, or in block mode to provide a means of communicating with the host computer without affecting the display. Local only (p2 = 2) may be used to store commands for local execution only (paragraph 3.2.8), or text to be inserted in block mode. The third mode (p2 = 3) is provided primarily for half duplex systems; the data is transmitted and also processed by the terminal for display.

4.7 USER/STATUS LINE COMMANDS

| Command | Lead-in | ASCII | Description |
|--------------------------|---------|-------|---|
| Load User Line | Yes | f | <p>This command requires the following sequence: ESC f (up to 79 characters) CR. The user line is cleared to spaces and the text following the "f" is loaded in the user line area of the terminal memory. The CR indicates the end of the text to be loaded.</p> <p>Video attributes may be set on the user line using the same command as for a normal line (para. 4.4). An HT character in a user line load causes the terminal to TAB to the column in the user line specified by the parameter which follows it. Parameters are the same as for cursor address (Appendix B).</p> |
| Display User Line | Yes | g | <p>The message previously loaded is displayed in reverse video as the 25th line of the display, replacing the status line. At power up it is all spaces.</p> |
| Cancel User Line Display | Yes | h | <p>Restores display of the status line or a blank line if "BLANK" is selected in Set-Up menu.</p> |

4.8 SCROLLING CONTROLS

| | | | |
|-----------------------------|-----|---|--|
| Vertical Wrap/Auto Page On | Yes | v | <p>This mode provides a means of preventing new lines of data from causing old lines to be rolled up out of display memory, regardless of whether protection is on or off. The cursor will automatically go from the last line of one page to the first line of the next page. After the last line of the last page, it will wrap to the first line of the first page. If protection is off, old data can be written over.</p> |
| Vertical Wrap/Auto Page Off | Yes | w | |

4.9 VIDEO ATTRIBUTE COMMANDS

| <u>UNDERLINE</u> | <u>VIDEO</u> | <u>BLINK</u> | <u>INTENSITY</u> | <u>ASCII</u> | <u>HEX</u> | <u>DEC</u> | |
|------------------|--------------|--------------|------------------|--------------|------------|------------|-----|
| No | Normal | No | High | @ | 40 | 64 | |
| | | | Low | A | 41 | 65 | |
| | | Yes | High | B | 42 | 66 | |
| | | | Low | C | 43 | 67 | |
| | | | Blank | D | 44 | 68 | |
| | | Reverse | No | High | P | 50 | 80 |
| | Low | | | Q | 51 | 81 | |
| | Yes | | High | R | 52 | 82 | |
| | | | Low | S | 53 | 83 | |
| | | | Blank | T | 54 | 84 | |
| | Yes | | Normal | No | High | | 60 |
| | | Low | | | a | 61 | 97 |
| Yes | | High | | b | 62 | 98 | |
| | | Low | | c | 63 | 99 | |
| Reverse | | No | | High | p | 70 | 112 |
| | | | | Low | q | 71 | 113 |
| | | Yes | High | r | 72 | 114 | |
| | | | Low | s | 73 | 115 | |

| Command | Lead-in | ASCII | Description |
|---------------------------------|---------|-------|--|
| Select Foreground Attribute (V) | Yes | 0 | The one character following the command will select video attributes as listed below without occupying space on the display. The attributes will apply to all characters (foreground or background) entered until a new selection command is received. |
| Select Background Attribute (V) | Yes | 9 | |

Section V

INTERFACE

5.1 COMMUNICATIONS INTERFACE

5.1.1 ASCII Code. The Esprit ESP 6310 terminal communicates via ASCII codes shown in Appendix A.

5.1.2 Asynchronous Data. The form for received and transmitted data is asynchronous serial ASCII. Each character is preceded by a start bit and separated from the following character by a minimum of 1 or 2 stop bits—depending on baud rate (refer to Section 1). Received characters must have at least one stop bit.

The parity bit can be selected (refer to Section II) to be even, odd, always one, or always zero. If a

character is received with incorrect parity (with odd or even parity selected), a question mark (?) is displayed on the screen at the cursor position (@ sign in TeleVideo emulation). This indicates to the terminal operator that erroneous data was received. Menu screens in Setup mode provide the ability to select 1 of 15 transmission rates from 50 to 19,200 baud.

5.1.3 EIA Input/Output Connector. The standard EIA input/output connector located on the rear of the terminal (see figure 5-1) provides the connection to the appropriate data set or acoustic coupler. The signals conform to EIA Standard RS-232C. These are listed in table 5-1.

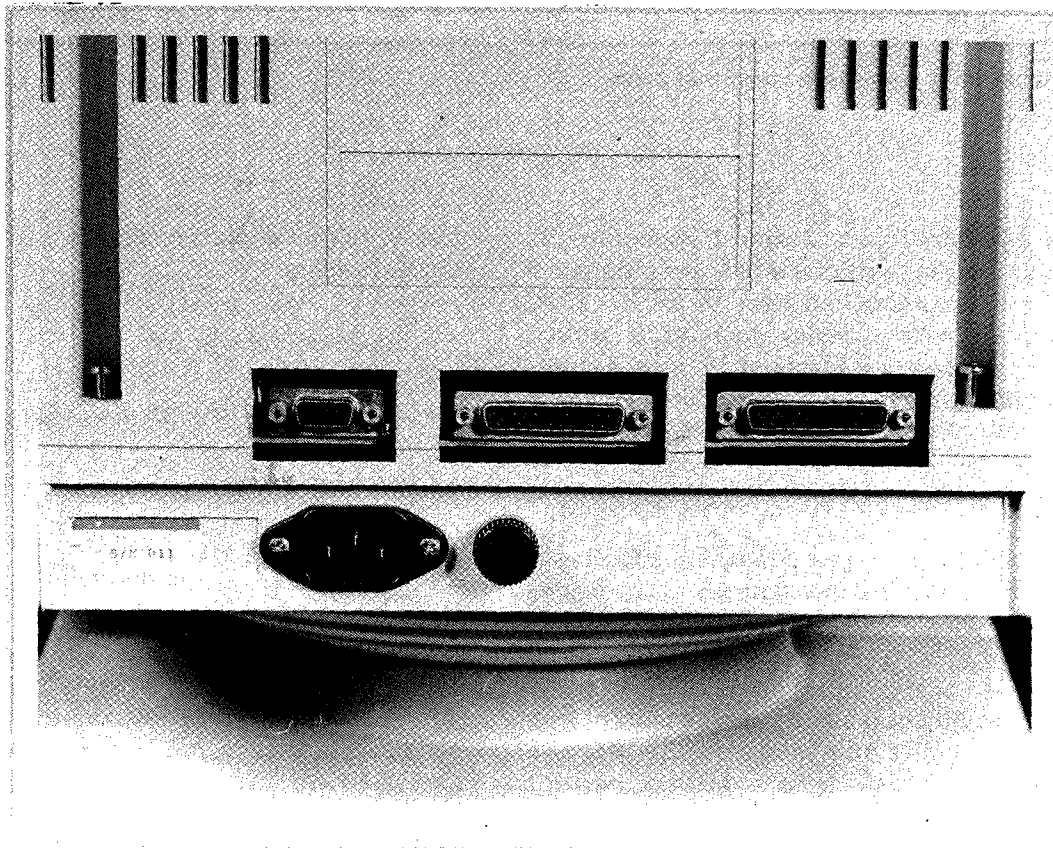

Figure 5-1. Rear of Terminal

Table 5-1. EIA Interface

| Pin Number | Direction of Signal | EIA Designation | CCITT Designation | Function |
|------------|---------------------|-----------------|-------------------|-----------------------------|
| 1 | — | AA | 101 | Protective Ground (Chassis) |
| 2 | From Terminal | BA | 103 | Transmitted Data |
| 3 | To Terminal | BB | 104 | Received Data |
| 4 | From Terminal | CA | 105 | Request to Send |
| 5 | To Terminal | CB | 106 | Clear to Send |
| 6 | To Terminal | CC | 107 | Data Set Ready |
| 7 | — | AB | 102 | Signal Ground |
| 8 | To Terminal | CF | 109 | Data Carrier Detect |
| 12 | From Terminal | — | — | Detected Current Loop Data |
| 13 | From Terminal | — | — | 16X Baud Rate Clock (TTL) |
| 18 | To Terminal | — | — | + Current Loop Input |
| 19 | To Terminal | — | — | - Current Loop Input |
| 20 | From Terminal | CD* | 108.2 | Data Terminal Ready |
| 21 | From Terminal | — | — | + Current Loop Output |
| 24 | To Terminal | — | — | Current Loop Transmit Drive |
| 25 | From Terminal | — | — | - Current Loop Output |

*CD is true (high) whenever terminal is on.

5.1.4 Auxiliary Input/Output Connector. The auxiliary input/output port permits serial output of received and transmitted data to an RS-232C compatible auxiliary device such as a printer, recorder, or another terminal. It also permits display and transmission of serial data input from an auxiliary device. Output and display may be controlled by remote commands described in Section IV.

The auxiliary input/output connector is located at the rear of the terminal (see figure 5-1). It provides the EIA RS-232C voltage level signals listed in table 5-2.

5.1.5 Current Loop Interface. The current loop interface converts the standard EIA RS-232C voltage level interface to a 20 mA current switching interface. The current loop interface switching states are "mark" (current flow) or "space" (no current flow). Figure 5-2 shows the external current loop configuration for either a

four-wire (full duplex) facility or a two-wire (half duplex) facility.

The maximum ratings are:

Current: 30 mA maximum

Open Loop Voltage: 50 V maximum

Cable Interface: 1000 ft maximum
9600 baud

5.1.6 Hardwired Interface. The terminal can be connected directly to a computer by connecting pins 2, 3, and 7 from the EIA connector on the rear panel. Note that pins 2 and 3 may have to be crossed with the corresponding pins on the computer. No wiring changes are required at the terminal to simulate the presence of a modem. Refer to your computer supplier for any special wiring at the computer interface.

Table 5-2. Auxiliary Interface

| Pin Number | Direction of Signal | Designation | Function |
|------------|---------------------|-------------|-----------------------------|
| 1 | — | AA | Protective Ground (Chassis) |
| 2 | To Terminal | Aux BB | Auxiliary Data in |
| 3 | From Terminal | Aux BA | Auxiliary Data Out |
| 4 | To Terminal | Aux CA | Auxiliary Request to Send |
| 5 | From Terminal | Aux CB | Clear to Send |
| 6 | From Terminal | Aux CC | Data Set Ready |
| 7 | — | AB | Signal Ground |
| 8 | From Terminal | Aux CF | Data Carrier Detect |
| 11 | To Terminal | — | Printer Ready |
| 20 | To Terminal | — | Auxiliary Data Term. Ready |

NOTE

Aux CC is true (high) whenever terminal is on. Aux CF is true when primary CF is true.

5.1.7 Interactive Full Duplex Operation. The full duplex mode of communication is used for interactive communication in systems capable of

simultaneous two-way transmission. In interactive mode with echo, it permits more computer control of the display. Data and commands entered at the keyboard are transmitted directly to the computer without display. The display is affected only by data received by or "echoed" back to the terminal. In the interactive full duplex mode, the terminal's "Request to Send" output is high (true) when the first character is entered and remains high until power is shut off or the terminal is switched to half duplex.

5.1.8 Half Duplex Operation. The half duplex mode of communication is used when the system is not capable of simultaneous two-way transmission, or when "echoed" back operation is undesirable. Data from the keyboard is displayed immediately. Half duplex transmission via a modem is accomplished by the following modem control sequence:

a. When the terminal has data to transmit (when a key is depressed in interactive mode, or when ENTER is entered in batch modes) the terminal outputs a "Request to Send" signal to the modem.

b. The terminal checks for a "Data Set Ready" signal from the modem.

c. Upon sensing the "Data Set Ready" signal, the terminal waits, if necessary, for a "Clear to Send" signal from the modem.

d. Upon sensing the "Clear to Send" signal, the terminal transmits the data via the modem. If the "RTS CTRL" selection in Setup Screen #2 is ON, the terminal will drop RTS after each character and raise it again for the next character, otherwise RTS will remain high.

Note that if the terminal does not sense a "Data Set Ready" signal in step b above, it transmits the data regardless of the presence or absence of the "Clear to Send" signal. This permits direct hard-wired connection to a computer or other device without simulation of modem control signals.

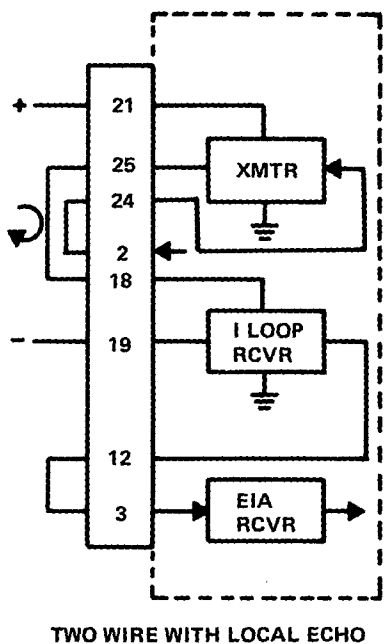
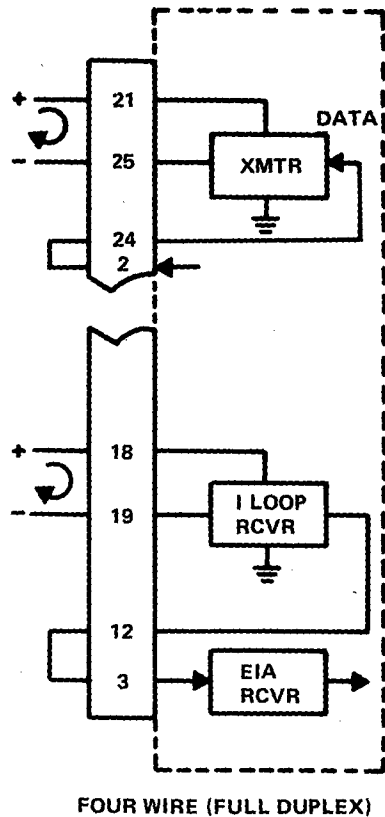

Figure 5-2. Current Loop Interface

5.1.9 Block Mode Operation. Either a full or half duplex communication channel may be used for Block mode (line, page or field) operation; however, batch transmissions should not be echoed. The terminal will follow the half duplex modem control sequence described in paragraph 5.1.8 for all batch transmissions.

5.2 FLOW CONTROL

5.2.1 HOST TO TERMINAL. Any time the terminal is "On Line" but unable to receive data it will transmit an XOFF signal (DC3 Character) to the host and drop its Data Terminal Ready signal. This may happen if:

The operator types ^CBREAK to stop scrolling and the terminal's input buffer fills.

The Auxiliary port is on line, with or without display, and the terminal's 256 character printer buffer fills.

The terminal is busy processing time consuming remote commands and its 256 character input buffer fills.

When the terminal is ready to receive data it will transmit an X ON (DC1 character) and raise its Data Terminal Ready signal.

If the terminal is placed in LOCAL mode it will drop its Data Terminal Ready signal and ignore any data received.

5.2.2 TERMINAL TO HOST. Transmission by the terminal can be suspended by dropping the "Clear to Send" signal. Up to two additional characters may be output after CTS drops. Transmission will resume when CTS is raised.

5.2.3 TERMINAL TO AUX. For Local Print from display and Auxiliary On Line with or without display, auxiliary data is generated from the terminal's auxiliary transmitter. In these modes the auxiliary port Baud rate can be different from the main port Baud rate. The auxiliary device can control data flow from the terminal by means of a "Ready" signal at either pin 20 or pin 11. This signal must be true (high) when the aux device is ready to accept data and false (low) when it is busy.

5.2.4 HOST TO AUX. Figure 5-3 shows the signal flow between the main and auxiliary ports. In all modes the Clear to Send, Data Set Ready and Data Carrier Detect signals at the main port are relayed to the auxiliary port. A three part DIP switch on the main logic port provides a means of disabling some of the control signals (shown as 1, 2 and 3 on figure 5-3). The **Bidirectional Mode** provides a means for the host computer to control the auxiliary device directly. In this mode data received from the host is passed to the auxiliary device and data from the auxiliary device is transmitted to the host. The data is output by the terminal in the same format and speed as it is received. The aux Data Terminal Ready signal at aux pin 20 and an aux "Ready/Busy" signal at aux pin 11 are also relayed to the corresponding main port pins in this mode and either may be used to permit the auxiliary device to control data flow from the host. Since data transmitted by the aux device is also passed to the host it is possible for the aux device to use data protocols (e.g. X OFF/X ON or ETX/ACK protocols) to control transmission from the host. Note however that if the keyboard is not locked out it is possible for data generated at the terminal to collide with data transmitted by the aux device, resulting in a garbled transmission to the host.

5.3 EXPANSION CAPABILITIES

5.3.1 Internal Modem. The Duchess terminal includes a 16-pin socket for the addition of an internal modem integrated circuit. The signals are as follows:

| PIN | PIN |
|---------|----------------------|
| 1. +12V | 9. +5V |
| 2. TxD | 10. -12V |
| 3. RxD | 11. NA |
| 4. NA | 12. RxC |
| 5. -12V | 13. Modem to speaker |
| 6. +5V | 14. +12V |
| 7. GND | 15. NA |
| 8. GND | 16. NA |

5.3.2 External Video. A 9-pin "D" type male connector (DE9P) is provided for external video input from an Esprit work station. The pin assignment is as follows:

- 1) Ground
- 2) Ground
- 3) Not Used
- 4) Not Used
- 5) Not Used
- 6) + Intensity (Hi/Lo)
- 7) + Video
- 8) + Horizontal
- 9) + Vertical

All external video input signals must be TTL compatible. The horizontal and vertical drive signals must be at the same rate as the internal (Duchess) signals to facilitate monitor switching and "lock-on." A multiplexer selects the terminal or external video source at the final output stage before conversion to analog levels.

Video blanking for a period of 500ms is required following a multiplexer switch.

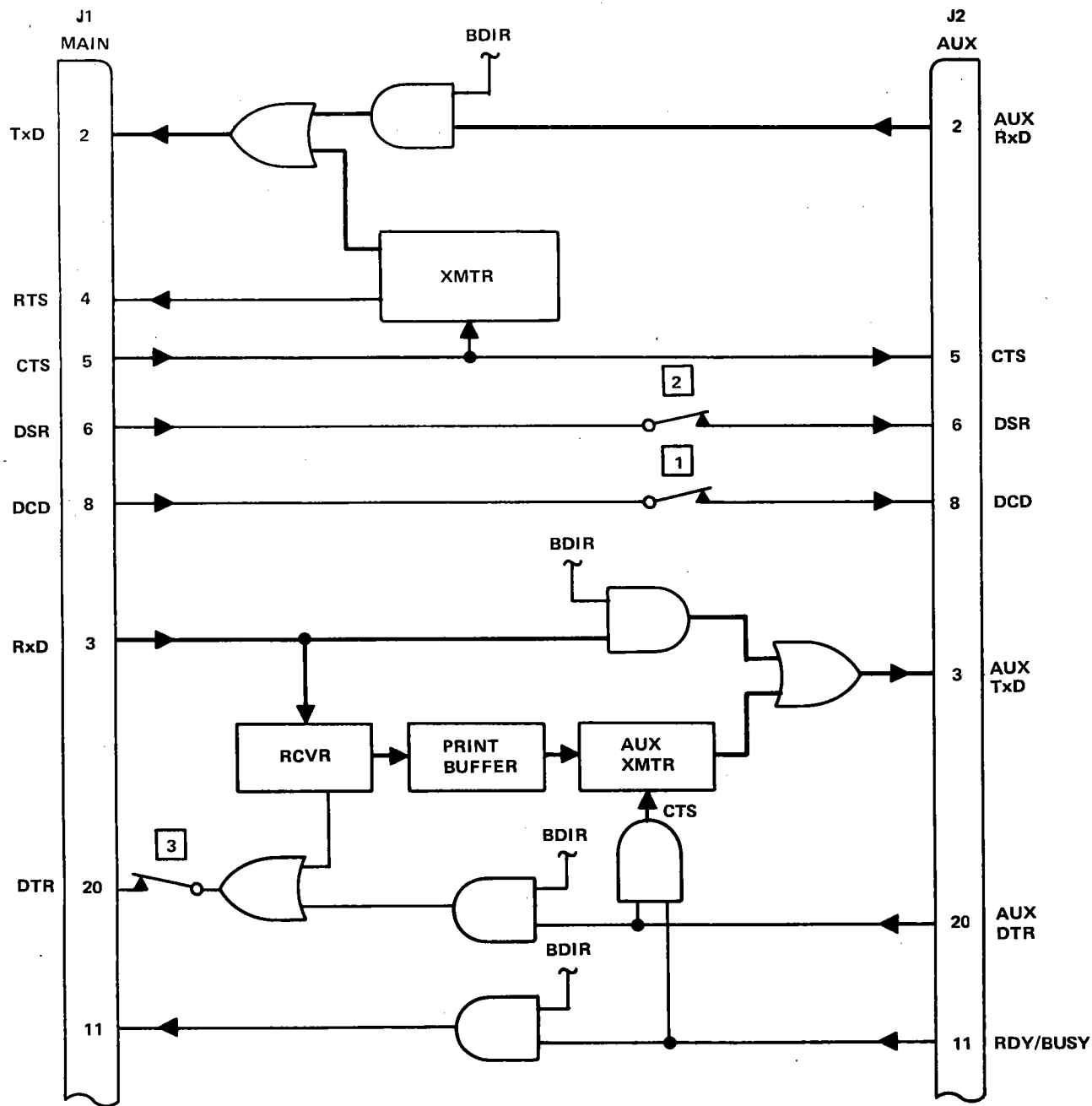

Figure 5-3. Main Port and Auxiliary Port Signal Flow

APPENDIX A

ASCII CODE

| ROW | BIT | COL | | | | | | | |
|-----|-----------------|--------------|-------|-----|-----|-----|-----|-----|-----|
| | | 0 | 1 | 2 | 3 | 4 | 5 | 6 | 7 |
| | | 7 6 5 000 | 001 | 010 | 011 | 100 | 101 | 110 | 111 |
| 0 | 4 3 2 1 0000 | @ NUL | ␣ DLE | SP | 0 | @ | P | ' | P |
| 1 | 0001 | A SOH | ␣ DC1 | ! | 1 | A | Q | a | q |
| 2 | 0010 | B STX | ␣ DC2 | " | 2 | B | R | b | r |
| 3 | 0011 | C ETX | ␣ DC3 | = | 3 | C | S | c | s |
| 4 | 0100 | D EOT | ␣ DC4 | \$ | 4 | D | T | d | t |
| 5 | 0101 | E ENQ | ␣ NAK | % | 5 | E | U | e | u |
| 6 | 0110 | F ACK | ␣ SYN | & | 6 | F | V | f | v |
| 7 | 0111 | G BEL | ␣ ETB | ' | 7 | G | W | g | w |
| 8 | 1000 | H BS | ␣ CAN | (| 8 | H | X | h | x |
| 9 | 1001 | I HT | ␣ EM |) | 9 | I | Y | i | y |
| A | 1010 | J LF | ␣ SUB | * | : | J | Z | j | z |
| B | 1011 | K VT | ␣ ESC | + | ; | K | [| k | { |
| C | 1100 | L FF | ␣ FS | . | < | L | \ | | ; |
| D | 1101 | M CR | ␣ GS | - | = | M |] | m | } |
| E | 1110 | N SO | ␣ RS | . | > | N | ^ | n | ~ |
| F | 1111 | O SI | ␣ US | / | ? | O | _ | o | DEL |

- Ak -ACKNOWLEDGE
- Bl -BELL
- Bs -BACKSPACE
- Cn -CANCEL LINE
- Cr -CARRIAGE RETURN
- Dl -DATA LINK ESCAPE
- D1 -DEVICE CONTROL 1
- D2 -DEVICE CONTROL 2
- D3 -DEVICE CONTROL 3
- D4 -DEVICE CONTROL 4
- Em -END OF MEDIUM
- Eq -ENQUIRY
- Ex -END OF TRANSMISSION
- Es -ESCAPE
- Eb -END OF BLOCK
- Et -END OF TEXT
- Ff -FORM FEED
- Fs -FILE SEPARATOR
- Gs -GROUP SEPARATOR
- Ht -HORIZONTAL TAB
- Lf -LINE FEED
- Nk -NEGATIVE ACKNOWLEDGE
- Rs -RECORD SEPARATOR
- S1 -SHIFT IN
- S0 -SHIFT OUT
- Sp -SPACE
- Sh -START OF HEADING
- St -START OF TEXT
- Sb -SUBSTITUTE
- Sy -SYNCHRONOUS IDLE
- Us -UNIT SEPARATOR
- Vt -VERTICAL TAB

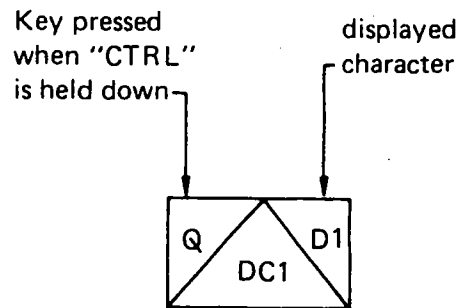

CONTROL CHARACTER LEGEND standard abbreviation

ENGLAND

| | | |
|-----|-------|---------------|
| HEX | ASCII | REPLACED WITH |
| 23 | # | £ |

A-2

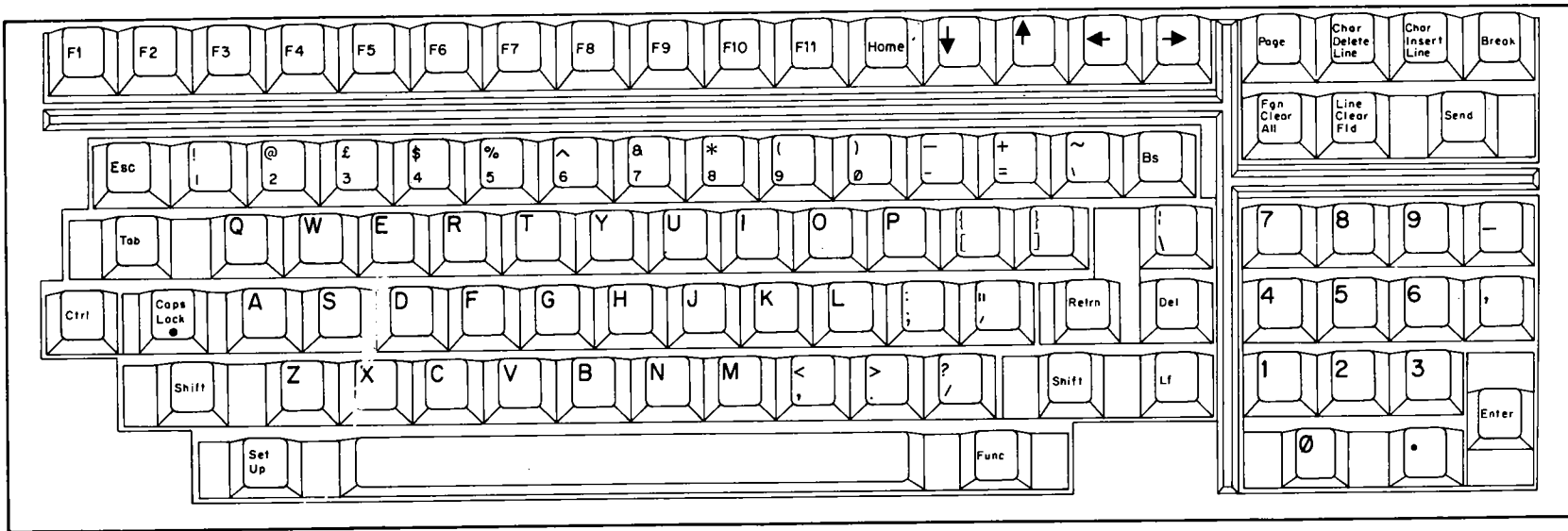

NORWAY

| HEX | ASCII | REPLACED WITH |
|-----|-------|---------------|
| 5B | [| Æ |
| 5C | \ | Ø |
| 5D |] | Å |
| 5E | ^ | • |
| 7B | { | æ |
| 7C | : | ø |
| 7D | } | å |

A-3

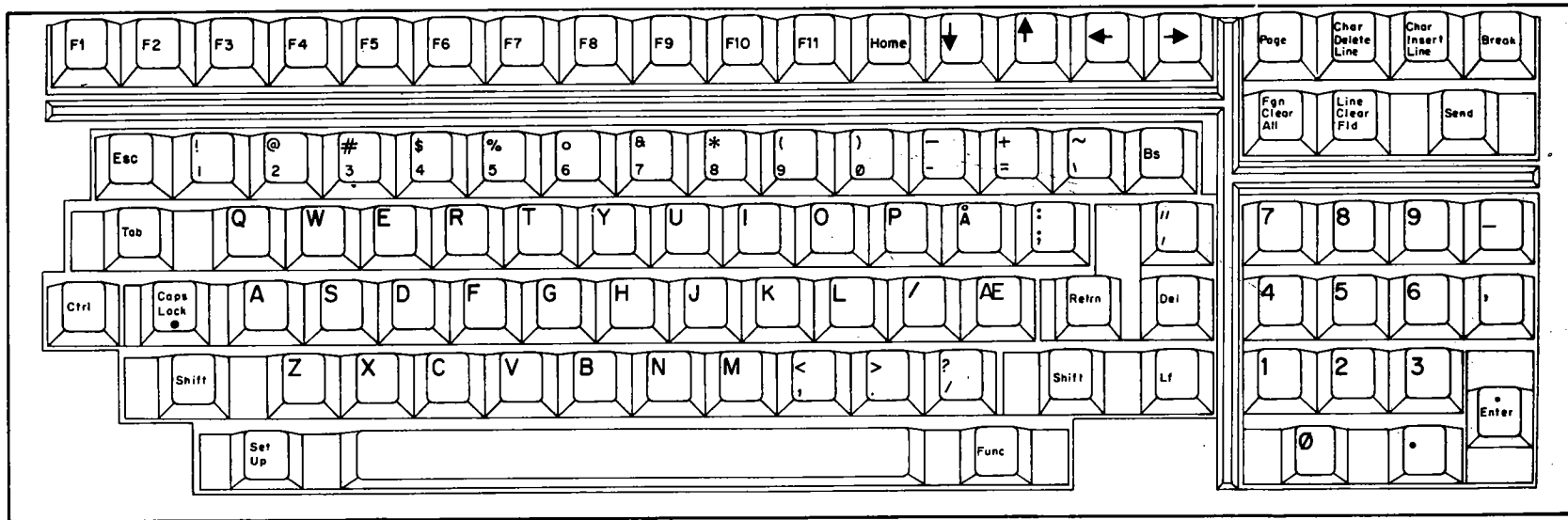

DENMARK

| HEX | ASCII | REPLACED WITH |
|-----|-------|---------------|
| 5B | [| Æ |
| 5C | \ | Ø |
| 5D |] | Å |
| 5E | ^ | • |
| 7B | (| Æ |
| 7C |) | Ø |
| 7D |] | Å |

A-4

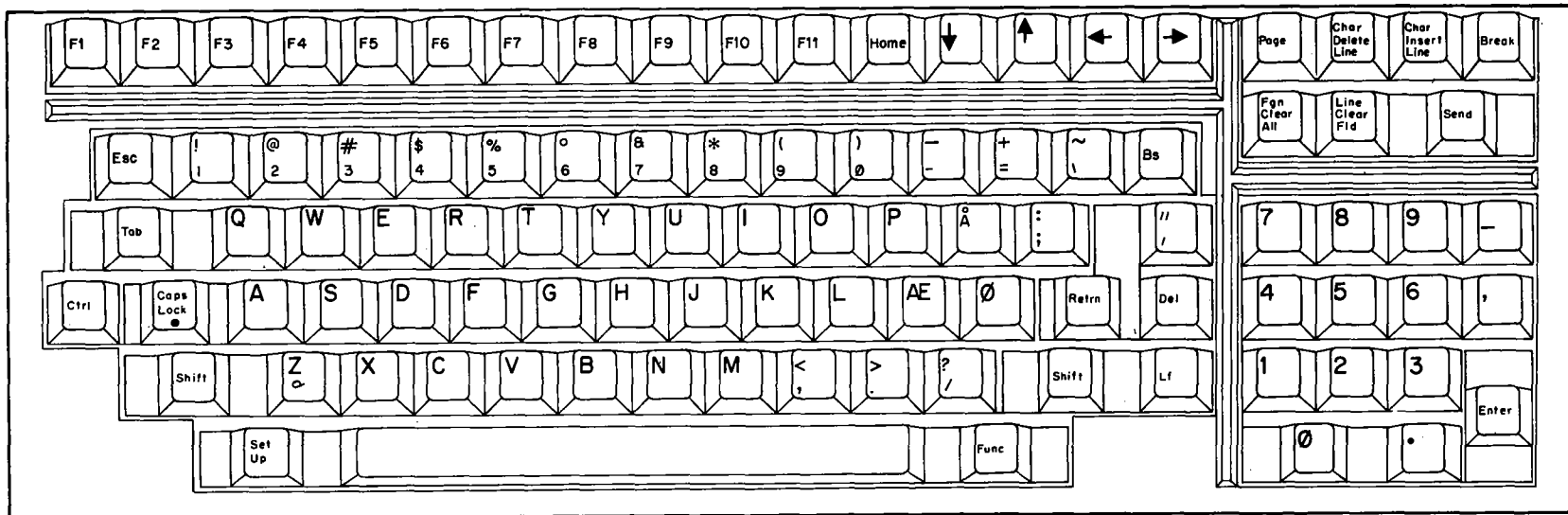

SPAIN

| HEX | ASCII | REPLACED WITH |
|-----|-------|---------------|
| 5C | \ | ~N |
| 7C | : | ~R |

A-5

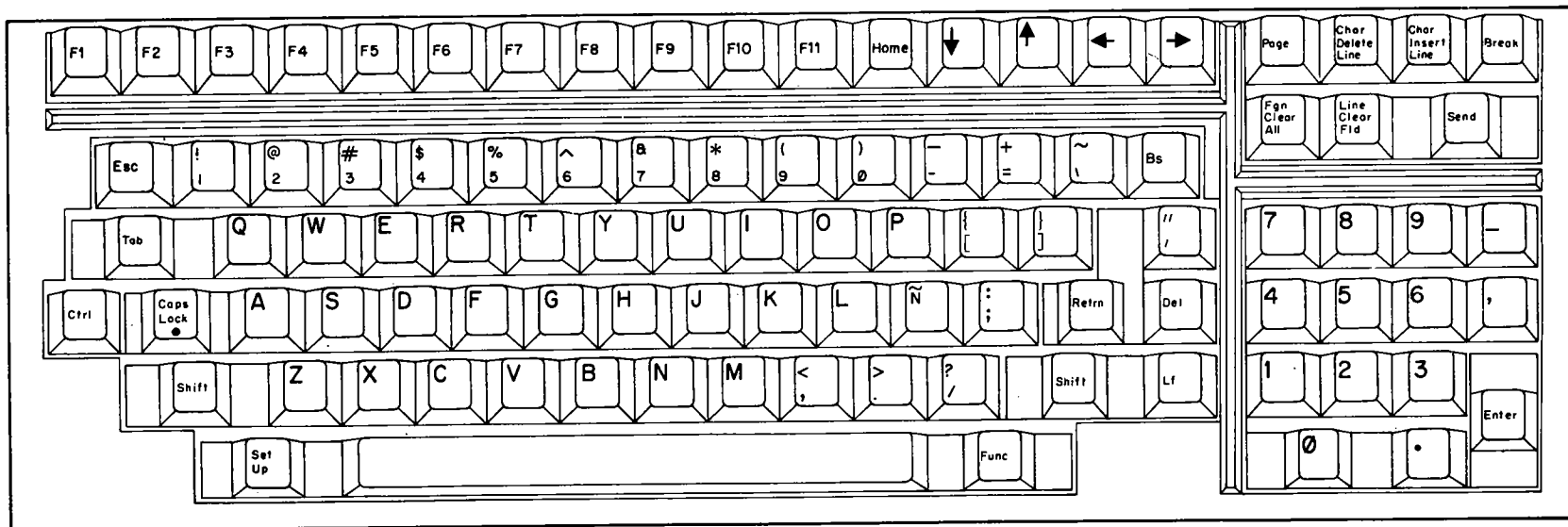

GERMANY

| HEX | ASCII | REPLACED WITH |
|-----|-------|---------------|
| 40 | @ | 9 |
| 5B | [| A |
| 5C | \ | O |
| 5D |] | U |
| 7B | { | a |
| 7C | : | o |
| 7D | } | u |
| 7E | ~ | ß |

A-6

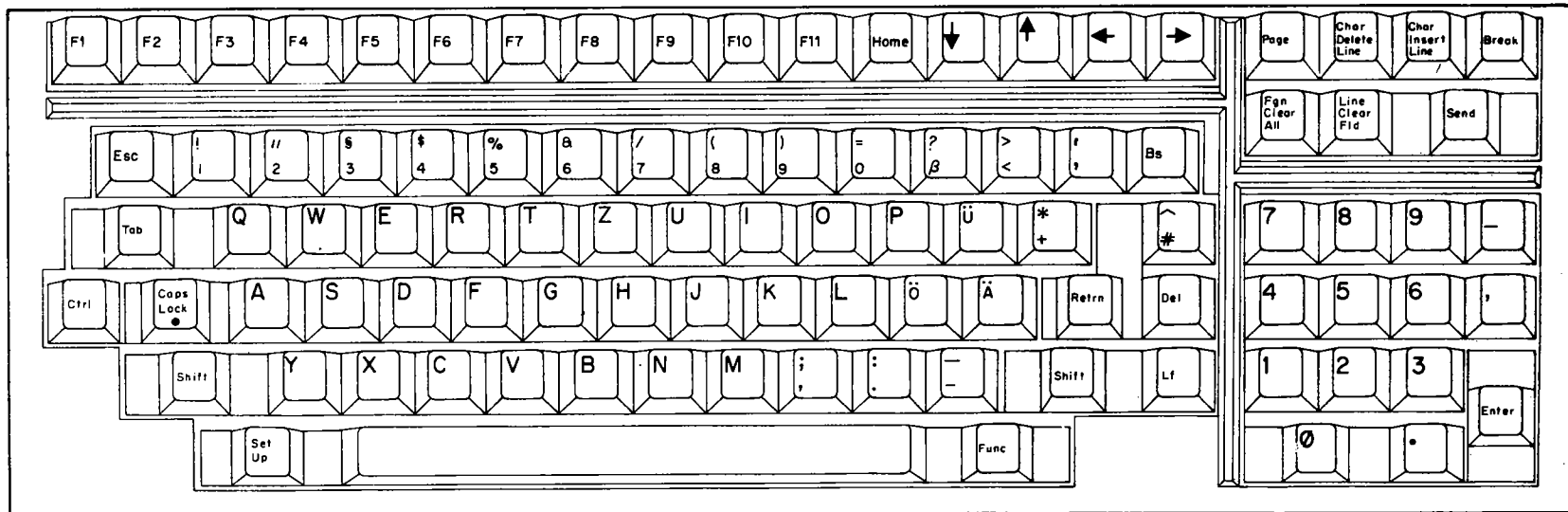

FRANCE

| HEX | ASCII | REPLACED WITH |
|-----|-------|---------------|
| 40 | @ | â |
| 5B | [| • |
| 5C | \ | µ |
| 5D |] | ¶ |
| 60 | ` | ÿ |
| 7B | { | œ |
| 7C | : | ü |
| 7D | } | ø |
| 7E | ~ | .. |

A-7

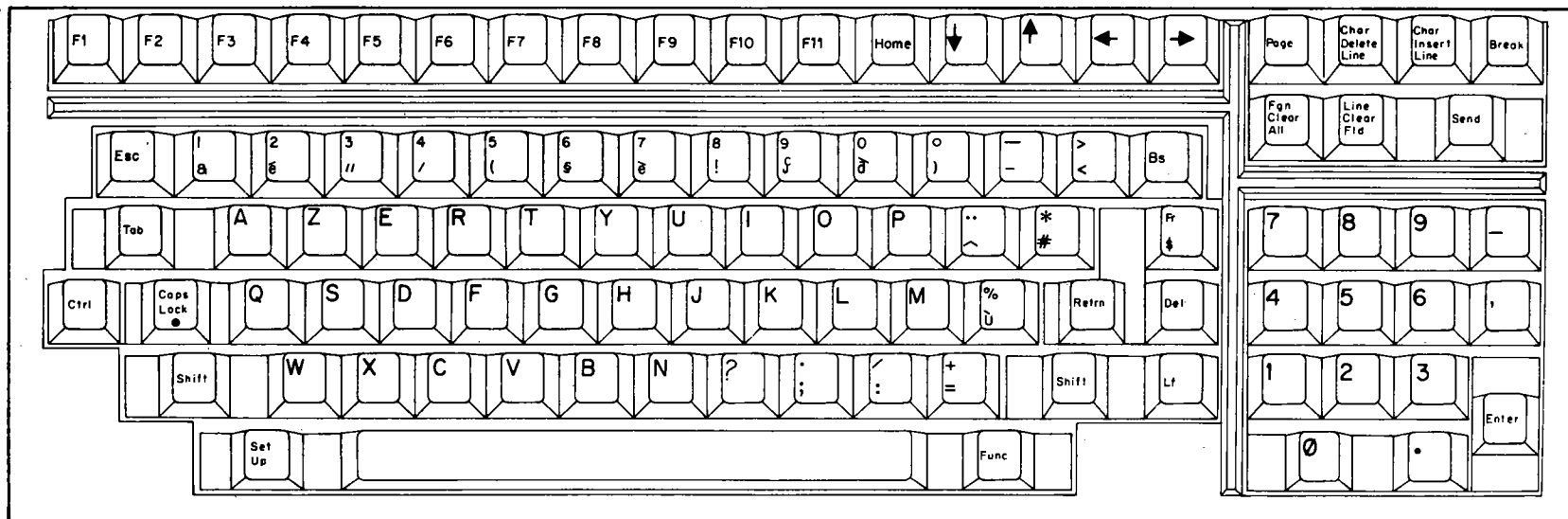

SWEDEN

| HEX | ASCII | REPLACED WITH |
|-----|-------|---------------|
| 40 | @ | È |
| 5B | [| Å |
| 5C | \ | Ö |
| 5D |] | Ä |
| 5E | ^ | U |
| 60 | ` | e |
| 7B | { | a |
| 7C | : | o |
| 7D | } | a |
| 7E | ~ | ü |

8-V

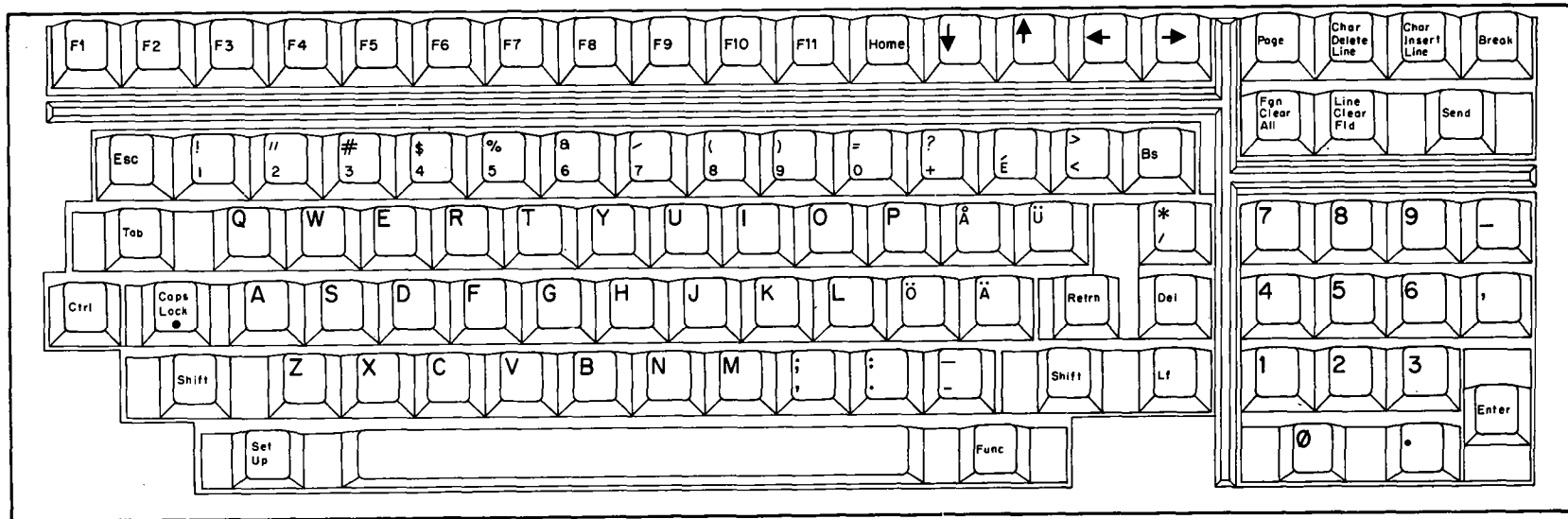

APPENDIX B

CURSOR ADDRESS TABLES

HAZELTINE Direct Cursor Address and Send Cursor Address

| DECIMAL CODE | KEYSTROKE | CRT POSITION | | DECIMAL CODE | KEYSTROKE | CRT POSITION | |
|--------------|-----------|--------------|----------|--------------|---|--------------|----------|
| | | ROW # | COLUMN # | | | ROW # | COLUMN # |
| 0 | CTRL @ | 0 | 0 | | | | |
| 1 | CTRL A | 1 | 1 | 64 | @ | 0 | 64 |
| 2 | CTRL B | 2 | 2 | 65 | A | 1 | 65 |
| 3 | CTRL C | 3 | 3 | 66 | B | 2 | 66 |
| 4 | CTRL D | 4 | 4 | 67 | C | 3 | 67 |
| 5 | CTRL E | 5 | 5 | 68 | D | 4 | 68 |
| 6 | CTRL F | 6 | 6 | 69 | E | 5 | 69 |
| 7 | CTRL G | 7 | 7 | 70 | F | 6 | 70 |
| 8 | CTRL H | 8 | 8 | 71 | G | 7 | 71 |
| 9 | CTRL I | 9 | 9 | 72 | H | 8 | 72 |
| 10 | CTRL J | 10 | 10 | 73 | I | 9 | 73 |
| 11 | CTRL K | 11 | 11 | 74 | J | 10 | 74 |
| 12 | CTRL L | 12 | 12 | 75 | K | 11 | 75 |
| 13 | CTRL M | 13 | 13 | 76 | L | 12 | 76 |
| 14 | CTRL N | 14 | 14 | 77 | M | 13 | 77 |
| 15 | CTRL O | 15 | 15 | 78 | N | 14 | 78 |
| 16 | CTRL P | 16 | 16 | 79 | O | 15 | 79 |
| 17 | CTRL Q | 17 | 17 | 80 | P | 16 | 79 |
| 18 | CTRL R | 18 | 18 | 81 | Q | 17 | 79 |
| 19 | CTRL S | 19 | 19 | 82 | R | 18 | 79 |
| 20 | CTRL T | 20 | 20 | 83 | S | 19 | 79 |
| 21 | CTRL U | 21 | 21 | 84 | T | 20 | 79 |
| 22 | CTRL V | 22 | 22 | 85 | U | 21 | 79 |
| 23 | CTRL W | 23 | 23 | 86 | V | 22 | 79 |
| 24 | CTRL X | 23 | 24 | 87 | W | 23 | 79 |
| 25 | CTRL Y | 23 | 25 | 88 | X | 23 | 79 |
| 26 | CTRL Z | 23 | 26 | 89 | Y | 23 | 79 |
| 27 | CTRL [| 23 | 27 | 90 | Z | 23 | 79 |
| 28 | CTRL \ | 23 | 28 | 91 | [\] ^ | 23 | 79 |
| 29 | CTRL] | 23 | 29 | 92 |] | 23 | 79 |
| 30 | CTRL ^ | 23 | 30 | 93 | ^ | 23 | 79 |
| 31 | CTRL _ | 23 | 31 | 94 | _ | 23 | 79 |
| 32 | SPACE | 0 | 32 | 95 | ` a b c d e f g h i j k l m n o p q r s t u v w x y z [\] ^ _ ` | 23 | 79 |
| 33 | ! | 1 | 33 | 96 | ` a b c d e f g h i j k l m n o p q r s t u v w x y z [\] ^ _ ` | 0 | 0 |
| 34 | " | 2 | 34 | 97 | ` a b c d e f g h i j k l m n o p q r s t u v w x y z [\] ^ _ ` | 1 | 1 |
| 35 | # | 3 | 35 | 98 | ` a b c d e f g h i j k l m n o p q r s t u v w x y z [\] ^ _ ` | 2 | 2 |
| 36 | \$ | 4 | 36 | 99 | ` a b c d e f g h i j k l m n o p q r s t u v w x y z [\] ^ _ ` | 3 | 3 |
| 37 | % | 5 | 37 | 100 | ` a b c d e f g h i j k l m n o p q r s t u v w x y z [\] ^ _ ` | 4 | 4 |
| 38 | & | 6 | 38 | 101 | ` a b c d e f g h i j k l m n o p q r s t u v w x y z [\] ^ _ ` | 5 | 5 |
| 39 | ' | 7 | 39 | 102 | ` a b c d e f g h i j k l m n o p q r s t u v w x y z [\] ^ _ ` | 6 | 6 |
| 40 | (| 8 | 40 | 103 | ` a b c d e f g h i j k l m n o p q r s t u v w x y z [\] ^ _ ` | 7 | 7 |
| 41 |) | 9 | 41 | 104 | ` a b c d e f g h i j k l m n o p q r s t u v w x y z [\] ^ _ ` | 8 | 8 |
| 42 | * | 10 | 42 | 105 | ` a b c d e f g h i j k l m n o p q r s t u v w x y z [\] ^ _ ` | 9 | 9 |
| 43 | + | 11 | 43 | 106 | ` a b c d e f g h i j k l m n o p q r s t u v w x y z [\] ^ _ ` | 10 | 10 |
| 44 | , | 12 | 44 | 107 | ` a b c d e f g h i j k l m n o p q r s t u v w x y z [\] ^ _ ` | 11 | 11 |
| 45 | - | 13 | 45 | 108 | ` a b c d e f g h i j k l m n o p q r s t u v w x y z [\] ^ _ ` | 12 | 12 |
| 46 | . | 14 | 46 | 109 | ` a b c d e f g h i j k l m n o p q r s t u v w x y z [\] ^ _ ` | 13 | 13 |
| 47 | / | 15 | 47 | 110 | ` a b c d e f g h i j k l m n o p q r s t u v w x y z [\] ^ _ ` | 14 | 14 |
| 48 | 0 | 16 | 48 | 111 | ` a b c d e f g h i j k l m n o p q r s t u v w x y z [\] ^ _ ` | 15 | 15 |
| 49 | 1 | 17 | 49 | 112 | ` a b c d e f g h i j k l m n o p q r s t u v w x y z [\] ^ _ ` | 16 | 16 |
| 50 | 2 | 18 | 50 | 113 | ` a b c d e f g h i j k l m n o p q r s t u v w x y z [\] ^ _ ` | 17 | 17 |
| 51 | 3 | 19 | 51 | 114 | ` a b c d e f g h i j k l m n o p q r s t u v w x y z [\] ^ _ ` | 18 | 18 |
| 52 | 4 | 20 | 52 | 115 | ` a b c d e f g h i j k l m n o p q r s t u v w x y z [\] ^ _ ` | 19 | 19 |
| 53 | 5 | 21 | 53 | 116 | ` a b c d e f g h i j k l m n o p q r s t u v w x y z [\] ^ _ ` | 20 | 20 |
| 54 | 6 | 22 | 54 | 117 | ` a b c d e f g h i j k l m n o p q r s t u v w x y z [\] ^ _ ` | 21 | 21 |
| 55 | 7 | 23 | 55 | 118 | ` a b c d e f g h i j k l m n o p q r s t u v w x y z [\] ^ _ ` | 22 | 22 |
| 56 | 8 | | 56 | 119 | ` a b c d e f g h i j k l m n o p q r s t u v w x y z [\] ^ _ ` | 23 | 23 |
| 57 | 9 | | 57 | 120 | ` a b c d e f g h i j k l m n o p q r s t u v w x y z [\] ^ _ ` | 23 | 24 |
| 58 | : | | 58 | 121 | ` a b c d e f g h i j k l m n o p q r s t u v w x y z [\] ^ _ ` | 23 | 25 |
| 59 | ; | | 59 | 122 | ` a b c d e f g h i j k l m n o p q r s t u v w x y z [\] ^ _ ` | 23 | 26 |
| 60 | < | | 60 | 123 | ` a b c d e f g h i j k l m n o p q r s t u v w x y z [\] ^ _ ` | 23 | 27 |
| 61 | = | | 61 | 124 | ` a b c d e f g h i j k l m n o p q r s t u v w x y z [\] ^ _ ` | 23 | 28 |
| 62 | > | | 62 | 125 | ` a b c d e f g h i j k l m n o p q r s t u v w x y z [\] ^ _ ` | 23 | 29 |
| 63 | ? | | 63 | 126 | ` a b c d e f g h i j k l m n o p q r s t u v w x y z [\] ^ _ ` | 23 | 30 |
| | | | | 127 | DEL | 23 | 31 |

NOTE: The coordinates of "Send Cursor Address" command are shown in the outlined areas.

ADM-3A Direct Cursor Address Table

| DECIMAL CODE | KEYSTROKE | CRT POSITION | | DECIMAL CODE | KEYSTROKE | CRT POSITION | |
|--------------|-----------|--------------|----------|--------------|-----------|--------------|----------|
| | | ROW # | COLUMN # | | | ROW # | COLUMN # |
| 0 | CTRL @ | | | 64 | @ | 0 | 32 |
| 1 | CTRL A | 1 | 33 | 65 | A | 1 | 33 |
| 2 | CTRL B | 2 | 34 | 66 | B | 2 | 34 |
| 3 | CTRL C | 3 | 35 | 67 | C | 3 | 35 |
| 4 | CTRL D | 4 | 36 | 68 | D | 4 | 36 |
| 5 | CTRL E | 5 | 37 | 69 | E | 5 | 37 |
| 6 | CTRL F | 6 | 38 | 70 | F | 6 | 38 |
| 7 | CTRL G | 7 | 39 | 71 | G | 7 | 39 |
| 8 | CTRL H | 8 | 40 | 72 | H | 8 | 40 |
| 9 | CTRL I | 9 | 41 | 73 | I | 9 | 41 |
| 10 | CTRL J | 10 | 42 | 74 | J | 10 | 42 |
| 11 | CTRL K | 11 | 43 | 75 | K | 11 | 43 |
| 12 | CTRL L | 12 | 44 | 76 | L | 12 | 44 |
| 13 | CTRL M | 13 | 45 | 77 | M | 13 | 45 |
| 14 | CTRL N | 14 | 46 | 78 | N | 14 | 46 |
| 15 | CTRL O | 15 | 47 | 79 | O | 15 | 47 |
| 16 | CTRL P | 16 | 48 | 80 | P | 16 | 48 |
| 17 | CTRL Q | 17 | 49 | 81 | Q | 17 | 49 |
| 18 | CTRL R | 18 | 50 | 82 | R | 18 | 50 |
| 19 | CTRL S | 19 | 51 | 83 | S | 19 | 51 |
| 20 | CTRL T | 20 | 52 | 84 | T | 20 | 52 |
| 21 | CTRL U | 21 | 53 | 85 | U | 21 | 53 |
| 22 | CTRL V | 22 | 54 | 86 | V | 22 | 54 |
| 23 | CTRL W | 23 | 55 | 87 | W | 23 | 55 |
| 24 | CTRL X | | 56 | 88 | X | | 56 |
| 25 | CTRL Y | | 57 | 89 | Y | | 57 |
| 26 | CTRL Z | | 58 | 90 | Z | | 58 |
| 27 | CTRL [| | 59 | 91 | [| | 59 |
| 28 | CTRL \ | | 60 | 92 | \ | | 60 |
| 29 | CTRL] | | 61 | 93 |] | | 61 |
| 30 | CTRL ^ | | 62 | 94 | ^ | | 62 |
| 31 | CTRL _ | | 63 | 95 | _ | | 63 |
| 32 | SPACE | 0 | 0 | 96 | · | 0 | 64 |
| 33 | ! | 1 | 1 | 97 | a | 1 | 65 |
| 34 | " | 2 | 2 | 98 | b | 2 | 66 |
| 35 | # | 3 | 3 | 99 | c | 3 | 67 |
| 36 | \$ | 4 | 4 | 100 | d | 4 | 68 |
| 37 | % | 5 | 5 | 101 | e | 5 | 69 |
| 38 | & | 6 | 6 | 102 | f | 6 | 70 |
| 39 | ' | 7 | 7 | 103 | g | 7 | 71 |
| 40 | (| 8 | 8 | 104 | h | 8 | 72 |
| 41 |) | 9 | 9 | 105 | i | 9 | 73 |
| 42 | * | 10 | 10 | 106 | j | 10 | 74 |
| 43 | + | 11 | 11 | 107 | k | 11 | 75 |
| 44 | , | 12 | 12 | 108 | l | 12 | 76 |
| 45 | - | 13 | 13 | 109 | m | 13 | 77 |
| 46 | . | 14 | 14 | 110 | n | 14 | 78 |
| 47 | / | 15 | 15 | 111 | o | 15 | 79 |
| 48 | 0 | 16 | 16 | 112 | p | 16 | |
| 49 | 1 | 17 | 17 | 113 | q | 17 | |
| 50 | 2 | 18 | 18 | 114 | r | 18 | |
| 51 | 3 | 19 | 19 | 115 | s | 19 | |
| 52 | 4 | 20 | 20 | 116 | t | 20 | |
| 53 | 5 | 21 | 21 | 117 | u | 21 | |
| 54 | 6 | 22 | 22 | 118 | v | 22 | |
| 55 | 7 | 23 | 23 | 119 | w | 23 | |
| 56 | 8 | | 24 | 120 | x | | |
| 57 | 9 | | 25 | 121 | y | | |
| 58 | : | | 26 | 122 | z | | |
| 59 | ; | | 27 | 123 | { | | |
| 60 | < | | 28 | 124 | } | | |
| 61 | = | | 29 | 125 | ~ | | |
| 62 | > | | 30 | 126 | DEL | | |
| 63 | ? | | 31 | 127 | | | |

TVI 925/REGENT 25 Direct Cursor Address Table

| CRT POSITION | | | | CRT POSITION | | | |
|--------------|-----------|-------|----------|--------------|-----------|-------|----------|
| DECIMAL CODE | KEYSTROKE | ROW # | COLUMN # | DECIMAL CODE | KEYSTROKE | ROW # | COLUMN # |
| 0 | CTRL @ | | | 64 | @ | | 32 |
| 1 | CTRL A | | | 65 | A | | 33 |
| 2 | CTRL B | | | 66 | B | | 34 |
| 3 | CTRL C | | | 67 | C | | 35 |
| 4 | CTRL D | | | 68 | D | | 36 |
| 5 | CTRL E | | | 69 | E | | 37 |
| 6 | CTRL F | | | 70 | F | | 38 |
| 7 | CTRL G | | | 71 | G | | 39 |
| 8 | CTRL H | | | 72 | H | | 40 |
| 9 | CTRL I | | | 73 | I | | 41 |
| 10 | CTRL J | | | 74 | J | | 42 |
| 11 | CTRL K | | | 75 | K | | 43 |
| 12 | CTRL L | | | 76 | L | | 44 |
| 13 | CTRL M | | | 77 | M | | 45 |
| 14 | CTRL N | | | 78 | N | | 46 |
| 15 | CTRL O | | | 79 | O | | 47 |
| 16 | CTRL P | | | 80 | P | | 48 |
| 17 | CTRL Q | | | 81 | Q | | 49 |
| 18 | CTRL R | | | 82 | R | | 50 |
| 19 | CTRL S | | | 83 | S | | 51 |
| 20 | CTRL T | | | 84 | T | | 52 |
| 21 | CTRL U | | | 85 | U | | 53 |
| 22 | CTRL V | | | 86 | V | | 54 |
| 23 | CTRL W | | | 87 | W | | 55 |
| 24 | CTRL X | | | 88 | X | | 56 |
| 25 | CTRL Y | | | 89 | Y | | 57 |
| 26 | CTRL Z | | | 90 | Z | | 58 |
| 27 | CTRL [| | | 91 | [| | 59 |
| 28 | CTRL \ | | | 92 | \ | | 60 |
| 29 | CTRL] | | | 93 |] | | 61 |
| 30 | CTRL ^ | | | 94 | ^ | | 62 |
| 31 | CTRL _ | | | 95 | _ | | 63 |
| 32 | SPACE | 0 | 0 | 96 | | | 64 |
| 33 | ! | 1 | 1 | 97 | ! | | 65 |
| 34 | " | 2 | 2 | 98 | " | | 66 |
| 35 | # | 3 | 3 | 99 | # | | 67 |
| 36 | \$ | 4 | 4 | 100 | \$ | | 68 |
| 37 | % | 5 | 5 | 101 | % | | 69 |
| 38 | & | 6 | 6 | 102 | & | | 70 |
| 39 | ' | 7 | 7 | 103 | ' | | 71 |
| 40 | (| 8 | 8 | 104 | (| | 72 |
| 41 |) | 9 | 9 | 105 |) | | 73 |
| 42 | * | 10 | 10 | 106 | * | | 74 |
| 43 | + | 11 | 11 | 107 | + | | 75 |
| 44 | , | 12 | 12 | 108 | , | | 76 |
| 45 | - | 13 | 13 | 109 | - | | 77 |
| 46 | . | 14 | 14 | 110 | . | | 78 |
| 47 | / | 15 | 15 | 111 | / | | 79 |
| 48 | 0 | 16 | 16 | 112 | 0 | | |
| 49 | 1 | 17 | 17 | 113 | 1 | | |
| 50 | 2 | 18 | 18 | 114 | 2 | | |
| 51 | 3 | 19 | 19 | 115 | 3 | | |
| 52 | 4 | 20 | 20 | 116 | 4 | | |
| 53 | 5 | 21 | 21 | 117 | 5 | | |
| 54 | 6 | 22 | 22 | 118 | 6 | | |
| 55 | 7 | 23 | 23 | 119 | 7 | | |
| 56 | 8 | 24 | 24 | 120 | 8 | | |
| 57 | 9 | 25 | 25 | 121 | 9 | | |
| 58 | : | 26 | 26 | 122 | : | | |
| 59 | ; | 27 | 27 | 123 | ; | | |
| 60 | < | 28 | 28 | 124 | < | | |
| 61 | = | 29 | 29 | 125 | = | | |
| 62 | > | 30 | 30 | 126 | > | | |
| 63 | ? | 31 | 31 | 127 | ? | | |
| | | | | | DEL | | |

REGENT 25 Horizontal and Vertical Address Table

| DECIMAL CODE | KEYSTROKE | CRT POSITION | | DECIMAL CODE | KEYSTROKE | CRT POSITION | |
|--------------|-----------|--------------|----------|--------------|-----------|--------------|----------|
| | | ROW # | COLUMN # | | | ROW # | COLUMN # |
| 0 | CTRL @ | 0 | 0 | 64 | @ | 0 | 40 |
| 1 | CTRL A | 1 | 1 | 65 | A | 1 | 41 |
| 2 | CTRL B | 2 | 2 | 66 | B | 2 | 42 |
| 3 | CTRL C | 3 | 3 | 67 | C | 3 | 43 |
| 4 | CTRL D | 4 | 4 | 68 | D | 4 | 44 |
| 5 | CTRL E | 5 | 5 | 69 | E | 5 | 45 |
| 6 | CTRL F | 6 | 6 | 70 | F | 6 | 46 |
| 7 | CTRL G | 7 | 7 | 71 | G | 7 | 47 |
| 8 | CTRL H | 8 | 8 | 72 | H | 8 | 48 |
| 9 | CTRL I | 9 | 9 | 73 | I | 9 | 49 |
| 10 | CTRL J | 10 | | 74 | J | 10 | |
| 11 | CTRL K | 11 | | 75 | K | 11 | |
| 12 | CTRL L | 12 | | 76 | L | 12 | |
| 13 | CTRL M | 13 | | 77 | M | 13 | |
| 14 | CTRL N | 14 | | 78 | N | 14 | |
| 15 | CTRL O | 15 | | 79 | O | 15 | |
| 16 | CTRL P | 16 | 10 | 80 | P | 16 | 50 |
| 17 | CTRL Q | 17 | 11 | 81 | Q | 17 | 51 |
| 18 | CTRL R | 18 | 12 | 82 | R | 18 | 52 |
| 19 | CTRL S | 19 | 13 | 83 | S | 19 | 53 |
| 20 | CTRL T | 20 | 14 | 84 | T | 20 | 54 |
| 21 | CTRL U | 21 | 15 | 85 | U | 21 | 55 |
| 22 | CTRL V | 22 | 16 | 86 | V | 22 | 56 |
| 23 | CTRL W | 23 | 17 | 87 | W | 23 | 57 |
| 24 | CTRL X | | 18 | 88 | X | | 58 |
| 25 | CTRL Y | | 19 | 89 | Y | | 59 |
| 26 | CTRL Z | | | 90 | Z | | |
| 27 | CTRL [| | | 91 | [| | |
| 28 | CTRL \ | | | 92 | \ | | |
| 29 | CTRL] | | | 93 |] | | |
| 30 | CTRL ^ | | | 94 | ^ | | |
| 31 | CTRL _ | | | 95 | _ | | |
| 32 | SPACE | 0 | 20 | 96 | | 0 | 60 |
| 33 | ! | 1 | 21 | 97 | a | 1 | 61 |
| 34 | " | 2 | 22 | 98 | b | 2 | 62 |
| 35 | # | 3 | 23 | 99 | c | 3 | 63 |
| 36 | \$ | 4 | 24 | 100 | d | 4 | 64 |
| 37 | % | 5 | 25 | 101 | e | 5 | 65 |
| 38 | & | 6 | 26 | 102 | f | 6 | 66 |
| 39 | ' | 7 | 27 | 103 | g | 7 | 67 |
| 40 | (| 8 | 28 | 104 | h | 8 | 68 |
| 41 |) | 9 | 29 | 105 | i | 9 | 69 |
| 42 | * | 10 | | 106 | j | 10 | |
| 43 | + | 11 | | 107 | k | 11 | |
| 44 | , | 12 | | 108 | l | 12 | |
| 45 | - | 13 | | 109 | m | 13 | |
| 46 | . | 14 | | 110 | n | 14 | |
| 47 | / | 15 | | 111 | o | 15 | |
| 48 | 0 | 16 | 30 | 112 | p | 16 | 70 |
| 49 | 1 | 17 | 31 | 113 | q | 17 | 71 |
| 50 | 2 | 18 | 32 | 114 | r | 18 | 72 |
| 51 | 3 | 19 | 33 | 115 | s | 19 | 73 |
| 52 | 4 | 20 | 34 | 116 | t | 20 | 74 |
| 53 | 5 | 21 | 35 | 117 | u | 21 | 75 |
| 54 | 6 | 22 | 36 | 118 | v | 22 | 76 |
| 55 | 7 | 23 | 37 | 119 | w | 23 | 77 |
| 56 | 8 | | 38 | 120 | x | | 78 |
| 57 | 9 | | 39 | 121 | y | | 79 |
| 58 | : | | | 122 | z | | |
| 59 | ; | | | 123 | { | | |
| 60 | < | | | 124 | } | | |
| 61 | = | | | 125 | ~ | | |
| 62 | > | | | 126 | DEL | | |
| 63 | ? | | | 127 | | | |

APPENDIX C

SUMMARY OF REMOTE COMMANDS

| REMOTE COMMAND | 925 | VP/RGT25 | HAZELTINE | ADM3A |
|---------------------------------------|------------|-----------------|------------------|--------------|
| CURSOR HOME | RS | SOH | LI DC2 | RS |
| CURSOR UP | VT | SUB | LI FF | VT |
| CURSOR DOWN | LF | LF | LI VT | LF |
| CURSOR LEFT BACKSPACE | BS | NAK or BS | BS | BS |
| CURSOR RIGHT | FF | ACK | DLE | FF |
| LINE FEED | LF | LF | LF | LF |
| CARRIAGE RETURN | CR | CR | CR | CR |
| FIELD TAB | ESC i | | HT | |
| COLUMNAR TAB | HT | | LI : | |
| BACK COLUMNAR TAB | | | LI L | |
| BACK TAB | ESC O | ESC O | LI DC 4 | |
| CURSOR ADDRESS | ESC = RC | ESC Yrc | LI DC1cr | ESC = rc |
| READ CURSOR ADDRESS | ESC ? | | LI ENQ | |
| TRANSMIT CHARACTER AT CURSOR | ESC ! | ESC ! | LI ! | ESC ! |
| SET CURSOR ATTRIBUTE | ESC .N | ESC .N | LI cN | ESC .N |
| SET COLUMN STOP | ESC 1 | | LI 1 | |
| CLEAR COLUMN TAB | ESC 2 | | LI 2 | |
| CLEAR ALL TABS | ESC 3 | | LI 3 | |
| CURSOR ADDRESS (Page/Row/Col) | ESC-PRC | ESC-PRC | LI PCR | ESC-PRC |
| READ CURSOR ADDRESS (Page/Row/Col) | / | / | LI z | / |

| REMOTE COMMAND | 925 | VP/RGT25 | HAZELTINE | ADM3A |
|--------------------------------------|--------|----------|-----------|--------|
| CLEAR ALL TO FULL INTENSITY BLANKS | | FF | LI FS | |
| ERASE EOP WITH BLANK | ESC T | ESC K | LI SI | |
| CLEAR EOP (BACKGROUND) | | | LI ETB | |
| ERASE EOL WITH BLANK | ESC Y | ESC k | LI CAN | |
| CLEAR FIELD | | | LI SYN | |
| CLEAR UNPROTECTED TO BLANK CHARACTER | SUB | ESC G | LI GS | SUB |
| LINE INSERT (INTERACTIVE MODE ONLY) | ESC E | ESC m | LSI SUB | |
| LINE DELETE (INTERACTIVE MODE ONLY) | ESC R | ESC 1 | LI DC3 | |
| CHARACTER INSERT (BLOCK MODE ONLY) | ESC Q | ESC F | LI P | |
| CHARACTER DELETE (BLOCK MODE ONLY) | ESC W | ESC E | LI T | |
| WRITE PROTECT (HALF INT.) ON | ESC) | SI | LI US | |
| WRITE PROTECT (HALF INT.) OFF | ESC (| SO | LI EM | |
| GRAPHIC MODE ON | ESC \$ | ESC \$ | LI M | ESC \$ |
| GRAPHIC MODE OFF | ESC % | | LI % | |
| REVERSE BACKGROUND | ESC b | | LI b | |
| NORMAL BACKGROUND | ESC d | | LI d | ESC d |
| BLANK SCREEN ON | ESC O | ESC d | LI o | ESC O |
| BLANK SCREEN OFF | ESC N | ESC D | LI n | ESC N |
| FIELD TRANSMIT | | | LI) | |
| SEND PAGE (ALL) | ESC 7 | LI 7 | | |

| REMOTE COMMAND | 925 | VP/RGT25 | HAZELTINE | ADM3A |
|---------------------------------|----------|----------|-------------|--------|
| SEND LINE (ALL) | ESC 6 | | LI 6 | |
| SEND MESSAGE (ALL) | ESC s | | LI s | |
| SEND PAGE UNPROTECTED ONLY | ESC 5 | | LI SO | |
| SEND LINE UNPROTECTED ONLY | ESC 4 | | LI 4 | |
| SEND MESSAGE UNPROTECTED ONLY | ESC S | | LI S | |
| STORE STX | | | LI STX | ESC Z |
| STORE ETX | | | LI ETX | ESC M |
| MONITOR MODE ON | ESC U | | LI U | |
| MONITOR MODE OFF | ESC u | | LI u | |
| PROGRAM SEND DELIMITERS | ESC xnnn | | LI xnnn | |
| ADVANCE PAGE | ESC K | | LI K | |
| BACK PAGE | ESC J | | LI J | |
| ENTER BLOCK MODE | ESC B | ESC u | LI # | |
| EXIT BLOCK MODE | | | LI \$ | |
| SET LINE MODE (BLOCK MODE ONLY) | | | LI (period) | |
| SEND ANSWER BACK | | | ENQ | |
| SELECT EMULATION | | | An | |
| REMOTE PRINT | | | LI RS | |
| CONFIGURE PRINTER PORT | ESC P1 | ESC An | P1 | ESC p1 |
| COPY MODE ON | ESC 2 | DC2 | LI / | |
| BUFFER PRINT ON | | | LI * | |

| REMOTE COMMAND | 925 | VP/RGT25 | HAZELTINE | ADM3A |
|------------------------------------|--------------|--------------|-------------|--------------|
| COPY MODE OFF/BUFFER PRINT OFF | ESC A | DC4 | LI ? | |
| ENABLE BIDIRECTIONAL PORT | | | { | |
| DISABLE BIDIRECTIONAL PORT | | | (UNDERLINE) | |
| SELECT FOREGROUND ATTRIBUTE (V) | | | LI 0 n | |
| SELECT BACKGROUND ATTRIBUTE (V) | | | LI 9 n | |
| BELL | BEL | BEL | BEL | BEL |
| LOCK KEYBOARD | ESC # | ESC 5 | LI NAK | SI |
| UNLOCK KEYBOARD | ESC " | ESC 6 | LI ACK | SO |
| KEYPAD FUNCTION MODE 1 | | ESC ; | LI ; | ESC ; |
| KEYPAD FUNCTION MODE 2 | | ESC < | LI < | ESC < |
| KEYPAD FUNCTION MODE 3 | | ESC = | LI = | ESC = |
| EXIT KEYPAD FUNCTION MODE | | ESC > | LI > | ESC > |
| ENABLE X OFF/X ON | SI | | | |
| DISABLE X OFF/X ON | SO | | | |
| DISPLAY TEST PATTERN "H" | | | LI " | |
| DISPLAY CHARACTER FONT | | | LI 8 | |
| LOAD FUNCTION KEY | | | LI : | |
| CLEAR ALL FUNCTION KEYS | V | V | LI V | ESC V |
| LOAD USER LINE | ESC f...data | ESC f...data | LI f...data | ESC P...data |
| DISPLAY USER LINE | ESC g | | LI g | |

| REMOTE COMMAND | 925 | VP/RGT25 | HAZELTINE | ADM3A |
|--------------------------------------|----------------------|----------|-----------|-------|
| CANCEL USER LINE DISPLAY | ESC h | ESC b | LI h | |
| VERTICAL WRAP/ AUTO PAGE ON | ESC v | | LI v | |
| VERTICAL WRAP/ AUTO PAGE OFF | ESC w | | LI w | |
| NEW LINE | US | - | - | - |
| CLEAR UNPROTECTED TO BLANK CHAR. | SUB ESC+ ESC ; | - | - | - |
| CLEAR ALL TO NULLS | ESC * | - | - | - |
| CLEAR ALL TO HALF INTENSITY BLANK | ESC , | - | - | - |
| CLEAR UNPROTECTED TO NULL | ESC : | | | |
| SET FIELD ATTRIBUTE | ESC G n | - | - | - |
| END FIELD ATTRIBUTE | ESC G 0 | - | - | - |
| ERASE EOL WITH NULL | ESC t | - | - | - |
| ERASE EOP WITH NULLS | ESC y | - | - | - |
| PROTECT MODE ON | ESC & | - | - | - |
| PROTECT MODE OFF | ESC ' | - | - | - |
| HORIZONTAL ADDRESS | - | DLEC | - | - |
| VERTICAL ADDRESS | - | VTr | - | - |
| CURSOR ENABLE | - | CAN | - | - |
| CURSOR DISABLE | - | ETB | - | - |
| LOCAL EDIT | ESC k | - | - | - |
| DUPLEX EDIT | ESC I | - | - | - |

| REMOTE COMMAND | 925 | VP/RGT25 | HAZELTINE | ADM3A |
|---------------------------|--------|----------|-----------|-------|
| REVERSE LINEFEED | ESC j | ESC j | - | ESC j |
| PRINTER TERMINATION CHAR. | ESC pn | - | - | - |
| HIDDEN FLD ATT. ON | ESC > | - | - | - |
| HIDDEN FLD ATT. OFF | ESC < | - | - | - |
| SMOOTH SCROLL ON | ESC 8 | - | - | - |
| SMOOTH SCROLL OFF | ESC 9 | - | - | - |

Esprit
Systems, Inc.

Hazeltine Terminals Division
100 Marcus Drive
Melville, NY 11747