

3270 Information Display System



**3174 Subsystem Control Unit**

**Models 1L, 1R, 2R, and 3R**

**User's Guide**

---

Introduction

---

Operation

---

Problem Determination

---

Status Codes

---

Setup and Relocation

3270 Information Display System



**3174 Subsystem Control Unit**

**Models 1L, 1R, 2R, and 3R**

**User's Guide**

---

Introduction

---

Operation

---

Problem Determination

---

Status Codes

---

Setup and Relocation

The following warning statements (required by country regulatory agencies) are applicable in the countries indicated.

## **United States**

**Warning:** This equipment generates, uses, and can radiate radio frequency energy and if not installed and used in accordance with the instructions manual, may cause interference to radio communications. It has been tested and found to comply with the limits for a Class A computing device pursuant to Subpart J of Part 15 of FCC Rules, which are designed to provide reasonable protection against such interference when operated in a commercial environment. Operation of this equipment in a residential area is likely to cause interference in which case the user at his own expense will be required to take whatever measures may be required to correct the interference.

### **Additional IBM Statement**

This warning is also applicable to all attaching units produced for use in the U.S.A. that have been manufactured after December 31, 1980. A notice of compliance has been affixed within the customer access area of all affected units.

## **United Kingdom**

**Warning:** This IBM product is made to high Safety standards. It complies inherently with Telecommunications safety standard BS6301. It is not designed to provide protection from excessive voltages appearing externally at its interfaces. Therefore, when this product is connected to a public telecommunications network via any other equipment, and you connect to this product items not supplied by IBM United Kingdom Ltd., you must comply with mandatory telecommunications safety requirements.

**You may do this either by choosing products which also are approved as complying to BS6301 or British Telecom Technical Guide No. 26, or by the use of approved safety barriers. Consult the local office of your public telecommunications operator, for advice and permission to make the connections.**

## **Second Edition (December 1987)**

This major revision obsoletes and replaces GA23-0337-0.

Changes are made periodically to the information herein; before using this publication in connection with the operation of IBM systems, consult the latest *IBM System/370, 30xx, and 4300 Processors Bibliography*, GC20-0001, for the editions that are applicable and current.

References in this publication to IBM products, programs, or services do not imply that IBM intends to make these available in all countries in which IBM operates. Any reference to an IBM licensed program in this publication is not intended to state or imply that only IBM's licensed program may be used. Any functionally equivalent program may be used instead.

Publications are not stocked at the address given below. Requests for IBM publications should be made to your IBM representative or to the IBM branch office serving your locality.

A form for users' comments is provided at the back of this publication. If the form is missing, address comments to IBM Corporation, Department E02, P.O. Box 12195, Research Triangle Park, N.C., U.S.A. 27709-9990. IBM may use or distribute whatever information you supply in any way it believes appropriate without incurring any obligation to you.

---

# Contents

<b>Chapter 1. Introduction</b>	1-1
3174 Subsystem Control Unit Models	1-2
3174 Description	1-4
3174 Model Descriptions	1-4
3174 Models and Features	1-4
This User's Guide and the 3174 Library	1-6
The Purpose of This User's Guide	1-7
Control Unit Setup and Relocation	1-7
Operations with Diskettes	1-9
Status Codes	1-9
Online and Offline Tests	1-11
Problem Solving	1-11
<b>Chapter 2. Operation</b>	2-1
3174 Panels, Switches, and Indicators	2-2
Power Panel and Power Supply	2-4
Operator Panel	2-6
3174 Ports and Cables	2-8
3270 Terminal Port Addresses	2-12
For Terminals Directly Connected to the Terminal Adapter	2-12
For Terminals Indirectly Connected to the Terminal Adapter	2-12
Diskettes and Diskette Drives	2-13
Description of 3174 Diskettes	2-13
How to Handle Diskettes	2-14
How to Insert and Remove Diskettes	2-15
Inserting Diskettes	2-15
Removing Diskettes	2-16
Diskette Shipping and Receiving	2-16
Long-Term Storage of Diskettes	2-16
Making the 3174 Operational	2-17
For Model 1L	2-17
How to IML When Power Is Off	2-17
How to IML When Power Is On	2-19
For Models 1R, 2R, and 3R	2-20
Taking the 3174 Offline	2-21
For Model 1L	2-21
For Models 1R, 2R, and 3R	2-21
Displaying the Master Menu	2-22
Replacing the Encrypt/Decrypt Adapter Battery	2-24
<b>Chapter 3. Control Unit Problem Determination</b>	3-1
Initial Symptom/Action Table	3-3
Symptom/Decision Chart	3-4
Checking Control Unit Power	3-7
For Model 1L	3-7
For Models 1R, 2R, and 3R	3-8
Checking AC Power	3-9



Check Cond Indicator Lit and No Status Code	3-10
Forcing the Control Unit Offline	3-11
3270 Terminal Connection Problems	3-13
Collecting Information about the Problem	3-13
1 – Identify the Failing Terminal and Its Control Unit	3-16
2 – Obtain Physical-Connection Information	3-16
3 – Determine How the Terminal Is Connected to the 3174	3-16
4 – Determine the Status of Other Connected Terminals	3-16
Selecting a 3270 Terminal Symptom	3-18
Procedure A – All Terminals Are Failing	3-19
Procedure B – All Terminals Connected to a TMA Are Failing	3-21
Procedure C – All Terminals Connected to a 3299 Are Failing	3-23
Procedure D – One Terminal Connected to a TMA Is Failing	3-29
Procedure E – One Terminal Connected to a 3299 Is Failing	3-34
Procedure F – A Directly Connected Terminal Is Failing	3-38
Procedure G – A Remote Host Connection Is Failing	3-43
3299 Service/Replacement Procedure	3-48
ASCII Terminal Connection Problems	3-49
Collecting Information about the Problem	3-49
Asynchronous Emulation Adapter 1 Port Range 21 – 00 to 21 – 07	3-50
1 – Identify the Failing Terminal and Its Control Unit	3-52
2 – Obtain Physical-Connection Information	3-52
3 – Determine How the Terminal Is Connected to the 3174	3-52
4 – Determine the Status of Other Connected Terminals	3-55
Selecting an ASCII Terminal Symptom	3-56
Procedure H – All Connections to ASCII Adapter Are Failing	3-57
Procedure I – One Direct ASCII Terminal Is Failing	3-59
Procedure J – One Nonswitched ASCII Terminal Is Failing	3-64
Procedure K – One Switched ASCII Terminal Is Failing	3-71
Procedure L – ASCII Adapter Does Not Respond to Incoming Call	3-75
Procedure M – ASCII Adapter Does Not Respond to Rotary Call	3-79
ASCII Host Connection Problems	3-83
Collecting Information about the Problem	3-83
Asynchronous Emulation Adapter 1 Port Range 21 – 00 to 21 – 07	3-84
1 – Identify the Failing Host and Its Control Unit	3-86
2 – Obtain Physical-Connection Information	3-86
3 – Determine How the Host Is Connected to the 3174	3-86
4 – Determine the Status of Other Connected Hosts	3-89
Selecting an ASCII Host System Symptom	3-90
Procedure N – All Host Connections to ASCII Adapter Are Failing	3-91
Procedure O – One Direct ASCII Host Is Failing	3-93
Procedure P – One Nonswitched ASCII Host Is Failing	3-97
Procedure Q – One Switched ASCII Host Is Failing	3-102
Offline Tests	3-108
Test Operations	3-108
Alt 2 IML Tests	3-108
Alt 1 IML Tests	3-110
Communication Adapter and Communication Cable Test	3-110
Token-Ring Adapter and Cable Test	3-114
<b>Chapter 4. Status Codes</b>	4-1
Description	4-2
How to Display Status Codes	4-2
Status Code Chart	4-4

<b>Chapter 5. Customer Setup and Relocation Instructions</b>	5-1
Model 1L Setup and Relocation Instructions	5-2
How to Set Up the 3174 Model 1L	5-3
How to Relocate the 3174 Model 1L	5-8
Models 1R, 2R, and 3R Setup and Relocation Instructions	5-12
How to Set Up the 3174 Models 1R, 2R, and 3R	5-13
How to Relocate the 3174 Models 1R, 2R, and 3R	5-20

<b>Appendix A. Online Tests</b>	A-1
Online Test Summary	A-2
Entering and Exiting Test Mode	A-2
Displaying the Test Menu	A-3
Terminal Check – Test 0	A-4
Display Logs Menu – Test 1	A-5
Configuration Menu – Test 2	A-7
Display Status Summary – Test 3	A-9
Reset Log – Test 4	A-12
Vital Data – Test 5	A-13
Display Storage – Test 6	A-14
Color Convergence – Test 7	A-14
Extended Function and Program Symbols – Test 8	A-14
Token-Ring Test – Test 9	A-15
Definition of Token-Ring Status Codes	A-16
Definition of Token-Ring Adapter Fields	A-17
Definition of Link Fields	A-18
Online Port Test – Test 10	A-20
How to Run the Terminal Adapter Port Test	A-20
How to Run the TMA/3299 Model 2 Port Test	A-21
Test 12: Asynchronous Emulation Adapter Tests	A-22

<b>Appendix B. Cables and Connections</b>	B-1
3174 Connection Overview	B-2
3174 Adapter Hardware Group Numbers	B-2
Terminal Adapter (HG = 26)	B-2
ASCII Adapter (HG = 21, 22, or 23)	B-2
Token-Ring Adapter (HG = 31)	B-2
Establishing Communication	B-3
Configurations	B-5
Asynchronous Emulation Adapter Feature	B-8
Asynchronous Emulation Adapter Communication	B-9
Asynchronous Emulation Adapter (AEA) Hardware	B-11
Communication Links and Associated Hardware	B-13
Physical and Logical Paths	B-14
Logical Path	B-15
Connection Menu	B-16
Customizing	B-18
Stations and Sets	B-18
Port Type and Port Sets	B-19
How to Disconnect and Connect Cables	B-21
Terminal Cable Connectors	B-21
Modular Telephone Plug Connectors	B-22
Terminal Adapter Connectors	B-22
BNC and DPC Connectors	B-23
3174 Cables, Plugs, and Accessories	B-24

**List of Abbreviations X-1**

**Glossary X-9**

**Index X-27**

## Figures

- 1-1. 3174 Subsystem Control Unit Models 1L, 1R, 2R, and 3R 1-2
- 1-2. 3174 Subsystem Control Unit Models 51R, 52R, and 53R 1-3
- 1-3. 3174 Subsystem Control Unit Models 81R and 82R 1-3
- 1-4. 3174 Subsystem Control Unit Features 1-5
- 1-5. Locations of &itcap1. and &itcap2. 1-6  
efle.e.
- 1-6. Packing the Control Unit for Relocation 1-8
- 2-1. 3174 Control Unit Models 1L, 1R, 2R, and 3R – Front View 2-2
- 2-2. 3174 Control Unit Models 1L, 1R, 2R, and 3R – Rear View 2-3
- 2-3. 3174 Power Panel 2-4
- 2-4. Sequence and Control Cable and Connector 2-5
- 2-5. 3174 Operator Panel 2-6
- 2-6. Sample Cabling Layout for Models 1R and 2R 2-8
- 2-7. Sample Cabling Layout for Model 3R 2-9
- 2-8. Sample Cabling Layout for Model 1L 2-10
- 2-9. Sample ASCII Connection Diagram 2-11
- 3-1. Initial Symptom/Action Table 3-3
- 3-2. Symptom/Decision Chart 3-4
- 3-3. Sample Overview Cable Connection Worksheet 3-14
- 3-4. Sample 3299 Cable Connection Worksheet 3-15
- 3-5. Sample Physical Connection Diagram (3270 Terminals) 3-17
- 3-6. 3270 Terminal Connection Problems 3-18
- 3-7. Sample Cabling Worksheet (ASCII Terminals) 3-50
- 3-8. Sample Physical Connection Diagram (ASCII Terminals) 3-53
- 3-9. ASCII Terminal Connection Problems 3-56
- 3-10. Sample Cabling Worksheet (ASCII Host System) 3-84
- 3-11. Sample Physical Connection Diagram (ASCII Host System) 3-87
- 3-12. ASCII Host Connection Problems 3-90
- 3-13. Communication Cable Switch Settings 3-111
- A-1. 3174 Test Menu A-3
- A-2. Test 0 Display Pattern A-4
- A-3. Test 1 Menu A-5
- A-4. RTM Log for Test 1, Option 1 A-5
- A-5. Log Record Display Panel for Test 1, Options 2 through 6 A-6
- A-6. Test 2 Menu A-7
- A-7. Hardware Configuration Table for Test 2, Option 1 A-8
- A-8. Test 3 Menu A-9
- A-9. Test 4 Menu A-12
- A-10. Test 5 Menu A-13
- A-11. Token-Ring Test Menu A-15
- A-12. Token-Ring Status Test Panel A-16
- A-13. Token-Ring Adapter Status Summary Panel A-17
- A-14. Link Status Summary Panel A-18
- A-15. Gateway Host Status Summary for Test 9, Option 8 A-19
- A-16. Test 10 – Port Wrap Test Menu A-20
- A-17. Test 12 Menu A-22
- A-18. Asynchronous Emulation Adapter Port Tests Menu A-23
- A-19. WXYZZ Override Settings A-25
- A-20. Test 12 Status Summary Panel A-25
- B-1. 3270 Communication B-8
- B-2. ASCII Communication B-8
- B-3. 3270 Terminal Communicating with an ASCII Host B-9

B-4.	ASCII Terminal Communicating with an IBM Host	B-9
B-5.	ASCII Terminal Communicating with an ASCII Host	B-10
B-6.	Asynchronous Emulation Adapter Hardware	B-11
B-7.	AEA I/O Panel	B-12
B-8.	Communication Equipment	B-13
B-9.	Physical and Logical Paths	B-14
B-10.	Printer Logical Path	B-15
B-11.	Display Logical Path	B-15
B-12.	Connection Menu	B-16
B-13.	Connection Menu Option 1	B-16
B-14.	Connection Menu Option 2	B-17
B-15.	Host Set and Terminal Set	B-18
B-16.	Port Sets	B-19
B-17.	Connected Terminal and Port Sets	B-20
B-18.	BNC and DPC connectors	B-23

---

## Preface

This manual contains operator reference information and problem determination procedures for the IBM 3174 Subsystem Control Unit Models 51R, 52R, and 53R.

### Who This Book Is For

This book is written for anyone assigned to operate, and handle problems with, the 3174 Subsystem Control Unit Models 51R, 52R, and 53R. This book should remain with the control unit so that the responsible people can refer to it when doing operating or problem determination procedures.

### How This Book Is Organized

This manual has five chapters and two appendixes:

- Chapter 1 contains an introduction to the 3174 Subsystem Control Unit Models 51R, 52R, and 53R.
- Chapter 2 describes the location and function of the switches, indicators, ports, and cables on the 3174 Subsystem Control Unit Models 51R, 52R, and 53R. Chapter 2 also contains basic operating procedures, such as turning on power, loading microcode, and displaying system menus.
- Chapter 3 contains a symptom/action table, problem determination procedures, and terminal and cabling error-isolation procedures.
- Chapter 4 contains the status codes.
- Chapter 5 contain setup and relocation procedures.
- Appendix A contains reference information about online tests.
- Appendix B contains reference information about cable connectors.

Sometimes, the procedures ask you to do problem determination on one of the terminals attached to the 3174. Be sure you have a copy of the problem determination guide for each terminal type attached to your 3174.



## **Related Publications**

### *IBM 3270 Information Display System:*

*3174 Subsystem Control Unit; Site Planning, GA23-0213*

*3174 Subsystem Control Unit; Customizing Guide, GA23-0214*

*3174 Subsystem Control Unit; Customer Extended Problem Determination, GA23-0217*

*3174 Subsystem Control Unit; Terminal User's Reference for Expanded Functions, GA23-0333*

*3174 Subsystem Control Unit; Functional Description, GA23-0218*

*3174 Subsystem Control Unit Models 51R, 52R, and 53R; User's Guide, GA23-0333*

*3174 Subsystem Control Unit Models 81R and 82R; User's Guide, GA23-0313*

# 3174 Publications

---

## At the central site

(Part 1 of 2)

To do site physical planning



GA23-0213

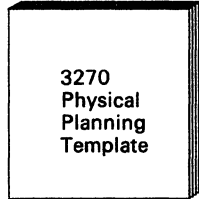

GX27-2999

To plan and do microcode customizing

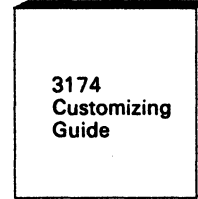

GA23-0214

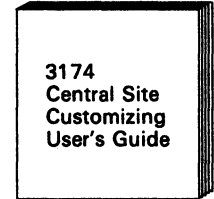

GA23-0342

To manage problems

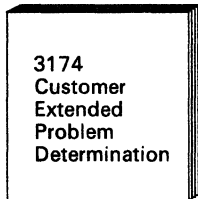

GA23-0217

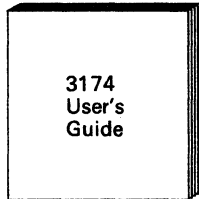

GA23-0337 (for Models 1L, 1R, 2R, and 3R)  
GA23-0333 (for Models 51R, 52R, and 53R)  
GA23-0313 (for Models 81R and 82R)

To understand or write data stream code or to diagnose data stream problems

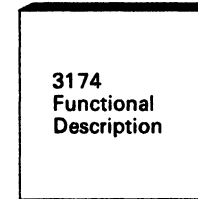

GA23-0218

To plan for and use the Asynchronous Emulation Adapter feature

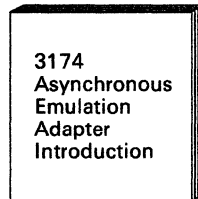

GA23-0331

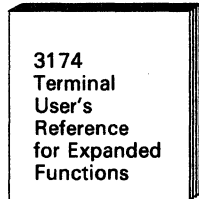

GA23-0332

For terminal users

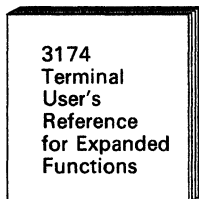

GA23-0332

- In addition, host configuration and network planning and diagnosis publications contain relevant 3174 information.
- A copy of the publications that come with each control unit should also be available at the central site (see next page).

# 3174 Publications

---

## With each control unit

(Part 2 of 2)

To set up, relocate, and operate the control unit and to handle problems

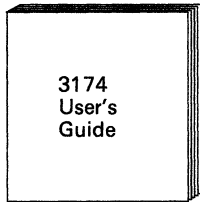

GA23-0337 (for Models 1L, 1R, 2R, and 3R)  
GA23-0333 (for Models 51R, 52R, and 53R)  
GA23-0313 (for Models 81R and 82R)

A yellow card stored in the diskette storage pocket of the control unit may help you locate this publication.

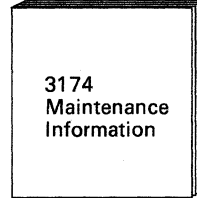

For IBM service representative  
SY27-2572 (for Models 1L, 1R, 2R, and 3R)  
SY27-2573 (for Models 51R, 52R, and 53R)  
SY27-2584 (for Models 81R and 82R)

## With features

- 3174 Encrypt/Decrypt Adapter: Customer Setup Instructions, GA23-0262
- 3174 1.2MB Diskette Drive: Customer Setup Instructions, GA23-0263
- 3174 Terminal Multiplexer Adapter: Customer Setup Instructions, GA23-0265
- 3174 Model/Communications Interface Conversion: Customer Setup Instructions, GA23-0295
- 3174 IBM Token-Ring Network 3270 Gateway: Customer Setup Instructions, GA23-0329
- 3174 Storage Expansion Feature: Customer Setup Instructions, GA23-0330
- 3174 Asynchronous Emulation Adapter: Customer Setup Instructions, GA23-0341

## Additional 3270 related publications

See the 3270 Library User's Guide, GA23-0058

## At the central site (optional)

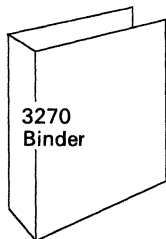

SX23-0331

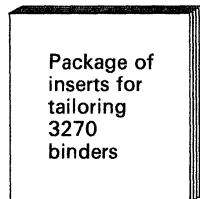

SX23-0332

At customer option, binders and inserts can be ordered to assemble:

- 3270 planning volumes
- 3270 terminal reference volumes
- A 3270 help desk volume
- Other volumes

---

## Summary of Changes

---

### Second Edition (December 1987)

New information has been added primarily for the Asynchronous Emulation Adapter feature of the 3174 Subsystem Control Unit, Configuration A, Release 3:

- Procedures H through Q in Chapter 3
- New Status Codes in Chapter 4
- ASCII Test 12 in Appendix A
- ASCII tutorials and connectors in Appendix B.







---

## 3174 Subsystem Control Unit Models

The 3174 is available in nine models:

3174 Models 1L, 1R, 2R, and 3R (see Figure 1-1)

3174 Models 51R, 52R, and 53R (see Figure 1-2 on page 1-3)

3174 Models 81R and 82R (see Figure 1-3 on page 1-3).

The **L** in the model number indicates that the control unit is attached locally to the host computer by a channel. The **R** in the model number indicates that the control unit is attached remotely to the host computer by a telecommunications link.

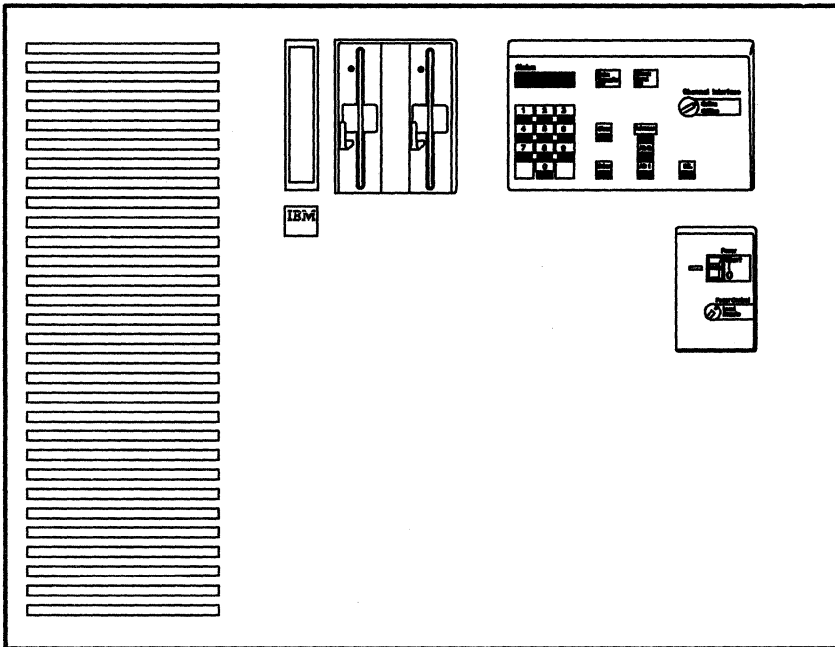

Figure 1-1. 3174 Subsystem Control Unit Models 1L, 1R, 2R, and 3R

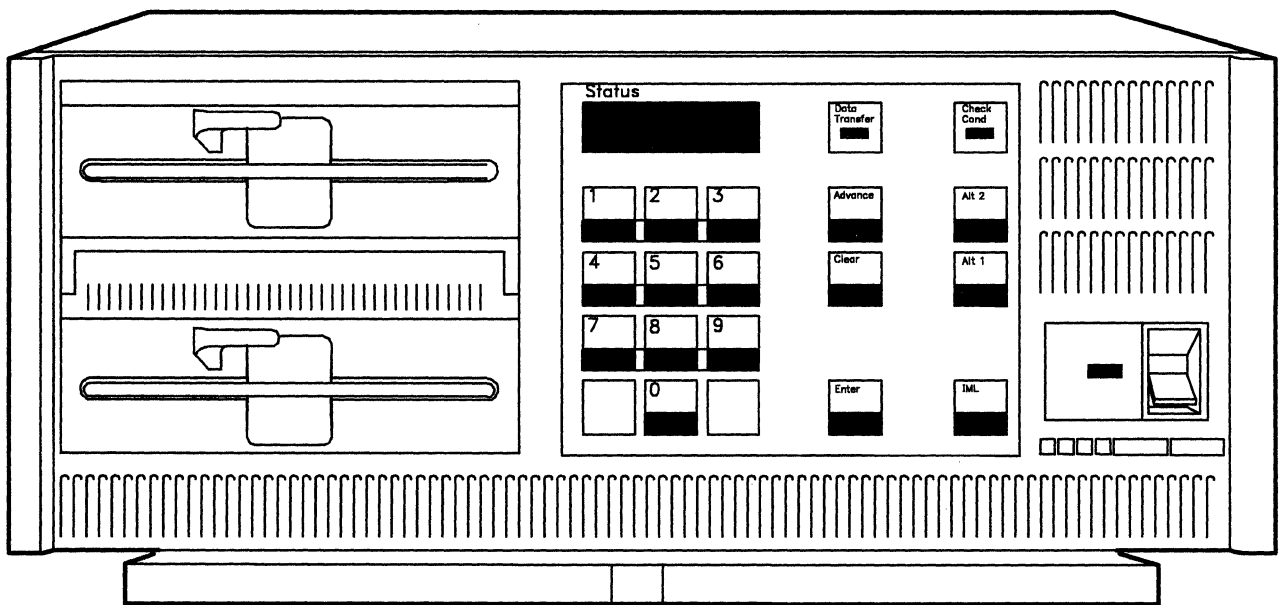

Figure 1-2. 3174 Subsystem Control Unit Models 51R, 52R, and 53R

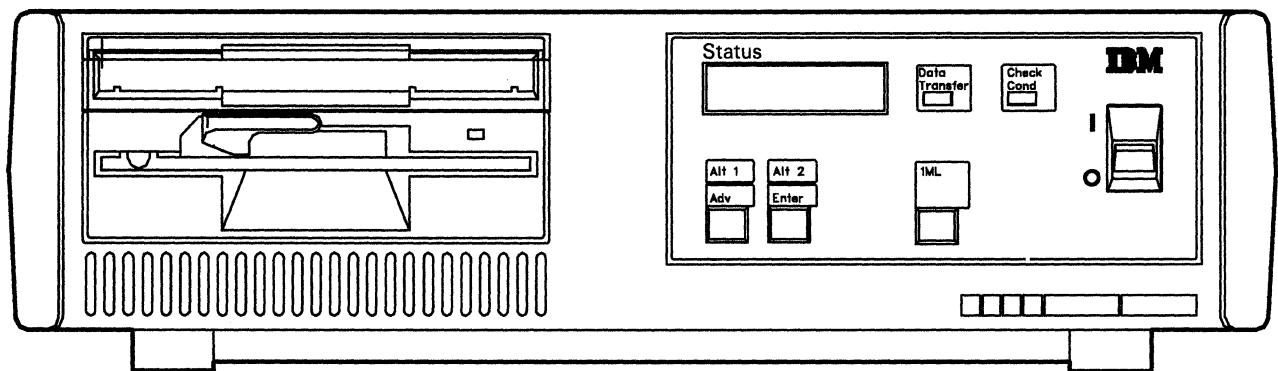

Figure 1-3. 3174 Subsystem Control Unit Models 81R and 82R

---

### 3174 Description

The 3174 links 3270 display stations and printers (from now on, display stations and printers will be referred to as *terminals*) to a central computer (host). The 3270 terminals attach to the control unit directly through the terminal adapter or indirectly through an internal Terminal Multiplexer Adapter (TMA), or through an external terminal multiplexer (for example, a 3299 Terminal Multiplexer).

Some models of the 3174 allow attachment of ASCII hosts, terminals, or printers through an optional feature called the *Asynchronous Emulation Adapter*.

One 5-1/4 inch, high-capacity, 1.2-megabyte (Mb) diskette drive is standard for all models. A second diskette drive must be installed if distributed function terminals (such as a 3290 Information Panel) are to be used for downstream load, or if an Asynchronous Emulation Adapter is installed.

**Note:** The second diskette drive is not available on models 81R and 82R.

### 3174 Model Descriptions

The 3174 Models 1L, 1R, 2R, and 3R have an integrated four-port Terminal Adapter for attaching category A terminals either directly or by one to four Terminal Multiplexer Adapters (TMAs), or with a combination of external terminal multiplexers. These models support a maximum of 32 terminals.

The 3174 Models 51R, 52R, and 53R have an integrated nine-port Terminal Adapter for attaching category A terminals directly or indirectly through external terminal multiplexers. These models support a maximum of 16 terminals.

The 3174 Models 81R and 82R have an integrated four-port Terminal Adapter for attaching category A terminals directly or indirectly through one external terminal multiplexer. These models support a maximum of 8 terminals.

- |                                |   |
|--------------------------------|---|
| <b>Model 1L</b>                | The Model 1L has an S/370-type channel adapter for Systems Network Architecture (SNA) and non-SNA for local attachment.   |
| <b>Models 1R, 51R, and 81R</b> | The Models 1R, 51R, and 81R are designed for remote operation. They contain EIA RS-232C/CCITT V.24 and CCITT V.35 interfaces for SNA/SDLC, BSC, or X.25 remote link attachment of IBM host. |
| <b>Models 2R, 52R, and 82R</b> | The Models 2R, 52R, and 82R are designed for remote operation. They contain an X.21 interface (CCITT V.11) for SNA/SDLC or X.25 remote link attachment of IBM host.                         |
| <b>Models 3R and 53R</b>       | The Models 3R and 53R are designed for remote connection to a Token-Ring Network. They contain a Token-Ring Adapter and cable for connection to a Token-Ring Network.                       |

### 3174 Models and Features

See Figure 1-4 on page 1-5 for additional 3174 subsystem features.

Feature	3174 Models	Functions
	1L, 1R, 2R, 3R	Attaches four 3270 display stations and printers directly or up to thirty-two 3270 display stations and printers through four terminal multiplexer adapters, or four terminal multiplexers, such as a 3299.
	51R, 52R, 53R	Attaches nine 3270 display stations and printers directly or up to sixteen display stations using one or two terminal multiplexers, such as a 3299.
	81R, 82R	Attaches four 3270 display stations and printers directly or eight 3270 display stations or printers through a terminal multiplexer, such as a 3299.
Terminal Multiplexer Adapter (TMA)	1L, 1R, 2R, 3R	Attaches eight 3270 Display stations and printers. The TMA connects to the terminal adapter with coaxial cable. Up to four TMAs can be installed.
Type 1 Communication Adapter (EIA/V.35)	1L, 1R, 3R, 51R	Provides a telecommunication path to a host.
Type 2 Communication Adapter (X.21)	1L, 2R, 3R, 52R	Provides a telecommunication path to a host.
Token-Ring Network 3270 Gateway	1L, 1R, 2R, 51R, 52R	Connects an IBM Token-Ring to the 3174 and serves as the gateway controller for the Token-Ring to the host. This feature includes a Token-Ring Adapter and <b>S</b> level micro-code.
Token-Ring Adapter	3R, 53R	Connects the 3174 to an IBM Token-Ring Network.
Asynchronous Emulation Adapter	1L, 1R, 2R, 3R, 51R, 52R	Provides attachment of eight ASCII display stations, printers, or hosts. The display station, printer, or host is attached directly, or through a nonswitched modem, or through a switched modem. Three AEAs, are the maximum for Models 1L, 1R, and 2R; one AEA for Models 51R and 52R.  The AEA allows ASCII devices to communicate with ASCII hosts, ASCII devices to emulate 3270 devices to communicate with 3270/IBM hosts, and 3270 terminals attached to the 3174 to emulate ASCII display stations or printers to communicate with ASCII hosts.
Second Diskette Drive	1L, 1R, 2R, 3R, 51R, 52R, 53R	Is normally used for Downstream Load diskettes when distributed function terminals are attached to the control unit. Is also required if an Asynchronous Emulation Adapter is installed in the control unit.
Encrypt/Decrypt Adapter	1R, 2R, 3R	Allows encryption of data sent to and from the host.
Storage Expansion	1L, 1R, 2R, 3R	Allows expansion to a maximum of 3 megabytes.
	51R, 52R	Allows expansion to a maximum of 1 megabyte.

Figure 1-4. 3174 Subsystem Control Unit Features

## This User's Guide and the 3174 Library

The *User's Guide* is complemented by other documents in the 3174 library:

- The *3174 Customer Extended Problem Determination* is used by skilled customer personnel at the host site (see Figure 1-5) to help the *User's Guide* audience at the remote site.
- The *3174 Customizing Guide* is used by skilled customer personnel to complete customization worksheet information.
- The *3174 Models 1L, 1R, 2R, and 3R Maintenance Information* manual (MIM), used by the IBM service representative, is another level of skilled support for the remote user of this *User's Guide*.

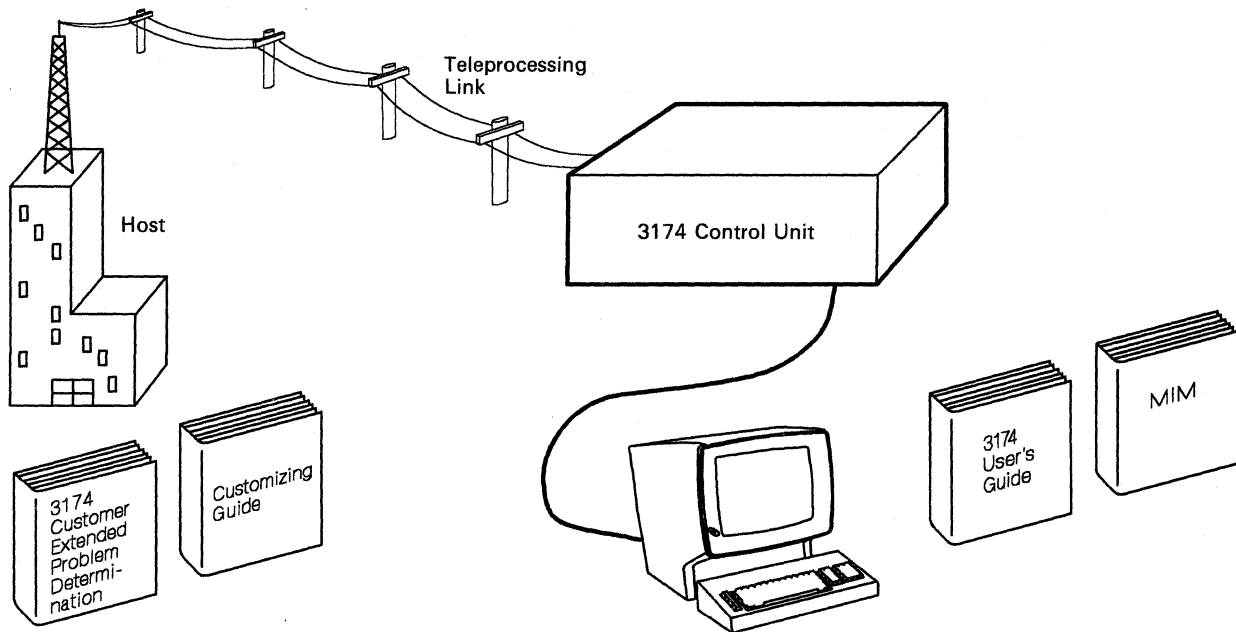

Figure 1-5. Locations of 3174 Extended Problem Determination and User's Guide

---

## The Purpose of This User's Guide

This guide is intended for use by an operator at a remote site (see Figure 1-5 on page 1-6). This user is expected to contact a help desk when an unusual problem or event occurs.

This guide may be different from other system documents you may be familiar with in that it consolidates within one document the information you will need for several tasks. The remote site user, for whom this book is intended, will use it for:

- Setting up or relocating this control unit (Chapter 5)
- Identifying the correct cables and connectors (Appendix B)
- Using diskettes when operating the control unit (Chapter 2)
- Interpreting the meaning of status codes (Chapter 4)
- Running offline and online tests (Chapter 3 and Appendix A)
- Helping to solve problems with the control units, terminal multiplexers, terminals, or the cables connecting control unit, multiplexers, and terminals (Chapter 3).

## Control Unit Setup and Relocation

You will need to know how to prepare the 3174 Subsystem Control Unit for operation after it is unpacked. Figure 1-6 on page 1-8 is an example of how to repack a control unit for relocation. The step-by-step procedures in Chapter 5 will direct you to set up or relocate this control unit and to use the Utility diskette to complete the installation of the control unit.



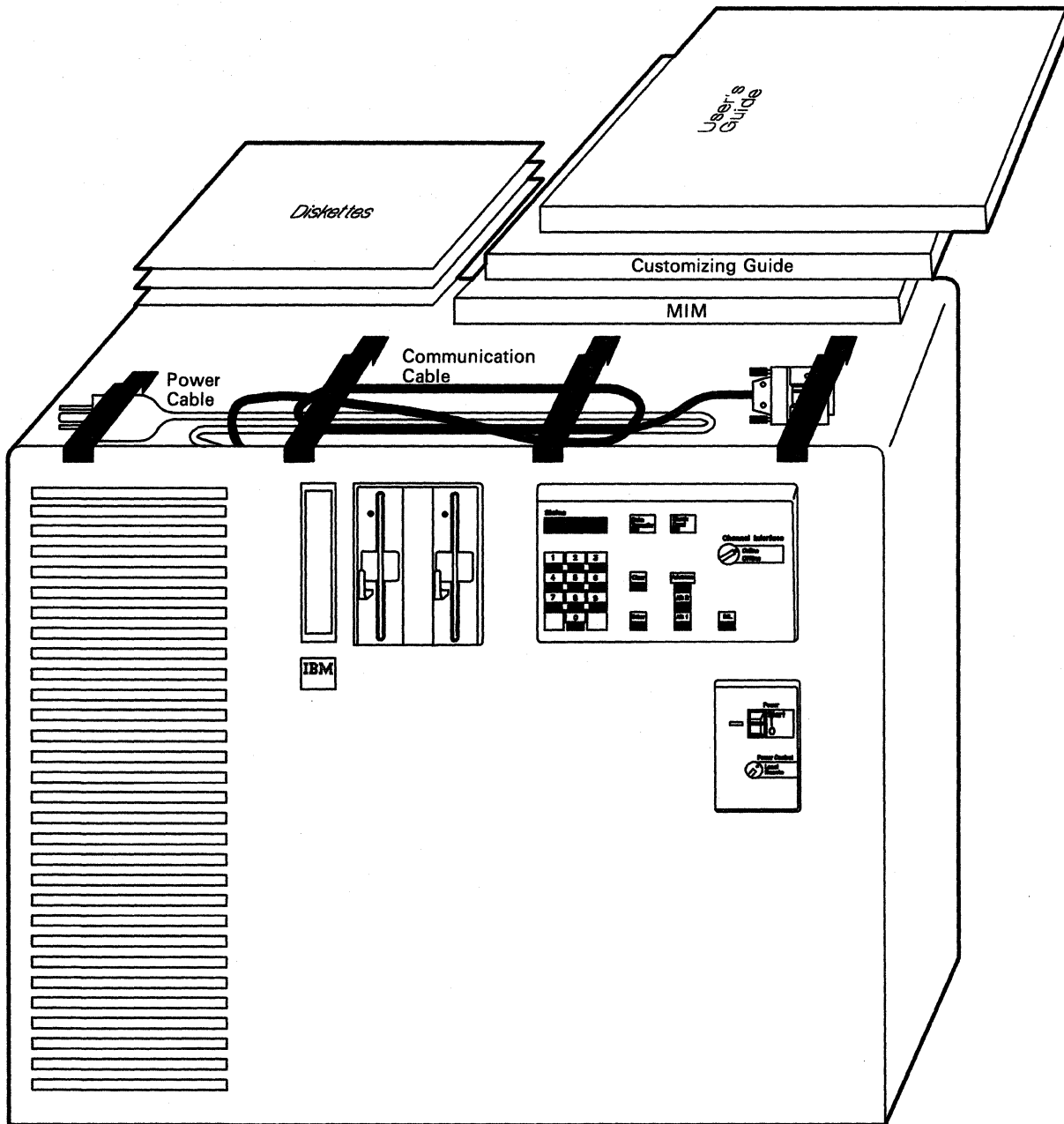
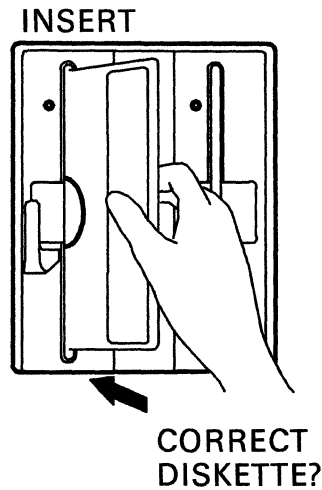

Figure 1-6. Packing the Control Unit for Relocation

## Operations with Diskettes

A common problem among all users is inserting the wrong diskette for a particular operation. It does not take long to learn how to handle and care for your diskettes, but it does take concentration at all times to use the correct diskette and avert the obvious problems.



Directions for operating the 3174 Subsystem Control Unit are presented in Chapter 2 along with a description of each switch, connector, and indicator.

## Status Codes

Your success with the 3174 Models 1L, 1R, 2R, and 3R is enhanced by the ease with which you can look up status codes in Chapter 4 and perform the actions. From the time you turn it on, the control unit will be communicating with status codes (see the following diagram): prompting you for responses, informing you about the progress of an operation, or indicating a problem that exists. Your ability to respond will depend on how familiar you are with the status code actions in Chapter 4.

# Introduction

Status Code? (Refer to Chapter 4)

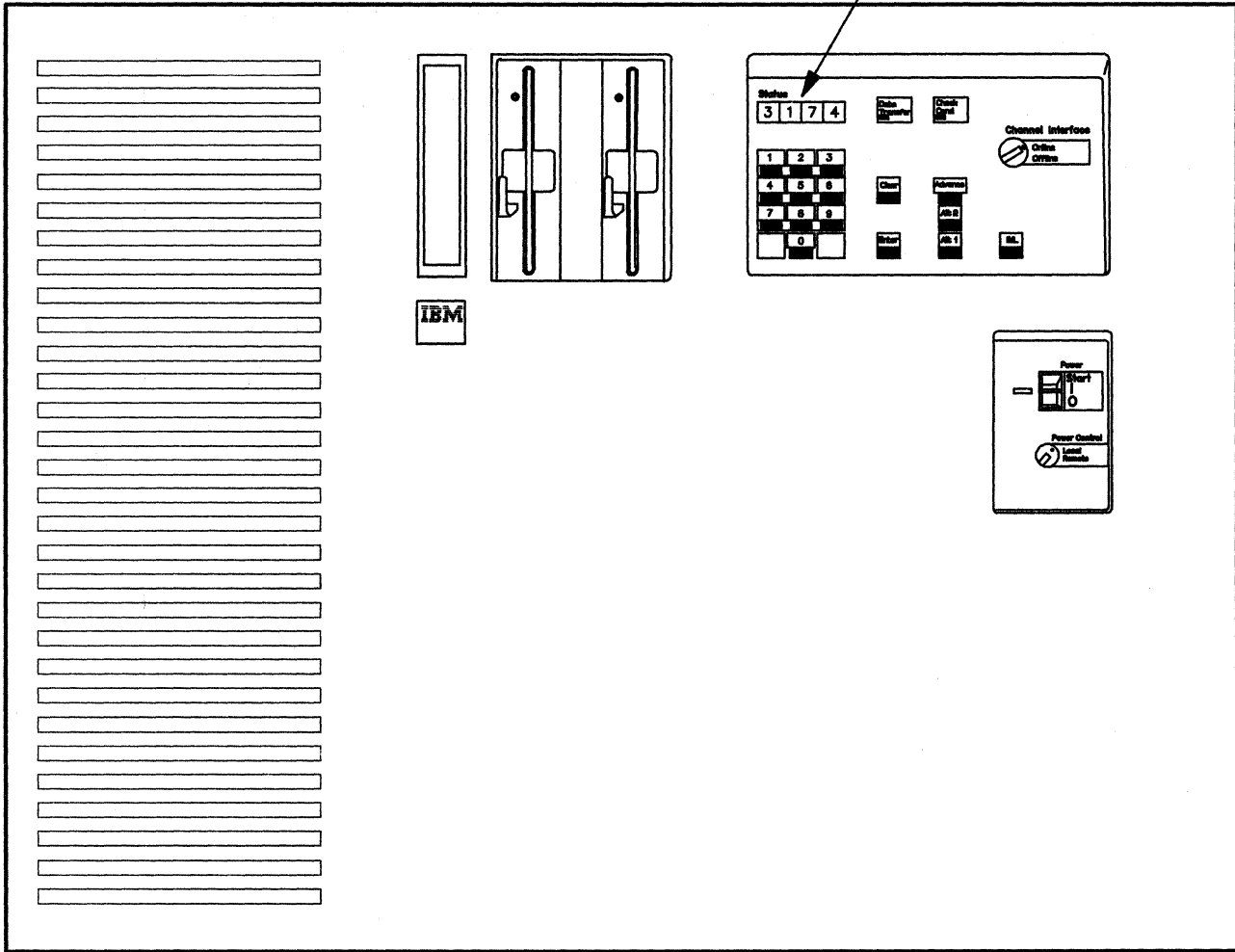

## Online and Offline Tests

As with diskettes, it will not take you long to learn how to run online tests (see Appendix A, "Online Tests" on page A-1) and offline tests (see "Offline Tests" on page 3-108). When you are working with others (while solving a problem, for instance), knowing the results of pertinent tests will enable you to help your support groups, who, in turn, will help you solve a problem.

Online and offline tests, then, are important tools to help you become more effective at your work.

## Problem Solving

Because your equipment is functioning with a variety of programs and other equipment, solving problems must be a team effort. And *you* play the most important role.

The 3174 Subsystem Control Unit and the attached terminals are usually part of a larger network, and a problem cannot be solved unless it is quickly isolated. The problem determination procedures in Chapter 3 will enable you to isolate problems quickly and effectively.

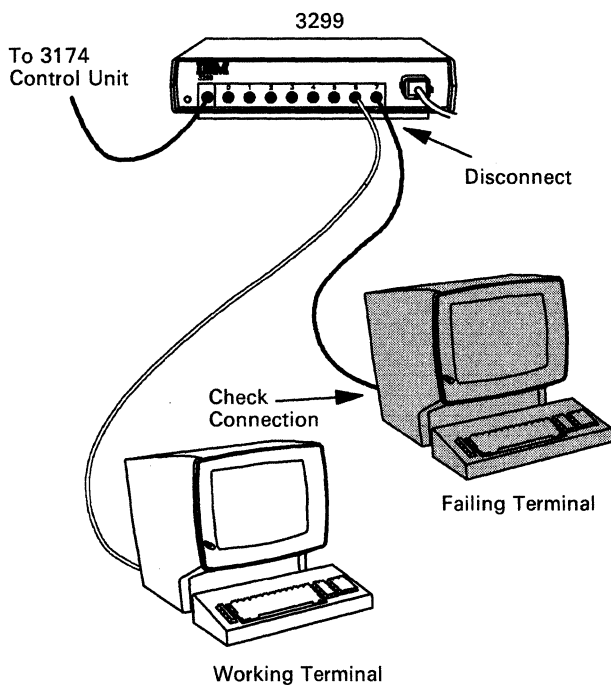

For example, many problems are the result of poor connections; so you will follow a step-by-step procedure (see "Initial Symptom/Action Table" on page 3-3) that may ask you to exchange cables or terminals to find the source of the problem.

You will be doing your part of your team's problem-solving effort when you have gathered all the information available to you before you call for assistance about a problem.



---

## Chapter 2. Operation

3174 Panels, Switches, and Indicators	2-2
Power Panel and Power Supply	2-4
Operator Panel	2-6
3174 Ports and Cables	2-8
3270 Terminal Port Addresses	2-12
For Terminals Directly Connected to the Terminal Adapter	2-12
For Terminals Indirectly Connected to the Terminal Adapter	2-12
Diskettes and Diskette Drives	2-13
Description of 3174 Diskettes	2-13
How to Handle Diskettes	2-14
How to Insert and Remove Diskettes	2-15
Inserting Diskettes	2-15
Removing Diskettes	2-16
Diskette Shipping and Receiving	2-16
Long-Term Storage of Diskettes	2-16
Making the 3174 Operational	2-17
For Model 1L	2-17
How to IML When Power Is Off	2-17
How to IML When Power Is On	2-19
For Models 1R, 2R, and 3R	2-20
Taking the 3174 Offline	2-21
For Model 1L	2-21
For Models 1R, 2R, and 3R	2-21
Displaying the Master Menu	2-22
Replacing the Encrypt/Decrypt Adapter Battery	2-24



## 3174 Panels, Switches, and Indicators

The front panel on the IBM 3174 Subsystem Control Unit contains a power panel, an operator panel, a diskette drive(s), and a diskette storage pocket. Figure 2-1 shows a front view of the 3174 control unit. Notice that only Model 1L has a **Channel Interface switch** and a **Power Control switch**. Figure 2-2 shows a rear view of the control unit.

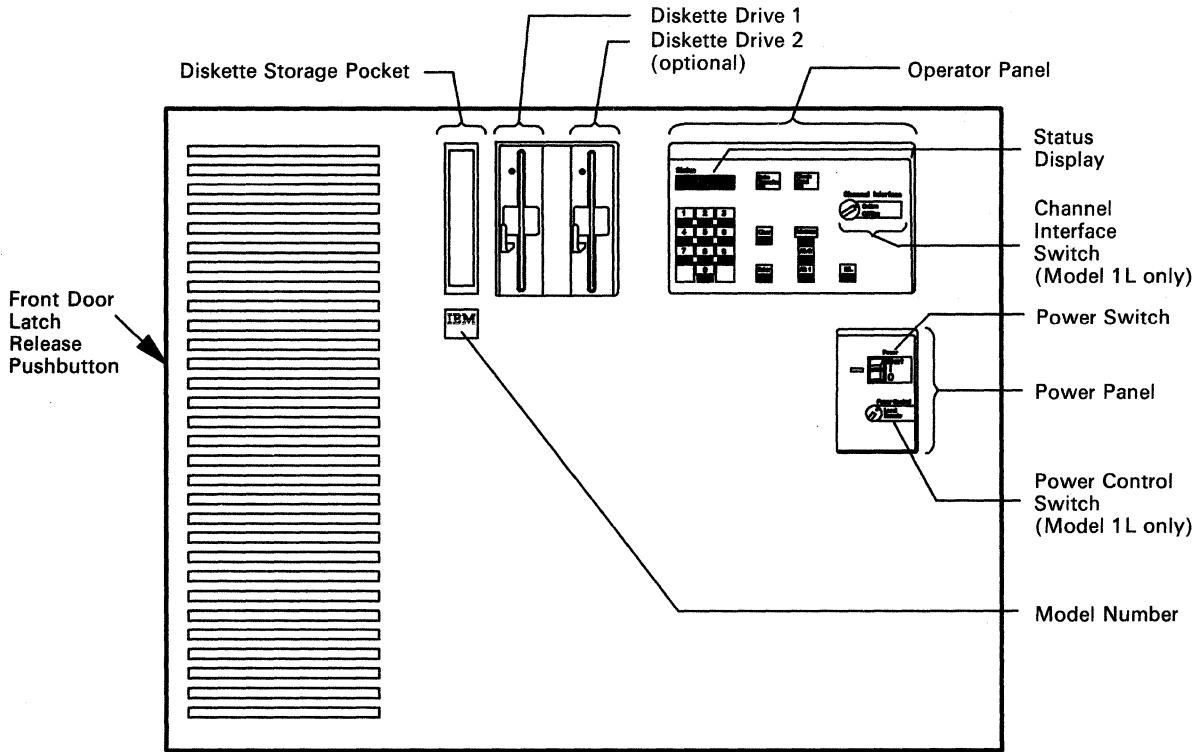

Figure 2-1. 3174 Control Unit Models 1L, 1R, 2R, and 3R – Front View

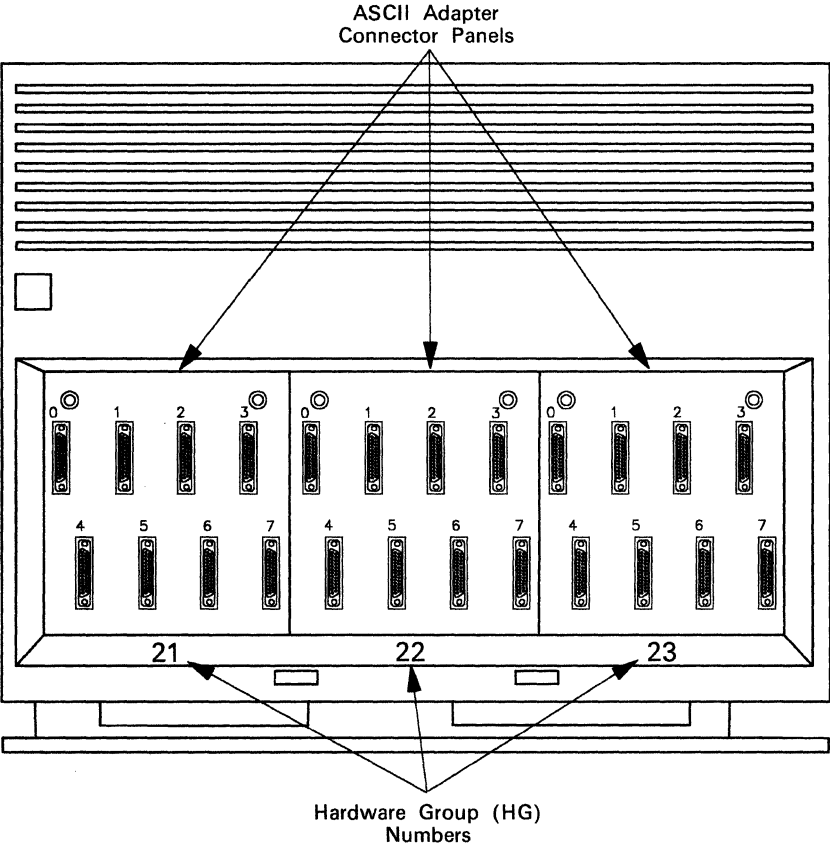

Figure 2-2. 3174 Control Unit Models 1L, 1R, 2R, and 3R – Rear View

## Power Panel and Power Supply

Figure 2-3 shows the power panel for the 3174 control unit.

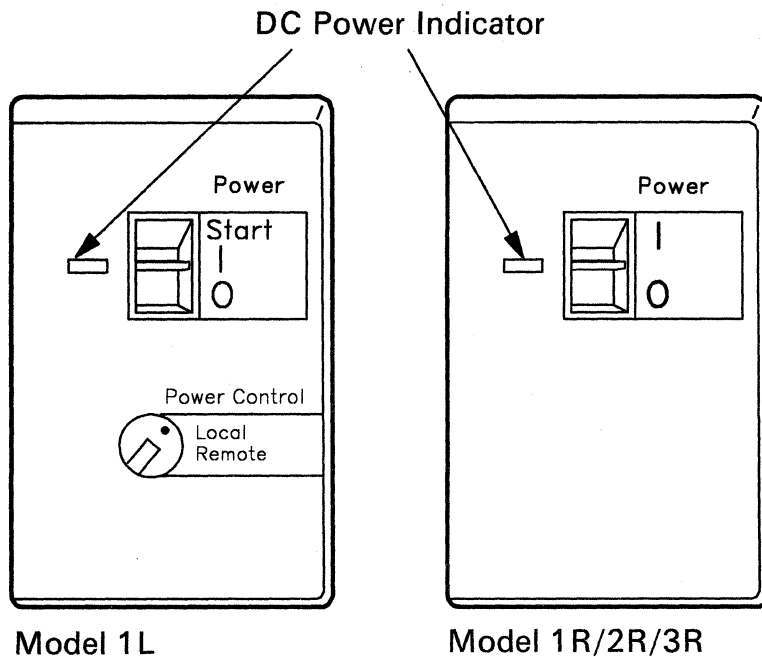

Figure 2-3. 3174 Power Panel

The functions of the power indicators and switches are as follows.

Indicator or Switch	Description
<b>DC Power</b>	This green indicator is lit when the control unit is on. It shows that the dc power supply voltages are at the correct levels.
<b>AC Power</b>	This green indicator is located on the power supply (see Figure 2-4 on page 2-5) and indicates that ac power is supplied to the control unit.
<b>Power</b>	<p><b>For Models 1R, 2R, and 3R:</b>            You turn on the Model 1R, 2R, and 3R control units by lifting the <b>Power</b> switch to <b>I</b>. An initial microcode load (IML) sequence starts when you turn on the control unit. You turn off the control unit by pressing the <b>Power</b> switch to <b>O</b>. To turn the control unit on and off, refer to "Making the 3174 Operational" on page 2-17 and "Taking the 3174 Offline" on page 2-21.</p> <p><b>For Model 1L:</b>            This switch controls power to the 3174 when the <b>Power Control</b> switch is set to <b>Local</b>. You turn on the Model 1L control unit by lifting and momentarily holding the <b>Power</b> switch in the <b>Start</b> position, and then releasing it. When released, the switch returns to the <b>I</b> position. An initial microcode load (IML) sequence starts when you turn on the control unit. You turn off the control unit by pressing the <b>Power</b> switch to <b>O</b>.</p>

**Indicator  
or Switch**

**Description**

**Power Control**

**Model 1L only:**

When this switch is in the **Local** position, power to the 3174 is controlled by the **Power** switch.

When this switch is in the **Remote** position, power to the control unit is controlled by a power sequence from the host computer. Remote power control requires a Sequence and Control cable that is plugged into the control unit power supply (see Figure 2-4).

**Note:** To use remote power control, the **Power** switch must be in the I (on) position.

**Warning:** If your control unit does not have a Sequence and Control cable, do not turn the Power Control switch to Remote. To do so would turn off the 3174.

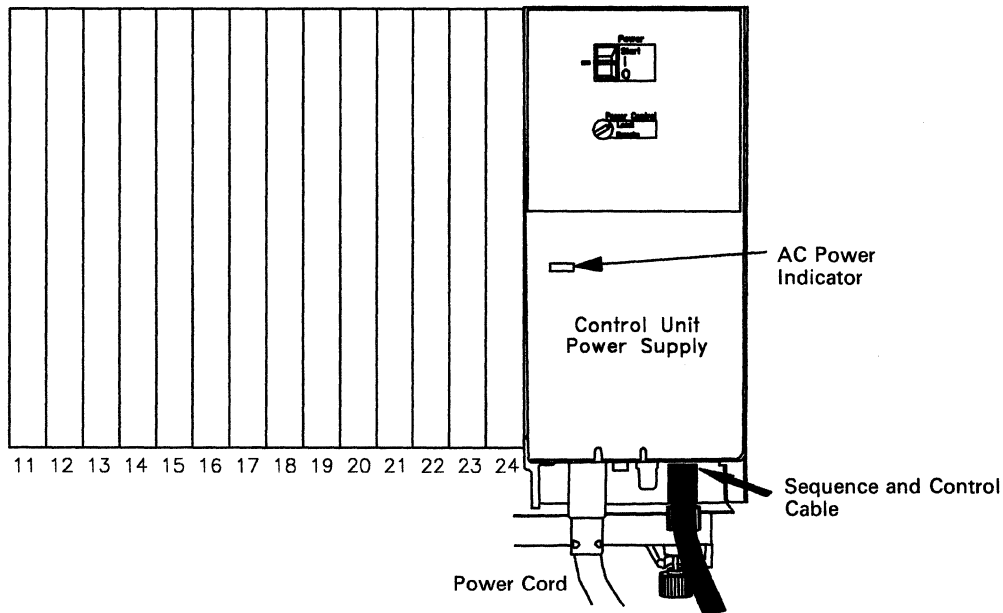

Figure 2-4. Sequence and Control Cable and Connector

## Operator Panel

The operator panel for the 3174 control unit is shown in Figure 2-5.

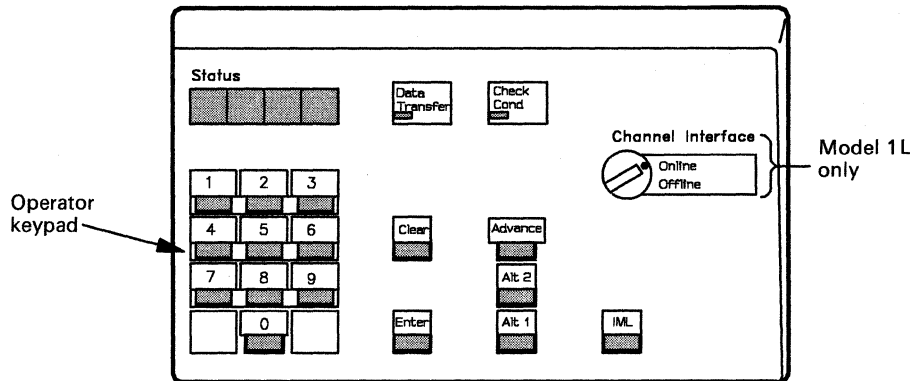

Figure 2-5. 3174 Operator Panel

The functions of the indicators and controls on the operator panel are as follows.

Indicator or Control	Description
<b>Status</b>	These four indicators display numeric status codes or keypad input.
<b>Check Cond</b>	This indicator is lit when the control unit has a major hardware or microcode failure.
<b>Data Transfer</b>	This indicator is lit or blinking when the control unit is transmitting data to the host or receiving data from the host.
<b>Offline</b>	<b>Model 1L only:</b> This indicator is lit after the <b>Channel Interface</b> switch is turned to <b>Offline</b> , and indicates that the control unit is logically disconnected from the host.
<b>IML</b>	When this key is pressed, all indicators on the operator panel are lit and <b>8888</b> is displayed in the <b>Status</b> indicators. When the key is released, IML tests run and, if no errors are found, operational microcode is loaded into control unit storage from a customized Control diskette in drive 1 or 2. A normal IML is completed when <b>501</b> appears in the <b>Status</b> display. A <b>3174</b> appears in the <b>Status</b> display when the host system brings the control unit online. If a failure occurs during any portion of the IML sequence, a status code appears in the <b>Status</b> display.  The <b>IML</b> key is also used with the <b>Alt 1</b> and <b>Alt 2</b> keys.

<b>Indicator or Control</b>	<b>Description</b>
<b>Alt 1</b>	<p><b>Alt 1</b> is pressed in conjunction with either <b>IML</b> or a power-on sequence to do any of the following:</p> <ul style="list-style-type: none"> <li>• Customer Setup tests (see the <i>Setup and Relocation Instructions</i> for your control unit model)</li> <li>• Customizing procedures</li> <li>• Specific tests.</li> </ul> <p>The Utility diskette contains offline testing and customizing microcode.</p> <p>An <b>Alt 1 IML</b> (see “Alt 1 IML Tests” on page 3-110) causes a <b>40</b> prompt to appear in the <b>Status</b> display. You then either press <b>Enter</b> to display a menu of procedures (Master Menu) at the terminal connected to port 0, or make a keypad entry and press <b>Enter</b> to request one of the specified functions.</p>
<b>Alt 2</b>	<p><b>Alt 2</b> (see “Alt 2 IML Tests” on page 3-108) is pressed in conjunction with either <b>IML</b> or a power-on sequence to check out the control unit. The <b>Alt 2 IML</b> is used at feature installation, or whenever hardware problem determination is required. <b>Alt 2 IML</b> will select only diskette drive 1 as the microcode loading device. The Utility diskette contains the offline testing microcode and must remain in the diskette drive.</p> <p>A <b>2082</b> status code indicates the successful completion of testing.</p>
<b>Enter</b>	<p>Pressing <b>Enter</b> signals microcode to do the function indicated in the <b>Status</b> display. <b>Enter</b> is also used when the control unit is operating to display any status codes that might be present.</p>
<b>Clear</b>	<p>Pressing <b>Clear</b> erases the characters in the <b>Status</b> display that were entered from the operator keypad.</p>
<b>Keypad</b>	<p>The numeric keypad is used to input variables in response to subsystem prompts. Numbers appear in the <b>Status</b> display (from left to right) as the keys are pressed.</p>
<b>Advance</b>	<p>This pushbutton is used to allow more keypad input (as many as four digits at a time) or to display additional status code fields in the <b>Status</b> display.</p>
<b>Channel Interface</b>	<p><b>Model 1L only:</b></p> <p>When this switch is set to <b>Offline</b> and the offline indicator is lit, the control unit is logically disconnected from the host channel (offline). In this condition, power to the Model 1L control unit can be turned off or an IML sequence can be started.</p> <p>When the switch is set to <b>Online</b> and the offline indicator is not lit, the control unit is logically connected to the host channel.</p>

## 3174 Ports and Cables

The next four figures identify ports and cables, and show sample cabling layouts, for Models 1R and 2R (Figure 2-6), Model 3R (Figure 2-7 on page 2-9), Model 1L (Figure 2-8 on page 2-10), and ASCII panels in the rear of the control unit (Figure 2-9 on page 2-11). For additional connector details, see “3174 Cables, Plugs, and Accessories” on page B-24.

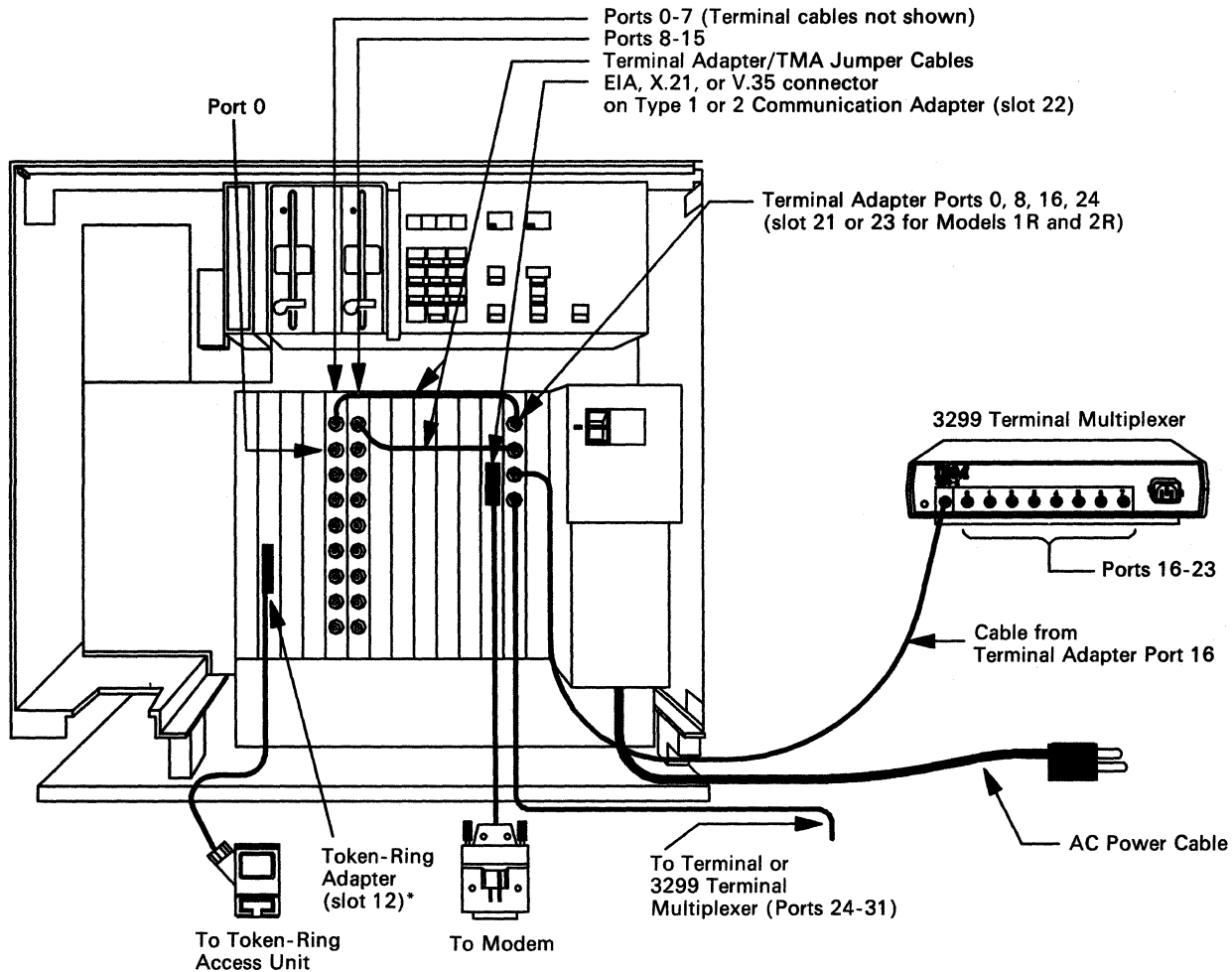

Figure 2-6. Sample Cabling Layout for Models 1R and 2R

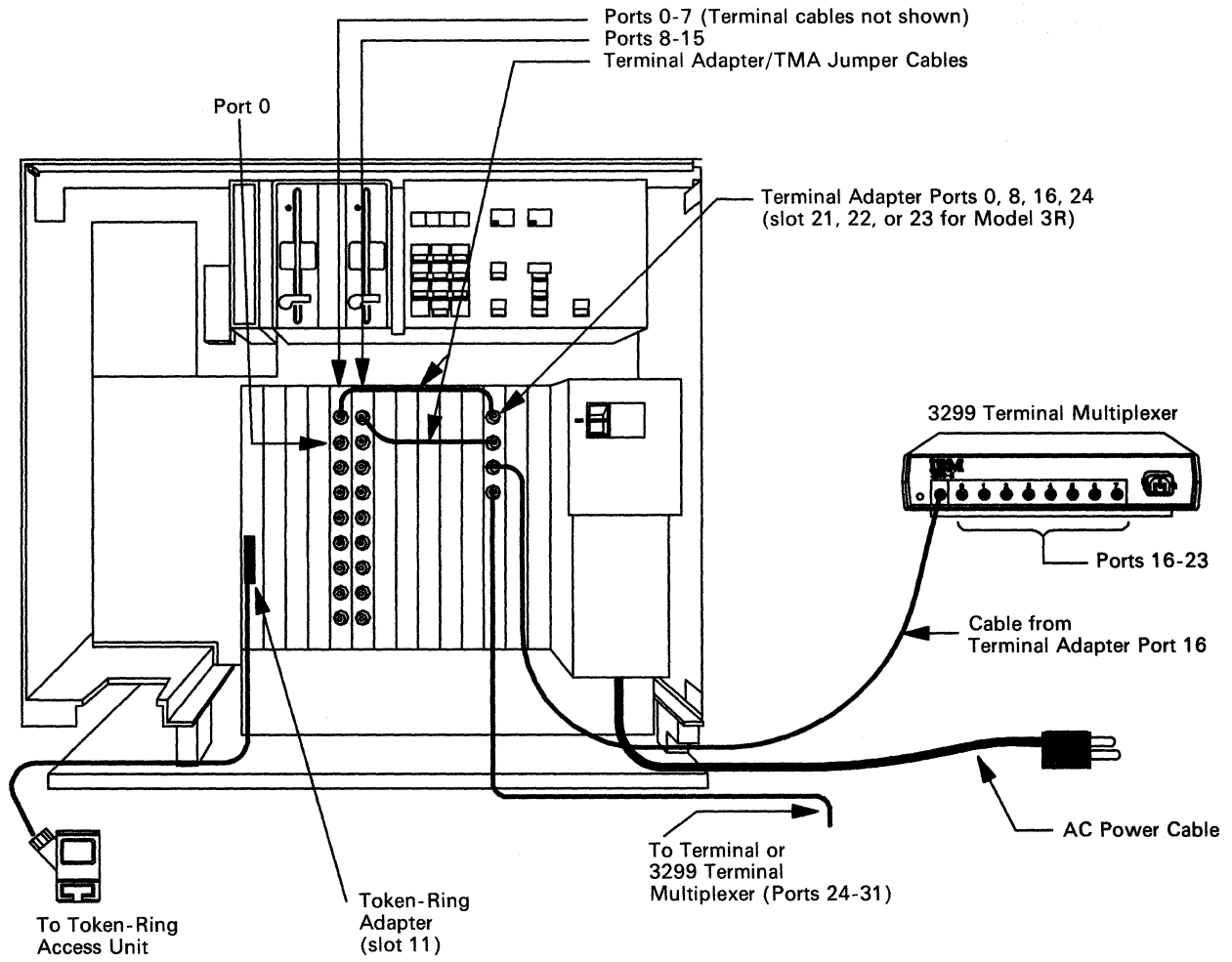
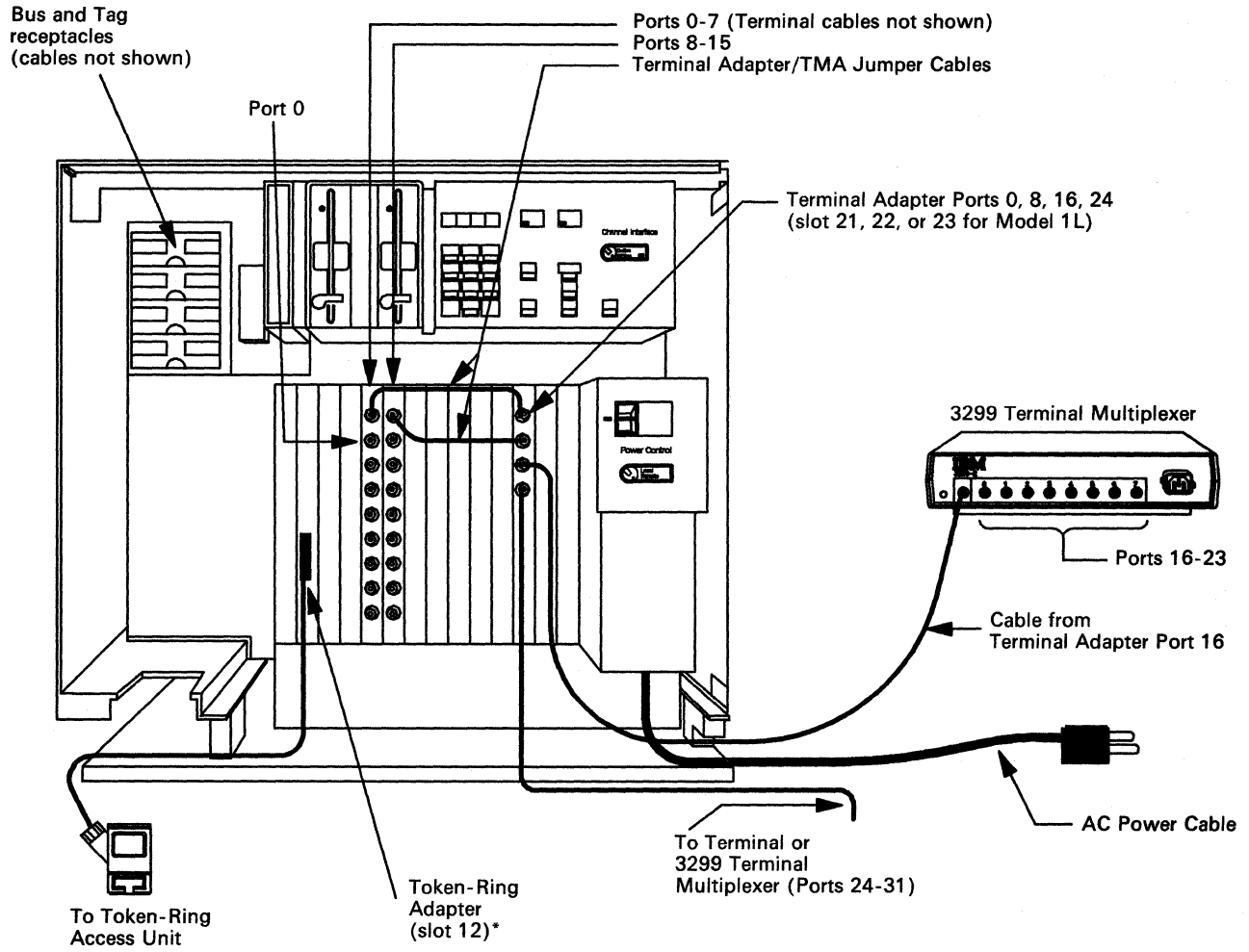

Figure 2-7. Sample Cabling Layout for Model 3R



# 3174 Ports and Cables



\* Only in control units with the IBM Token-Ring Network 3270 Gateway feature.

Figure 2-8. Sample Cabling Layout for Model 1L

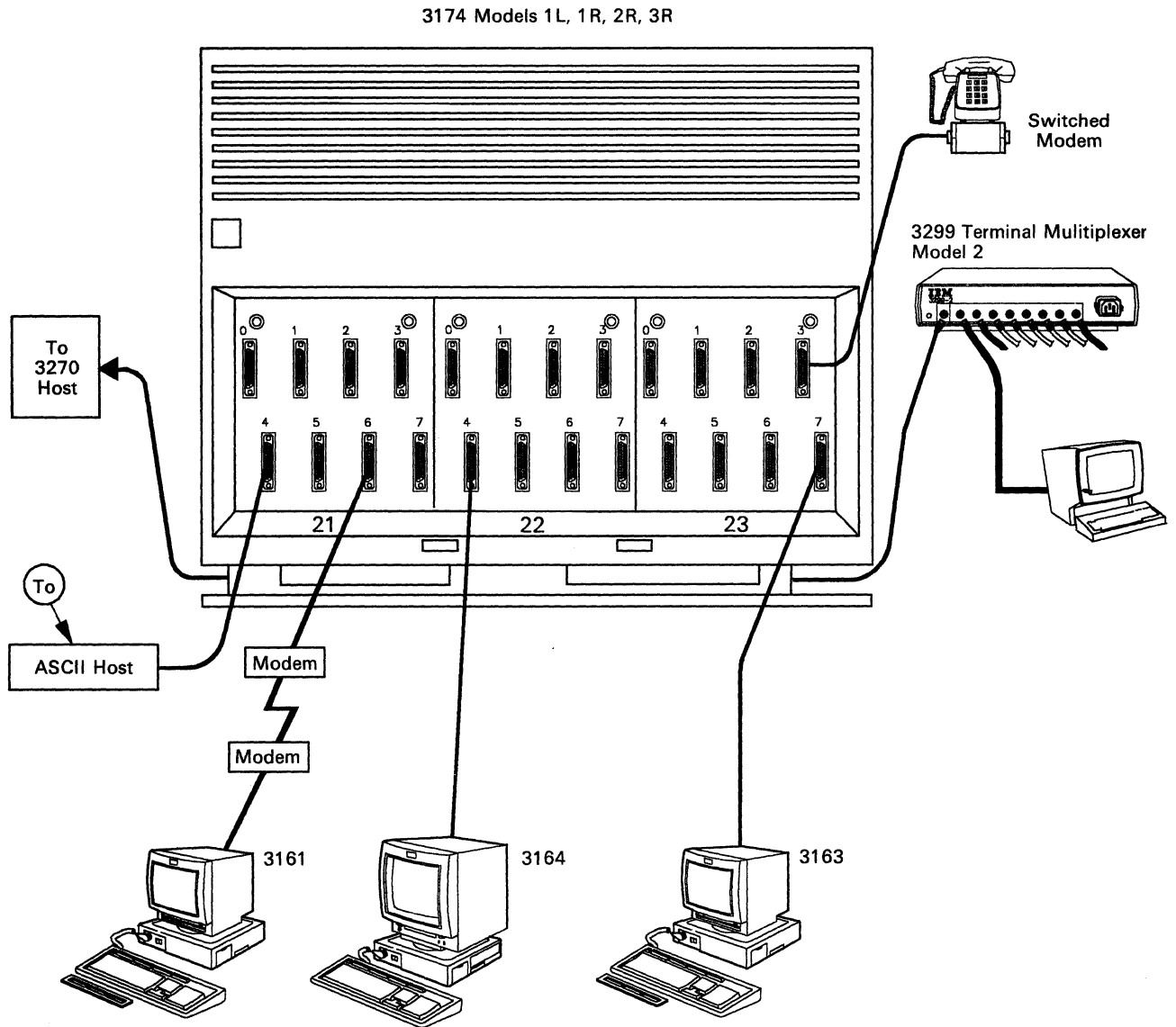

**Note:** This figure shows an overview of a 3174 with three Asynchronous Emulation Adapter features. The terminals can be any of the ASCII terminals.

Figure 2-9. Sample ASCII Connection Diagram

---

## 3270 Terminal Port Addresses

This section explains how to determine a terminal's port address. To determine a terminal's port address (also known as *port number*), use the cabling worksheets and physical connection diagram for your subsystem to find how the terminal is connected to the 3174. (See Figure 3-3 on page 3-14 for an example of a cabling worksheet, and Figure 3-5 on page 3-17 for an example of a physical connection diagram.)

There are two ways that a terminal can be connected to the 3174:

- *Directly*, where the terminal is connected to a Terminal Adapter port (located in card location 22 or 23)
- *Indirectly*, where the terminal is connected to a Terminal Adapter port via a 3299 or a TMA.

### For Terminals Directly Connected to the Terminal Adapter

If a terminal is *directly* connected to the Terminal Adapter, its port number, or terminal port address, is the same as the Terminal Adapter port number. For example, if the terminal is connected to Terminal Adapter port 16, its terminal port address is 16.

### For Terminals Indirectly Connected to the Terminal Adapter

If a terminal is *indirectly* connected to a Terminal Adapter port via a 3299 or a TMA, its port number, or terminal port address, is determined by adding the number of the Terminal Adapter port to which the terminal multiplexer is connected to the number of the 3299 or TMA port to which the terminal is connected. For example:

Terminal Adapter Port		3299 or TMA Port	=	Terminal Port Address
0	+	2	=	2
8	+	4	=	12
16	+	3	=	19
24	+	7	=	31

---

## Diskettes and Diskette Drives

This section describes the different diskettes used with the 3174 control unit, how to handle diskettes, and how to insert diskettes into, and remove them from, the diskette drive. In addition, this section provides information on diskette shipping, receiving, and long-term storage.

### Description of 3174 Diskettes

A diskette (shown below) is a thin, flexible magnetic disk and a protective jacket, in which the disk is permanently enclosed.

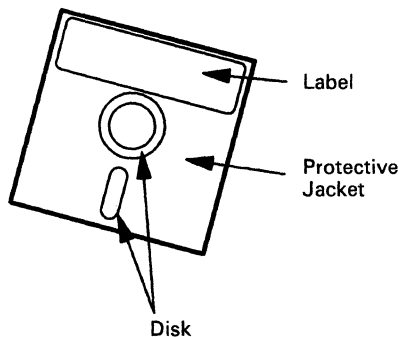

**Warning:** Do NOT try to remove the flexible magnetic disk from its protective jacket (black).

The function of the diskette is to store information that the 3174 Subsystem Control Unit and attached 3179G or 3290 display stations need for operation. The types of diskettes associated with the 3174 are the Control diskette, the Utility diskette, the Downstream Load (DSL) diskette, the RPQ diskette, and the Encrypt/Decrypt diskette.

The **Control diskette** is used for the daily operation of the 3174. This diskette contains operational microcode and configuration information that is unique to your organization. For example, the Control diskette contains information that describes all terminals attached to the 3174.

The **Utility diskette** contains the microcode necessary to run various control unit utilities, including customization and offline tests (diagnostics).

The **DSL diskette** is used with the Control diskette for the daily operation of the 3174 when 3179G or 3290 display stations are attached or when the AEA feature is installed. This diskette contains test and configuration information that is unique to your organization.

The **AEA diskette** contains Asynchronous Emulation Adapter code, which is to be merged onto the **DSL diskette** when the AEA feature is installed in the control unit. 3290 display stations are attached. This diskette contains test and configuration information that is unique to your organization.

The **RPQ diskette** contains the changes or additions to the functional capabilities of the 3174 to fulfill your unique data processing requirements.

The **Encrypt/Decrypt diskette** is used to enter and verify the Master Key Value in 3174 Models 1R, 2R, and 3R.

## How to Handle Diskettes

Follow the required diskette-handling procedures as shown here. Remember that a telephone is a source of a magnetic field.

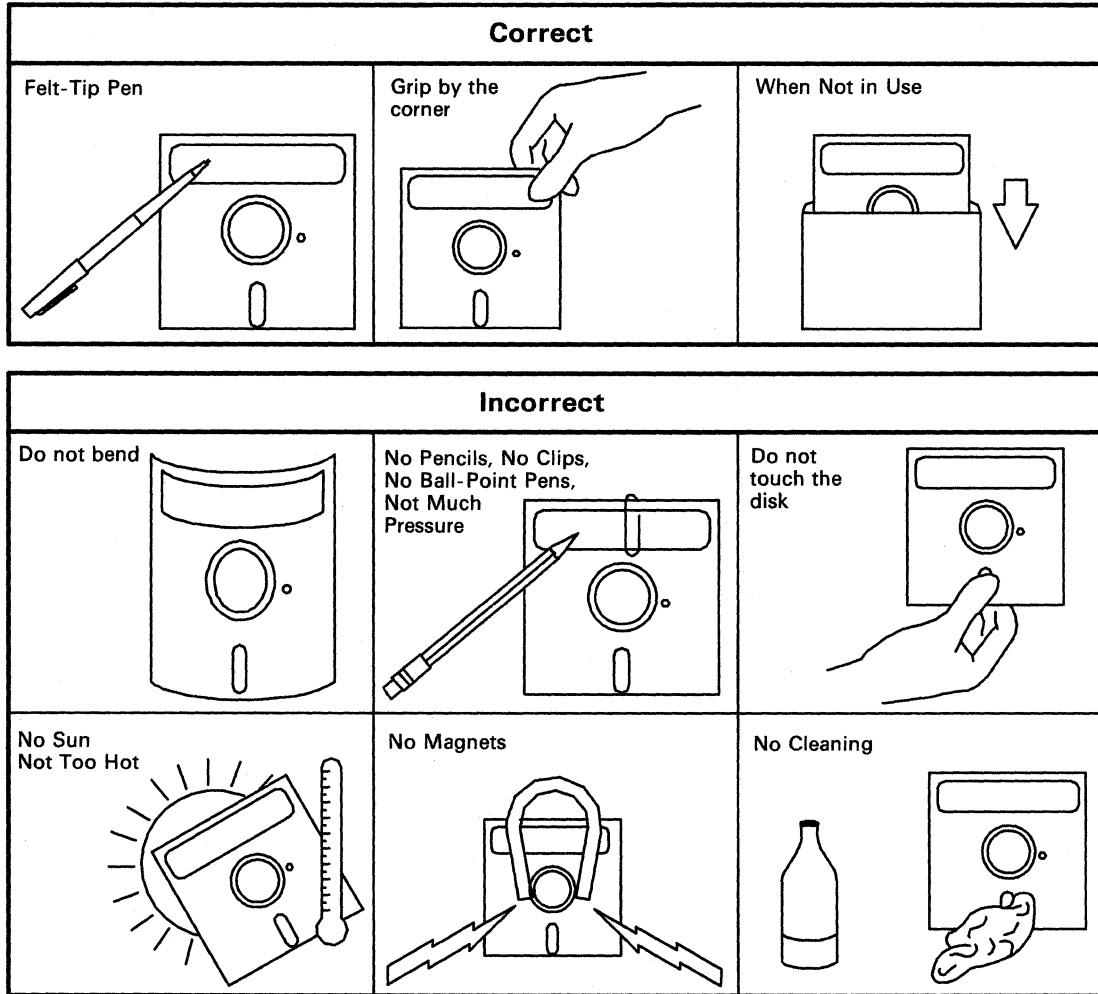

## How to Insert and Remove Diskettes

These procedures describe how to insert diskettes into, and remove them from, the diskette drives. Diskette drive 1 is shown throughout these procedures. The diskette being inserted may be any valid control unit diskette.

Diskettes for the control unit are kept in the storage pocket next to the diskette drive(s).

### Inserting Diskettes

- 1** Remove the diskette from the protective envelope.

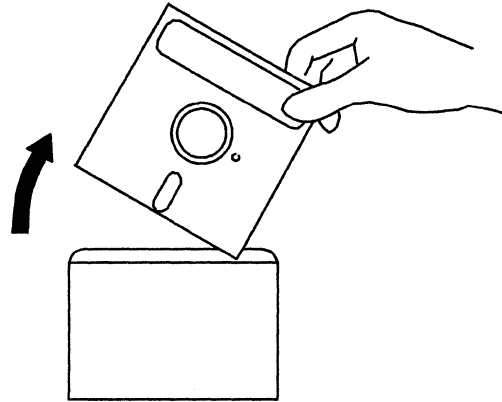

- 2** Make sure that the drive lever is up.

Holding the diskette by the label with the label facing left, insert the diskette into drive 1 (left drive). Close the drive lever.

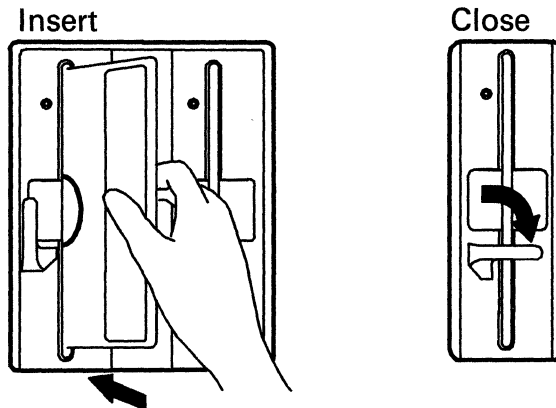

## Diskettes and Diskette Drives

### Removing Diskettes

**Warning:** Do not remove a diskette while the diskette drive is turning. Make sure that the red indicator on the diskette drive is not lit before you remove diskettes.

- 1 Open the lever to diskette drive 1 (left drive). Grip the diskette by the label, and remove the diskette from the drive.

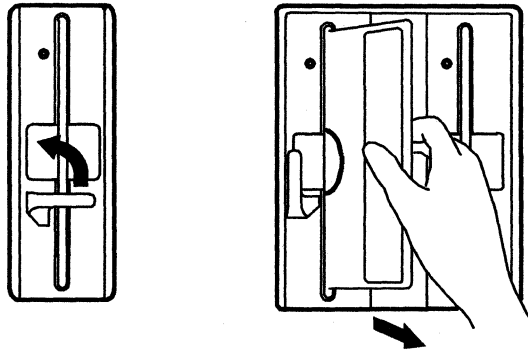

- 2 Place the diskette in the protective envelope.

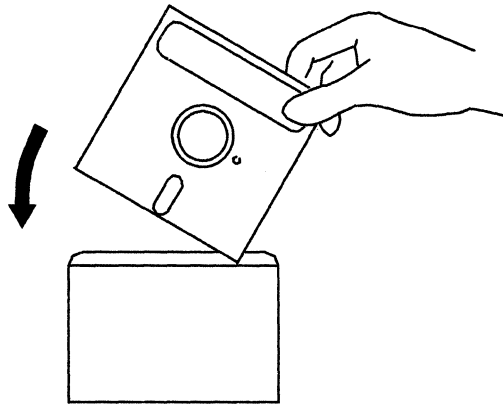

### Diskette Shipping and Receiving

Diskettes should always be shipped inside the original shipping container; an ordinary envelope does not provide enough protection. Label the package **DO NOT EXPOSE TO EXCESSIVE HEAT** (temperatures above 51.5° C or 125° F) **OR DIRECT SUNLIGHT**.

Upon receiving diskettes, check for damage to the shipping container or to the diskettes. Save the shipping container for storing the diskettes for later shipment.

### Long-Term Storage of Diskettes

Place diskettes in their protective envelopes, and store them in the following environment:

- Temperature: 10° to 51.5°C (50° to 125°F)
- Relative humidity: 8% to 80%.

Before using a diskette that has been exposed to temperatures outside the above environment range, allow the diskette to adjust to room temperature for 5 minutes. The diskette can be removed from its shipping container while adjusting to room temperature, but should be kept in its protective envelope.

---

## Making the 3174 Operational

An Initial Microcode Load (IML) sequence causes some basic control unit tests to run. If these tests run without error, microcode is loaded from the diskette drive that has a customized Control diskette correctly installed and the drive lever closed. If you have two diskette drives, the Control diskette should be in drive 1. If you have a Downstream Load (DSL) diskette, it should be in drive 2.

You can start a normal IML in one of two ways:

- Press **IML** while power is on (for Model 1L, the **Offline** indicator must be lit).
- Turn on the 3174 (also called a *power-on IML*).

To IML the 3174, do the steps listed for your 3174 model number.

If you get unexpected results at any time, refer to Figure 3-1 on page 3-3.

### For Model 1L

The following procedures describe how to IML the Model 1L when power is off (green dc indicator not lit – see “How to IML When Power Is Off”), and when power is on (green dc indicator lit – see “How to IML When Power Is On” on page 2-19).

#### How to IML When Power Is Off

- 1** Make sure that a customized Control diskette is correctly installed in diskette drive 1 (refer to “How to Insert and Remove Diskettes” on page 2-15).

If you have a DSL diskette, make sure that it is in drive 2.

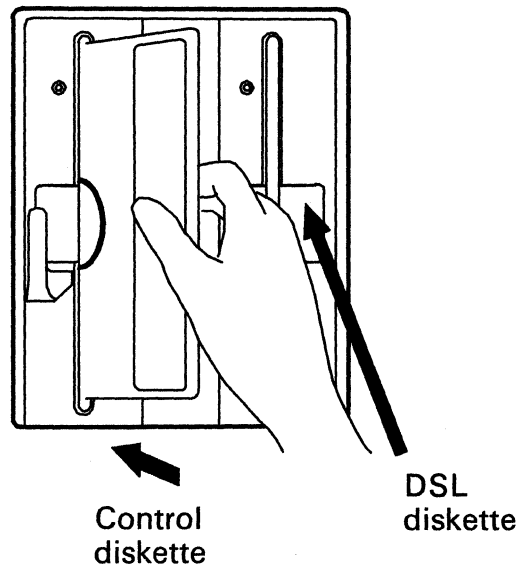



## Making the 3174 Operational

- 2** Turn the **Channel Interface** to **Online**.

### Channel Interface

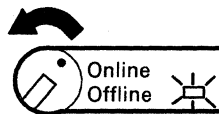

- 3** Turn the **Power Control** switch to **Local**.

### Power Control

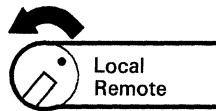

- 4** Lift the **Power** switch to **Start**, and release it (it returns to the **I** position). This starts a normal IML. IML progress codes should appear in the **Status** display. IML takes about 4 minutes, and is completed when **501** appears in the **Status** display.

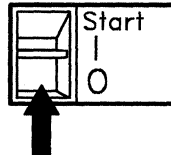

If required, notify the host operator to bring the 3174 online, at which time 3174 will be displayed.

- 5** If your control unit has a Sequence and Control cable for remote power control of the control unit (see Figure 2-4 on page 2-5 for cable location), set the **Power Control** switch to **Remote**.

### Power Control

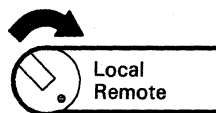

**How to IML When Power Is On**

- 1 Make sure that a customized Control Diskette is correctly installed in diskette drive 1 (refer to "How to Insert and Remove Diskettes" on page 2-15).

If you have a DSL Diskette, make sure that it is in drive 2.

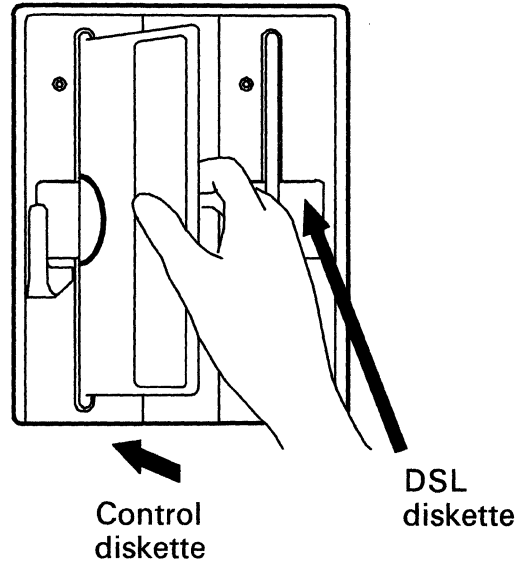

- 2 Is the **Offline** indicator lit?

**Yes** — Go to step 3.

**No** — Turn the **Channel Interface** switch to **Offline**, and wait up to 30 seconds. If the offline indicator lights, go to step 3. If the offline indicator does not light, refer to "Forcing the Control Unit Offline" on page 3-11.

**Channel Interface**

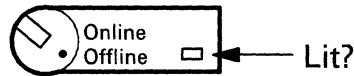

- 3 Press and release **IML**. This starts a normal IML. IML progress codes should appear in the **Status** display. Continue with step 4.

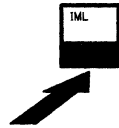

- 4 Set the **Channel Interface** switch to **Online** (the offline indicator may turn off). IML takes about 4 minutes, and is completed when **501** appears in the **Status** display.

If required, notify the host operator to bring the 3174 online, at which time **3174** will be displayed.

**Channel Interface**



## For Models 1R, 2R, and 3R

If you get unexpected results at any time, refer to Figure 3-1 on page 3-3.

- 1 Make sure that a customized Control Diskette is correctly installed in diskette drive 1 (refer to "How to Insert and Remove Diskettes" on page 2-15). If you have a DSL Diskette, it should be in drive 2.

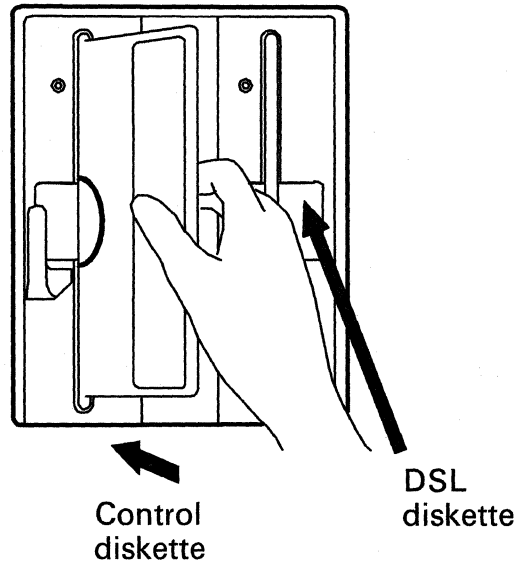

- 2 Is the green dc power indicator lit?

**No** — Lift the **Power** switch to the **I** position. This starts a normal IML.

**Yes** — Press and release **IML**. This starts a normal IML.

IML progress codes should appear in the **Status** display. IML takes about 4 minutes, and is completed when **501** appears in the **Status** display.

If required, notify the host operator to bring the 3174 online, at which time **3174** will be displayed.

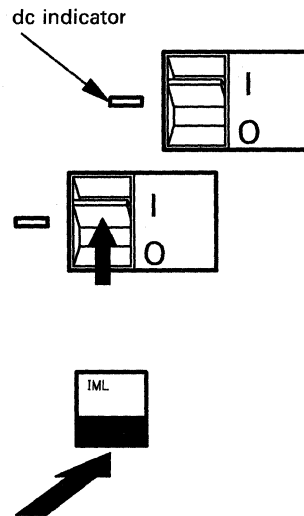

---

## Taking the 3174 Offline

To take the 3174 offline, do the steps listed for your 3174 model number.

### For Model 1L

- 1** Notify the host operator to take the control unit offline.  
Set the **Channel Interface** switch to **Offline**, and wait up to 30 seconds for the offline indicator to light.

#### Channel Interface



- 2** Did the offline indicator light?  
**No** — Refer to “Forcing the Control Unit Offline” on page 3-11.  
**Yes** — The system is now offline.

#### Channel Interface

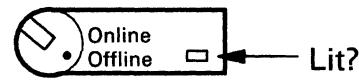

You can now do either *a* or *b*:

- a. Turn off the control unit by setting the **Power** switch to **O**.
- b. Leave power on and do either customizing or offline testing (see “Offline Tests” on page 3-108).

To make the system operational again, refer to “Making the 3174 Operational” on page 2-17.

---

### For Models 1R, 2R, and 3R

- 1** Notify the host operator to take the control unit offline.
- 2** You can now do either *a* or *b*:
- a. Turn off the control unit by setting the **Power** switch to **O**.
  - b. Leave power on and do either customizing or offline testing (see “Offline Tests” on page 3-108).
- To make the system operational again, refer to “Making the 3174 Operational” on page 2-17.

---

## Displaying the Master Menu

The Master Menu presents all the utility functions available on the Utility diskette. This menu is used primarily for customizing.

**Notes:**

1. A 3278 or similar terminal must be attached to port 0 and turned on.
2. This procedure interrupts all host services. Notify users if necessary.

To display the Master Menu, do the following steps:

- 1** Ask the host operator to take the control unit offline.

Insert a Utility Diskette into diskette drive 1.

For Model 1L, go to step 2.

For Models 1R, 2R, and 3R, go to step 3.

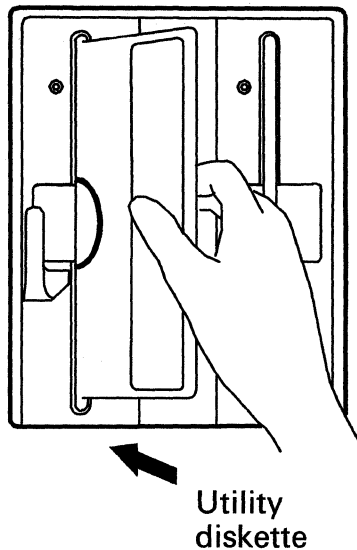

- 
- 2** Set the **Channel Interface** switch to **Offline**, and wait for the offline indicator to light.

**Note:** If the offline indicator does not come on, refer to "Forcing the Control Unit Offline" on page 3-11.

### Channel Interface

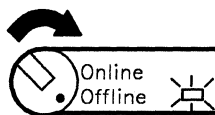

- 
- 3** Press and hold down **Alt 1** while you press and release **IML**. Then release **Alt 1**.

**Notes:**

1. If power is off, lift and release the **Power** switch instead of pressing **IML**.
2. If **40** does not appear in the **Status** display within 5 seconds, repeat this step.

### Operator Panel

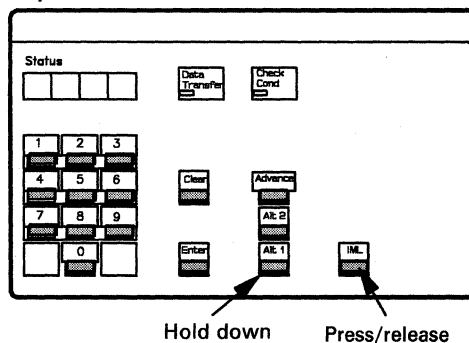

- 4** When 40 appears in the Status display, press and release Enter.

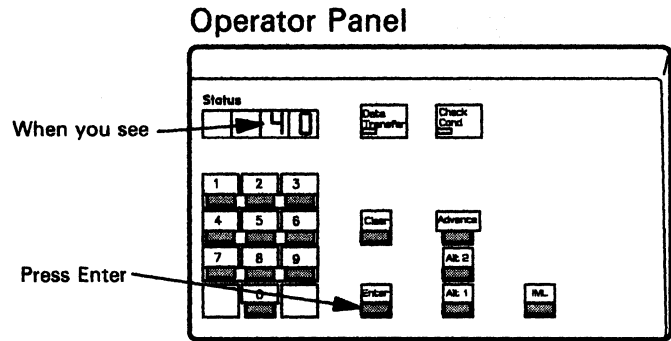

- 5** When 7000 appears in the Status display, the Master Menu is displayed at the terminal attached to port 0. Refer to the *3174 Customizing Guide* for more operating information.

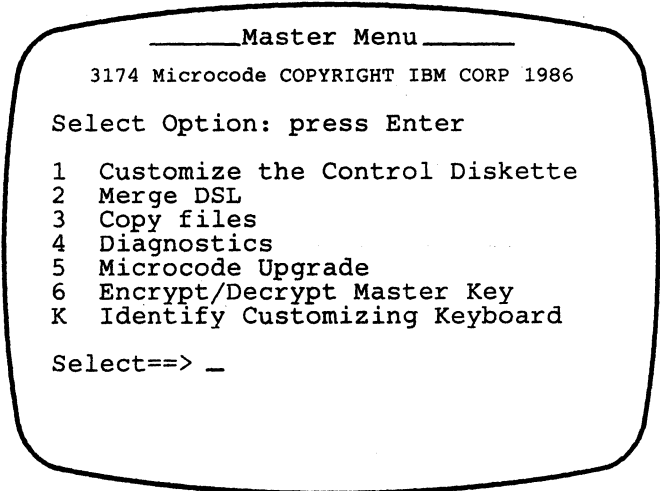

---

## Replacing the Encrypt/Decrypt Adapter Battery

Sometimes, you may have to replace the battery for the Encrypt/Decrypt feature. The following instructions show you where the battery is located and how to replace it.

**Notes:**

1. You **DO NOT** need to turn off the control unit to replace the battery. If, however, you do turn off the control unit to replace the battery, you must reenter the master key value.
2. When throwing away the replaced battery, observe the disposal instructions on the battery label.

**1** Open the front door of the 3174.

The battery for the Encrypt/Decrypt feature is located on the front of the Encrypt/Decrypt adapter card (location 24).

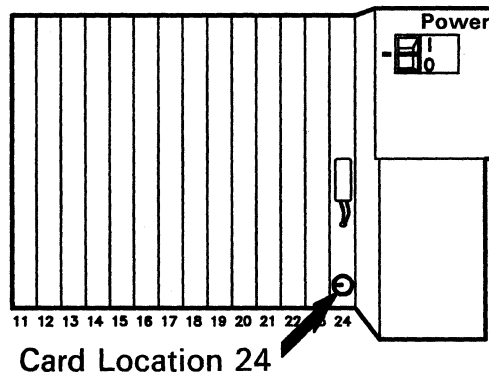
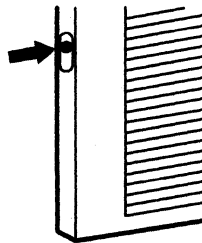

---

**2** Disconnect the battery connector from the card.

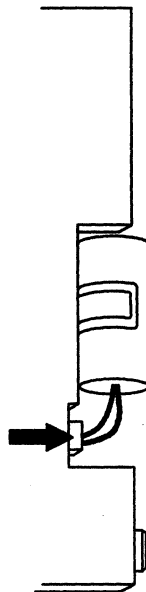

- 3** Remove the old battery from the clip on the card.

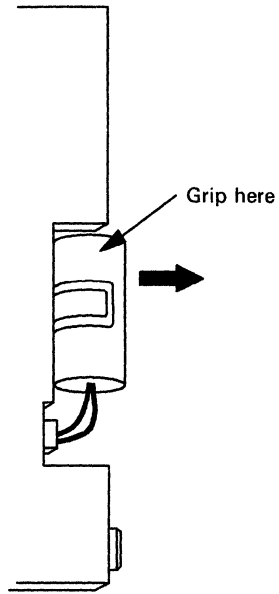

- 4** Insert the new battery into the clip, connect the new battery connector to the card, and close the front access door.

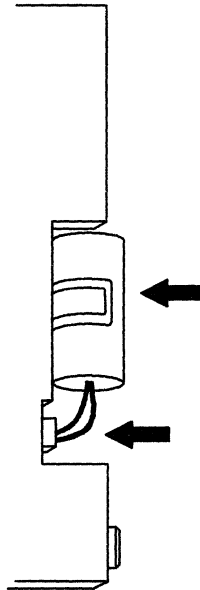







## Control Unit Problem Determination

Offline Tests 3-108

Test Operations 3-108

Alt 2 IML Tests 3-108

Alt 1 IML Tests 3-110

Communication Adapter and Communication Cable Test 3-110

Token-Ring Adapter and Cable Test 3-114

## Initial Symptom/Action Table

The problem symptoms in the Initial Symptom/Action Table (Figure 3-1) are arranged in the order that they should be examined. Read down the list of symptoms until you find the first one that compares with an error condition in your system. Then do the recommended actions.

	Symptom	Action
<b>1</b>	Control unit does not power-on (green dc power indicator is not lit).	Go to "Checking Control Unit Power" on page 3-7.
<b>2</b>	Nonnumeric character (something other than a number, 0–9) in <b>Status</b> display.	Request service for the control unit.
<b>3</b>	Status code in <b>Status</b> display, or at the terminals.	Go to "Status Code Chart" on page 4-4, find the status code, and do the recommended actions. If the status code is not listed, request service for the control unit.
<b>4</b>	<b>Check Cond</b> indicator is lit (no status code displayed).	Go to "Check Cond Indicator Lit and No Status Code" on page 3-10.
<b>5</b>	The operator panel is not working correctly. For example: <ul style="list-style-type: none"> <li>• A Normal IML occurs when Alt 1 or Alt 2 IML is done</li> <li>• The <b>40</b> prompt after an Alt 1 IML does not display</li> <li>• Status code 130 is displayed when an Alt 1 or Alt 2 IML is done.</li> </ul>	Request service for the control unit.
<b>6</b>	Terminal or host connection problems. This includes: <ul style="list-style-type: none"> <li>• Communication or link problems to or from the 3174 control unit</li> <li>• Direct-connect or cable problems between the 3174 control unit and a terminal, station, or host.</li> </ul>	Go to "Symptom/Decision Chart" on page 3-4.
<b>7</b>	Symptom undefined.	If the control unit is not working correctly, run Alt 2 IML tests (refer to "Alt 2 IML Tests" on page 3-108).  <b>Warning:</b> An IML disrupts all operating terminals.  If needed, request help from your technical support group or help desk.

Figure 3-1. Initial Symptom/Action Table

## Symptom/Decision Chart

The problem symptoms in the Symptom/Decision Chart (Figure 3-2) are arranged in the order that they should be examined. Read down the list of symptoms until you determine the first one that compares with the error condition in your system. Then GO TO the appropriate Symptom/Action Table or ask for help, as indicated.

TERMINAL CONNECTION PROBLEMS	
<b>1</b>	<p><b>3270-Type Terminal Connection Problem</b></p> <p>The connection between the control unit and a 3270-type terminal is failing.</p> <div style="text-align: center;"> <pre> graph LR     CU[Control Unit] --- A[Adapter HG 26] --- T[3270 Terminal]             </pre> </div> <p>A bad connection is indicated at a display station by a missing S, 4, or 6 in the lower left corner of the operator information area, and at a printer by a status code 27 or 28 or by the control unit signal's being off (refer to your printer manual).</p> <p>GO TO "3270 Terminal Connection Problems" on page 3-13.</p>
<b>2</b>	<p><b>ASCII-Type Terminal Connection Problem</b></p> <p>The connection between the control unit and an ASCII-type terminal is failing.</p> <div style="text-align: center;"> <pre> graph LR     CU[Control Unit] --- A[ASCII Adapter HG 2X] --- T[ASCII Terminal]             </pre> </div> <p>2X = 21, 22, or 23</p> <p>A bad connection is indicated at an ASCII display station by a missing Connection Menu, or other messages, such as <i>log on</i>, <i>sign on</i>, or <i>ready</i>. For a display or printer, <b>check your local operating instructions for the desired indication of a successful or failing connection.</b></p> <p>GO TO "ASCII Terminal Connection Problems" on page 3-49.</p>

Figure 3-2 (Part 1 of 3). Symptom/Decision Chart

HOST CONNECTION PROBLEMS	
<b>3</b>	<p><b>Remote IBM Host Connection Problem</b></p> <p>The connection between the control unit and the remote IBM host is failing.</p>  <p>A bad connection is indicated at the control unit by a 3XX or 5XX code in the Status display.</p> <p>GO TO "Procedure G – A Remote Host Connection Is Failing" on page 3-43.</p>
<b>4</b>	<p><b>Local IBM Host Connection Problem</b></p> <p>The connection between the control unit and the local IBM host is failing.</p>  <p>A bad connection is indicated at the control unit by a 3XX or 5XX code in the Status display.</p> <p>Request service for the control unit.</p>
<b>5</b>	<p><b>ASCII Host Connection Problem</b></p> <p>The connection between the control unit and an ASCII host is failing.</p>  <p>2X = 21, 22, or 23</p> <p>GO TO "Selecting an ASCII Host System Symptom" on page 3-90.</p>

Figure 3-2 (Part 2 of 3). Symptom/Decision Chart

**Make Problem Decision Here**

	<b>TOKEN-RING PROBLEMS</b>
<b>6</b>	<b>Token-Ring Connection Problem</b> The connection to the Token-Ring is failing. This is indicated by a 3XX or 8XX Status code (at the display station; for Gateway, however, the Status code is shown in the control unit operator panel only).
	GO TO "Token-Ring Adapter and Cable Test" on page 3-114.

Figure 3-2 (Part 3 of 3). Symptom/Decision Chart

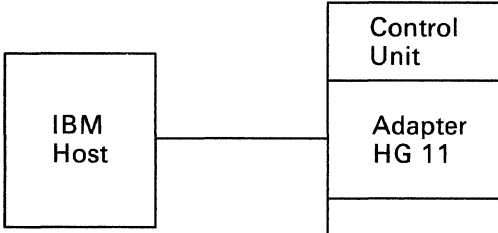
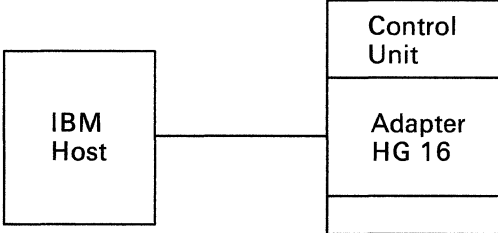
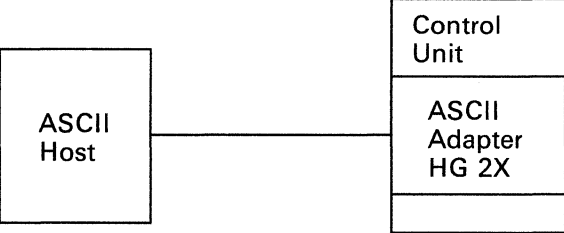
## Checking Control Unit Power

You are here because the green dc power indicator is off.

For Model 1L, do the steps listed below. For Models 1R, 2R, and 3R, go to page 3-8.

### For Model 1L

- 1** Turn the **Power Control** switch to **Local**.

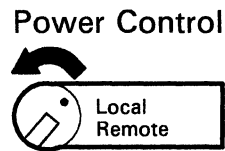

- 2** Lift the **Power** switch to **Start**, and release it (it returns to the **I** position).

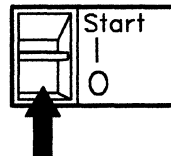

- 3** Is the green dc power indicator lit?
- No** — Go to “Checking AC Power” on page 3-9.
- Yes** — Is there a Sequence and Control cable?

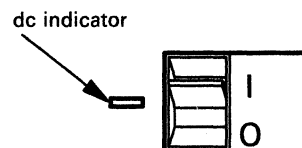

**No** — Close the front door and continue normal operation.

**Yes** — Turn the **Power Control** switch to **Remote**, and close the front door. Go to step 4.

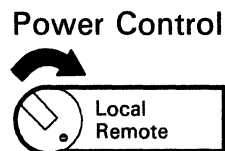

- 4** Did the green dc power indicator remain lit?

**No** — Make sure that the Sequence and Control cable is installed correctly, and that the host is operating normally. Then go back to step 1 and try this procedure again. If you do not find the problem, request help from your technical support group or help desk.

**Note:** As a temporary measure, you can set the **Power Control** switch to **Local** and turn on power.

**Yes** — Continue normal operation.



## Checking Control Unit Power

### For Models 1R, 2R, and 3R

**1** Is the Power switch set to I?

No — Lift the Power switch to I.

Yes — Go to step 2.

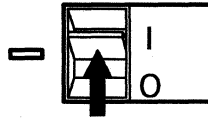

**2** Is the green dc power indicator lit?

No — Go to "Checking AC Power" on page 3-9.

Yes — Continue normal operation.

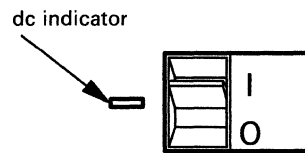

## Checking AC Power

You are here because the **Power** switch is set to **I**, but the dc power indicator is not lit.

- 1** Press the latch-release pushbutton on the left-center edge of the front door, open the door, and check the green ac power indicator. Go to step 2.

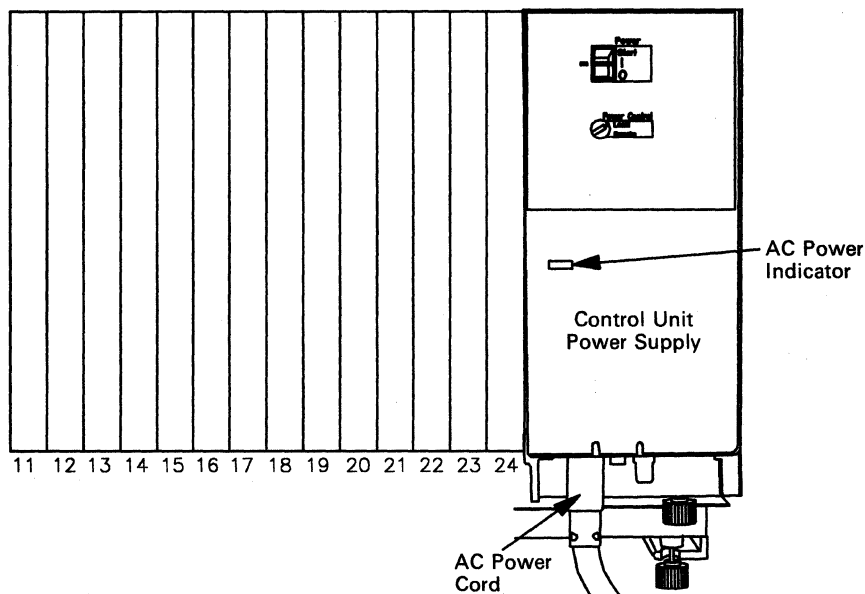
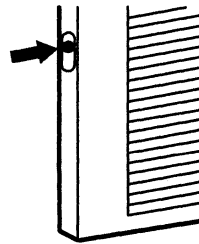

- 2** Is the ac power indicator on?

**Yes** — Request service for the control unit.

**No** — Move the **Power** switch to **O**. Verify that the power cord is plugged into the control unit.

**Note:** The ac power cord plugs into the bottom of the power supply (see the above figure).

If the power cord is plugged into the control unit, verify that it is also plugged into the electric outlet.

Then, if necessary, check that the outlet has power by using a lamp or similar device. If power is not present at the outlet, notify the electrical repair service.

If no problem is found and the ac power indicator is still not lit, request service for the control unit.

## Check Cond Indicator Lit and No Status Code

You are here because the **Check Cond** indicator came on while the 3174 control unit was operational.

- 1 At the operator panel, press **Enter** and check the **Status** display for a status code.  
Did a status code appear?  
**No** — Go to step 2.  
**Yes** — Go to “Status Code Chart” on page 4-4, look up the status code, and do the recommended actions.

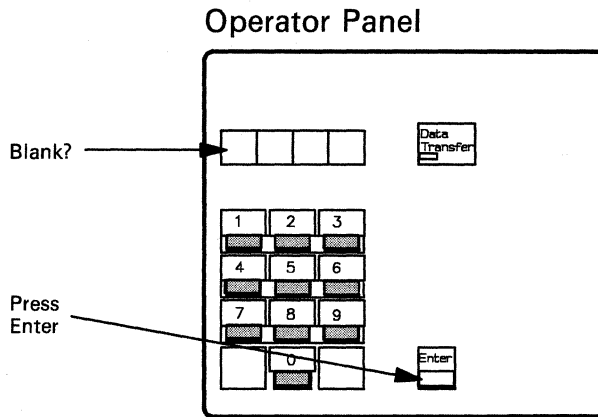

- 2 Is the control unit still operating, and are terminals still functioning?  
**No** — Go to “Alt 2 IML Tests” on page 3-108, do steps 1, 2, and 3 of the test procedure, and then go to step 3 below.  
**Yes** — There may be a problem with the operator panel. Request help from your technical support group or help desk.

- 3 Were the tests completed without error (2082 in the Status display)?  
**No** — Go to “Status Code Chart” on page 4-4, look up the status code, and do the recommended actions.  
**Yes** — Do a normal IML — refer to “Making the 3174 Operational” on page 2-17. Then return to step 4.

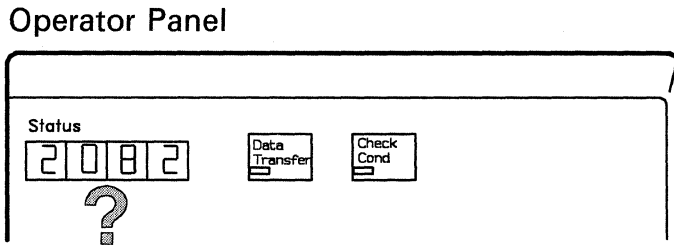

- 4 Did an IML start (progress codes appear in the Status display)?  
**No** — Request service for the control unit.  
**Yes** — Continue normal operation. If the problem persists, request service for the control unit.

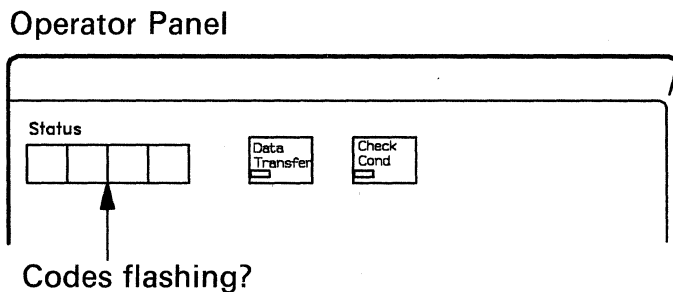

## Forcing the Control Unit Offline

**Note:** This procedure is for the Model 1L only.

You are here because the offline indicator on the **Channel Interface** switch did not light when you turned the switch to the **Offline** position.

- 1** Press and hold down **Alt 1** while you press and release **IML**. Then release **Alt 1**.

Did the offline indicator light?

**No** — Go to step 2.

**Yes** — The system is now offline.

### Operator Panel

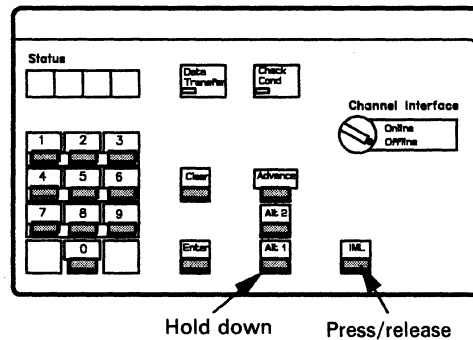

- 2** Set the **Power Control** switch to **Local**.

### Power Control



- 3** Press the **Power** switch to **O**. Go to step 4.

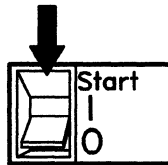

- 4** Lift the **Power** switch to **Start** and release it (it returns to the **I** position). This starts a normal **IML**.

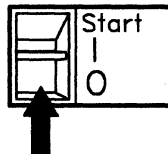

- 5** Is the **Offline** indicator lit?

**No** — Request help from your technical support group or help desk.

**Yes** — The control unit is now offline.

### Channel Interface

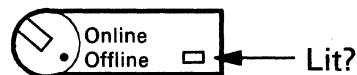

Once the control unit is offline, you can do customizing or offline testing (see “Offline Tests” on page 3-108).

To make the control unit operational again, refer to “Making the 3174 Operational” on page 2-17.

**This page intentionally left blank.**

## 3270 Terminal Connection Problems

You are here because one or more terminals connected to the Terminal Adapter (either directly or through a multiplexer) have lost their connection to the control unit.

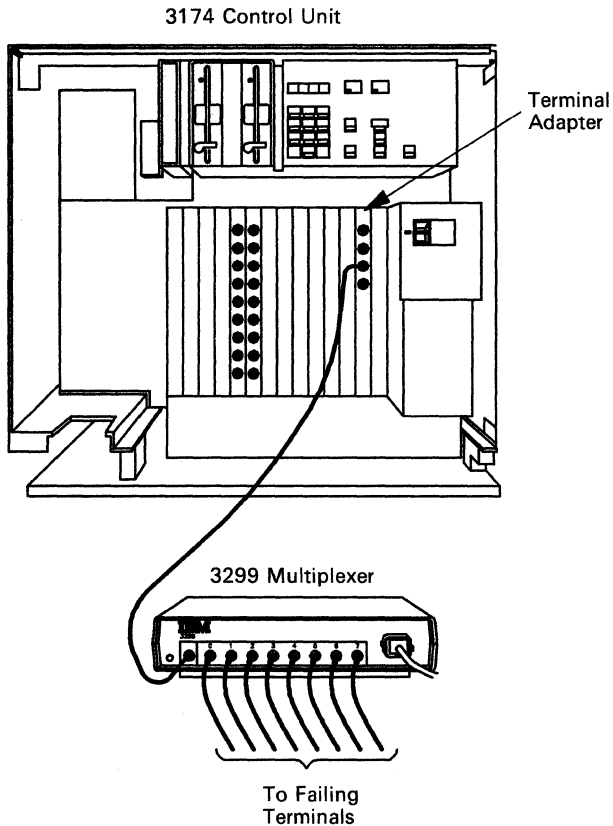

On display stations, a bad connection is indicated by a missing **S**, **4**, or **6** in the lower left corner of the operator information area. On printers, a bad connection is indicated by the Control Unit Signal (CU) indicator's being off or by a printer status code of 27 or 28 (consult the manual for your printer).

Handling the problem involves three steps:

- **Collect and study the information about the problem** (see "Collecting Information about the Problem").
- **Select the symptom and action** (see "Selecting a 3270 Terminal Symptom" on page 3-18).
- Do the appropriate problem determination procedure described in the **Action** selected.

This section also contains information on terminal connectors and terminal addresses.

### Collecting Information about the Problem

To complete the procedures in this section, you first need to:

1. Identify the failing terminal and its associated control unit
2. Obtain the terminal-to-3174 physical-connection information
3. Determine how the terminal is connected to the 3174
4. Determine the operating status of other connected devices, using data from worksheets like those shown in Figures 3-3 and 3-4.

### Sample Cabling Worksheet

#### Identifying the 3174 Hardware Cabling for Models 1L, 1R, 2R, AND 3R

**Instructions**

- Determine the components you will be using and draw in the connecting cables as indicated by the dotted lines.
- When the hardware configuration is determined, go to the worksheet number specified for that component and complete the worksheet indicated. Complete only the worksheets required for your hardware configuration.
- The accompanying worksheets show all cabling to be installed in **BOLD BLACK**. TMA-to-TA cabling is installed at the time of manufacture and is shown but not highlighted.
- Use the cabling worksheets for cable installation.
- Store these worksheets with the 3174 control unit documentation for future reference. The worksheets are necessary to perform terminal connection problem determination. When cabling changes are made, correct these worksheets to reflect such changes.

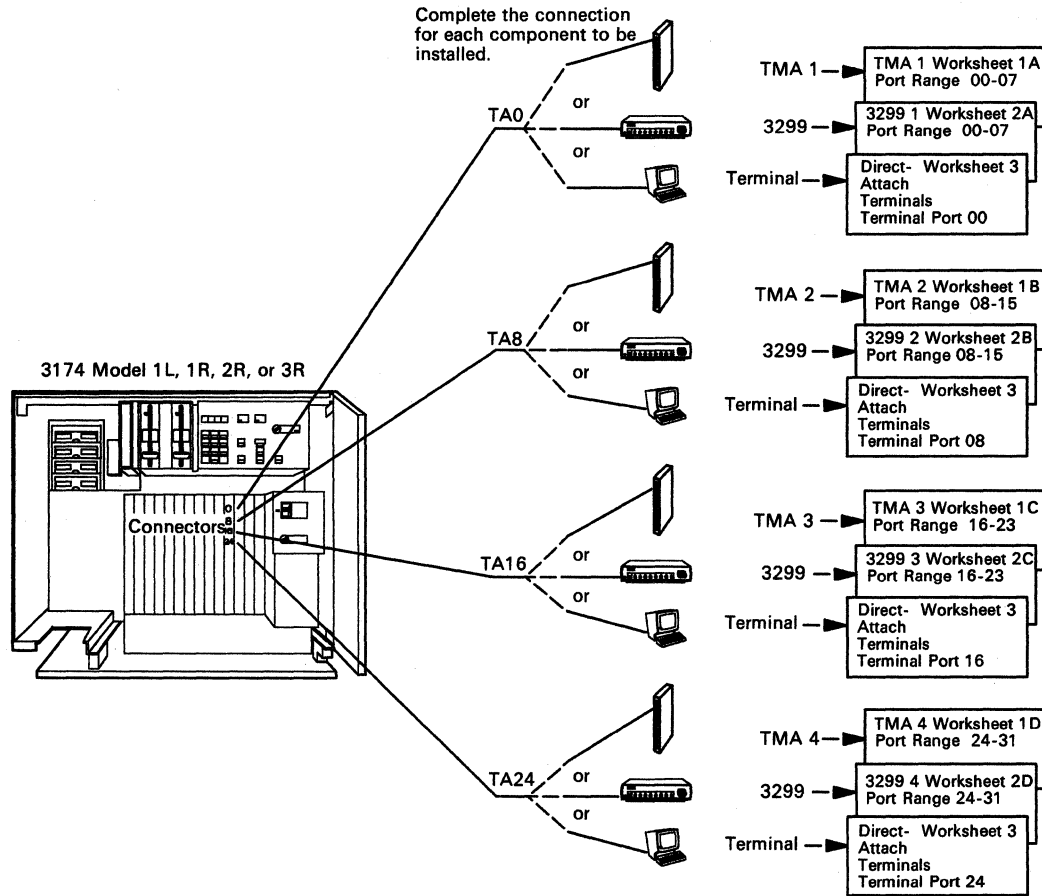

Figure 3-3. Sample Overview Cable Connection Worksheet

**Sample Cabling Worksheets (cont.)**

**3299 TERMINAL MULTIPLEXER PORT RANGE 00-07**

Complete this worksheet during site planning. Use this worksheet during cable installation and terminal connection problem determination. Store this worksheet with the 3174 control unit documentation for future reference. When cabling changes are made, correct this record to reflect such changes.

3174 Model \_\_\_\_\_  
 3174 Location \_\_\_\_\_  
 3174 ID \_\_\_\_\_

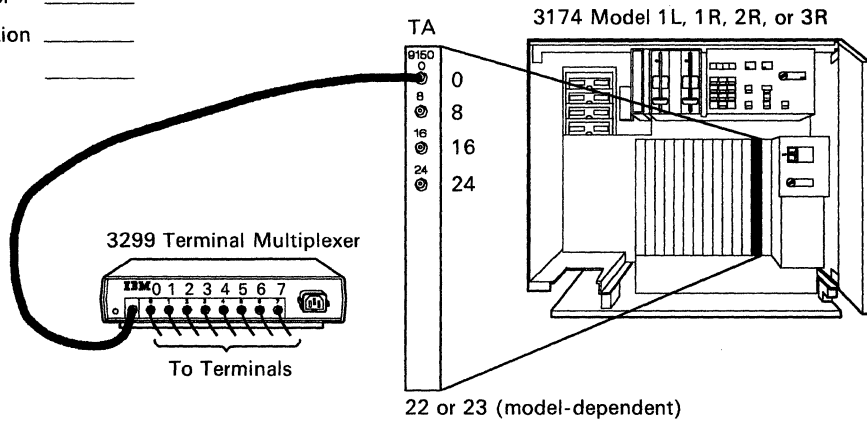

**FROM 3174 TO 3299 TERMINAL MULTIPLEXER CABLING**

3174 TA Connector	3299 Cable ID	3299 Model	3299 Location	3299 ID or Number
-------------------	---------------	------------	---------------	-------------------

**FROM 3299 TERMINAL MULTIPLEXER TO TERMINAL CABLING**

--

Figure 3-4. Sample 3299 Cable Connection Worksheet



## 3270 Terminal Connection Problems

To collect information about the problem, do the following procedures.

### 1 – Identify the Failing Terminal and Its Control Unit

Use your local resources to identify the control unit and its failing terminal(s). The control unit and its terminals may be identified in one of the following ways:

- A label on the terminal containing the control unit address, the terminal port number, or the host identifier (ID)
- A location for the terminal, for example, *the terminal in the Administration Building, office 123*
- A function or operation, for example, *the terminal in the reproduction room*
- A person's name and phone number, for example, *Red Linehan's terminal at extension 9876*
- A cable or wall socket identifier.

### 2 – Obtain Physical-Connection Information

Physical-connection information is usually stored at the control unit or at some central location. Get the installation cabling worksheets (see Figure 3-3 on page 3-14 and Figure 3-4 on page 3-15 for samples), or whatever other subsystem documentation is available to identify the connection path between the failing terminal and its control unit. The information should include cable IDs, port numbers, device locations, and the type of device (display station, printer, or multiplexer).

You may have a subsystem connection diagram that shows all the devices attached to the control unit (see Figure 3-5 on page 3-17).

### 3 – Determine How the Terminal Is Connected to the 3174

Using the cabling worksheets or the subsystem connection diagram, determine how a terminal is connected to the control unit. For example:

- Is the terminal connected directly to the control unit?
- Is the terminal connected to a 3299 Terminal Multiplexer?
- Is the terminal connected to a Terminal Multiplexer Adapter (TMA)?

### 4 – Determine the Status of Other Connected Terminals

Determine the extent of the problem by asking other terminal users, using the same control unit, the status of their terminal:

- Are all the terminals connected to the Terminal Adapter failing?
- If the failing terminal is connected through a multiplexer (3299 or TMA), determine whether all the terminals on the multiplexer are failing.

**Note:** If any terminal is working, then all terminals are **not** failing.

The answers to questions like these will help you to identify which symptom in Figure 3-6 applies to your situation.

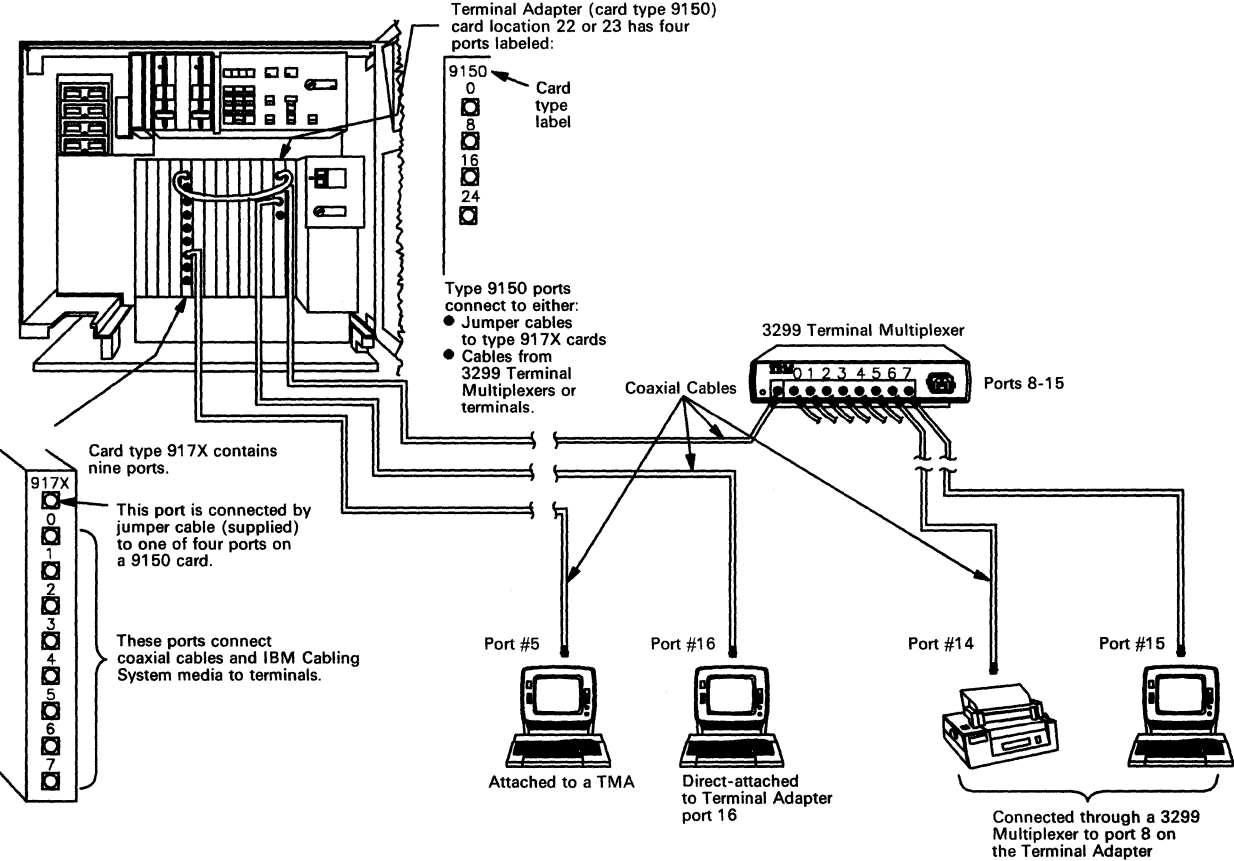

Figure 3-5. Sample Physical Connection Diagram (3270 Terminals)

### Selecting a 3270 Terminal Symptom

Once you have collected all the necessary 3270 connection and status information, read down the list of symptoms in Figure 3-6 and choose the one that best describes the 3270 problem you are having. Then go to the procedure listed.

	Symptom	Action
<b>1</b>	All terminals connected to the control unit are failing.	Go to "Procedure A – All Terminals Are Failing" on page 3-19.
<b>2</b>	All terminals connected to one Terminal Multiplexer Adapter (TMA) are failing. See Note 1.	Go to "Procedure B – All Terminals Connected to a TMA Are Failing" on page 3-21.
<b>3</b>	All terminals connected to a 3299 are failing. See Note 2.	Go to "Procedure C – All Terminals Connected to a 3299 Are Failing" on page 3-23.
<b>4</b>	One terminal connected to a Terminal Multiplexer Adapter (TMA) is failing.	Go to "Procedure D – One Terminal Connected to a TMA Is Failing" on page 3-29.
<b>5</b>	One terminal connected to a 3299 is failing.	Go to "Procedure E – One Terminal Connected to a 3299 Is Failing" on page 3-34.
<b>6</b>	One terminal directly connected to a Terminal Adapter port is failing.	Go to "Procedure F – A Directly Connected Terminal Is Failing" on page 3-38.
<b>7</b>	One or more (but not all) terminals are failing.	Go to the appropriate procedure listed above, and do the procedure for one failing terminal at a time.
<p><b>Notes:</b></p> <ol style="list-style-type: none"> <li>1. When the failing terminal is the only terminal connected to the Terminal Multiplexer Adapter, use "Procedure B – All Terminals Connected to a TMA Are Failing" on page 3-21, and then, if you do not find the problem, use "Procedure D – One Terminal Connected to a TMA Is Failing" on page 3-29.</li> <li>2. When the failing terminal is the only terminal connected to the 3299 Terminal Multiplexer, use "Procedure C – All Terminals Connected to a 3299 Are Failing" on page 3-23, and then, if you do not find the problem, use "Procedure E – One Terminal Connected to a 3299 Is Failing" on page 3-34.</li> </ol>		

Figure 3-6. 3270 Terminal Connection Problems

## Procedure A – All Terminals Are Failing

The problem may be in the host system, in the link to the host, or in the control unit.

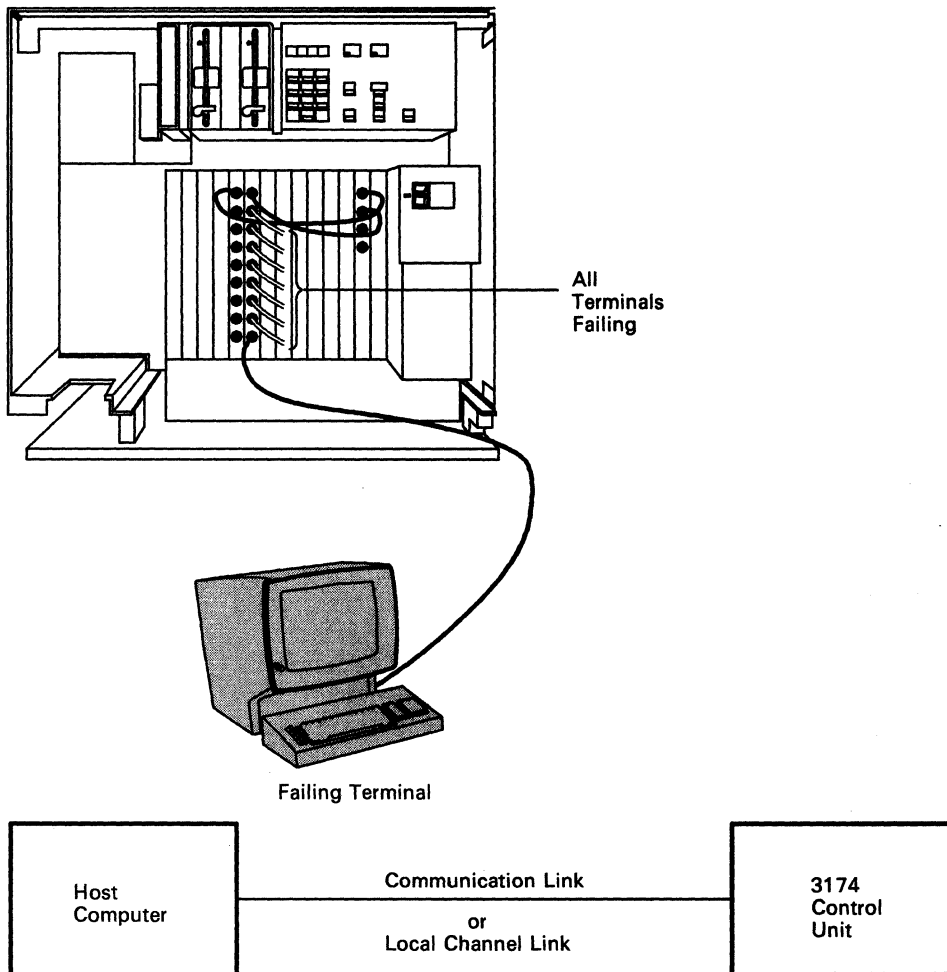

**1**

At the control unit, check that the green dc power indicator is lit.

Is the green dc power indicator lit?

**No** — Go to "Checking Control Unit Power" on page 3-7.

**Yes** — Go to step 2 on page 3-20.

dc indicator

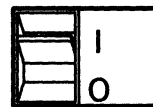

## All Terminals Are Failing

### 2 Check for a status code in the **Status** display.

Is there a status code displayed?

**No** — Go to “Alt 2 IML Tests” on page 3-108 and run the Alt 2 IML tests.

**Warning:** An IML disrupts all control unit operations.

**Yes** — Go to “Status Code Chart” on page 4-4, look up the status code, and do the recommended actions.

### Operator Panel

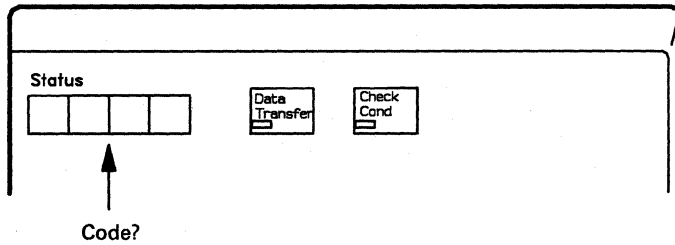

### Procedure B – All Terminals Connected to a TMA Are Failing

The problem may be in the Terminal Adapter, the short jumper cable to the Terminal Multiplexer Adapter (TMA), or the jumper cable connections.

**CAUTION:**

Do not disconnect or connect cables during an electrical storm.

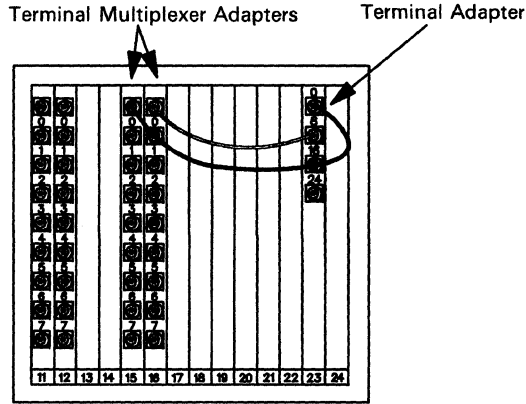

- 1 At the control unit, open the front door and check that the jumper cable is correctly connected to both the Terminal Adapter and the Terminal Multiplexer Adapter (TMA). Go to step 2 on page 3-22.

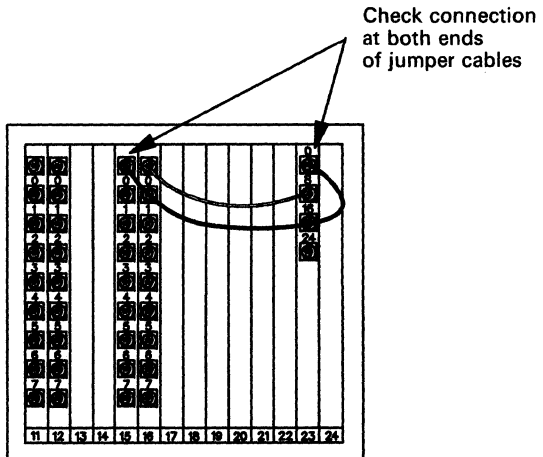
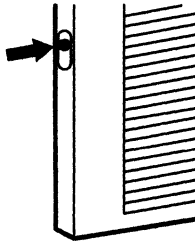

## All Terminals Connected to a TMA Are Failing

### 2 Did you find a problem?

**No** — Request service for the control unit.

**Yes** — Correct the problem, go to a previously failing terminal, and set the **Normal/Test** switch to **Test**, then to **Normal**. Or, on some displays, turn power off, then on, and wait up to 2 minutes.

Is **S**, **4**, or **6** displayed in the bottom left corner of the operator information area?

**No** — Request service for the control unit.

**Yes** — You fixed the problem. Stop here.

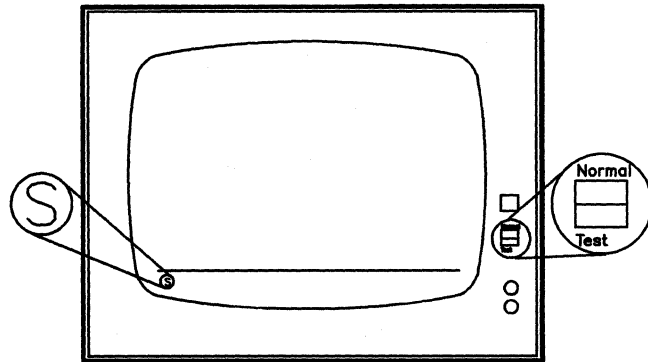

### Procedure C – All Terminals Connected to a 3299 Are Failing

To do this procedure, you need a terminal known to be working. You will use this terminal to test the Terminal Adapter port and the cable to the 3299 multiplexer.

The problem may be in the Terminal Adapter, the cable to the external multiplexer, the cable connections, or the 3299 multiplexer.

**CAUTION:**

**Do not disconnect or connect cables during an electrical storm.**

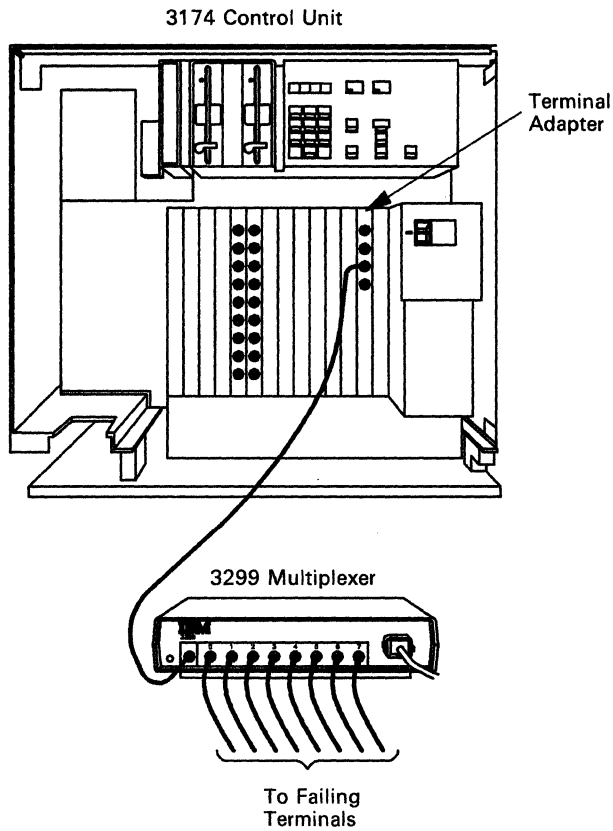



## All Terminals Connected to a 3299 Are Failing

- 1 At the 3299 multiplexer, check that the cables are connected correctly (especially the cable from the control unit), that the 3299 is plugged in, and that power is supplied to the unit (power on indicator is lit).

Did you find a problem?

**No** — Go to step 2 on page 3-25.

**Yes** — Correct the problem, go to a previously failing terminal, and set the **Normal/Test** switch to **Test**, then to **Normal**. Or, on some displays, turn power off, then on, and wait up to 2 minutes.

Is **S**, **4**, or **6** displayed in the bottom left corner of the operator information area?

**No** — You have another problem. Start the Terminal Connection Problem Determination again (go to "Selecting a 3270 Terminal Symptom" on page 3-18).

**Yes** — You fixed the problem. Stop here.

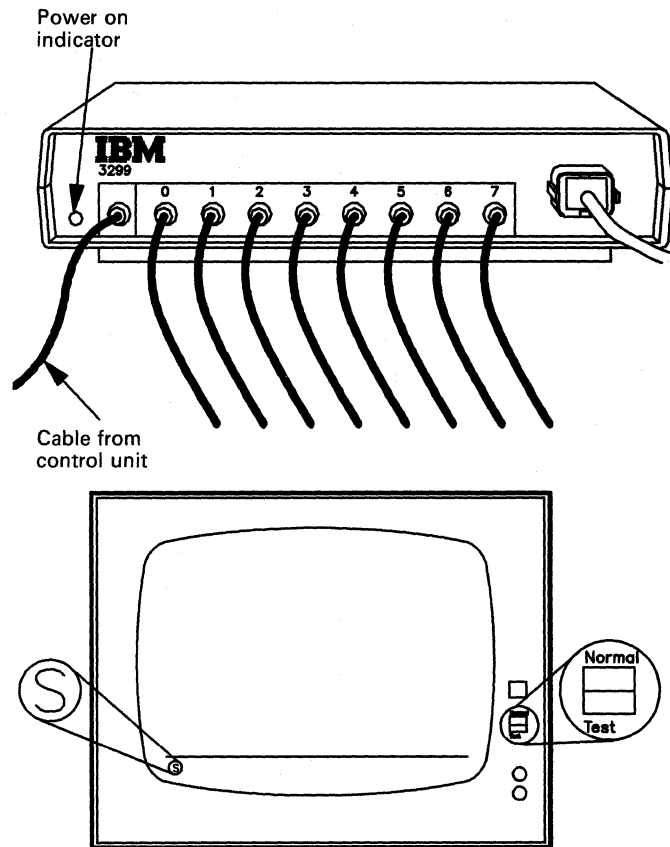

- 2** At the control unit, open the front access door.

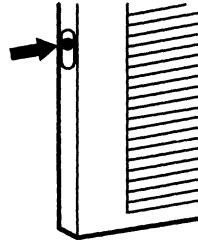

Check that the cable from the 3299 is connected correctly to the port on the Terminal Adapter (card location 22 or 23).

Did you find a problem?

**No** — Go to step 3 on page 3-26.

**Yes** — Correct the problem, go to a previously failing terminal, and set the **Normal/Test** switch to **Test**, then to **Normal**. Or, on some displays, turn power off, then on, and wait up to 2 minutes.

Is **S**, **4**, or **6** displayed in the bottom left corner of the operator information area?

**No** — You have another problem. Start the Terminal Connection Problem Determination again (go to “Selecting a 3270 Terminal Symptom” on page 3-18).

**Yes** — You fixed the problem. Stop here.

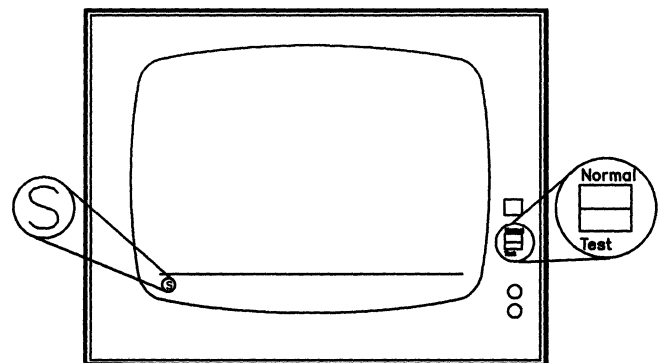
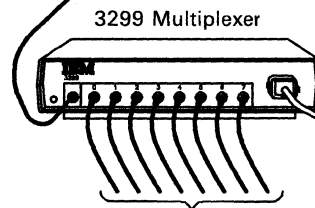
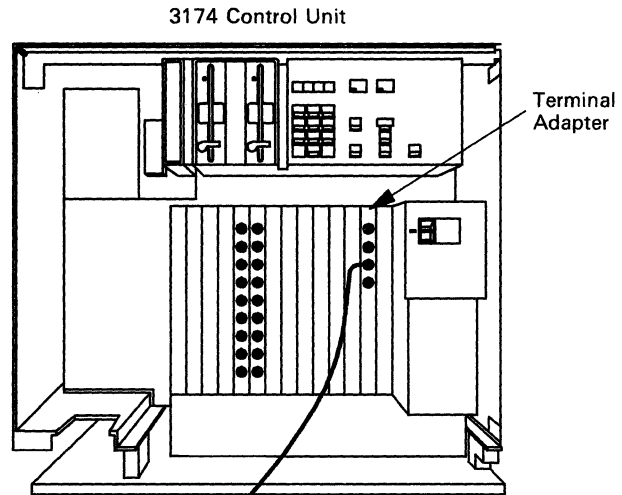

# All Terminals Connected to a 3299 Are Failing

**3** Disconnect the 3299 multiplexer cable from the suspect Terminal Adapter port.

**Note:** If you do not know how to disconnect cables, refer to "How to Disconnect and Connect Cables" on page B-21 for the necessary information, and then return here and continue with the procedure.

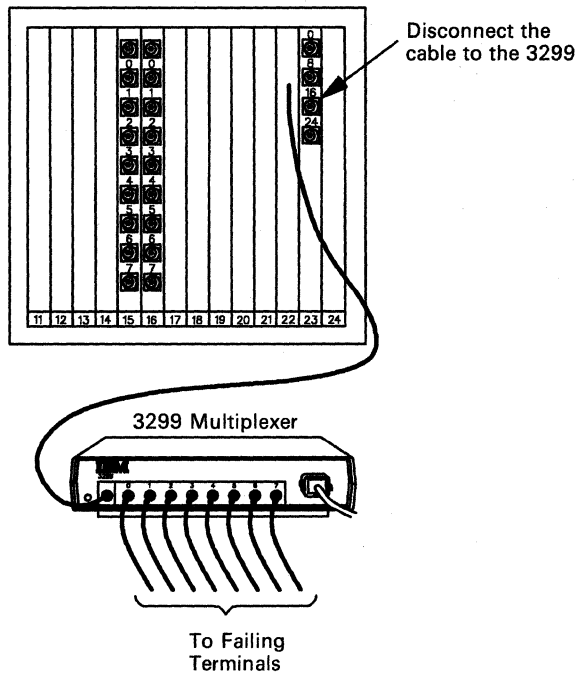

**4** Connect a known working terminal to the suspect Terminal Adapter port.

**Warning:** You must make sure that the cable you are connecting has the same type of cable connector as the one you removed in the previous step.

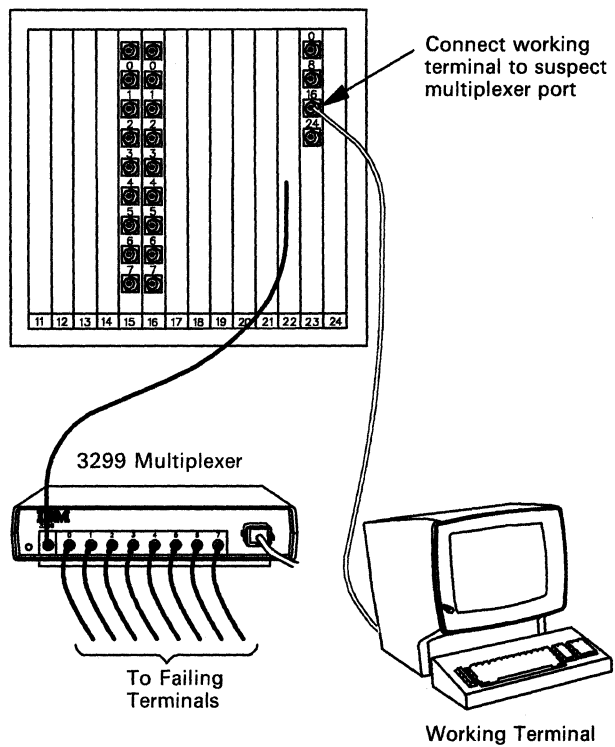

**5** At the working terminal, set the **Normal/Test** switch to **Test**, then to **Normal**. Or, on some displays, turn power off, then on, and wait up to 2 minutes.

Is **S**, **4**, or **6** displayed in the bottom left corner of the operator information area?

**No** — The Terminal Adapter port is bad. Request service for the control unit.

**Yes** — The Terminal Adapter port is good. The problem is in the cable to the 3299 or in the 3299. Put each cable back in its original place, and go to step 6.

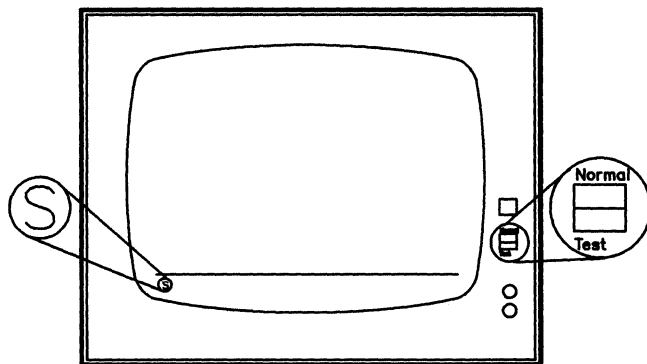

**6** At the 3299 multiplexer, disconnect the cable coming from the control unit.

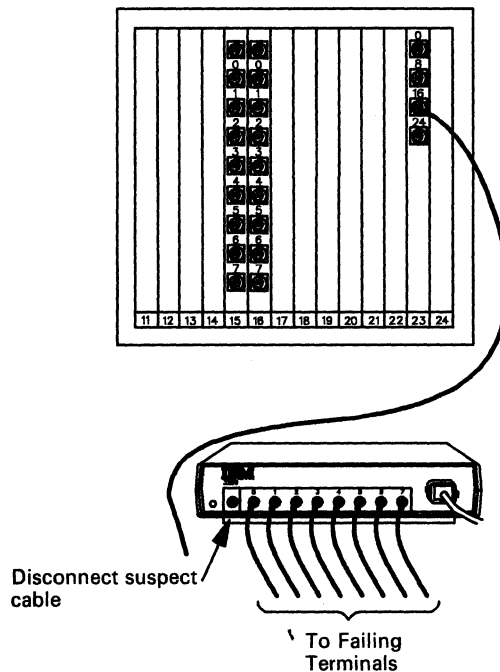

# All Terminals Connected to a 3299 Are Failing

- 7** Connect the cable, coming from the control unit, to a known working terminal.

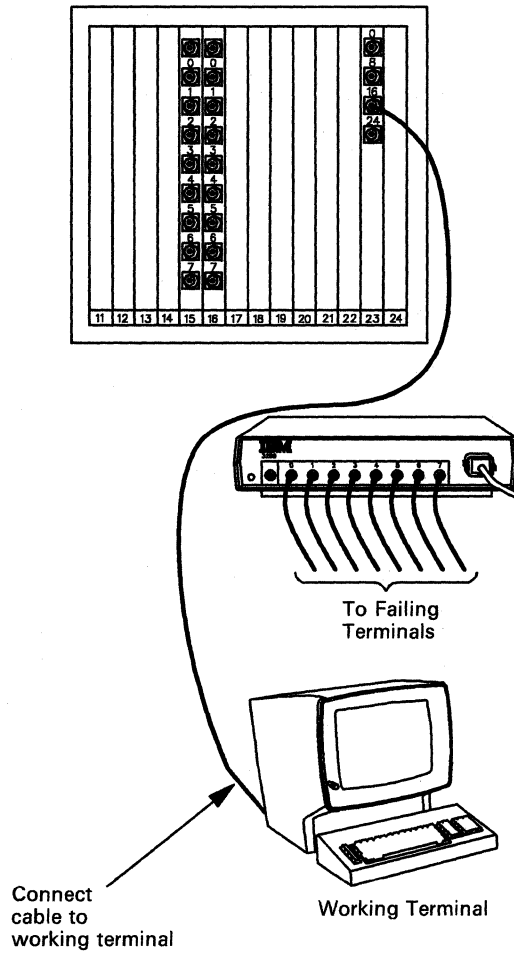

- 8** At the working terminal, set the **Normal/Test** switch to **Test**, then to **Normal**. Or, on some displays, turn power off, then on, and wait up to 2 minutes.

Is **S**, **4**, or **6** displayed in the bottom left corner of the operator information area?

- No** — The cable from the control unit to the 3299 is bad. Put each cable and terminal back in its original place and call the cable repair service.
- Yes** — The 3299 is bad. Put each cable and terminal back in its original place. If you have a spare 3299, install it in place of the faulty unit. Refer to "3299 Service/Replacement Procedure" on page 3-48.

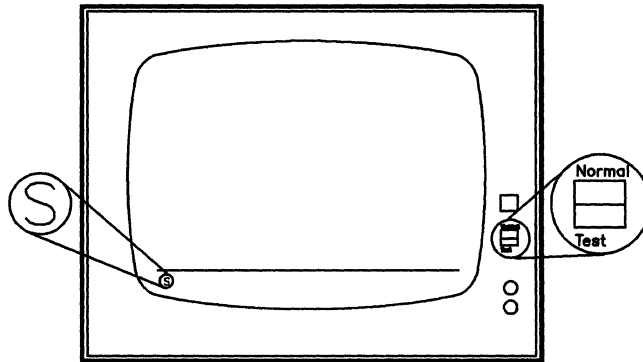

## Procedure D – One Terminal Connected to a TMA Is Failing

To do this procedure, you need a terminal known to be working. You will use this terminal to test the port on the Terminal Multiplexer Adapter (TMA) and the cable to the failing terminal.

The problem may be in the Terminal Multiplexer Adapter (TMA), the cable to the terminal, the cable connections, or the terminal.

**CAUTION:**

**Do not disconnect or connect cables during an electrical storm.**

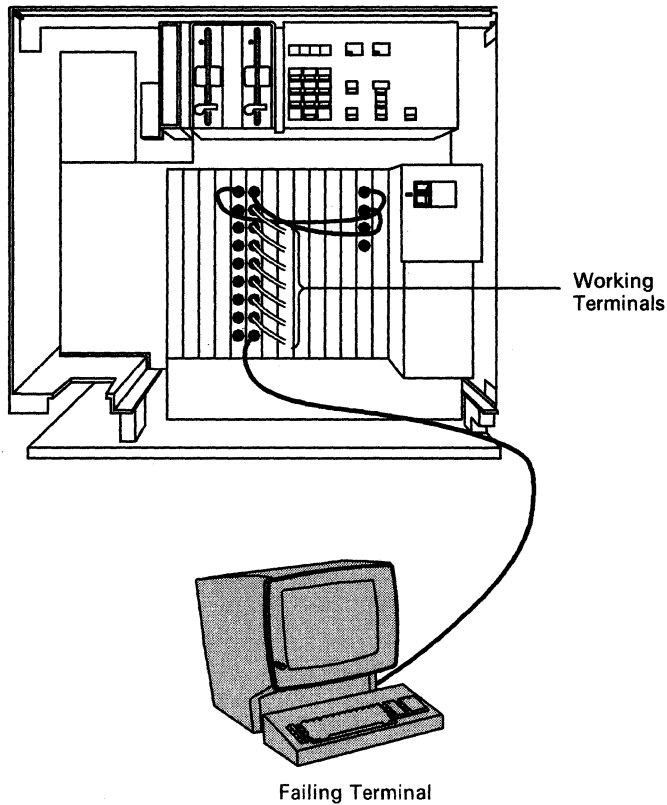

## One Terminal Connected to a TMA Is Failing

- 1 Check that the cables are correctly connected both to the terminal and to the Terminal Multiplexer Adapter (TMA).

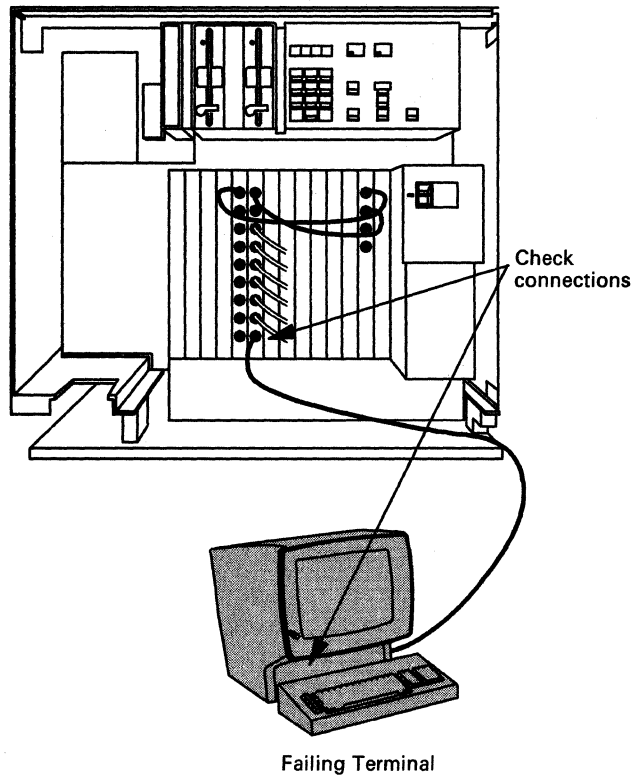

Did you find a problem?

No — Go to step 2 on page 3-31.

Yes — Correct the problem, go to the previously failing terminal, and set the **Normal/Test** switch to **Test**, then to **Normal**. Or, on some displays, turn power off, then on, and wait up to 2 minutes.

Is **S**, **4**, or **6** displayed in the bottom left corner of the operator information area?

No — Go to step 2 on page 3-31.

Yes — You fixed the problem. Stop here.

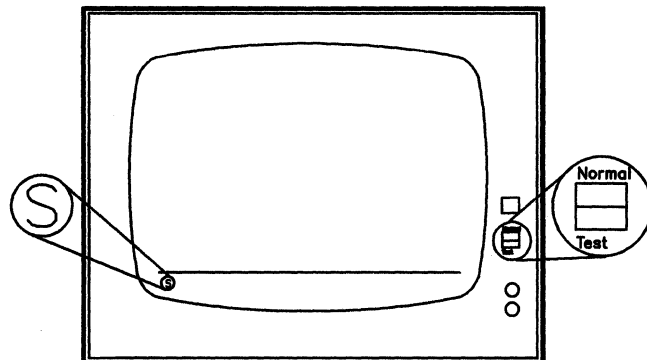

- 2** At the Terminal Multiplexer Adapter (TMA), disconnect the cable coming from the failing terminal.

**Note:** If you do not know how to disconnect cables, refer to "How to Disconnect and Connect Cables" on page B-21 for the necessary information, and then return here and continue with the procedure.

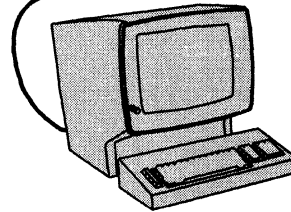
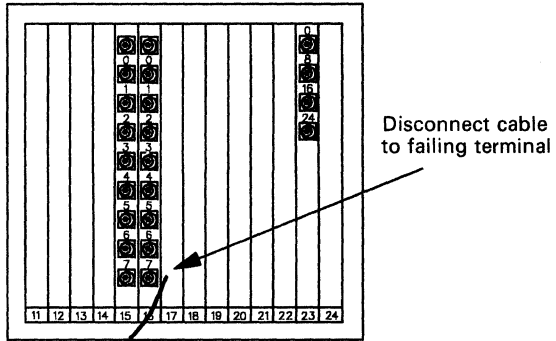

Failing Terminal

- 3** Connect the cable from the working terminal to the suspect TMA port.

**Warning:** You must make sure that the cable you are connecting has the same type of cable connector as the one you removed in the previous step.

**Note:** You may use a working terminal from any Terminal Multiplexer Adapter or Terminal Adapter port. If necessary, notify the user of a service disruption.

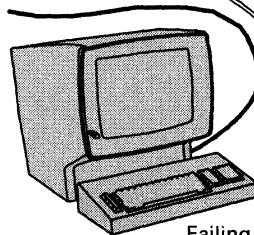
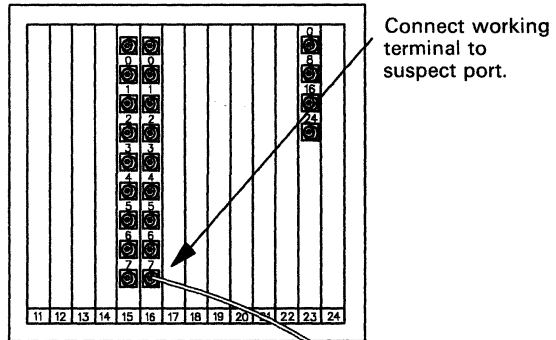

Failing Terminal

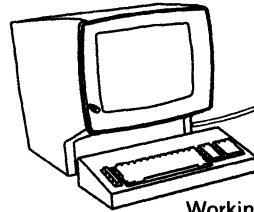

Working Terminal



## One Terminal Connected to a TMA Is Failing

- 4** At the working terminal, set the **Normal/Test** switch to **Test**, then to **Normal**. Or, on some displays, turn power off, then on, and wait up to 2 minutes.

Is **S**, **4**, or **6** displayed in the bottom left corner of the operator information area?

**No** — The Terminal Multiplexer Adapter (TMA) port is bad. Request service for the control unit.

**Yes** — The Terminal Multiplexer Adapter (TMA) port is good. The problem is in the terminal cable or the terminal. At the TMA, put each cable back in its original place. Go to step 5.

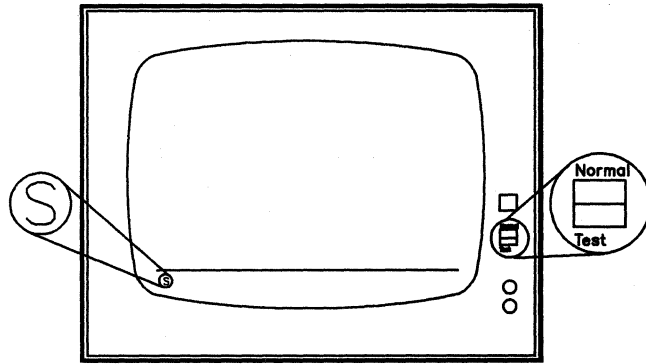

- 5** At the failing terminal, disconnect the cable.

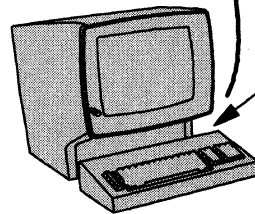
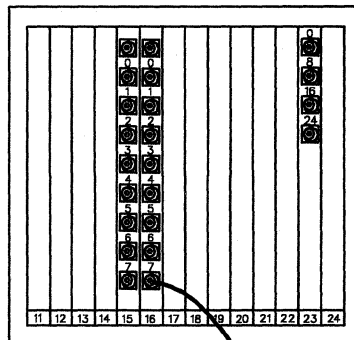

Disconnect cable at the failing terminal

Failing Terminal

6 Connect the suspect cable to a known working terminal.

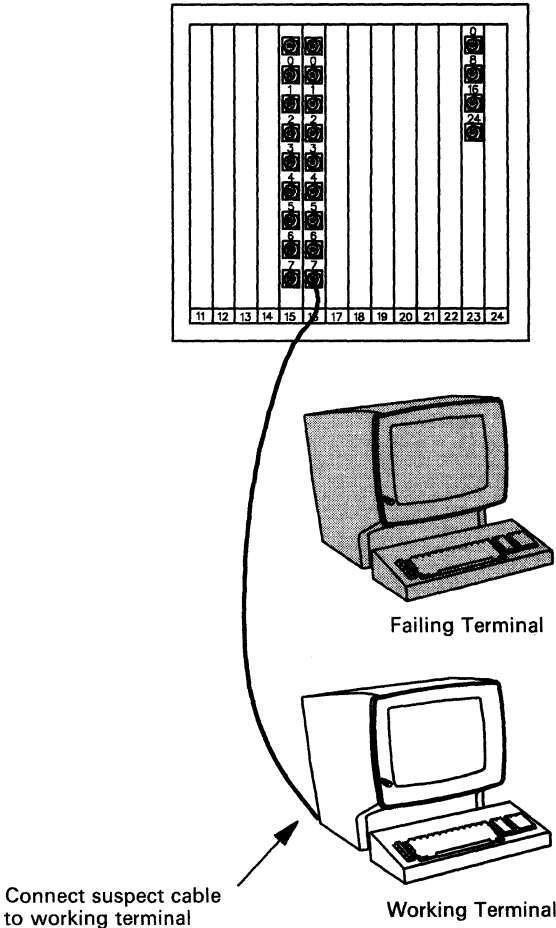

7 At the working terminal, set the Normal/Test switch to Test, then to Normal. Or, on some displays, turn power off, then on, and wait up to 2 minutes.

Is S, 4, or 6 displayed in the bottom left corner of the operator information area?

No — The failing terminal's cable is bad. Put each cable and terminal back in its original place, and call the cable repair service.

Yes — The failing terminal is bad. Put each cable and terminal back in its original place. Call the terminal repair service.

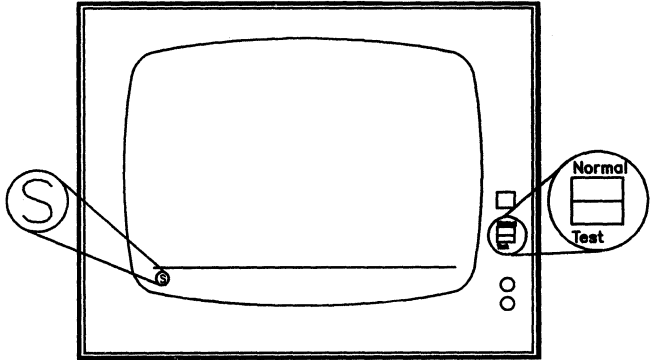

### Procedure E – One Terminal Connected to a 3299 Is Failing

To do this procedure, you need a terminal known to be working. You will use this terminal to test the port on the 3299 multiplexer and the cable to the failing terminal.

The problem may be in the 3299 multiplexer, the cable to the terminal, the cable connections, or the terminal.

**CAUTION:**

**Do not disconnect or connect cables during an electrical storm.**

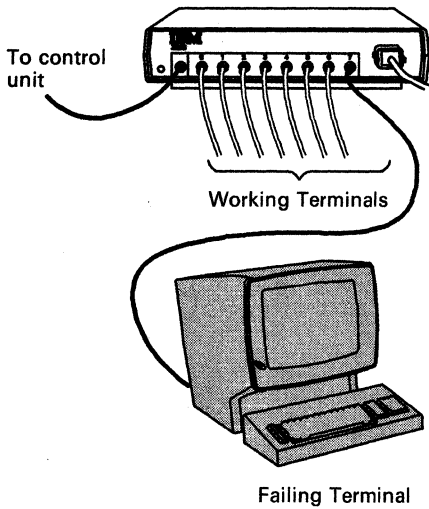

- 1 Check that the cables are correctly connected both to the terminal and to the 3299 multiplexer.  
Did you find a problem?  
**No** — Go to step 2 on page 3-35.  
**Yes** — Correct the problem, go to the previously failing terminal, and set the **Normal/Test** switch to **Test**, then to **Normal**. Or, on some displays, turn power off, then on, and wait up to 2 minutes.  
Is **S**, **4**, or **6** displayed in the bottom left corner of the operator information area?  
**No** — Go to step 2 on page 3-35.  
**Yes** — You fixed the problem. Stop here.

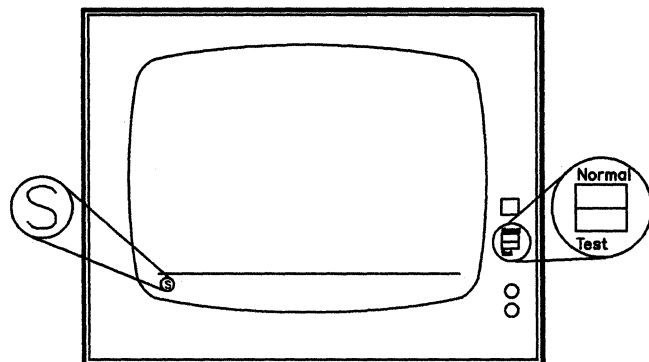
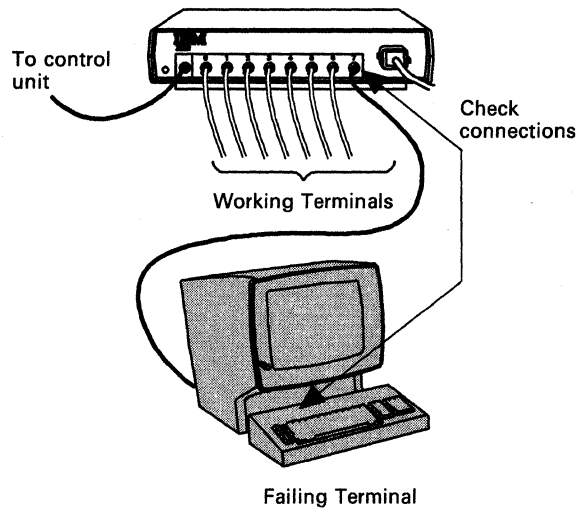

## One Terminal Connected to a 3299 Is Failing

- 2** At the 3299, disconnect the cable from the failing terminal.

**Note:** If you do not know how to disconnect cables, refer to "How to Disconnect and Connect Cables" on page B-21 for the necessary information, and then return here and continue with the procedure.

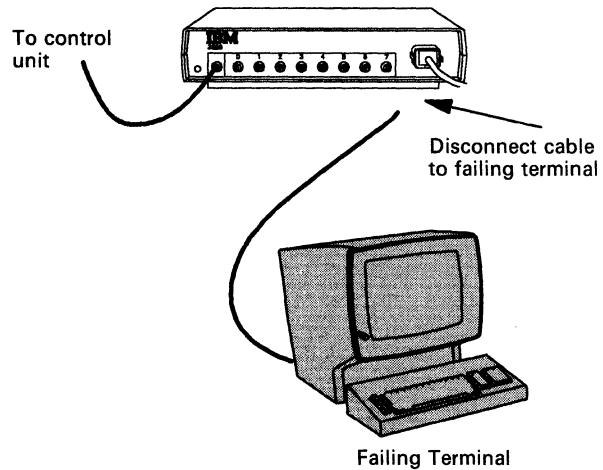

- 3** At the suspect 3299 port, connect the cable from a known working terminal.

**Warning:** You must make sure that the cable you are connecting has the same type of cable connector as the one you removed in the previous step.

**Note:** You may use a working terminal from this or another 3299. If necessary, notify the user of a service disruption.

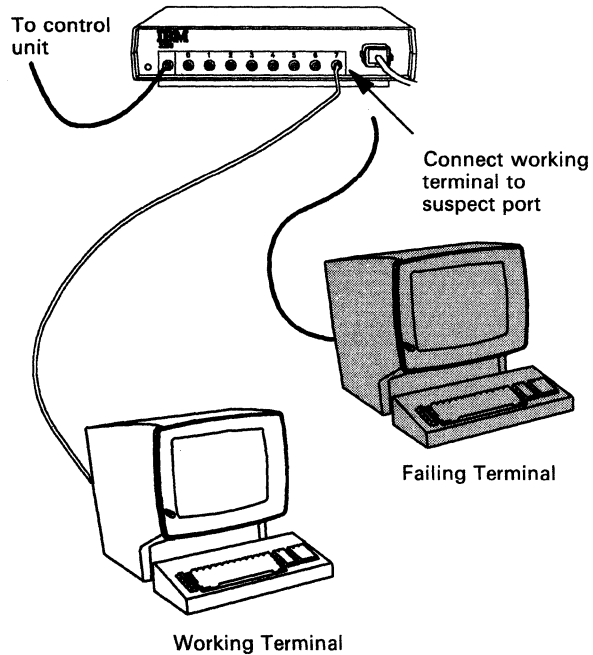

## One Terminal Connected to a 3299 Is Failing

- 4** At the working terminal, set the **Normal/Test** switch to **Test**, then to **Normal**. Or, on some displays, turn power off, then on, and wait up to 2 minutes.

Is **S**, **4**, or **6** displayed in the bottom left corner of the operator information area?

**No** — The 3299 is bad. Put each cable and terminal back in its original place. If you have a spare 3299, install it in place of the faulty unit.

For the defective 3299, refer to “3299 Service/Replacement Procedure” on page 3-48.

**Yes** — The 3299 multiplexer port is good. The problem is in the terminal cable or the terminal. At the 3299, put each cable back in its original place. Go to step 5.

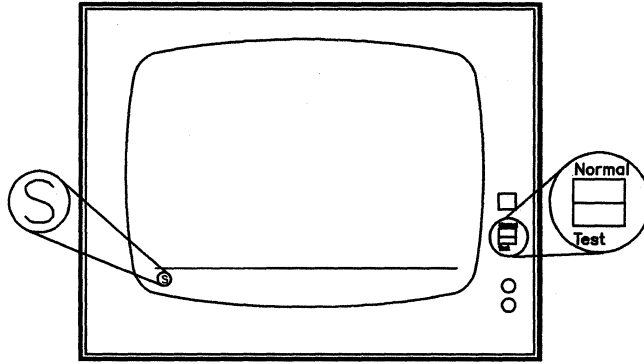

- 5** At the failing terminal, disconnect the suspect cable coming from the 3299 multiplexer.

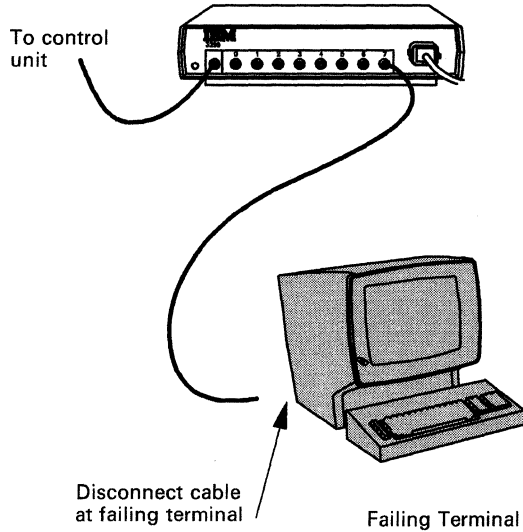

- 6** Connect the suspect cable, coming from the 3299, to a known working terminal.

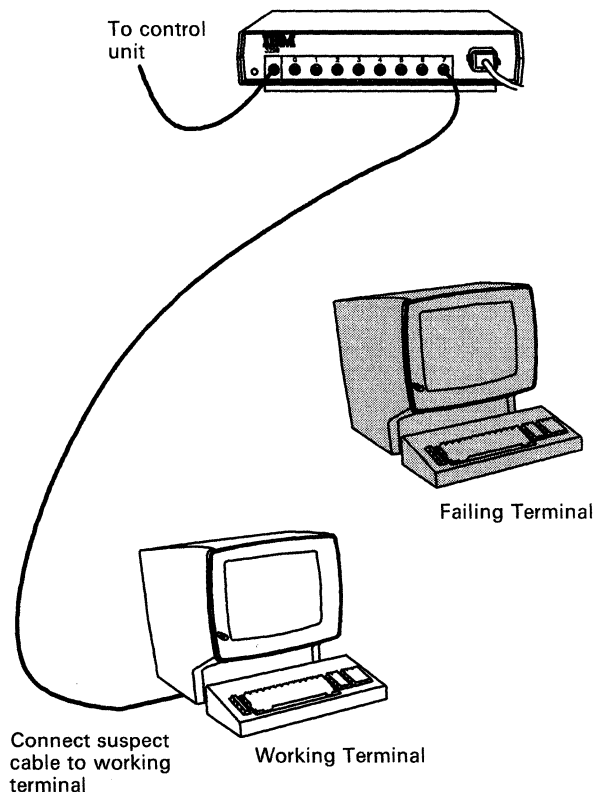

- 7** At the working terminal, set the **Normal/Test** switch to **Test**, then to **Normal**. Or, on some displays, turn power off, then on, and wait up to 2 minutes.

Is **S**, **4**, or **6** displayed in the bottom left corner of the operator information area?

**No** — The failing terminal's cable is bad. Put each cable and terminal back in its original place, and call the cable repair service.

**Yes** — The failing terminal is bad. Put each cable and terminal back in its original place. Call the terminal repair service.

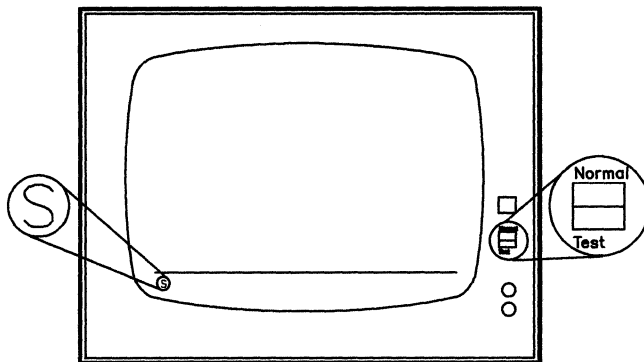

## A Directly Connected Terminal Is Failing

### Procedure F – A Directly Connected Terminal Is Failing

To do this procedure, you need a terminal known to be working. You will use this terminal to test the port on the Terminal Adapter and the cable to the failing terminal.

The problem may be in the Terminal Adapter, the cable to the terminal, the cable connections, or the terminal.

#### CAUTION:

**Do not disconnect or connect cables during an electrical storm.**

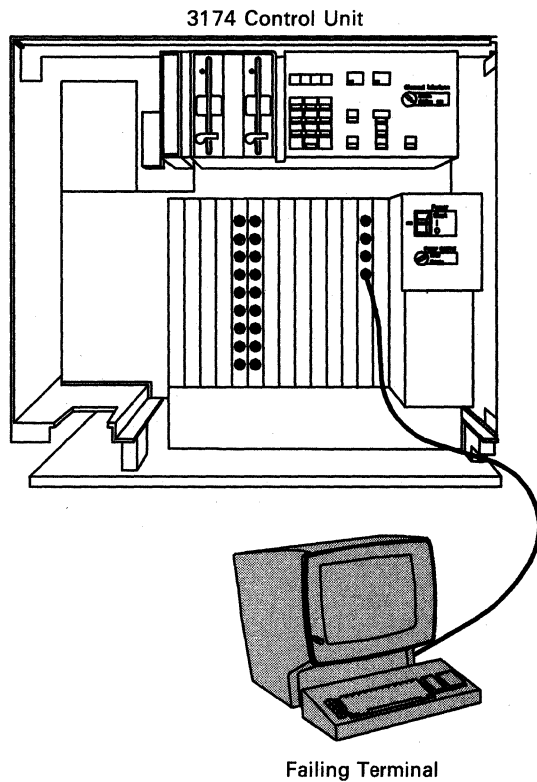

## A Directly Connected Terminal Is Failing

- 1** Check that the cables are correctly connected both to the terminal and to the control unit.

Did you find a problem?

**No** — Go to step 2 on page 3-40.

**Yes** — Correct the problem, go to the previously failing terminal, and set the **Normal/Test** switch to **Test**, then to **Normal**. Or, on some displays, turn power off, then on, and wait up to 2 minutes.

Is **S**, **4**, or **6** displayed in the bottom left corner of the operator information area?

**No** — Go to step 2 on page 3-40.

**Yes** — You fixed the problem. Stop here.

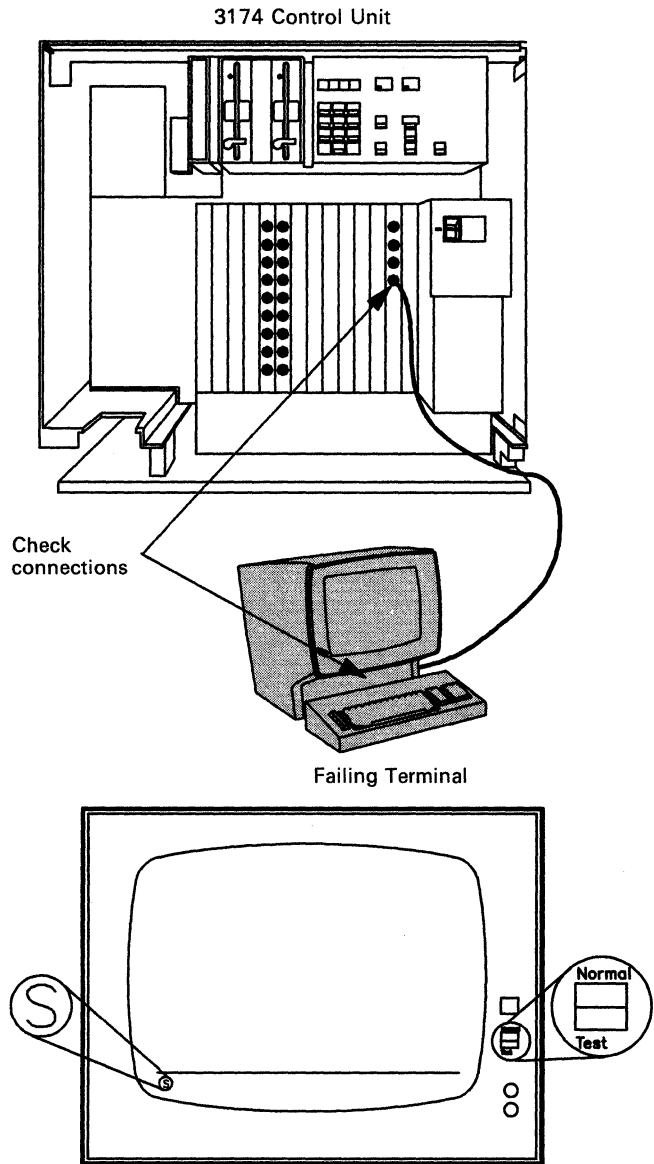



## A Directly Connected Terminal Is Failing

- 2** At the control unit, disconnect the cable coming from the failing terminal.

**Note:** If you do not know how to disconnect cables, refer to "How to Disconnect and Connect Cables" on page B-21 for the necessary information, and then return here and continue with the procedure.

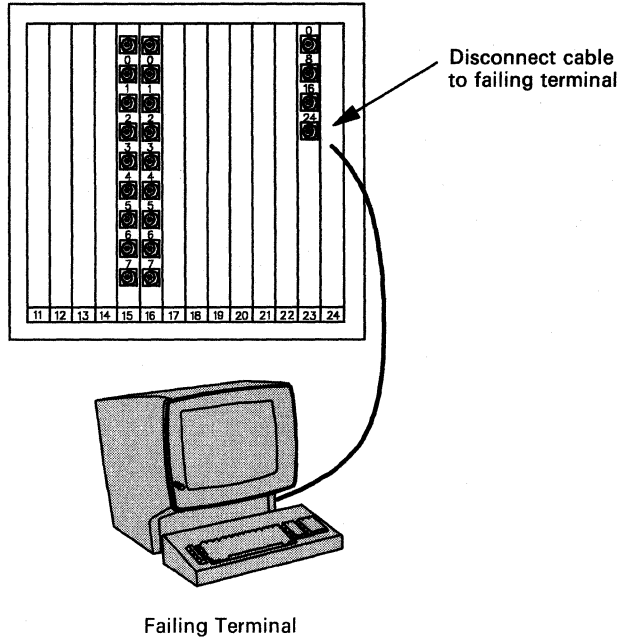

- 3** Connect a known working terminal to the suspect control unit port.

**Warning:** You must make sure that the cable you are connecting has the same type of cable connector as the one you removed in the previous step.

**Note:** You may use a working terminal from any Terminal Multiplexer Adapter or Terminal Adapter port. If necessary, notify the user of a service disruption.

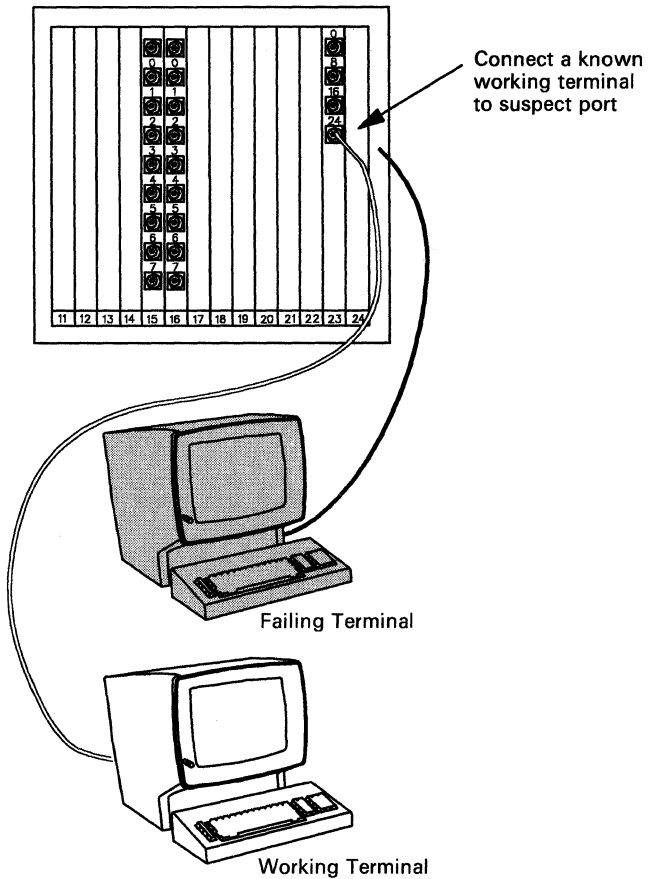

**4** At the working terminal, set the **Normal/Test** switch to **Test**, then to **Normal**. Or, on some displays, turn power off, then on, and wait up to 2 minutes.

Is **S**, **4**, or **6** displayed in the bottom left corner of the operator information area?

**No** — The control unit port is bad. Request service for the control unit.

**Yes** — The Terminal Adapter port is good. The problem is in the terminal cable or the terminal. At the Terminal Adapter, put each cable back in its original place, and go to step 5.

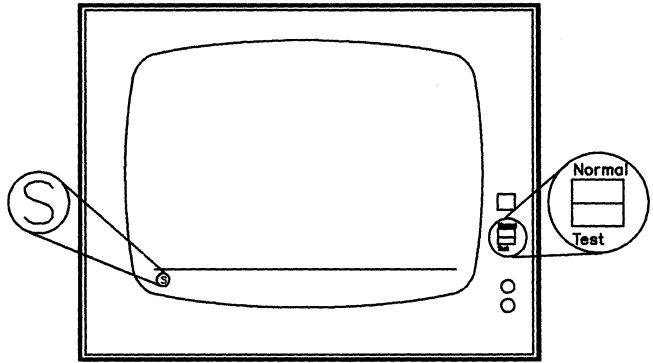

**5** At the failing terminal, disconnect the cable.

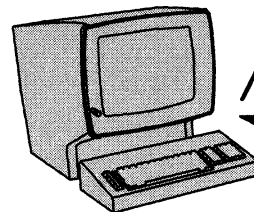
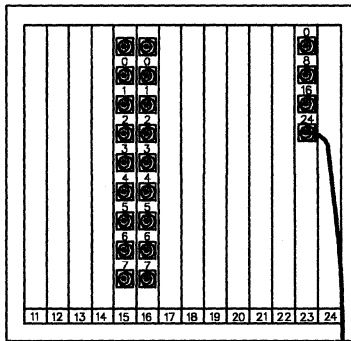

Disconnect cable from failing terminal

Failing Terminal

## A Directly Connected Terminal Is Failing

- 6** Connect the suspect cable to a known working terminal.

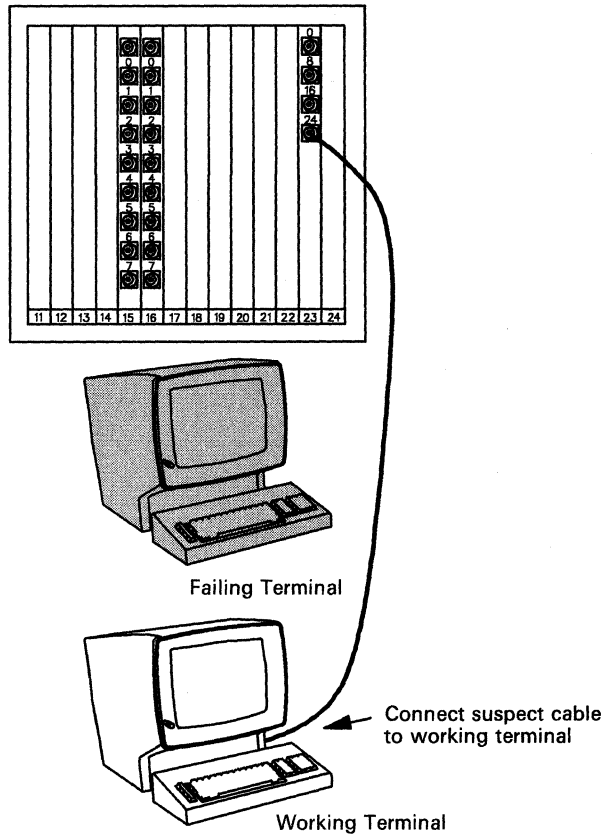

- 7** At the working terminal, set the **Normal/Test** switch to **Test**, then to **Normal**. Or, on some displays, turn power off, then on, and wait up to 2 minutes.

Is **S**, **4**, or **6** displayed in the bottom left corner of the operator information area?

- No** — The failing terminal's cable is bad. Put each cable and terminal back in its original place, and call the cable repair service.
- Yes** — The failing terminal is bad. Put each cable and terminal back in its original place. Call the terminal repair service.

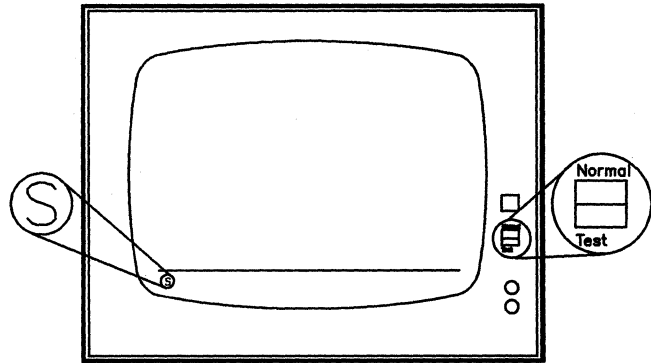

**Procedure G – A Remote Host Connection Is Failing**

You are here because the communication link between the IBM host and the 3174 adapter is failing, and either a status code referred you to this procedure or you have no system status code in the status display.

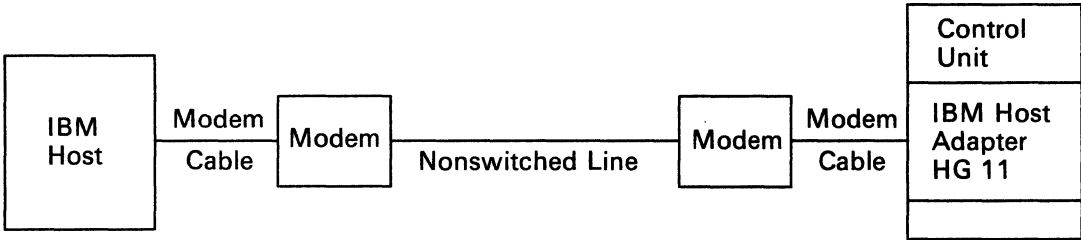

This procedure will direct you to perform an **Alt 1 IML** (refer to “Alt 1 IML Tests” on page 3-110), using the Utility diskette, to help isolate the problem.

**Warning:** An IML disrupts all control unit operations.

Step	Action	Comments
<b>1</b>	Is the host application running?	Contact your host site.
	<b>No</b> — You do not have a problem with the control unit.	
	<b>Yes</b> — GO TO step 2 on page 3-44.	

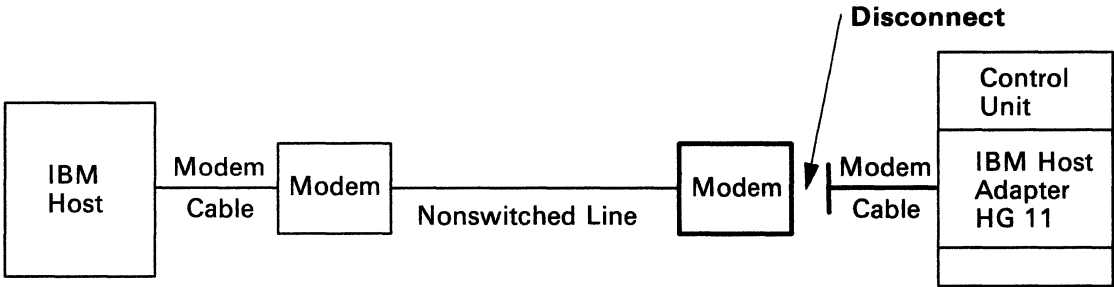

## Connection to Remote Host Is Failing

- 2** Between the control unit and the modem, disconnect the communication cable from the modem.

GO TO step 3.

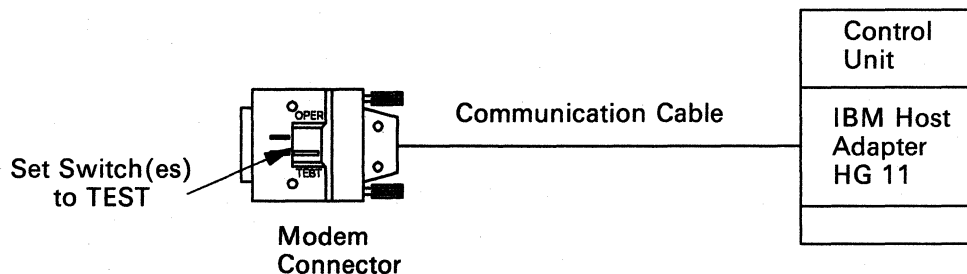

- 3** On the communication cable connector, set the TEST/OPER switch(es) to TEST.

GO TO step 4.

- 4** Insert the Utility diskette

AND

Perform an **Alt 1 IML** (refer to "Alt 1 IML Tests" on page 3-110).

**Warning:** An IML disrupts all control unit operations.

Was **2081** displayed, indicating a successful IML?

**No** — Request service for the control unit.

**Yes** — You do not have a problem with the control unit or the communication cable. GO TO step 5 on page 3-45.

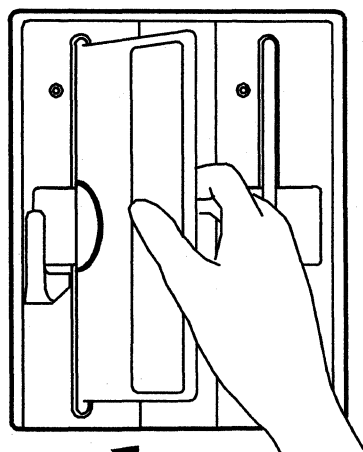

Utility diskette

---

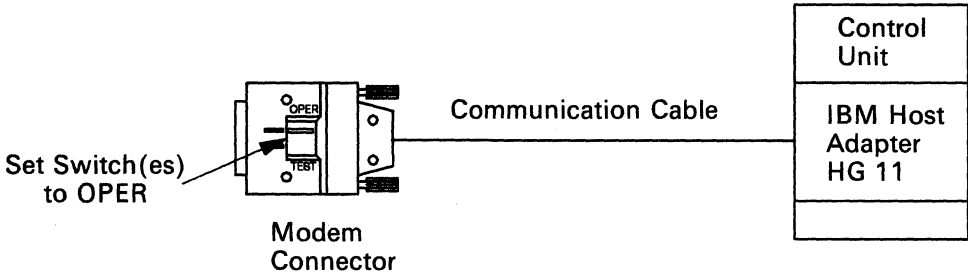

**5** On the communication cable connector, set the TEST/OPER switch(es) to OPER.  
GO TO step 6.

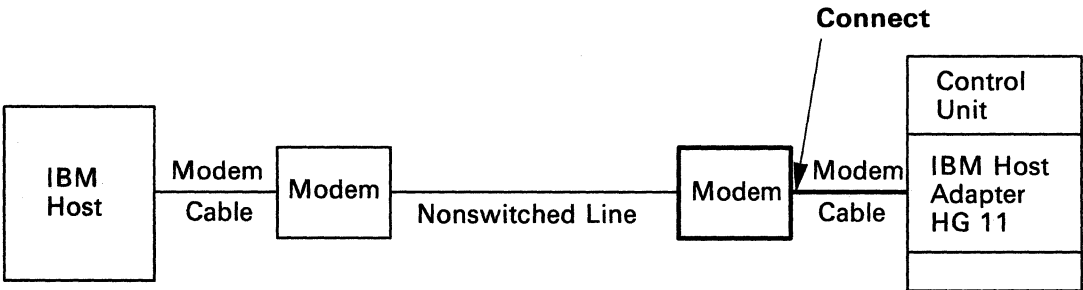

**6** Between the control unit and the modem, connect the communication cable to the modem. GO TO step 7.

End of Procedure

**7**

The following actions are recommended for suspected problems in the terminal, cabling, or connectors.

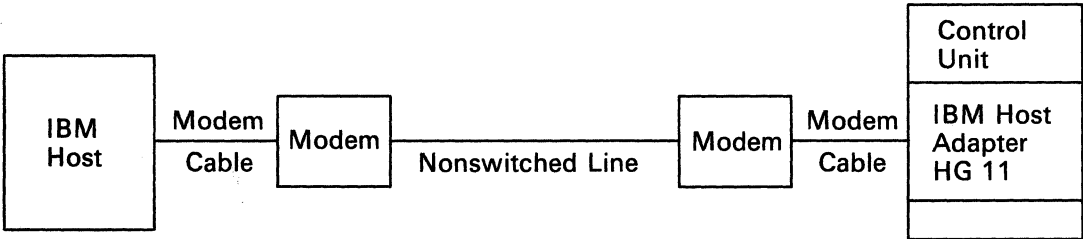

These actions are ONLY recommendations. If you have local procedures for doing problem determination, use those instructions first.

# Connection to Remote Host Is Failing

Action	Comments
--------	----------

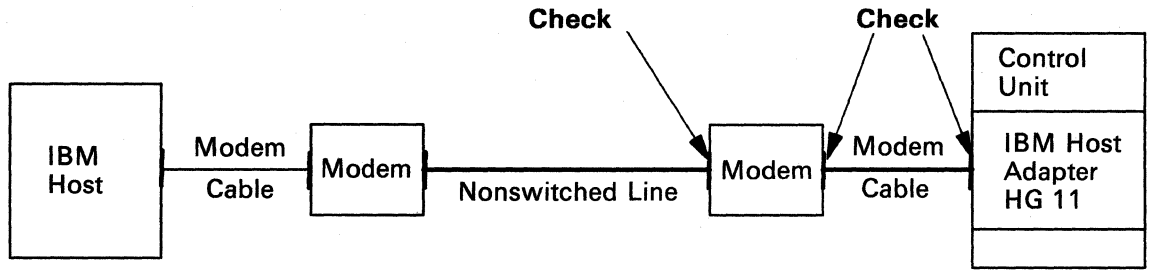

Check that the cables are connected at both the control unit adapter and the modems. Make sure that the connectors are seated and tight.

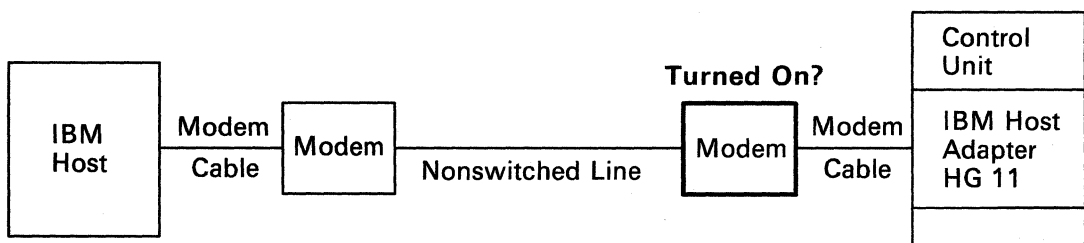

Check that the modems are turned on.

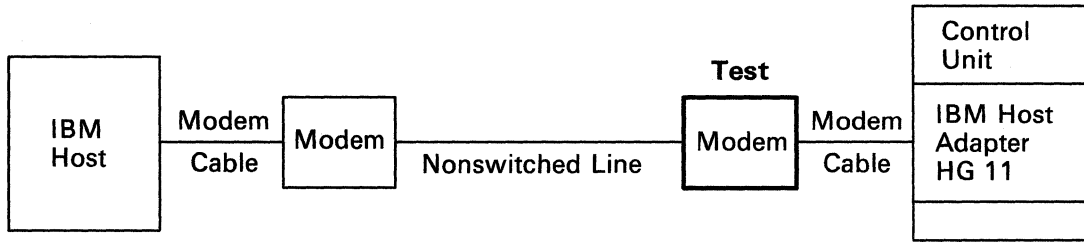

Run the modem test, if available. Use the manufacturer's instructions for running the modem test.

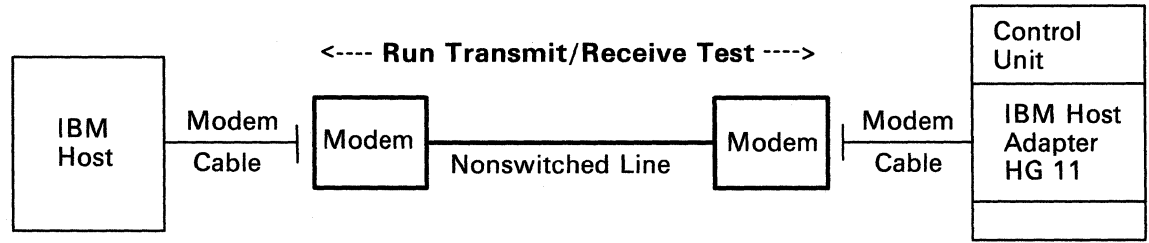

Run the modem transmit/receive test, if available. The modem may not have a transmit/receive test.

## Connection to Remote Host Is Failing

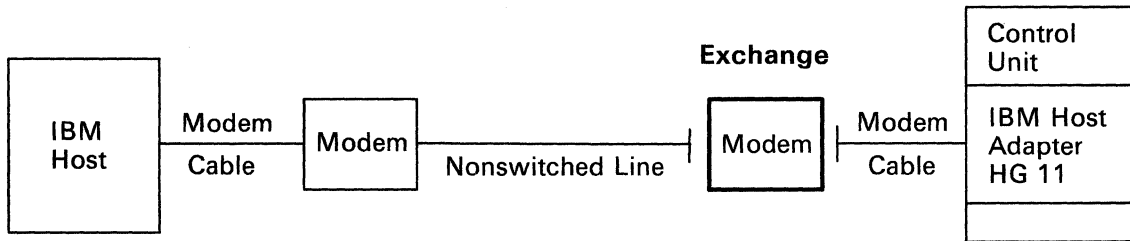

Exchange the modems.

You must exchange the same type modem.

You may have to change the modem setup to match the suspect modem.

OR

You may have to change the control unit customization parameters for this port number.

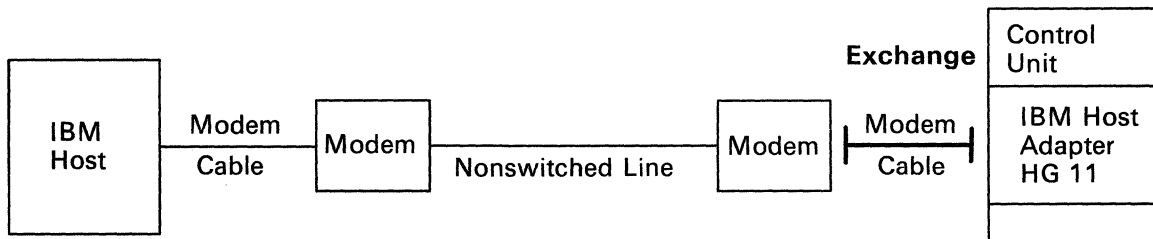

Exchange the cables between the modem and the control unit adapter.

Request help from your technical support group or help desk.



## 3299 Service/Replacement Procedure

**U.S. and Canada**

Call the IBM Service/Exchange Communications Center (toll-free) at 800-428-2569. IBM will need some product data from you to verify your warranty and/or service contract and to start the required service action. Please include the power cable when returning a 3299 to IBM.

**World Trade  
(except Canada)**

Call your IBM Repair Center or IBM Branch Office for specific instructions.

---

## ASCII Terminal Connection Problems

You are here because one or more terminals connected to the ASCII adapter (either directly or through a modem) cannot communicate with the 3174 control unit.

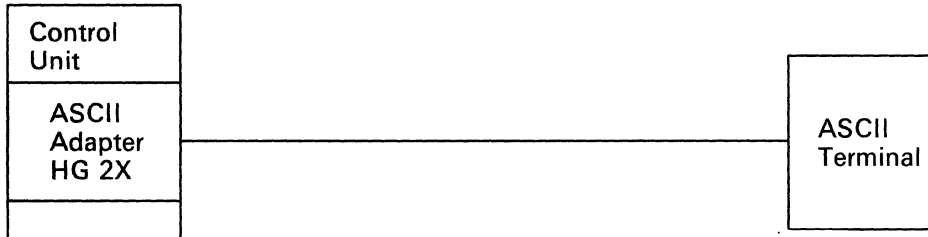

The bad connection on an ASCII display station is indicated by a missing Connection Menu or another customer-assigned message, such as *log on*, *sign on*, or *ready*. **Check your local operating instructions for the correct indication.**

Handling the problem involves three steps:

- **Collect information about the problem** (see “Collecting Information about the Problem”).
- **Select the symptom and action** (see “Selecting an ASCII Terminal Symptom” on page 3-56).
- Do the appropriate problem determination procedure as described in the **Action** selected.

This section also contains information on terminal connectors and terminal addresses.

### Collecting Information about the Problem

To complete the procedures in this section, you first need to:

1. Identify the failing terminal and its associated control unit
2. Obtain the terminal-to-3174 physical-connection information
3. Determine how the terminal is connected to the 3174
4. Determine the operating status of other connected devices, using a cabling worksheet like the one shown in Figure 3-7.

## Asynchronous Emulation Adapter 1 Port Range 21 – 00 to 21 – 07

Complete this worksheet during site planning. Use this worksheet during cable installation and terminal connection problem determination. Store this worksheet with the 3174 control unit documentation for future reference. When cabling changes are made, correct this record to reflect such changes.

3174 Model \_\_\_\_\_ 3174 Location \_\_\_\_\_ 3174 ID \_\_\_\_\_

### AEA Port Range 21-00 to 21-03

AEA 1 Connector	0	1	2	3
Cable ID				
Terminal or Host Type				
Location				
Modem Type				
Dial In Number				
Dial Out Number				
AEA Port Number	21-00	21-01	21-02	21-03

### AEA Port Range 21-04 to 21-07

AEA 1 Connector	4	5	6	7
Cable ID				
Terminal or Host Type				
Location				
Modem Type				
Dial In Number				
Dial Out Number				
AEA Port Number	21-04	21-05	21-06	21-07

Figure 3-7 (Part 1 of 2). Sample Cabling Worksheet (ASCII Terminals)

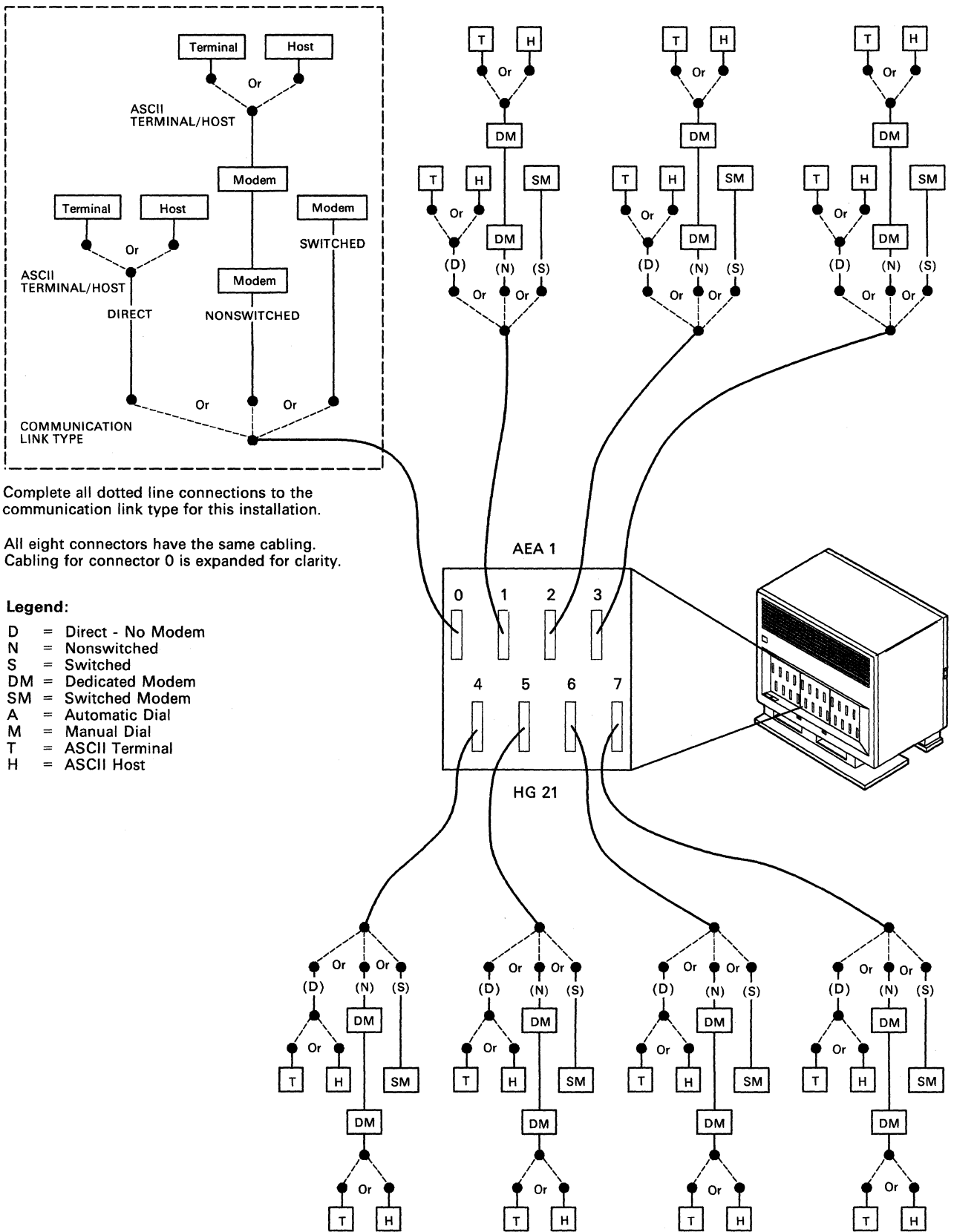

Figure 3-7 (Part 2 of 2). Sample Cabling Worksheet (ASCII Terminals)

## ASCII Terminal Connection Problems

To collect information about the problem, do the following procedures:

### 1 – Identify the Failing Terminal and Its Control Unit

Use your local resources to identify the control unit and its failing terminal(s). The control unit and its terminals may be identified in one of the following ways:

- A label on the terminal containing the control unit address, the terminal port number, or the host identifier (ID)
- A location for the terminal, for example, *the terminal in the Administration Building, office 123*
- A function or operation, for example, *the terminal in the reproduction room*
- A person's name and phone number, for example, *Red Linehan's terminal at extension 9876*
- A cable or wall socket identifier.

### 2 – Obtain Physical-Connection Information

Physical-connection information is usually stored at the control unit or at some central location. Get the installation cabling worksheets (see Figure 3-7 for a sample), or whatever other subsystem documentation is available to identify the connection path between the failing terminal and its control unit. The information should include cable IDs, port numbers, device locations, and the type of device (display station, printer, or multiplexer).

You may have a subsystem connection diagram that shows all the devices attached to the control unit (see Figure 3-8 on page 3-53).

### 3 – Determine How the Terminal Is Connected to the 3174

Using the cabling worksheets or the subsystem connection diagram, determine how a terminal is connected to the control unit.

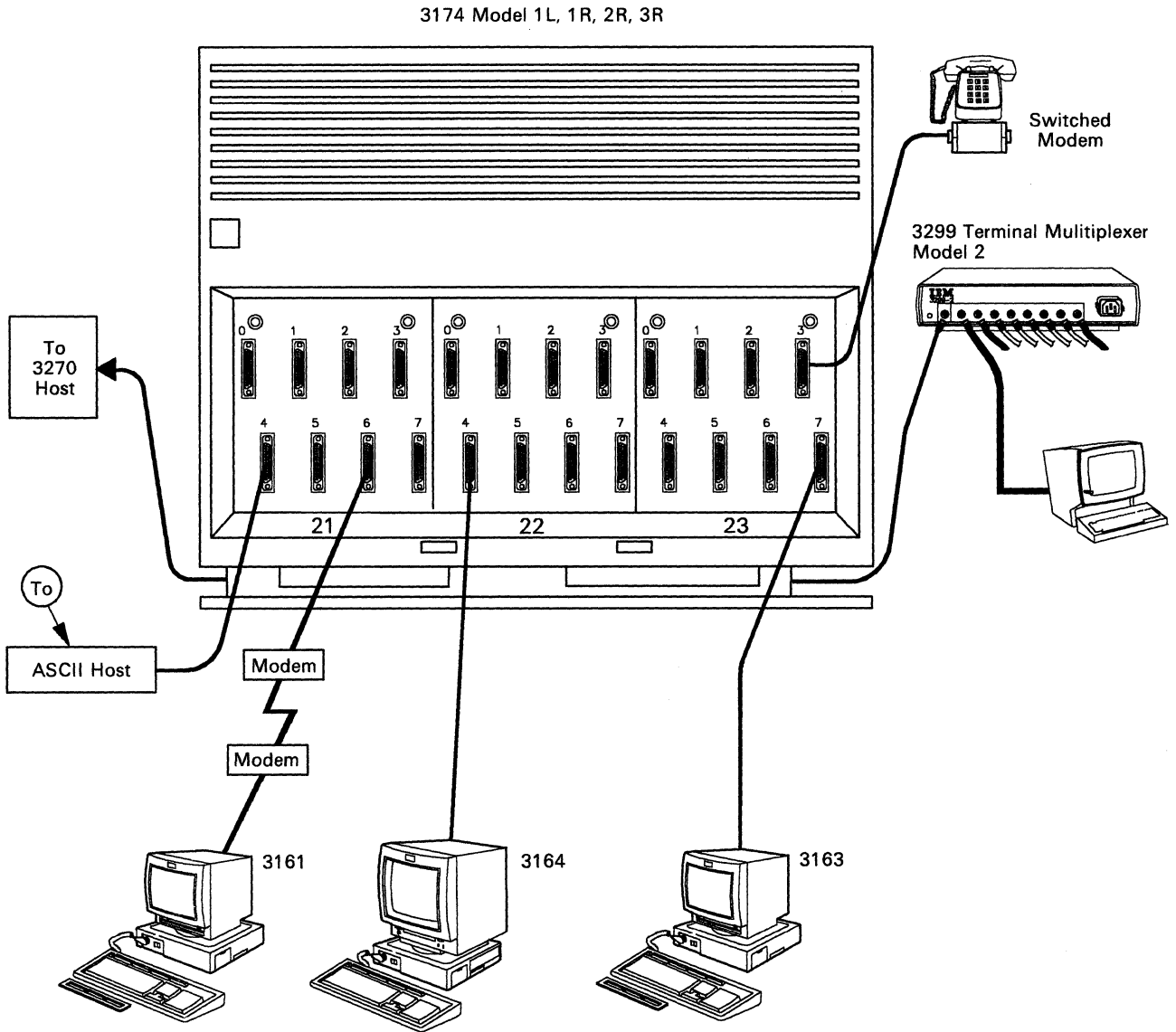

**Note:** This figure shows an overview of a 3174 with three Asynchronous Emulation Adapter features. The terminals can be any of the ASCII terminals.

Figure 3-8. Sample Physical Connection Diagram (ASCII Terminals)

**ASCII Terminal Communication Links:** There are four types of communication links between the control unit ASCII adapter and the ASCII terminal:

- Direct Line
- Nonswitched Line
- Switched Line
- Telephone Rotary.

## ASCII Terminal Connection Problems

**Direct Line:** This connection is a direct-wire communication link that does not include modems (see Appendix B for details on ASCII adapter connectors).

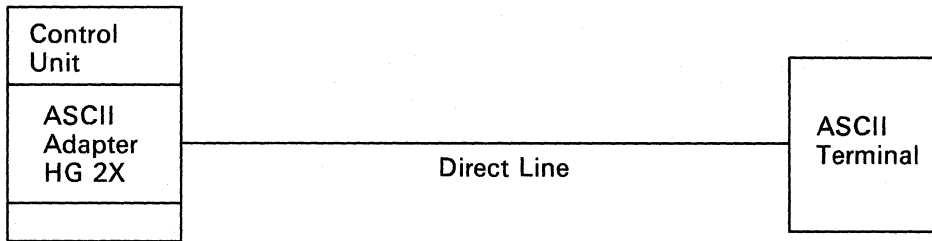

**Nonswitched Line:** This connection is a direct-line communication link between two modems, one of which is connected to the ASCII adapter and the other to the ASCII terminal (see Appendix B for details on modems and ASCII adapter connectors).

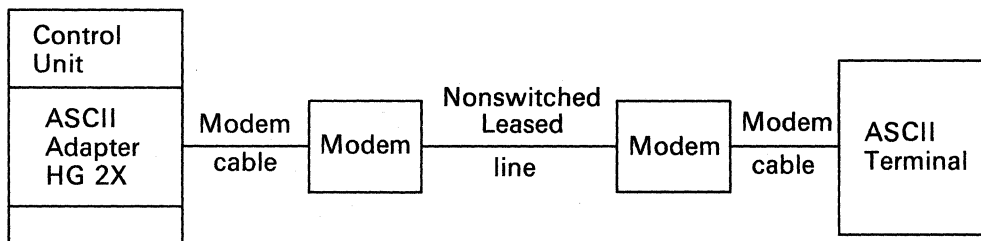

**Switched Line:** This connection is a communication link between two modems that is established by manually or automatically dialing out on a public telephone line (see Appendix B for details on modems and ASCII adapter connectors).

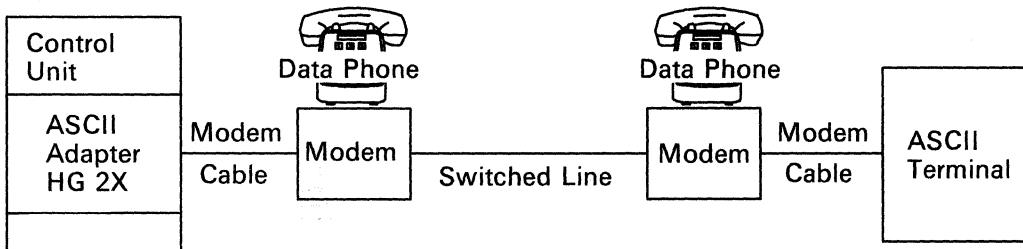

**Telephone Rotary:** This equipment allows access to more than one port of the ASCII adapter with the use of one phone number (see Appendix B for details on modems, rotaries, and ASCII adapter connectors).

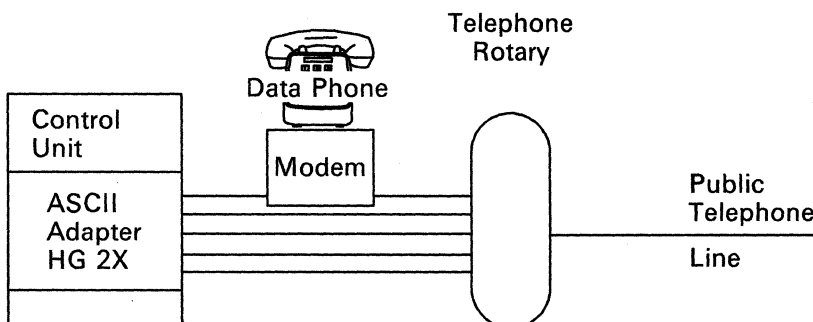

**4 – Determine the Status of Other Connected Terminals**

Determine the extent of the problem by asking other terminal users, using the same control unit, the status of their terminal.

- Are all terminals connected to the ASCII adapter failing?
- Have other terminal users identified a connection problem when trying to connect to a certain ASCII host.

**Note:** Use /12, Option 2 ASCII Status Summary test to determine the status of other terminals connected to this adapter.

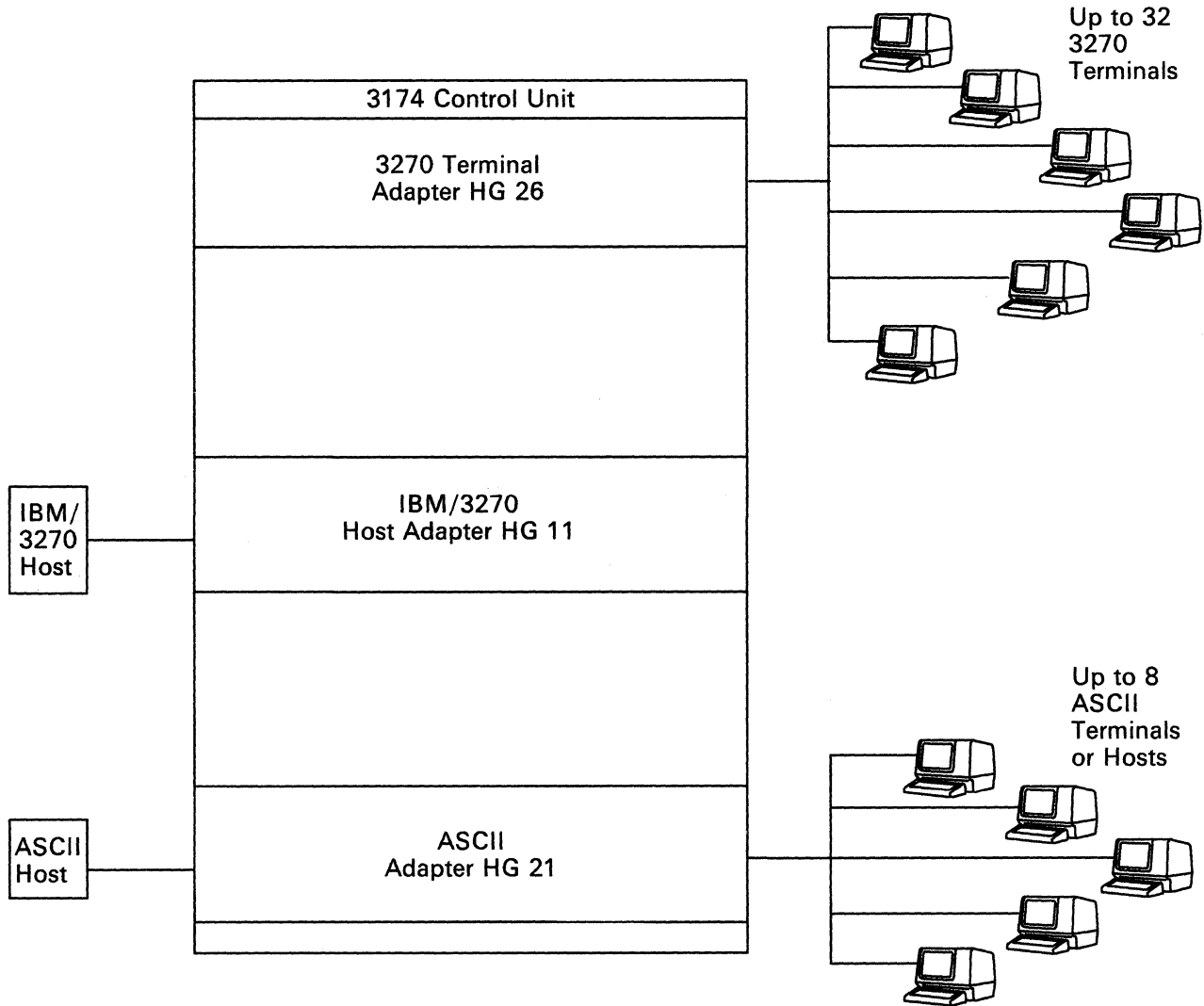

The answers to questions like these will help you to identify which symptom in Figure 3-9 on page 3-56 applies to your situation.



### Selecting an ASCII Terminal Symptom

Once you have collected all the necessary ASCII connection and status information, read down the list of symptoms, and choose the one that best describes the ASCII problem you are having. Then go to the procedure listed.

	Symptom	Action
<b>1</b>	All terminals connected to the ASCII adapter are failing.	Go to "Procedure H – All Connections to ASCII Adapter Are Failing" on page 3-57.
<b>2</b>	One terminal, <b>directly</b> connected (no modem) to the ASCII adapter, is failing.	Go to "Procedure I – One Direct ASCII Terminal Is Failing" on page 3-59.
<b>3</b>	One terminal, connected to a <b>nonswitched</b> communication link, is failing.	Go to "Procedure J – One Nonswitched ASCII Terminal Is Failing" on page 3-64.
<b>4</b>	One terminal, connected to a <b>switched</b> communication link, is failing.	Go to "Procedure K – One Switched ASCII Terminal Is Failing" on page 3-71.
<b>5</b>	One or more terminals, connected by a <b>switched</b> communication link, have failed to establish a connection to an ASCII adapter port at the control unit.	Go to "Procedure L – ASCII Adapter Does Not Respond to Incoming Call" on page 3-75.
<b>6</b>	One or more terminals, connected by a <b>switched</b> communication link, have failed to establish a connection through a telephone rotary to an ASCII adapter port at the control unit.	Go to "Procedure M – ASCII Adapter Does Not Respond to Rotary Call" on page 3-79.
<b>7</b>	More than one but not all terminals connected to the ASCII adapter are failing.	Go to the appropriate procedure above: Direct, Non-switched, Switched, or Switched through a Rotary. Handle the problem as if only one terminal were failing.

Figure 3-9. ASCII Terminal Connection Problems

## Procedure H – All Connections to ASCII Adapter Are Failing

You are here because all the communication paths (ports) to the ASCII adapter are failing, and either a status code referred you to this procedure or you have no system status code in the status display.

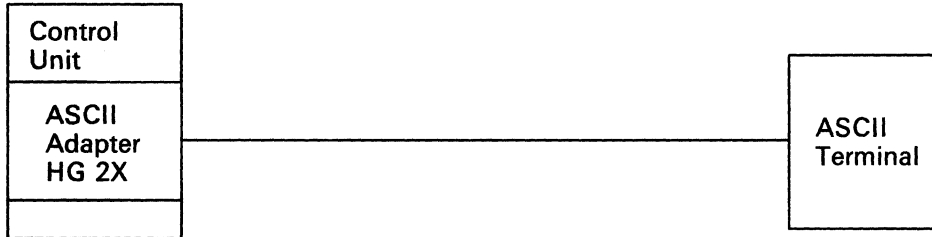

2X = 21, 22, or 23

Step	Action	Comments
------	--------	----------

**1** To run the online External Port Wrap Test, you will need the ASCII Adapter Wrap Plug, any Port Number (PN = 0 - 7) because all ports are failing, and the Hardware Group number 2X (2X = 21, 22, or 23).

Select a port number for this test.

Sign off your customer application.

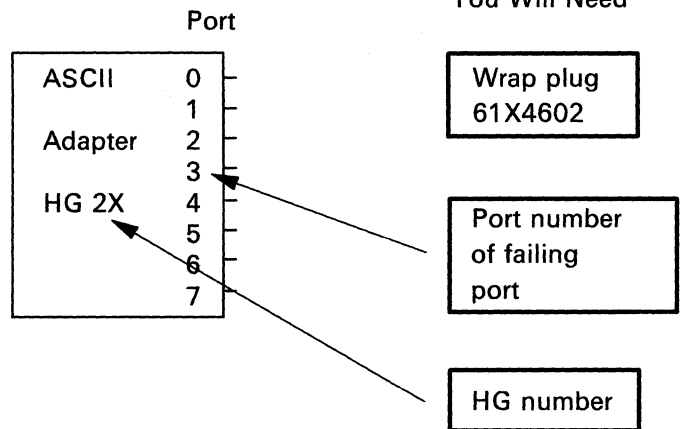

**2** At the control unit ASCII adapter, disconnect the communication cable on the port you have selected. See Figure 3-8 on page 3-53 to identify port locations.

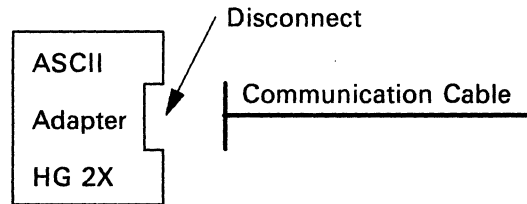

## All Connections to ASCII Adapter Are Failing

- 3** At the control unit, install the ASCII Adapter Wrap Plug on the port you have selected.

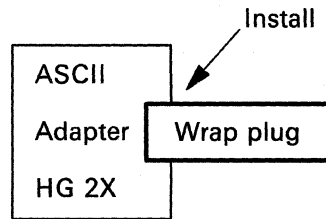

- 4** Run the Port Wrap Test.

At a working 3270 terminal, sign off your application and enter Online Test mode. Press **Alt** and **Test** in a 3270-type terminal.

For an ASCII terminal, sign off your application, request the Connection Menu, and enter Online Test mode. Refer to the *Terminal User's Reference for Expanded Functions* for the correct key sequence, if you are invoking this test from an ASCII terminal.

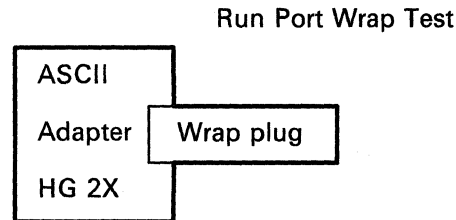

- 5** On the blank screen, enter **/12**, Option 1, and press the **Enter** key.

Enter **/12,1** on the Select Line.

- 6** When the Port Test Menu is displayed, enter **2**, the Port Number (PN) you have selected, and the Hardware Group (HG = 2X), and press the **Enter** key.

Enter **2,PN,2X** on the Select Line to invoke the External Port Wrap Test, where 2X = 21, 22, or 23.

- 7** When the **Ready** message is displayed, the first part of the test has been completed successfully.

If the screen remains blank, the test has failed.

Type in some characters to initiate the last part of the test. Each character should appear on the screen immediately.

If the characters sent to the screen are incorrect or garbled, it may be due to an error in customization or a terminal problem.

It is as if the characters are bounced off the wrap plug and onto the terminal screen.

- 8** Was the test successful?

**No** — Request service for the control unit. Ask to have the ASCII adapter replaced.

Store the ASCII Adapter Wrap Plug.

**Yes** — All ports on the ASCII adapter are not failing. GO TO "Selecting an ASCII Terminal Symptom" on page 3-56.

End of Procedure

**Procedure I – One Direct ASCII Terminal Is Failing**

You are here because you are having a problem with the direct (no modems) cable path between the control unit and an ASCII terminal, and either a status code referred you to this procedure or you have no system status code in the status display.

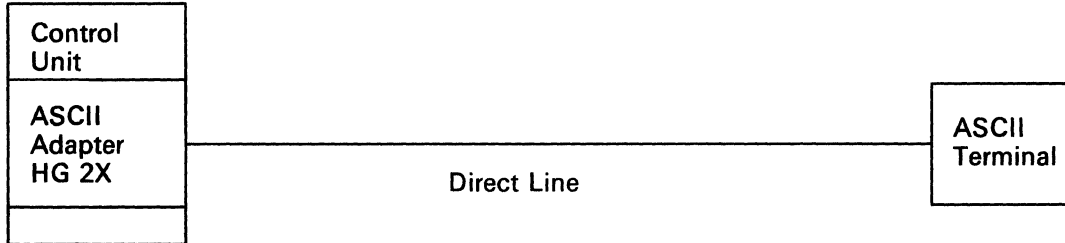

2X = 21, 22, or 23

**Note:** You may need someone at the terminal end to assist in this procedure.

This procedure will determine whether the ASCII terminal can communicate with the control unit.

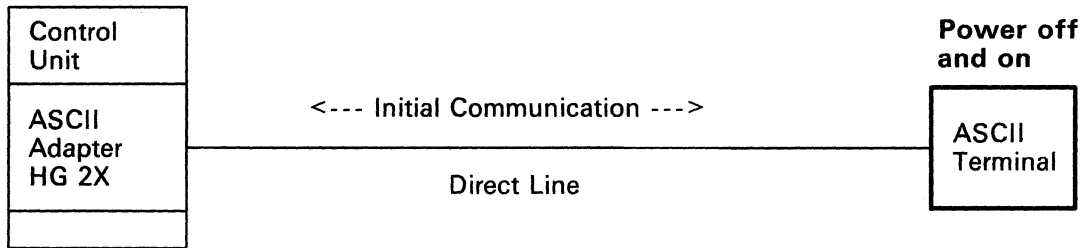

Step	Action	Comments
1	<p>At the ASCII terminal, turn the power <b>OFF</b> and <b>ON</b> again. Then press any key.</p> <p>Did you get the initial response?</p> <p><b>No</b> — Go to step 2 on page 3-60.</p> <p><b>Yes</b> — The path between the control unit and the terminal is <b>NOT</b> failing.</p> <p>You may have a setup or customization problem. Request help from your technical support group or help desk.</p>	<p>This starts the initial communication between the terminal and the control unit, which will be indicated by the Connection Menu, log-on, sign-on, Ready, or other customer messages.</p> <p><b>Check your local operating instructions for the correct indication of a successful or failing connection.</b></p>

**One Direct ASCII Terminal Connection Is Failing**

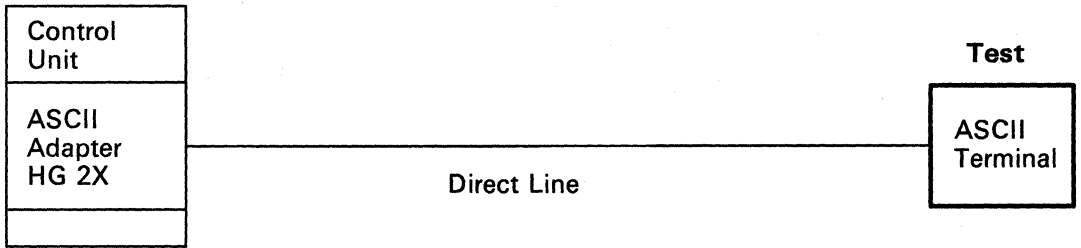

**2** If you have not performed the terminal manufacturer's problem determination procedures, do so now.

Is there a problem with the terminal?

No — Go to step 3.

Yes — Request service for the terminal.

**3** To run the online External Port Wrap Test, you will need the ASCII Adapter Wrap Plug, any Port Number (PN = 0 - 7), and the Hardware Group number 2X (2X = 21, 22, or 23).

Sign off your customer application.

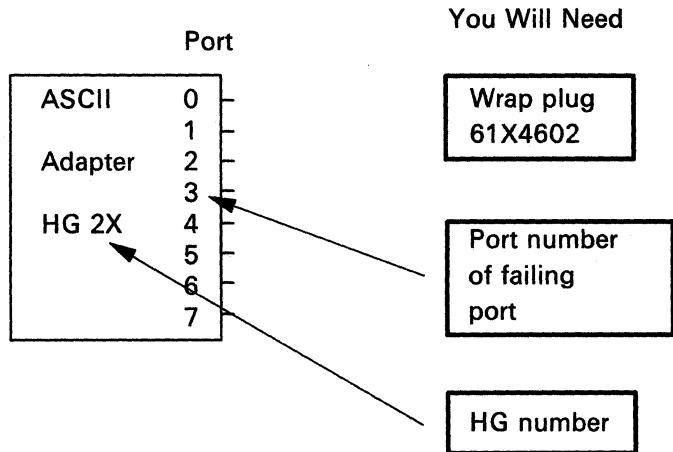

**4** At the control unit ASCII adapter, disconnect the communication cable on the failing port. See Figure 3-8 on page 3-53 to identify port locations.

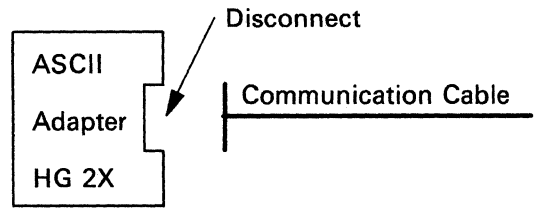

- 5** At the control unit, install the ASCII Adapter Wrap Plug on the failing port.

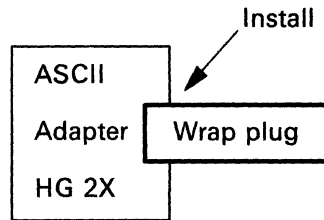

**6 Run the Port Wrap Test.**

At a working 3270 terminal, sign off your application and enter Online Test mode. Press **Alt** and **Test**.

For an ASCII terminal, sign off your application, request the Connection Menu, and enter Online Test mode. Refer to the *Terminal User's Reference for Expanded Functions* for the correct key sequence, if you are invoking this test from an ASCII terminal.

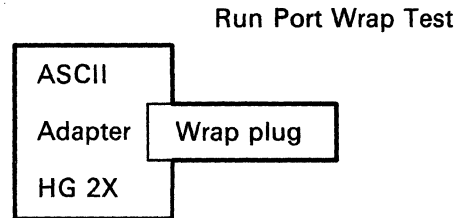

- 7** On the Select Line, enter **/12**, Option 1, and press the **Enter** key.

Enter **/12,1** on the Select Line.

- 8** When the Port Test Menu is displayed, enter **2**, the Port Number (PN) you have selected, and the Hardware Group (HG = 2X), and press the **Enter** key.

Enter **2,PN,2X** on the Select Line to invoke the External Port Wrap Test, where 2X = 21, 22, or 23.

- 9** When the **Ready** message is displayed, the test has been completed successfully.

Type in some characters. Each character should appear on the screen immediately.

It is as if the characters are bounced off the wrap plug and onto the terminal screen.

If the screen remains blank, the test has failed.

If the characters sent to the screen are incorrect or garbled, it may be due to an error in customization or a terminal problem.

**10** Was the test successful?

**No** — Request service for the control unit. Ask to have the ASCII adapter replaced.

**Yes** — The ASCII adapter is not the problem.

GO TO step 11 on page 3-62.

If you have additional local procedures, do them now.

OR

Request help from your technical support group or help desk.

OR

Use the following list as a guide to doing additional problem determination.

End of Procedure

# One Direct ASCII Terminal Connection Is Failing

## 11

The following actions are recommended for suspected problems in the terminal, cabling, or connectors.

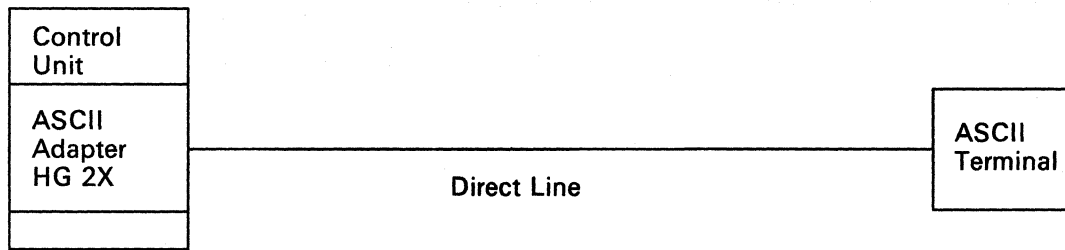

These actions are **ONLY** recommendations. If you have local procedures for doing problem determination, use those instructions first.

---

### Action

### Comments

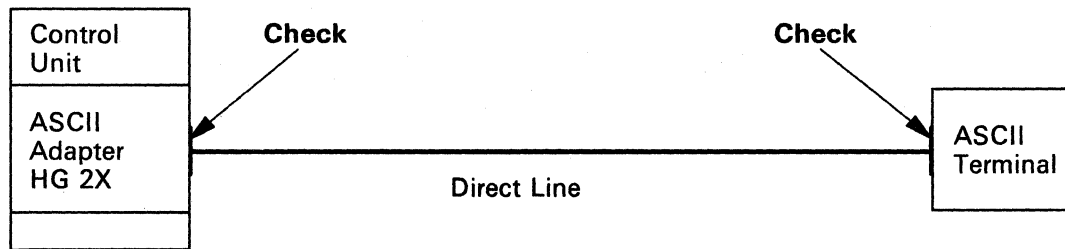

Check that the cable is connected at both the control unit and terminal.

Make sure that the connectors are seated and tight.

Check the cable for breaks along its entire length.

The cable may not be accessible along its entire length.

You may not be able to readily see a break internal to the cable covering.

---

## One Direct ASCII Terminal Connection Is Failing

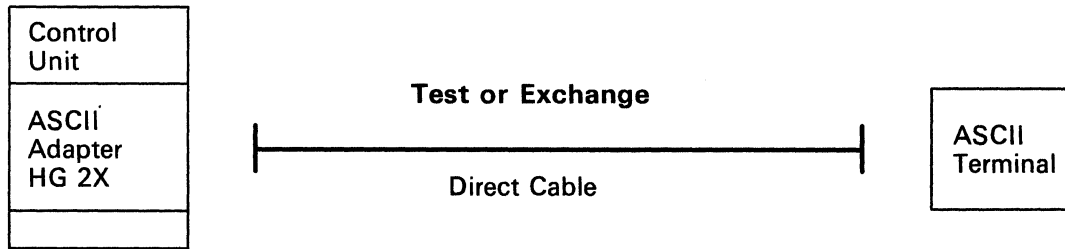

Exchange the cable.

The cable may be difficult to handle because of its length or weight.

The connectors on both ends of the cable must be the same as those on the suspect cable.

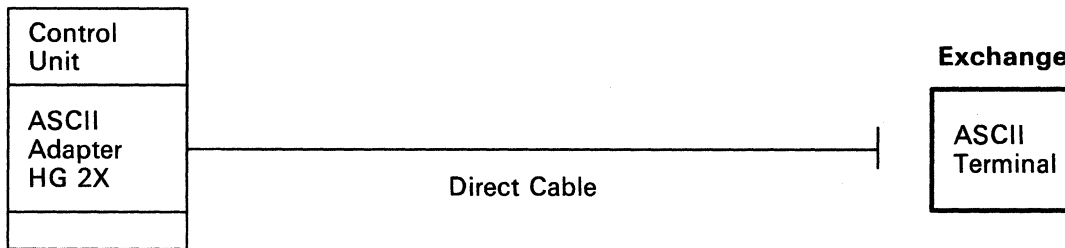

Exchange the terminal with a known working terminal of the same type.

You may have to change the terminal's operational setup.

OR

You may have to change the control unit configuration for the terminal.

---

Request help from your technical support group or help desk.



### Procedure J – One Nonswitched ASCII Terminal Is Failing

You are here because you are having a problem with the nonswitched communication path between the control unit and an ASCII terminal, and either a status code referred you to this procedure or you have no system status code in the status display.

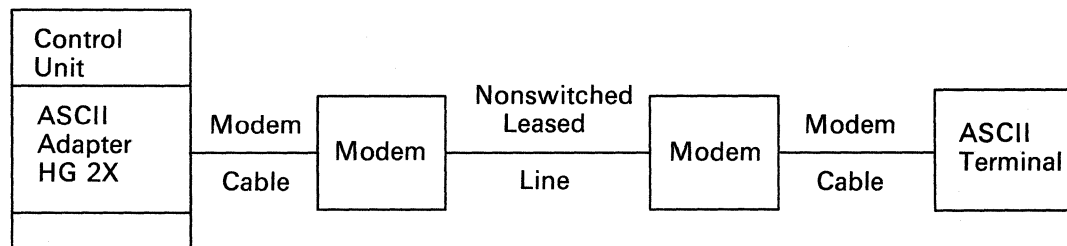

2X = 21, 22, or 23

**Note:** You may need someone at the terminal end to assist in this procedure.

This procedure will determine whether the ASCII terminal can communicate with the control unit.

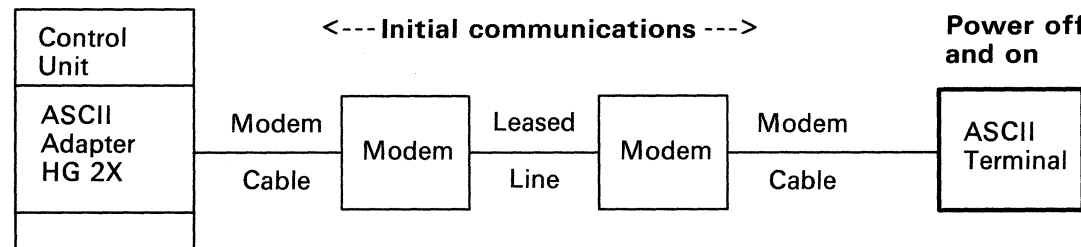

Step	Action	Comments
1	<p>At the ASCII terminal, turn the power <b>OFF</b> and <b>ON</b> again. Then press any key.</p> <p>Did you get the initial response?</p> <p><b>No</b> — Go to step 2 on page 3-65.</p> <p><b>Yes</b> — The path between the control unit and the terminal is <b>NOT</b> failing.</p> <p>You may have a setup or customization problem. Request help from your technical support group or help desk.</p>	<p>This starts the initial communication between the terminal and the control unit, which will be indicated by the Connection Menu, log-on, sign-on, Ready, or other customer messages.</p> <p><b>Check your local operating instructions for the correct indication of a successful or failing connection.</b></p>

## One Nonswitched ASCII Terminal Connection Is Failing

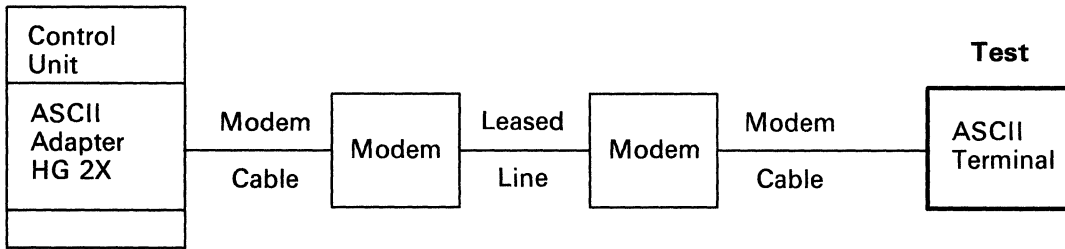

- 2** If you have not performed the terminal manufacturer's problem determination procedures, do so now.

Is there a problem with the terminal?

**No** — GO TO step 3.

**Yes** — Request service for the terminal.

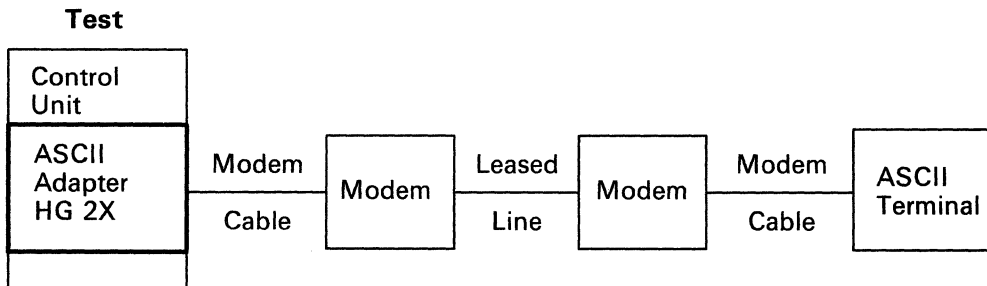

- 3** To run the online External Port Wrap Test, you will need the ASCII Adapter Wrap Plug, any Port Number (PN = 0 - 7), and the Hardware Group number 2X (2X = 21, 22, or 23).

Sign off your customer application.

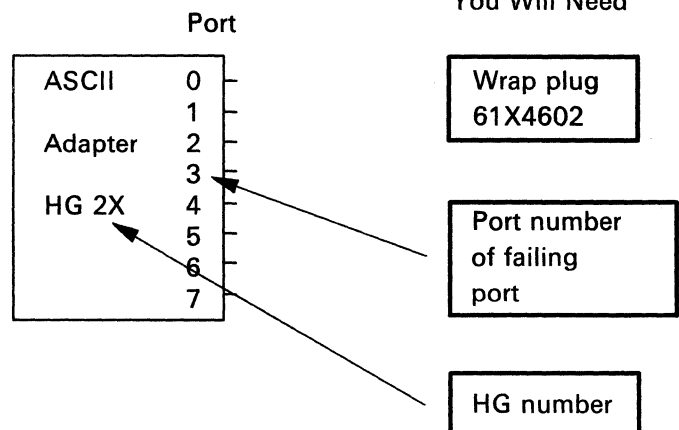

## One Nonswitched ASCII Terminal Connection Is Failing

- 4** At the control unit ASCII adapter, disconnect the communication cable on the failing port. See Figure 3-8 on page 3-53 to identify port locations.

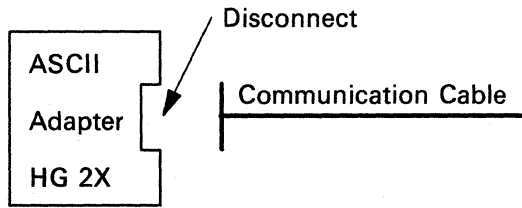

- 5** At the control unit, install the ASCII Adapter Wrap Plug on the failing port.

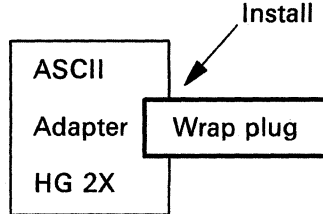

- 6** Run the Port Wrap Test.

At a working 3270 terminal, sign off your application and enter Online Test mode. Press **Alt** and **Test**.

For an ASCII terminal, sign off your application, request the Connection Menu, and enter Online Test mode. Refer to the *Terminal User's Reference for Expanded Functions* for the correct key sequence, if you are invoking this test from an ASCII terminal.

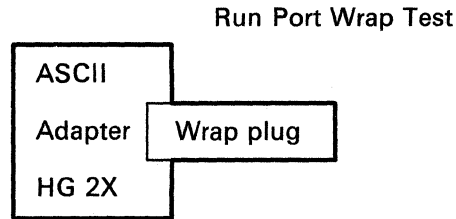

- 7** On the Select Line, enter **/12**, Option 1, and press the **Enter** key.

Enter **/12,1** on the Select Line.

- 8** When the Port Test Menu is displayed, enter **2**, the Port Number (PN) you have selected, and the Hardware Group (HG = 2X), and press the **Enter** key.

Enter **2,PN,2X** on the Select Line to invoke the External Port Wrap Test, where 2X = 21, 22, or 23.

- 9** When the **Ready** message is displayed, the first part of the test has been completed successfully.

If the screen remains blank, the test has failed.

Type in some characters to begin the last part of the test. Each character should appear on the screen immediately.

If the characters sent to the screen are incorrect or garbled, it may be due to an error in customization or a terminal problem.

It is as if the characters are bounced off the wrap plug and onto the terminal screen.

## One Nonswitched ASCII Terminal Connection Is Failing

**10** Was the test successful?

**No** — Request service for the control unit.  
Ask to have the ASCII adapter replaced.

**Yes** — The ASCII adapter is not the problem. GO TO step 11.

If you have additional local procedures, do them now.

OR

Request help from your technical support group or help desk.

OR

Use the following list as a guide to doing additional problem determination.

End of Procedure

## 11

The following actions are recommended for suspected problems in the terminal, cabling, connectors, or modems.

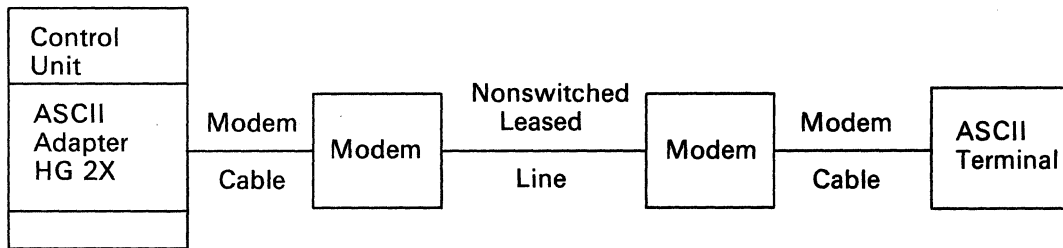

These actions are **ONLY** recommendations. If you have local procedures for doing problem determination, use those instructions first.

### Action

### Comments

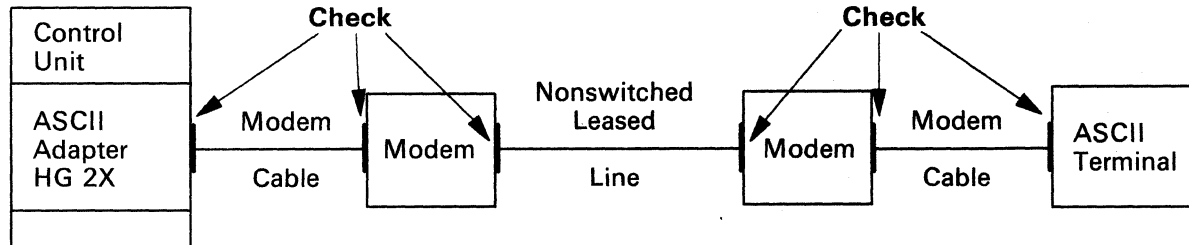

Check that the cables are connected at the control unit adapter, modems, and terminals.

Make sure that the connectors are seated and tight.

# One Nonswitched ASCII Terminal Connection Is Failing

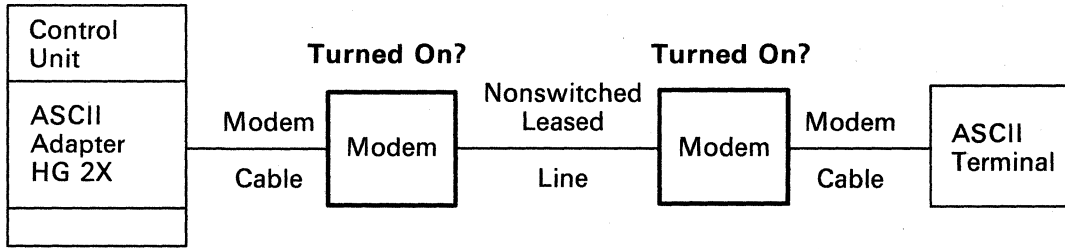

Check that the modems are turned on.

---

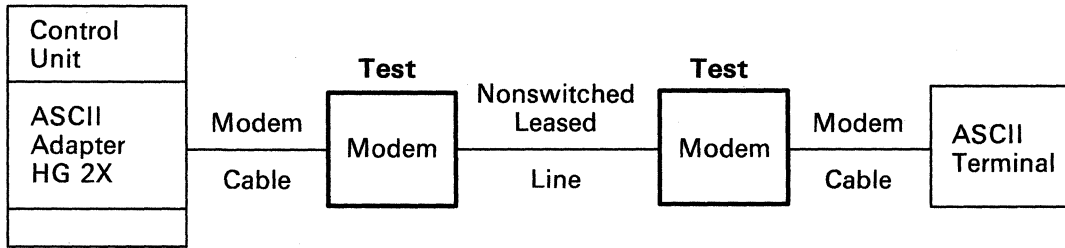

Run the modem test, if available.

Use the manufacturer's instructions for running the modem test.

---

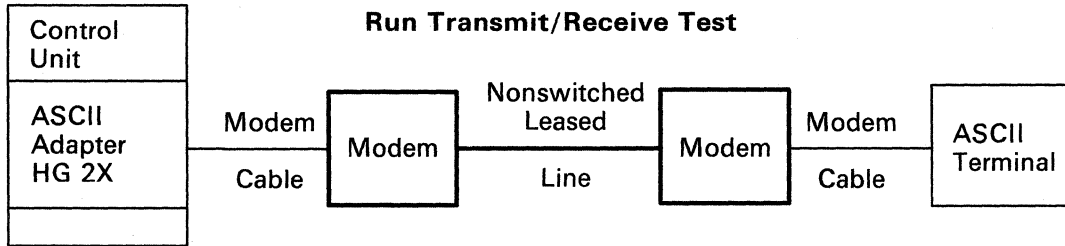

Run the modem transmit/receive test, if available.

The modem may not have a transmit/receive test.

---

## One Nonswitched ASCII Terminal Connection Is Failing

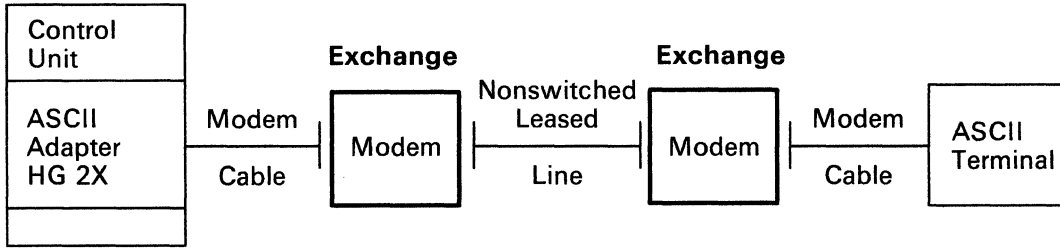

Exchange the modems, one at a time.

You must exchange the same type modem.

You may have to change the modem setup to match the suspect modem.

OR

You may have to change the control unit customization parameters for this port number.

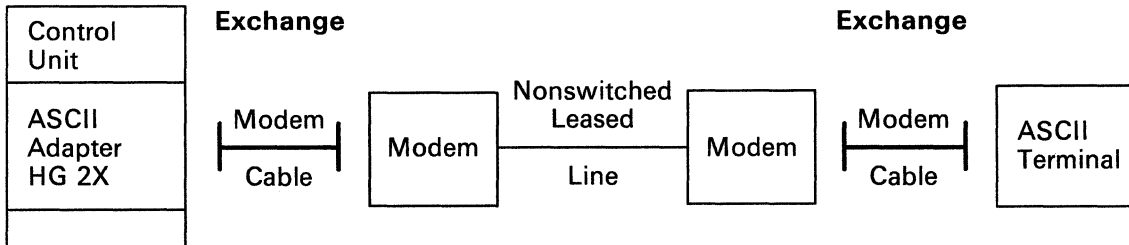

Exchange the cables between modem and terminal and between modem and adapter.

Request help from your technical support group or help desk.

## One Nonswitched ASCII Terminal Connection Is Failing

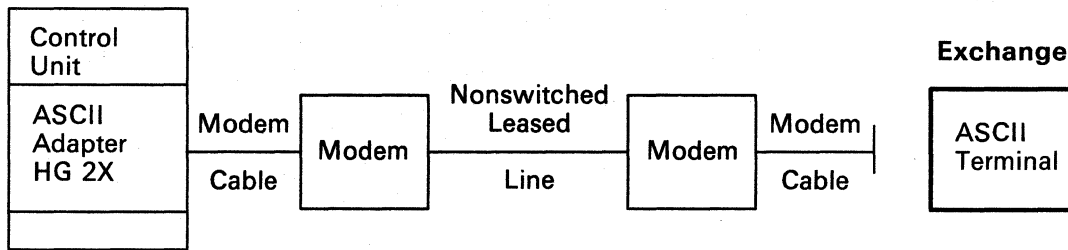

Exchange the terminal with a known working terminal of the same type.

You may have to change the terminal's operational setup.

OR

You may have to change the control unit customization parameters for the terminal.

---

Request help from your technical support group or help desk.

### Procedure K – One Switched ASCII Terminal Is Failing

You are here because you are having a problem with an ASCII terminal establishing a connection when dialing over a public telephone line into the control unit ASCII adapter, and either a status code referred you to this procedure or you have no system status code in the status display.

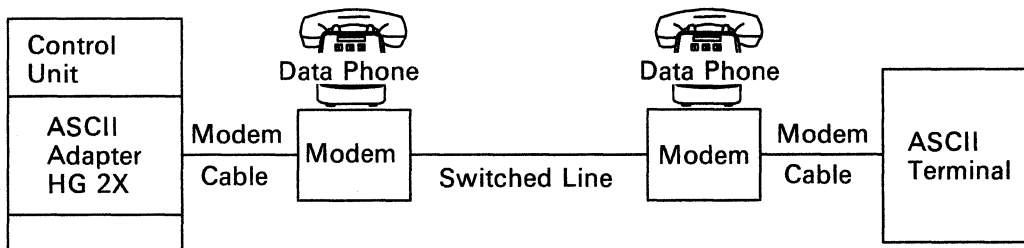

2X = 21, 22, or 23

This procedure will determine whether the ASCII terminal can communicate with the control unit.

<---- Call to 3174 Control Unit  
ASCII adapter port fails.

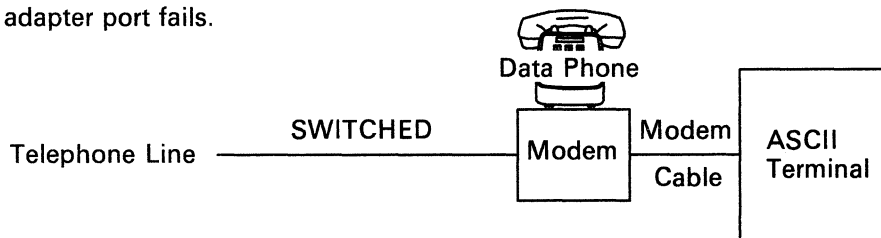

Step	Action	Comments
1	<p>Are other ASCII terminal users having a problem calling into this ASCII adapter port (phone number)?</p> <p><b>No</b> — The ASCII adapter is not the problem. GO TO step 2.</p> <p><b>Yes</b> — Go to "Procedure L – ASCII Adapter Does Not Respond to Incoming Call" on page 3-75.</p>	<p>The ASCII adapter is working if the port receives calls from other ASCII terminal users.</p>
2	<p>Do you have a dial tone?</p> <p><b>No</b> — Contact the appropriate phone services to have the phone line connected or repaired.</p> <p><b>Yes</b> — GO TO step 3 on page 3-72.</p>	



## One Switched ASCII Terminal Connection Is Failing

**3** If you have not performed the terminal manufacturer's problem determination procedures, do so now.

Is there a problem with the terminal?

**No** — Go to step 4.

**Yes** — Request service for the terminal.

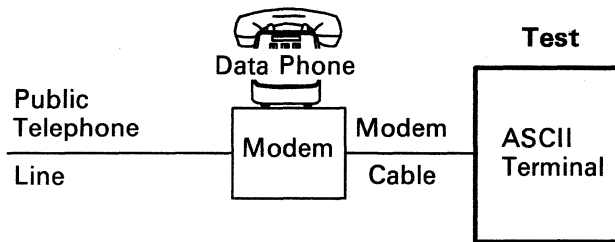

End Of Procedure

## 4

The following actions are recommended for suspected problems in the terminal, cabling, connectors, or modems.

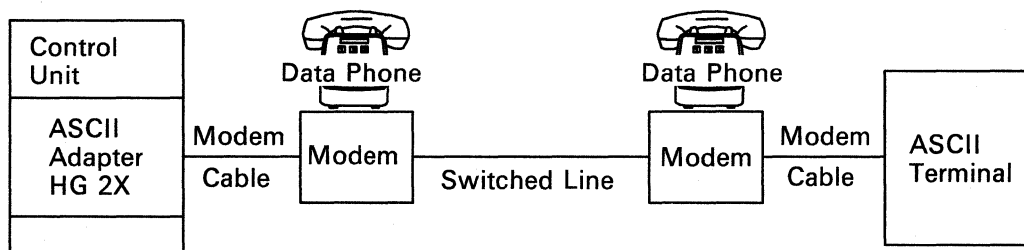

These actions are ONLY recommendations and are performed at the terminal.

### Action

### Comments

Check that the cables are connected at the modem and terminal.  
Make sure that the connectors are seated and tight.

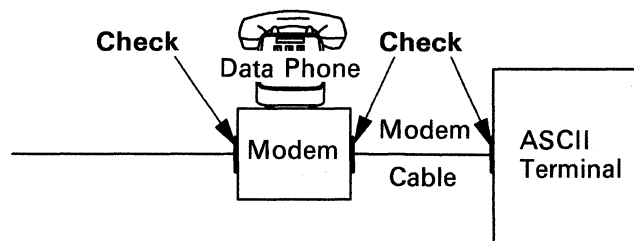

Check that the modem is turned on.

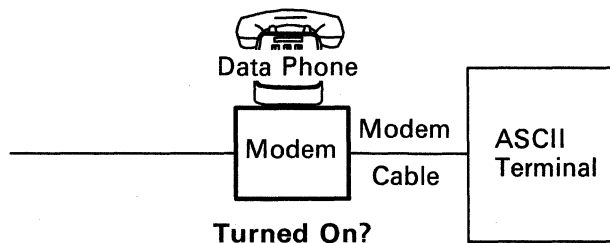

# One Switched ASCII Terminal Connection Is Failing

Run the modem self-test, if available.

Use the manufacturer's instructions for running the modem test.

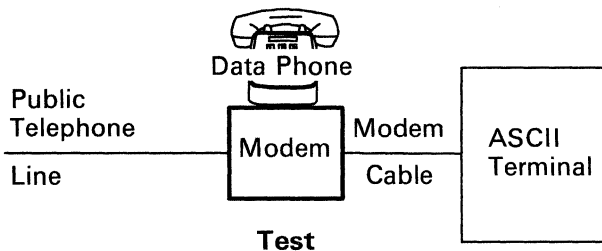

Try to establish a connection to another phone number.

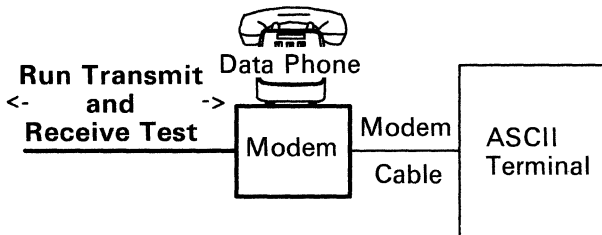

Exchange the modem cable.

Make sure the corresponding connector on each cable is identical.

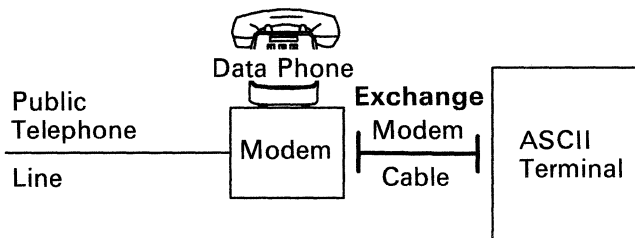

Exchange the modem.

You may have to change the modem setup to match the suspect modem.

You must exchange the same type modem.

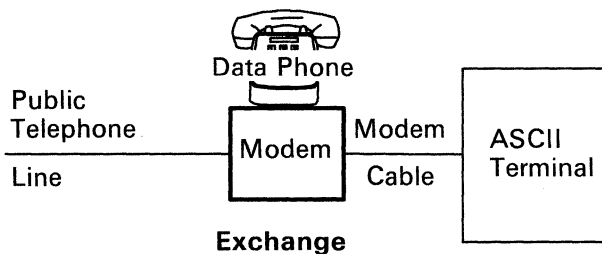

## One Switched ASCII Terminal Connection Is Failing

If present, exchange the data phone.

You must exchange the same type data phone.

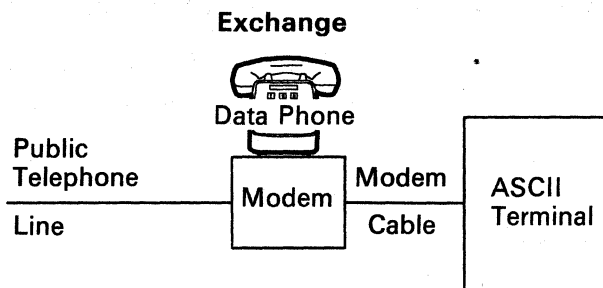

Exchange the terminal.

You may have to change the terminal's operational setup to match the suspect terminal.

You must exchange the same type

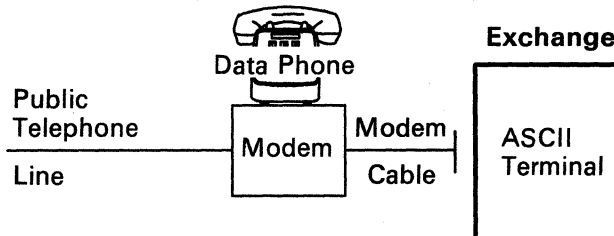

You must exchange the same type working terminal.

Request help from your technical support group or help desk.

**Procedure L – ASCII Adapter Does Not Respond to Incoming Call**

You are here because you are having a problem with a switched communications path into a control unit ASCII adapter port, and you have no System Status Code in the status display.

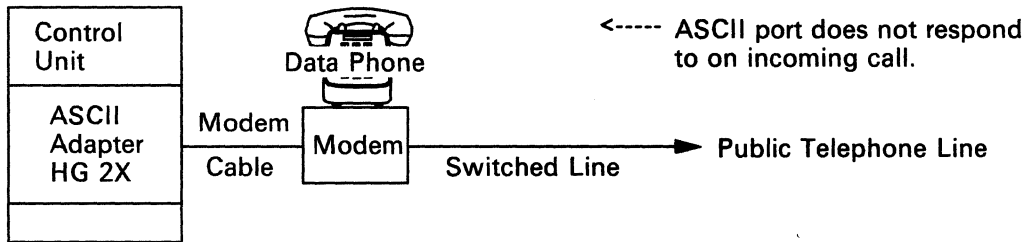

2X = 21, 22, or 23

**Note:** You may need someone at the terminal end to assist in doing this procedure.

**Test**

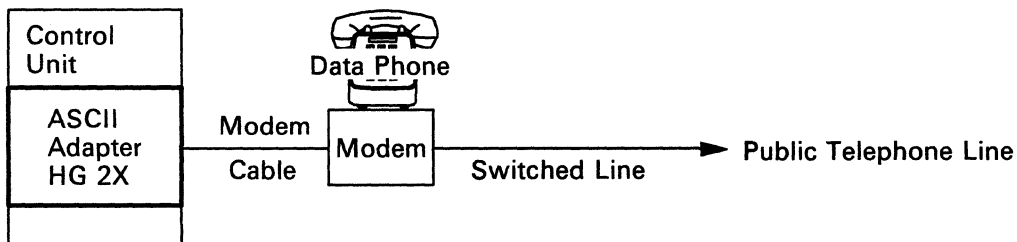

Step	Action	Comments
1	<p>To run the online External Port Wrap test you will need the ASCII Adapter Wrap Plug, any Port Number (PN = 0 - 7), and the Hardware Group number 2X (2X = 21, 22, or 23).</p> <p>Sign off your customer application.</p>	<p><b>You Will Need</b></p> <ul style="list-style-type: none"> <li>Wrap plug 61X4602</li> <li>Port number of failing port</li> <li>HG number</li> </ul>

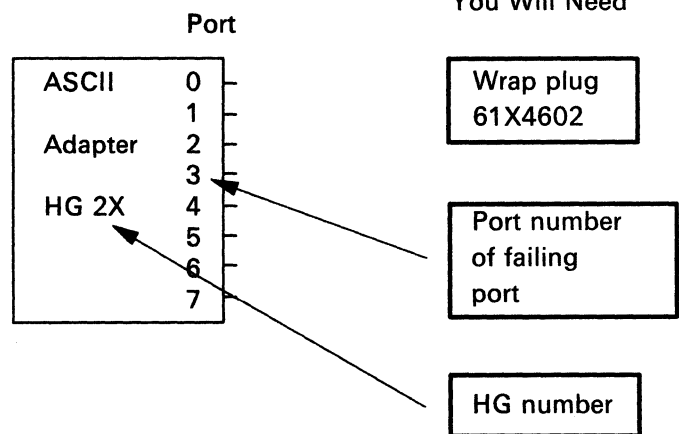

## ASCII Adapter Does Not Respond to Incoming Call

- 2** At the control unit ASCII adapter, disconnect the modem cable on the port you have selected. See Figure 3-9 on page 3-56 to identify port locations.

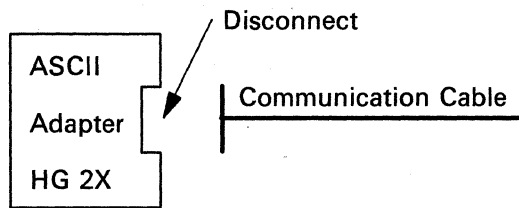

- 3** At the control unit, install the ASCII Adapter Wrap Plug on the port you have selected.

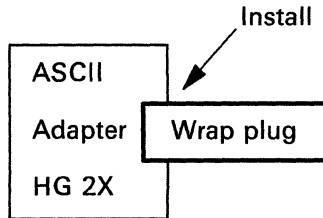

**4** **Run the Port Wrap Test.**

At a working 3270 terminal, sign off your application and enter Online Test mode. Press **Alt** and **Test**.

For an ASCII terminal, sign off your application, request the Connection Menu, and enter Online Test mode. Refer to the *Terminal User's Reference for Expanded Functions* for the correct key sequence, if you are invoking this test from an ASCII terminal.

**Run Port Wrap Test**

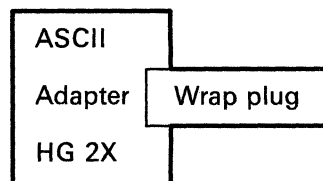

- 5** When the Test Menu is displayed, enter **/12**, Option 1, and press the **Enter** key.

Enter **/12,1** on the Select Line.

- 6** When the Port Test Menu is displayed, enter **2**, the Port Number (PN) you have selected, the Hardware Group (HG = **2X**), and press the **Enter** key.

Enter **2,PN,2X** on the Select Line to invoke the External Port Wrap test, where **2X** = 21, 22, or 23.

- 7** When the **Ready** message is displayed, the test has completed successfully.

Type in some characters. Each character should appear on the screen immediately.

It is as if the characters are bounced off the wrap plug and onto the terminal screen.

If the screen remains blank, the test has failed.

If the characters sent to the screen are incorrect or garbled, it may be due to an error in customization or a terminal problem.

## ASCII Adapter Does Not Respond to Incoming Call

- 8** Was the test successful?
- No** — Request service for the control unit. Ask to have the ASCII adapter replaced.
- Yes** — The ASCII adapter is not the problem. GO TO step 9.

If you have additional local procedures, do them now.

OR

Request help from your technical support group or help desk.

OR

Use the following list as a guide to doing additional problem determination.

Request help from your technical support group or help desk.

End Of Procedure

## 9

The following actions are recommended for suspected problems in the control unit, cabling, connectors, or modem.

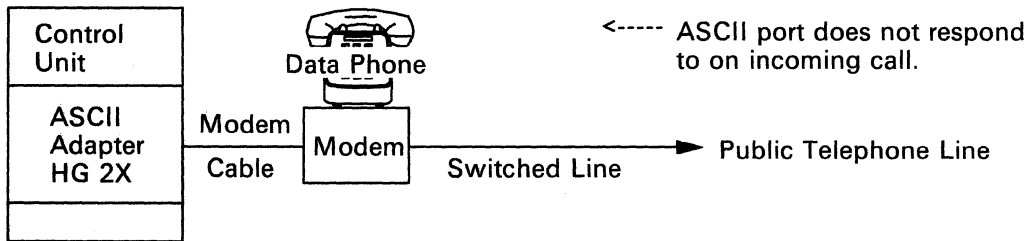

These actions are **ONLY** recommendations and are performed at the control unit ASCII adapter.

### Action

### Comments

- Check that the cables are connected at the control unit adapter and modem.  
Make sure that the connectors are seated and tight.

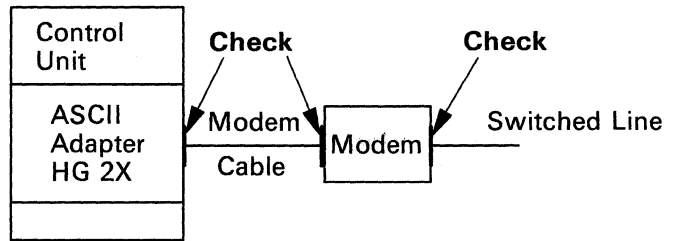

- Check that the modem is turned **ON**

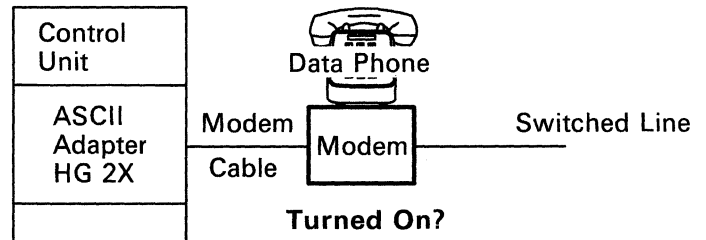

- Check that the phone has a dial tone, indicating that it is connected to the switched network.

# ASCII Adapter Does Not Respond to Incoming Call

Run the modem self-test, if available.  
Use the manufacturer's instructions for running the modem test.

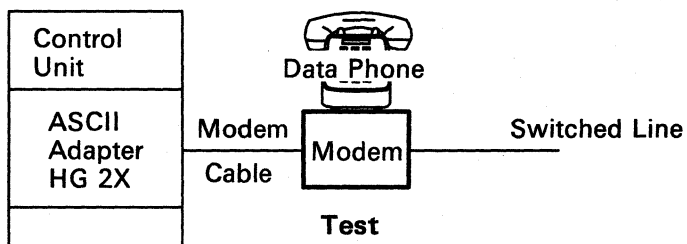

Exchange the cable between the ASCII Adapter port and the modem.  
You must exchange the same type cable.

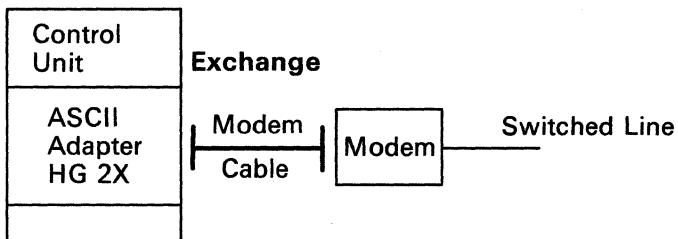

Exchange the modem.  
You may have to change the modem setup to match the suspect modem.

OR

You may have to change the control unit customization parameters for this port number.

You must exchange the same type modem.

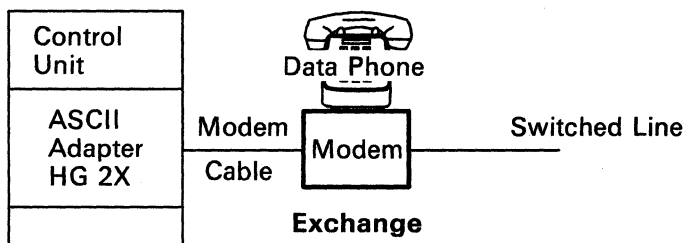

If present, exchange the data phone.  
You must exchange the same type data phone.

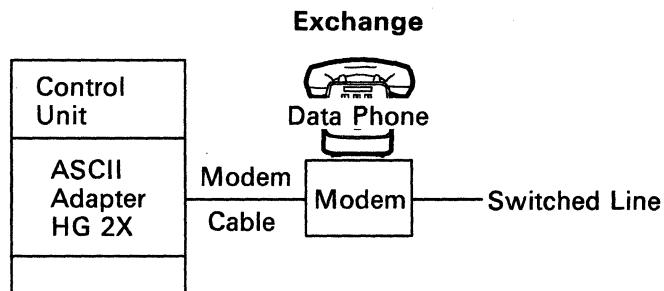

Request help from your technical support group or help desk.

### Procedure M – ASCII Adapter Does Not Respond to Rotary Call

You are here because you are having a problem with the communications path between the control unit ASCII adapter port and the input telephone rotary, and you have no System Status Code in the status display.

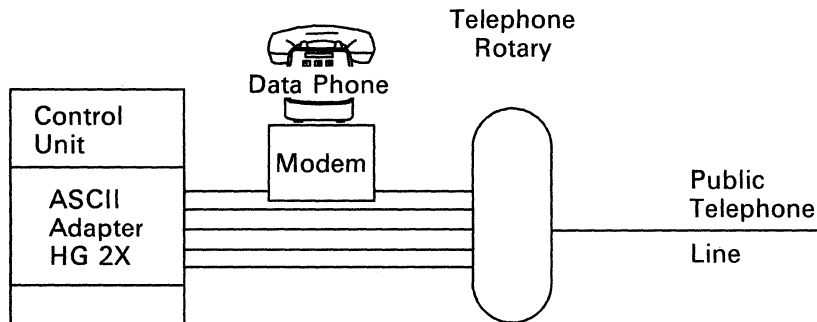

2X = 21, 22, or 23

**Note:** You may need someone at the terminal end to assist in doing this procedure.

Step	Action	Comments
------	--------	----------

**1** To run the online External Port Wrap test you will need the ASCII Adapter Wrap Plug, any Port Number (PN = 0 - 7), and the Hardware Group number 2X (2X = 21, 22, or 23).

Sign off your customer application.

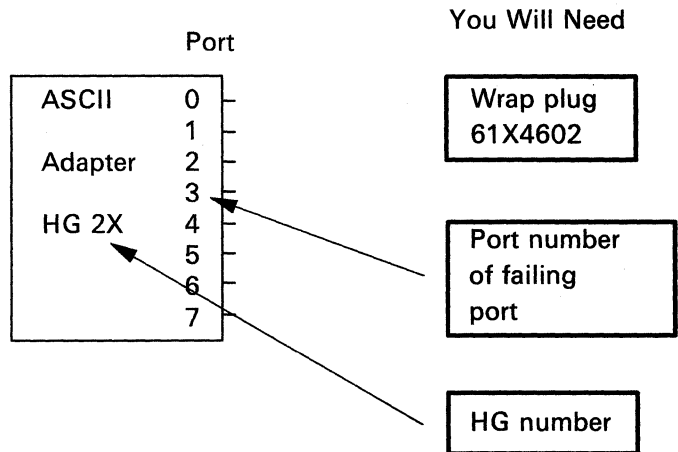

**2** At the control unit ASCII adapter, disconnect the communications cable on the port you have selected. See Figure 3-9 on page 3-56 to identify port locations.

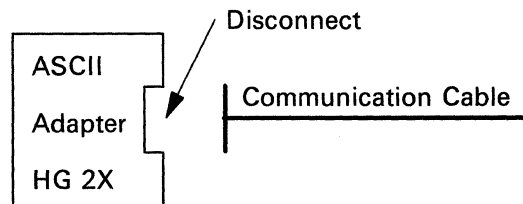



## ASCII Adapter Does Not Respond to Rotary Call

- 3** At the control unit, install the ASCII Adapter Wrap Plug on the port you have selected.

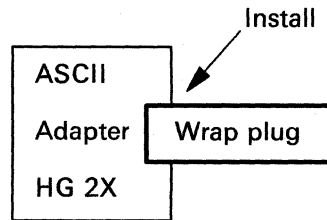

- 4** Run the Port Wrap Test.

At a working 3270 terminal, sign off your application and enter Online Test mode. Press **Alt** and **Test**.

For an ASCII terminal, sign off your application, request the Connection Menu, and enter Online Test mode. Refer to the *Terminal User's Reference for Expanded Functions* for the correct key sequence, if you are invoking this test from an ASCII terminal.

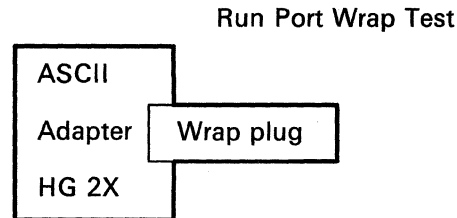

- 5** When the Test Menu is displayed, enter **/12**, Option 1, and press the **Enter** key.

Enter **/12,1** on the Select Line.

- 6** When the Port Test Menu is displayed, enter **2**, the Port Number (PN) you have selected, the Hardware Group (HG = **2X**), and press the **Enter** key.

Enter **2,PN,2X** on the Select Line to invoke the External Port Wrap test, where **2X** = 21, 22, or 23.

- 7** When the **Ready** message is displayed, the test has completed successfully.

Type in some characters. Each character should appear on the screen immediately.

It is as if the characters are bounced off the wrap plug and onto the terminal screen.

If the screen remains blank, the test has failed.

If the characters sent to the screen are incorrect or garbled, it may be due to an error in customization or a terminal problem.

- 8** Was the test successful?

**No** — Request service for the control unit. Ask to have the ASCII adapter replaced.

**Yes** — The ASCII adapter is not the problem. GO TO step 9 on page 3-81.

If you have additional local procedures, do them now.

OR

Request help from your technical support group or help desk.

OR

Use the following list as a guide to doing additional problem determination.

End Of Procedure

9

The following actions are recommended for suspected problems in the terminal, cabling, or connectors.

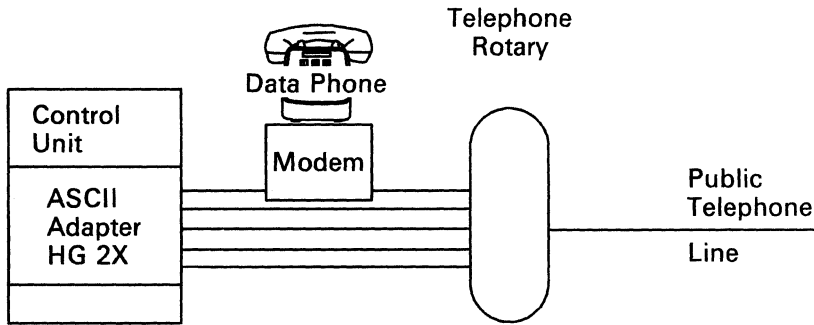

These actions are ONLY recommendations and are performed at the control unit ASCII adapter.

Action	Comments
<p>Check that the cables are connected at the control unit adapter and rotary. Make sure that the connectors are seated and tight.</p>	
<p>Check that the modem is turned ON</p>	
<p>Run the modem self-test, if available. Use the manufacturer's instructions for running the modem test.</p>	

# ASCII Adapter Does Not Respond to Rotary Call

Exchange the cable between the ASCII Adapter port and the modem.

You must exchange the same type cable.

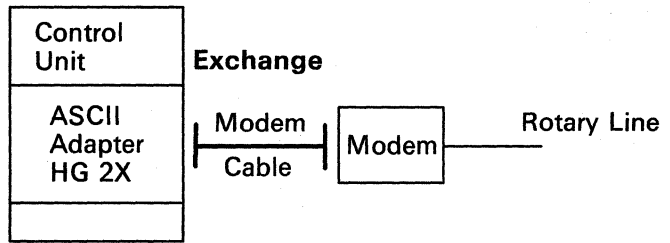

Exchange the modem.

You may have to change the modem setup to match the suspect modem.

OR

You may have to change the control unit customization parameters for this port number.

You must exchange the same type modem.

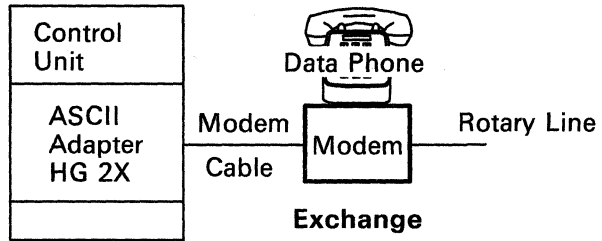

If present, exchange the data phone.

You must exchange the same type data phone.

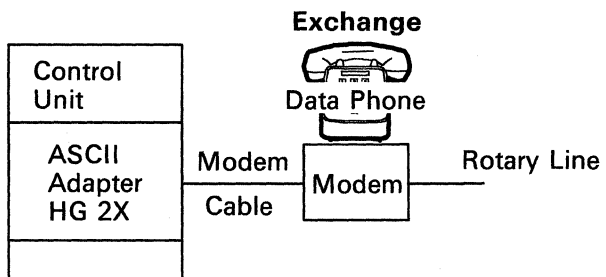

Request help from your technical support group or help desk.

## ASCII Host Connection Problems

You are here because one or more hosts connected to the ASCII Adapter (either directly or through a modem) cannot communicate with the 3174 control unit.

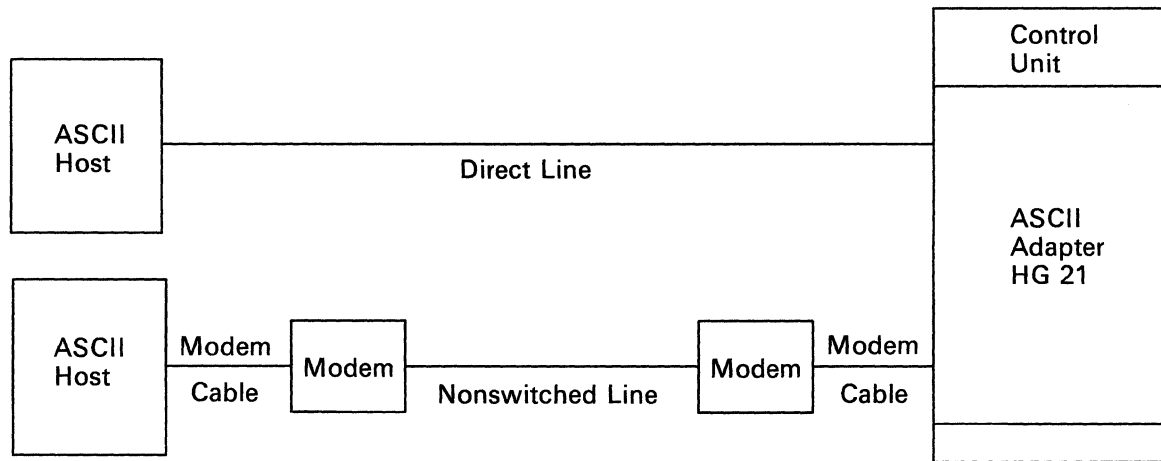

2X = 21, 22, or 23

The bad connection to an ASCII host is indicated by a missing Connection Menu or another customer-assigned message, such as *log on*, *sign on*, or *ready*. **Check your local operating instructions for the correct indication.**

Handling the problem involves three steps:

- **Collect information about the problem** (see “Collecting Information about the Problem”).
- **Select the symptom and action** (see “Selecting an ASCII Host System Symptom” on page 3-90).
- Do the appropriate problem determination procedure described in the **Action** selected.

This section also contains information on terminal connectors and terminal addresses.

### Collecting Information about the Problem

To complete the procedures in this section, you first need to:

1. Identify the failing host and its associated control unit
2. Obtain the host-to-3174 physical-connection information
3. Determine how the host is connected to the 3174
4. Determine the operating status of other connected devices, using a cabling worksheet like the one shown in Figure 3-10.

## Asynchronous Emulation Adapter 1 Port Range 21 – 00 to 21 – 07

Complete this worksheet during site planning. Use this worksheet during cable installation and terminal connection problem determination. Store this worksheet with the 3174 control unit documentation for future reference. When cabling changes are made, correct this record to reflect such changes.

3174 Model \_\_\_\_\_ 3174 Location \_\_\_\_\_ 3174 ID \_\_\_\_\_

### AEA Port Range 21-00 to 21-03

AEA 1 Connector	0	1	2	3
Cable ID				
Terminal or Host Type				
Location				
Modem Type				
Dial In Number				
Dial Out Number				
AEA Port Number	21-00	21-01	21-02	21-03

### AEA Port Range 21-04 to 21-07

AEA 1 Connector	4	5	6	7
Cable ID				
Terminal or Host Type				
Location				
Modem Type				
Dial In Number				
Dial Out Number				
AEA Port Number	21-04	21-05	21-06	21-07

Figure 3-10 (Part 1 of 2). Sample Cabling Worksheet (ASCII Host System)

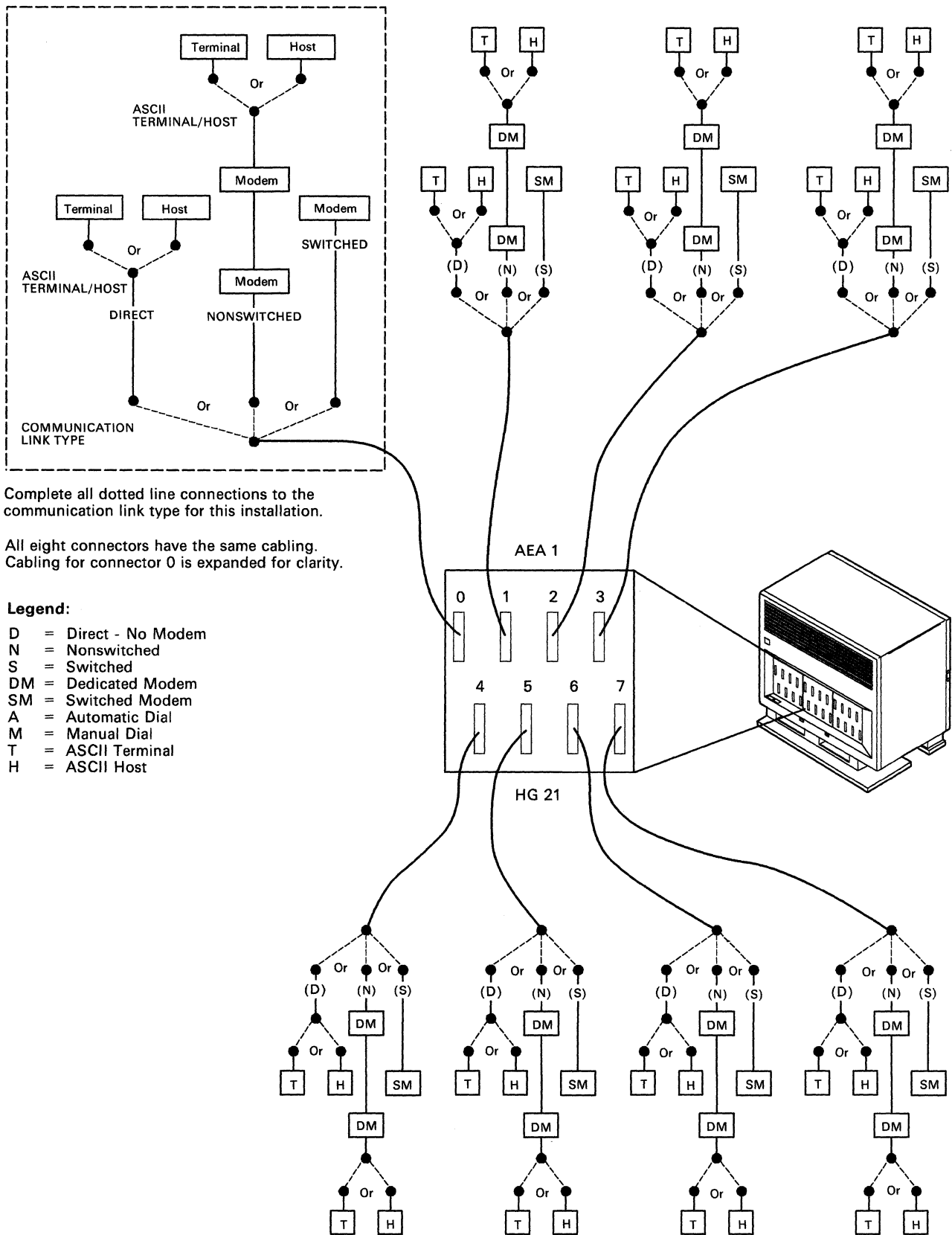

Figure 3-10 (Part 2 of 2). Sample Cabling Worksheet (ASCII Host System)

## ASCII Host Connection Problems

To collect information about the problem, do the following procedures.

### 1 – Identify the Failing Host and Its Control Unit

Use your local resources to identify the control unit and its failing host(s). The control unit and its terminals may be identified in one of the following ways:

- A label on the host containing the control unit address, the host port number, or the host identifier (ID)
- A location for the host, for example, *the New York Tribune News Service*
- A person's name and phone number, for example, *Red Linehan's terminal at extension 9876*
- A cable or wall socket identifier.

### 2 – Obtain Physical-Connection Information

Physical-connection information is usually stored at the control unit or at some central location. Get the installation cabling worksheets (see Figure 3-10 for a sample), or whatever other subsystem documentation is available to identify the connection path between the failing host and its control unit. The information should include cable IDs, port numbers, device locations, and the failing host.

You may have a subsystem connection diagram that shows all units attached to the control unit (see Figure 3-11 on page 3-87).

### 3 – Determine How the Host Is Connected to the 3174

Using the cabling worksheets or the subsystem connection diagram, determine how a host is connected to the control unit.

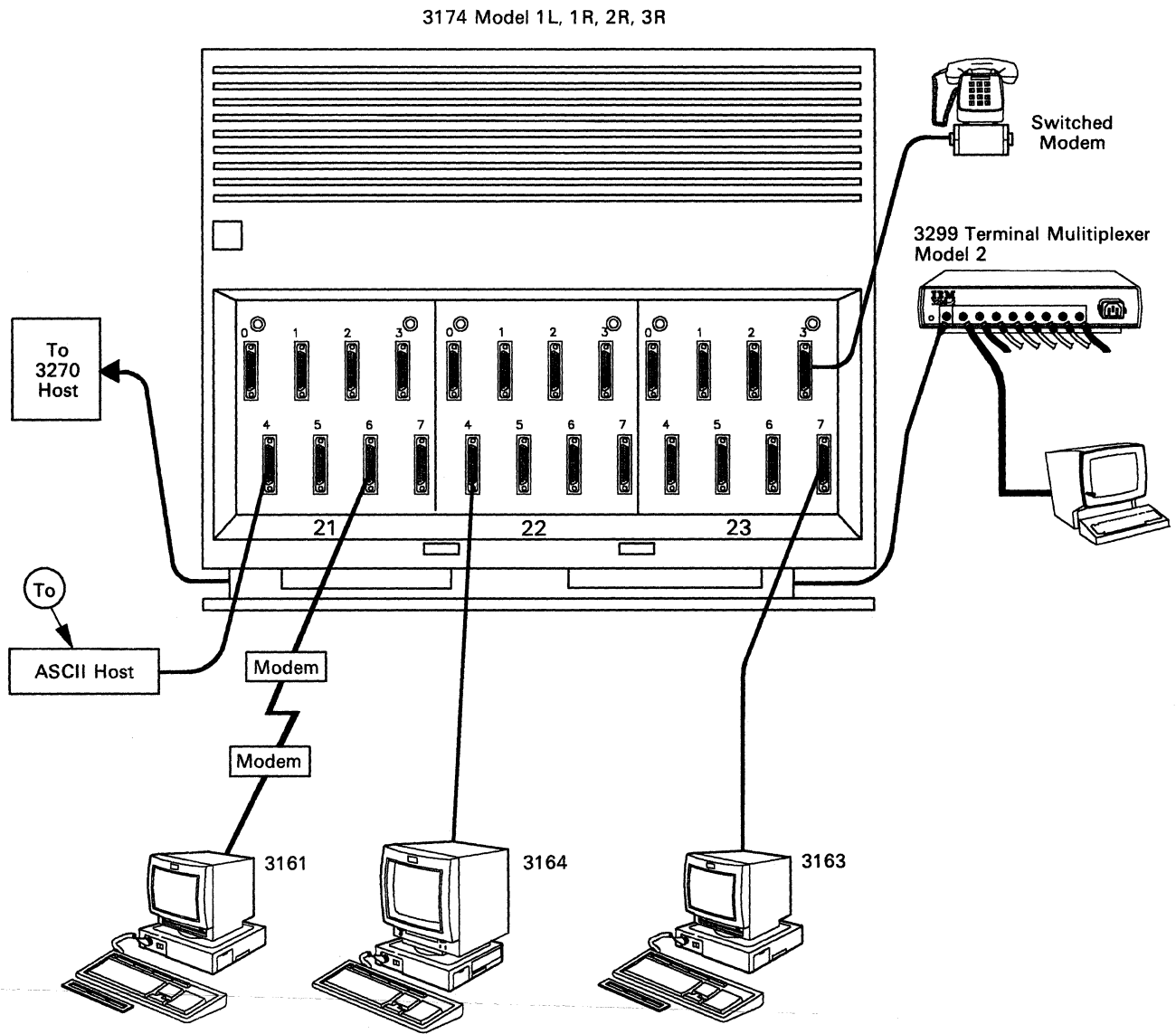

**Note:** This figure shows an overview of a 3174 with three Asynchronous Emulation Adapter features. The terminals can be any of the ASCII terminals.

Figure 3-11. Sample Physical Connection Diagram (ASCII Host System)

**ASCII Host Communication Links:** There are four types of communication links between the control unit ASCII adapter and the ASCII host:

- Direct Line
- Nonswitched Line
- Switched Line
- Telephone Rotary



## ASCII Host Connection Problems

**Direct Line:** This connection is a direct-wire communication link that does not include modems (see Appendix B for details on ASCII adapter connectors).

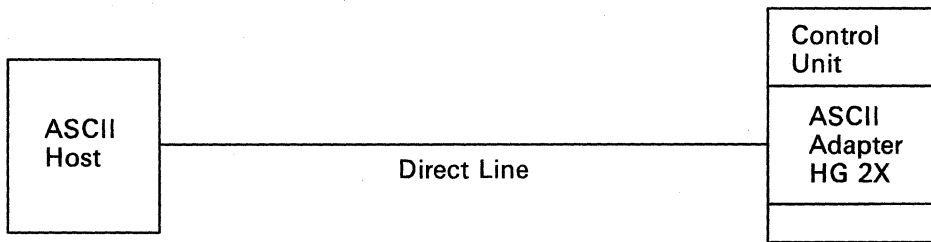

**Nonswitched Line:** This connection is a direct-line communication link between two modems, one of which is connected to the ASCII adapter and the other to the ASCII host (see Appendix B for details on modems and ASCII adapter connectors).

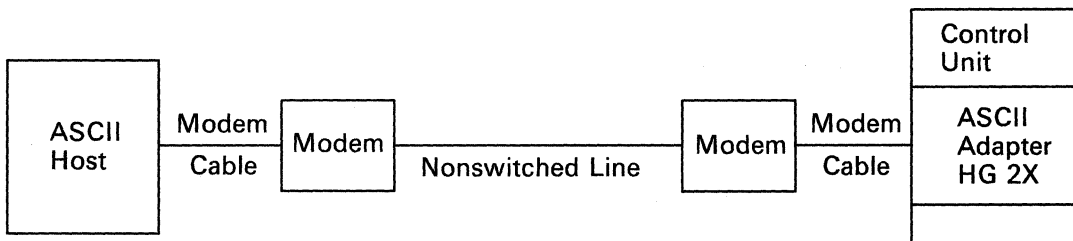

**Switched Line:** This connection is a communication link between two modems that is established by manually or automatically dialing out on a public telephone line (see Appendix B for details on modems and ASCII adapter connectors).

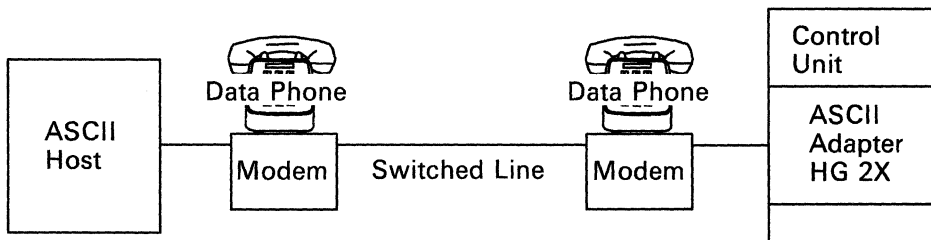

**Telephone Rotary:** This equipment allows access to more than one port of the ASCII adapter with the use of one phone number (see Appendix B for details on modems, rotaries, and ASCII adapter connectors).

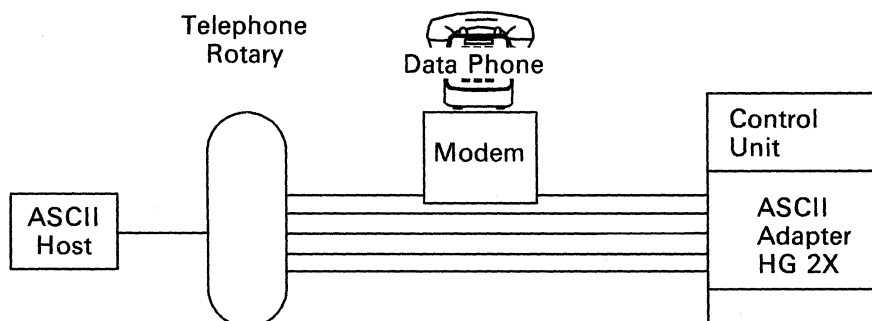

**4 – Determine the Status of Other Connected Hosts**

Determine the extent of the problem by asking other terminal users whether they are having trouble connecting to the same host site.

- Are all host systems connected to the ASCII adapter failing?
- Have other terminal users identified connection problems when trying to connect the ASCII adapter to other host sites?

**Note:** Use /12, Option 2 **ASCII Status Summary** test to determine the status of other terminals connected to this adapter.

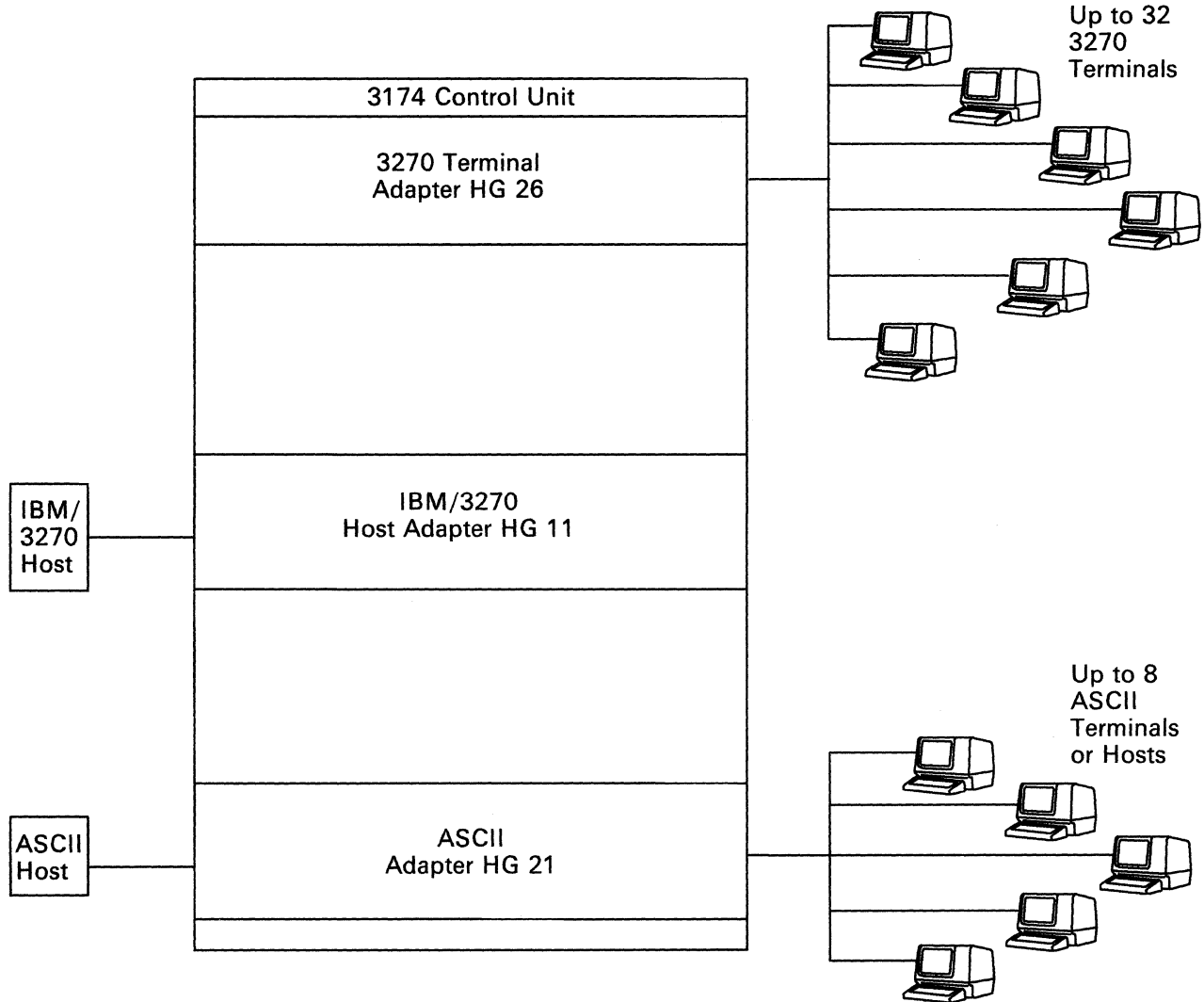

2X = 21, 22, or 23

The answers to questions like these will help you to identify which symptom in Figure 3-12 on page 3-90 applies to your situation.

### Selecting an ASCII Host System Symptom

Once you have collected all the necessary ASCII connection and status information, read down the list of symptoms, and choose the one that best describes the ASCII problem you are having. Then go to the procedure listed.

	Symptom	Action
<b>1</b>	All host systems connected to this 3174 ASCII adapter are failing.	Go to "Procedure N – All Host Connections to ASCII Adapter Are Failing" on page 3-91.
<b>2</b>	One host, <b>directly</b> connected (no modem) to this 3174 ASCII adapter, is failing.	Go to "Procedure O – One Direct ASCII Host Is Failing" on page 3-93.
<b>3</b>	One host, connected to a <b>non-switched</b> communication link, is failing.	Go to "Procedure P – One Nonswitched ASCII Host Is Failing" on page 3-97.
<b>4</b>	One host, connected to a <b>switched</b> communication link, is failing.	Go to "Procedure Q – One Switched ASCII Host Is Failing" on page 3-102.
<b>5</b>	One or more (but not all) terminals connected to this 3174 ASCII adapter are failing.	Go to the appropriate procedure above: Direct, Non-switched, or Switched. Handle the problem as if only one terminal were failing.

Figure 3-12. ASCII Host Connection Problems

## Procedure N – All Host Connections to ASCII Adapter Are Failing

You are here because all the communication paths (ports) between the ASCII host and the ASCII adapter are failing, and either a status code referred you to this procedure or you have no system status code in the status display.

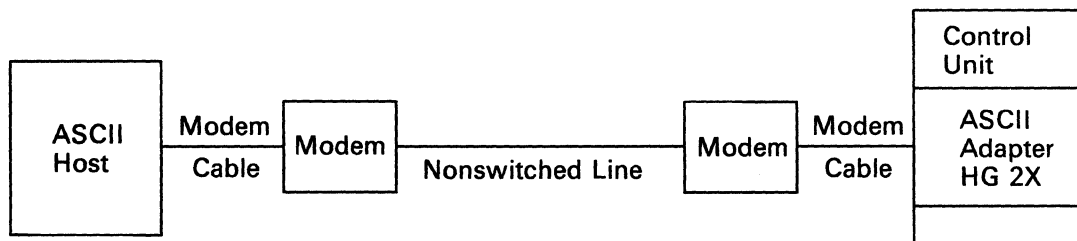

2X = 21, 22, or 23

Step	Action	Comments
------	--------	----------

- To run the online External Port Wrap Test, you will need the ASCII Adapter Wrap Plug, any Port Number (PN = 0 - 7), and the Hardware Group number 2X (2X = 21, 22, or 23).

Sign off your customer application.

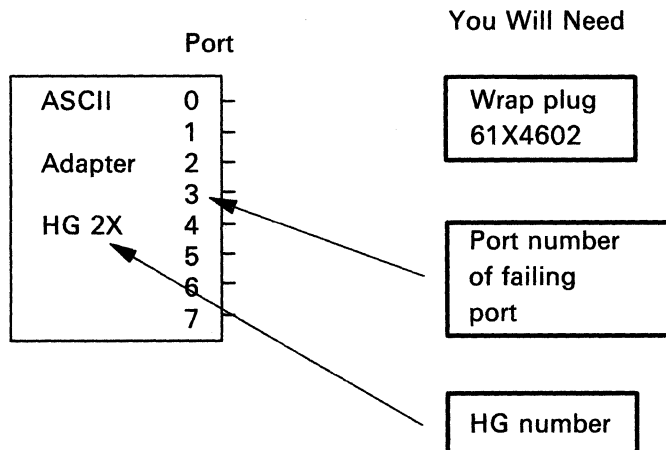

- At the control unit ASCII adapter, disconnect the communication cable on the port you have selected. See Figure 3-11 on page 3-87 to identify port locations.

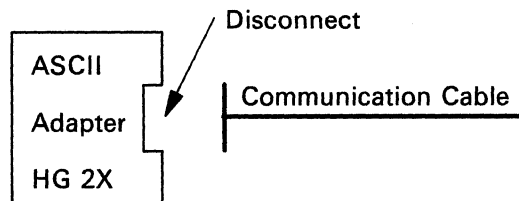

## All Host Connections to ASCII Adapter Are Failing

- 3** At the control unit, install the ASCII Adapter Wrap Plug on the port you have selected.

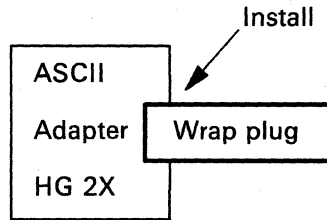

- 4** Run the Port Wrap Test.

At a working 3270 terminal, sign off your application and enter Online Test mode. Press **Alt** and **Test**.

For an ASCII terminal, sign off your application, request the Connection Menu, and enter Online Test mode. Refer to the *Terminal User's Reference for Expanded Functions* for the correct key sequence, if you are invoking this test from an ASCII terminal.

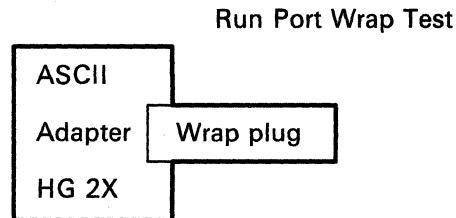

- 5** On the blank screen, enter **/12**, Option 1, and press the **Enter** key.

Enter **/12,1** on the Select Line.

- 6** When the Port Test Menu is displayed, enter **2**, the Port Number (PN) you have selected, and the Hardware Group (HG = 2X), and press the **Enter** key.

Enter **2,PN,2X** on the Select Line to invoke the External Port Wrap Test, where 2X = 21, 22, or 23.

- 7** When the **Ready** message is displayed, the first part of the test has been completed successfully.

If the screen remains blank, the test has failed.

Type in some characters to initiate the last part of the test. Each character should appear on the screen immediately.

If the characters sent to the screen are incorrect or garbled, it may be due to an error in customization or a terminal problem.

It is as if the characters are bounced off the wrap plug and onto the terminal screen.

- 8** Was the test successful?

**No** — Request service for the control unit. Ask to have the ASCII adapter replaced.

Store the ASCII Adapter Wrap Plug.

**Yes** — All ports on the ASCII adapter are not failing. GO TO "Selecting an ASCII Host System Symptom" on page 3-90.

End of Procedure

### Procedure O – One Direct ASCII Host Is Failing

You are here because you are having a problem with the direct (no modems) cable path between the control unit and an ASCII host, and either a status code referred you to this procedure or you have no system status code in the status display.

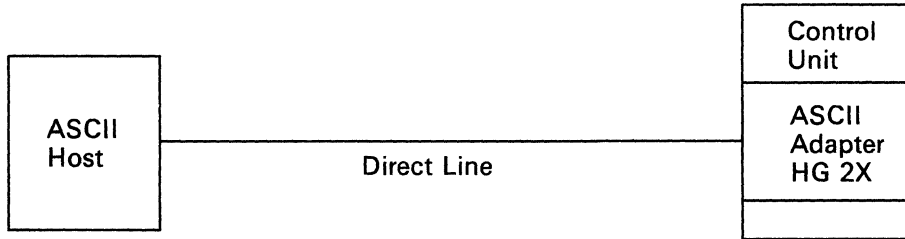

2X = 21, 22, or 23

This procedure will determine whether the ASCII host can communicate with the control unit.

**Note:** You may need someone at the host end to assist in this procedure.

Step	Action	Comments
------	--------	----------

<b>1</b>	<p>Verify that the host is operating. Call the host system operator to make sure that the host system is operational.</p>	<p>Check your local procedures for contacting the ASCII host.</p>
----------	---	---

**2** To run the online External Port Wrap Test, you will need the ASCII Adapter Wrap Plug, any Port Number (PN = 0 - 7), and the Hardware Group number 2X (2X = 21, 22, or 23).

Sign off your customer application.

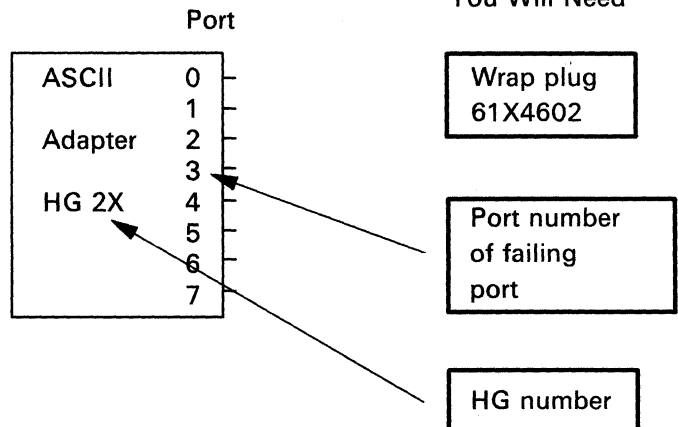

## One Direct ASCII Host Connection Is Failing

- 3** At the control unit ASCII adapter, disconnect the communication cable on the failing port. See Figure 3-11 on page 3-87 to identify port locations.

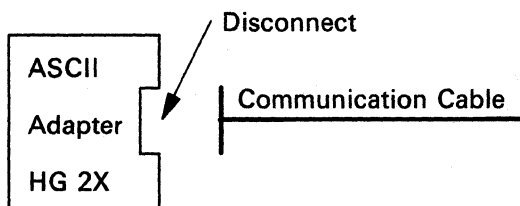

- 4** At the control unit, install the ASCII Adapter Wrap Plug on the failing port.

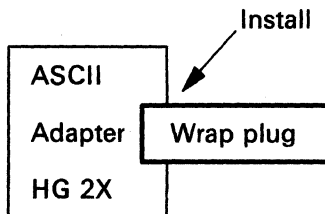

- 5** Run the Port Wrap Test.

At a working 3270 terminal, sign off your application and enter Online Test mode. Press **Alt** and **Test**.

For an ASCII terminal, sign off your application, request the Connection Menu, and enter Online Test mode. Refer to the *Terminal User's Reference for Expanded Functions* for the correct key sequence, if you are invoking this test from an ASCII terminal.

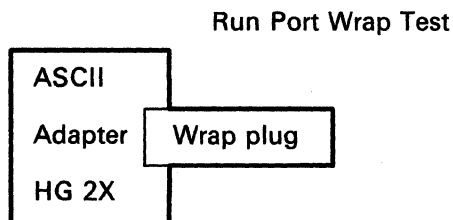

- 6** On the Select Line, enter **/12**, Option 1, and press the **Enter** key.

Enter **/12,1** on the Select Line.

- 7** When the Port Test Menu is displayed, enter **2**, the Port Number (PN) you have selected, and the Hardware Group (HG = 2X), and press the **Enter** key.

Enter **2,PN,2X** on the Select Line to invoke the External Port Wrap Test, where 2X = 21, 22, or 23.

- 8** When the **Ready** message is displayed, the test has been completed successfully.

Type in some characters. Each character should appear on the screen immediately.

It is as if the characters are bounced off the wrap plug and onto the terminal screen.

If the screen remains blank, the test has failed.

If the characters sent to the screen are incorrect or garbled, it may be due to an error in customization or a terminal problem.

- 9** Was the test successful?
- No** — Request service for the control unit. Ask to have the ASCII adapter replaced.
- Yes** — The ASCII adapter is not the problem.
- GO TO step 10.

If you have additional local procedures, do them now.

OR

Request help from your technical support group or help desk.

OR

Use the following list as a guide to doing additional problem determination.

---

End Of Procedure

---

## 10

The following actions are recommended for suspected problems in the host, cabling, or connectors.

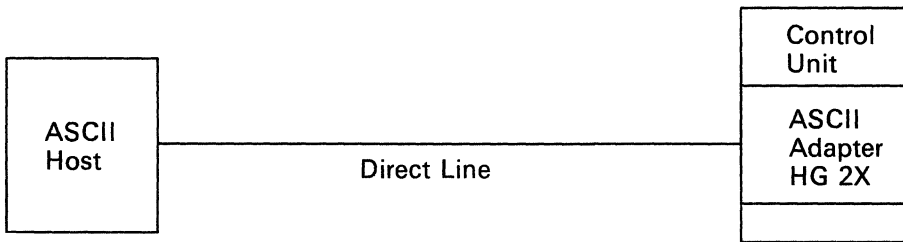

These actions are ONLY recommendations. If you have local procedures for doing problem determination, use those instructions first.

---

### Action

### Comments

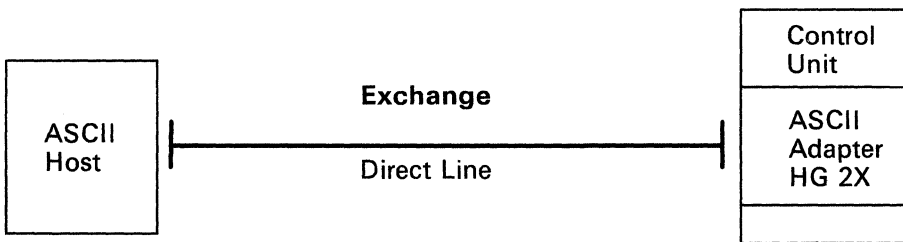

Check that the cable is connected at both the control unit and the host.

Make sure that the connectors are seated and tight.

Check the cable for breaks along its entire length.

The cable may not be accessible along its entire length.

---



## One Direct ASCII Host Connection Is Failing

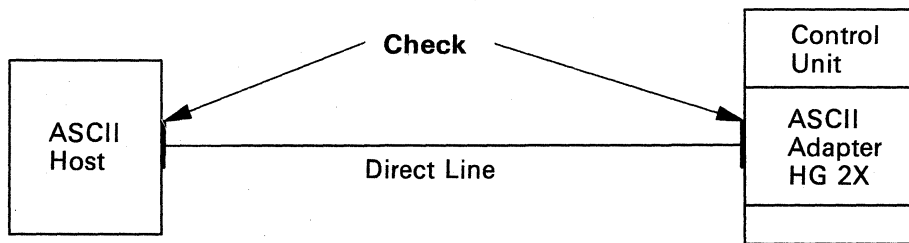

Exchange the cable.

The cable may be difficult to handle because of its length or weight.

The connectors on both ends of the cable must be the same as those on the suspect cable.

---

Request help from your technical support group or help desk.

**Procedure P – One Nonswitched ASCII Host Is Failing**

You are here because you are having a problem with the nonswitched communication path between the control unit and an ASCII host, and either a status code referred you to this procedure or you have no system status code in the status display.

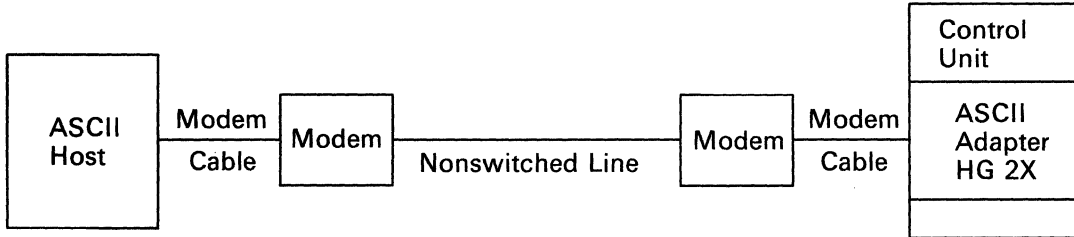

2X = 21, 22, or 23

This procedure will determine whether the ASCII host can communicate with the control unit.

**Note:** You may need someone at the host end to assist in this procedure.

Step	Action	Comments
------	--------	----------

**1** To run the online External Port Wrap Test, you will need the ASCII Adapter Wrap Plug, any Port Number (PN = 0 - 7), and the Hardware Group number 2X (2X = 21, 22, or 23).

Sign off your customer application.

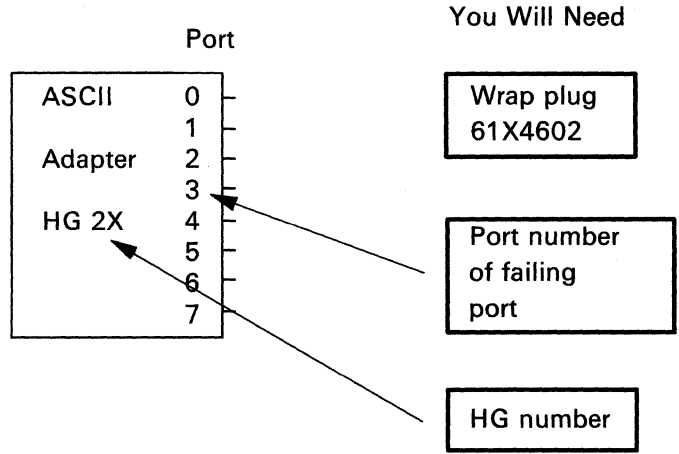

**2** At the control unit ASCII adapter, disconnect the communication cable on the failing port. See Figure 3-11 on page 3-87 to identify port locations.

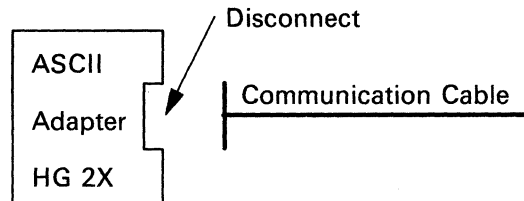

## One Nonswitched ASCII Host Connection Is Failing

- 3** At the control unit, install the ASCII Adapter Wrap Plug on the failing port.

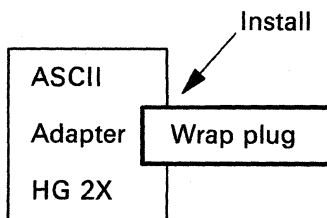

- 4** At a working 3270 terminal, sign off your application and enter Online Test mode. Press **Alt** and **Test**.

For an ASCII terminal, sign off your application, request the Connection Menu, and enter Online Test mode. Refer to the *Terminal User's Reference for Expanded Functions* for the correct key sequence, if you are invoking this test from an ASCII terminal.

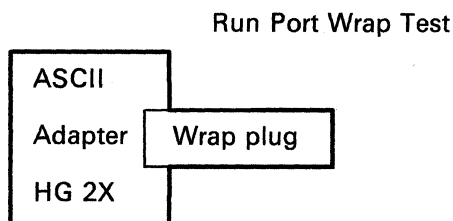

- 5** On the Select Line, enter **/12**, Option 1, and press the **Enter** key.

Enter **/12,1** on the Select Line.

- 6** When the Port Test Menu is displayed, enter **2**, the Port Number (PN) you have selected, and the Hardware Group (HG = 2X), and press the **Enter** key.

Enter **2,PN,2X** on the Select Line to invoke the External Port Wrap Test, where 2X = 21, 22, or 23.

- 7** When the **Ready** message is displayed, the first part of the test has been completed successfully.

Type in some characters to begin the last part of the test. Each character should appear on the screen immediately.

It is as if the characters are bounced off the wrap plug and onto the terminal screen.

If the screen remains blank, the test has failed.

If the characters sent to the screen are incorrect or garbled, it may be due to an error in customization or a terminal problem.

- 8** Was the test successful?
- No** — Request service for the control unit. Ask to have the ASCII adapter replaced.
- Yes** — The ASCII adapter is not the problem. GO TO step 9 on page 3-99.

If you have additional local procedures, do them now.

OR

Request help from your technical support group or help desk.

OR

Use the following list as a guide to doing additional problem determination.

End of Procedure

9

The following actions are recommended for suspected problems in the terminal, cabling, or connectors.

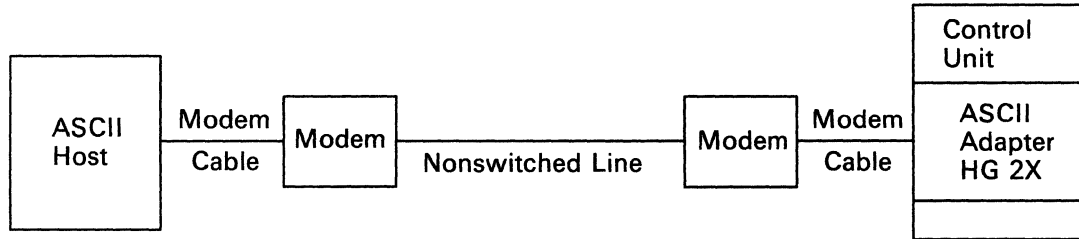

These actions are ONLY recommendations. If you have local procedures for doing problem determination, use those instructions first.

---

Action	Comments
--------	----------

---

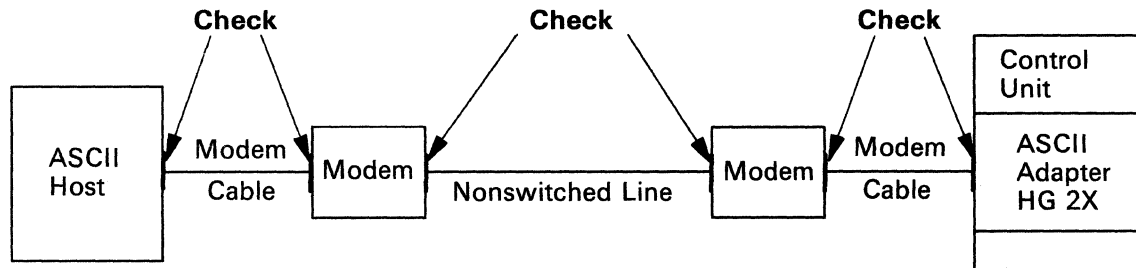

Check that the cables are connected at the control unit adapter, modems, and host.

Make sure that the connectors are seated and tight.

---

# One Nonswitched ASCII Host Connection Is Failing

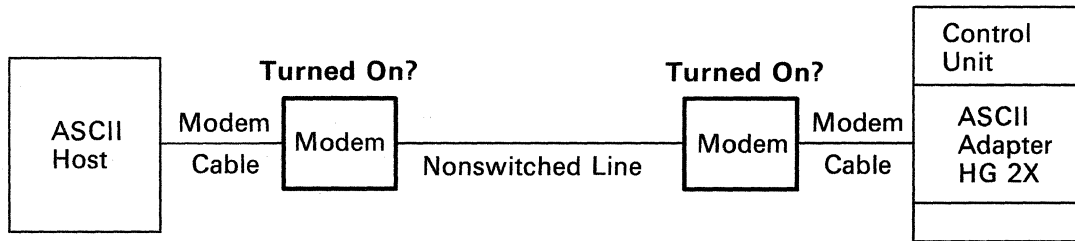

Check that the modems are turned **on**.

---

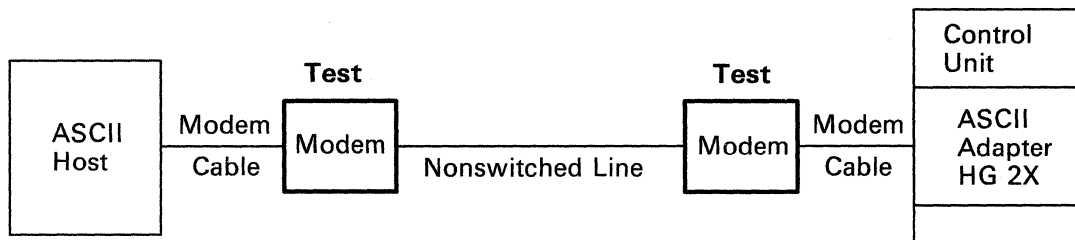

Run the modem test, if available.

Use the manufacturer's instructions for running the modem test.

---

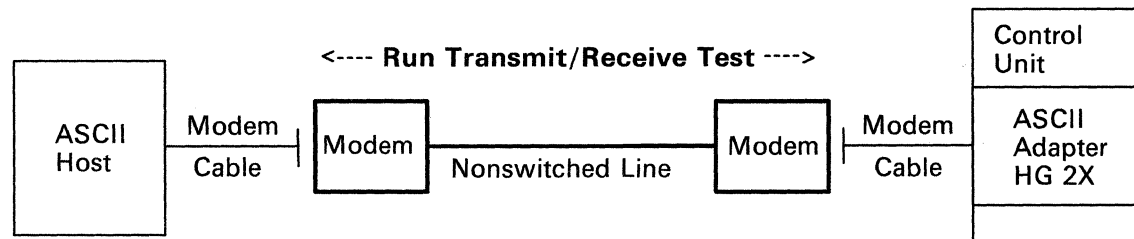

Run the modem transmit/receive test, if available.

The modem may not have a transmit/receive test.

---

## One Nonswitched ASCII Host Connection Is Failing

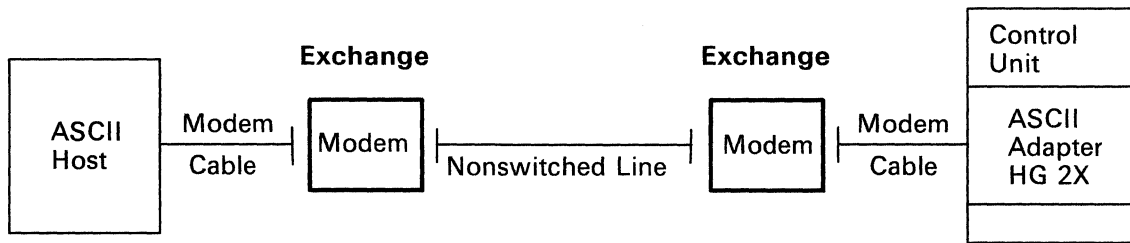

Exchange the modems, one at a time.

You must exchange the same type modem.

You may have to change the modem setup to match the suspect modem.

OR

You may have to change the control unit customization parameters for this port number.

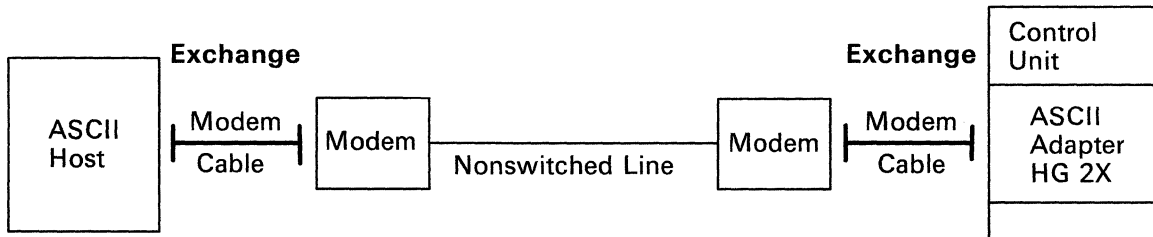

Exchange the cables between modem and host and between modem and adapter.

Request help from your technical support group or help desk.

## One Switched ASCII Host Connection Is Failing

### Procedure Q – One Switched ASCII Host Is Failing

You are here because you are having a problem with the switched communication path between the control unit ASCII adapter and the ASCII host, and either a status code referred you to this procedure or you have no system status code in the status display.

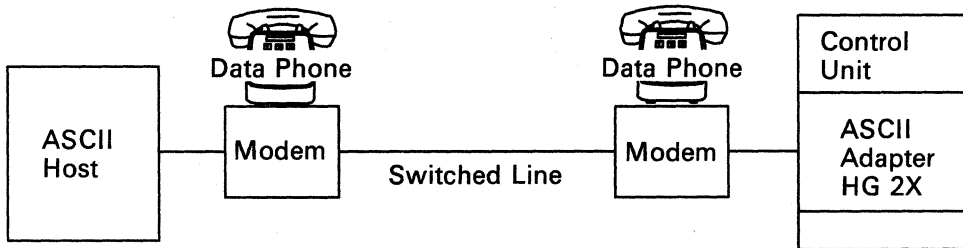

2X = 21, 22, or 23

This procedure will determine whether the ASCII host can communicate with the control unit.

<---- Call to ASCII Host from ASCII adapter port fails.

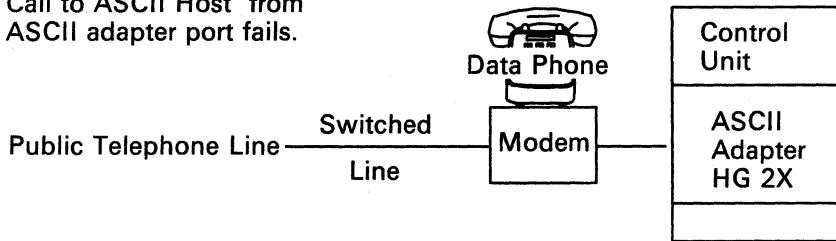

Step	Action	Comments
1	<p>Are other ASCII terminal users having a problem calling this ASCII host (phone number) from the 3174?</p> <p>No — GO TO step 2 on page 3-103.</p> <p>Yes — GO TO step 10 on page 3-104.</p>	<p>You may have a configuration problem, or you are entering an incorrect phone number.</p> <p>Request help from your technical support group or help desk.</p>

- 2** To run the online External Port Wrap Test, you will need the ASCII Adapter Wrap Plug, any Port Number (PN = 0 - 7), and the Hardware Group number 2X (2X = 21, 22, or 23).

Sign off your customer application.

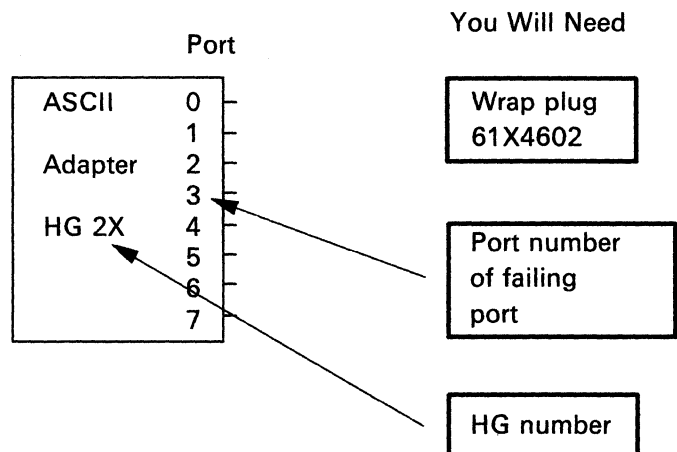

- 3** At the control unit ASCII adapter, disconnect the communication cable on the failing port. See Figure 3-11 on page 3-87 to identify port locations.

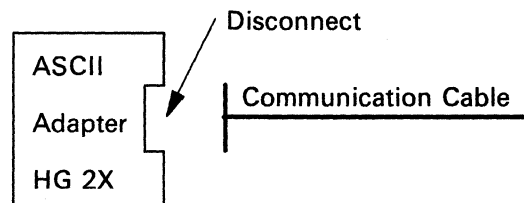

- 4** At the control unit, install the ASCII Adapter Wrap Plug on the failing port.

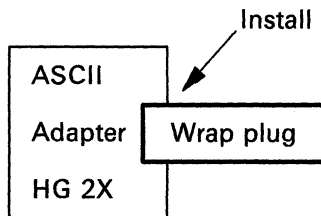

- 5** Run the Port Wrap Test.

At a working 3270 terminal, sign off your application and enter Online Test mode. Press **Alt** and **Test**.

For an ASCII terminal, sign off your application, request the Connection Menu, and enter Online Test mode. Refer to the *Terminal User's Reference for Expanded Functions* for the correct key sequence, if you are invoking this test from an ASCII terminal.

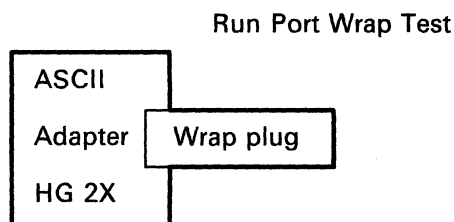

- 6** On the Select Line, enter /12, Option 1, and press the **Enter** key.

Enter /12,1 on the Select Line.



## One Switched ASCII Host Connection Is Failing

**7** When the Port Test Menu is displayed, enter **2**, the Port Number (PN) you have selected, and the Hardware Group (HG = 2X), and press the **Enter** key.

Enter **2,PN,2X** on the Select Line to invoke the External Port Wrap Test, where 2X = 21, 22, or 23.

**8** When the **Ready** message is displayed, the first part of the test has been completed successfully.

If the screen remains blank, the test has failed.

Type in some characters to begin the last part of the test. Each character should appear on the screen immediately.

If the characters sent to the screen are incorrect or garbled, it may be due to an error in customization or a terminal problem.

It is as if the characters are bounced off the wrap plug and onto the terminal screen.

**9** Was the test successful?

If you have additional local procedures, do them now.

**No** — Request service for the control unit. Ask to have the ASCII adapter replaced.

OR

Request help from your technical support group or help desk.

**Yes** — The ASCII adapter is not the problem. GO TO step 10.

OR

Use the following list as a guide to doing additional problem determination.

End of Procedure

## 10

The following actions are recommended for suspected problems in the terminal, cabling, or connectors.

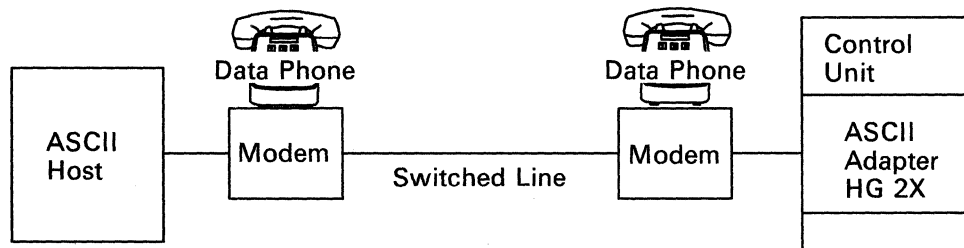

These actions are **ONLY** recommendations and are performed at the terminal.

# One Switched ASCII Host Connection Is Failing

Check for the dial tone at both connections, indicating that both are connected to the switched network.

Action	Comments
--------	----------

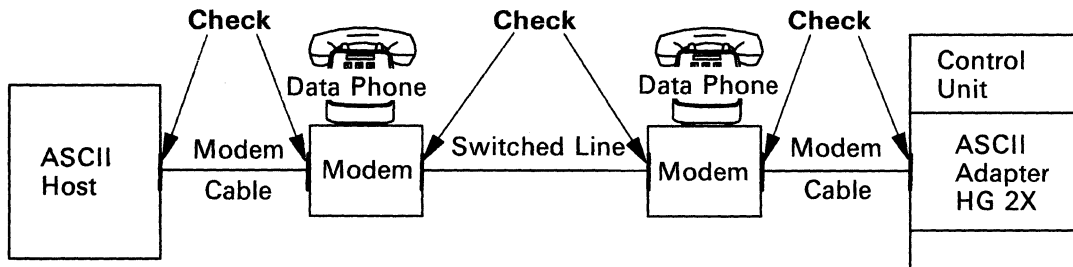

Check that the cables are connected at the control unit adapter, modems, and host.

Make sure that the connectors are seated and tight.

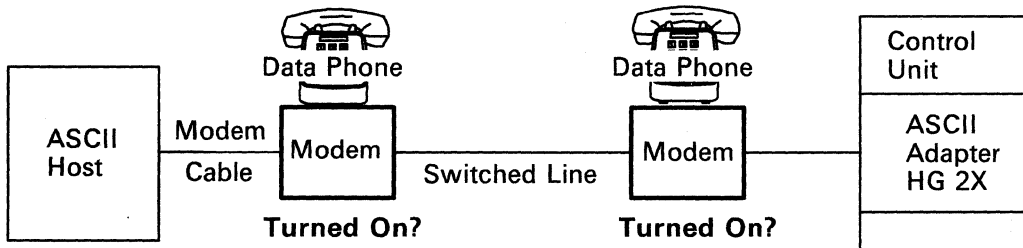

Check that the modems are turned on.

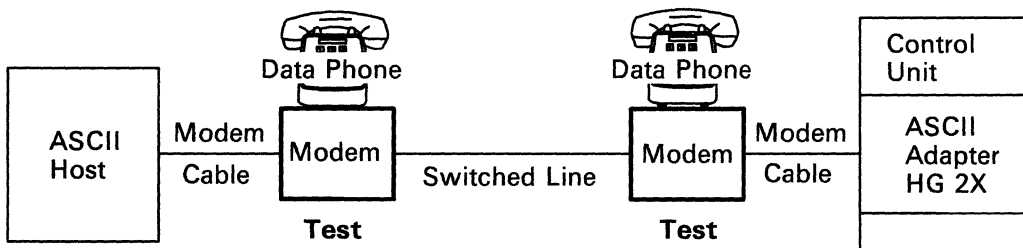

Run the modem self-test, if available.

Use the manufacturer's instructions for running the modem test.

## One Switched ASCII Host Connection Is Failing

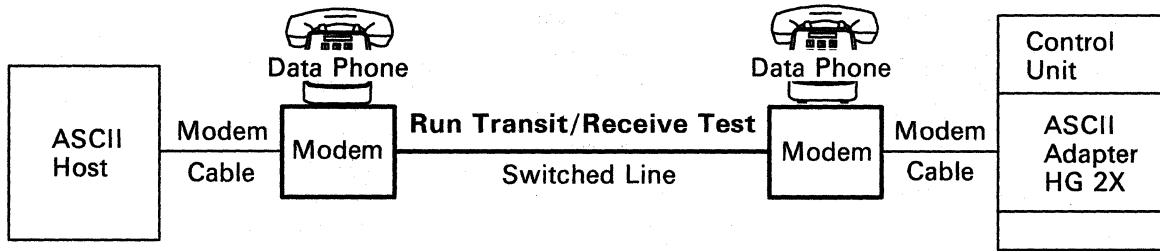

Run the modem transmit/receive test, if available.

The modem may not have a transmit/receive test.

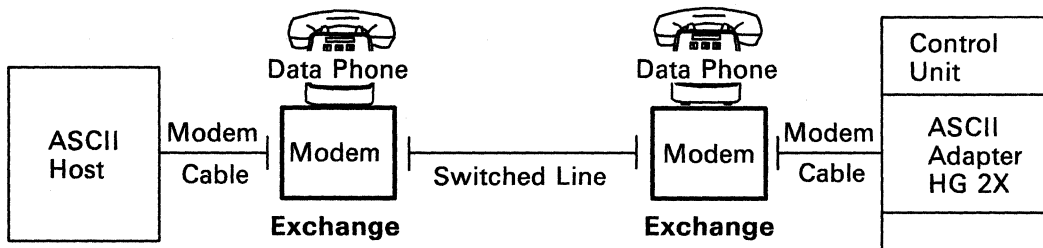

Exchange the modems.

You must exchange the same type modem.

You may have to change the modem setup to match the suspect modem.

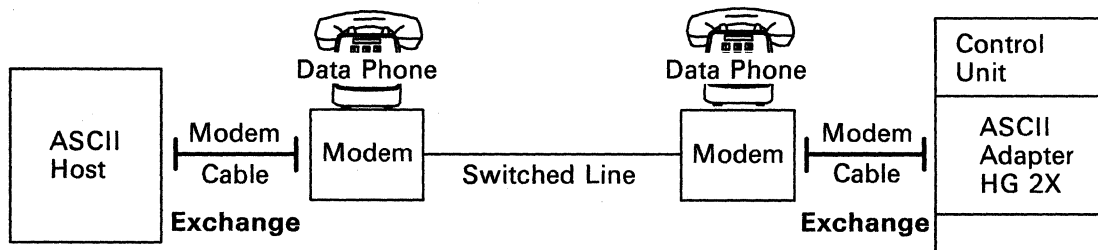

Exchange the modem cables.

You must exchange the same modem cable.

The corresponding connectors on each end of the cables must be the same.

## One Switched ASCII Host Connection Is Failing

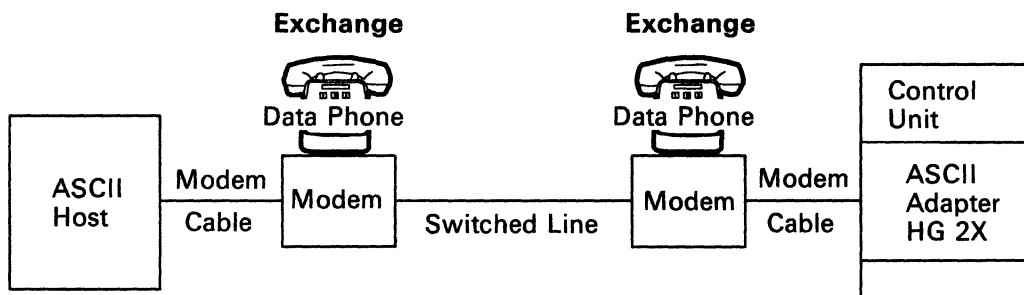

If present, exchange the data phone.

You must exchange the same type data phone.

---

Request help from your technical support group or help desk.

---

## Offline Tests

This section tells you how to do a general control unit test (Alt 2 IML), and how to do specific tests (using Alt 1 IML) on the communication adapter and cable and on the Token-Ring Adapter and cable. The *3174 Customer Extended Problem Determination* contains more information on offline testing procedures.

### Test Operations

The Alt 2 IML test stops when it finds an error. To continue testing other areas of the control unit, use the operator keypad to key in **1**, and then press **Enter**. This is called the *Continue* function.

If while running offline tests you decide to stop testing, or to select another operation after an error, or to recover from a keystroke mistake, press **Enter**. This is called the *Free* function. The Free function resets the function in progress; the **4001** prompt appears in the **Status** display, indicating that the control unit is ready for a new request.

### Alt 2 IML Tests

**Warning:** An IML disrupts all control unit operations.

Notify users if necessary.

- 1 Ask the host operator to take the control unit offline.  
Insert a Utility diskette into diskette drive 1.  
If there are two diskette drives, ensure that a Downstream Load (DSL) or Control diskette is installed in diskette drive 2.  
**For Models 1R, 2R, and 3R, go to step 3 on page 3-109.**

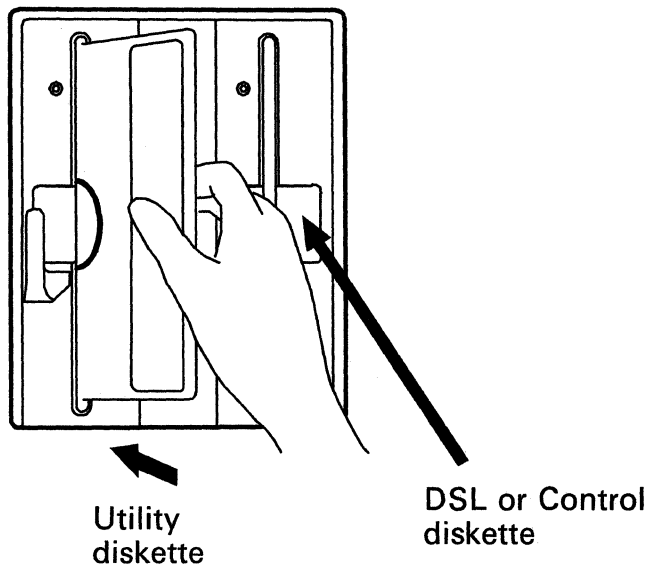

- 2** Set the **Channel Interface** switch to **Offline**, and wait for the offline indicator to light.

**Channel Interface**

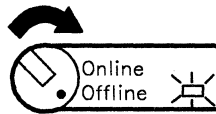

- 3** Press and hold down **Alt 2** while you press and release **IML**. Then release **Alt 2**.

Tests run, and progress numbers appear in the **Status** display of the operator panel. The tests run about 4 minutes. If the tests are completed successfully, **2082** appears in the **Status** display.

**Operator Panel**

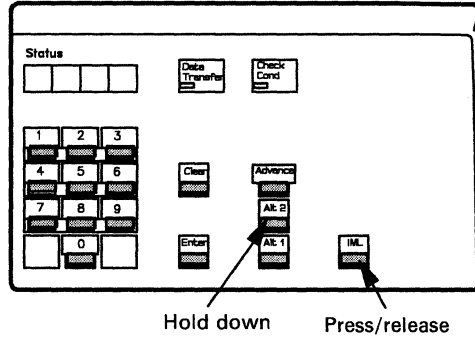

- 4** Were the tests completed without error (**2082** in the **Status** display)?

- No** — Go to “Status Code Chart” on page 4-4, record the full status code, look up the status code in the Status Code Chart, and do the recommended actions.
- Yes** — More problem determination is needed. Request help from your technical support group or help desk.

**Operator Panel**

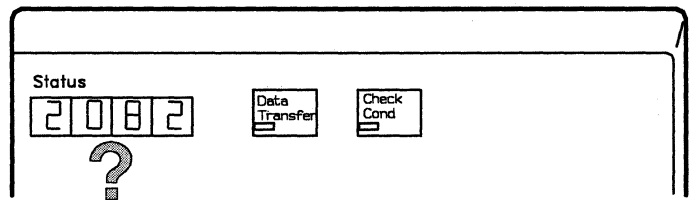

## Offline Tests

### Alt 1 IML Tests

Alt 1 IML tests include:

- Communication Adapter and Communication Cable Test
- Token-Ring Adapter and Cable Test.

#### Communication Adapter and Communication Cable Test

**Warning:** An IML disrupts all control unit operations.

If unexpected status codes appear in the **Status** display, go to "Status Code Chart" on page 4-4, look up the status code, and follow the recommended actions.

- 1** Ask the host operator to take the control unit offline.

Insert a Utility diskette into diskette drive 1.

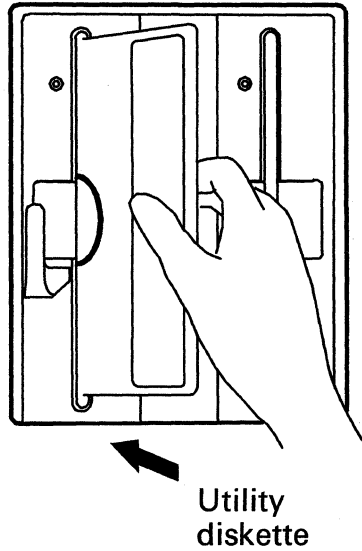

- 2** Go to Figure 3-13 on page 3-111, and set the **TEST/OPER** switch, on the communication cable attached to the modem, to the setting specified for your cable part number.

Cable Part Number	Switch Setting
<p><b>6423153</b> (EIA Type 1)</p> <p>and</p> <p><b>6168155</b> or <b>6423155</b> (X.21 Type 2)</p>	<p>Set the <b>TEST/OPER</b> switch to <b>Test</b>.</p> 
<p>(V.35 Type 1)</p> <p><b>6423157</b> <b>6423325</b> <b>6423326</b></p>	<p><b>For cable connectors with one switch:</b></p> <ol style="list-style-type: none"> <li>1. Set the <b>TEST/OPER</b> switch to <b>OPER</b>.</li> <li>2. Remove the cable connector from the modem and attach the wrap plug (part number 61X4603) to the connector.</li> </ol>  <p><b>For cable connectors with three switches:</b></p> <p>Set all three switches to <b>TEST</b>.</p> 

Figure 3-13. Communication Cable Switch Settings

- 3** Press and hold down **Alt 1** while you press and release **IML**. Then release **Alt 1**.
- Note:** If **40** does not appear in the **Status** display within 5 seconds, do this step again.

**Operator Panel**



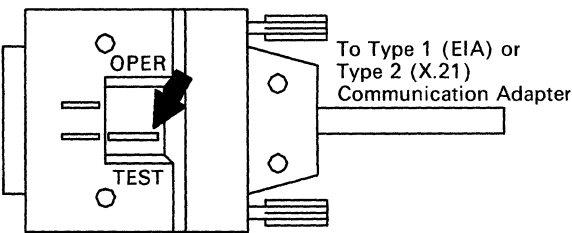
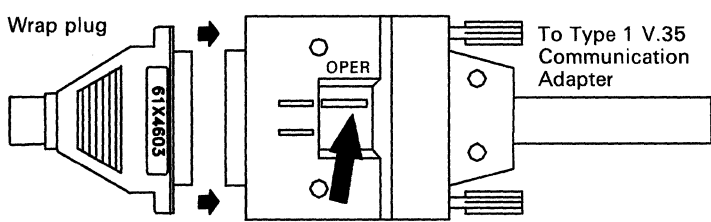
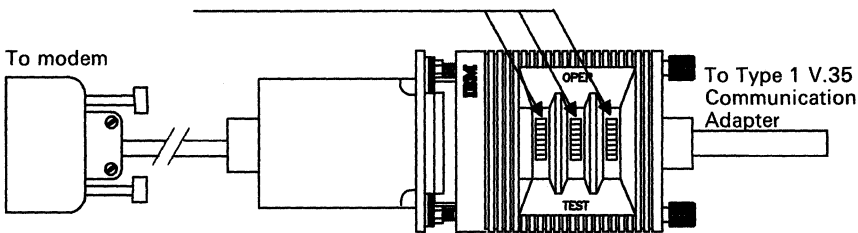
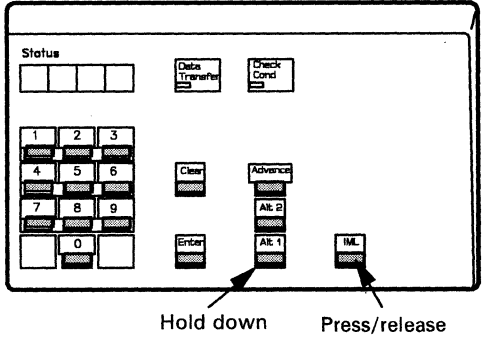

# Offline Tests

**4** When you see 40, key in 80.

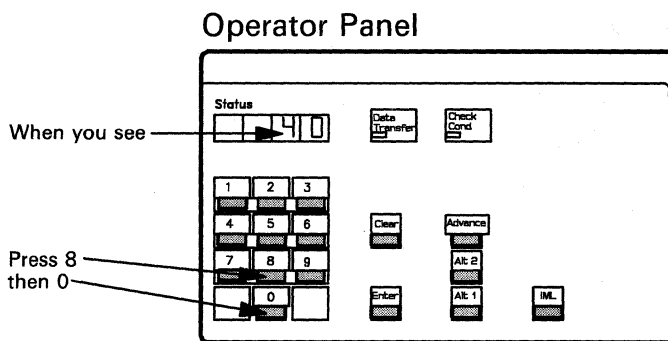

**5** With 80 displayed, press Enter.

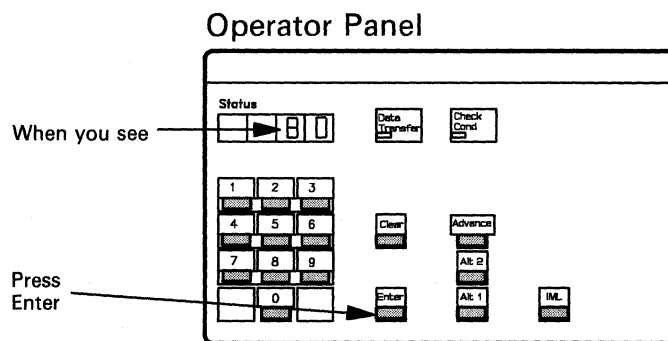

**6** When you see 4001, key in 1101.

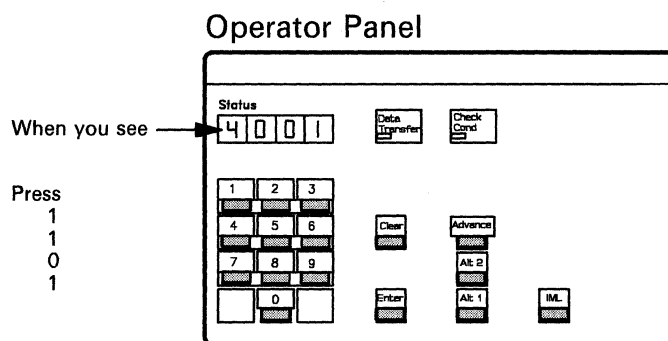

**7** With 1101 displayed, press Enter.

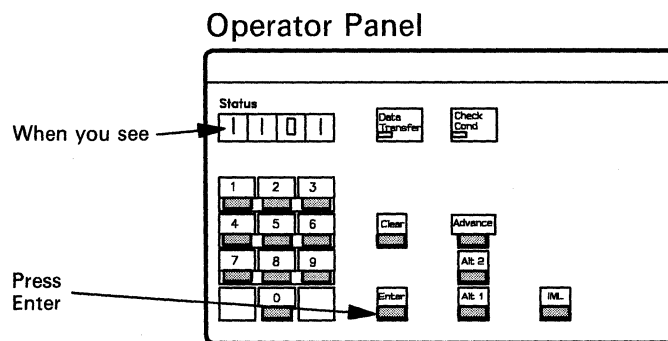

- 8** When the test of the communication adapter and cable is completed, a status code remains in the display. For status codes other than those shown below, refer to "Status Code Chart" on page 4-4.

<b>If the Status code is</b>	<b>Then</b>
<b>2011</b>	The control unit, communication adapter, and communication cable are OK. The problem is in the modem, telecommunication line, or host. Call your help desk for assistance, or call the required service for repair.
<b>3030</b>	There is a problem with the communication adapter or with the cable. Press <b>Advance</b> , and record the next four digits of the status code.  Press <b>Advance</b> a second time, and record the next four digits of the status code.  Press <b>Advance</b> a third time, and record the last four digits of the status code. Request service, and report the problem and all the status code.

- 9** When all tests and repair actions are completed, set the **TEST/OPER** switch(es) on the communication cable to **OPER**.

**Note:** For V.35 communication cables with one switch, remove the wrap plug, and connect the cable to the modem.

To make the control unit operational, refer to "Making the 3174 Operational" on page 2-17.

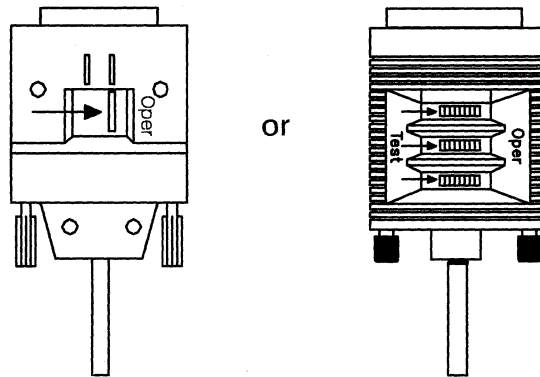

---

## Token-Ring Adapter and Cable Test

**Warning:** This procedure interrupts all host services. Notify users if necessary.

**CAUTION:**

**Do not disconnect or connect cables during an electrical storm.**

- 1 Ask the host operator to take the control unit offline.  
Insert a Utility diskette into diskette drive 1.  
For Model 1L, go to step 2.  
For Model 3R, go to step 3.

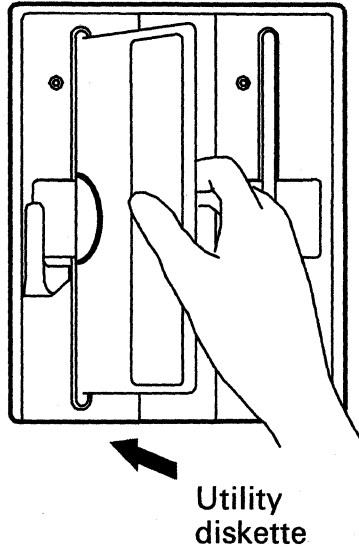

- 
- 2 For Model 1L, set the **Channel Interface** switch to **Offline**, and wait for the offline indicator to light.

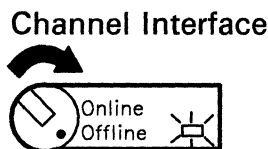

- 
- 3 Press and hold down **Alt 1** while you press and release **IML**. Then release **Alt 1**.

**Note:** If 40 does not appear in the **Status** display within 5 seconds, do this step again.

### Operator Panel

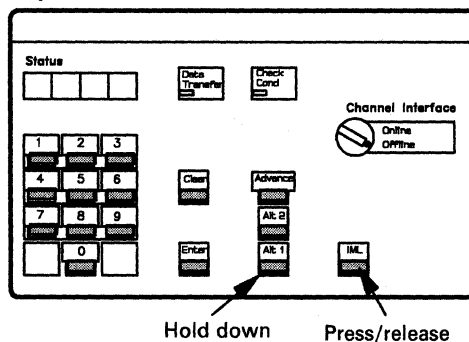

4 When you see 40, key in 80.

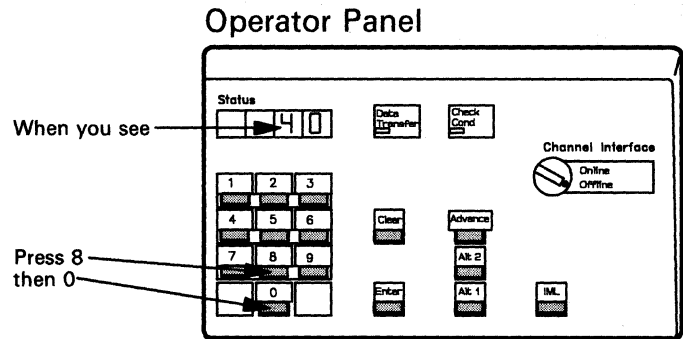

5 With 80 displayed, press Enter.

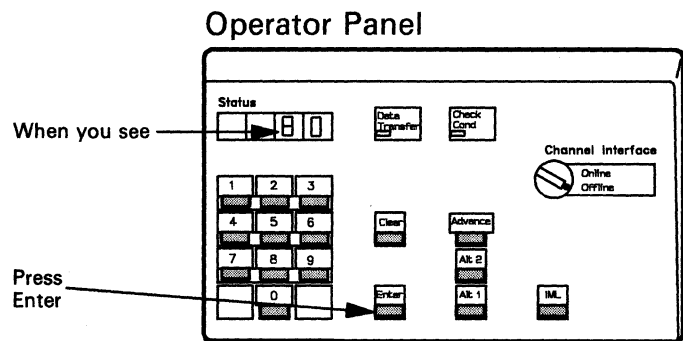

6 When you see 4001, key in 3101.

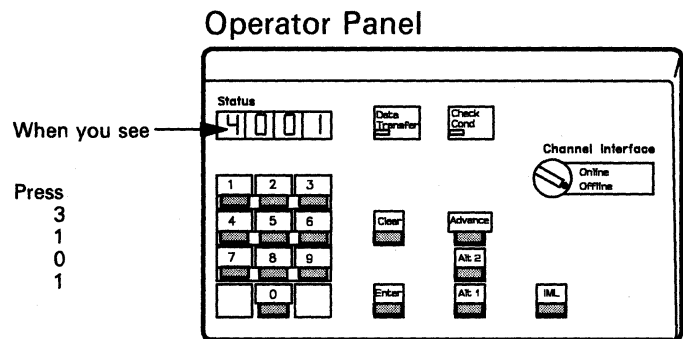

7 With 3101 displayed, press Enter.

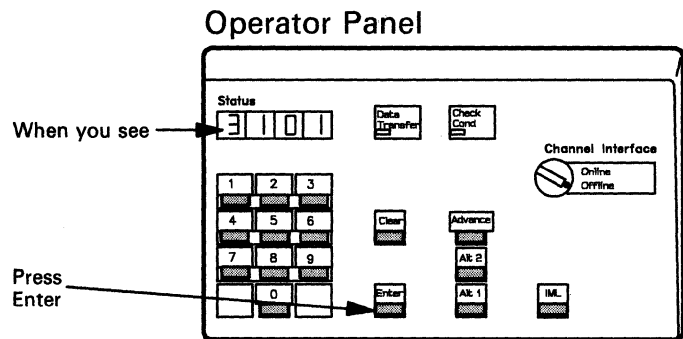

## Offline Tests

- 8** When the test of the Token-Ring Adapter and cable is completed, a status code remains in the display. For status codes other than those shown below, refer to "Status Code Chart" on page 4-4.

If the Status code is	Then
2031	The control unit, Token-Ring Adapter, and adapter cable are OK. For further actions, refer to <i>IBM Token-Ring Problem Determination Guide</i> , or request help from your technical support group or help desk.
3050	Go to step 9.

- 9** Disconnect the Token-Ring Adapter cable from the wall connector or faceplate.

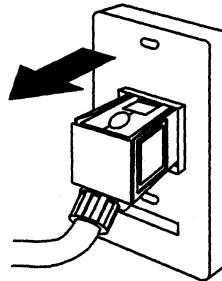

- 10** With 3050 displayed, press Enter.

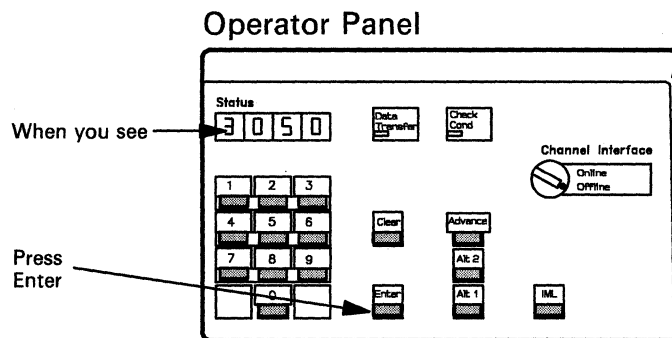

- 11** When you see 4001, key in 3101.

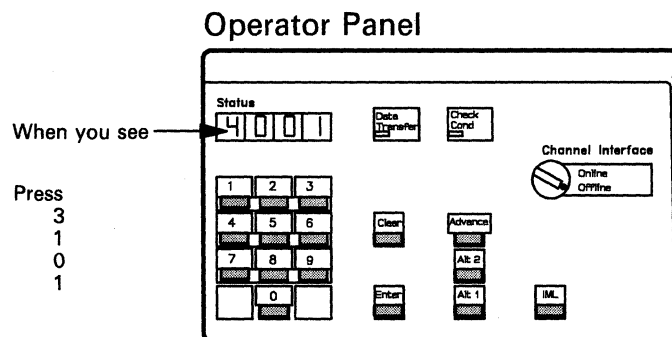

**12** With 3101 displayed, press **Enter**.

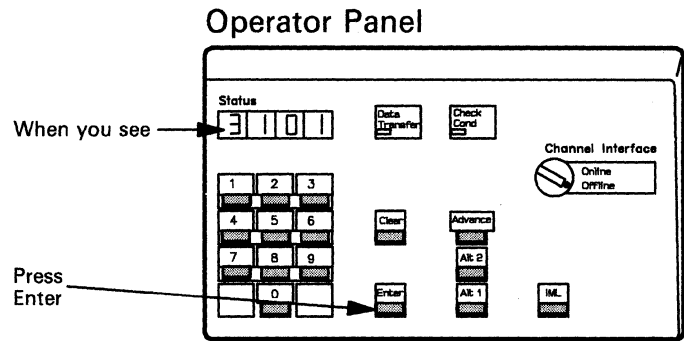

**13** When the test of the Token-Ring Adapter and cable is completed, a status code remains in the display. For status codes other than those shown below, refer to "Status Code Chart" on page 4-4.

**If the Status code is**

**Then**

**2031**

The control unit, Token-Ring Adapter, and adapter cable are OK. For further actions, refer to *IBM Token-Ring Problem Determination Guide*, or request help from your technical support group or help desk.

**3050**

There is a problem with the Token-Ring Adapter or with the cable.

Press **Advance**, and record the next four digits of the status code.

Press **Advance** a second time, and record the next four digits of the status code.

Press **Advance** a third time, and record the last four digits of the status code.

Request service for the control unit. Report the problem and all the status code.

**14** When all tests and repair actions are completed, connect the Token-Ring Adapter cable to the wall connector or faceplate.

To make the control unit operational, refer to "Making the 3174 Operational" on page 2-17.

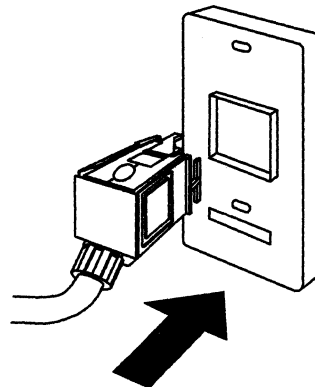



---

## Chapter 4. Status Codes

Description	4-2
How to Display Status Codes	4-2
Status Code Chart	4-4

---

Status codes help you identify and locate a failing subsystem component. Status codes appear in the **Status** display on the operator panel of the 3174, or in the events log, or on attached terminals.

Before looking up a status code, you may need to know what a status code is, how to display it, and how to use the Status Code Chart. If you want to know this kind of information, read the next three pages before looking up the status code in the Status Code Chart.



---

### Description

The *base* status code is a number from 1 to 4 digits long. The base status code is the first 1-to-4-digit number that is displayed in the **Status** display, or in the events log, or on the terminal. The base status code is the number in the first column of the Status Code Chart (pages 4-5 through 4-56).

The base status code may have additional numbers following it; these additional numbers can be displayed at the operator panel by pressing **Advance**. These numbers will be used to further qualify and identify the base status code.

Depending on the type of problem, one or more status codes can be logged in the control unit. Individual status codes are separated from one another by a blank **Status** display (all four status indicators are blank). That is, when you reach the end of a status code and press **Advance**, you see a blank **Status** display. At the end of a group of status codes, you must press **Advance** twice to review the status codes again.

---

### How to Display Status Codes

Initially, the **Status** display can be blank, or displaying a status code, or sequencing (displaying up to 10 codes, one at a time). Read through the following five-step procedure, and then refer to the following table to get the full status code(s).

**Note:** The following procedure should not be used if the **Status** display contains nonnumeric characters. If you see nonnumeric characters in the **Status** display, request service for the control unit.

1. Observe the initial condition of the **Status** display, and match it to one of the conditions (A, B, or C) in the first column of the following table (on page 4-3).
2. Do the action described in the second column, and note the result (third column).
3. Record the status code(s) as you move through the procedure; you will need the full status code (base status code and additional numbers) when you look up the status code in the Status Code Chart.
4. Do the appropriate actions listed in the last column.
5. Once you have the full status code(s), read the section "Status Code Chart" on page 4-4 and familiarize yourself with how to use and understand the chart. Then look up the status code.

Initial Status Display Condition:	Press:	Result:	Next Steps:
<p><b>Condition A:</b></p> <p>Status display is blank.</p>	<p><b>Enter</b></p>	<p>One status code is displayed (not sequencing).</p> <p>OR</p> <p>The Status display is sequencing, displaying up to 10 status codes, one at a time.</p>	<p>If one status code is displayed, go to Condition B.</p> <p>If the Status display is sequencing, go to Condition C.</p>
<p><b>Condition B:</b></p> <p>A status code is displayed.</p>	<p><b>Advance</b></p>	<p>Additional numbers are displayed.</p> <p>OR</p> <p>The status code remains in the display, indicating that there are no additional numbers (in this case, do not do the Next Steps).</p>	<ol style="list-style-type: none"> <li>1. Press <b>Advance</b> to display additional numbers.</li> <li>2. Repeat step 1 until the <b>Status</b> display is blank.</li> <li>3. Press <b>Advance</b> again.</li> </ol> <p>Does the <b>Status</b> display remain blank?</p> <p><b>No</b> — The number in the <b>Status</b> display is the original status code or another status code. Repeat steps 1 through 3, as required.</p> <p><b>Yes</b> — This is the end of the status codes. To display the first status code again, press <b>Advance</b>.</p>
<p><b>Condition C:</b></p> <p>Sequencing (first code, blank, second code, blank, and so on).</p>	<p><b>Advance</b></p>	<p>Status display stops on one code.</p>	<ol style="list-style-type: none"> <li>1. Press <b>Advance</b> to display additional numbers.</li> <li>2. Repeat step 1 until the <b>Status</b> display is blank.</li> <li>3. Press <b>Advance</b> again.</li> </ol> <p>Do you want to see the next status code?</p> <p><b>No</b> — Repeat steps 1 through 3 to display the status code again.</p> <p><b>Yes</b> — Press <b>Enter</b>. This causes the <b>Status</b> display to again start sequencing, displaying up to 10 status codes, one at a time.</p> <p>Press <b>Advance</b>, as you did before, to stop the display on the selected status code. Repeat steps 1 through 3.</p>

---

## Status Code Chart

Status codes are listed in numeric order in the Status Code Chart. To use the chart:

1. Look up the base status code in the first column of the chart.
2. Look for the additional numbers associated with the base status code; **these numbers are printed in bold-face at the start of an entry in the second column.**

**Note:** In the Status Code Chart, x represents any number from 0 to 9.

3. Read the description and do the first recommended action. If that does not solve the problem, do the next action. Continue in this way until you solve the problem or are told to call for help or for service.
4. When requesting service, be sure to give the base status code and additional numbers to the service personnel.

The Status Code Chart uses some abbreviations that you should be familiar with:

**HG** HG means *Hardware Group*. A hardware group number is a 2-digit number that represents a functional area of the control unit. For example, a hardware group number of 01 means *diskette drive 1*.

**Re-IML** Re-IML means to try to make the control unit operational; refer to "Making the 3174 Operational" on page 2-17 for the correct actions.

Base Status Code	Possible Additional Numbers / Explanation / Action
31	<ul style="list-style-type: none"> <li>• Release the <b>Alt 1</b> or <b>Alt 2</b> pushbutton, or</li> <li>• Request help from your technical support group or help desk.</li> </ul>
36	<p><i>IML hardware failure: file adapter.</i></p> <ul style="list-style-type: none"> <li>• Re-IML.</li> <li>• Request service for the control unit.</li> </ul>
40	<p><i>This is a normal Alt 1 IML prompt for additional input.</i></p> <p>The Alt 1 IML procedures provide the required responses (refer to “Alt 1 IML Tests” on page 3-110).</p>
42 – 94	<p><i>IML hardware failure: processor or storage card.</i></p> <ul style="list-style-type: none"> <li>• Re-IML.</li> <li>• Request service for the control unit.</li> </ul>
96 – 98	<p><i>Invalid response to the Alt 1 IML 40 prompt.</i></p> <ul style="list-style-type: none"> <li>• Re-IML.</li> <li>• Try the keypad entry again.</li> <li>• Request help from your technical support group or help desk.</li> </ul>
101 – 114	<p><i>IML hardware failure: processor or file adapter.</i></p> <ul style="list-style-type: none"> <li>• Re-IML.</li> <li>• Request help from your technical support group or help desk.</li> </ul>
117	<p><i>IML hardware failure: diskette drive or media.</i></p> <ul style="list-style-type: none"> <li>• Make sure that the correct diskette is correctly installed (refer to “Diskettes and Diskette Drives” on page 2-13 for the correct way to insert diskettes).</li> <li>• Insert a backup diskette, and try the Alt 1 IML again.</li> <li>• If the problem returns, run Alt 2 IML tests (refer to “Alt 2 IML Tests” on page 3-108).</li> <li>• Request help from your technical support group or help desk.</li> </ul>
120	<p><i>During an Alt 2 IML, a Control or Utility diskette was not found in diskette drive 01.</i></p> <ul style="list-style-type: none"> <li>• Insert a Control or Utility diskette into diskette drive 01.</li> <li>• Try an Alt 2 IML again.</li> <li>• Try using a backup copy of the diskette.</li> <li>• Request help from your technical support group or help desk.</li> </ul>
121	<p><i>A not-ready drive condition was detected during an Alt 1 or Alt 2 IML.</i></p> <ul style="list-style-type: none"> <li>• Make sure that the diskette is correctly installed. For an Alt 2 IML, the diskette must be in drive 01.</li> <li>• Make sure that the diskette drive lever is closed.</li> <li>• Try the Alt 1 or Alt 2 IML again.</li> <li>• Request help from your technical support group or help desk.</li> </ul>
123	<p><i>IML hardware failure: diskette drive or file adapter.</i></p> <ul style="list-style-type: none"> <li>• Re-IML.</li> <li>• Request help from your technical support group or help desk.</li> </ul>

- Re-IML means to try to make the control unit operational; refer to page 2-17 for the correct actions.
- When requesting service, be sure to give the status code and additional numbers to the service personnel.
- Some status codes are normal progress or completion messages; if the **Status Code** remains lit for more than 10 seconds, the code indicates an error. For an error, perform the appropriate actions.

Base Status Code	Possible Additional Numbers / Explanation / Action
124	<p><i>IML hardware failure: diskette drive or media.</i></p> <ul style="list-style-type: none"> <li>• Re-IML with the backup Control diskette.</li> <li>• Request help from your technical support group or help desk.</li> </ul>
125	<p><i>IML hardware failure: diskette drive.</i></p> <ul style="list-style-type: none"> <li>• Re-IML.</li> <li>• Request help from your technical support group or help desk.</li> </ul>
130	<p><i>During a normal IML, the Control diskette was not found.</i></p> <ul style="list-style-type: none"> <li>• Make sure that a customized Control diskette is correctly inserted into the diskette drive, and try to IML again (refer to "Diskettes and Diskette Drives" on page 2-13 for the correct way to insert diskettes).</li> <li>• Try another Control diskette.</li> <li>• Re-IML.</li> <li>• Request help from your technical support group or help desk.</li> </ul>
131	<p><i>An Alt 1 IML was performed with a diskette that does not have IML capabilities.</i></p> <ul style="list-style-type: none"> <li>• Insert a valid Control or Utility diskette, and re-IML.</li> <li>• Request help from your technical support group or help desk.</li> </ul>
2%%	<p><i>There is a mismatch between customization and the hardware that is installed on the 3174 control unit.</i></p> <p>Request help from your technical support group or help desk.</p>
200 – 299	<p><i>3270 terminal failure (display, printer, selector pen, etc.).</i></p> <ul style="list-style-type: none"> <li>• Press RESET at the affected terminal and try the operation again.</li> <li>• At the affected terminal, set the Normal/Test switch from Normal to Test and back again. Then try the operation again.</li> <li>• At the affected terminal, switch the power off, then on, and try the operation again.</li> <li>• Request help from your technical support group or help desk.</li> </ul>
301 – 311	<p><i>3174 hardware failure.</i></p> <ul style="list-style-type: none"> <li>• Press RESET at the affected terminal.</li> <li>• Try the operation again.</li> <li>• Re-IML.</li> </ul> <p><b>Warning:</b> An IML disrupts all operating terminals.</p> <ul style="list-style-type: none"> <li>• Run an Alt 2 IML Test (refer to "Alt 2 IML Tests" on page 3-108).</li> <li>• Request service for the control unit.</li> </ul>
313	<p><i>3174 hardware failure: operator panel.</i></p> <ul style="list-style-type: none"> <li>• Press RESET at the affected terminal. No further recovery is possible at this time. Repair action is mandatory before the next IML.</li> <li>• Request service for the control unit.</li> </ul>

- Re-IML means to try to make the control unit operational; refer to page 2-17 for the correct actions.
- When requesting service, be sure to give the status code and additional numbers to the service personnel.
- Some status codes are normal progress or completion messages; if the **Status Code** remains lit for more than 10 seconds, the code indicates an error. For an error, perform the appropriate actions.

Base Status Code	Possible Additional Numbers / Explanation / Action
315 – 331	<p><i>3174 hardware failure.</i></p> <ul style="list-style-type: none"> <li>• Press RESET at the affected terminal.</li> <li>• Try the operation again.</li> <li>• Re-IML.</li> </ul> <p><b>Warning:</b> An IML disrupts all operating terminals.</p> <ul style="list-style-type: none"> <li>• Run an Alt 2 IML Test (refer to “Alt 2 IML Tests” on page 3-108).</li> <li>• Request service for the control unit.</li> </ul>
335	<p><i>3174 hardware failure, Encrypt/Decrypt feature.</i></p> <p><b>Note:</b> The control unit can still be operational without the Encrypt/Decrypt Adapter.</p> <ul style="list-style-type: none"> <li>• Press RESET at the affected terminal.</li> <li>• Try the operation again.</li> <li>• Re-IML.</li> </ul> <p><b>Warning:</b> An IML disrupts all operating terminals.</p> <ul style="list-style-type: none"> <li>• Run an Alt 2 IML Test (refer to “Alt 2 IML Tests” on page 3-108).</li> <li>• Request help from your technical support group or help desk.</li> </ul>
336	<p><i>3174 hardware failure, Encrypt/Decrypt battery.</i></p> <p>Replace the battery on the Encrypt/Decrypt adapter card.</p>
340	<p><i>A Token-Ring Adapter error condition has been cleared.</i></p> <p>No action is required.</p>

- Re-IML means to try to make the control unit operational; refer to page 2-17 for the correct actions.
- When requesting service, be sure to give the status code and additional numbers to the service personnel.
- Some status codes are normal progress or completion messages; if the **Status Code** remains lit for more than 10 seconds, the code indicates an error. For an error, perform the appropriate actions.

Base Status Code	Possible Additional Numbers / Explanation / Action
341	<p><b>01HG – 02HG</b> <i>A Token-Ring Adapter hardware failure occurred.</i></p> <ul style="list-style-type: none"> <li>• Contact the host operator to return the link(s) to service.</li> <li>• Do an Alt 2 IML (refer to “Alt 2 IML Tests” on page 3-108).</li> </ul> <p><b>Warning:</b> An IML disrupts all operating terminals.</p> <ul style="list-style-type: none"> <li>• Request help from your technical support group or help desk.</li> </ul>
	<p><b>03HG – 06HG</b> <i>A Token-Ring Adapter hardware failure occurred.</i></p> <ul style="list-style-type: none"> <li>• Do an Alt 2 IML (refer to “Alt 2 IML Tests” on page 3-108).</li> </ul> <p><b>Warning:</b> An IML disrupts all operating terminals.</p> <ul style="list-style-type: none"> <li>• Request help from your technical support group or help desk.</li> </ul>
	<p><b>07HG – 20HG</b> <i>A Token-Ring Adapter hardware failure occurred.</i></p> <ul style="list-style-type: none"> <li>• Contact the host operator to return the link(s) to service.</li> <li>• Do an Alt 2 IML (refer to “Alt 2 IML Tests” on page 3-108).</li> </ul> <p><b>Warning:</b> An IML disrupts all operating terminals.</p> <ul style="list-style-type: none"> <li>• Request help from your technical support group or help desk.</li> </ul>
	<p><b>21HG – 22HG</b> <i>A Token-Ring Adapter hardware failure occurred.</i></p> <ul style="list-style-type: none"> <li>• Do an Alt 2 IML (refer to “Alt 2 IML Tests” on page 3-108).</li> </ul> <p><b>Warning:</b> An IML disrupts all operating terminals.</p> <ul style="list-style-type: none"> <li>• Request help from your technical support group or help desk.</li> </ul>
	<p><b>53HG – 56HG</b> <i>A temporary Token-Ring Adapter failure occurred.</i></p> <ul style="list-style-type: none"> <li>• No repair actions are required if the control unit is operating normally. If it is not working normally, go to the next step.</li> <li>• Do an Alt 2 IML (refer to “Alt 2 IML Tests” on page 3-108).</li> </ul> <p><b>Warning:</b> An IML disrupts all operating terminals.</p> <ul style="list-style-type: none"> <li>• Request help from your technical support group or help desk.</li> </ul>
351 and 352	<p><i>An ASCII Adapter hardware or microcode failure occurred.</i></p> <ul style="list-style-type: none"> <li>• Use Test 12, Option 1,2 (refer to “Procedure H – All Connections to ASCII Adapter Are Failing” on page 3-57) to perform an ASCII Port Wrap Test on the failing adapter port (HG and port) indicated in the terminal message.</li> <li>• Re-IML.</li> </ul> <p><b>Warning:</b> An IML disrupts all operating terminals.</p> <ul style="list-style-type: none"> <li>• Run an Alt 2 IML Test (refer to “Alt 2 IML Tests” on page 3-108).</li> <li>• Request service for the control unit.</li> </ul>

- Re-IML means to try to make the control unit operational; refer to page 2-17 for the correct actions.
- When requesting service, be sure to give the status code and additional numbers to the service personnel.
- Some status codes are normal progress or completion messages; if the **Status Code** remains lit for more than 10 seconds, the code indicates an error. For an error, perform the appropriate actions.

Base Status Code	Possible Additional Numbers / Explanation / Action
380	<p><b>01HG – 20HG</b> <i>A Token-Ring Adapter microcode failure occurred.</i></p> <ul style="list-style-type: none"> <li>• Contact the host operator to return the link(s) to service.</li> <li>• Do an Alt 2 IML (refer to “Alt 2 IML Tests” on page 3-108).</li> <li>• Request service for the control unit.</li> </ul>
	<p><b>60HG – 96HG</b> <i>A temporary Token-Ring Adapter microcode failure occurred.</i></p> <ul style="list-style-type: none"> <li>• No action is required if the control unit is operating normally. If it is not working normally, go to the next step.</li> <li>• Contact the host operator to reactivate the links.</li> <li>• Do an Alt 2 IML (refer to “Alt 2 IML Tests” on page 3-108).</li> <li>• Request help from your technical support group or help desk.</li> </ul>
381	<p><b>0xHG – 21HG</b> <i>A 3174 microcode failure occurred.</i></p> <ul style="list-style-type: none"> <li>• Re-IML.</li> <li>• Run an Alt 2 IML Test (refer to “Alt 2 IML Tests” on page 3-108).</li> <li>• Request service for the control unit.</li> </ul>
	<p><b>5xHG</b> <i>A 3174 microcode failure occurred.</i></p> <p>No action is required unless your operation is impaired.</p> <ul style="list-style-type: none"> <li>• Re-IML.</li> <li>• Run an Alt 2 IML Test (refer to “Alt 2 IML Tests” on page 3-108).</li> <li>• Request service for the control unit.</li> </ul>
382	<p><i>3174 operational hardware failure.</i></p> <ul style="list-style-type: none"> <li>• Press RESET at the affected terminal.</li> <li>• Try the operation again.</li> <li>• Re-IML.</li> </ul> <p><b>Warning:</b> An IML disrupts all operating terminals.</p> <ul style="list-style-type: none"> <li>• Run an Alt 2 IML Test (refer to “Alt 2 IML Tests” on page 3-108).</li> <li>• Request service for the control unit.</li> </ul>
384	<p><i>A Downstream Load (DSL) diskette is not present in the 3174.</i></p> <ul style="list-style-type: none"> <li>• Remove the DSL diskette (usually in drive 2) and reinsert it. Certain terminals may require power-on.</li> <li>• Try another DSL diskette.</li> <li>• If the problem continues, re-IML.</li> </ul> <p><b>Warning:</b> An IML disrupts all operating terminals.</p> <ul style="list-style-type: none"> <li>• Do an Alt 2 IML (refer to “Alt 2 IML Tests” on page 3-108).</li> <li>• Request service for the control unit.</li> </ul>

- Re-IML means to try to make the control unit operational; refer to page 2-17 for the correct actions.
- When requesting service, be sure to give the status code and additional numbers to the service personnel.
- Some status codes are normal progress or completion messages; if the **Status Code** remains lit for more than 10 seconds, the code indicates an error. For an error, perform the appropriate actions.



## Status Codes

<b>Base Status Code</b>	<b>Possible Additional Numbers / Explanation / Action</b>
385	<p><b>00HG</b> <i>A 3174 diskette drive is not ready.</i></p> <ul style="list-style-type: none"><li>• Remove the diskette and check that it is the correct diskette.</li><li>• Insert the correct diskette into the drive to start again.</li><li>• If the problem occurred during IML, then re-IML.</li></ul> <p><b>Warning:</b> An IML disrupts all operating terminals.</p> <ul style="list-style-type: none"><li>• Do an Alt 2 IML (refer to "Alt 2 IML Tests" on page 3-108).</li><li>• Request service for the control unit.</li></ul>
	<hr/> <p><b>01HG</b> <i>A 3174 diskette drive is not ready.</i></p> <ul style="list-style-type: none"><li>• Remove the Control diskette (usually in drive 1) and check that it really is the Control diskette.</li><li>• Insert the correct diskette into the drive to start again.</li><li>• If the problem continues, re-IML.</li></ul> <p><b>Warning:</b> An IML disrupts all operating terminals.</p> <ul style="list-style-type: none"><li>• Do an Alt 2 IML (refer to "Alt 2 IML Tests" on page 3-108).</li><li>• Request service for the control unit.</li></ul>
	<hr/> <p><b>02HG</b> <i>A 3174 diskette drive is not ready during an online test.</i></p> <ul style="list-style-type: none"><li>• Remove the Control diskette (usually in drive 1) and check that it really is the Control diskette.</li><li>• Insert the correct diskette into the drive to start again.</li><li>• Select the online test again.</li><li>• If the problem continues, re-IML.</li></ul> <p><b>Warning:</b> An IML disrupts all operating terminals.</p> <ul style="list-style-type: none"><li>• Do an Alt 2 IML (refer to "Alt 2 IML Tests" on page 3-108).</li><li>• Request service for the control unit.</li></ul>
	<hr/> <p><b>03HG and 04HG</b> <i>A 3174 diskette drive is not ready during customizing or IML.</i></p> <ul style="list-style-type: none"><li>• Remove the Control diskette (usually in drive 1) and check that it really is the Control diskette.</li><li>• Insert the correct diskette into the drive and re-IML to start again.</li><li>• Do an Alt 2 IML (refer to "Alt 2 IML Tests" on page 3-108).</li><li>• Request service for the control unit.</li></ul>
	<hr/> <p><b>05HG</b> <i>The 3174 diskette drive containing the Downstream Load (DSL) diskette is not ready.</i></p> <ul style="list-style-type: none"><li>• Remove the DSL diskette (usually in drive 2) and check that it really is the DSL diskette.</li><li>• Insert the correct diskette into the drive and close the drive lever.</li><li>• If the problem continues, replace the DSL diskette with a duplicate.</li></ul>

- Re-IML means to try to make the control unit operational; refer to page 2-17 for the correct actions.
- When requesting service, be sure to give the status code and additional numbers to the service personnel.
- Some status codes are normal progress or completion messages; if the **Status Code** remains lit for more than 10 seconds, the code indicates an error. For an error, perform the appropriate actions.

Base Status Code	Possible Additional Numbers / Explanation / Action
385 (cont.)	<p><b>06HG</b> <i>The 3174 diskette drive containing the Distributed Function Terminal (DFT) Dump diskette is not ready.</i></p> <ul style="list-style-type: none"> <li>• Remove the Dump diskette (usually in drive 1) and check that it really is the Dump diskette.</li> <li>• Insert the correct diskette into the drive and select the dump again.</li> <li>• If the problem continues, re-IML.</li> </ul> <p><b>Warning:</b> An IML disrupts all operating terminals.</p> <ul style="list-style-type: none"> <li>• Do an Alt 2 IML (refer to “Alt 2 IML Tests” on page 3-108).</li> <li>• Request service for the control unit.</li> </ul>
	<p><b>07HG</b> <i>The 3174 diskette drive is not ready during offline diagnostics.</i></p> <ul style="list-style-type: none"> <li>• Remove the Utility diskette (usually in drive 1) and check that it really is the Utility diskette.</li> <li>• Insert the correct diskette into the drive, press <b>ENTER</b>, and select the test again.</li> <li>• If the problem continues, re-IML.</li> <li>• Do an Alt 2 IML (refer to “Alt 2 IML Tests” on page 3-108).</li> <li>• Request service for the control unit.</li> </ul>
	<p><b>08HG</b> <i>The 3174 diskette drive is not ready during an offline dump, and the dump has been lost.</i></p> <ul style="list-style-type: none"> <li>• Initiate the dump again at the next microcode failure.</li> <li>• Do an Alt 2 IML (refer to “Alt 2 IML Tests” on page 3-108).</li> <li>• Request service for the control unit.</li> </ul>
	<p><b>09HG</b> <i>The 3174 diskette drive is not ready during an offline dump.</i></p> <ul style="list-style-type: none"> <li>• Remove the Control or Dump diskette (usually in drive 1) and check that you are using the correct one.</li> <li>• Insert the correct diskette into the drive to start the dump again.</li> <li>• Do an Alt 2 IML (refer to “Alt 2 IML Tests” on page 3-108).</li> <li>• Request service for the control unit.</li> </ul>
387	<p><i>The wrong diskette is being used in the control unit for Downstream Load (DSL).</i></p> <ul style="list-style-type: none"> <li>• Remove the DSL diskette (usually in drive 2) and check that it really is the DSL diskette.</li> <li>• Insert the DSL diskette into the drive and power-on the Distributed Function Terminal to start again.</li> <li>• If the problem continues, re-IML.</li> </ul> <p><b>Warning:</b> An IML disrupts all operating terminals.</p> <ul style="list-style-type: none"> <li>• Do an Alt 2 IML (refer to “Alt 2 IML Tests” on page 3-108).</li> <li>• Request service for the control unit.</li> </ul>

- Re-IML means to try to make the control unit operational; refer to page 2-17 for the correct actions.
- When requesting service, be sure to give the status code and additional numbers to the service personnel.
- Some status codes are normal progress or completion messages; if the **Status Code** remains lit for more than 10 seconds, the code indicates an error. For an error, perform the appropriate actions.

Base Status Code	Possible Additional Numbers / Explanation / Action
388	<p><b>00HG</b> <i>A 3174 diskette media failure.</i></p> <ul style="list-style-type: none"> <li>• Remove the diskette.</li> <li>• Insert another diskette into the drive.</li> <li>• If the problem occurred during IML, then re-IML.</li> </ul> <p><b>Warning:</b> An IML disrupts all operating terminals.</p> <ul style="list-style-type: none"> <li>• Do an Alt 2 IML (refer to “Alt 2 IML Tests” on page 3-108).</li> <li>• Request service for the control unit.</li> </ul>
	<p><b>01HG</b> <i>A 3174 diskette media failure occurred during the logging of records.</i></p> <ul style="list-style-type: none"> <li>• Remove the Control diskette (usually in drive 1) and check that it really is the Control diskette.</li> <li>• Insert the correct diskette into the drive to start again.</li> <li>• If the problem continues, repeat the procedures above with a duplicate Control diskette.</li> <li>• If the problem continues, re-IML.</li> </ul> <p><b>Warning:</b> An IML disrupts all operating terminals.</p> <ul style="list-style-type: none"> <li>• Do an Alt 2 IML (refer to “Alt 2 IML Tests” on page 3-108).</li> <li>• Request service for the control unit.</li> </ul>
	<p><b>02HG</b> <i>A 3174 diskette media failure occurred during an online test.</i></p> <ul style="list-style-type: none"> <li>• Remove the Control diskette (usually in drive 1) and check that it really is the Control diskette.</li> <li>• Insert the correct diskette into the drive and select the test again.</li> <li>• If the problem continues, repeat the procedures above with a duplicate Control diskette.</li> <li>• If the problem continues, re-IML.</li> </ul> <p><b>Warning:</b> An IML disrupts all operating terminals.</p> <ul style="list-style-type: none"> <li>• Do an Alt 2 IML (refer to “Alt 2 IML Tests” on page 3-108).</li> <li>• Request service for the control unit.</li> </ul>
	<p><b>03HG and 04HG</b> <i>A 3174 diskette media failure occurred during an IML or customizing.</i></p> <ul style="list-style-type: none"> <li>• Remove the Control diskette (usually in drive 1) and check that it really is the Control diskette.</li> <li>• Insert the correct diskette into the drive and re-IML to start again.</li> <li>• If the problem continues, repeat the procedures above with a duplicate Control diskette.</li> <li>• Do an Alt 2 IML (refer to “Alt 2 IML Tests” on page 3-108).</li> <li>• Request service for the control unit.</li> </ul>
	<p><b>05HG</b> <i>A 3174 diskette media failure occurred during a Downstream Load (DSL) operation.</i></p> <ul style="list-style-type: none"> <li>• Remove the DSL diskette (usually in drive 2) and check that it really is a DSL diskette.</li> <li>• Insert the correct diskette into the drive and power-on the Distributed Function Terminal to start again.</li> <li>• If the problem continues, repeat the procedures above with a duplicate DSL diskette.</li> <li>• If the problem continues, re-IML.</li> </ul> <p><b>Warning:</b> An IML disrupts all operating terminals.</p> <ul style="list-style-type: none"> <li>• Do an Alt 2 IML (refer to “Alt 2 IML Tests” on page 3-108).</li> <li>• Request service for the control unit.</li> </ul>

- Re-IML means to try to make the control unit operational; refer to page 2-17 for the correct actions.
- When requesting service, be sure to give the status code and additional numbers to the service personnel.
- Some status codes are normal progress or completion messages; if the **Status Code** remains lit for more than 10 seconds, the code indicates an error. For an error, perform the appropriate actions.

Base Status Code	Possible Additional Numbers / Explanation / Action
388 (cont.)	<p><b>06HG</b> <i>A 3174 diskette media failure occurred during a Distributed Function Terminal dump.</i></p> <ul style="list-style-type: none"> <li>• Remove the Dump diskette (usually in drive 1) and check that it really is the Dump diskette.</li> <li>• Insert the correct diskette into the drive and select the dump again.</li> <li>• If the problem continues, repeat the procedures above with a different Dump diskette.</li> <li>• If the problem continues, re-IML.</li> </ul> <p><b>Warning:</b> An IML disrupts all operating terminals.</p> <ul style="list-style-type: none"> <li>• Do an Alt 2 IML (refer to “Alt 2 IML Tests” on page 3-108).</li> <li>• Request service for the control unit.</li> </ul>
	<p><b>07HG</b> <i>A 3174 diskette media failure occurred during offline diagnostics.</i></p> <ul style="list-style-type: none"> <li>• Remove the Utility diskette (usually in drive 1) and check that it really is the Utility diskette.</li> <li>• Insert the correct diskette into the drive, press <b>ENTER</b>, and select the test again.</li> <li>• If the problem continues, repeat the procedures above with a different Utility diskette.</li> <li>• If the problem continues, re-IML.</li> <li>• Do an Alt 2 IML (refer to “Alt 2 IML Tests” on page 3-108).</li> <li>• Request service for the control unit.</li> </ul>
	<p><b>08HG</b> <i>A 3174 diskette media failure occurred during an offline dump, and the dump has been lost.</i></p> <ul style="list-style-type: none"> <li>• Initiate the dump again at the next microcode failure.</li> <li>• Do an Alt 2 IML (refer to “Alt 2 IML Tests” on page 3-108).</li> <li>• Request service for the control unit.</li> </ul>
	<p><b>09HG</b> <i>A 3174 diskette media failure occurred during an offline dump.</i></p> <ul style="list-style-type: none"> <li>• Remove the Control or Dump diskette (usually in drive 1) and check that you are using the correct one.</li> <li>• Insert the correct diskette into the drive to start the dump again.</li> <li>• If the problem continues, repeat the procedures above with a different Dump diskette or a duplicate Control diskette.</li> </ul> <p><b>Note:</b> If you use another Dump diskette, part of the dump will be on the original diskette and the rest will be on the second diskette.</p> <ul style="list-style-type: none"> <li>• Do an Alt 2 IML (refer to “Alt 2 IML Tests” on page 3-108).</li> <li>• Request service for the control unit.</li> </ul>
389	<p><b>01HG – 04HG</b> <i>A 3174 file adapter failure occurred.</i></p> <ul style="list-style-type: none"> <li>• No further recovery is possible at this time. Repair action is mandatory before the next IML.</li> </ul> <p><b>Warning:</b> Do not turn off Distributed Function Terminals for which downstream loads are required.</p> <ul style="list-style-type: none"> <li>• Do an Alt 2 IML (refer to “Alt 2 IML Tests” on page 3-108) to isolate the cause of the failure.</li> </ul> <p><b>Warning:</b> An IML disrupts all operating terminals.</p> <ul style="list-style-type: none"> <li>• Request service for the control unit.</li> </ul>
	<p><b>51HG – 54HG</b> <i>A 3174 diskette error.</i></p> <ul style="list-style-type: none"> <li>• No action to be performed.</li> </ul>

- Re-IML means to try to make the control unit operational; refer to page 2-17 for the correct actions.
- When requesting service, be sure to give the status code and additional numbers to the service personnel.
- Some status codes are normal progress or completion messages; if the **Status Code** remains lit for more than 10 seconds, the code indicates an error. For an error, perform the appropriate actions.

## Status Codes

Base Status Code	Possible Additional Numbers / Explanation / Action
390	<p><b>00HG</b> <i>A 3174 diskette failure: file not found.</i></p> <ul style="list-style-type: none"><li>• Remove the diskette and check that it is the correct diskette.</li><li>• Insert the correct diskette into the drive to start again.</li><li>• If the problem occurred during IML, then re-IML.</li></ul> <p><b>Warning:</b> An IML disrupts all operating terminals.</p> <ul style="list-style-type: none"><li>• If the problem continues, repeat the procedures above with a duplicate diskette.</li><li>• Do an Alt 2 IML (refer to "Alt 2 IML Tests" on page 3-108).</li><li>• Request service for the control unit.</li></ul>
	<p><b>01HG</b> <i>A 3174 diskette failure occurred during the logging of records: file not found.</i></p> <ul style="list-style-type: none"><li>• Remove the Control diskette (usually in drive 1) and check that it really is the Control diskette.</li><li>• Insert the correct diskette into the drive to start again.</li><li>• If the problem continues, repeat the procedures above with a duplicate Control diskette.</li><li>• If the problem continues, re-IML.</li></ul> <p><b>Warning:</b> An IML disrupts all operating terminals.</p> <ul style="list-style-type: none"><li>• Do an Alt 2 IML (refer to "Alt 2 IML Tests" on page 3-108).</li><li>• Request service for the control unit.</li></ul>
	<p><b>02HG</b> <i>A 3174 diskette failure occurred after an online test was requested: file not found.</i></p> <ul style="list-style-type: none"><li>• Remove the Control diskette (usually in drive 1) and check that it really is the Control diskette.</li><li>• Insert the correct diskette into the drive and select the test again.</li><li>• If the problem continues, repeat the procedures above with a duplicate Control diskette.</li><li>• If the problem continues, re-IML.</li></ul> <p><b>Warning:</b> An IML disrupts all operating terminals.</p> <ul style="list-style-type: none"><li>• Do an Alt 2 IML (refer to "Alt 2 IML Tests" on page 3-108).</li><li>• Request service for the control unit.</li></ul>
	<p><b>03HG and 04HG</b> <i>A 3174 diskette failure occurred during an IML or customizing: file not found.</i></p> <ul style="list-style-type: none"><li>• Remove the Control diskette (usually in drive 1) and check that it really is the Control diskette.</li><li>• Insert the correct diskette into the drive and re-IML to start again.</li><li>• If the problem continues, repeat the procedures above with a duplicate Control diskette.</li><li>• Do an Alt 2 IML (refer to "Alt 2 IML Tests" on page 3-108).</li><li>• Request service for the control unit.</li></ul>

- Re-IML means to try to make the control unit operational; refer to page 2-17 for the correct actions.
- When requesting service, be sure to give the status code and additional numbers to the service personnel.
- Some status codes are normal progress or completion messages; if the **Status Code** remains lit for more than 10 seconds, the code indicates an error. For an error, perform the appropriate actions.

Base Status Code	Possible Additional Numbers / Explanation / Action
390 (cont.)	<p><b>05HG</b> <i>A 3174 diskette failure occurred during a Downstream Load (DSL): file not found.</i></p> <ul style="list-style-type: none"> <li>• Remove the DSL diskette (usually in drive 2) and check that it really is a DSL diskette.</li> <li>• Insert the correct diskette into the drive and power-on the Distributed Function Terminal to start again.</li> <li>• If the problem continues, repeat the procedures above with a duplicate DSL diskette.</li> <li>• If the problem continues, re-IML.</li> </ul> <p><b>Warning:</b> An IML disrupts all operating terminals.</p> <ul style="list-style-type: none"> <li>• Do an Alt 2 IML (refer to “Alt 2 IML Tests” on page 3-108).</li> <li>• Request service for the control unit.</li> </ul>
	<p><b>06HG</b> <i>A 3174 diskette failure occurred during a DFT dump: file not found.</i></p> <ul style="list-style-type: none"> <li>• Remove the Dump diskette (usually in drive 1) and check that it really is the Dump diskette.</li> <li>• Insert the correct diskette into the drive and select the dump again.</li> <li>• If the problem continues, repeat the procedures above with a different Dump diskette.</li> <li>• If the problem continues, re-IML.</li> </ul> <p><b>Warning:</b> An IML disrupts all operating terminals.</p> <ul style="list-style-type: none"> <li>• Do an Alt 2 IML (refer to “Alt 2 IML Tests” on page 3-108).</li> <li>• Request service for the control unit.</li> </ul>
	<p><b>07HG</b> <i>A 3174 diskette failure occurred during offline diagnostics: file not found.</i></p> <ul style="list-style-type: none"> <li>• Remove the Utility diskette (usually in drive 1) and check that it is the correct diskette.</li> <li>• Insert the correct diskette into the drive, press <b>ENTER</b>, and select the test again.</li> <li>• If the problem continues, repeat the procedures above with a different Utility diskette.</li> <li>• If the problem continues, re-IML.</li> <li>• Do an Alt 2 IML (refer to “Alt 2 IML Tests” on page 3-108).</li> <li>• Request service for the control unit.</li> </ul>
	<p><b>08HG</b> <i>A 3174 failure occurred during an offline dump, and the dump has been lost.</i></p> <ul style="list-style-type: none"> <li>• Initiate the dump again at the next microcode failure.</li> <li>• Do an Alt 2 IML (refer to “Alt 2 IML Tests” on page 3-108).</li> <li>• Request service for the control unit.</li> </ul>
	<p><b>09HG</b> <i>A 3174 diskette failure occurred during an offline dump: file not found.</i></p> <ul style="list-style-type: none"> <li>• Remove the Control or Dump diskette and check that you are using the correct one.</li> <li>• Insert the correct diskette into the drive to start the dump again.</li> <li>• If the problem continues, repeat the procedures above with a different Dump diskette or a duplicate Control diskette. Note that, if you use another Dump diskette, part of the dump will be on the original diskette and the rest will be on the second diskette.</li> <li>• Do an Alt 2 IML (refer to “Alt 2 IML Tests” on page 3-108).</li> <li>• Request service for the control unit.</li> </ul>

- Re-IML means to try to make the control unit operational; refer to page 2-17 for the correct actions.
- When requesting service, be sure to give the status code and additional numbers to the service personnel.
- Some status codes are normal progress or completion messages; if the **Status Code** remains lit for more than 10 seconds, the code indicates an error. For an error, perform the appropriate actions.

## Status Codes

Base Status Code	Possible Additional Numbers / Explanation / Action
391	<p><b>00HG</b> <i>A 3174 diskette failure: a write-protect error was detected.</i></p> <ul style="list-style-type: none"><li>• Obtain a diskette that is not write-protected, or remove write-protection from the current diskette.</li><li>• Insert the diskette into the drive to start again.</li><li>• If the problem occurred during IML, then re-IML.</li></ul> <p><b>Warning:</b> An IML disrupts all operating terminals.</p> <ul style="list-style-type: none"><li>• Do an Alt 2 IML (refer to “Alt 2 IML Tests” on page 3-108).</li><li>• Request service for the control unit.</li></ul>
	<hr/> <p><b>01HG</b> <i>A 3174 diskette failure: a write-protect error was detected during the logging of records.</i></p> <ul style="list-style-type: none"><li>• Remove the Control diskette (usually in drive 1).</li><li>• Obtain a diskette that is not write-protected, or remove write-protection from the current diskette.</li><li>• Insert the diskette into the drive to start again.</li><li>• If the problem continues, repeat the procedures above with a duplicate Control diskette.</li><li>• If the problem continues, re-IML.</li></ul> <p><b>Warning:</b> An IML disrupts all operating terminals.</p> <ul style="list-style-type: none"><li>• Do an Alt 2 IML (refer to “Alt 2 IML Tests” on page 3-108).</li><li>• Request service for the control unit.</li></ul>
	<hr/> <p><b>02HG</b> <i>A 3174 diskette failure: a write-protect error was detected during an online test.</i></p> <ul style="list-style-type: none"><li>• Remove the Control diskette (usually in drive 1).</li><li>• Obtain a diskette that is not write-protected, or remove write-protection from the current diskette.</li><li>• Insert the diskette into the drive and select the test again.</li><li>• If the problem continues, repeat the procedures above with a duplicate Control diskette.</li><li>• If the problem continues, re-IML.</li></ul> <p><b>Warning:</b> An IML disrupts all operating terminals.</p> <ul style="list-style-type: none"><li>• Do an Alt 2 IML (refer to “Alt 2 IML Tests” on page 3-108).</li><li>• Request service for the control unit.</li></ul>
	<hr/> <p><b>03HG and 04HG</b> <i>A 3174 diskette failure: a write-protect error was detected during an IML or customizing.</i></p> <ul style="list-style-type: none"><li>• Remove the Control diskette (usually in drive 1).</li><li>• Obtain a diskette that is not write-protected, or remove write-protection from the current diskette.</li><li>• Insert the diskette into the drive and re-IML to start again.</li><li>• If the problem continues, repeat the procedures above with a duplicate Control diskette.</li><li>• Do an Alt 2 IML (refer to “Alt 2 IML Tests” on page 3-108).</li><li>• Request service for the control unit.</li></ul>

- Re-IML means to try to make the control unit operational; refer to page 2-17 for the correct actions.
- When requesting service, be sure to give the status code and additional numbers to the service personnel.
- Some status codes are normal progress or completion messages; if the **Status Code** remains lit for more than 10 seconds, the code indicates an error. For an error, perform the appropriate actions.

Base Status Code	Possible Additional Numbers / Explanation / Action
391 (cont.)	<p><b>05HG</b> <i>A 3174 diskette failure: a write-protect error was detected during a Downstream Load (DSL) operation.</i></p> <ul style="list-style-type: none"> <li>• Remove the DSL diskette (usually in drive 2).</li> <li>• Obtain a diskette that is not write-protected, or remove write-protection from the current diskette.</li> <li>• Insert the diskette into the drive and power-on the Distributed Function Terminal to start again.</li> <li>• If the problem continues, repeat the procedures above with a duplicate DSL diskette.</li> <li>• If the problem continues, re-IML.</li> </ul> <p><b>Warning:</b> An IML disrupts all operating terminals.</p> <ul style="list-style-type: none"> <li>• Do an Alt 2 IML (refer to “Alt 2 IML Tests” on page 3-108).</li> <li>• Request service for the control unit.</li> </ul>
	<p><b>06HG</b> <i>A 3174 diskette failure: a write-protect error was detected during an online dump.</i></p> <ul style="list-style-type: none"> <li>• Remove the Dump diskette (usually in drive 1).</li> <li>• Obtain a diskette that is not write-protected, or remove write-protection from the current diskette.</li> <li>• Insert the diskette into the drive and select the dump again.</li> <li>• If the problem continues, repeat the procedures above with a different Dump diskette.</li> <li>• If the problem continues, re-IML.</li> </ul> <p><b>Warning:</b> An IML disrupts all operating terminals.</p> <ul style="list-style-type: none"> <li>• Do an Alt 2 IML (refer to “Alt 2 IML Tests” on page 3-108).</li> <li>• Request service for the control unit.</li> </ul>
	<p><b>07HG</b> <i>A 3174 diskette failure: a write-protect error was detected during offline diagnostics.</i></p> <ul style="list-style-type: none"> <li>• Remove the Utility diskette (usually in drive 1).</li> <li>• Obtain a diskette that is not write-protected, or remove write-protection from the current diskette.</li> <li>• Insert the diskette into the drive, press <b>ENTER</b>, and select the test again.</li> <li>• If the problem continues, repeat the procedures above with a different Utility diskette.</li> <li>• If the problem continues, re-IML.</li> <li>• Do an Alt 2 IML (refer to “Alt 2 IML Tests” on page 3-108).</li> <li>• Request service for the control unit.</li> </ul>
	<p><b>08HG</b> <i>A 3174 diskette failure: a write-protect error was detected during an offline dump, and the dump has been lost.</i></p> <ul style="list-style-type: none"> <li>• Initiate the dump again at the next microcode failure. Use a different Dump diskette that is not write-protected, or remove write-protection from the current diskette.</li> <li>• Do an Alt 2 IML (refer to “Alt 2 IML Tests” on page 3-108).</li> <li>• Request service for the control unit.</li> </ul>
	<p><b>09HG</b> <i>A 3174 diskette failure: a write-protect error was detected during an offline dump.</i></p> <ul style="list-style-type: none"> <li>• Remove the Control or Dump diskette (usually in drive 1).</li> <li>• Obtain a diskette that is not write-protected, or remove write-protection from the current diskette.</li> <li>• Insert the diskette into the drive to start again.</li> <li>• Request service for the control unit.</li> </ul>

- Re-IML means to try to make the control unit operational; refer to page 2-17 for the correct actions.
- When requesting service, be sure to give the status code and additional numbers to the service personnel.
- Some status codes are normal progress or completion messages; if the **Status Code** remains lit for more than 10 seconds, the code indicates an error. For an error, perform the appropriate actions.



## Status Codes

<b>Base Status Code</b>	<b>Possible Additional Numbers / Explanation / Action</b>
392	<p><b>00HG</b> <i>A 3174 diskette error occurred.</i></p> <ul style="list-style-type: none"><li>• Remove the diskette and check that it is the correct diskette.</li><li>• Insert the diskette into the drive to start again.</li><li>• If the problem occurred during IML, then re-IML.</li></ul> <p><b>Warning:</b> An IML disrupts all operating terminals.</p> <ul style="list-style-type: none"><li>• Do an Alt 2 IML (refer to "Alt 2 IML Tests" on page 3-108).</li><li>• Request service for the control unit.</li></ul>
	<p><b>01HG</b> <i>A 3174 diskette error occurred during the logging of records.</i></p> <ul style="list-style-type: none"><li>• Remove the Control diskette (usually in drive 1).</li><li>• Insert a duplicate Control diskette into the drive to start again.</li><li>• If the problem continues, re-IML.</li></ul> <p><b>Warning:</b> An IML disrupts all operating terminals.</p> <ul style="list-style-type: none"><li>• Do an Alt 2 IML (refer to "Alt 2 IML Tests" on page 3-108).</li><li>• Request service for the control unit.</li></ul>
	<p><b>02HG</b> <i>A 3174 diskette error occurred during an online test.</i></p> <ul style="list-style-type: none"><li>• Remove the Control diskette (usually in drive 1).</li><li>• Insert a duplicate Control diskette into the drive to start again.</li><li>• If the problem continues, re-IML.</li></ul> <p><b>Warning:</b> An IML disrupts all operating terminals.</p> <ul style="list-style-type: none"><li>• Do an Alt 2 IML (refer to "Alt 2 IML Tests" on page 3-108).</li><li>• Request service for the control unit.</li></ul>

- Re-IML means to try to make the control unit operational; refer to page 4-18supp. for the correct actions.
- When requesting service, be sure to give the status code and additional numbers to the service personnel.
- Some status codes are normal progress or completion messages; if the **Status Code** remains lit for more than 10 seconds, the code indicates an error. For an error, perform the appropriate actions.

Base Status Code	Possible Additional Numbers / Explanation / Action
392 (cont.)	<p><b>03HG and 04HG</b> <i>A 3174 diskette error was detected during an IML or customizing.</i></p> <ul style="list-style-type: none"> <li>• Remove the Control diskette (usually in drive 1).</li> <li>• Insert a duplicate Control diskette into the drive and re-IML to start again.</li> <li>• Do an Alt 2 IML (refer to “Alt 2 IML Tests” on page 3-108).</li> <li>• Request service for the control unit.</li> </ul>
	<p><b>05HG</b> <i>A 3174 diskette error occurred during a Downstream Load (DSL) operation.</i></p> <ul style="list-style-type: none"> <li>• Remove the DSL diskette (usually in drive 2).</li> <li>• Insert a duplicate DSL diskette into the drive and power-on the Distributed Function Terminal to start again.</li> <li>• If the problem continues, re-IML.</li> </ul> <p><b>Warning:</b> An IML disrupts all operating terminals.</p> <ul style="list-style-type: none"> <li>• Do an Alt 2 IML (refer to “Alt 2 IML Tests” on page 3-108).</li> <li>• Request service for the control unit.</li> </ul>
	<p><b>06HG</b> <i>A 3174 diskette error occurred during an online dump.</i></p> <ul style="list-style-type: none"> <li>• Remove the Dump diskette (usually in drive 1).</li> <li>• Insert a different Dump diskette into the drive and select the dump again.</li> <li>• If the problem continues, re-IML.</li> </ul> <p><b>Warning:</b> An IML disrupts all operating terminals.</p> <ul style="list-style-type: none"> <li>• Do an Alt 2 IML (refer to “Alt 2 IML Tests” on page 3-108).</li> <li>• Request service for the control unit.</li> </ul>
	<p><b>07HG</b> <i>A 3174 diskette error occurred during diagnostics.</i></p> <ul style="list-style-type: none"> <li>• Remove the Utility diskette (usually in drive 1) and check that it really is the Utility diskette.</li> <li>• Insert a different Utility diskette into the drive, press <b>ENTER</b>, and select the test again.</li> <li>• If the problem continues, re-IML.</li> <li>• Do an Alt 2 IML (refer to “Alt 2 IML Tests” on page 3-108).</li> <li>• Request service for the control unit.</li> </ul>
	<p><b>08HG</b> <i>A 3174 diskette error was detected during an offline dump, and the dump has been lost.</i></p> <ul style="list-style-type: none"> <li>• Initiate the dump again at the next microcode failure.</li> <li>• Do an Alt 2 IML (refer to “Alt 2 IML Tests” on page 3-108).</li> <li>• Request service for the control unit.</li> </ul>

- Re-IML means to try to make the control unit operational; refer to page 4-19upp. for the correct actions.
- When requesting service, be sure to give the status code and additional numbers to the service personnel.
- Some status codes are normal progress or completion messages; if the **Status Code** remains lit for more than 10 seconds, the code indicates an error. For an error, perform the appropriate actions.

## Status Codes

<b>Base Status Code</b>	<b>Possible Additional Numbers / Explanation / Action</b>
393	<p><b>00HG</b> <i>A 3174 diskette was changed.</i></p> <ul style="list-style-type: none"><li>• Remove the diskette and check that it is the correct diskette.</li><li>• Insert the correct diskette into the drive and close the drive lever.</li><li>• If the problem occurred during IML, then re-IML.</li></ul> <p><b>Warning:</b> An IML disrupts all operating terminals.</p> <ul style="list-style-type: none"><li>• Do an Alt 2 IML (refer to "Alt 2 IML Tests" on page 3-108).</li><li>• Request service for the control unit.</li></ul>
	<p><b>01HG</b> <i>A 3174 diskette was changed during the logging of records.</i></p> <ul style="list-style-type: none"><li>• Remove the Control diskette (usually in drive 1) and check that it really is the Control diskette.</li><li>• Insert the correct diskette into the drive to start again.</li><li>• If the problem continues, re-IML.</li></ul> <p><b>Warning:</b> An IML disrupts all operating terminals.</p> <ul style="list-style-type: none"><li>• Do an Alt 2 IML (refer to "Alt 2 IML Tests" on page 3-108).</li><li>• Request service for the control unit.</li></ul>
	<p><b>02HG</b> <i>A 3174 diskette was changed during an online test.</i></p> <ul style="list-style-type: none"><li>• Remove the Control diskette (usually in drive 1) and check that it really is the Control diskette.</li><li>• Insert the correct diskette into the drive and select the test again.</li><li>• If the problem continues, re-IML.</li></ul> <p><b>Warning:</b> An IML disrupts all operating terminals.</p> <ul style="list-style-type: none"><li>• Do an Alt 2 IML (refer to "Alt 2 IML Tests" on page 3-108).</li><li>• Request service for the control unit.</li></ul>

- Re-IML means to try to make the control unit operational; refer to page 4-20upp. for the correct actions.
- When requesting service, be sure to give the status code and additional numbers to the service personnel.
- Some status codes are normal progress or completion messages; if the Status Code remains lit for more than 10 seconds, the code indicates an error. For an error, perform the appropriate actions.

Base Status Code	Possible Additional Numbers / Explanation / Action
393 (cont.)	<p><b>03HG and 04HG</b> <i>A 3174 diskette was changed during an IML or customizing.</i></p> <ul style="list-style-type: none"> <li>• Remove the Control diskette (usually in drive 1) and check that it really is the Control diskette.</li> <li>• Insert the correct diskette into the drive and re-IML to start again.</li> <li>• Do an Alt 2 IML (refer to “Alt 2 IML Tests” on page 3-108).</li> <li>• Request service for the control unit.</li> </ul>
	<p><b>05HG</b> <i>A 3174 diskette was changed while a Downstream Load (DSL) was being tried.</i></p> <p>The DSL resumes automatically.</p>
	<p><b>06HG</b> <i>A 3174 diskette was changed during a Distributed Function Terminal dump.</i></p> <p>The dump resumes automatically.</p>
	<p><b>07HG</b> <i>A 3174 diskette was changed during diagnostics; the diagnostics have ended before completion.</i></p> <ul style="list-style-type: none"> <li>• Press <b>Enter</b> to obtain the 4001 prompt, and select the test again.</li> <li>• Do an Alt 2 IML (refer to “Alt 2 IML Tests” on page 3-108).</li> <li>• Request service for the control unit.</li> </ul>
	<p><b>08HG</b> <i>A 3174 diskette was changed during an offline dump, and the dump has been lost.</i></p> <ul style="list-style-type: none"> <li>• Initiate the dump again at the next microcode failure.</li> <li>• Do an Alt 2 IML (refer to “Alt 2 IML Tests” on page 3-108).</li> <li>• Request service for the control unit.</li> </ul>

- Re-IML means to try to make the control unit operational; refer to page 4-21upp. for the correct actions.
- When requesting service, be sure to give the status code and additional numbers to the service personnel.
- Some status codes are normal progress or completion messages; if the **Status Code** remains lit for more than 10 seconds, the code indicates an error. For an error, perform the appropriate actions.

## Status Codes

Base Status Code	Possible Additional Numbers / Explanation / Action
399	<p><b>01HG</b> <i>The 3174 is configured for ASCII, but the ASCII Adapter is not installed.</i></p> <p><b>Note:</b> The 3174 is operational but will not execute ASCII functions.</p> <ul style="list-style-type: none"><li>• Request help from your technical support group or help desk.</li></ul>
	<p><b>03HG</b> <i>A 3174 diskette error occurred, and the ASCII Adapter was not initialized.</i></p> <p><b>Note:</b> The 3174 is operational but will not execute ASCII functions.</p> <ul style="list-style-type: none"><li>• Remove the diskette and check that it is the <b>3174 ASYNC Emulation Adapter</b> diskette.</li><li>• Insert this diskette into the drive.</li><li>• Re-IML.</li></ul> <p><b>Warning:</b> An IML disrupts all operating terminals.</p> <ul style="list-style-type: none"><li>• Request help from your technical support group or help desk.</li></ul>
	<p><b>04HG</b> <i>A 3174 diskette error occurred. The Control diskette is not compatible with the level of the 3174 ASYNC Emulation Adapter diskette.</i></p> <p><b>Note:</b> The 3174 is operational but will not execute ASCII functions.</p> <ul style="list-style-type: none"><li>• Obtain a Control diskette that is compatible with the <b>3174 ASYNC Emulation Adapter</b> diskette.</li><li>• Insert this Control diskette into the drive.</li><li>• Re-IML.</li></ul> <p><b>Warning:</b> An IML disrupts all operating terminals.</p> <ul style="list-style-type: none"><li>• Request help from your technical support group or help desk.</li></ul>
	<p><b>05HG</b> <i>The 3174 is still operational; however, the 3270 Terminal Adapter is missing, defective, or not properly installed.</i></p> <ul style="list-style-type: none"><li>• If you need to use the 3270 terminals, re-IML.</li></ul> <p><b>Warning:</b> An IML disrupts all operating terminals.</p> <ul style="list-style-type: none"><li>• Do an Alt 2 IML (refer to "Alt 2 IML Tests" on page 3-108).</li><li>• Request service for the control unit.</li></ul>
	<p><b>06HG</b> <i>A 3174 diskette containing ASYNC Emulation Adapter code was not found.</i></p> <p><b>Note:</b> The 3174 is operational but will not execute ASCII functions.</p> <ul style="list-style-type: none"><li>• Check that the diskettes are labeled <b>Control Diskette</b> and <b>3174 ASYNC Emulation Adapter Diskette</b>.</li><li>• Insert the correct diskettes into the drives.</li><li>• Re-IML.</li></ul> <p><b>Warning:</b> An IML disrupts all operating terminals.</p> <ul style="list-style-type: none"><li>• Request help from your technical support group or help desk.</li></ul>

- Re-IML means to try to make the control unit operational; refer to page 2-17 for the correct actions.
- When requesting service, be sure to give the status code and additional numbers to the service personnel.
- Some status codes are normal progress or completion messages; if the **Status Code** remains lit for more than 10 seconds, the code indicates an error. For an error, perform the appropriate actions.

Base Status Code	Possible Additional Numbers / Explanation / Action
399 (cont.)	<p><b>07HG</b> <i>Certain 3174 terminal users may not be able to access all the sessions that were configured.</i></p> <p><b>Note:</b> Additional storage is required.</p> <ul style="list-style-type: none"> <li>• Request help from your technical support group or help desk.</li> </ul>
	<p><b>08HG</b> <i>A missing or disconnected ASCII Adapter cable.</i></p> <ul style="list-style-type: none"> <li>• Connect or replace the adapter cable.</li> <li>• Request service for the control unit.</li> </ul>
	<p><b>09HG</b> <i>IML hardware configuration failure.</i></p> <p>A Terminal Multiplexer Adapter (TMA) is installed but does not appear to be connected to a Terminal Adapter port.</p> <ol style="list-style-type: none"> <li>1. Press <b>Advance</b> twice – the first two digits in the <b>Status</b> display (after pressing of <b>Advance</b> twice) identify the card location number of the affected TMA. Repeat this procedure, recording the first two digits that appear in the <b>Status</b> display, until the <b>Status</b> display is blank.</li> <li>2. Press the latch-release pushbutton on the left-center edge of the front door, and open the door (refer to Figure 2-1 on page 2-2, if necessary).</li> <li>3. Make sure that the jumper cables are correctly connected both to the Terminal Adapter (card location 22 [L models] or 23 [R models]) and to the top coaxial connector on the associated TMAs (possible card locations are 15, 16, 11 or 23, and 12, 17, and 24).</li> <li>4. To proceed with the IML, and to bring up those terminals that are not connected to the affected TMA(s), press <b>1</b> on the operator panel, and then press <b>Enter</b> (Continue function).</li> <li>5. Request service for the control unit.</li> </ol>
	<p><b>10HG</b> <i>A customization error occurred during IML.</i></p> <p>No action is required; the control unit is operational.</p>
401 – 420	<p><i>Host programming error.</i></p> <ul style="list-style-type: none"> <li>• Press <b>RESET</b> at the affected terminal.</li> <li>• Try the operation again.</li> <li>• If the session is terminated, initiate the session again.</li> <li>• Request help from your technical support group or help desk.</li> </ul>
421	<p><i>Program check; noncryptographic sessions may still be run.</i></p> <ul style="list-style-type: none"> <li>• Press <b>RESET</b> at the affected terminal.</li> <li>• Follow local logon and logoff procedures to establish a noncryptographic session.</li> <li>• Perform the actions given for the status codes displayed.</li> <li>• Request help from your technical support group or help desk.</li> </ul>
422 – 435	<p><i>Host programming error.</i></p> <ul style="list-style-type: none"> <li>• No recovery required at the control unit or terminals.</li> </ul> <p>The session may have to be reinitiated by the host application program.</p> <ul style="list-style-type: none"> <li>• If the problem continues, call your host programmer.</li> </ul>

- **Re-IML** means to try to make the control unit operational; refer to page 4-23upp. for the correct actions.
- **When requesting service**, be sure to give the status code and additional numbers to the service personnel.
- **Some status codes** are normal progress or completion messages; if the **Status Code** remains lit for more than 10 seconds, the code indicates an error. For an error, perform the appropriate actions.

## Status Codes

<b>Base Status Code</b>	<b>Possible Additional Numbers / Explanation / Action</b>
436	<i>Informational message: a late signal request or a stray response was received.</i> No action required.
437 – 499	<i>Host programming error.</i> <ul style="list-style-type: none"><li>• No recovery required at the control unit or terminals. The session may have to be reinitiated by the host application program. If the problem continues, call your host programmer.</li></ul>
500	No action is required, because communication is available.
501	<i>Data communication equipment failure. Wait for the condition to clear.</i> <ul style="list-style-type: none"><li>• If the problem continues, check that the modem is turned on.</li><li>• Check that the control unit/modem cable is connected.</li><li>• Do an Alt 2 IML (refer to “Alt 2 IML Tests” on page 3-108). <b>Warning:</b> An IML disrupts all operating terminals.</li><li>• Run the Communication Cable Wrap Test (refer to “Communication Adapter and Communication Cable Test” on page 3-110).</li><li>• Request service for the control unit.</li></ul>
503	<i>The Channel Interface switch is offline.</i> <ul style="list-style-type: none"><li>• Restore the <b>Channel Interface</b> switch to the <b>Online</b> position.</li><li>• If the problem continues, do an Alt 2 IML (refer to “Alt 2 IML Tests” on page 3-108).</li><li>• If the problem continues, request service for the control unit.</li></ul>

- Re-IML means to try to make the control unit operational; refer to page 2-17 for the correct actions.
- When requesting service, be sure to give the status code and additional numbers to the service personnel.
- Some status codes are normal progress or completion messages; if the **Status Code** remains lit for more than 10 seconds, the code indicates an error. For an error, perform the appropriate actions.

Base Status Code	Possible Additional Numbers / Explanation / Action
504	<p><b>01HG</b> <i>Disconnected from the line.</i></p> <p>To recover:</p> <ul style="list-style-type: none"> <li>• Establish the connection again.</li> </ul> <hr/> <p><b>02HG</b> <i>Disconnect received.</i></p> <ul style="list-style-type: none"> <li>• Wait for the condition to clear.</li> <li>• If the condition continues, request help from your technical support group or help desk.</li> </ul> <hr/> <p><b>03HG</b> <i>Normal X.21 initialization sequence.</i></p> <ul style="list-style-type: none"> <li>• Wait for the incoming call, or initiate a call.</li> </ul> <hr/> <p><b>04HG – 06HG</b> <i>X.21 problem: exceeded the maximum number of retries.</i></p> <ul style="list-style-type: none"> <li>• Call again.</li> </ul> <hr/> <p><b>07HG</b> <i>X.21 equipment error has been cleared.</i></p> <ul style="list-style-type: none"> <li>• Wait for the incoming call, or initiate a call.</li> </ul> <hr/> <p><b>08HG</b> <i>X.21 time-out.</i></p> <ul style="list-style-type: none"> <li>• Validate the status of the X.21 network.</li> </ul> <hr/> <p><b>09HG</b> <i>X.21 problem: Write Halt.</i></p> <ul style="list-style-type: none"> <li>• Record the operator panel Status display or the Communications Check number from the terminal display.</li> <li>• Use the EXT, DISC keys at the primary dial terminal to return to <b>Call Ready</b> mode.</li> <li>• Dial again.</li> <li>• Request help from your technical support group or help desk.</li> </ul> <hr/> <p><b>10HG</b> <i>X.21 problem: invalid selection sequence.</i></p> <ul style="list-style-type: none"> <li>• Record the operator panel Status display or the Communications Check number from the terminal display.</li> <li>• Use the EXT, DISC keys at the primary dial terminal to return to <b>Call Ready</b> mode.</li> <li>• Dial again.</li> <li>• Request help from your technical support group or help desk.</li> </ul> <hr/> <p><b>11HG</b> <i>Disconnect received on a nonswitched line. This disconnection was intended for a station attached to the Token-Ring.</i></p> <p>Try to reestablish the connection.</p>
505	<p><i>Host connection condition.</i></p> <ul style="list-style-type: none"> <li>• Wait for the condition to clear.</li> <li>• Call the host system support if the problem continues.</li> </ul>

- Re-IML means to try to make the control unit operational; refer to page 2-17 for the correct actions.
- When requesting service, be sure to give the status code and additional numbers to the service personnel.
- Some status codes are normal progress or completion messages; if the **Status Code** remains lit for more than 10 seconds, the code indicates an error. For an error, perform the appropriate actions.



## Status Codes

<b>Base Status Code</b>	<b>Possible Additional Numbers / Explanation / Action</b>
506	<p><i>The 3174 is in the process of connecting to the X.25 network.</i></p> <ul style="list-style-type: none"><li>• Wait for the condition to clear.</li><li>• If the condition continues, request help from your technical support group or help desk.</li></ul>
513	<p><i>Communication status (X.25 call not completed).</i></p> <ul style="list-style-type: none"><li>• If you were trying an outgoing call, try the call again.</li><li>• If an outgoing call was not tried, wait for the X.25 network to recover.</li><li>• Request help from your technical support group or help desk.</li></ul>
531, 532	<p><i>Temporary host communication condition.</i></p> <ul style="list-style-type: none"><li>• Wait for the condition to clear.</li><li>• If the condition continues, request help from your technical support group or help desk.</li></ul>
533	<p><b>01HG</b> X.25 Clear Packet was sent.</p> <p>To recover:</p> <ul style="list-style-type: none"><li>• If outgoing calls are allowed, then initiate an outgoing call.</li><li>• If outgoing calls are not allowed, then wait for an incoming call to reopen the circuit.</li></ul> <hr/> <p><b>02HG</b> X.25 Reset Packet was sent.</p> <ul style="list-style-type: none"><li>• Wait for the condition to clear.</li><li>• If the condition continues, request help from your technical support group or help desk.</li></ul> <hr/> <p><b>03HG</b> X.25 Restart Packet was sent.</p> <ul style="list-style-type: none"><li>• Wait for the condition to clear.</li><li>• If the condition continues, request help from your technical support group or help desk.</li></ul> <hr/> <p><b>04HG</b> X.25 Clear Packet was received.</p> <ul style="list-style-type: none"><li>• If outgoing calls are allowed, then initiate an outgoing call.</li><li>• If outgoing calls are not allowed, then wait for an incoming call to reopen the circuit.</li></ul> <hr/> <p><b>05HG and 06HG</b> X.25 Reset or Restart Packet was received.</p> <ul style="list-style-type: none"><li>• Wait for the condition to clear.</li><li>• If the condition continues, request help from your technical support group or help desk.</li></ul>
540	<p><i>Communication status.</i></p> <ul style="list-style-type: none"><li>• Press RESET.</li><li>• Try the operation again.</li><li>• Do an Alt 2 IML (refer to "Alt 2 IML Tests" on page 3-108).</li></ul> <p><b>Warning:</b> An IML disrupts all operating terminals.</p> <ul style="list-style-type: none"><li>• Request help from your technical support group or help desk.</li></ul>
541	<p><i>Communication status; manual intervention required at attached display station or printer.</i></p> <p>Check to see that the display station is on, the security key is not locked, or the printer has paper.</p>

- Re-IML means to try to make the control unit operational; refer to page 2-17 for the correct actions.
- When requesting service, be sure to give the status code and additional numbers to the service personnel.
- Some status codes are normal progress or completion messages; if the **Status Code** remains lit for more than 10 seconds, the code indicates an error. For an error, perform the appropriate actions.

<b>Base Status Code</b>	<b>Possible Additional Numbers / Explanation / Action</b>
550	<i>X.25 exception conditions.</i> No action is required at the control unit or at the terminals.
551	<i>X.25 information messages.</i> No action is required at the control unit or at the terminals.
553	<i>X.21/X.25 call establishment.</i> No action is required at the control unit or at the terminals.
560, 561	<i>X.21 communication status.</i> Wait for the condition to clear.
562	<b>01HG</b> <i>The X.21 'call progress' signal has been received</i> Try the call again. <b>02HG</b> <i>The X.21 network is not ready.</i> No action is required at the control unit or at the terminals. <b>03HG</b> <i>X.21 clear time-out.</i> Wait for the condition to clear.
563	<i>X.21 error condition.</i> <ul style="list-style-type: none"> <li>• Check the dial numbers of the Primary and of the 3174.</li> <li>• Use the EXT, DISC keys at the terminal to return to call-ready state.</li> <li>• Dial again.</li> <li>• Request service for the control unit.</li> </ul>

- Re-IML means to try to make the control unit operational; refer to page 2-17 for the correct actions.
- When requesting service, be sure to give the status code and additional numbers to the service personnel.
- Some status codes are normal progress or completion messages; if the **Status Code** remains lit for more than 10 seconds, the code indicates an error. For an error, perform the appropriate actions.

## Status Codes

<b>Base Status Code</b>	<b>Possible Additional Numbers / Explanation / Action</b>
580	<p><b>01HG – 03HG</b> <i>A failure occurred during the initialization of the Token-Ring Adapter.</i></p> <ul style="list-style-type: none"><li>• Re-IML.</li></ul> <p><b>Warning:</b> An IML disrupts all operating terminals.</p> <ul style="list-style-type: none"><li>• Do an Alt 2 IML (refer to “Alt 2 IML Tests” on page 3-108).</li><li>• Do the Token-Ring Adapter wrap test.</li><li>• Request help from your technical support group or help desk.</li></ul>
	<p><b>04HG</b> <i>A failure occurred during the initialization of the Token-Ring Adapter.</i></p> <ul style="list-style-type: none"><li>• Re-IML.</li></ul> <p><b>Warning:</b> An IML disrupts all operating terminals.</p> <ul style="list-style-type: none"><li>• Request help from your technical support group or help desk.</li></ul>
	<p><b>05HG – 07HG</b> <i>A failure occurred during the initialization of the Token-Ring Adapter.</i></p> <ul style="list-style-type: none"><li>• Re-IML.</li></ul> <p><b>Warning:</b> An IML disrupts all operating terminals.</p> <ul style="list-style-type: none"><li>• Do an Alt 2 IML (refer to “Alt 2 IML Tests” on page 3-108).</li><li>• Do the Token-Ring Adapter wrap test.</li><li>• Request help from your technical support group or help desk.</li></ul>
	<p><b>08HG</b> <i>The Token-Ring is inoperative.</i></p> <p>Request help from your technical support group or help desk.</p>
	<p><b>58HG</b> <i>A temporary Token-Ring error occurred.</i></p> <p>If the failure continues, request help from your technical support group or help desk.</p>
581	<p><i>The Token-Ring Adapter detected a duplicate adapter address on the ring.</i></p> <p>A unique address must be assigned to each adapter on the ring. If the address for the 3174 must be changed, the control unit must be reconfigured.</p>
583	<p><b>02HG</b> <i>A Frame Reject (FRMR) was sent because an unacceptable Token-Ring frame was received.</i></p> <p>No action is required.</p>
	<p><b>03HG</b></p> <ul style="list-style-type: none"><li>• Contact the host operator to return the link(s) to service.</li><li>• Request help from your technical support group or help desk.</li></ul>
	<p><b>04HG – 08HG</b></p> <p>No action is required.</p>
	<p><b>09HG</b> <i>Link recovery was unsuccessful.</i></p> <ul style="list-style-type: none"><li>• Contact the host operator to return the link(s) to service.</li><li>• Request help from your technical support group or help desk.</li></ul>

- Re-IML means to try to make the control unit operational; refer to page 2-17 for the correct actions.
- When requesting service, be sure to give the status code and additional numbers to the service personnel.
- Some status codes are normal progress or completion messages; if the **Status Code** remains lit for more than 10 seconds, the code indicates an error. For an error, perform the appropriate actions.

Base Status Code	Possible Additional Numbers / Explanation / Action
584	<p><i>A Token-Ring Adapter counter overflowed.</i></p> <ul style="list-style-type: none"> <li>• No actions are required if the control unit is operating normally. If the control unit is not operating normally, go to the next step.</li> <li>• Do an Alt 2 IML (refer to “Alt 2 IML Tests” on page 3-108).</li> </ul> <p><b>Warning:</b> An IML disrupts all operating terminals.</p> <ul style="list-style-type: none"> <li>• Request help from your technical support group or help desk.</li> </ul>
590	<p><i>Communication problem at the Distributed Function Terminal.</i></p> <ul style="list-style-type: none"> <li>• Switch terminal power off, then on.</li> <li>• Refer to the terminal Problem Determination Guide.</li> <li>• Perform the terminal problem determination procedures.</li> </ul>
599	<p><i>Communication status (Local mode).</i></p> <p>Press the COMM key at the affected terminal to exit local mode.</p>
600 – 699	<p><b>1X Permanent machine check detected by a DFT.</b></p> <p>Refer to the terminal Problem Determination Guide.</p> <hr/> <p><b>5X Temporary machine check detected by a DFT.</b></p> <p>Refer to the terminal Problem Determination Guide.</p>
700 – 799	<p><i>Program check detected by a DFT.</i></p> <p>Refer to the terminal Problem Determination Guide.</p>
802	<p><b>01HG Not authorized to access another host from the Connection Menu.</b></p> <p>Change customization to authorize access, or select the default host.</p> <hr/> <p><b>02HG – 05HG A temporary condition is blocking your request.</b></p> <p>Wait for a few minutes and try again.</p> <hr/> <p><b>06HG The PF3 (Quit) key was pressed, but the previous host to return to does not exist.</b></p> <p>Select a host for your return request.</p> <hr/> <p><b>07HG</b></p> <p>The port connection you request already exists.</p> <hr/> <p><b>08HG A printer powered off because it could not connect to the host.</b></p> <ul style="list-style-type: none"> <li>• Wait for a few minutes and power on. Keep trying this until a connection is made to the host.</li> <li>• If the condition continues, request help from your technical support group or help desk.</li> </ul>

- Re-IML means to try to make the control unit operational; refer to page 2-17 for the correct actions.
- When requesting service, be sure to give the status code and additional numbers to the service personnel.
- Some status codes are normal progress or completion messages; if the **Status Code** remains lit for more than 10 seconds, the code indicates an error. For an error, perform the appropriate actions.

## Status Codes

<b>Base Status Code</b>	<b>Possible Additional Numbers / Explanation / Action</b>
803	<p><b>01HG</b> <i>The wrong keyboard was used with the 3270 terminal in session with the ASCII host.</i></p> <p>Use one of these supported keyboards:</p> <ul style="list-style-type: none"><li>• US English Typewriter keyboards</li><li>• APL keyboards</li><li>• Text keyboards</li></ul>
	<hr/> <p><b>02HG – 03HG</b></p> <p>Make sure that you are using the correct entry from the Connection Menu.</p>
	<hr/> <p><b>04HG</b> <i>An invalid key was pressed.</i></p> <ul style="list-style-type: none"><li>• Try again.</li><li>• If the message is repeated, check the keyboard map found in the <i>Terminal User's Guide</i>, GA23-0332.</li><li>• Request help from your technical support group or help desk.</li></ul>
804	<p><i>A timeout occurred in the ASCII Adapter.</i></p> <ul style="list-style-type: none"><li>• Wait and try again.</li><li>• If this message recurs, request help from your technical support group or help desk.</li></ul>
805	<p><i>An incorrect password was used.</i></p> <p>Follow the local recovery procedures.</p>
806	<p><i>An ASCII buffer has overrun.</i></p> <p>Request help from your technical support group or help desk.</p>
807 and 808	<p><i>The ASCII Adapter has timed out.</i></p> <ul style="list-style-type: none"><li>• Make sure that the terminal is turned on and its cable is connected.</li><li>• Verify that the ASCII port type was customized correctly.</li><li>• Use Test 12, Option 1,2 (refer to “Procedure H – All Connections to ASCII Adapter Are Failing” on page 3-57) to perform the AEA Port Wrap Test on the ASCII Adapter port (HG and port) indicated in the terminal message.</li><li>• Request help from your technical support group or help desk.</li></ul>
809	<p><i>The ASCII Adapter was disconnected from the terminal or host.</i></p> <p><b>Note:</b> If this was a normal disconnect from the ASCII host, no action is required.</p> <ul style="list-style-type: none"><li>• Make sure that the terminal is turned on and its cable is connected.</li><li>• Use Test 12, Option 1,2 (refer to “Procedure H – All Connections to ASCII Adapter Are Failing” on page 3-57) to perform the AEA Port Wrap Test on the ASCII Adapter port (HG and port) indicated in the terminal message.</li><li>• Request help from your technical support group or help desk.</li></ul>

- Re-IML means to try to make the control unit operational; refer to page 2-17 for the correct actions.
- When requesting service, be sure to give the status code and additional numbers to the service personnel.
- Some status codes are normal progress or completion messages; if the **Status Code** remains lit for more than 10 seconds, the code indicates an error. For an error, perform the appropriate actions.

Base Status Code	Possible Additional Numbers / Explanation / Action
810	<p><i>The ASCII Adapter was disconnected from the terminal or host.</i></p> <p><b>Note:</b> If this was a normal logoff procedure from the ASCII host, no action is required.</p> <ul style="list-style-type: none"> <li>• Make sure that the terminal is turned on and its cable is connected.</li> <li>• Check the phone connection.</li> <li>• Verify that the modem cabling is correct.</li> <li>• Use Test 12, Option 1,2 (refer to “Procedure H – All Connections to ASCII Adapter Are Failing” on page 3-57) to perform the AEA Port Wrap Test on the ASCII Adapter port (HG and port) indicated in the terminal message.</li> <li>• Request help from your technical support group or help desk.</li> </ul>
811	<p><i>The ASCII Adapter has not received a <b>Ready</b> signal from the modem.</i></p> <ul style="list-style-type: none"> <li>• Make sure that the correct modem is installed and properly set up, and that the modem cabling is correct.</li> <li>• Make sure that the control unit is properly customized for the modem.</li> <li>• Run the modem manufacturer’s diagnostic tests.</li> <li>• Use Test 12, Option 1,2 (refer to “Procedure H – All Connections to ASCII Adapter Are Failing” on page 3-57) to perform the AEA Port Wrap Test on the ASCII Adapter port (HG and port) indicated in the terminal message.</li> <li>• Request help from your technical support group or help desk.</li> </ul>
812	<p><i>The ASCII Adapter has exhausted connection retries.</i></p> <ul style="list-style-type: none"> <li>• Make sure that the correct modem is installed and properly set up, and that the modem cabling is correct.</li> <li>• Call the host number on a voice phone to check the remote modem.</li> <li>• Make sure that the dial digits, specified during customization, are correct.</li> <li>• Use Test 12, Option 1,2 (refer to “Procedure H – All Connections to ASCII Adapter Are Failing” on page 3-57) to perform the AEA Port Wrap Test on the ASCII Adapter port (HG and port) indicated in the terminal message.</li> <li>• Request help from your technical support group or help desk.</li> </ul>
813	<p><i>The modem has received an invalid command from the ASCII Adapter.</i></p> <ul style="list-style-type: none"> <li>• Make sure that the correct modem is installed and properly set up, and that the modem cabling is correct.</li> <li>• Make sure that the control unit is properly customized for the modem.</li> <li>• Make sure that the dial digits, specified during customization, conform to the modem requirements. Include pauses in the Dial String if they are required to allow for intermediate dial tones.</li> <li>• Run the modem manufacturer’s diagnostic tests.</li> <li>• Request help from your technical support group or help desk.</li> </ul>
814	<p><i>The ASCII Adapter has not received a Character Echo from the modem.</i></p> <ul style="list-style-type: none"> <li>• Make sure that the correct modem is installed and properly set up, and that the modem cabling is correct.</li> <li>• Make sure that the modem matches the type specified during customization.</li> <li>• Run the modem manufacturer’s diagnostic tests.</li> <li>• Use Test 12, Option 1,2 (refer to “Procedure H – All Connections to ASCII Adapter Are Failing” on page 3-57) to perform the AEA Port Wrap Test on the ASCII Adapter port (HG and port) indicated in the terminal message.</li> <li>• Request help from your technical support group or help desk.</li> </ul>

- Re-IML means to try to make the control unit operational; refer to page 2-17 for the correct actions.
- When requesting service, be sure to give the status code and additional numbers to the service personnel.
- Some status codes are normal progress or completion messages; if the **Status Code** remains lit for more than 10 seconds, the code indicates an error. For an error, perform the appropriate actions.

## Status Codes

Base Status Code	Possible Additional Numbers / Explanation / Action
815	<p><i>A call came in while an outgoing call was in progress.</i></p> <ul style="list-style-type: none"><li>• Retry the call.</li><li>• Make sure that the modem cabling is correct.</li><li>• Run the modem manufacturer's diagnostic tests.</li><li>• Use Test 12, Option 1,2 (refer to "Procedure H – All Connections to ASCII Adapter Are Failing" on page 3-57) to perform the AEA Port Wrap Test on the ASCII Adapter port (HG and port) indicated in the terminal message.</li><li>• Request help from your technical support group or help desk.</li></ul>
816	<p><i>A 3174 ASCII Adapter received an incoming call, but the answering sequence was not completed.</i></p> <ul style="list-style-type: none"><li>• Make sure that the modem cabling is correct.</li><li>• Run the modem manufacturer's diagnostic tests.</li><li>• Use Test 12, Option 1,2 (refer to "Procedure H – All Connections to ASCII Adapter Are Failing" on page 3-57) to perform the AEA Port Wrap Test on the ASCII Adapter port (HG and port) indicated in the terminal message.</li><li>• Request help from your technical support group or help desk.</li></ul>
817	<p><i>An ASCII status counter overflowed.</i></p> <ul style="list-style-type: none"><li>• Use the Refresh Sequence (see the keyboard map) to request retransmission.</li><li>• Make sure that the parity and the number of stop bits were specified correctly during customization.</li><li>• Make sure that the modem cabling is correct.</li><li>• Run the modem manufacturer's diagnostic tests.</li><li>• Use Test 12, Option 1,2 (refer to "Procedure H – All Connections to ASCII Adapter Are Failing" on page 3-57) to perform the AEA Port Wrap Test on the ASCII Adapter port (HG and port) indicated in the terminal message.</li><li>• Request help from your technical support group or help desk.</li></ul>
818	<p><i>The Break key was pressed, and the session was disconnected.</i></p> <ul style="list-style-type: none"><li>• There is no recovery action.</li></ul> <p>A new connection may be requested.</p>
819	<p><i>The ASCII Adapter could not reset the modem.</i></p> <ul style="list-style-type: none"><li>• Make sure that the correct modem is installed and properly set up, and that the modem cabling is correct.</li><li>• Make sure that the control unit is properly customized for the modem.</li><li>• Run the modem manufacturer's diagnostic tests.</li><li>• Use Test 12, Option 1,2 (refer to "Procedure H – All Connections to ASCII Adapter Are Failing" on page 3-57) to perform the AEA Port Wrap Test on the ASCII Adapter port (HG and port) indicated in the terminal message.</li><li>• Request help from your technical support group or help desk.</li></ul>

- Re-IML means to try to make the control unit operational; refer to page 2-17 for the correct actions.
- When requesting service, be sure to give the status code and additional numbers to the service personnel.
- Some status codes are normal progress or completion messages; if the **Status Code** remains lit for more than 10 seconds, the code indicates an error. For an error, perform the appropriate actions.

Base Status Code	Possible Additional Numbers / Explanation / Action
820	<p data-bbox="365 283 803 304"><i>An ASCII Adapter communications error.</i></p> <ul data-bbox="381 325 1472 483" style="list-style-type: none"> <li>• Use Test 12, Option 1,2 (refer to “Procedure H – All Connections to ASCII Adapter Are Failing” on page 3-57) to perform the AEA Port Wrap Test on the ASCII Adapter port (HG and port) indicated in the terminal message.</li> <li>• Run the modem manufacturer’s diagnostic tests.</li> <li>• Request help from your technical support group or help desk.</li> </ul>
821	<p data-bbox="365 493 1226 514"><b>10HG</b> <i>The session was dropped because the ASCII Adapter bit rate was exceeded.</i></p> <ul data-bbox="381 535 1193 661" style="list-style-type: none"> <li>• If the port type is Direct or Nonswitched, press the Carriage-Return key.</li> <li>• If the port type is Switched, dial again.</li> <li>• If the problem continues, power the terminal <b>OFF</b> and <b>ON</b>.</li> <li>• Request help from your technical support group or help desk.</li> </ul> <hr/> <p data-bbox="365 693 1226 714"><b>20HG</b> <i>The session was dropped because the ASCII Adapter bit rate was exceeded.</i></p> <ul data-bbox="381 735 1071 808" style="list-style-type: none"> <li>• Select a host from the Connection Menu.</li> <li>• Request help from your technical support group or help desk.</li> </ul>
880	<p data-bbox="365 819 1274 840"><b>01HG – 03HG</b> <i>A failure occurred during the initialization of the Token-Ring Adapter.</i></p> <ul data-bbox="381 861 1079 924" style="list-style-type: none"> <li>• Contact the host operator to return the link(s) to service.</li> <li>• Do an Alt 2 IML (refer to “Alt 2 IML Tests” on page 3-108).</li> </ul> <p data-bbox="414 934 966 966"><b>Warning:</b> An IML disrupts all operating terminals.</p> <ul data-bbox="381 987 1372 1081" style="list-style-type: none"> <li>• Do the Token-Ring Adapter wrap test (refer to “Token-Ring Adapter and Cable Test” on page 3-114)</li> <li>• Request help from your technical support group or help desk.</li> </ul> <hr/> <p data-bbox="365 1102 1177 1134"><b>04HG</b> <i>A failure occurred during the initialization of the Token-Ring Adapter.</i></p> <p data-bbox="365 1144 1031 1176">Request help from your technical support group or help desk.</p> <hr/> <p data-bbox="365 1197 1274 1228"><b>05HG – 07HG</b> <i>A failure occurred during the initialization of the Token-Ring Adapter.</i></p> <ul data-bbox="381 1249 1079 1365" style="list-style-type: none"> <li>• Contact the host operator to return the link(s) to service.</li> <li>• Do an Alt 2 IML (refer to “Alt 2 IML Tests” on page 3-108).</li> <li>• Do the Token-Ring Adapter wrap test.</li> <li>• Request help from your technical support group or help desk.</li> </ul> <hr/> <p data-bbox="365 1396 1015 1428"><b>08HG</b> <i>The Token-Ring is inoperative – permanent beaconing.</i></p> <p data-bbox="365 1438 1031 1470">Request help from your technical support group or help desk.</p> <hr/> <p data-bbox="365 1480 430 1512"><b>58HG</b></p> <p data-bbox="365 1522 1015 1554"><i>A temporary beaconing condition occurred on the Token-Ring.</i></p> <p data-bbox="365 1564 1274 1596">If the failure continues, request help from your technical support group or help desk.</p>
881	<p data-bbox="365 1617 1144 1648"><i>The Token-Ring Adapter detected a duplicate adapter address on the ring.</i></p> <p data-bbox="365 1659 1437 1724">A unique address must be assigned to each adapter on the ring. If the address for the 3174 must be changed, the control unit has to be configured again.</p>

- Re-IML means to try to make the control unit operational; refer to page 2-17 for the correct actions.
- When requesting service, be sure to give the status code and additional numbers to the service personnel.
- Some status codes are normal progress or completion messages; if the **Status Code** remains lit for more than 10 seconds, the code indicates an error. For an error, perform the appropriate actions.



## Status Codes

<b>Base Status Code</b>	<b>Possible Additional Numbers / Explanation / Action</b>
883	<p><b>01HG</b> <i>The gateway address or the Token-Ring Adapter address is invalid.</i></p> <p>Contact the system programmer.</p> <hr/> <p><b>02HG – 08HG</b></p> <ul style="list-style-type: none"><li>• Contact the host operator to return the link(s) to service.</li><li>• If the failure continues, request help from your technical support group or help desk.</li></ul> <hr/> <p><b>60HG</b></p> <p>If the control unit is not working correctly, request help from your technical support group or help desk.</p>
884	If the control unit is not working correctly, request help from your technical support group or help desk.
890	<p><i>The Ring Error Monitor has detected a problem.</i></p> <p>Request help from your technical support group or help desk.</p>
1001, 1002	<p><i>IML microcode failure.</i></p> <ul style="list-style-type: none"><li>• Insert the backup Control or Utility diskette.</li><li>• Re-IML.</li><li>• Request help from your technical support group or help desk.</li></ul>
1003, 1004	<p><i>IML hardware failure: diskette or diskette drive.</i></p> <ul style="list-style-type: none"><li>• Insert the backup Control or Utility diskette.</li><li>• Re-IML.</li><li>• Request help from your technical support group or help desk.</li></ul>
1005	<p><i>An Alt 1 IML was performed, using a diskette other than the Control or Utility diskette.</i></p> <ul style="list-style-type: none"><li>• Insert the correct Control or Utility diskette.</li><li>• Correct the Alt 1 IML diskette selection parameter.</li><li>• Re-IML.</li><li>• Request help from your technical support group or help desk.</li></ul>
1011	<p><i>IML microcode failure.</i></p> <ul style="list-style-type: none"><li>• Insert the backup Control or Utility diskette.</li><li>• Re-IML.</li><li>• Request help from your technical support group or help desk.</li></ul>
1048 – 1058	<p><i>IML hardware failure.</i></p> <ul style="list-style-type: none"><li>• Re-IML.</li><li>• Request service for the control unit.</li></ul>
1060 – 1079	<p><i>IML hardware or microcode failure.</i></p> <ul style="list-style-type: none"><li>• Insert the backup Control or Utility diskette.</li><li>• Re-IML.</li><li>• Request service for the control unit.</li></ul>

- Re-IML means to try to make the control unit operational; refer to page 2-17 for the correct actions.
- When requesting service, be sure to give the status code and additional numbers to the service personnel.
- Some status codes are normal progress or completion messages; if the **Status Code** remains lit for more than 10 seconds, the code indicates an error. For an error, perform the appropriate actions.

Base Status Code	Possible Additional Numbers / Explanation / Action
2001 – 2087	<i>The offline test was completed successfully.</i> At the operator panel, press Enter for the 4001 prompt, or do an IML to exit testing mode.
21HG	<i>Offline test in progress. A failure occurred if the status code does not change for more than 10 seconds.</i> <b>Note:</b> 21HG will alternate with 22HG during the running of this test. <ul style="list-style-type: none"> <li>• Re-IML and try the test again.</li> <li>• Request service for the control unit.</li> </ul>
22HG	<i>Offline test in progress; a failure occurred if the status code does not change for more than 10 seconds.</i> <b>Note:</b> 22HG will alternate with 21HG during the running of this test. <ul style="list-style-type: none"> <li>• Re-IML and try the test again.</li> <li>• Request service for the control unit.</li> </ul>
2587	<i>Offline tests from a Control diskette have been completed successfully.</i> <b>Note:</b> Not all offline tests are on the Control diskette. <b>Use the Utility diskette to run a complete set of tests.</b> Re-IML to exit test mode.
2901 – 2987	<i>Offline test hardware failure.</i> <ul style="list-style-type: none"> <li>• Keep pressing the <b>Advance</b> key until the display is blank, and record all the numbers that appeared in the <b>Status</b> display each time you pressed the key.</li> <li>• Request service for the control unit.</li> </ul>
3001 – 3012	<i>Offline test hardware failure.</i> <ul style="list-style-type: none"> <li>• Keep pressing the <b>Advance</b> key until the display is blank, and record all the numbers that appeared in the <b>Status</b> display each time you pressed the key.</li> <li>• Request service for the control unit.</li> </ul>
3020 – 3025	<i>Offline test hardware failure: diskette drive or media.</i> <ul style="list-style-type: none"> <li>• Install another Utility diskette in drive 1, and then another Control diskette in drive 2, and try the test again.</li> <li>• Request service for the control unit.</li> </ul>

- **Re-IML** means to try to make the control unit operational; refer to page 2-17 for the correct actions.
- **When** requesting service, be sure to give the status code and additional numbers to the service personnel.
- **Some** status codes are normal progress or completion messages; if the **Status Code** remains lit for more than 10 seconds, the code indicates an error. For an error, perform the appropriate actions.

## Status Codes

<b>Base Status Code</b>	<b>Possible Additional Numbers / Explanation / Action</b>
3030	<p><b>01HG</b> <i>Offline test modem wrap failure.</i></p> <ul style="list-style-type: none"><li>• Keep pressing the <b>Advance</b> key until the display is blank, and record all the numbers that appeared in the <b>Status</b> display each time you pressed the key.</li><li>• Perform the Communication Cable Wrap Test (refer to “Communication Adapter and Communication Cable Test” on page 3-110).</li><li>• Request help from your technical support group or help desk.</li></ul> <hr/> <p><b>02HG</b> <i>Offline test communication cable wrap failure: A cable is not connected.</i></p> <ul style="list-style-type: none"><li>• Verify that the cable is a valid 3174 communication cable. Valid cable part numbers are 6168155, 6423153, 6423155, 6423157, 6423325, and 6423326.</li><li>• Verify that the cable is correctly attached.</li><li>• Try the test again.</li><li>• Request help from your technical support group or help desk.</li></ul> <hr/> <p><b>03HG</b> <i>Offline test communication cable wrap failure: An incorrect cable is connected to a Type 2 Communication Adapter.</i></p> <ul style="list-style-type: none"><li>• Connect the Type 2 cable to the Type 2 Communication Adapter. Refer to “Communication Adapter and Communication Cable Test” on page 3-110 for the port numbers.</li><li>• Request help from your technical support group or help desk.</li></ul> <hr/> <p><b>04HG</b> <i>Offline test communication cable wrap failure: An incorrect cable is connected to a Type 1 Communication Adapter.</i></p> <ul style="list-style-type: none"><li>• Connect the Type 1 cable to the Type 1 Communication Adapter. Refer to “Communication Adapter and Communication Cable Test” on page 3-110 for the port numbers.</li><li>• Request help from your technical support group or help desk.</li></ul> <hr/> <p><b>2xHG</b></p> <p><b>Note:</b> Make sure that the cable switches are set to test.</p> <ul style="list-style-type: none"><li>• Keep pressing the <b>Advance</b> key until the display is blank, and record all the numbers that appeared in the <b>Status</b> display each time you pressed the key.</li><li>• Request service for the control unit.</li></ul>

- Re-IML means to try to make the control unit operational; refer to page 2-17 for the correct actions.
- When requesting service, be sure to give the status code and additional numbers to the service personnel.
- Some status codes are normal progress or completion messages; if the **Status Code** remains lit for more than 10 seconds, the code indicates an error. For an error, perform the appropriate actions.

Base Status Code	Possible Additional Numbers / Explanation / Action
3040	<p><b>01HG PN00</b> <i>Terminal Adapter port failed an offline wrap test.</i> (PN = Terminal Adapter port number)</p> <p><b>Note:</b> Make sure that the cable was disconnected from the port being tested.</p> <ul style="list-style-type: none"> <li>• Keep pressing the <b>Advance</b> key until the display is blank, and record all the numbers that appeared in the <b>Status</b> display each time you pressed the key.</li> <li>• Request service for the control unit.</li> </ul>
	<hr/> <p><b>02HG PNMP</b> <i>TMA/3299 port failed an offline wrap test.</i> (PN = Terminal Adapter port number) (MP = Multiplexer port number)</p> <p><b>Note:</b> Make sure that the cable was disconnected from the port being tested.</p> <ul style="list-style-type: none"> <li>• Request help from your technical support group or help desk.</li> </ul>
3041	<p><i>Terminal Adapter path test to a terminal has failed.</i></p> <p><b>Note:</b> Make sure that the terminal is turned on.</p> <ul style="list-style-type: none"> <li>• Check the connection between the terminal and the 3174. Refer to “3270 Terminal Connection Problems” on page 3-13.</li> <li>• Request help from your technical support group or help desk.</li> </ul>
3042	<p><b>01HG PN00</b> <i>Offline display/printer Exerciser test failure (path was direct).</i> (PN = Terminal Adapter port number)</p> <ul style="list-style-type: none"> <li>• Refer to the display/printer Problem Determination Guide.</li> <li>• Request help from your technical support group or help desk.</li> </ul>
	<hr/> <p><b>02HG PNMP</b> <i>Offline Display/Printer Exerciser test failure (path through TMA/3299).</i> (PN = Terminal Adapter port number) (MP = Multiplexer port number)</p> <ul style="list-style-type: none"> <li>• Refer to the display/printer Problem Determination Guide.</li> <li>• Request help from your technical support group or help desk.</li> </ul>
3043	<p><i>Terminal Adapter has failed.</i></p> <ul style="list-style-type: none"> <li>• Keep pressing the <b>Advance</b> key until the display is blank, and record all the numbers that appeared in the <b>Status</b> display each time you pressed the key.</li> <li>• Re-IML.</li> <li>• Request service for the control unit.</li> </ul>

- Re-IML means to try to make the control unit operational; refer to page 2-17 for the correct actions.
- When requesting service, be sure to give the status code and additional numbers to the service personnel.
- Some status codes are normal progress or completion messages; if the **Status Code** remains lit for more than 10 seconds, the code indicates an error. For an error, perform the appropriate actions.

## Status Codes

Base Status Code	Possible Additional Numbers / Explanation / Action
3050	<p><b>01HG</b> <i>Offline Token-Ring Adapter cable wrap test failure; there is an open condition.</i></p> <ul style="list-style-type: none"><li>• Check that the Token-Ring Adapter cable is correctly attached to the adapter. If the cable is correctly connected, a problem exists in the cable path to the Token-Ring access unit or in the access unit itself.</li><li>• To troubleshoot, disconnect the cable at various points, except from the adapter, and retry the test. To retry the wrap test, press <b>Enter</b> on the operator panel, key in the test selection (3101), and press <b>Enter</b>.</li><li>• If the cable directly connected to the Token-Ring adapter fails, then request service for the control unit.</li></ul>
	<p><b>02HG</b> <i>Offline Token-Ring Adapter cable wrap test failure; the wrap data is incorrect.</i></p> <ul style="list-style-type: none"><li>• Check all cable connections for proper seating; reseal any loose connections.</li><li>• To troubleshoot, disconnect the cable at various points, except from the adapter, and retry the test. To retry the wrap test, press <b>Enter</b> on the operator panel, key in the test selection (3101), and press <b>Enter</b>.</li><li>• If the cable directly connected to the Token-Ring Adapter fails, then request service for the control unit.</li></ul>
3060, 3061	<p><i>There may be a loose or disconnected internal adapter cable between the ASCII Adapter and the I/O Panel.</i></p> <ul style="list-style-type: none"><li>• Keep pressing the <b>Advance</b> key until the display is blank, and record all the numbers that appeared in the <b>Status</b> display each time you pressed the key.</li><li>• Re-IML.</li><li>• Request service for the control unit.</li></ul>
3091 – 3170	<p><i>Offline test hardware failure: storage.</i></p> <ul style="list-style-type: none"><li>• Keep pressing the <b>Advance</b> key until the display is blank, and record all the numbers that appeared in the <b>Status</b> display each time you pressed the key.</li><li>• Re-IML.</li><li>• Request service for the control unit.</li></ul>
3174	<p><i>Indicates that a normal IML was completed successfully, or that no error status codes are present.</i></p>
3180	<p><i>Offline test hardware failure.</i></p> <ul style="list-style-type: none"><li>• Keep pressing the <b>Advance</b> key until the display is blank, and record all the numbers that appeared in the <b>Status</b> display each time you pressed the key.</li><li>• Re-IML.</li><li>• Request service for the control unit.</li></ul>
3201 – 3203	<p><i>IML hardware failure: FRU identification bus.</i></p> <ul style="list-style-type: none"><li>• Re-IML.</li><li>• Request service for the control unit.</li></ul>

- Re-IML means to try to make the control unit operational; refer to page 2-17 for the correct actions.
- When requesting service, be sure to give the status code and additional numbers to the service personnel.
- Some status codes are normal progress or completion messages; if the **Status Code** remains lit for more than 10 seconds, the code indicates an error. For an error, perform the appropriate actions.

Base Status Code	Possible Additional Numbers / Explanation / Action
3204	<p><i>IML hardware configuration failure: excess storage cards.</i></p> <ul style="list-style-type: none"> <li>• If you are doing a feature installation, recheck the instructions.</li> <li>• Keep pressing the <b>Advance</b> key until the display is blank, and record all the numbers that appeared in the <b>Status</b> display each time you pressed the key.</li> <li>• Re-IML.</li> <li>• Request service for the control unit.</li> </ul>
3205	<p><i>IML hardware configuration failure: invalid storage card plugging.</i></p> <p>For 3174 Models 1L, 1R, 2R, and 3R, a storage card is in location 17, and location 20 either is empty or has a nonstorage card installed.</p> <ul style="list-style-type: none"> <li>• If you are doing a feature installation, recheck the instructions.</li> <li>• Keep pressing the <b>Advance</b> key until the display is blank, and record all the numbers that appeared in the <b>Status</b> display each time you pressed the key.</li> <li>• Re-IML.</li> <li>• Request service for the control unit.</li> </ul>
3220	<p><i>IML hardware configuration failure: invalid diskette ID.</i></p> <ul style="list-style-type: none"> <li>• To proceed with IML, press <b>1</b> on the operator panel, and then press <b>Enter</b>.</li> <li>• Request service for the control unit.</li> </ul>
3221	<p><i>IML hardware configuration failure: The Channel Adapter or Driver is missing.</i></p> <ul style="list-style-type: none"> <li>• If you are doing a feature installation, recheck the instructions.</li> <li>• Verify that a Channel Adapter (Type 9210) is plugged into location 11 and a Channel Driver (Type 9230) is plugged into location 10.</li> <li>• To proceed with IML, press <b>1</b> on the operator panel, and then press <b>Enter</b>.</li> <li>• Request service for the control unit.</li> </ul>
3222	<p><i>IML hardware configuration failure: invalid adapter configuration.</i></p> <ul style="list-style-type: none"> <li>• If you are doing a feature installation, recheck the instructions.</li> <li>• Verify that the cards are plugged into locations 22, 23, and 24 in the correct order and that they are valid cards.</li> <li>• To proceed with IML, press <b>1</b> on the operator panel, and then press <b>Enter</b>.</li> <li>• Request service for the control unit.</li> </ul>
3223	<p><i>IML hardware configuration failure: invalid adapter card is installed.</i></p> <ul style="list-style-type: none"> <li>• If you are doing a feature installation, recheck the instructions.</li> <li>• Verify that the cards in locations 11 through 17 are valid.</li> <li>• Keep pressing the <b>Advance</b> key until the display is blank, and record all the numbers that appeared in the <b>Status</b> display each time you pressed the key. These numbers identify which cards are invalid.</li> <li>• To proceed with IML, press <b>1</b> on the operator panel, and then press <b>Enter</b>.</li> <li>• Request service for the control unit.</li> </ul>
3230 – 3232	<p><i>IML hardware failure: Terminal Adapter.</i></p> <ul style="list-style-type: none"> <li>• Keep pressing the <b>Advance</b> key until the display is blank, and record all the numbers that appeared in the <b>Status</b> display each time you pressed the key.</li> <li>• To proceed with IML, press <b>1</b> on the operator panel, and then press <b>Enter</b>.</li> <li>• Request service for the control unit.</li> </ul>

- Re-IML means to try to make the control unit operational; refer to page 2-17 for the correct actions.
- When requesting service, be sure to give the status code and additional numbers to the service personnel.
- Some status codes are normal progress or completion messages; if the **Status Code** remains lit for more than 10 seconds, the code indicates an error. For an error, perform the appropriate actions.

## Status Codes

Base Status Code	Possible Additional Numbers / Explanation / Action
3233	<p><i>IML hardware configuration failure.</i></p> <p>A Terminal Multiplexer Adapter (TMA) is installed but does not appear to be connected to a Terminal Adapter port.</p> <ol style="list-style-type: none"><li>1. If you are installing a feature, press <b>Advance</b> twice – the first two digits in the <b>Status</b> display identify the card location number of the affected TMA. Repeat this procedure, recording the first two digits that appear in the <b>Status</b> display until the <b>Status</b> display is blank.</li><li>2. Press the latch-release pushbutton on the left-center edge of the front door, and open the door (refer to Figure 2-1 on page 2-2, if necessary).</li><li>3. Make sure that the jumper cables are correctly connected both to the Terminal Adapters (Type 915X, card locations 21, 22, and 23) and to the top coaxial connector on the associated TMAs (possible card locations are 15, 16, 11 or 23, and 12, 17, and 24).</li><li>4. To proceed with the IML, and to bring up those terminals that are not connected to the affected TMA(s), press <b>1</b> on the operator panel, and then press <b>Enter</b> (Continue function).</li><li>5. Request service for the control unit.</li></ol>
3234	<p><i>IML hardware configuration failure: undefined ID.</i></p> <p>The hardware is at a higher release level than the microcode.</p> <ul style="list-style-type: none"><li>• Obtain the latest level of Control and Utility diskettes and re-IML.</li><li>• Request help from your technical support group or help desk.</li></ul>
3235	<p><i>The internal cable between the Token-Ring Adapter and the I/O assembly is not connected.</i></p> <p>Request help from your technical support group or help desk.</p>
3250 – 3297	<p><i>IML hardware failure.</i></p> <ul style="list-style-type: none"><li>• Re-IML.</li><li>• Request service for the control unit.</li></ul>
3301	<p><i>Offline test failure: Port 0 control terminal.</i></p> <ul style="list-style-type: none"><li>• Check that the Port 0 control terminal is turned on.</li><li>• Use “3270 Terminal Connection Problems” on page 3-13 to identify connection or terminal problems.</li><li>• Request help from your technical support group or help desk.</li></ul>
3302	<p><i>Offline test failure: Terminal Adapter.</i></p> <ul style="list-style-type: none"><li>• Use the operator panel to continue testing.</li><li>• Run Alt 2 IML tests (refer to “Alt 2 IML Tests” on page 3-108).</li></ul>
3801 – 3809	<p><i>Offline test microcode failure.</i></p> <ul style="list-style-type: none"><li>• Keep pressing the <b>Advance</b> key until the display is blank, and record all the numbers that appeared in the <b>Status</b> display each time you pressed the key.</li><li>• Insert a new diskette and try the operation again.</li><li>• Re-IML.</li><li>• If the problem continues, request service for the control unit.</li></ul>

- Re-IML means to try to make the control unit operational; refer to page 2-17 for the correct actions.
- When requesting service, be sure to give the status code and additional numbers to the service personnel.
- Some status codes are normal progress or completion messages; if the **Status Code** remains lit for more than 10 seconds, the code indicates an error. For an error, perform the appropriate actions.

Base Status Code	Possible Additional Numbers / Explanation / Action
4001	<p><i>Offline test prompt.</i></p> <ul style="list-style-type: none"> <li>• Key in the offline test selection. Refer to “Offline Tests” on page 3-108.</li> </ul>
4030 – 4034	<p><i>Offline test failure.</i></p> <ul style="list-style-type: none"> <li>• Re-IML and retry the operation.</li> <li>• Request service for the control unit.</li> </ul>
4050	<p><i>Offline test log is full.</i></p> <p>At the terminal connected to port 0:</p> <ul style="list-style-type: none"> <li>• To retrieve the log, press <b>Enter</b> (Free function) to get the 4001 prompt.</li> <li>• Key in <b>8001</b> and press <b>Enter</b> to display the test log.</li> <li>• If the test log is not displayed, request help from your technical support group or help desk.</li> </ul>
4079	<p><i>Offline test failure.</i></p> <ul style="list-style-type: none"> <li>• Re-IML and retry the operation.</li> <li>• Request service for the control unit.</li> </ul>
4080	<i>Offline tests are running at the display connected to port zero.</i>
4081	<p><i>Offline test failure: Port 0 control terminal.</i></p> <ul style="list-style-type: none"> <li>• Check that the Port 0 control terminal is turned on.</li> <li>• Use “3270 Terminal Connection Problems” on page 3-13 to identify connection or terminal problems.</li> <li>• Request help from your technical support group or help desk.</li> </ul>
4082	<p><i>Unsupported keyboard attached to port 0.</i></p> <ul style="list-style-type: none"> <li>• Connect a 3278, 3279, 3178, 3179, or similar terminal to port 0.</li> <li>• Request help from your technical support group or help desk.</li> </ul>
4099	<p><i>Invalid procedure tried at IML error.</i></p> <p>The diagnostic Free and Continue functions are not allowed.</p> <ul style="list-style-type: none"> <li>• Re-IML.</li> <li>• Request help from your technical support group or help desk.</li> </ul>
4101	<p><i>Invalid request keyed in the Alt 1 40 prompt.</i></p> <p><b>Note:</b> Use the Utility diskette for offline tests or for customization.</p> <ul style="list-style-type: none"> <li>• Make sure that a Utility diskette is installed in the diskette drive.</li> <li>• Do an Alt 1 IML (press and hold <b>Alt 1</b>, press and release <b>IML</b>, and then release <b>Alt 1</b>).</li> <li>• Key in the correct selection at the 40 prompt.</li> <li>• Request help from your technical support group or help desk.</li> </ul>
4102 – 4106	<p><i>Invalid offline test request.</i></p> <ul style="list-style-type: none"> <li>• Press <b>Enter</b> for the 4001 prompt.</li> <li>• Key in the correct selection.</li> <li>• Request help from your technical support group or help desk.</li> </ul>

- Re-IML means to try to make the control unit operational; refer to page 2-17 for the correct actions.
- When requesting service, be sure to give the status code and additional numbers to the service personnel.
- Some status codes are normal progress or completion messages; if the **Status Code** remains lit for more than 10 seconds, the code indicates an error. For an error, perform the appropriate actions.



## Status Codes

<b>Base Status Code</b>	<b>Possible Additional Numbers / Explanation / Action</b>
4107 – 4110	<i>Operator error in pressing the wrong key during the offline tests.</i> <ul style="list-style-type: none"><li>• Press the correct key.</li><li>• Request help from your technical support group or help desk.</li></ul>
4111	<i>The response keyed in at the 3174 operator panel was not a Continue request.</i> <p>Key in <b>1</b>, and press <b>Enter</b>.</p>
4112	<i>The operator did not press Alt 1 or Alt 2 correctly.</i> <p>Key in <b>1</b>, and press <b>Enter</b>.</p> <ul style="list-style-type: none"><li>• If it is not an operator problem, request service for the control unit.</li></ul>
4113 – 4201	<i>Offline test failure: the diskette drive is not ready.</i> <ul style="list-style-type: none"><li>• Check to see that the correct diskette is inserted in all drives.</li><li>• Make sure that the diskette drive lever is closed on all drives.</li><li>• Do the Free function (press <b>Enter</b>).</li><li>• Try the test request again.</li><li>• If the problem continues, request service for the control unit.</li></ul>
4203	<i>Offline test failure: a write-protected diskette is in the diskette drive.</i> <ul style="list-style-type: none"><li>• Insert a diskette that is not write-protected and try the operation again.</li><li>• Request help from your technical support group or help desk.</li></ul>
4204	<i>The diskette drive lever was opened and closed during the test of the drive.</i> <ul style="list-style-type: none"><li>• If no one opened the drive during testing, the drive may have failed.</li><li>• Press <b>Enter</b> to do the Free function (4001 prompt).</li><li>• Try the test again.</li><li>• Request service for the control unit.</li></ul>
4210 – 4212	<i>The Terminal Adapter Printer Exerciser has detected a problem:</i> <p><b>4210:</b> Testing an incorrect port or device. <b>4211:</b> Printer is out of paper, jammed, or not ready. <b>4212:</b> Printer is on hold or is defective.</p> <ul style="list-style-type: none"><li>• Correct the condition and rerun the test.</li><li>• Request help from your technical support group or help desk.</li><li>• Press <b>Enter</b> to stop this test.</li></ul>
4505	<i>Prompt message presented after invoking of the operator panel keypad indicator test diagnostic.</i> <ul style="list-style-type: none"><li>• Press any keys and observe the Status display key indication.</li><li>• Press <b>Enter</b> to end the routine.</li><li>• To do the Free function, press <b>Enter</b> a second time.</li></ul>

- Re-IML means to try to make the control unit operational; refer to page 2-17 for the correct actions.
- When requesting service, be sure to give the status code and additional numbers to the service personnel.
- Some status codes are normal progress or completion messages; if the **Status Code** remains lit for more than 10 seconds, the code indicates an error. For an error, perform the appropriate actions.

Base Status Code	Possible Additional Numbers / Explanation / Action
4510	<p><i>An attached printer or display is not supported, or the wrong terminal was specified.</i></p> <ul style="list-style-type: none"> <li>• Run the test again, specifying the correct port.</li> <li>• If the correct port was specified, connect a printer that is supported.</li> <li>• Check modem power and cable connections.</li> <li>• Request help from your technical support group or help desk.</li> <li>• Press <b>Enter</b> to stop this test.</li> </ul>
4511	<p><i>The printer is out of paper, jammed, or not ready.</i></p> <ul style="list-style-type: none"> <li>• Check modem power and cable connections.</li> <li>• Request help from your technical support group or help desk.</li> <li>• Press <b>Enter</b> to stop this test.</li> </ul>
4512	<p><i>The print operation has not been completed; the printer Hold switch is active, or the printer is defective.</i></p> <ul style="list-style-type: none"> <li>• Check modem power and cable connections.</li> <li>• Request help from your technical support group or help desk.</li> <li>• Press <b>Enter</b> to stop this test.</li> </ul>
4513	<p><i>Responses to Communication Adapter Test: Data Set Ready and Carrier Detect are active.</i></p> <ul style="list-style-type: none"> <li>• Press <b>Enter</b> to stop this test.</li> <li>• Request help from your technical support group or help desk.</li> </ul>
4514	<p><i>Response for the offline Communication Adapter Driver Static test.</i></p> <ul style="list-style-type: none"> <li>• The interface is being held active.</li> <li>• To stop this function, press <b>Enter</b> (Free).</li> </ul>
4530, 4531	<p><i>Response to offline Channel Adapter Online/Offline Switch test:</i></p> <p style="padding-left: 40px;"><b>4530:</b> The <b>Channel Interface</b> switch is in the <b>Offline</b> position.</p> <p style="padding-left: 40px;"><b>4531:</b> The <b>Channel Interface</b> switch is in the <b>Online</b> position.</p> <p>To stop this function, press <b>Enter</b> (Free).</p>
4535	<p><b>IDID IDID IDID</b> <i>The Token-Ring Adapter Function 10 was selected for this address (ID.....ID).</i></p> <p>Press <b>Enter</b> (Free function) to display the 4001 prompt.</p>
4542	<p><i>A prompt message to allow an update of the control unit timer day and time.</i></p> <p>Request help from your technical support group or help desk.</p>
4550	<p><b>01HG PN00</b> <i>Offline Terminal Adapter selectable test was successful (direct path).</i></p> <p><b>02HG PN00</b> <i>Offline Terminal Adapter selectable test was successful (path through TMA/3299).</i></p>
4560 – 4563	<p><i>Responses for the offline Diskette Drive Ready/Change Test.</i></p> <p style="padding-left: 40px;"><b>4560:</b> Neither Drive Ready nor Diskette Change.</p> <p style="padding-left: 40px;"><b>4561:</b> Drive Ready without Diskette Change.</p> <p style="padding-left: 40px;"><b>4562:</b> No Drive Ready with Diskette Change.</p> <p style="padding-left: 40px;"><b>4563:</b> Drive Ready and Diskette Change.</p> <p>If a proper status code change is not displayed when a Drive Ready or Diskette Change action occurs:</p> <ul style="list-style-type: none"> <li>• Request service for the control unit.</li> <li>• Press <b>Enter</b> to stop this test.</li> </ul>

- Re-IML means to try to make the control unit operational; refer to page 2-17 for the correct actions.
- When requesting service, be sure to give the status code and additional numbers to the service personnel.
- Some status codes are normal progress or completion messages; if the **Status Code** remains lit for more than 10 seconds, the code indicates an error. For an error, perform the appropriate actions.

## Status Codes

<b>Base Status Code</b>	<b>Possible Additional Numbers / Explanation / Action</b>
4565 – 4569	<i>Responses for the offline Diskette Media Scan Test.</i> <b>4565:</b> Insert the diskette to be scanned, key in 1, and press <b>Enter</b> to start the scan. <b>4566:</b> The scan was completed without any defective tracks detected. <b>4567:</b> The scan was completed with defective tracks detected. Replace the diskette. <b>4568:</b> Insert a valid 3174 diskette in drive 1. Rerun the test. <b>4569:</b> Insert a valid 3174 diskette in drive 2. Rerun the test.
4580	<i>The offline test log is empty.</i> Press <b>Enter</b> (Free function) to display the 4001 prompt.
4581	<i>The offline test log contains errors.</i> At the terminal connected to port 0: <ul style="list-style-type: none"><li>• To retrieve the log, press <b>Enter</b> (Free function) to get the 4001 prompt.</li><li>• Key in <b>8001</b> and press <b>Enter</b> to display the test log.</li><li>• If the test log is not displayed, request help from your technical support group or help desk.</li></ul>
4607	<i>The requested adapter is disabled.</i> Request help from your technical support group or help desk.
4608	<i>Online test failure: Too many users are requesting these tests.</i> <ul style="list-style-type: none"><li>• Wait; then retry the online test.</li><li>• Request help from your technical support group or help desk.</li></ul>
4609	<i>Online test microcode failure.</i> <ul style="list-style-type: none"><li>• Retry the online test.</li><li>• Request service for the control unit.</li></ul>
4610	<i>An invalid test number was typed in during online tests.</i> Type in a valid test number from the test menu.
4611	<i>Online Test condition: The test requested is already active.</i> Try the test request again.
4612, 4613	<i>An incorrect port number or hardware group was requested:</i> <b>4612:</b> Enter the correct port number and retry the request. <b>4613:</b> Enter the correct hardware group or check that the requested group is present. Request help from your technical support group or help desk.
4614	<i>An invalid entry was made during the online tests.</i> Check the panel for the format that should be used, and try the test request again.
4615	<i>The number of parameters for the online test request is incorrect.</i> Check the panel that lists the desired test, and correct the test request.
4616	<i>An invalid parameter was typed in during the online test.</i> Check the panel that lists the valid parameters, and correct the test request.

- Re-IML means to try to make the control unit operational; refer to page 2-17 for the correct actions.
- When requesting service, be sure to give the status code and additional numbers to the service personnel.
- Some status codes are normal progress or completion messages; if the **Status Code** remains lit for more than 10 seconds, the code indicates an error. For an error, perform the appropriate actions.

Base Status Code	Possible Additional Numbers / Explanation / Action
4617	<i>Invalid data in the online test request was typed in.</i> Check the menu for the correct test request format, and try the test request again.
4618	<i>The requested function is no longer supported.</i> Request help from your technical support group or help desk.
4619	<i>An invalid key was pressed during the online test.</i> Use the correct key and retry the test request.
4620	<i>An informational message that a system event was logged.</i> No action is required at this time.
4625	<i>An online test error was detected; a /8 was entered during a secondary session.</i> 1. Use the <b>ChgS</b> key to return to the primary session. 2. Type in /8. 3. Press <b>ENTER</b> .
4630	<i>A Start Trace command has been sent, and a trace is already running.</i> To start the trace again: 1. Type in the Stop Trace command. 2. Press <b>ENTER</b> . 3. Then type in the Start Trace command. 4. Press <b>ENTER</b> .
4631	<i>A Stop Trace command was sent while the trace was already stopped.</i>
4632	<i>The control unit is busy and cannot accept the trace request.</i> Try the trace request again.
4633	<i>Trace initialization was requested after the trace was already started.</i> Stop the trace, and try the trace request again.
4634	<i>A diskette error occurred during an attempt to stop a trace.</i> Use the status code on the operator panel to determine the cause of the diskette failure.
4635	<i>A diskette error occurred during an attempt to start a trace.</i> Use the status code on the operator panel to determine the cause of the diskette failure.
4636	<i>The online trace was requested for more than two ASCII ports.</i> • Traces, beyond the second requested trace, will be ignored. To run these traces, key in the <b>Trace Stop</b> command and set up the new ports to be traced. • Request help from your technical support group or help desk.
4640	<i>The online Port Wrap Test has been completed successfully.</i>
4641	<i>The requested wrap test has not been done, because a terminal is now successfully communicating with the port number that was entered in the test request.</i>
4642	<i>An invalid Terminal Adapter port number was typed in during the online Port Wrap Test.</i> Type in 0, 8, 16, or 24 and try the test again.

- Re-IML means to try to make the control unit operational; refer to page 2-17 for the correct actions.
- When requesting service, be sure to give the status code and additional numbers to the service personnel.
- Some status codes are normal progress or completion messages; if the **Status Code** remains lit for more than 10 seconds, the code indicates an error. For an error, perform the appropriate actions.

## Status Codes

Base Status Code	Possible Additional Numbers / Explanation / Action
4650	<p><i>The Terminal Adapter support for multiplexers (TMA/3299) has failed; however, the adapter may operate when attached directly to a terminal.</i></p> <ul style="list-style-type: none"><li>• If this port is being used for a directly attached terminal, this failure will not affect normal operation.</li><li>• If this port is being used to support terminals attached through a TMA/3299 multiplexer, the Terminal Adapter must be replaced.</li><li>• Request help from your technical support group or help desk.</li></ul>
4651	<p><i>Terminal Adapter port wrap failure.</i></p> <p><i>This can be a false indication if the signal cable is attached to the port being tested.</i></p> <ul style="list-style-type: none"><li>• Disconnect the port signal cable, and try the test again.</li><li>• Request service for the control unit.</li></ul>
4652	<p><i>Terminal multiplexer port wrap failure.</i></p> <p><i>This can be a false indication if the signal cable is attached to the port being tested.</i></p> <ul style="list-style-type: none"><li>• Disconnect the port signal cable, and retry the test.</li><li>• Request help from your technical support group or help desk.</li></ul>
4653	<p><i>A multiplexer wrap test was requested on a port that is directly connected to a terminal.</i></p> <p>Use the Direct Wrap Test for the Terminal Adapter port.</p>
4660 – 4663	<p><i>An invalid entry was made in the Transmit Request from the ACA Port Test Menu.</i></p> <ul style="list-style-type: none"><li>• Correct the entry and rerun the test.</li><li>• Request help from your technical support group or help desk.</li><li>• Press <b>Enter</b> to stop this test.</li></ul>
4664 – 4666	<p><i>These are messages reflecting a disconnect request from a port wrap test:</i></p> <p><b>4664:</b> The ASCII port is currently active. To force a disconnection, press <b>Enter</b>.</p> <p><b>4265:</b> A disconnection is in progress.</p> <p><b>4266:</b> The disconnection is completed. Press <b>Enter</b> to begin the wrap test originally requested.</p>
4670	<p><i>A dump of a DFT has been selected, and the DFT has not responded.</i></p> <p>4670 is normally followed by alternating status codes of 4671 and 4672. If this does not occur, cancel the dump by turning the DFT off, and then on.</p> <p>Start the dump again the next time the DFT fails.</p>
4671	<p><i>A dump of a DFT is in progress.</i></p> <p><b>Note:</b> This status code alternates with 4672.</p>
4672	<p><i>A dump of a DFT is in progress.</i></p> <p><b>Note:</b> This status code alternates with 4671.</p>
4673	<p><i>A dump of a DFT has ended before completion.</i></p> <p>Try the dump again. If the problem continues, do the dump the next time the DFT fails.</p>

- Re-IML means to try to make the control unit operational; refer to page 2-17 for the correct actions.
- When requesting service, be sure to give the status code and additional numbers to the service personnel.
- Some status codes are normal progress or completion messages; if the **Status Code** remains lit for more than 10 seconds, the code indicates an error. For an error, perform the appropriate actions.

Base Status Code	Possible Additional Numbers / Explanation / Action
4675	<p><i>A dump of a DFT has been completed successfully.</i></p> <p>Remove the Dump diskette and insert the Downstream Load or Control diskette. Normal operations start automatically.</p> <p>If the control unit is not working correctly, request help from your technical support group or help desk.</p>
4687	<p><i>The online Token-Ring Link Status Test [9] detected an error.</i></p> <ul style="list-style-type: none"> <li>• No action is required.</li> <li>• If the operation is impaired, request help from your technical support group or help desk.</li> </ul>
4688	<p><i>The online Token-Ring Link Status Test indicates that no links are active.</i></p> <p>No action is required.</p>
4689	<p><i>The online Token-Ring Link Status Test indicates that the link requested is not active.</i></p> <p>No action is required.</p>
4690	<p><i>An invalid link address was entered during the online Token-Ring Link Status Test.</i></p> <p>Reenter the correct address.</p>
4691	<p><i>During an online Token-Ring Status Test, a station detected a signal loss for more than 250 milliseconds and has entered beaconing.</i></p> <p>Request help from your technical support group or help desk.</p>
4692	<p><i>During an online Token-Ring Status Test, the Token-Ring Adapter detected a beacon signal.</i></p> <p>Request help from your technical support group or help desk.</p>
4693	<p><i>A lobe wire fault was detected during the online Token-Ring Status Test.</i></p> <ul style="list-style-type: none"> <li>• Contact the host operator to return the link(s) to service.</li> <li>• If the failure continues, request help from your technical support group or help desk.</li> </ul>
4694	<p><i>This status code indicates how long the online Token-Ring Status Test has been running.</i></p> <p>No action is required.</p>
4695	<p><i>This status code is displayed after the online Token-Ring Status Test has been active for 10 minutes.</i></p> <p>Press PF9 within the next 5 minutes to continue the test. If PF9 is not pressed, the test ends automatically.</p>
4696	<p><i>The online Token-Ring Status Test is being performed at another terminal.</i></p> <p>No action is required.</p>
4697	<p><i>The online Token-Ring Status Test indicates the Token-Ring Adapter is open.</i></p> <p>No action is required.</p>

- Re-IML means to try to make the control unit operational; refer to page 2-17 for the correct actions.
- When requesting service, be sure to give the status code and additional numbers to the service personnel.
- Some status codes are normal progress or completion messages; if the **Status Code** remains lit for more than 10 seconds, the code indicates an error. For an error, perform the appropriate actions.

## Status Codes

Base Status Code	Possible Additional Numbers / Explanation / Action
4698	<p><i>The online Token-Ring Status Test indicates the Token-Ring Adapter is closed.</i></p> <ul style="list-style-type: none"> <li>• Use the operator panel to see if there is another status code for hardware group 31. If there is, look up the status code in this chart and do the recommended actions.</li> <li>• If another status code is not indicated, do an Alt 2 IML (refer to "Alt 2 IML Tests" on page 3-108). Remember, an IML disrupts all operating terminals.</li> <li>• If the Alt 2 IML is successful, do the Token-Ring Adapter Wrap Test.</li> <li>• If the problem continues, request help from your technical support group or help desk.</li> </ul>
4699	<p><i>The online Token-Ring Link status test indicates the links are not active.</i></p> <ul style="list-style-type: none"> <li>• The station status cannot be displayed.</li> <li>• No action is required.</li> </ul>
4990	<p><i>IML hardware or microcode failure.</i></p> <ul style="list-style-type: none"> <li>• Insert the backup Control or Utility diskette.</li> <li>• Re-IML.</li> <li>• Request service for the control unit.</li> </ul>
4994	<p><i>IML hardware failure: the Terminal Adapter is either defective or missing.</i></p> <ul style="list-style-type: none"> <li>• Re-IML.</li> <li>• Request service for the control unit.</li> </ul>
4995	<p><i>IML failure: insufficient storage for the Control diskette configuration.</i></p> <ul style="list-style-type: none"> <li>• For diskettes configured for the Token-Ring Gateway feature, at least one Storage Expansion feature card (Type 9051 or 9052) is required in location 20.</li> <li>• Make sure you are using the correct Control diskette.</li> <li>• Re-IML.</li> <li>• Request help from your technical support group or help desk.</li> </ul>
4997	<p><b>0100</b> <i>Something other than 40 or 41 was entered at the Alt 1 40 prompt.</i></p> <ul style="list-style-type: none"> <li>• Try the Alt 1 IML again.</li> <li>• Enter the correct parameters (40 or 41).</li> </ul> <hr/> <p><b>0200</b> <i>A 40 was entered with Alt 1 requesting the Master Menu with the Control diskette installed.</i></p> <ul style="list-style-type: none"> <li>• If you want a normal IML, do the Alt 1 IML and key in 41 (refer to "Making the 3174 Operational" on page 2-17).</li> <li>• If you want the Master Menu, install the Utility diskette, do the Alt 1 IML, and key in 40 (refer to "Displaying the Master Menu" on page 2-22).</li> <li>• Request help from your technical support group or help desk.</li> </ul> <hr/> <p><b>0300</b> <i>A 41 was entered with Alt 1 requesting a normal IML with the Utility diskette installed.</i></p> <ul style="list-style-type: none"> <li>• If you want the Master Menu, do the Alt 1 IML and key in 40 (refer to "Displaying the Master Menu" on page 2-22).</li> <li>• If you want the normal IML, install the Control diskette, do the Alt 1 IML, and key in 41 (refer to "Making the 3174 Operational" on page 2-17).</li> <li>• Request help from your technical support group or help desk.</li> </ul>

- Re-IML means to try to make the control unit operational; refer to page 2-17 for the correct actions.
- When requesting service, be sure to give the status code and additional numbers to the service personnel.
- Some status codes are normal progress or completion messages; if the **Status Code** remains lit for more than 10 seconds, the code indicates an error. For an error, perform the appropriate actions.

Base Status Code	Possible Additional Numbers / Explanation / Action
4998	<p><i>An IML microcode failure.</i></p> <ul style="list-style-type: none"> <li>• Insert the backup Control or Utility diskette.</li> <li>• Re-IML.</li> <li>• Request help from your technical support group or help desk.</li> </ul>
4999 – 5090	<p><i>These are IML progress messages. A failure has occurred if the status code does not change in 10 seconds.</i></p> <ul style="list-style-type: none"> <li>• Exchange the Control diskette.</li> <li>• Re-IML.</li> <li>• Do an Alt 2 IML (refer to “Alt 2 IML Tests” on page 3-108).</li> <li>• Request help from your technical support group or help desk.</li> </ul>
5201	<p><i>There is a mismatch between the hardware and customization. A Channel Adapter is required for Model 1L.</i></p> <ul style="list-style-type: none"> <li>• Re-IML.</li> <li>• Verify that you have the correct Control diskette.</li> <li>• Request help from your technical support group or help desk.</li> </ul>
5202	<p><b>0100</b> <i>There is a mismatch between the hardware and customization. Communication Adapter Type 1 is required; Models 1R, 51R, and 81R contain a Type 1 adapter.</i></p> <ul style="list-style-type: none"> <li>• Check that you are using the correct Control diskette for the correct model.</li> <li>• Check that the Communication Adapter Type 9253 is correctly installed in location 22.</li> <li>• Re-IML.</li> <li>• Request help from your technical support group or help desk.</li> </ul> <p><b>0200</b> <i>There is a mismatch between the hardware and customization: invalid or missing Type 1 communication cable.</i></p> <ul style="list-style-type: none"> <li>• Check that the communication cable is attached correctly.</li> <li>• Check that the correct communication cable type is attached (see “Communication Adapter and Communication Cable Test” on page 3-110 for the correct part numbers).</li> <li>• Re-IML.</li> <li>• Request help from your technical support group or help desk.</li> </ul>
5203	<p><b>0100</b> <i>There is a mismatch between the hardware and customization. Communication Adapter Type 2 is required; Models 2R, 52R, and 82R contain a Type 2 adapter.</i></p> <ul style="list-style-type: none"> <li>• Check that you are using the correct Control diskette for the correct model.</li> <li>• Check that the Communication Adapter Type 9273 or 9277 is correctly installed in location 22.</li> <li>• Re-IML.</li> <li>• Request help from your technical support group or help desk.</li> </ul> <p><b>0200</b> <i>There is a mismatch between the hardware and customization: invalid or missing Type 2 communication cable.</i></p> <ul style="list-style-type: none"> <li>• Check that the communication cable is attached correctly.</li> <li>• Check that the correct communication cable type is attached (see “Communication Adapter and Communication Cable Test” on page 3-110 for the correct part numbers).</li> <li>• Re-IML.</li> <li>• Request help from your technical support group or help desk.</li> </ul>

- Re-IML means to try to make the control unit operational; refer to page 2-17 for the correct actions.
- When requesting service, be sure to give the status code and additional numbers to the service personnel.
- Some status codes are normal progress or completion messages; if the **Status Code** remains lit for more than 10 seconds, the code indicates an error. For an error, perform the appropriate actions.



## Status Codes

<b>Base Status Code</b>	<b>Possible Additional Numbers / Explanation / Action</b>
5204	<p><b>0100</b> <i>There is a mismatch between the hardware and customization; the Control diskette is configured for a Model 51R, 52R, or 53R.</i></p> <ul style="list-style-type: none"><li>• Check that the correct Control diskette is installed.</li><li>• Re-IML.</li><li>• Request help from your technical support group or help desk.</li></ul> <hr/> <p><b>0300</b> <i>There is a mismatch between the hardware and customization; the Control diskette is configured for a Model 81R or 82R.</i></p> <ul style="list-style-type: none"><li>• Check that the correct Control diskette is installed.</li><li>• Re-IML.</li><li>• Request help from your technical support group or help desk.</li></ul>
5206	<p><i>There is a mismatch between the hardware and customization: a Token-Ring Adapter is required. Models 3R, 53R, and 1L with the Token-Ring Gateway feature have a Token-Ring Adapter.</i></p> <ul style="list-style-type: none"><li>• Check that you are using the correct Control diskette for the correct model.</li><li>• Check that the Token-Ring Adapter Type 9350 is correctly installed in the control unit.</li><li>• Request help from your technical support group or help desk.</li></ul>
5207	<p><i>There is a mismatch between the hardware and customization: there is not enough storage to support the attachment of the Token-Ring Adapter Gateway feature.</i></p> <ul style="list-style-type: none"><li>• Check that the correct Control diskette is installed.</li><li>• Re-IML.</li><li>• Request help from your technical support group or help desk.</li></ul>
5230	<p><i>An IML customization failure: the Control diskette has not been configured.</i></p> <ul style="list-style-type: none"><li>• Check that the correct Control diskette is installed.</li><li>• Re-IML.</li><li>• Request help from your technical support group or help desk.</li></ul>
5231 – 5242	<p><i>IML customization failure. The Control diskette must be recustomized.</i></p> <ul style="list-style-type: none"><li>• Insert the backup Control diskette.</li><li>• Re-IML.</li><li>• Request help from your technical support group or help desk.</li></ul>

- Re-IML means to try to make the control unit operational; refer to page 2-17 for the correct actions.
- When requesting service, be sure to give the status code and additional numbers to the service personnel.
- Some status codes are normal progress or completion messages; if the **Status Code** remains lit for more than 10 seconds, the code indicates an error. For an error, perform the appropriate actions.

Base Status Code	Possible Additional Numbers / Explanation / Action
5243	<p><b>0100</b> <i>IML customization failure: Question 121 and the Keyboard Definition Utility language ID do not match.</i></p> <p><b>Note:</b> The Keyboard Definition Utility must be used to correct the language ID.</p> <ul style="list-style-type: none"> <li>• Insert the backup Control diskette.</li> <li>• Re-IML.</li> <li>• Request help from your technical support group or help desk.</li> </ul>
	<p><b>0200</b> <i>IML customization failure: Question 137 contains an invalid keyboard ID.</i></p> <p><b>Note:</b> The Keyboard Definition Utility must be used to correct the keyboard ID.</p> <ul style="list-style-type: none"> <li>• Insert the backup Control diskette.</li> <li>• Re-IML.</li> <li>• Request help from your technical support group or help desk.</li> </ul>
	<p><b>0400</b> <i>IML customization microcode failure.</i></p> <ul style="list-style-type: none"> <li>• Insert the backup Control diskette.</li> <li>• Re-IML.</li> <li>• Request service for the control unit.</li> </ul>
5244 – 5252	<p><i>IML customization failure.</i></p> <ul style="list-style-type: none"> <li>• Keep pressing the <b>Advance</b> key until the display is blank, and record all the numbers that appeared in the <b>Status</b> display each time you pressed the key.</li> <li>• Insert the backup Control diskette.</li> <li>• Re-IML.</li> <li>• Request help from your technical support group or help desk.</li> </ul>
5286 – 5290	<p><i>IML customization failure. The Control diskette must be recustomized. IML customization microcode failure.</i></p> <ul style="list-style-type: none"> <li>• Insert the backup Control diskette.</li> <li>• Re-IML.</li> <li>• Request service for the control unit.</li> </ul>
5901, 5902	<p><i>A control unit offline dump is in progress. A failure occurred if the status code does not change for more than 10 seconds.</i></p> <p>Status codes 5901 and 5902 will alternate during the dump.</p> <ul style="list-style-type: none"> <li>• The dump may be retried by starting the Alt 1 IML Dump Procedure again.</li> <li>• Try another Dump diskette.</li> <li>• Request service for the control unit.</li> </ul>
5903 – 5905	<p><i>A control unit offline dump is in progress. A failure occurred if the status code does not change for more than 10 seconds.</i></p> <p><b>Note:</b> The microcode to be dumped has been destroyed.</p> <ul style="list-style-type: none"> <li>• Dump must be done again at the next failure.</li> <li>• Do an Alt 2 IML (refer to “Alt 2 IML Tests” on page 3-108).</li> <li>• Request service for the control unit.</li> </ul>

- Re-IML means to try to make the control unit operational; refer to page 2-17 for the correct actions.
- When requesting service, be sure to give the status code and additional numbers to the service personnel.
- Some status codes are normal progress or completion messages; if the **Status Code** remains lit for more than 10 seconds, the code indicates an error. For an error, perform the appropriate actions.

## Status Codes

<b>Base Status Code</b>	<b>Possible Additional Numbers / Explanation / Action</b>
5907	<p><i>This is an offline dump prompt.</i></p> <p>Insert the Control diskette in the Dump diskette drive.</p>
5908, 5909	<p><i>A control unit offline dump is in progress. A failure occurred if the status code does not change for more than 10 seconds.</i></p> <p>Status codes 5908 and 5909 will alternate during the dump.</p> <p><b>Note:</b> The microcode to be dumped has been destroyed.</p> <ul style="list-style-type: none"><li>• Dump must be done again at the next failure.</li><li>• Do an Alt 2 IML (refer to "Alt 2 IML Tests" on page 3-108).</li><li>• Request service for the control unit.</li></ul>
5910	<p><i>This is an offline dump prompt.</i></p> <p>Replace the Control diskette with the original Dump diskette.</p>
5912, 5913	<p><i>A control unit offline dump is in progress. A failure occurred if the status code does not change for more than 10 seconds.</i></p> <p>Status codes 5912 and 5913 will alternate during the dump.</p> <p><b>Note:</b> The microcode to be dumped has been destroyed.</p> <ul style="list-style-type: none"><li>• Dump must be done again at the next failure.</li><li>• Do an Alt 2 IML (refer to "Alt 2 IML Tests" on page 3-108).</li><li>• Request service for the control unit.</li></ul>
5914	<p><i>This is an offline dump prompt: The Dump diskette is full.</i></p> <p>Replace the Dump diskette with a new Dump diskette.</p>
5916	<p><i>This is an offline dump prompt: The dump was completed without an error.</i></p> <ul style="list-style-type: none"><li>• Remove the Dump diskette.</li><li>• The control unit can now be made operational (refer to "Making the 3174 Operational" on page 2-17).</li></ul>
5917, 5918	<p><i>This is an offline dump prompt: The dump was completed with an error.</i></p> <ul style="list-style-type: none"><li>• Press <b>Advance</b> and record the numbers in the <b>Status</b> display. Repeat this process until the display is blank.</li><li>• Remove the Dump diskette.</li><li>• The control unit can now be made operational (refer to "Making the 3174 Operational" on page 2-17).</li></ul>
5920	<p><i>Incorrect offline IML dump. The Alt 1 IML Dump procedure was not invoked correctly.</i></p> <p><b>Note:</b> The microcode to be dumped has been destroyed.</p> <ul style="list-style-type: none"><li>• The dump must be done again at the next failure.</li><li>• Use the correct Alt 1 IML Dump procedure.</li><li>• Request service for the control unit.</li></ul>
5922	<p><i>Recoverable Dump diskette error.</i></p> <ul style="list-style-type: none"><li>• The dump may be retried by starting the Alt 1 IML Dump Procedure again.</li><li>• Try another Dump diskette.</li><li>• Request service for the control unit.</li></ul>

- Re-IML means to try to make the control unit operational; refer to page 4-52upp. for the correct actions.
- When requesting service, be sure to give the status code and additional numbers to the service personnel.
- Some status codes are normal progress or completion messages; if the **Status Code** remains lit for more than 10 seconds, the code indicates an error. For an error, perform the appropriate actions.

Base Status Code	Possible Additional Numbers / Explanation / Action
5923	<p><i>Unrecoverable Dump diskette error.</i></p> <p><b>Note:</b> The microcode to be dumped has been destroyed.</p> <ul style="list-style-type: none"> <li>• The dump must be done again at the next failure.</li> <li>• Try another Dump diskette.</li> <li>• Do an Alt 2 IML (refer to “Alt 2 IML Tests” on page 3-108).</li> <li>• Request service for the control unit.</li> </ul>
5924, 5925	<p><i>Offline dump hardware error.</i></p> <p><b>Note:</b> The microcode to be dumped has been destroyed.</p> <ul style="list-style-type: none"> <li>• The dump must be done again at the next failure.</li> <li>• Do an Alt 2 IML (refer to “Alt 2 IML Tests” on page 3-108).</li> <li>• Request service for the control unit.</li> </ul>
5932	<p><b>QLHG</b> <i>The wrong diskette was inserted for the offline dump.</i></p> <ul style="list-style-type: none"> <li>• Insert the correct diskette: <ul style="list-style-type: none"> <li>QL = 01 = Insert the Control diskette.</li> <li>QL = 02 = Insert the original Dump diskette.</li> <li>QL = 03 = Insert a new Dump diskette.</li> </ul> </li> <li>• Request service for the control unit.</li> </ul>
7000 – 7079	<p><i>Configuration status code.</i></p> <p>Refer to the <i>3174 Customizing Guide</i>.</p>
7080	<p><i>The customizing terminal (on port 0) is not communicating with the control unit.</i></p> <ul style="list-style-type: none"> <li>• Check that the terminal is switched on.</li> <li>• Check that the terminal cable is connected correctly.</li> </ul> <p><b>Note:</b> If the terminal is attached by a 7232 Dual Control Unit Terminal Multiplexer, use the <b>ChgSc</b> key to display the connection to the customizing control unit.</p> <ul style="list-style-type: none"> <li>• Refer to the terminal Problem Determination Guide.</li> </ul>
7081	<p><i>An unsupported terminal is connected to port 0.</i></p> <p>Connect a 3278, 3279, 3178, 3179, or similar terminal to port 0.</p>
7082	<p><b>01HG</b> <i>The customizing terminal (on port 0) is either disconnected from the control unit or switched off.</i></p> <ul style="list-style-type: none"> <li>• Check that the terminal is switched on.</li> <li>• Check that the terminal cable is connected correctly.</li> <li>• Refer to the terminal Problem Determination Guide.</li> <li>• Refer to “Initial Symptom/Action Table” on page 3-3.</li> </ul> <hr/> <p><b>02xx</b> <i>The terminal connected to port 0 is logically disconnected from the control unit because of terminal or terminal cable errors.</i></p> <ul style="list-style-type: none"> <li>• Check that the terminal cable is connected correctly.</li> <li>• Refer to the 2xx status code for recommended actions.</li> <li>• Refer to “Initial Symptom/Action Table” on page 3-3.</li> </ul>

- Re-IML means to try to make the control unit operational; refer to page 4-53upp. for the correct actions.
- When requesting service, be sure to give the status code and additional numbers to the service personnel.
- Some status codes are normal progress or completion messages; if the **Status Code** remains lit for more than 10 seconds, the code indicates an error. For an error, perform the appropriate actions.

## Status Codes

Base Status Code	Possible Additional Numbers / Explanation / Action
7083	<i>An invalid request was received from the customizing terminal (on port 0) port 0.</i> Check that a 3278, 3279, 3178, 3179, or similar terminal is attached to port 0.
7100 – 7449	<i>An error was detected during customization.</i> <ul style="list-style-type: none"> <li>• Make sure that the customization questions were answered correctly. Refer to the <i>3174 Customizing Guide</i>.</li> <li>• Request help from your technical support group or help desk.</li> </ul>
7501	<i>RPQs were moved to a new disk.</i> Reapply the RPQ, if necessary. The Merge RPQ Utility may be needed to delete old RPQs and to apply new releases containing updated versions.
7502	<i>During a microcode upgrade, the Modified Keyboard file was not upgraded.</i> <ul style="list-style-type: none"> <li>• Perform the Modified Keyboard function if you want a modified keyboard. Refer to the <i>3174 Customizing Guide</i>.</li> <li>• Request help from your technical support group or help desk.</li> </ul>
7503	<i>During a microcode upgrade, errors were found during updating of panels.</i> <ul style="list-style-type: none"> <li>• Reconfigure. Refer to the <i>3174 Customizing Guide</i>.</li> <li>• Request help from your technical support group or help desk.</li> </ul>
7504	<i>Not able to upgrade the Printer Authorization Matrix (PAM).</i> <ul style="list-style-type: none"> <li>• Redo the PAM procedure. Refer to the <i>3174 Customizing Guide</i>.</li> <li>• Request help from your technical support group or help desk.</li> </ul>
7505	<i>During a microcode upgrade, errors were found during updating of AEA panels.</i> <ul style="list-style-type: none"> <li>• Redo the AEA configuration procedure. Refer to the <i>3174 Customizing Guide</i>.</li> <li>• Request help from your technical support group or help desk.</li> </ul>
7521	<i>The Encrypt/Decrypt Adapter is not present.</i> Open the front door, and verify that the Encrypt/Decrypt Adapter is installed in card location 24. <ul style="list-style-type: none"> <li>• If the adapter is installed, run Alt 2 IML tests (refer to “Alt 2 IML Tests” on page 3-108).</li> <li>• If the adapter is not installed, you were trying to do an Encrypt/Decrypt utility on a control unit that does not have the feature.</li> </ul>
7522 and 7523	<i>Configuration status code.</i> Refer to the <i>3174 Customizing Guide</i> .
7524	<i>Encrypt/Decrypt Adapter error.</i> <ul style="list-style-type: none"> <li>• Insert the security key into the Encrypt/Decrypt Adapter and turn it to the horizontal position. Then, turn it back to the vertical position. Try the utility again.</li> <li>• Do an Alt 2 IML (refer to “Alt 2 IML Tests” on page 3-108).</li> <li>• Replace the battery on the Encrypt/Decrypt Adapter.</li> <li>• Then call your system security supervisor to install the master key value (procedures in the <i>3174 Customizing Guide</i>).</li> <li>• Request help from your technical support group or help desk.</li> </ul>

- Re-IML means to try to make the control unit operational; refer to page 4-54upp. for the correct actions.
- When requesting service, be sure to give the status code and additional numbers to the service personnel.
- Some status codes are normal progress or completion messages; if the **Status Code** remains lit for more than 10 seconds, the code indicates an error. For an error, perform the appropriate actions.

Base Status Code	Possible Additional Numbers / Explanation / Action
7525	<p><i>Encrypt/Decrypt Adapter error.</i></p> <ul style="list-style-type: none"> <li>• Insert the security key into the Encrypt/Decrypt Adapter and turn it to the horizontal position. Then, turn it back to the vertical position. Try the utility again.</li> <li>• Do an Alt 2 IML (refer to “Alt 2 IML Tests” on page 3-108).</li> <li>• Request help from your technical support group or help desk.</li> </ul>
7526 – 7529	<p><i>Configuration status code.</i></p> <p>Refer to the <i>3174 Customizing Guide</i>.</p>
7530	<p><i>Either the Encrypt/Decrypt Adapter keylock is in the wrong position or the adapter is bad.</i></p> <ul style="list-style-type: none"> <li>• Make sure that the keylock is in the vertical position, and try the operation again.</li> <li>• Request help from your technical support group or help desk.</li> </ul>
7531	<p><i>The Encrypt/Decrypt Diskette has not yet been initialized with either a CID value or a Verify Pattern.</i></p> <ul style="list-style-type: none"> <li>• Invoke Option 1.</li> <li>• If Option 1 has already been invoked, reinsert the diskette that was installed when that invocation took place. The current Encrypt/Decrypt diskette is not the one that was used when Option 1 was originally invoked.</li> </ul>
7541 – 7899	<p><i>A customizing status code.</i></p> <p>Refer to the <i>3174 Customizing Guide</i>.</p>
7900 – 7999	<p><i>An internal 3174 control unit error.</i></p> <p>Request service for the control unit.</p>
8888	<p><b>8888</b> appears when the IML pushbutton is pressed.</p> <p>This is an indicator test.</p> <p><b>Note:</b> If you are <i>not</i> pressing IML, and <b>8888</b> is displayed, the control unit has a hardware failure.</p> <p>Request service for the control unit.</p>

- Re-IML means to try to make the control unit operational; refer to page 4-55upp. for the correct actions.
- When requesting service, be sure to give the status code and additional numbers to the service personnel.
- Some status codes are normal progress or completion messages; if the Status Code remains lit for more than 10 seconds, the code indicates an error. For an error, perform the appropriate actions.



---

## **Chapter 5. Customer Setup and Relocation Instructions**

**Turn to the setup and relocation instructions that apply to your control unit model number.**

Model 1L Setup and Relocation Instructions	5-2
How to Set Up the 3174 Model 1L	5-3
How to Relocate the 3174 Model 1L	5-8
Models 1R, 2R, and 3R Setup and Relocation Instructions	5-12
How to Set Up the 3174 Models 1R, 2R, and 3R	5-13
How to Relocate the 3174 Models 1R, 2R, and 3R	5-20



# Model 1L Setup and Relocation Instructions

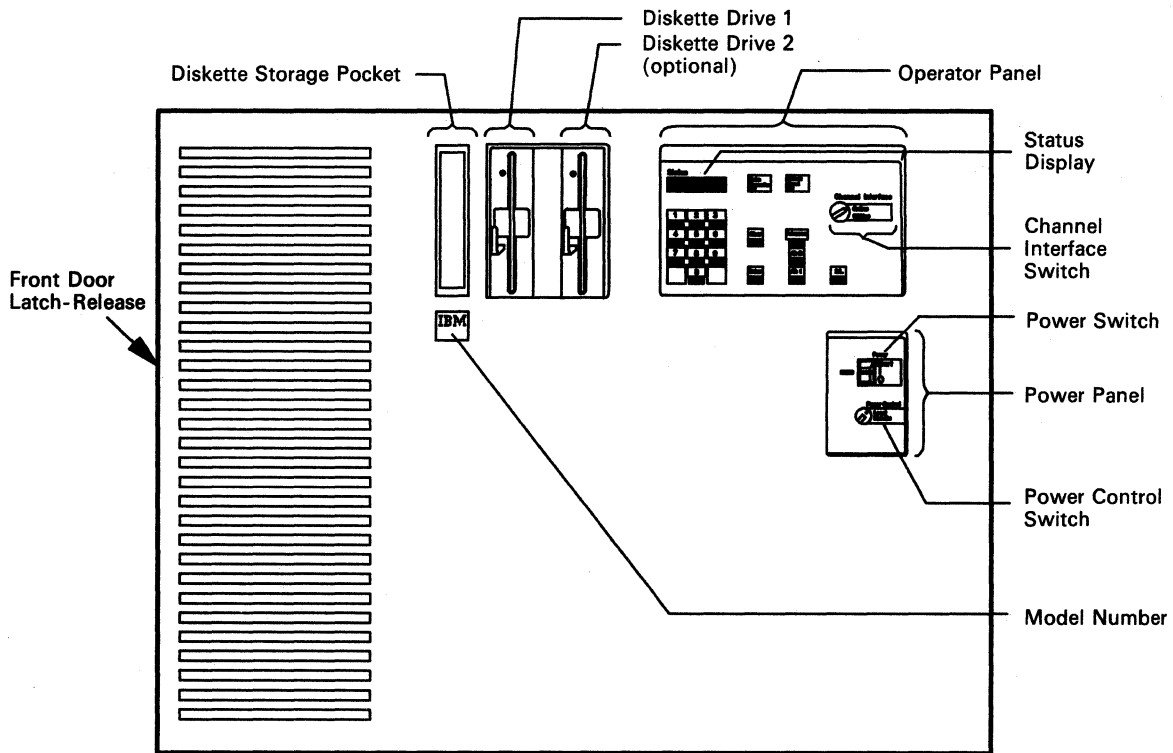

Model 1L -- Front View

## How to Set Up the 3174 Model 1L

These instructions tell you how to turn on the 3174 Subsystem Control Unit Model 1L and to verify that it is operating correctly.

With the control unit, you should have received the following items:

- Control diskettes (maximum of four), Utility diskettes (maximum of two), and, possibly, one or more Downstream Load (DSL) or RPQ diskettes
- A Token-Ring Adapter cable (for control units with the Token-Ring Network 3270 Gateway feature)
- A package of publications that includes:
  - An *IBM 3174 Subsystem Control Unit: User's Guide*, GA23-0337
  - An *IBM 3174 Subsystem Control Unit: Customizing Guide*, GA23-0214 (U.S. only).

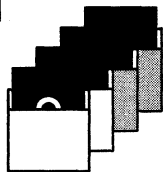
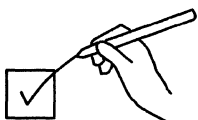

Control

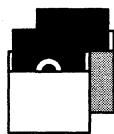

Utility



Downstream Load  
or  
RPQ

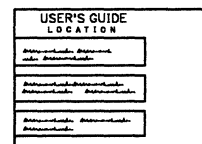
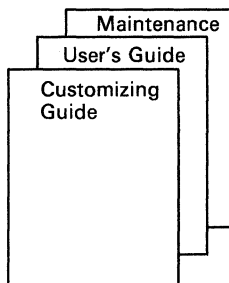
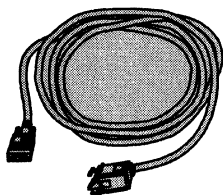

Items shown with gray shading may not be included with your machine.

## Setting Up Model 1L

Read through the setup instructions completely before doing the setup tasks. Then return to step 1 and do the instructions, step by step. To keep track of your progress, put a check in the box (☐) beside the action you complete.

You will be handling diskettes, so familiarize yourself with the correct and incorrect ways of handling diskettes.

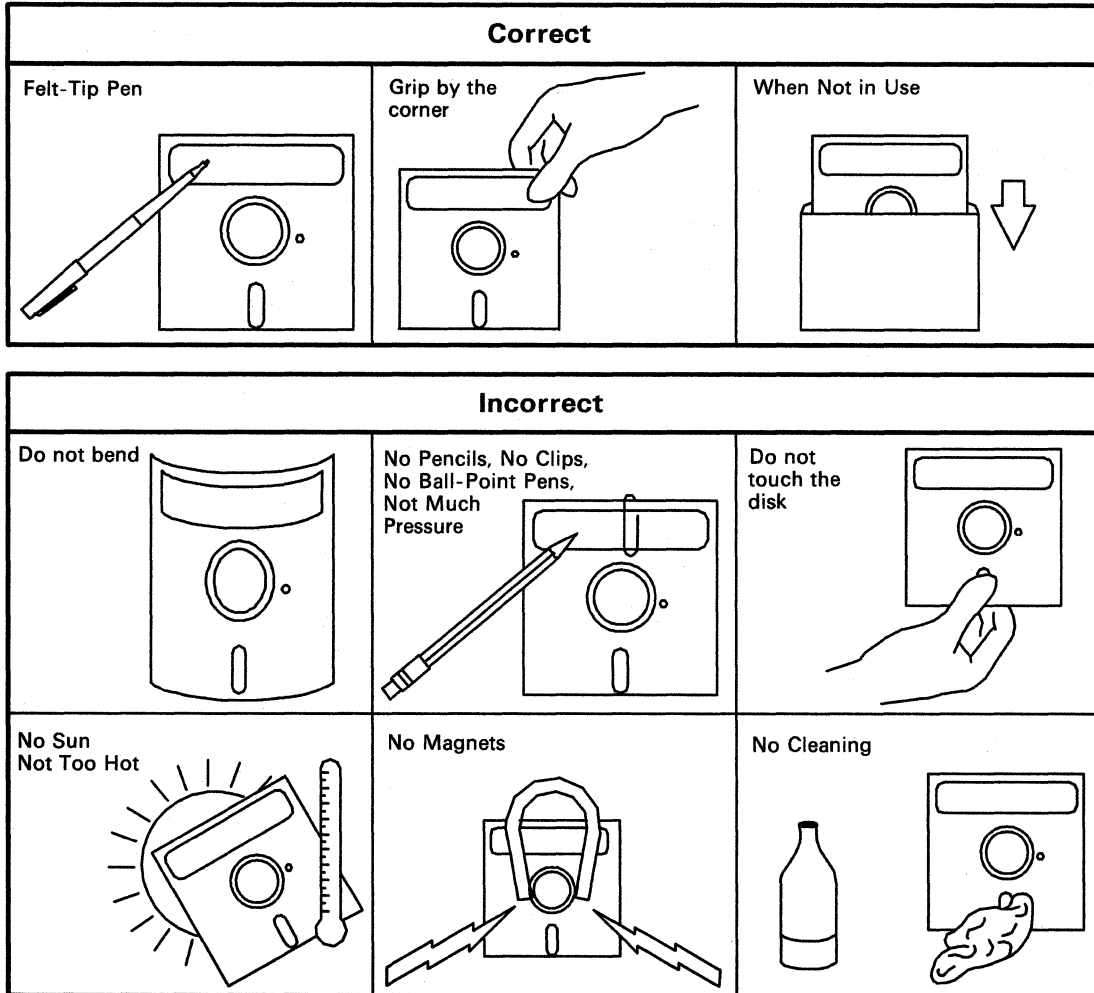

**1**

- Press the latch-release pushbutton on the left-center edge of the front door, and open the door.

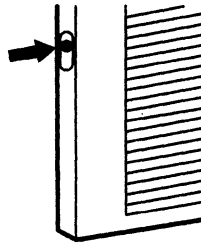

- Turn the **Channel Interface** switch to **Offline**.

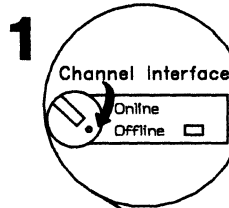

- Press the **Power** switch to **O** (off), and turn the **Power Control** switch to **Local**.

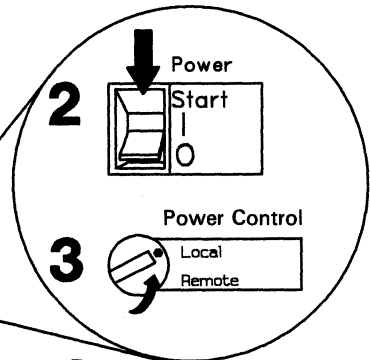

- Pass the power cable through either bottom-front-corner opening, and plug it into an electric outlet that is connected to ground.

- For control units with the **IBM Token-Ring Network 3270 Gateway** feature, plug the Token-Ring cable into the connector on the Token-Ring Adapter (card location 12), and tighten the thumbscrews. Pass the cable through one of the bottom openings in the control unit.

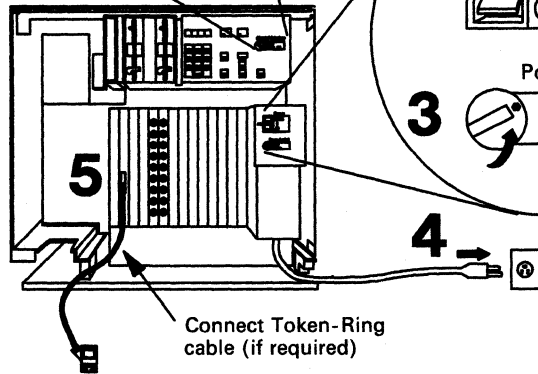

- Close the front door.

**2 Installing the diskette(s):**

- Open the lever to each diskette drive, and remove the cardboard insert. Store the insert(s) in the storage compartment, on the back of the front door, for future use.

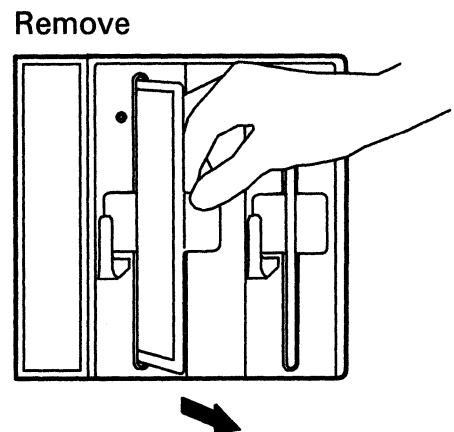
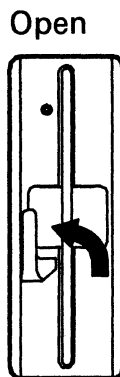

## Setting Up Model 1L

- Remove the Utility diskette from the protective envelope. Holding the diskette by the label, with the label facing left, insert the diskette into diskette drive 1 (left drive).

If you have two diskette drives, you must insert the Control diskette into diskette drive 2 (right drive).

- Close the lever to each drive.

For each diskette drive:

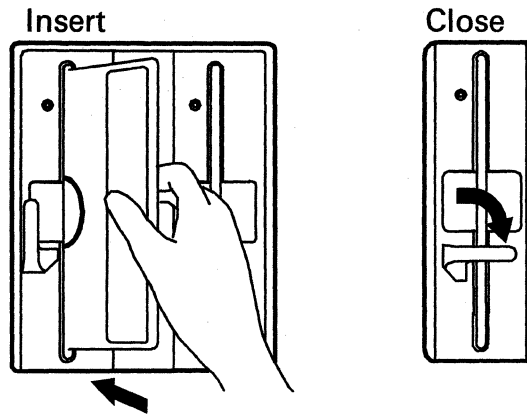

### 3 Testing the control unit:

For this step, if the correct numbers do not appear in the Status display, refer to Figure 3-1 on page 3-3 .

- Press and hold down **Alt 1**, and lift the **Power** switch to **Start**. Release the **Power** switch (it returns to the I position).

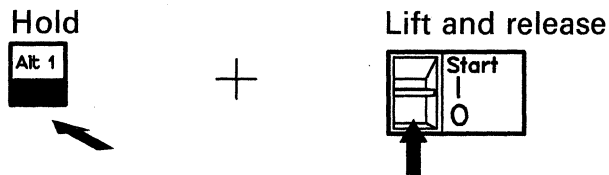

- Continue holding **Alt 1** until **31** appears in the **Status** display. Then release **Alt 1**.

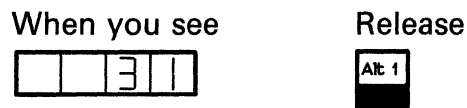

- When **40** appears in the **Status** display, key in **81** using the operator keypad. Make sure that the correct numbers are in the display. If you keyed in a wrong number, press **Clear** and try again.

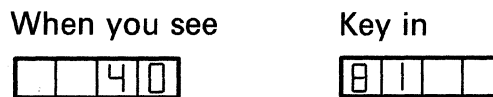

- Press **Enter**.

Tests run, and progress numbers appear in the **Status** display of the operator panel. The tests run between 1 and 3 minutes.

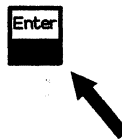

When the tests are completed successfully, **2081** appears and remains in the **Status** display.



## 4

- Open the lever to each diskette drive, and remove the diskette.
- Put each diskette into its protective envelope, and store each in the diskette storage pocket.

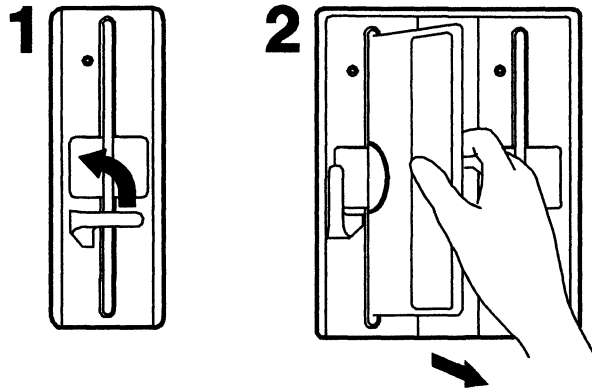

---

**Customer Setup is now completed.**

---

**THE NEXT STEPS...**

To make the control unit operational, terminal and host cables must be attached to the control unit, and the control unit must be customized.

For control units with the Token-Ring Network 3270 Gateway feature, the Token-Ring cable must be connected to the Token-Ring access unit.

For help with attaching terminal cables, refer to the cabling worksheets and the cabling instructions supplied by your organization.

For help with customizing the control unit, refer to the *IBM 3174 Subsystem Control Unit: Customizing Guide*, GA23-0214, or follow local procedures.

An IBM service engineer must attach the host cables to the control unit.

**Storing Publications**

- Store this *User's Guide* and the *Maintenance Information* manual in the compartment on the back of the front door.
- Complete the yellow *User's Guide Location* card, and put it into the diskette storage pocket.
- Store the remainder of the publications in an accessible location.

## How to Relocate the 3174 Model 1L

When planning to relocate the control unit, consider these things:

- Packing**                      Decide whether you need to pack the control unit before moving it. It is recommended that the control unit be packed if it is going to another building. If you decide to pack the control unit, call your IBM marketing representative and order a set of packing materials. Allow 4 weeks for delivery.
- Site Preparation**            Use the procedures in the *IBM 3174 Subsystem Control Unit: Site Planning*, GA23-0213, to prepare the new location for the control unit.
- Scheduling**                   Relocate the control unit during a time other than regular working hours, or notify the users that computer service will be interrupted.  
  
Also, call your IBM service representative and plan to have an IBM service engineer present for the relocation procedures.

To begin, read through these instructions completely. Then return to step 1 and do the instructions, step by step.

To keep track of your progress, put a check in the box (☐) beside the action you complete.

---

### 1 Take the control unit offline:

- Ask the host operator to take the control unit offline.
- When the control unit is offline, turn the **Channel Interface** switch to **Offline**, and wait for the **Offline** indicator to light.
- Turn the **Power Control** switch to **Local**.
- Press the **Power** switch to **O**.
- Unplug the power cable from the electric outlet.

#### Channel Interface

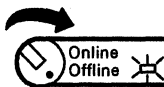

#### Power Control

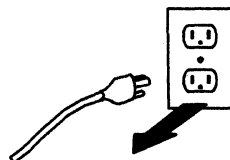
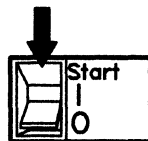

**2 Disconnect cables:**

- For control units with the Token-Ring Network 3270 Gateway feature, disconnect the Token-Ring cable from the wall connector or faceplate (the Token-Ring cable is connected to the Token-Ring Adapter in card location 12).

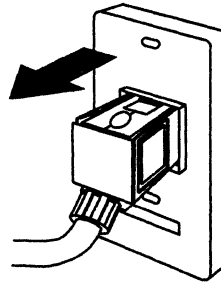

- Press the latch-release pushbutton on the left-center edge of the front door, and open the door.

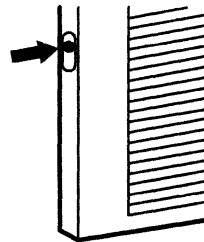

- Make sure that each terminal cable is labeled with its port number (labels are supplied by the customer).

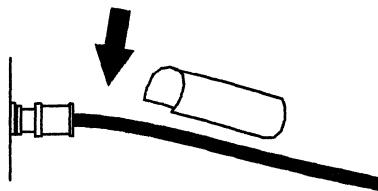

- **CAUTION:**  
**Do not disconnect terminal cables during an electrical storm.**

Disconnect all terminal cables from the control unit by turning the cable connectors counterclockwise and carefully pulling them off. Remove all terminal cables from the control unit.

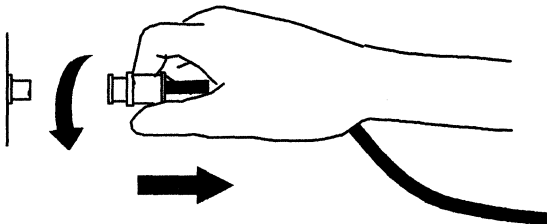

- Ask the IBM service engineer to disconnect the host cables from the control unit.

- Wind the power cable and, possibly, the Token-Ring cable, and store each in the control unit.

- Close the front door.

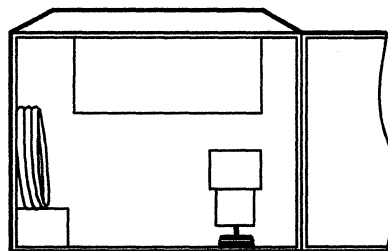



## Relocating Model 1L

### 3 Protect diskettes and diskette drives:

- Open the drive lever(s), and remove the diskette(s) from the diskette drive(s).

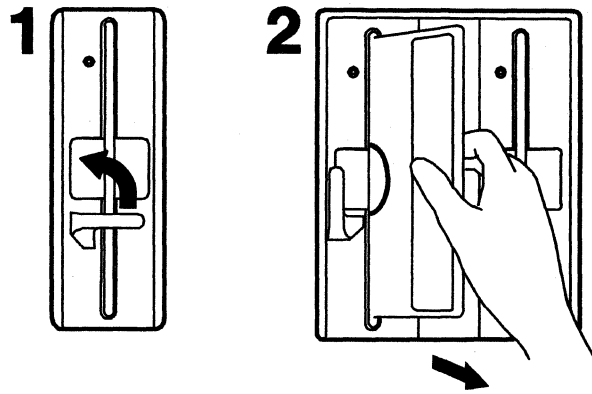

- Insert each diskette into a protective envelope, and store each in the diskette storage pocket.

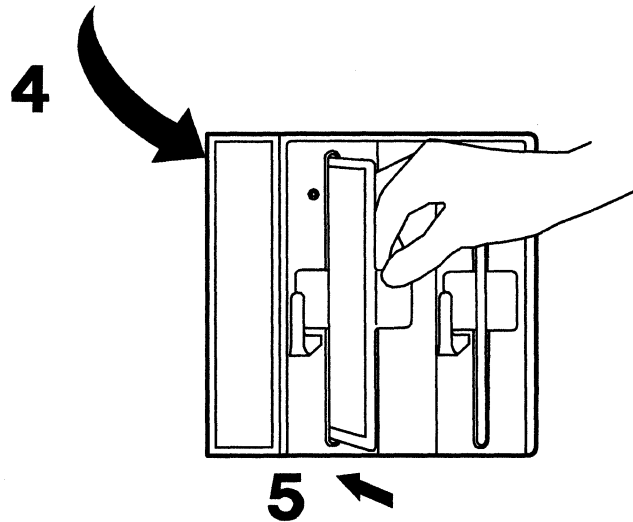
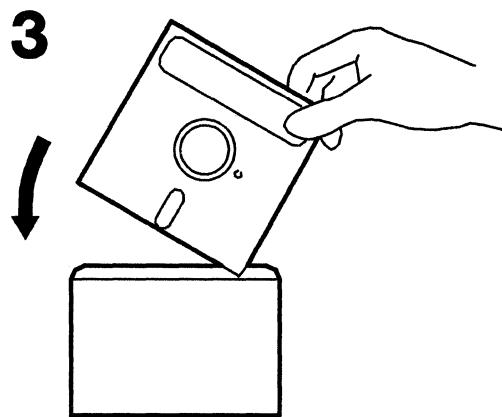

- Cardboard inserts should be in the storage compartment on the back of the front door. Put a cardboard insert into each diskette drive, and close the drive lever.

**4**

- If packing the control unit is necessary, read the instructions that came with the packing materials.
- Move the control unit to its new location.
- Unpack the control unit, if necessary.
- Do the setup procedures beginning on page 5-3.

# Models 1R, 2R, and 3R Setup and Relocation Instructions

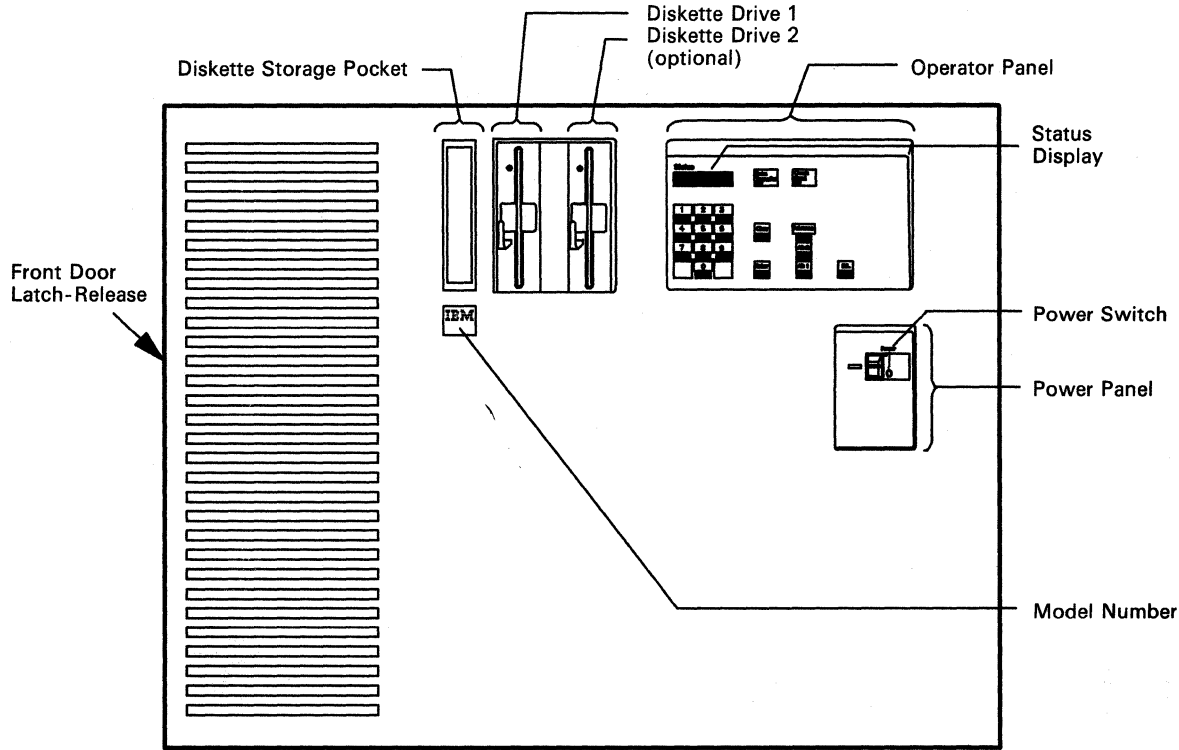

Models 1R, 2R, and 3R -- Front View

## How to Set Up the 3174 Models 1R, 2R, and 3R

These instructions tell you how to turn on the 3174 Control Unit Model 1R, 2R, or 3R, and to verify that it is operating correctly.

With the control unit, you should have received the following items:

- Two Control diskettes, a Utility diskette, and, possibly, one or more Downstream Load (DSL) or RPQ diskettes
- One of the following cables:
  - Communication cable, either EIA/V.24, or CCITT V.35 (Model 1R)
  - Communication cable, X.21 (Model 2R)
  - Token-Ring Adapter cable (Model 3R)
- A package of publications that includes:
  - An *IBM 3174 Subsystem Control Unit: User's Guide*, GA23-0337
  - An *IBM 3174 Subsystem Control Unit: Customizing Guide*, GA23-0214 (U.S. only).

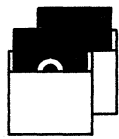
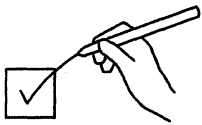

Control



Utility

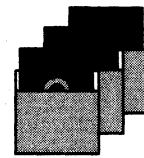

Downstream Load  
RPQ  
Encrypt/Decrypt

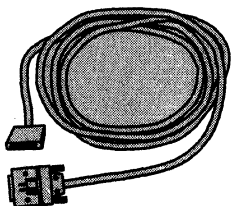

Communication  
Adapter  
Cable

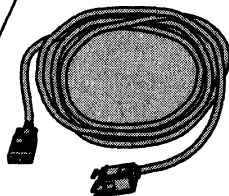

Token-Ring  
Adapter  
Cable

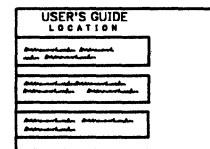
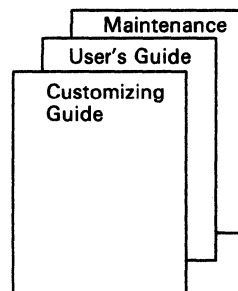

Items shown with gray shading may not be included with your machine.

## Setting Up Models 1R, 2R, and 3R

Read through these instructions completely before doing the setup tasks. Then return to step 1, and do the instructions, step by step. To keep track of your progress, put a check in the box (☐) beside the action you complete.

You will be handling diskettes, so familiarize yourself with the correct and incorrect ways of handling diskettes.

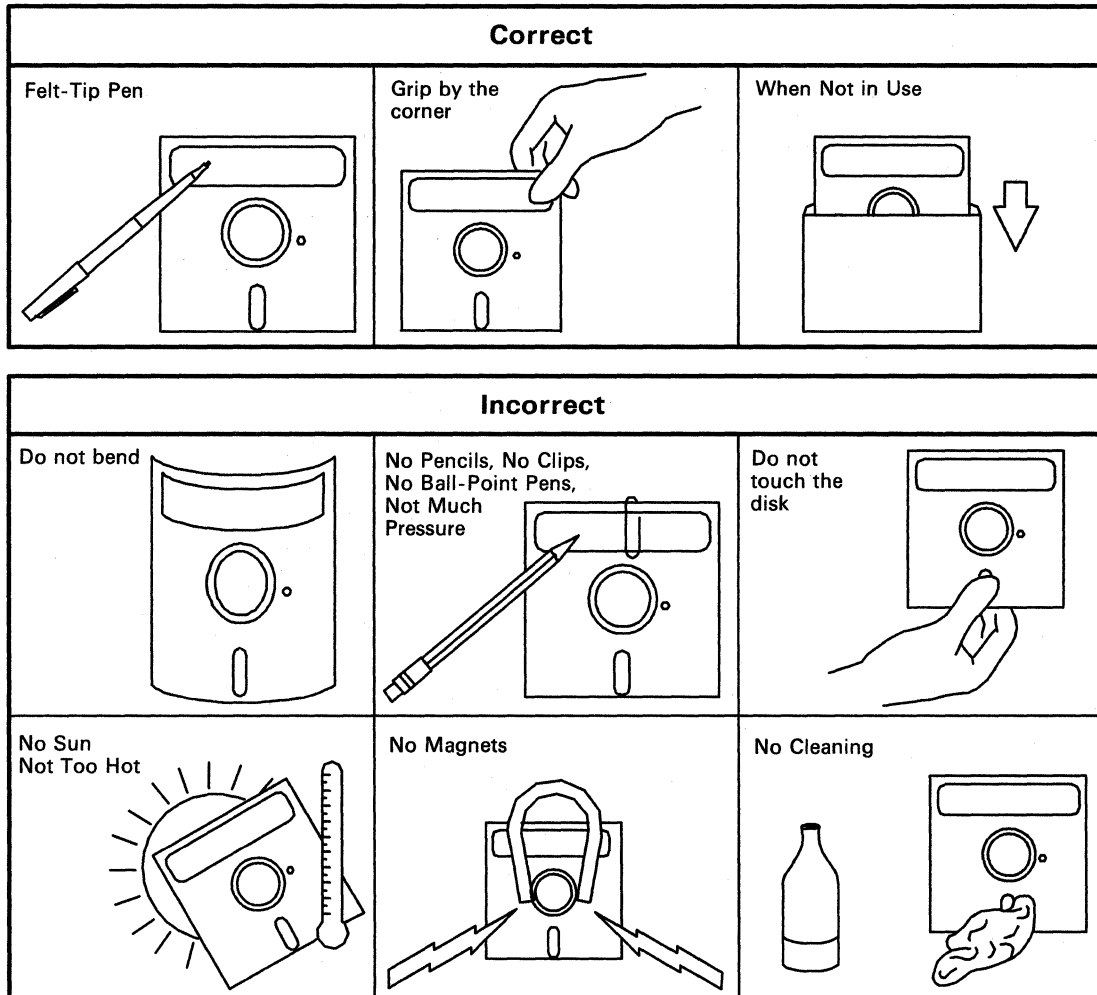

**1**

- Press the latch-release pushbutton on the left-center edge of the front door, and open the door.

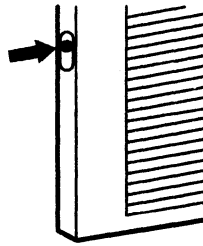

- Press the Power switch to **O** (off).

- For Models **1R** and **2R**, plug the communication cable into the connector on the Communication Adapter (card location 22), and tighten the thumbscrews. Pass the cable through one of the bottom openings in the control unit.

For Model **3R**, plug the Token-Ring cable into the connector on the Token-Ring Adapter (card location 11), and tighten the thumbscrews. Pass the cable through one of the bottom openings in the control unit.

- Pass the power cable through either bottom-front-corner opening, and plug it into an electric outlet that is connected to ground.

- Close the front door.

For Models **1R** and **2R**, go to step 2 on page 5-16.

For Model **3R**, go to step 3 on page 5-17.

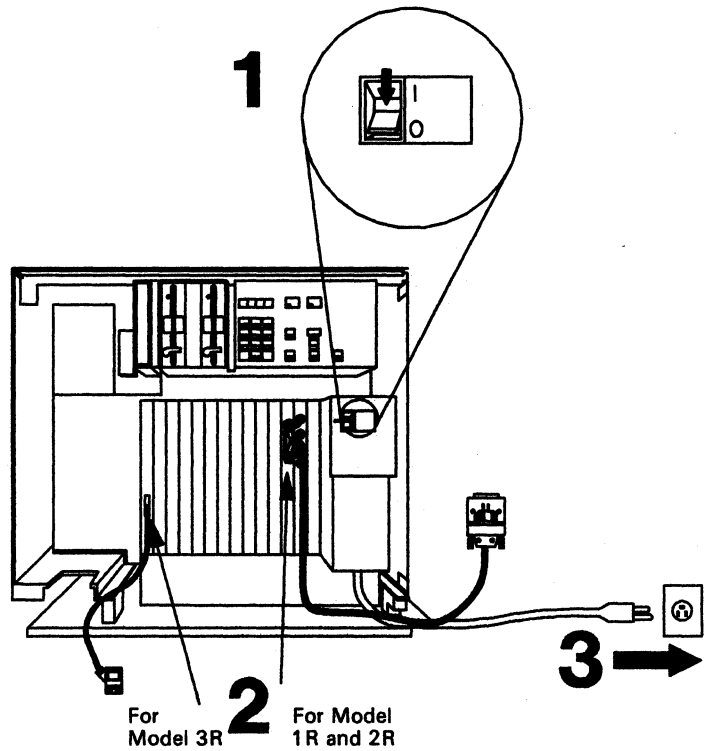

## Setting Up Models 1R, 2R, and 3R

### 2 Setting the switch(es) on the communication cable:

**Note:** This step is for Models 1R and 2R only.

- Set the **TEST/OPER** switch, on the communication cable attached to the modem, to the setting specified below for your cable part number.

- For cables with part number **6168155, 6423153, or 6423155:**

1. Set the **TEST/OPER** switch to **TEST**.
2. Go to step 3.

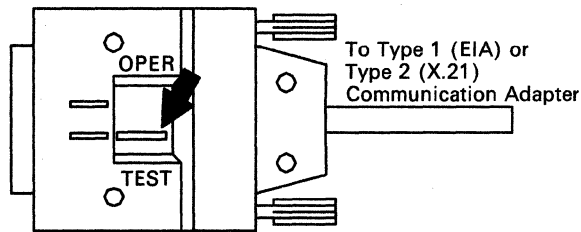

- For cables with **ONE TEST/OPER** switch and with part number **6423157, 6423325, or 6423326:**

1. Set the **TEST/OPER** switch to **OPER**.
2. Attach the wrap plug (part number 61X4603) to the connector.
3. Go to step 3.

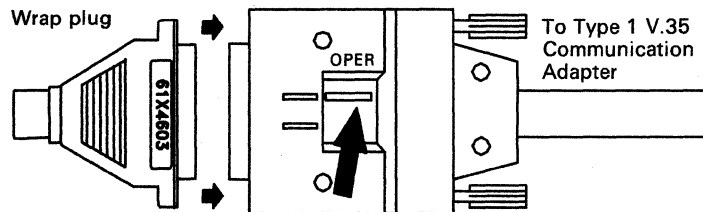

- For cables with **three TEST/OPER** switches:

1. Set all three switches to **TEST**.
2. Go to step 3.

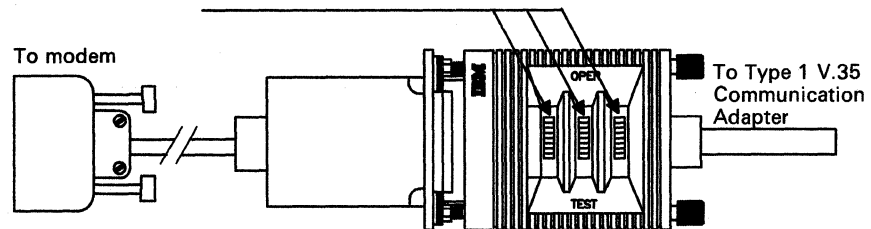

**3 Installing the diskette(s):**

- Open the lever to each diskette drive, and remove the cardboard insert. Store the insert(s) in the storage compartment, on the back of the front door, for future use.

Open

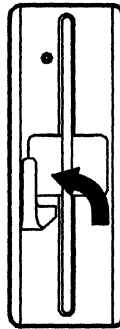

Remove

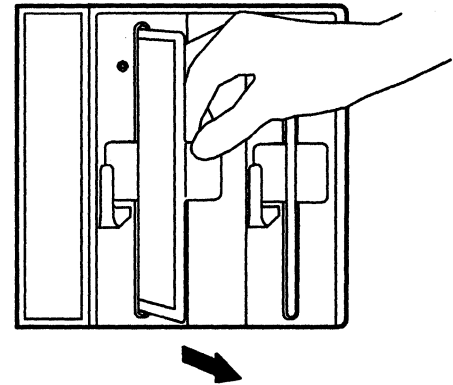

- Remove the Utility diskette from the protective envelope. Holding the diskette by the label, with the label facing left, insert the diskette into diskette drive 1 (left drive).

For each diskette drive:

Insert

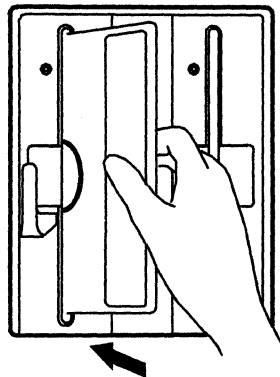

Close

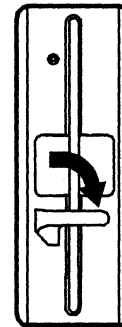

**If you have two diskette drives, you must insert the Control diskette into diskette drive 2 (right drive).**

- Close the lever to each drive.



## Setting Up Models 1R, 2R, and 3R

### 4 Testing the control unit:

For this step, if the correct numbers do not appear in the Status display, refer to Figure 3-1 on page 3-3.

- Press and hold down **Alt 1**, and lift the **Power** switch to **I**.

Hold



+

Lift and release

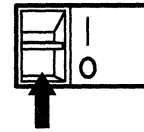

- Continue holding **Alt 1** until **31** appears in the **Status** display. Then release **Alt 1**.

When you see



Release



- When **40** appears in the **Status** display, key in **81** using the operator keypad. Make sure that the correct numbers are in the display. If you keyed in a wrong number, press **Clear** and try again.

When you see



Key in



- Press **Enter**.



Tests run, and progress numbers appear in the **Status** display of the operator panel. The tests run between 1 and 3 minutes.

When the tests are completed successfully, **2081** appears and remains in the **Status** display.



For **Model 1R or 2R**, go to step 5.

For **Model 3R**, go to step 6 on page 5-19.

### 5

- Set the **TEST/OPER** switch(es) on the communication cable to **OPER**.

**Note:** For V.35 communication cables with one switch, remove the wrap plug (the switch should already be set to **OPER**).

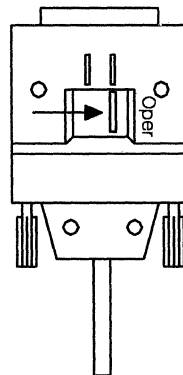

or

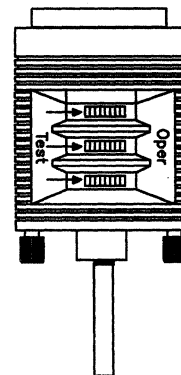

**6**

- Open the lever to each diskette drive, and remove the diskette.
- Put each diskette into its protective envelope, and store each in the diskette storage pocket.

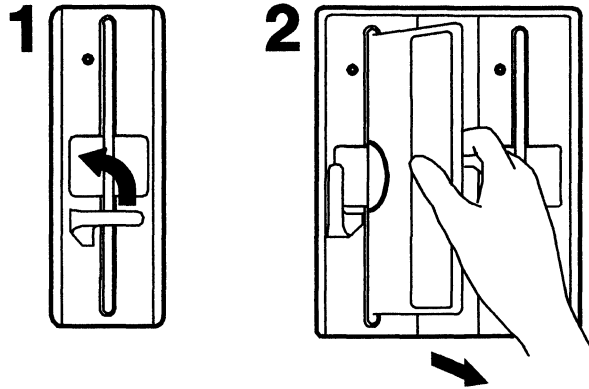

---

**Customer Setup is now completed.**

---

**THE NEXT STEPS...**

To make the control unit operational, terminal cables must be attached to the control unit, and the control unit must be customized. In addition, for Model 1R or 2R, the communication cable must be connected to a modem or other data circuit-terminating equipment. For Model 3R, the Token-Ring cable must be connected to the Token-Ring access unit.

For help with attaching terminal cables, refer to the cabling worksheets and the cabling instructions supplied by your organization.

For help with customizing the control unit, refer to the *IBM 3174 Subsystem Control Unit: Customizing Guide*, GA23-0214, or follow local procedures.

**Storing Publications**

- Store this *User's Guide* and the *Maintenance Information* manual in the compartment on the back of the front door.
- Complete the yellow *User's Guide Location* card, and put it into the diskette storage pocket.
- Store the remainder of the publications in an accessible location.

## How to Relocate the 3174 Models 1R, 2R, and 3R

When planning to relocate the control unit, consider these things:

- Packing** Decide whether you need to pack the control unit before moving it. It is recommended that the control unit be packed if it is going to another building. If you decide to pack the control unit, call your IBM marketing representative and order a set of packing materials. Allow 4 weeks for delivery.
- Site Preparation** Use the procedures in the *IBM 3174 Subsystem Control Unit: Site Planning*, GA23-0213, to prepare the new location for the control unit.
- Scheduling** Relocate the control unit during a time other than regular working hours, or notify the users that computer service will be interrupted.

To begin, read through these instructions completely. Then return to step 1, and do the instructions, step by step.

To keep track of your progress, put a check in the box () beside the action you complete.

---

### 1 Take the control unit offline:

- Ask the host operator to take the control unit offline.
- When the control unit is offline, press the **Power** switch to **O**.
- Unplug the power cable from the electric outlet.

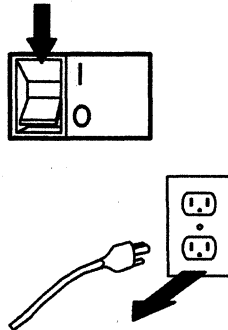

**2 Disconnect cables:**

- For Models 1R and 2R, disconnect the communication cable from the modem.

For Model 3R, disconnect the Token-Ring cable from the wall connector or faceplate.

For Models 1R and 2R:

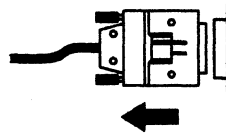

For Model 3R:

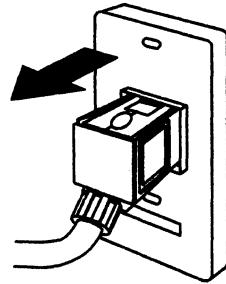

- Press the latch-release pushbutton on the left-center edge of the front door, and open the door.

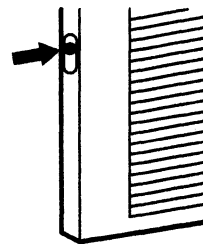

- Make sure that each terminal cable is labeled with its port number (labels are supplied by the customer).

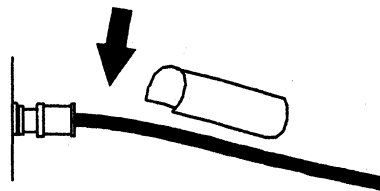

- **CAUTION:**  
Do not disconnect terminal cables during an electrical storm.

Disconnect all terminal cables from the control unit by turning the cable connectors counterclockwise and carefully pulling them off. Remove all terminal cables from the control unit.

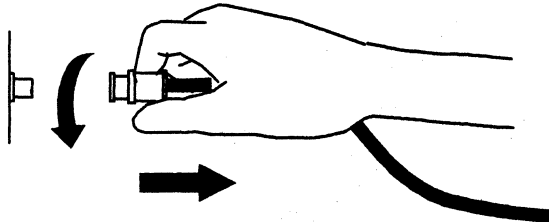

- Wind the power cable and the communication cable or Token-Ring cable, and store them in the control unit.

- Close the front door.

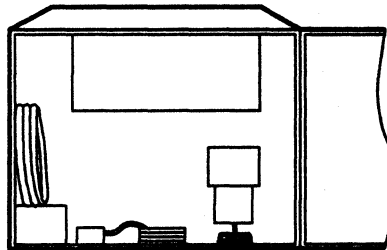

## Relocating Models 1R, 2R, and 3R

### 3 Protect diskettes and diskette drives:

- Open the drive lever(s), and remove the diskette(s) from the diskette drive(s).

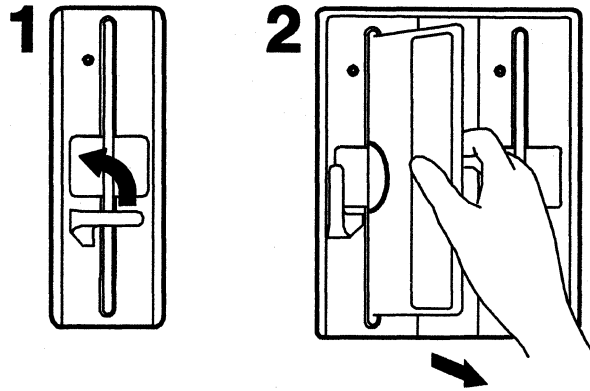

- Insert each diskette into a protective envelope, and store each in the diskette storage pocket.

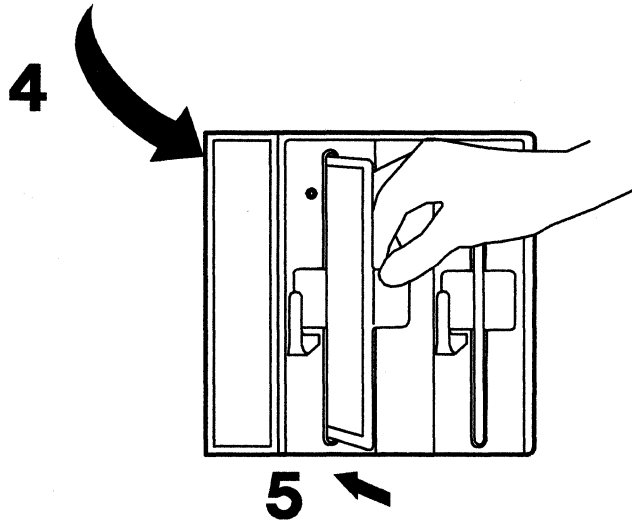
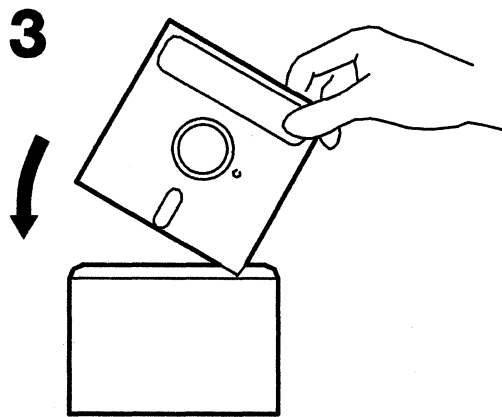

- Cardboard inserts should be in the storage compartment on the back of the front door. Put a cardboard insert into each diskette drive, and close the drive lever.

**4**

- If packing the control unit is necessary, read the instructions that came with the packing materials.
- Move the control unit to its new location.
- Unpack the control unit, if necessary.
- Do the setup procedures beginning on page 5-13.



---

## Appendix A. Online Tests

Online Test Summary	A-2
Entering and Exiting Test Mode	A-2
Displaying the Test Menu	A-3
Terminal Check – Test 0	A-4
Display Logs Menu – Test 1	A-5
Configuration Menu – Test 2	A-7
Display Status Summary – Test 3	A-9
Reset Log – Test 4	A-12
Vital Data – Test 5	A-13
Display Storage – Test 6	A-14
Color Convergence – Test 7	A-14
Extended Function and Program Symbols – Test 8	A-14
Token-Ring Test – Test 9	A-15
Definition of Token-Ring Status Codes	A-16
Definition of Token-Ring Adapter Fields	A-17
Definition of Link Fields	A-18
Online Port Test – Test 10	A-20
How to Run the Terminal Adapter Port Test	A-20
How to Run the TMA/3299 Model 2 Port Test	A-21
Test 12: Asynchronous Emulation Adapter Tests	A-22



### Online Test Summary

This appendix describes the online tests that allow you to examine control unit logs or to test selected portions of the subsystem without affecting working display stations or printers. You can use this ability from any 3178, 3278, 3279, or similar display station attached to the 3174.

**Note:** These tests cannot be run from a distributed function terminal (DFT), such as a 3290 Information Panel.

This appendix describes how to:

- Display the Test Menu
- Run a Terminal Check (Test 0)
- Display the Logs Menu (Test 1)
- Display the Configuration Menu (Test 2)
- Display a Status Summary of all attached devices (Test 3)
- Reset logs and cable errors (Test 4)
- Display vital data (Test 5)
- Run Token-Ring tests (Test 9)
- Run port tests (Test 10)
- Run Asynchronous Emulation Adapter tests (Test 12).

This description is limited to those online logs and tests that can help you identify and correct a problem in the subsystem. The *3174 Customer Extended Problem Determination* contains a complete description of all online logs and tests.

---

### Entering and Exiting Test Mode

To display the Test Menu or to run online tests, place your terminal in test mode.

To *enter* or *exit* test mode, press and hold down **ALT**, press **TEST**, and release both keys.

---

## Displaying the Test Menu

The Test Menu (Figure A-1) contains a list of online tests and error logs. To display the Test Menu, do these steps at a working terminal keyboard:

1. Press and hold down **ALT**, and press **TEST**. Release both keys. Your terminal is now in test mode.
2. Press **PF12**, or **Clear**, or **PA2** to display the Test Menu.

**Note:** On terminals with Data Entry keyboards, press **PA2** to display the Test Menu.

3. Select the desired test, type in the correct number, and press **ENTER**.

```

                _____ 3174 Test Menu _____
Select test, press ENTER

Test      Description
0         Terminal check
1         Display event logs and response time log
2         Display configuration panels
3         Display status summary
4         Reset logs and cable errors
5         Display vital data
6         Display storage
7         Color convergence
8         Extended functions and program symbols
9         Display Token-Ring test menu
10        Port wrap tests
11        Trace control
12        Asynchronous Emulation Adapter tests
A         Alerts
D,n      Dump device on port n (n=0-31)

Select test; press ENTER ==>_
PF: 3=Quit
```

Figure A-1. 3174 Test Menu

---

## Terminal Check – Test 0

Use Test 0 to check the communication path between the 3174 and its attached terminals.

You can select Test 0 by using the Test Menu (Figure A-1 on page A-3) or by doing these steps:

1. Press and hold down **ALT**, and press **TEST**. Release both keys. Your terminal is now in test mode.
2. `/0` or `/` to run Test 0 on the terminal you are working on.
3. Press **ENTER**.

**Note:** `nnmm` is the port address of the terminal requesting the test.

```

                Terminal Check
            _____
                3174 Controller
Hardware Group   nn
Port number     mm

?SEL PEN      SEL PEN
      &SEL PEN >SEL PEN
      DISPLAY INSERT CK

To go directly to other tests, enter: /Test,Option
Select test; press ENTER ==>_

PF: 3=Quit                12*=Test menu
```

\* On terminals with Data Entry keyboards, PA2 is displayed instead of PA12.

Where:

- `nn` = The adapter HG number of the terminal that requested the test.
- `mm` = The port number of the terminal that requested the test.
- `NON` = The nondisplay field that should not appear on the screen.

Figure A-2. Test 0 Display Pattern

## Display Logs Menu – Test 1

Test 1 provides a Response Time Log and error statistics for terminals, hardware groups, and ports. You select Test 1 by using the Test Menu (Figure A-1 on page A-3) or by doing these steps:

1. Press and hold down **ALT**, and press **TEST**. Release both keys. Your terminal is now in test mode.
2. Type **/1** and press **ENTER** to display the Logs Menu (Figure A-3).
3. To display a specific event log, type in the option number of the desired error log and press **ENTER**. (See Figures A-4 and A-5.)

```

                _____ Logs Menu _____
Select option, press ENTER

Option      Description          (Current log mode: Normal)

  1         Response time log
  2         All events logged
  3,n       Hardware group (n=0-99)
  4,n,m     Port (n=0-31), Hardware Group (m=0-99)
  5,xxxx   Status code (replace x's with search digits)
  6,n      Logical terminal (n=0-254)
  7         Change log mode (normal/intensive)

To go directly to other tests, enter: /Test,Option
Select option; press ENTER ==>_

PF: 3=Quit          12*=Test Menu
    
```

\* On terminals with Data Entry keyboards, PA2 is displayed instead of PA12.

Figure A-3. Test 1 Menu

```

                @ = NNN
/1,1
@  DEF   CTR#1  BDY#1  CTR#2  BDY#2  CTR#3  BDY#3  CTR#4  BDY#4  OV
00  1     10    0.5   11,415  1.0    316    5.0    21    1:00.0  6
01p 1     0     0.5    0       1.0    0       5.0    0     1:00.0  0
02 ? 1    651   0.5    0       1.0    0       5.0    0     1:00.0  14,458
03 *2    251   0.5    512    1.0     56     5.0    0     1:00.0  1

04i 1 *   31    1.0    11     2.0    4,371  5.0    4     10.0    2
05_ 1     0     0.5    0       1.0    0       5.0    0     1:00.0  0
06 *3 *   1     1.0    61     2.0    4       3.0    0     4.0     45
07  1    1,415  0.5    890    1.0    323    5.0    0     1:00.0  1,381

PF:3 = Quit          8=Fwd          12*=Test menu
    
```

\* On terminals with Data Entry keyboards, PA2 is displayed instead of PA12.

Figure A-4. RTM Log for Test 1, Option 1

# Online Test Summary

Log Records - PN 21, HG 26										
(Day/Time since last POR: 115/13:07)										
Day	Time	SC	QA	PHG_PN	CHG_PN	LT	Extended data			
111	23:12	nnnn	nn	26_21	23_07	111	xxxx	xxxx	xxxx	xxxx
111	22:12	nnnn	nn	16	26_21		xxxx	xxxx	xxxx	xxxx
110	21:12	nnnn	nn	26_21	16		xxxx	xxxx	xxxx	xxxx
106	20:13	nnnn	nn	26_21			xxxx	xxxx	xxxx	xxxx
105	02:02	nnnn	nn	16	26_21		xxxx	xxxx	xxxx	xxxx
104	03:03	nnnnPnn					xxxx	xxxx	xxxx	xxxx
100	06:04	nnnnPnn					xxxx	xxxx	xxxx	xxxx
100	05:04	nnnn	nn	26_21	21_02	111	xxxx	xxxx	xxxx	xxxx
099	01:01	nnnn	nn	22_04	26_21	111	xxxx	xxxx	xxxx	xxxx
098	16:23	nnnn	nn	26_21	22_05	111	xxxx	xxxx	xxxx	xxxx
011	23:16	nnnn	nn	26_21	23_01	111	xxxx	xxxx	xxxx	xxxx

SC=Status Code	QA=Qualifier	HG=Hardware group	PN=Port number
PHG_PN=PrimaryHG_PN	CHG_PN=ConnectionHG_PN	LT=Logical terminal	

To go directly to other tests, enter: /Test,Option  
 Select Test; press ENTER => \_

PF: 3=Quit                      8=Fwd                      12\*=Test menu

\* On terminals with Data Entry keyboards, PA2 is displayed instead of PA12.

Figure A-5. Log Record Display Panel for Test 1, Options 2 through 6

## Configuration Menu – Test 2

Test 2 displays configuration information, customizing panels, the printer authorization matrix, and the Asynchronous Emulation Adapter configuration.

**Note:** Configuration panel 118 is not displayed.

You select Test 2 by using the Test Menu (Figure A-1 on page A-3) or by doing these steps:

1. Press and hold down **ALT**, and press **TEST**. Release both keys. Your terminal is now in test mode.
2. Type **/2** and press **ENTER** to display the Configuration Menu (Figure A-6).
3. Select an option from the menu, type the option number (1, 2, or 3), and press **ENTER**. (See Figure A-7.)

```

                Configuration Menu
            _____
Select option, press ENTER

Option  Description
    1   Hardware configuration
    2   Configuration questions
    3,n  Printer authorization matrix for entry n (n=1-31)
    4   Asynchronous Emulation Adapter configuration

To go directly to other tests, enter: /Test,Option
Select option; press ENTER ==>_

PF: 3=Quit          12*=Test Menu
  
```

\* On terminals with Data Entry keyboards, PA2 is displayed instead of PA12.

Figure A-6. Test 2 Menu

**Option 1** displays the hardware configuration panel.

**Option 2** displays the configuration panels displayed during customization.

**Option 3** displays the printer authorization matrix.

**Option 4** displays the Asynchronous Emulation Adapter configuration panels.

For more information about Options 2, 3, and 4, refer to the *3174 Customizing Guide*.

Online Test Summary

Hardware Configuration Table

HG	TYPE	LC	DESCRIPTION	SC	HG	TYPE	LC	DESCRIPTION	SC
00	9001	00	Invalid Card/Cond		22	9540	62	AEA Cable Assembly	
01	9154	21	File Adpt		23	933X	12	Asynch Emul Adpt	
01	9110	01	Diskette Drive 1	32XX	23	9540	63	AEA Cable Assembly	
02	9110	02	Diskette Drive 2		26	9154	21	Terminal Adapter	
08	9500	18	Timer		26	9172	15	Term Mpx Adpt. 00-07	
09	9010	05	Ops Panel Adpt		26	9172	16	Term Mpx Adpt 08-15	
09	9010	05	ops panel adpt		26	9172	16	term mpx adpt 08-1	
09	9521	06	Ops Panel Assembly		26	9172	11	Term Mpx Adpt 16-23	
11	9253	22	Type 1 Com Adpt-XXX		26	9172	12	Term Mpx Adpt 24-31	
11	927X	22	Type 2 Com Adpt-XXX		31	9350	12	Token-ring Adpt	
16	9210	11	Channel Adpt		46	9030	25	Enc/Decrypt Adpt	
16	9230	10	Channel Drv/Rcvr		87	9051	19	Storage 512K	
21	933X	14	Asynch Emul Adpt		87	9051	20	Storage 512K	
21	9540	61	AEA Cable Assembly		87	9052	19	Storage 1MEG	
22	933X	13	Asynch Emul Adpt		87	9053	19	Storage 2MEG	

Select Test; press ENTER ==> \_

PF: 3=Quit                                 12=Test Menu

Where:

- HG = Hardware group
- TYPE = FRU Type number
- LC = FRU location
- SC = Status code

This field contains a 32XX number only if a problem has occurred with a FRU during an IML.

**Note:** This table shows the maximum configuration for Models 1L, 1R, 2R, and 3R of the 3174. Only those FRUs that are physically installed are displayed in this table. 1 megabyte of base storage is available. Either two 512K-byte cards are installed or one 1M-byte card. Up to 3 megabytes of storage can be installed.

For the communication adapters, the XXX = one of the following:

- WRP = EIA/V.35 wrap plug is connected.
- V.35 = V.35 cable is connected.
- EIA = EIA cable is connected.
- NC = Nothing is connected.
- X.21 = X.21 cable is connected.
- WRP = X.21 wrap plug is connected.
- INV = An undefined cable or wrap plug is connected.

Figure A-7. Hardware Configuration Table for Test 2, Option 1

## Display Status Summary – Test 3

This test displays the status of all configured devices. This information is very useful when you are trying to determine the kind and extent of a subsystem problem.

You select Test 3 by using the Test Menu (Figure A-1 on page A-3) or by doing these steps:

1. Press and hold down **ALT**, and press **TEST**. Release both keys. Your terminal is now in test mode.
2. Type **/3** and press **ENTER**. The Status Summary panel (Figure A-8) is displayed.

```

                _____
                Status Summary - HG 26
                _____

Port          00 02 04 06 08 10 12 14 16 18 20 22 24 26 28 30
Address      01 03 05 07 09 11 13 15 17 19 21 23 25 27 29 31

Attach       m m m m m m m m d                x m m m m m m m m m m m m m m m
Status       1 1 1 1 0 0 1 0 1 0 0 0 0 0 0 0 0 - - 1 0 s 1 1 0 1 0 0 1 0 0 1
Terminal     v v v v ? v v v p                p p v v v v v v v v i i v v v
Cable        . . . . . : . .                . . . | . . . . . : . . . . .
Cable Max    . . . . . * : . .                . . : * . . : . . . . . : : *
Host         3 3 3 A      3 A 3                3   3   x x 3       3
LU           + + +      +   +                +                   +   +

d = direct      - = off(error)      i = DFT device      . = 0 errors
m = multiplexer x = unconfigured    ? = unknown        : = 1-5 errors
1 = on          p = printer          + = in session     | = 6-15 errors
0 = off         v = video display    3=3270  A=ASCII    * = 16 or more errors
                s = switched

Connection Number: Outgoing call 914-555-1234

To go directly to other tests, enter: /Test,Option
Select option; press ENTER ==>_

PF: 3=Quit                12*=Test Menu
    
```

\* On terminals with Data Entry keyboards, PA2 is displayed instead of PA12.

Figure A-8. Test 3 Menu



## Online Test Summary

The lines displayed are explained below:

<b>Line</b>	<b>Meaning</b>
<b>Port Address</b>	Indicates the terminal port number (00 – 31).
<b>Attach</b>	<p>A “d” on this line means that the terminal connected to the associated port number is attached directly to the Terminal Adapter or to a terminal multiplexer (TMA or 3299).</p> <p>An “m” means that the terminal is attached to a multiplexer (TMA or 3299).</p> <p>A question mark (?) displayed on this line under port 00, 08, 16, or 24 means one of the following:</p> <ul style="list-style-type: none"><li>• The control unit has not communicated with a directly attached terminal</li><li>• The control unit has not communicated with any of the terminals connected to a Terminal Multiplexer Adapter (TMA)</li><li>• The control unit has not communicated with any of the terminals connected to a 3299 Terminal Multiplexer.</li></ul> <p>A question mark (?) displayed under 01 to 07, 09 to 15, or 17 to 23 means that the control unit has not communicated with that particular terminal.</p>
<b>Status</b>	Indicates whether the attached terminal has power on, has power off, is not configured, or is off because of an error.
<b>Terminal</b>	<p>Indicates the type of device connected.</p> <p>A question mark (?) displayed on this line means that the control unit has not communicated with that terminal. To establish communication with the control unit, set the <b>Normal/Test</b> switch on the terminal to <b>Test</b>, then to <b>Normal</b>. Or, on some displays, turn power off, and then on again.</p> <p>A v, p, or i on this line indicates the terminal for this port has a known history of communicating with the 3174.</p> <p><b>Note:</b> If a terminal or multiplexer cable is disconnected and then reconnected, a terminal power-on reset is required for the 3174 to recognize the change. The cable counter is reset by an IML, or by a power-on reset on the attached terminal, or by online test 4.</p> <p>If the subsystem cable configuration is changed, then an IML is required for the change to appear on this <b>Terminal</b> line.</p> <p>A distributed function terminal (DFT), such as a 3290, can use up to five consecutive port addresses. The “i” appears at the primary address assigned to the DFT.</p>
<b>Cable</b>	Terminal errors caused by cable media-related problems are counted by the cable counter for each port address. The cable counters accumulate the number of cable transmission errors occurring in the most recent 30-minute period. The cable counters are reset to 0 every 30 minutes, and error counting starts again. These counters are also reset by an IML, or by doing online test 4 and specifying option 2 or 3. Individual cable counters are reset when the attached terminal is switched on. When a cable counter exceeds 16 errors, status code 201 51 is recorded in the event log. The event log can be viewed (using online test 1) to determine the number of cable errors that have occurred over an extended time.

<b>Line</b>	<b>Meaning</b>
<b>Cable Max</b>	<p>The Cable Max counters retain the peak value attained by the Cable Threshold counters over an extended time. They are not reset every 30 minutes, but only by an IML, or by doing an online test 4 and specifying option 2 or 3.</p> <p><b>Note:</b> The Cable Max counter may be incremented when the Normal/Test switch is sequenced on the attached terminal or when the terminal is switched on.</p>
<b>Host</b>	<p>This line represents the type of host to which a terminal is connected or if no host is configured. For MLT ports, a blank, a 3, or an A represents the foreground session only.</p> <p>Blank = No current host.            x = No host sessions configured.            3 = IBM host connection is established.            A = Asynchronous Emulation Adapter host connection is established.</p>
<b>LU</b>	<p>This line is present only for control units running SNA. It indicates whether the SNA session is bound or active. For MLT ports, the + indicates that an SNA session is active.</p> <p>The connection number is for X.21 or X.25 lines. Incoming and outgoing calls differ as follows:</p> <ul style="list-style-type: none"> <li>• Outgoing Call X.25: 15-character host DTE (Data Terminal Equipment) address or 32-character buffer as entered in dial for X.21</li> <li>• Incoming Call X.25: 15-character host DTE address</li> <li>• Outgoing Call X.21: Direct call</li> <li>• Incoming Call X.21: No characters.</li> </ul>

## Reset Log – Test 4

Test 4 resets the response time log or the event logs.

You select Test 4 by using the Test Menu (Figure A-1 on page A-3) or by doing these steps:

1. Press and hold down **ALT**, and press **TEST**. Release both keys. Your terminal is now in test mode.
2. Type **/4** and press **ENTER** to display the Reset Log Menu (Figure A-9).
3. Type 1 or 2:  
Type 1 and press **ENTER** to reset the response time log.  
Type 2 and press **ENTER** to reset the event log.

```
          _____ Reset Log Menu _____  
  
Select option, press ENTER  
  
Option      Description  
  1         Reset response time log  
  2         Reset event log, traces and cable errors  
  3         Reset cable errors  
  
To go directly to other tests, enter: /Test,Option  
  
Select option; press ENTER ==>_  
  
PF: 3=Quit                12*=Test Menu
```

\* On terminals with Data Entry keyboards, PA2 is displayed instead of PA12.

Figure A-9. Test 4 Menu

## Vital Data – Test 5

This test displays information about the control unit, such as model and serial number, current microcode release, patches, and RPQs (optional and special features). You may need this information when reporting problems to IBM service.

You select Test 5 by using the Test Menu (Figure A-1 on page A-3) or by doing these steps:

1. Press and hold down **ALT**, and press **TEST**. Release both keys. Your terminal is now in test mode.
2. Type /5 and then press **ENTER**. The Vital Data panel (Figure A-10) is displayed.

```

                Vital Data
    _____

Help ## 914-555-5555 or 914-555-1212 after 5; IBM ## 914-555-1234

Model Number          n          Active Patches*  Active RPQs
Controller ID         1234567
Microcode Release     A3.0
Maintenance Release   86186

DSL Information:
3290 01.02 0000000000
3179 01.00 0000000000

To go directly to other tests, enter: /Test,Option
Select option; press ENTER ==>_

PF: 3=Quit                12**=Test menu
  
```

\* If more than 30 patches are installed on the control, PF8 = FWD displays of this panel.

\*\* On terminals with Data Entry keyboards, PA2 is displayed instead of PA12.

Figure A-10. Test 5 Menu

---

## **Display Storage – Test 6**

For Test 6 details, refer to the *3174 Customer Extended Problem Determination*, GA23-0217.

---

## **Color Convergence – Test 7**

For Test 7 details, refer to the *3174 Customer Extended Problem Determination*, GA23-0217.

---

## **Extended Function and Program Symbols – Test 8**

For Test 8 details, refer to the *3174 Customer Extended Problem Determination*, GA23-0217.

## Token-Ring Test – Test 9

Test 9 provides a test facility to check the status of the Token-Ring, the Token-Ring Adapter, and attached links. This test also provides the ability to reset the status counters for the adapter and the attached links.

You select this test by using the Test Menu (Figure A-1 on page A-3) or by doing these steps:

1. Press and hold down **ALT**, press **TEST**, and release both keys. Your terminal is now in test mode.
2. Type **/9** and press **ENTER** to display the Token-Ring Test Menu (Figure A-11).

Token-Ring Test Menu	
Select option; press ENTER	
Option	Description
1	Monitor Token-Ring status
2	Display Token-Ring adapter status summary
3	Reset Token-Ring adapter status counters
4	Display link status summary for all links
5,n	Display link status summary for link address n
6	Reset link status counters for all links
7,n	Reset link status counters for link address n
8	Display Gateway host status summary
To go directly to other tests, enter: /Test,Option	
Select option; press ENTER ==> _	
PF: 3=Quit	12*=Test menu

\* On terminals with Data Entry keyboards, PA2 is displayed instead of PA12.

Figure A-11. Token-Ring Test Menu

**Option 1** displays the Token-Ring Status Test panel (see Figure A-12 on page A-16).

**Option 2** displays the Token-Ring Adapter status summary (see Figure A-13 on page A-17).

**Option 3** resets the Token-Ring Adapter status counters.

**Option 4** displays the link status summary for all links (see Figure A-14 on page A-18).

**Option 5** displays the link status summary for the link selected in the test request.

**Option 6** resets the link status counters for all links.

**Option 7** resets the link status counters for the link selected in the test request.

**Option 8** displays the status summary of the Gateway Host (see Figure A-15 on page A-19).

```

                _____
                | Token-Ring Status Test |
                |_____                |
4697 - Local Token-Ring Adapter opened
4698 - Local Token-Ring Adapter closed
4691 - Signal Loss (Adapter not detecting ring signal)
4692 - Hard Error (Adapter detecting a beacon condition
internally, or receiving a Beacon MAC frame)
4693 - Wire Fault (Adapter has detected a wire fault)
4694 - The test has been active for #### minutes
4695 - The test will terminate in # minutes
       Press PF9 to continue for another 10 minutes

To go directly to other tests, enter: /Test,Option
Select option; press ENTER ==>_

PF: 3=Quit          9=Cont          12*=Test menu

```

\* On terminals with Data Entry keyboards, PA2 is displayed instead of PA12.

Figure A-12. Token-Ring Status Test Panel

### Definition of Token-Ring Status Codes

Code	Definition
4697	This message indicates that the Token-Ring Adapter is open.
4698	This message indicates that the Token-Ring Adapter is closed. The status of the ring before the adapter closed is also displayed.
4691	This message is displayed when the Token-Ring Adapter detects a signal-loss condition on the ring.
4692	This message is displayed when the Token-Ring Adapter detects a beaconing condition.
4693	This message is displayed when the Token-Ring Adapter detects a wire fault (open or short).
4694	This message indicates how long the ring test has been active.
4695	This message is displayed after the test has been running for 10 minutes. The test runs for another 5 minutes and terminates automatically. If PF9 is pressed within this 5-minute time frame, the test runs for 10 minutes and 4695 is displayed again.

```

_____ Token-Ring Adapter Status Summary _____
Adapter Address - XXXXXXXXXXXX      Adapter Status -   XXXXXX
Customized Links - XXX              Active Links   -   XXX

                                Counters      Overflow
Line Errors                    XXXXXX      0
Internal Errors                XXXXXX      0
Burst Errors                   XXXXXX      0
ARI/FCI Errors                 XXXXXX      0
Abort Delimiters               XXXXXX      0
Lost Frames                    XXXXXX      0
Receive Congestion            XXXXXX      0
Frame Copied Errors            XXXXXX      0
Frequency Errors               XXXXXX      0
Token Errors                   XXXXXX      0

To go directly to other tests, enter: /Test,Option
Select option; press ENTER ==>_

PF: 3=Quit                      12*=Test menu

```

\* On terminals with Data Entry keyboards, PA2 is displayed instead of PA12.

Figure A-13. Token-Ring Adapter Status Summary Panel

### Definition of Token-Ring Adapter Fields

Field	Definition
<b>Adapter Address</b>	The 6-byte Token-Ring address of the Token-Ring Adapter (determined at configuration)
<b>Adapter Status</b>	The Token-Ring Adapter's physical state relative to the Token-Ring (open or closed)
<b>Customized Links</b>	The number of links identified during configuration of the control diskette
<b>Active Links</b>	The number of links active at the time the test request was entered

The Token-Ring Adapter Status Summary also displays the number of particular error events and the state of the overflow flag.



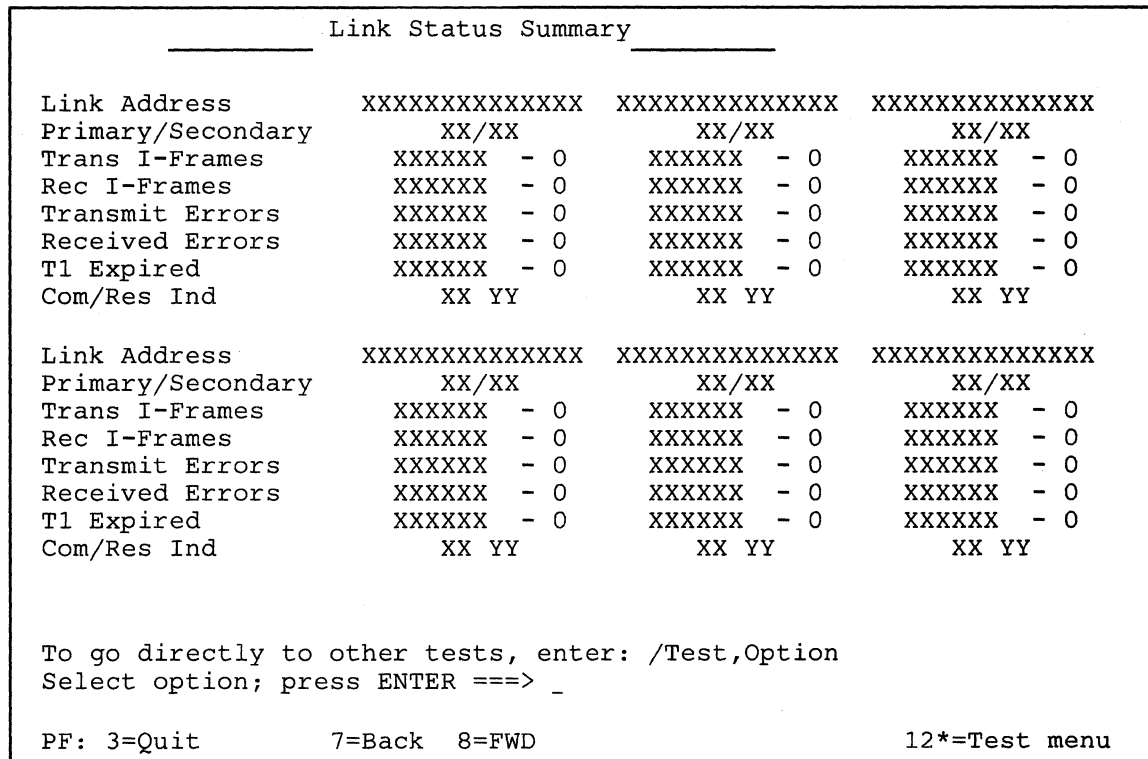

\* On terminals with Data Entry keyboards, PA2 is displayed instead of PA12.

Figure A-14. Link Status Summary Panel

The Link Status Summary panel displays the link address, the data link control (DLC) primary and secondary states, the command/response indicator, and the logical link station counters.

### Definition of Link Fields

Field	Definition
<b>Link Address</b>	The station address assigned to each link during configuration.
<b>Primary/Secondary</b>	The DLC primary and secondary states for the link station.
<b>Trans I-Frames</b>	The number of I-frames transmitted.
<b>Rec I-Frames</b>	The number of I-frames received.
<b>Transmit Errors</b>	The number of transmit errors.
<b>Receive Errors</b>	The number of receive errors.
<b>T1 Expired</b>	The number of times the T1 timer expired.
<b>Com/Res Ind</b>	WW XX indicates the last command/response received. YY ZZ indicates the last command/response sent.

Gateway Host Status Summary					
Customized Links - XXX			Address Range - XX-XX		
Host Address	Link Status	Token-Ring Address	Host Address	Link Status	Token-Ring Address
XX	XX	XXXXXXXXXXXXXX	XX	XX	XXXXXXXXXXXXXX
XX	XX	XXXXXXXXXXXXXX	XX	XX	XXXXXXXXXXXXXX
XX	XX	XXXXXXXXXXXXXX	XX	XX	XXXXXXXXXXXXXX
XX	XX	XXXXXXXXXXXXXX	XX	XX	XXXXXXXXXXXXXX
XX	XX	XXXXXXXXXXXXXX	XX	XX	XXXXXXXXXXXXXX
XX	XX	XXXXXXXXXXXXXX	XX	XX	XXXXXXXXXXXXXX
XX	XX	XXXXXXXXXXXXXX	XX	XX	XXXXXXXXXXXXXX

To go directly to other tests, enter: /Test,Option  
 Select option; press ENTER ==>\_

PF: 3=Quit      7=BACK      8=FWD      12\*=Test menu

\* On terminals with Data Entry keyboards, PA2 is displayed instead of PA12.

Figure A-15. Gateway Host Status Summary for Test 9, Option 8

## Online Port Test – Test 10

Test 10 allows you to test the operation of selected ports on the Terminal Adapter, on a Terminal Multiplexer Adapter (TMA), or on a 3299 Model 2. After running the test, you will get a message telling you the results of the test.

**Note:** If the selected port is in use, the test will not be run and you will get a message telling you the port is busy.

Two procedures are described here. The first procedure tells you how to test a Terminal Adapter port (Direct Wrap). The second procedure tells you how to test a TMA/3299 Model 2 port.

### How to Run the Terminal Adapter Port Test

You select this test by using the Test Menu (Figure A-1 on page A-3) or by doing these steps:

1. Press and hold down **ALT**, press **TEST**, and release both keys. Your terminal is now in test mode.
2. Type `/10` and press **ENTER** to display the Port Wrap Test panel (Figure A-16).

```
          Port Wrap Test
-----
Select option, press ENTER.

Option Description

 1,n      Direct Wrap for port n
 2,n      3299/Terminal Multiplexer wrap for port n (n=0-31)

To insure a valid wrap, the cable must
be disconnected from the wrapped port.

To go directly to other tests, enter: /Test,Option
Select options; press ENTER ==>>_

PF: 3=Quit          12*=Test Menu
```

\* On terminals with Data Entry keyboards, PA2 is displayed instead of PA12.

Figure A-16. Test 10 – Port Wrap Test Menu

3. Type `1,n`

**Note:** *n* can be 00, 08, 16, or 24 (Terminal Adapter port numbers).

**Examples:**

- To test Terminal Adapter port 0: Type `1,00`
- To test Terminal Adapter port 8: Type `1,08`

4. Press **ENTER** to start testing. Testing is completed in 30 seconds.
5. A text message and a status code appear on the message line, indicating whether the test ran successfully.
6. To run another test, press the return key and go to step 3 of this procedure.

When you have completed testing, press and hold down **ALT**, press **TEST**, and release both keys. Your terminal is now out of test mode.

## How to Run the TMA/3299 Model 2 Port Test

You select this test by using the Test Menu (Figure A-1 on page A-3) or by doing these steps:

1. Press and hold **ALT**, press **TEST**, and release both keys. Your terminal is now in test mode.
2. Type **/10** and press **ENTER** to display the Port Wrap Test panel (see Figure A-16).
3. Type in **2,*n*** where *n* is the port number (00 through 31) of the terminal being tested.
4. Press **ENTER** to start testing. Testing is completed in 30 seconds.
5. A text message and a status code appear on the message line, indicating whether the test ran successfully.
6. To run another test, press the return key and go to step 3 of this procedure.

When you have completed testing, press and hold down **ALT**, press **TEST**, and release both keys. Your terminal is now out of test mode.

## Test 12: Asynchronous Emulation Adapter Tests

Test 12 provides a test facility for terminals, ports, and smart modems attached to an Asynchronous Emulation Adapter (AEA). It also provides a status summary for all ports of the three Asynchronous Emulation Adapter HGs, and allows line errors to be reset for an individual Asynchronous Emulation Adapter port or for all ports of a specific Asynchronous Emulation Adapter HG. When Test 12 is selected, the menu shown in Figure A-17 is displayed. Perform the following procedure at any 3278 or similar display station, or at an ASCII display station:

1. Press and hold ALT; press TEST.
2. Key in /12
3. Press ENTER; the Asynchronous Emulation Adapter Tests Menu is displayed.

_____ Asynchronous Emulation Adapter Tests _____	
Option	Description
1	AEA port test menu
2	Display status summary
3	Reset line errors on all AEA HGs
3,n	Reset line errors on HG n (n=21-23)
Note:	
- Option 1 exits from 3174 TEST mode	
To go directly to other tests, enter: /Test,option	
Select option; press ENTER ==> _	
PF: 3=Quit	12=Test menu

Note: On terminals with Data Entry keyboards attached, PA2 is displayed instead of PA12.

Figure A-17. Test 12 Menu

**Option 1** displays the Asynchronous Emulation Adapter (AEA) port test menu, from which you can select a specific terminal, port, or smart modem to test. See Figure A-18 on page A-23 for an example of the test menu.

**Option 2** displays the status summary for the ASCII terminals on all 3 ASCII HGs. See Figure A-20 on page A-25 for an example of the status summary panel.

**Option 3** resets the line errors on all the ASCII HGs installed.

**Option 3,n** resets the line errors for the specific HG n.

Asynchronous Emulation Adapter Port Tests	
Option	Description
1,PN,HG	Connect to smart modem
2,PN,HG	AEA port wrap
3,PN,HG	Transmit data (default settings)
3,PN,HG,WXYYZZ	Transmit data (override settings)
PN=Port Number (0-7)    HG=Hardware Group (21-23) WXYYZZ=Override port and station descriptor values	
<b>NOTES:</b> - Use MENU REQUEST key sequence to return to this menu when above options are selected - Option 2 requires a wrap plug on requested port - Use TEST REQUEST key sequence to return to 3174 TEST mode	
Select option; press ENTER ==> _	
PF: 3=Quit	12=Disconnect

Note: On terminals with Data Entry keyboards attached, PA2 is displayed instead of PA12.

Figure A-18. Asynchronous Emulation Adapter Port Tests Menu

Options 1 through 3 are described in the following text:

- **Option 1:** Provides a facility to access and test a smart modem through its Asynchronous Emulation Adapter port, provided that port is not presently in session. Access and manipulation of the modem, using that modem's command syntax, enables the following:

- Modem Customization and Test

This function provides access to internal diagnostic and customization procedures built into certain smart modems. There are two reasons why this function is important:

1. By running diagnostics internal to the modem, you will be able to isolate a problem in the asynchronous communication equipment on a specific port, provided proper operation of the Asynchronous Emulation Adapter port has already been verified.
2. By customizing the modem to certain specifications, you can ensure proper operation or verify whether the modem has been customized correctly for normal operation.

- Modem Dial-Out Function

This function enables you to test the dial-out capability of the modem. By providing a number to the modem of a phone close-by or of an actual ASCII dial-in port, you can verify proper operation of the modem.

- **Option 2:** Provides access to an Asynchronous Emulation Adapter port not presently in session. This access allows you to perform a wrap test on the Asynchronous Emulation Adapter port.

**Note:** The Asynchronous Emulation Adapter wrap plug (PN 61X4602) must be installed on the port connector before you invoke the wrap test.

If a modem cable is attached to the port being tested, by installing a wrap plug at the modem end of that cable you can also test the cable.

- **Option 3:** Provides a means of verifying an ASCII terminal's ability to transmit and receive data correctly. From the invoking terminal, you can send data through the Asynchronous Emulation Adapter port connector to a terminal not presently in session. This test will verify the data path and the operation of the terminal receiving the data.

Example of Option 3,PN,HG Test:

1. At any ASCII terminal, terminate the customer application or session (if active) and return to the Connection Menu.
2. For most ASCII terminals, hold down Esc and press T to enter test mode. (For those terminals that do not accept Esc and T for test mode, refer to the *3174 Terminal User's Reference for Expanded Functions*, GA23-0332.)
3. At the 3174 Test Menu, select Option 12 (Asynchronous Emulation Adapter Tests).
4. At the Asynchronous Emulation Adapter Tests Menu, select Option 1 (AEA Port Test Menu).
5. At the AEA Port Test Menu, key in 3,PN,HG where:  
PN = Port Number (0-7) of the device being tested  
HG = Hardware Group (21, 22, or 23) of the device being tested.
6. Press Carriage Return.
7. The control unit responds with a READY message.
8. Perform steps a and b **only** if the device being tested is attached to a switched port with a smart modem. If the port is nonswitched, go to 9.
  - a. Key in ATD9,,XXX-XXXX where:  
ATD (uppercase characters) must be keyed in while the shift key is held  
9,, is the access code (optional) and 2-second pauses  
XXX-XXXX is the phone number of the smart modem attached to the device being tested.
  - b. Press Carriage Return.  
The control unit responds with a CONNECT message.
9. Key in a test message or any string of characters.  
**The message or characters will not appear on your terminal.**
10. Press Carriage Return.  
The data will appear on the device being tested.
11. You can then enter a test message at the device being tested and send it back to the invoking terminal by keying in the test message and pressing Carriage Return.
12. To return to the Asynchronous Emulation Adapter Tests Menu, press ESC, hold down CTRL, and press H.

The override settings, indicated by WXYZZ on the test menu, are parameters used by the control unit to communicate with ASCII devices. These parameters are entered during customization, and this test allows you to change them temporarily without changing the actual customization.

**Note:** If you enter override settings, you may also need to change the parameters on the ASCII device(s) you are testing.

Figure A-19 shows the values for WXYZZ.

W = Line Speed	X = Parity	YY = Flow Control	ZZ = Stop Bits
0 = Auto baud/parity	0 = Auto	00 = None	00 = One stop bit
1 = 300 bps	1 = Mark	10 = CTS	01 = Two stop bits
2 = 600 bps	2 = Space	20 = DTR	
3 = 1200 bps	3 = Even	80 = XON/XOFF	
4 = 2400 bps	4 = Odd		
5 = 4800 bps	7 = None		
6 = 9600 bps			
7 = 19 200 bps			

Figure A-19. WXYZZ Override Settings

Figure A-20 shows the status of the Asynchronous Emulation Adapter(s) and all devices attached to it. This panel is displayed by selecting Option 2 from the Asynchronous Emulation Adapter Tests Menu.

```

_____ Status Summary _____

Port                                HG 21                                HG 22                                HG 23
Address                             0 1 2 3 4 5 6 7                    0 1 2 3 4 5 6 7                    0 1 2 3 4 5 6 7

Attach                             d s d d 1   s 1
Status                             1 1 1 0 1 x 0 -                    (Disabled)                          (Not present)
Station                             v v v p h   ? h
Line                               . . : . .
Host/term                          3 A 3 3
LU                                  +  +

d = direct             1 = on                v = video display       . = 0 errors
1 = non-switched     0 = off              p = printer            : = 1-50
s = switched         - = disabled         h = host               | = 51-100
3 = 3270             x = unconfigured    ? = unknown            * = > 100
A = ASCII            + = in session

To go directly to other tests, enter: /Test,Option
Select test; press ENTER ==> _

PF: 3=Quit          12=Test menu
  
```

Note: On terminals with Data Entry keyboards attached, PA2 is displayed instead of PA12.

Figure A-20. Test 12 Status Summary Panel

The lines displayed are explained below:

- **Port Address:** Indicates the terminal port number (0–7) for HG 21, 22, or 23.
- **Attach:** Indicates how the terminal is attached to the Asynchronous Emulation Adapter port.
  - Blank = No attachment type (port unconfigured).
  - d = Direct attachment.
  - s = Switched attachment.
  - l = Leased line attachment.



## Online Test Summary

- **Status:** Indicates the state of the terminal at the time the status summary was requested.
  - Disabled = This Asynchronous Emulation Adapter is in the disabled state.
  - Not present = This Asynchronous Emulation Adapter is not installed in the control unit.
  - 0 = The terminal on that specific port is powered off (no current connection).
  - 1 = The terminal on that specific port is powered on (connection present).
  - x = The port is not configured.
  - = The terminal or specific port is in a disabled state (no connections possible, unusable).
- **Station:** Indicates the type of terminal to which that specific port is connected.
  - Blank = No station type (port unconfigured).
  - ? = Unknown station type (no station connected yet).
  - v = Video display station
  - p = Printer station
  - h = Host station
- **Line:** Indicates the number of parity, framing, and overrun errors that have been recorded on that particular port.
  - . = No errors recorded.
  - : = 1–50 errors recorded.
  - | = 51–100 errors recorded.
  - \* = Over 100 errors recorded.
- **Host/term:** Indicates the type of host with which the terminal is presently communicating.

When STATION type is “v” (video) or “p” (printer) and the Host/term line is:

  - Blank = No current host connection (if STATUS = 0 or -).
  - Blank = On Connection Menu (if STATUS = 1).
  - 3 = Connection to 3270 host.
  - A = Connection to ASCII host.

When STATION type is “h” (host) and the Host/term line is:

  - Blank = No terminal is currently connected to this host port.  
(If STATUS = 1, the attached terminal is either on the Connection Menu or awaiting the next connection).  
(If STATUS = 0, the attached terminal has either powered off or connected to another host destination).
  - 3 = A 3270 terminal is connected to this host.
  - A = An ASCII terminal is connected to this host.
- **LU:** Indicates whether or not the SNA session is bound and active.
  - Blank = Session is not bound.
  - + = Session is bound (on at least one logical terminal).



### 3174 Connection Overview

The model and features available will determine which of the adapters can be installed on each control unit.

#### 3174 Adapter Hardware Group Numbers

Each adapter in the control unit is identified by a name and Hardware Group (HG) number. It is important that you can identify which HG number is assigned to a particular adapter. This number is used when online tests are run. In addition, you may be asked to give the port number (PN) on the adapter.

3270 Terminal Adapter (TA)	HG = 26
Terminal Multiplexer Adapter (TMA)	HG = 26
ASCII Adapter(s)	HG = 21, 22, or 23
Token-Ring Adapters	HG = 31
IBM/3270 Host Communications (CA) Adapter	HG = 11
IBM/3270 Host Local Channel Adapter (LCA)	HG = 16

#### Terminal Adapter (HG = 26)

The 3270 Terminal Adapter (HG = 26) is used to connect nine 3270 type terminals directly, or up to 16 terminals via two Terminal Multiplexers, to the control unit. Every control unit has this adapter. The terminal connectors (ports) on this adapter can attach coaxial cable, the IBM Cabling System, or telephone wiring. For information on cabling, cable connectors, jacks, and supported terminals, see "How to Disconnect and Connect Cables" on page B-21.

#### ASCII Adapter (HG = 21, 22, or 23)

The ASCII Adapter (HG = 21, 22, or 23) is used to connect eight ASCII terminals and ASCII hosts (in any combination) to the control unit. The communication connectors (ports) on this adapter can attach more than one cable:

- To directly connected ASCII terminals or hosts
- To nonswitched modems and dedicated lines between modems
- To switched modems allowing access to the telephone network.

For information on cabling, cable connectors, jacks, communication links, and supported terminals, see "How to Disconnect and Connect Cables" on page B-21.

#### Token-Ring Adapter (HG = 31)

The Token-Ring Adapter (HG = 31) is used to connect the IBM 8228 Multi-Station Access Unit, which, in turn, is connected to the Token-Ring. The adapter has one connector (port) and supports only one connection between the control unit and the 8228 Multi-Station Access Unit.

## Establishing Communication

To begin an applications session between a terminal and a host, an **initial communication** takes place between the terminal and the control unit. This is begun by turning on the 3174 control unit and completing a normal IML (loading the operational microcode and configuration data into the control unit working storage).

Completion of a normal IML starts a *polling* sequence at the 3270 Terminal Adapter ports to see if a terminal is connected and turned on, and, if so, communication is established with the control unit.

Only one communication path is shown for clarity.

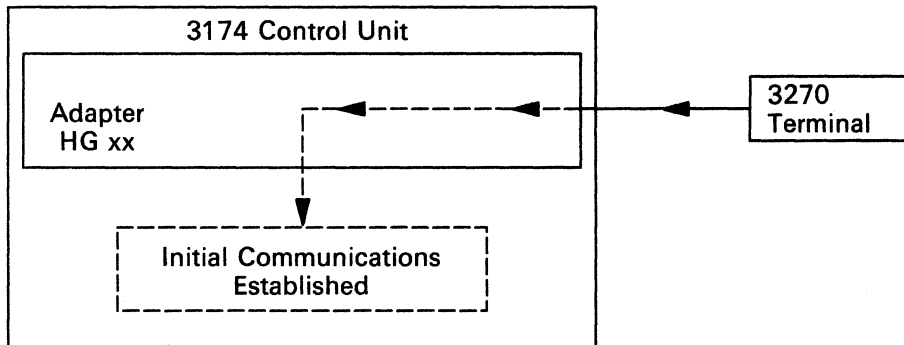

## 3174 Connection Overview

The IBM host initiates the communication between the host and the control unit. Once this communication is established, the host is ready to accept data from the devices (3270 terminals and printers, ASCII terminals, printers and hosts, and Token-Ring stations) connected to their respective control unit adapters.

Only one communication path is shown, for clarity.

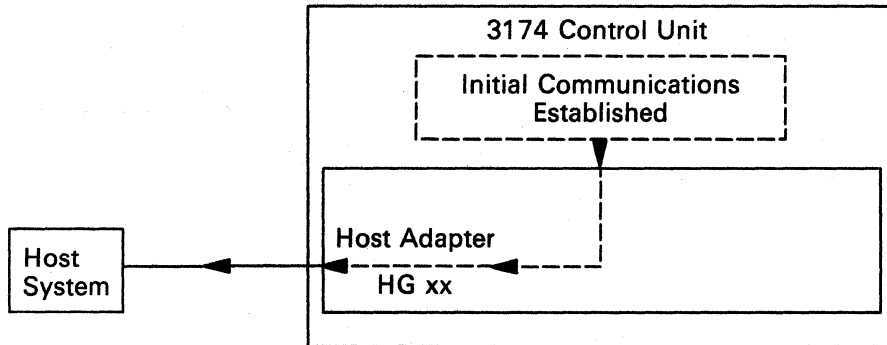

Once communication has been established, the operational microcode in the control unit provides the *path*, operational control, and protocol conversion between the terminal and the host system, according to customization parameters set by the customer.

Only one communication path is shown, for clarity.

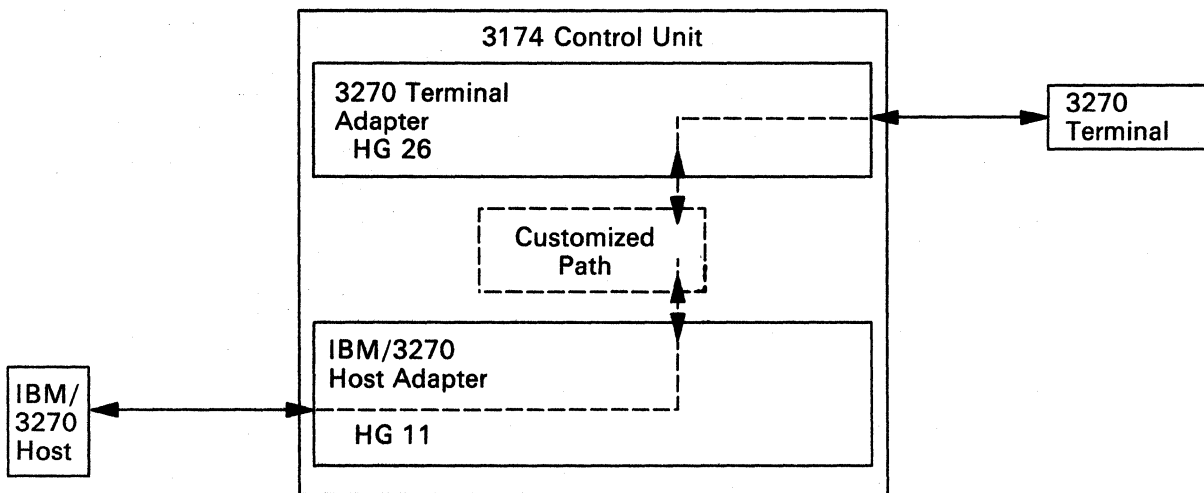

**Configurations**

Depending on the control unit model and the adapters installed, the control unit can be customized for a variety of configurations. The following are examples of how the 3174 Models 51R, 52R, and 53R can be customized:

1. A 3270 terminal can communicate with the IBM host in Models 51R and 52R.

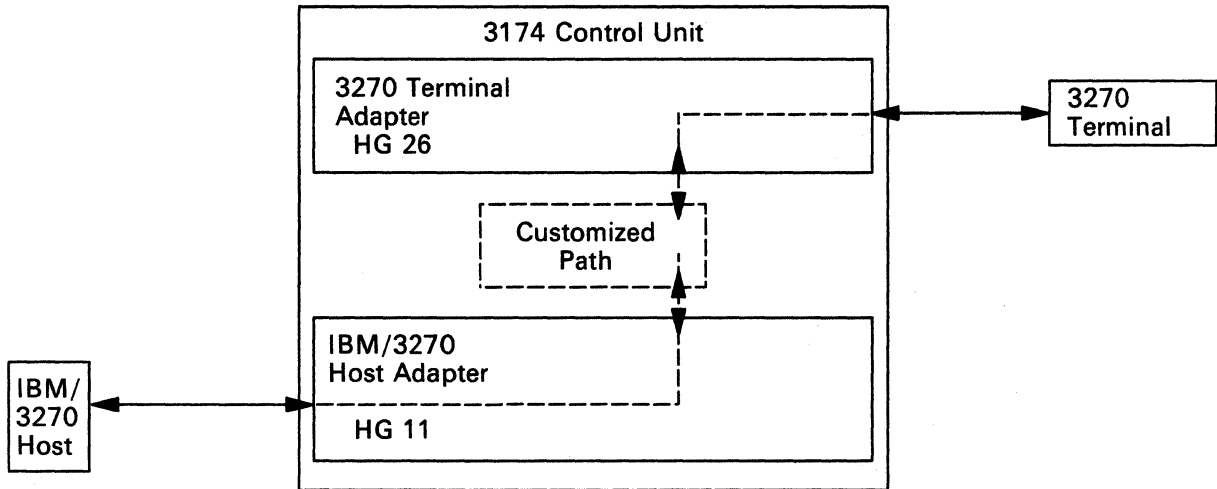

2. A 3270 terminal can communicate with the IBM host and ASCII hosts in Models 51R and 52R with the ASCII feature installed.

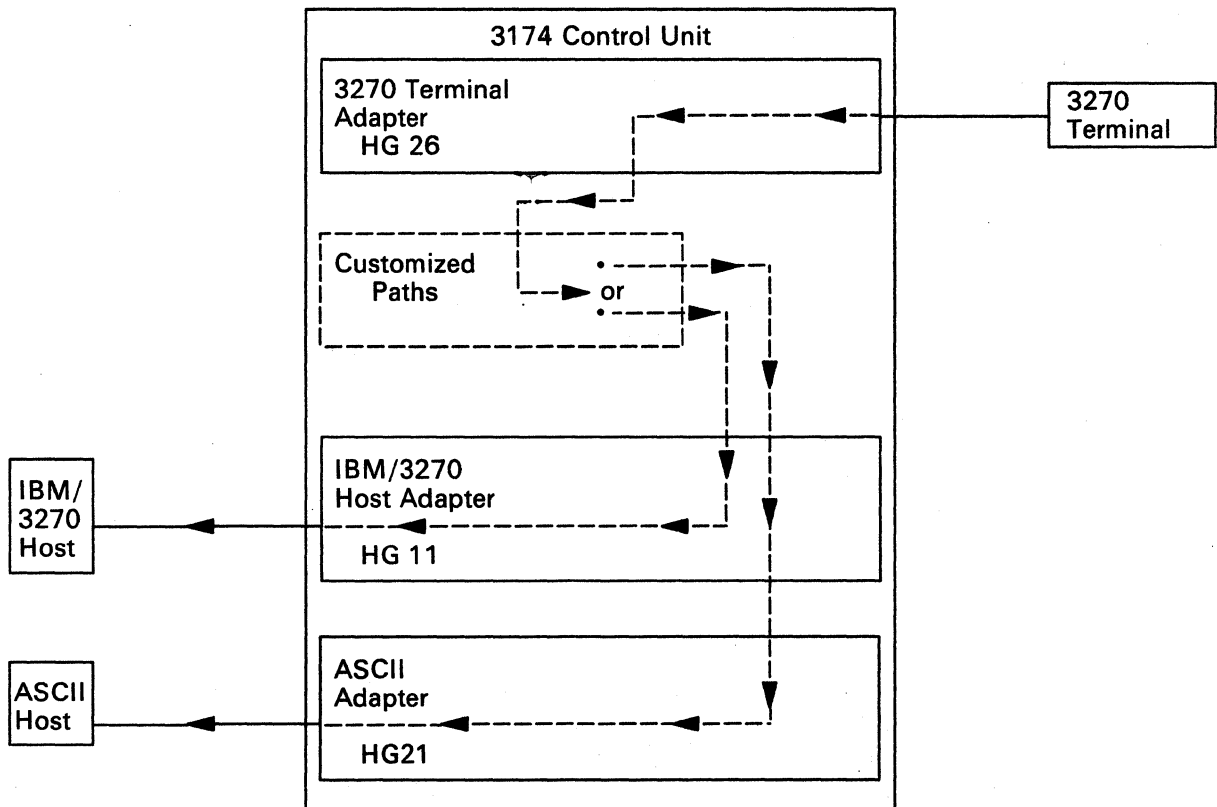

- 3. An ASCII terminal can communicate with the IBM host in Models 51R and 52R.

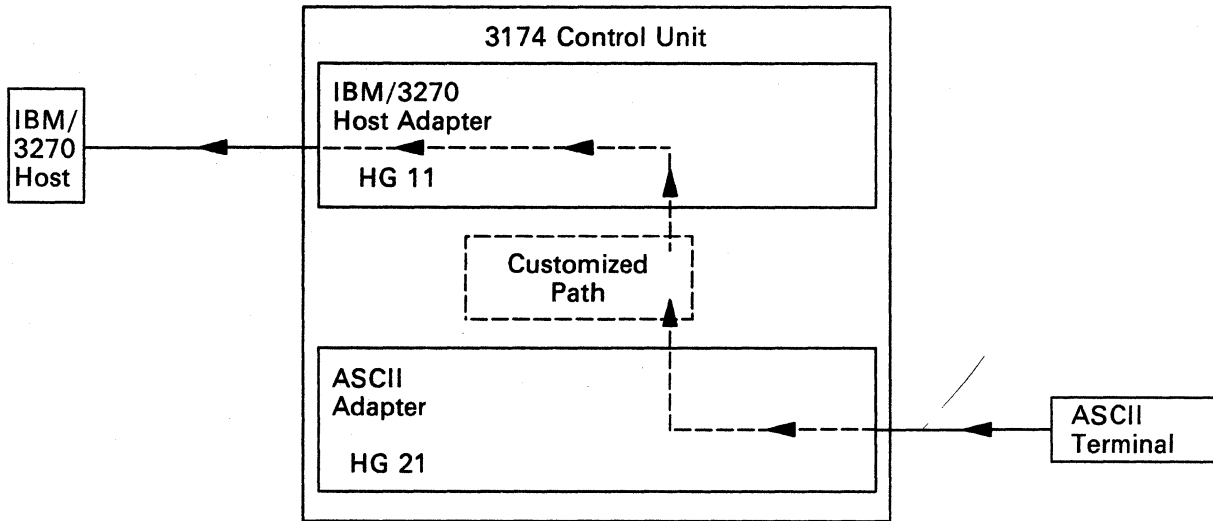

- 4. An ASCII terminal can communicate with one or more ASCII hosts in Models 51R and 52R.

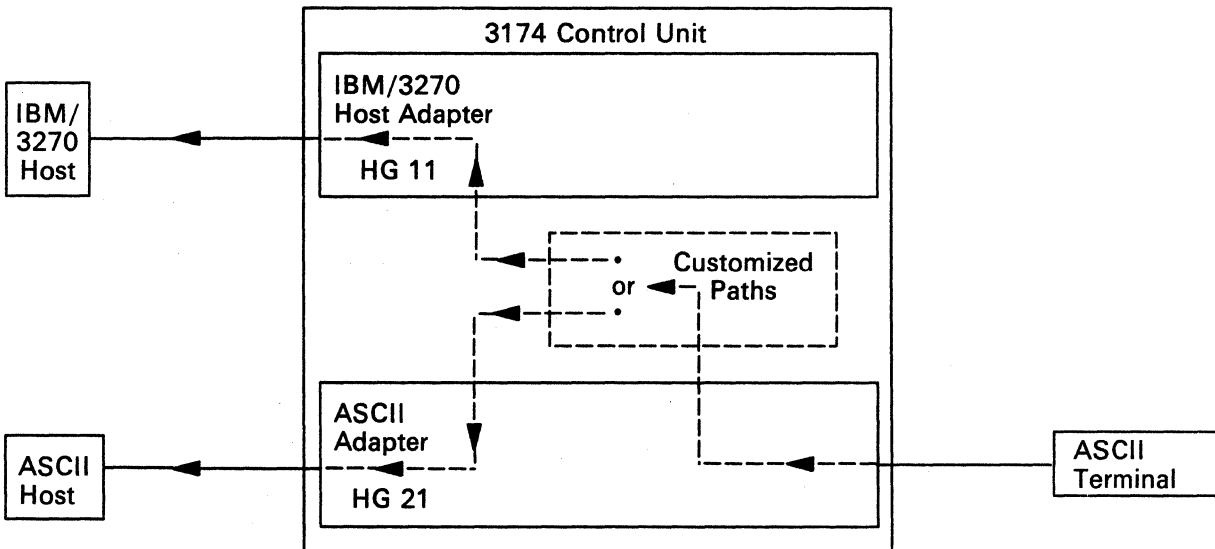

5. A Token-Ring station can communicate with the the IBM host in the Model 51R.

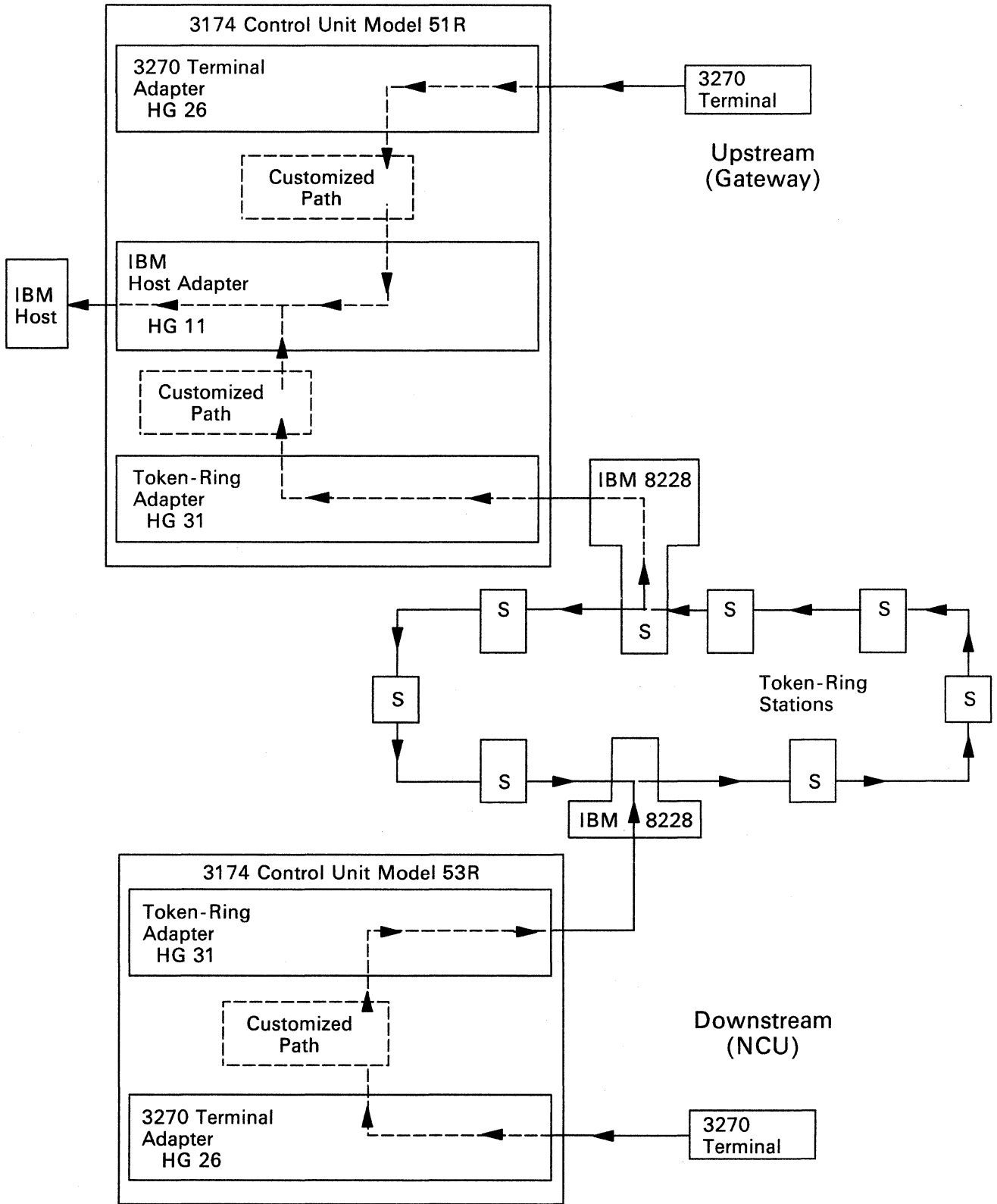



## Asynchronous Emulation Adapter Feature

The conventional 3270 subsystem environment consists of 3270 displays and printers communicating through the 3174 with a host system running a 3270 application program. See Figure B-1.

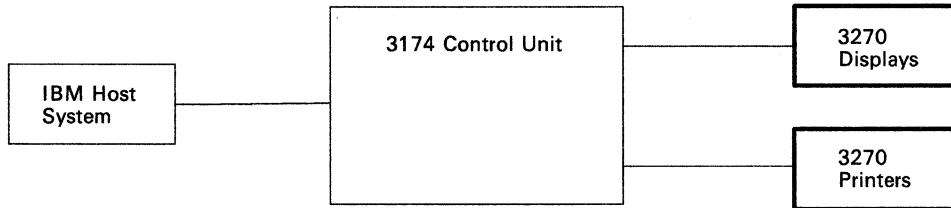

Figure B-1. 3270 Communication

This feature expands the connection and control capability of the 3174 to include communication with hosts, displays and printers that use the American National Standard Code for Information Interchange (ASCII) communication protocol, and hosts that use the International Organization for Standardization (ISO 646) National Language Support communication protocol. These hosts, displays, and printers are here referred to as *ASCII hosts, displays, and printers*. See Figure B-2.

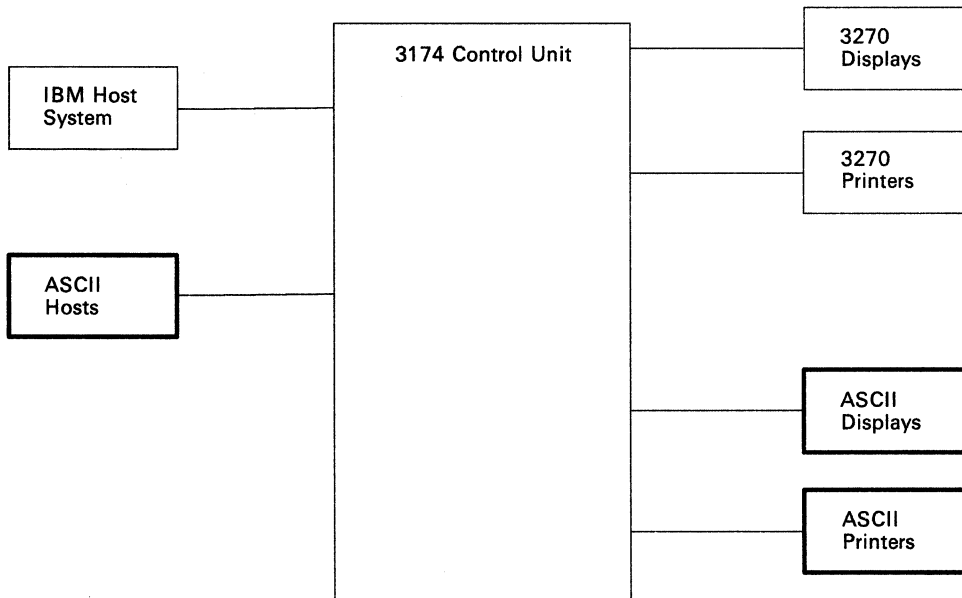

Figure B-2. ASCII Communication

# Asynchronous Emulation Adapter Communication

The AEA feature allows communication between:

- 3270 displays and/or printers to ASCII hosts (see Figure B-3)
- ASCII displays and/or printers to IBM hosts (see Figure B-4)
- ASCII displays and/or printers to ASCII hosts (see Figure B-5 on page B-10).

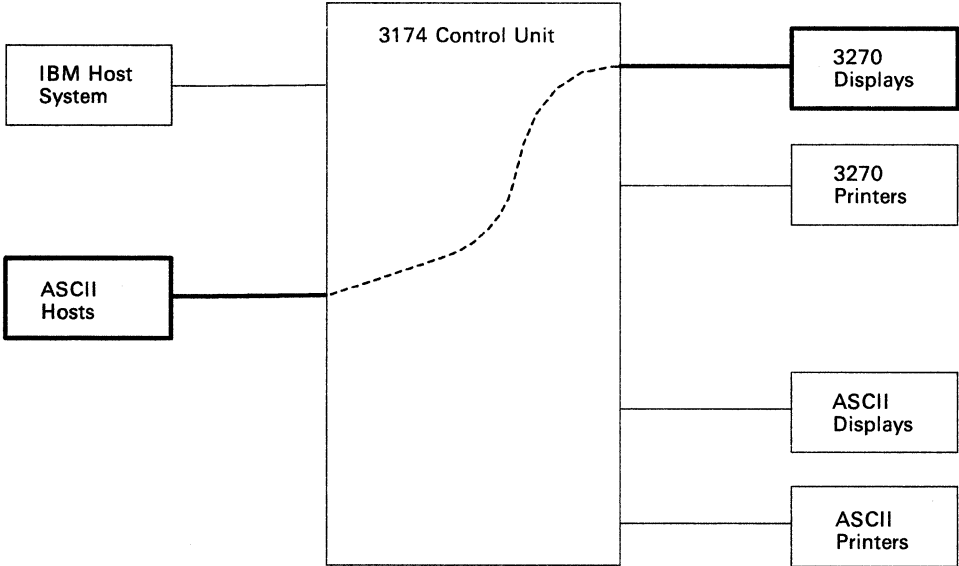

Figure B-3. 3270 Terminal Communicating with an ASCII Host

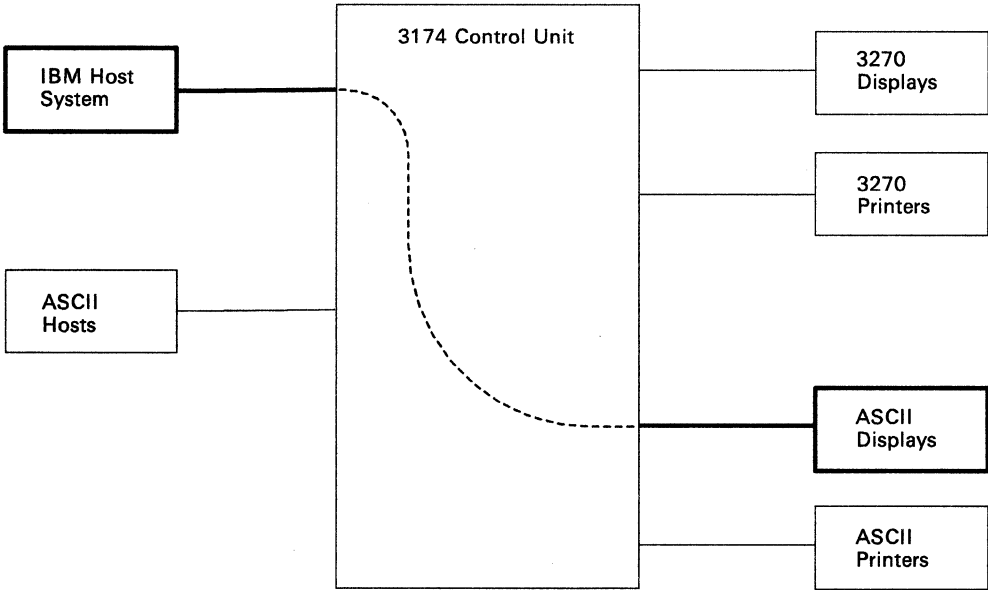

Figure B-4. ASCII Terminal Communicating with an IBM Host

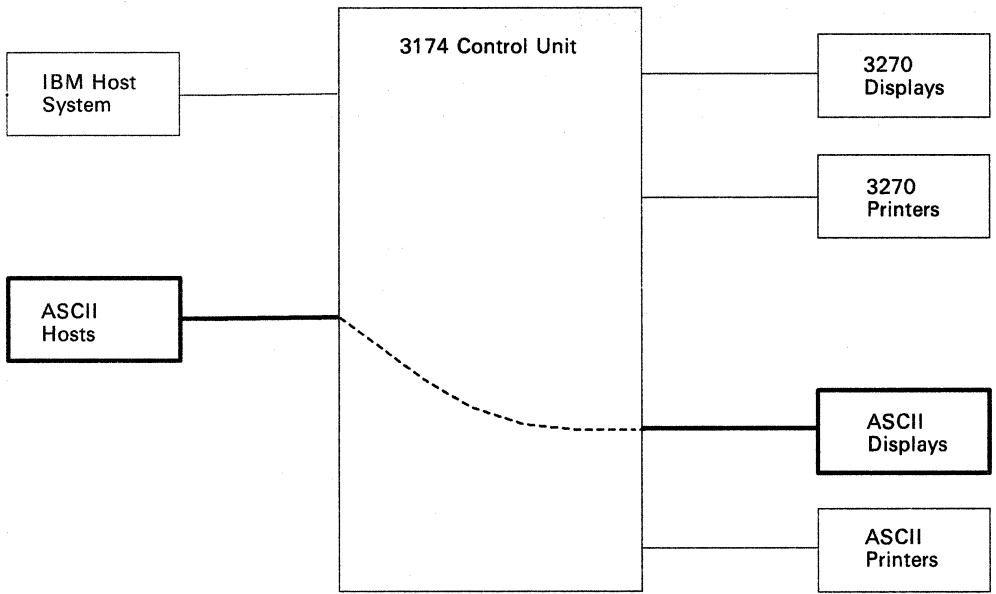

Figure B-5. ASCII Terminal Communicating with an ASCII Host

## Asynchronous Emulation Adapter (AEA) Hardware

Each Asynchronous Emulation Adapter and its associated cables and port connectors provide the capability to connect eight ASCII hosts, displays, or printers in any combination. Each adapter is identified by a hardware group (HG) number, and each port is identified by a port number.

3174 Models 1L, 1R, and 2R support the installation of up to three AEA cards, and, when three adapters are installed, allow the connection of up to 24 ASCII hosts, displays, and printers.

Models 51R and 52R support the installation of one AEA card and the connection of up to eight ASCII hosts, displays, or printers. See Figure B-6.

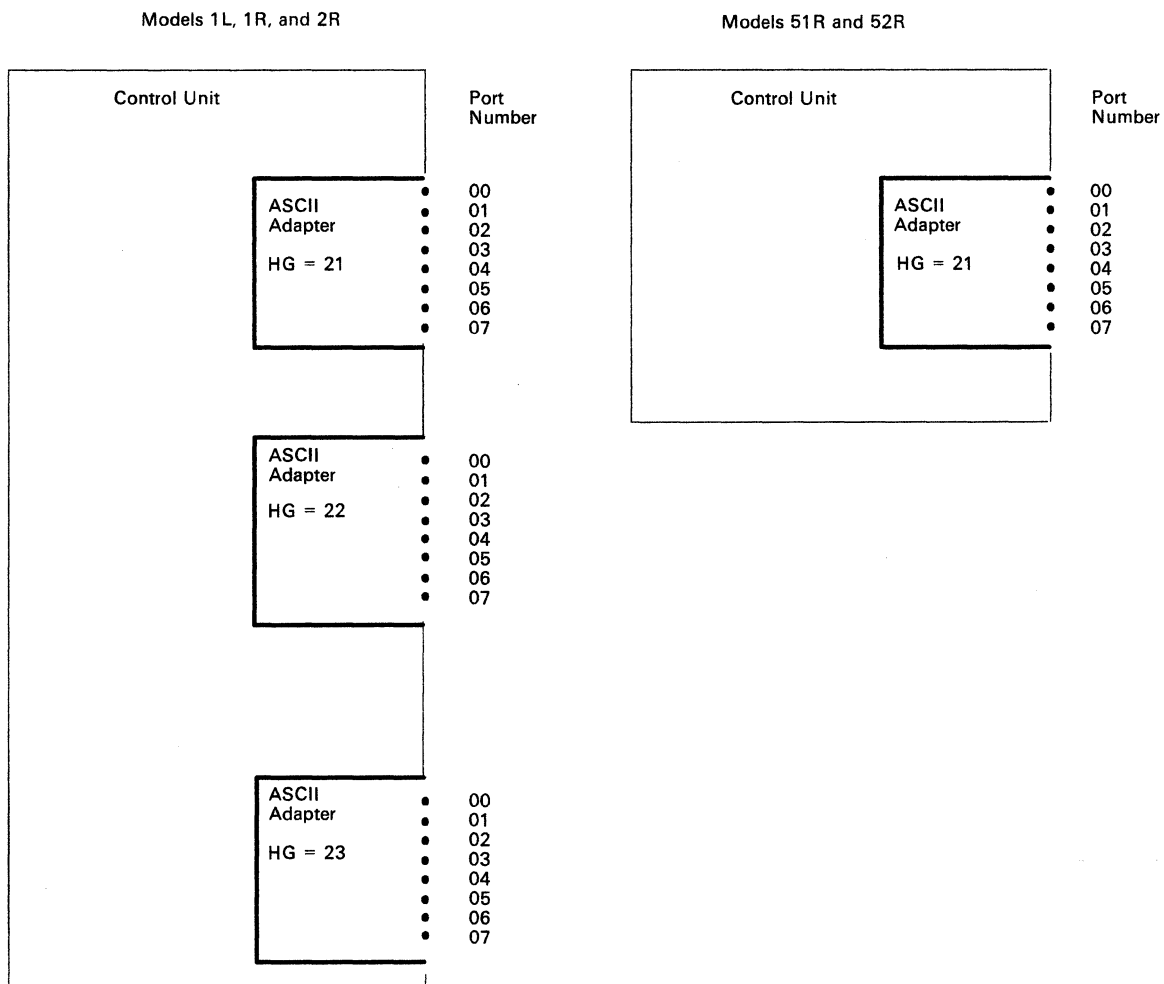

Figure B-6. Asynchronous Emulation Adapter Hardware

In addition to the adapter card(s), the feature also includes an internal cable between each adapter card and an I/O panel. The I/O panel has eight 25-pin D-shell port connectors. The port connectors are numbered 0 through 7 and provide the method of connecting the communication link cables. See Figure B-7.

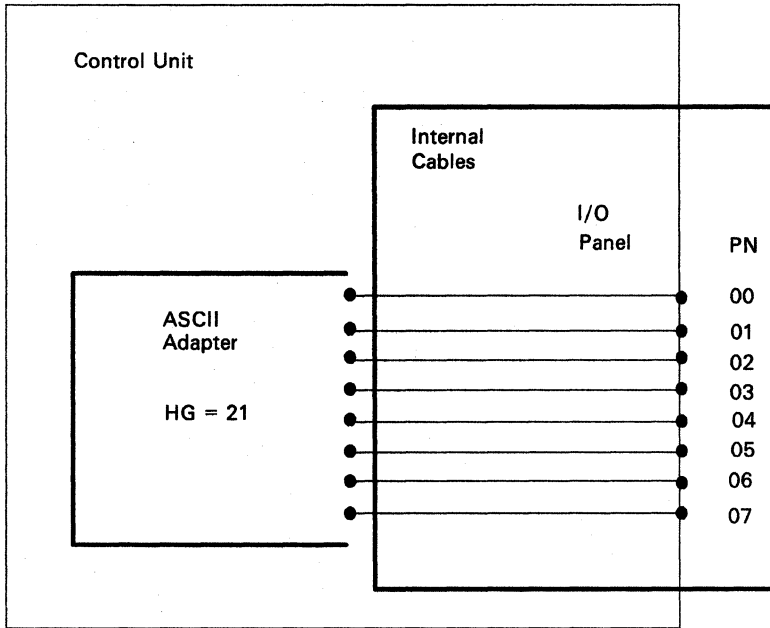

Figure B-7. AEA I/O Panel

# Communication Links and Associated Hardware

Three types of links are available:

- A direct cable from the AEA to the host, display, or printer
- A nonswitched link consisting of dedicated modems and customer-owned leased telephone lines
- A switched link consisting of programmable or intelligent modems (also called *smart* modems) with access to the public dial telephone network.

See Figure B-8.

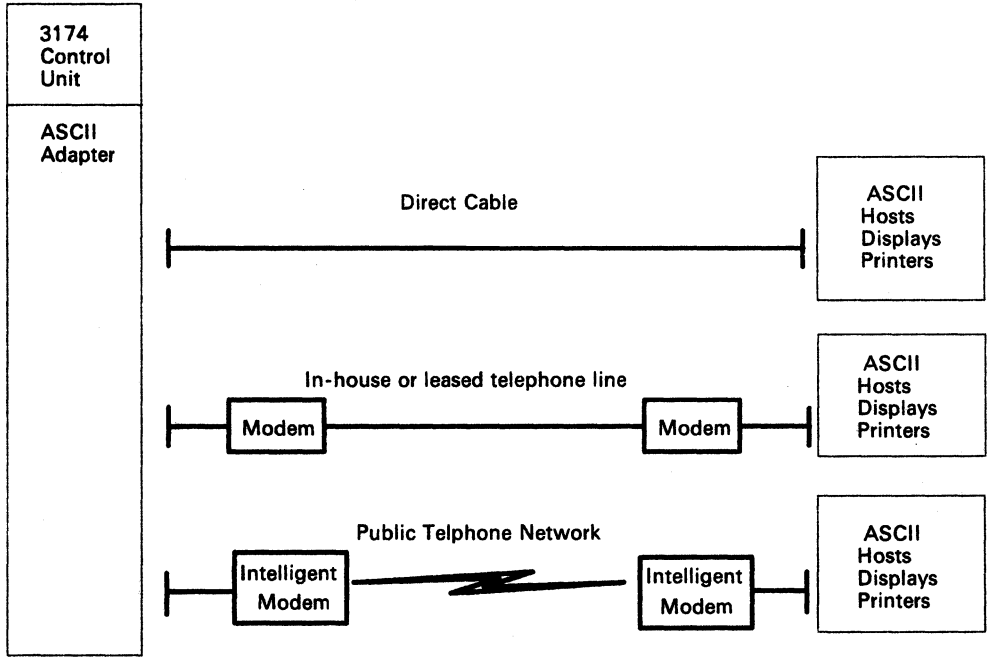

Figure B-8. Communication Equipment

## Physical and Logical Paths

The physical path between the control unit and various hosts, displays, and printers is determined by the equipment installed as explained in the hardware section. Once this hardware is installed, the physical path will generally remain the same.

The logical path is determined by customizing. This is accomplished by either selecting a default host or presenting a Connection Menu, from which the host is chosen by the display user. The ability to customize the logical path makes it easier to change terminal user access to more than one host, particularly when adding new host access. See Figure B-9.

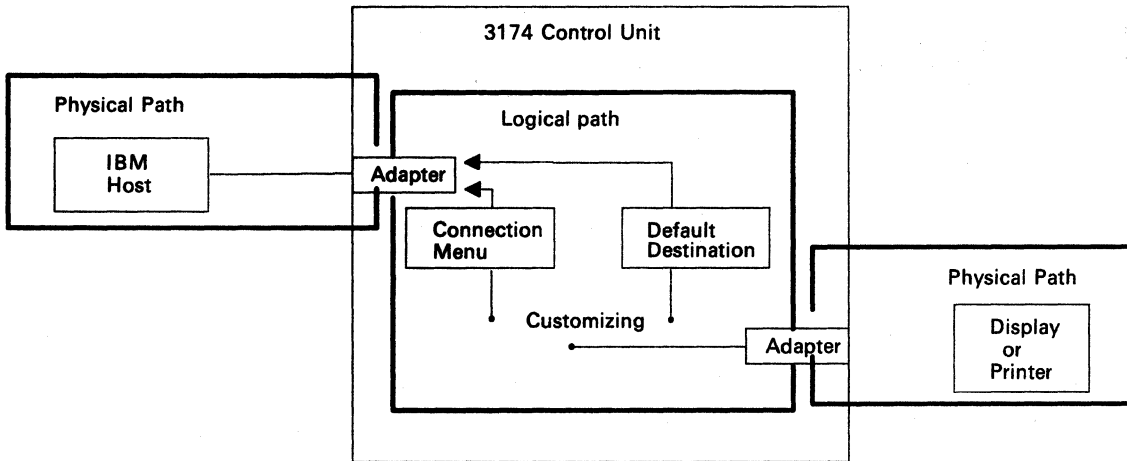

Figure B-9. Physical and Logical Paths

## Logical Path

Printers must be assigned to a host default destination. The host may be either the IBM host or an ASCII host. See Figure B-10.

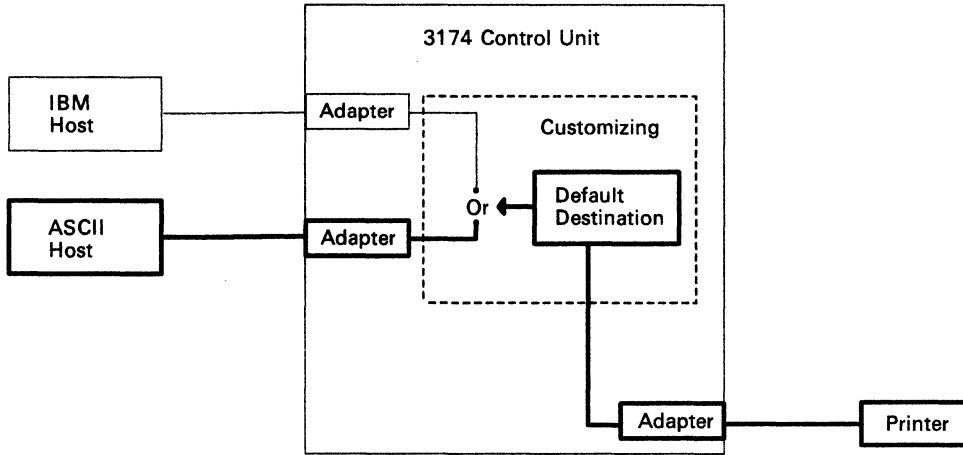

Figure B-10. Printer Logical Path

Display users may be assigned the Connection Menu or a default host. If assigned to a default host, then the path is the same as the one for printers. See Figure B-11.

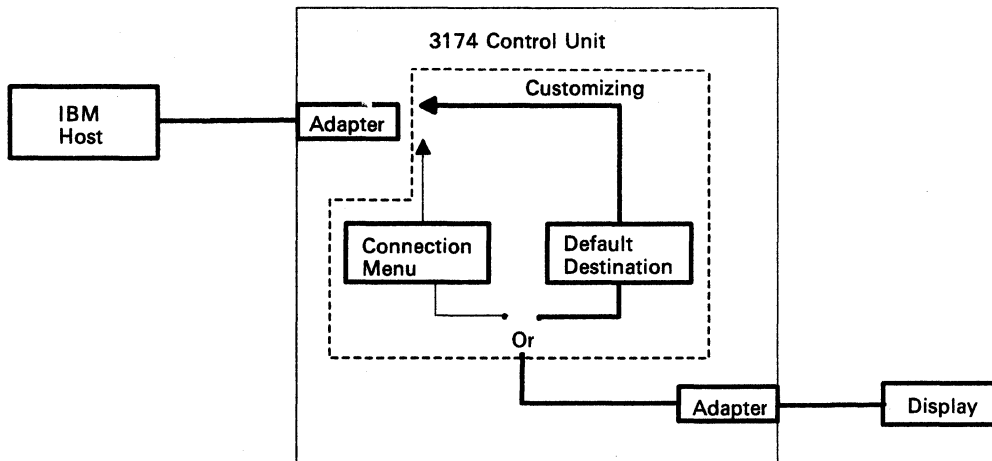

Figure B-11. Display Logical Path



## Connection Menu

The Connection Menu lists all the host connections that can be accessed by the display users. Hosts are identified at customizing time. See Figure B-12.

```

          _____ CONNECTION MENU _____
Enter a number (NUM) or name on the Command Line, then press Enter

NUM  NAME                STATUS    NUM  NAME                STATUS
  1   IBM HOST STATION
  2   ASCII HOST STATION
  3   ASCII HOST STATION
  4   ASCII HOST STATION
  5
  6
  7
  8
  9
 10
 11
 12
 13
 14
 15
 16
 17
 18
 19
 20
 21
 22
 23
 24
 25
 26
 27
 28

PF1=HELP  3=END
PF7=BACK  3=FWD

==== T0:

```

Figure B-12. Connection Menu

During customizing, two options are available when the Connection Menu is presented for selection.

1. The terminal user may be presented the Connection Menu, but is allowed to select only the default host assigned. See Figure B-13.

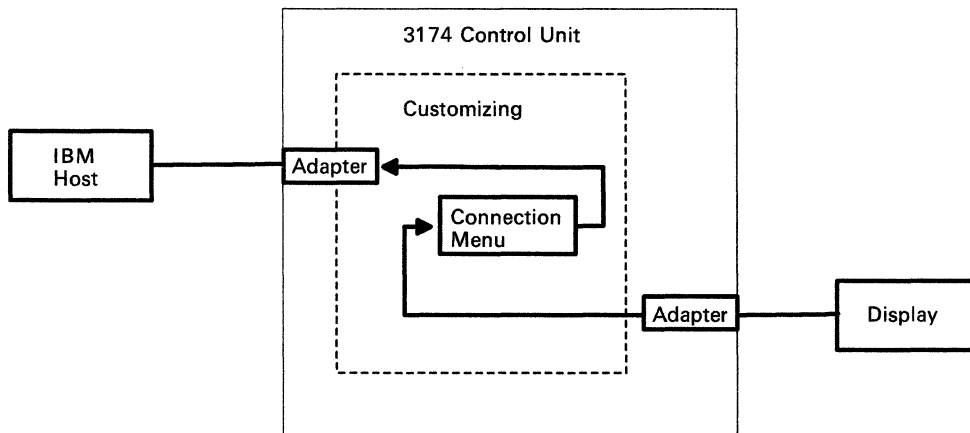

Figure B-13. Connection Menu Option 1

2. The terminal user may be presented the Connection Menu and be allowed to select any one of the hosts from the list. See Figure B-14.

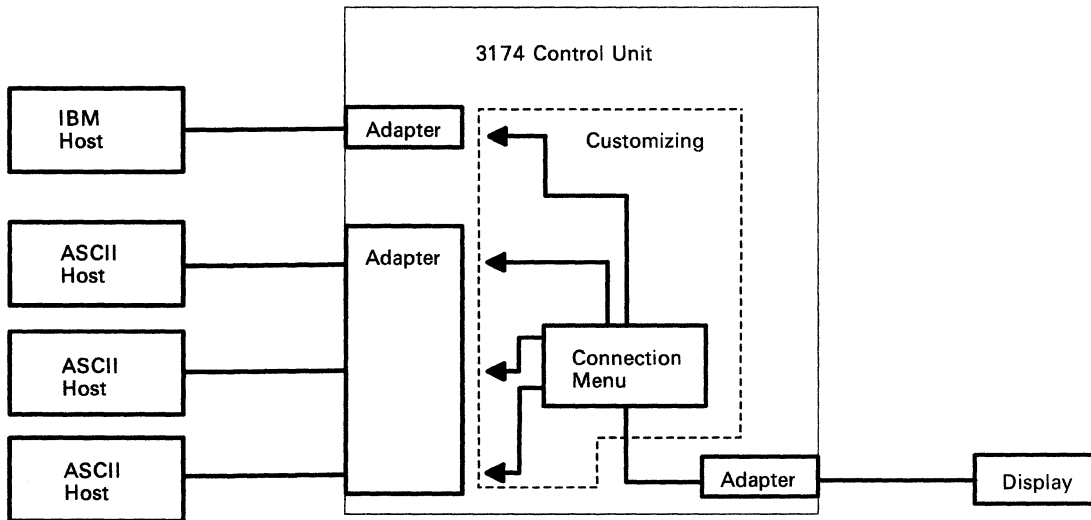

Figure B-14. Connection Menu Option 2

## Customizing

In customizing the AEA feature, you will be asked to define the physical equipment path, the connection type, and the operational characteristics of the equipment installed. You will also define the logical path as described previously. Once you have identified the physical and logical paths, you will be asked to summarize the information into sets for entry on the AEA customizing panels.

### Stations and Sets

The term *station* is used in the customizing procedures to differentiate between the conventional 3270 operation and the additional access provided by the AEA feature. A station may be an IBM or ASCII host, an IBM or ASCII display, or an IBM or ASCII printer.

Many of the stations will have the same characteristics. Because of this commonality between stations, provisions have been made for entering station information as a station set, thus eliminating the need to enter the same information multiple times. See Figure B-15.

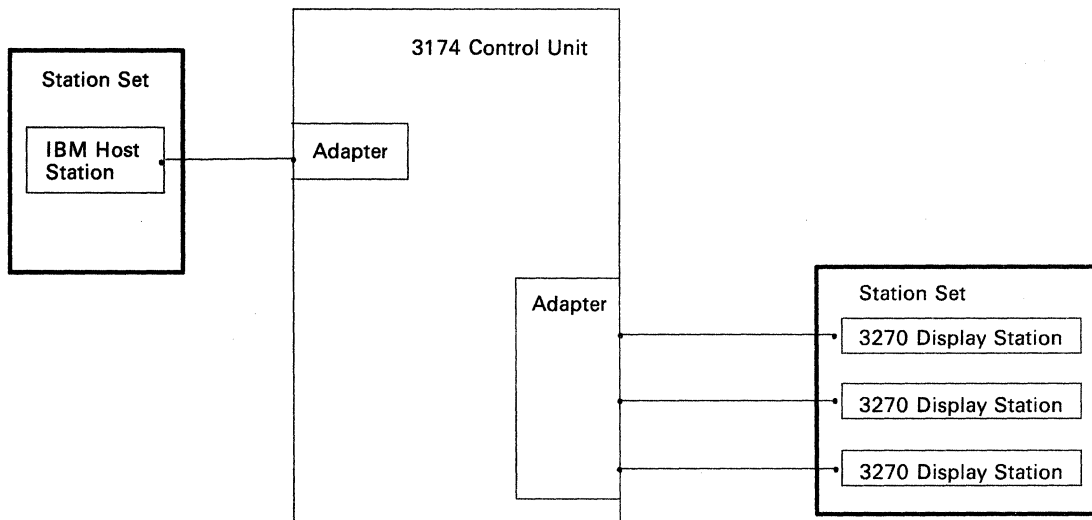

Figure B-15. Host Set and Terminal Set

## Port Type and Port Sets

The port type is used to identify the physical connection to the 3270 terminal adapter and ASCII adapter(s). The 3270 terminal adapter ports accept the conventional coaxial type cables used to connect 3270 type terminals. The AEA ports accept the cables used to connect direct, nonswitched, and switched communication links.

Many of the port types (coaxial, direct, nonswitched, switched) will be the same for a given station set. Provisions have been made to group these ports into port sets. See Figure B-16.

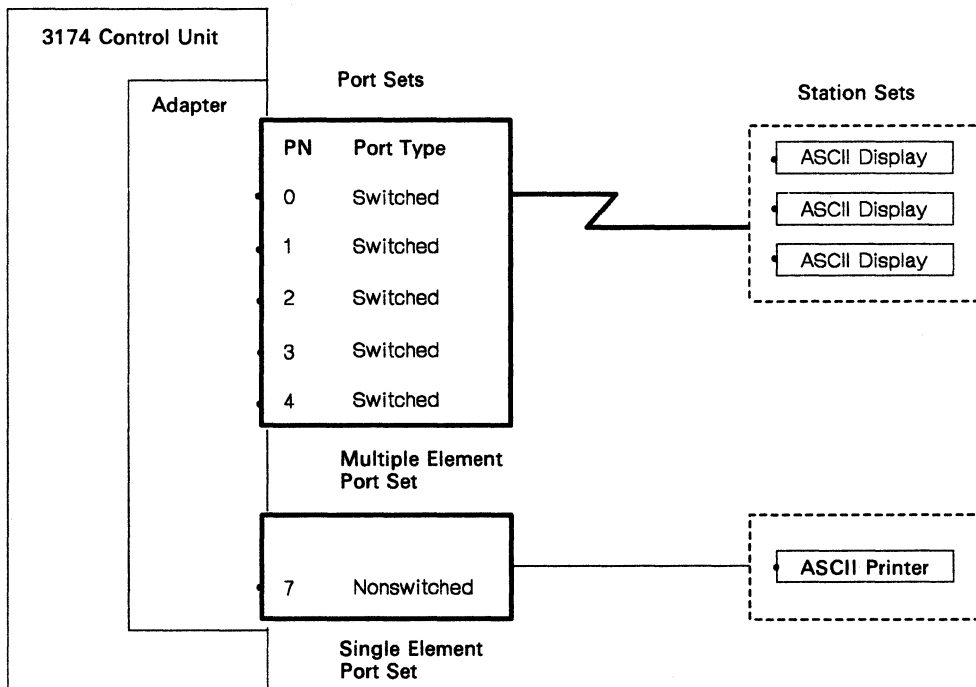

Figure B-16. Port Sets

Port sets may be used by more than one display station set, provided the station types of the station sets are different. Different station types are required because the control unit cannot identify which station set to connect if both station sets have the same station type and port type. See Figure B-17.

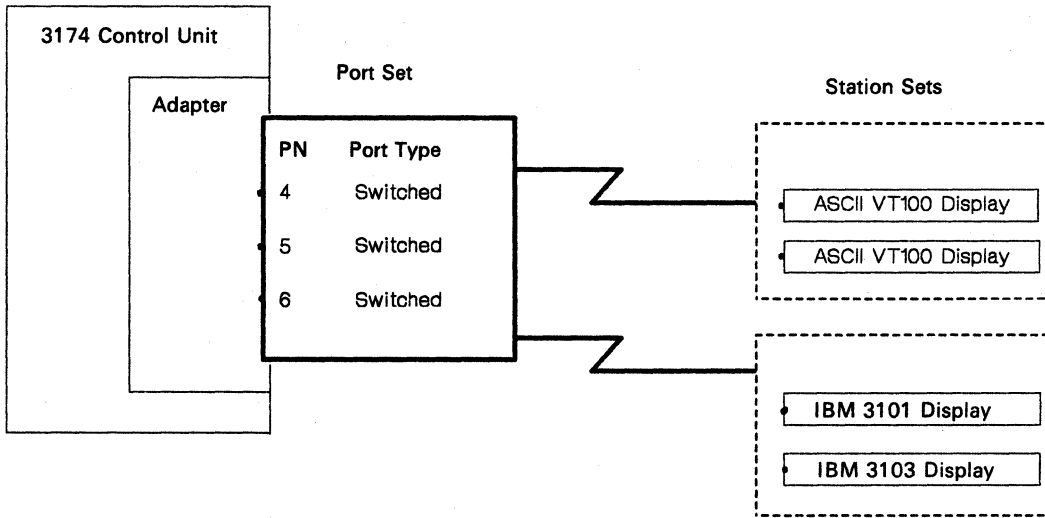

Figure B-17. Connected Terminal and Port Sets

---

## How to Disconnect and Connect Cables

The following diagrams illustrate how to connect cables to, and disconnect cables from, different subsystem components. In the problem determination procedures, you are asked to check cable connections in addition to connecting and disconnecting cables. It is important that you know how to disconnect and connect cables correctly.

### Terminal Cable Connectors

To disconnect a cable from a terminal (3278 shown), grip the cable by the knurled connector ring, and turn the cable connector counterclockwise.

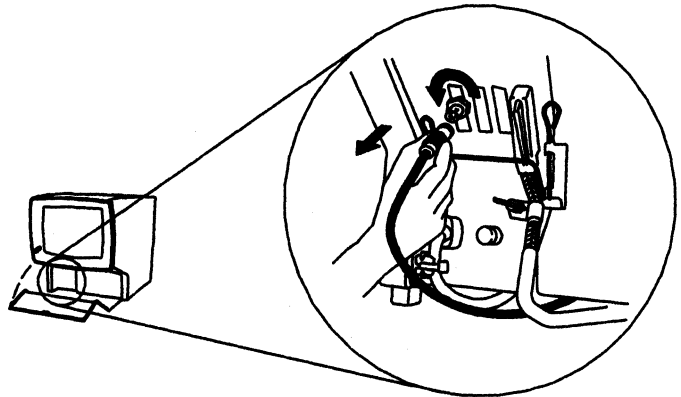

To connect a cable to a terminal (3278 shown), grip the cable by the knurled connector ring, push the cable connector over the connector on the terminal, and turn the cable connector clockwise.

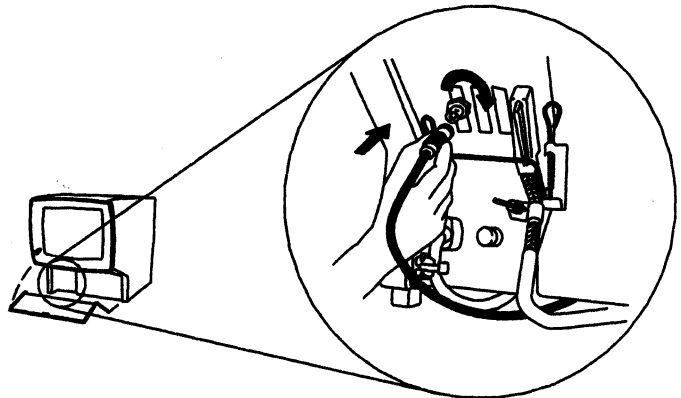

## Modular Telephone Plug Connectors

To disconnect a cable from a telephone plug (6-pin modular telephone plug shown here), grip the cable by the connector, thumb on top and forefinger on the tab underneath, squeeze the tab upward, and pull to disconnect.

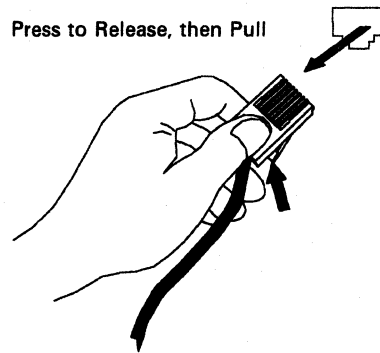

To connect a cable from a telephone plug (6-pin modular telephone plug shown here), grip the cable by the connector, thumb on top and forefinger on the tab underneath, and push to insert and connect.

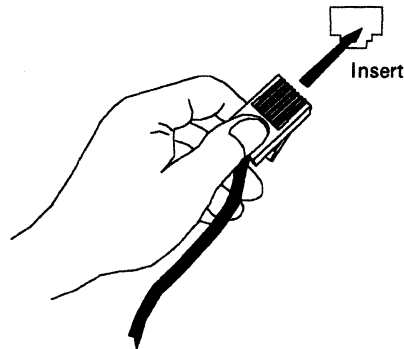

## Terminal Adapter Connectors

Shown here are the ports on the Terminal Adapter.

Use the same kind of motion as described above to disconnect and connect cables at the control unit or at a terminal multiplexer.

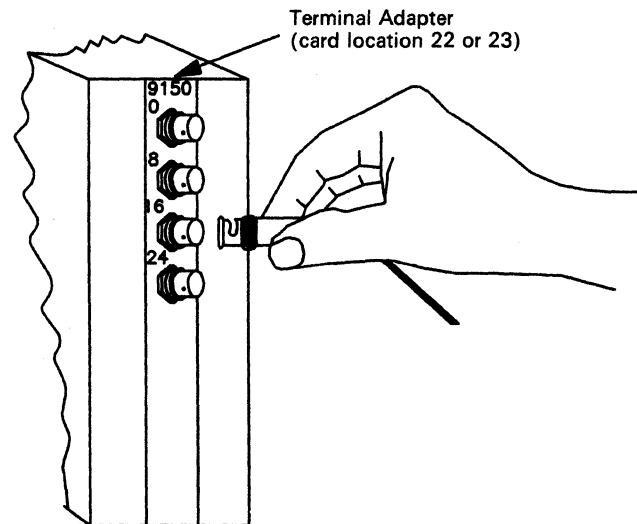

## BNC and DPC Connectors

Equipment **jacks** are the connecting devices on the 3174, 3299, and 3270-type terminals to which cables are connected. Cable **connectors** are the devices at the end of the cable that attach to the equipment jacks.

The 3174 jacks are Dual-Purpose Connector (DPC) jacks that accept either the BNC connectors on coaxial cables or the DPC connectors used for the IBM Cabling System. Older 3270 products, such as the 3299 Terminal Multiplexer Model 1, use a BNC jack and accept only the standard BNC connectors that are used with coaxial cabling or with ROLM's Coax-to-Twisted-Pair Balun.

BNC and DPC connectors are shown in Figure B-18. The DPC and BNC jacks look very similar. However, the DPC jack has an additional conductor in the center of the jack. The DPC connector on the cable has an insulator tube that extends about 3/16 of an inch beyond the body of the connector. Because of the differences between the BNC and DPC jack and connector, a DPC connector cannot be connected to a BNC equipment jack, such as the type of jack used on a 3299 Terminal Multiplexer Model 1. However, a BNC connector can be connected to a DPC jack.

**Note:** To isolate connection problems correctly, you must make sure that, when you exchange cables, the connectors on the new cable are the same type as the connectors on the old cable.

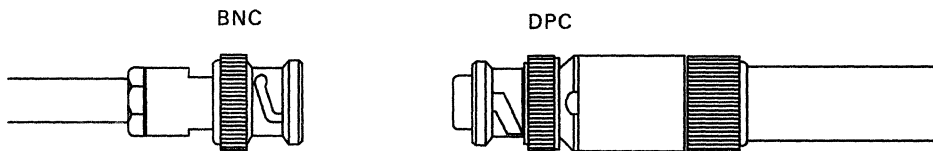

Figure B-18. BNC and DPC connectors



---

## 3174 Cables, Plugs, and Accessories

### DPC-T3 Connector

This connector is found on the IBM 3270 DPC-T3 (DPC to Type 3 Direct Attachment Accessory Cable) and is used to connect 3174 control units, 3299 Terminal Multiplexer Models 2 and 3, and new terminals directly to telephone wiring.

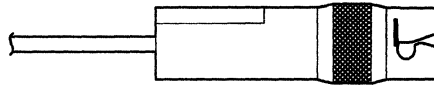

---

### DPC Connector

This connector is found on the IBM Cabling System accessories. It is used to connect the 3174 control units, 3299 Terminal Multiplexer Models 2 and 3, and terminals to the IBM Cabling System.

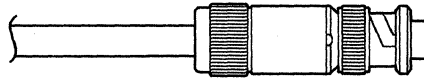

---

### BNC Connector

This connector is found on coaxial wiring and the IBM/ROLM 3270 Coax-to-Twisted-Pair Adapter. It is used to connect control units, terminal multiplexers, and terminals directly to coaxial cable. The IBM/ROLM 3270 Coax-to-Twisted-Pair Adapter allows you to connect control units, terminal multiplexers, and terminals, normally connected to coaxial cable, to telephone wiring.

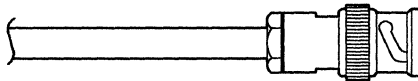

---

### BNC Jack

The BNC jack accepts only the BNC connector. Note that the BNC jack is shorter than the DPC jack.

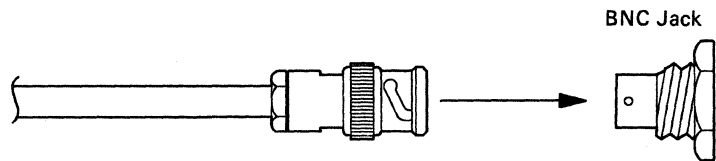

---

### 6-pin Modular Telephone Plug

This connector is found on telephone wiring, the IBM/ROLM Coax to Twisted Pair accessory, and the IBM DPC-T3 accessory. It is used to connect directly to telephone wiring and to the terminal connectors on the 3299 Terminal Multiplexer Model 3.

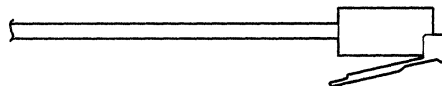

---

### Connectivity

The DPC T3, DPC, and BNC connectors will all connect and lock on the DPC jacks found on the 3174 control units, the 3299 Model 2, the 3299 Model 3 input jack, and most new terminals.

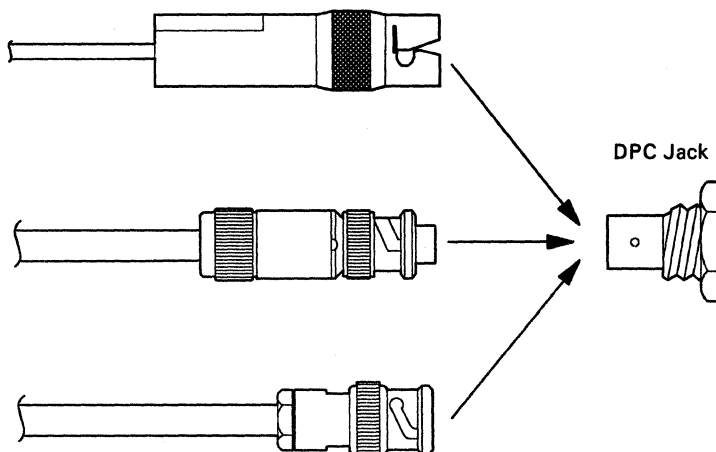

**DPC to IBM Cabling System Accessory (8'):  
6339073**

Consists of a DPC connector, 8 feet of IBM Cabling System media, and IBM Cabling System Data Connector.

Used for attaching 3174 control units, 3299 Terminal Multiplexer Models 2 and 3, and new devices to the IBM Cabling System.

Documentation: *IBM Cabling System Catalog, G570-2040.*

IBM Cabling System Data Connector  
6339073

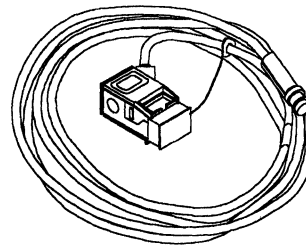

DPC Connector

**DPC to IBM Cabling System Accessory (30'):  
6339074**

Consists of a DPC connector, 30 feet of IBM Cabling System media, and IBM Cabling System Data Connector.

Used for attaching 3174 control units, 3299 Terminal Multiplexer Models 2 and 3, and new devices to the IBM Cabling System.

Documentation: *IBM Cabling System Catalog, G570-2040.*

IBM Cabling System Data Connector  
6339074

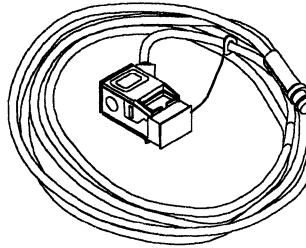

DPC Connector

**Double DPC-to-IBM Cabling System Accessory (8'):  
6339075**

Consists of two cables terminating in one IBM Cabling System Data Connector. Each cable has a DPC connector and IBM Cabling System media, and terminates in one IBM Cabling System Data Connector.

Used for attaching 3174 control units, 3299 Terminal Multiplexer Models 2 and 3, and new devices to the IBM Cabling System.

Documentation: *IBM Cabling System Catalog, G570-2040.*

IBM Cabling System Data Connector  
6339075

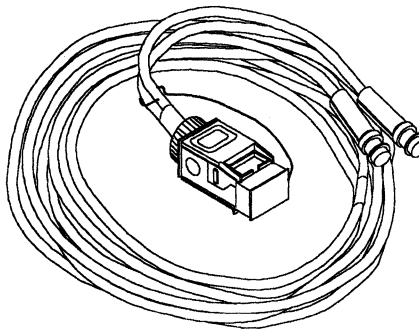

DPC Connectors

**IBM Cabling System Single Coaxial Cableless Balun:  
6339082**

Consists of an adapter with one coaxial jack and one IBM Cabling System Data Connector without cabling between.

Used for attaching 3278-like (Category A) terminals to the IBM Cabling System.

**Note:** Functionally the same as part number 8642546 (red) without cabling.

Documentation: *IBM Cabling System Catalog, G570-2040.*

BNC Jack

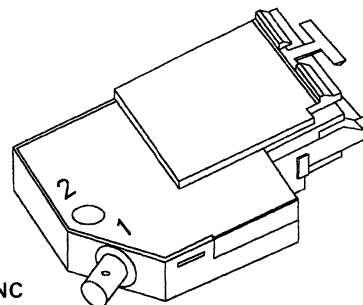

IBM Cabling System Data Connector  
6339082

## Cables, Plugs, and Accessories

### IBM Cabling System Single Coaxial Cableless Balun: 6339083

Consists of an adapter with two coaxial jacks and one IBM Cabling System Data Connector without cabling between.

Used for attaching 3278-like (Category A) terminals to the IBM Cabling System.

**Note:** Functionally the same as part number 8642546 (red) without cabling.

Documentation: *IBM Cabling System Catalog, G570-2040.*

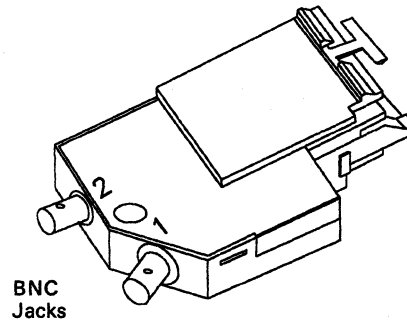

IBM Cabling System  
Data Connector  
6339083

---

### IBM Cabling System Coaxial Yellow Balun Assembly: 8642544

Consists of a BNC connector, a coaxial cable, a yellow balun, IBM Cabling System media, and IBM Cabling System Data Connector.

Used for attaching 3277-like (Category A) terminals to the IBM Cabling System.

Documentation: *IBM Cabling System Catalog, G570-2040.*

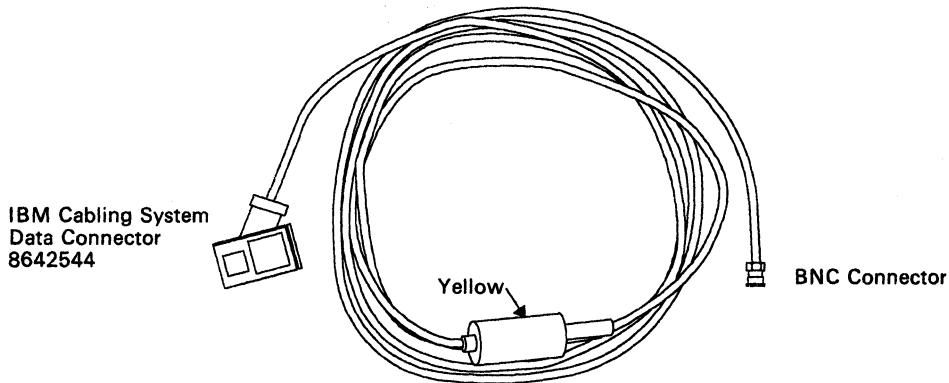

IBM Cabling System  
Data Connector  
8642544

BNC Connector

**IBM Cabling System Coaxial Red Balun Assembly:  
8642546**

Consists of a BNC connector, a coaxial cable, a red balun, IBM Cabling System media, and IBM Cabling System Data Connector.

Used for attaching 3278-like (Category A) terminals to the IBM Cabling System.

Documentation: *IBM Cabling System Catalog, G570-2040.*

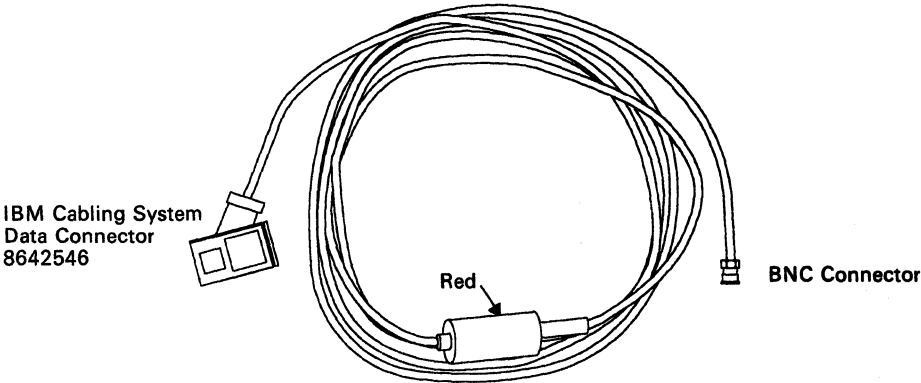

---

**IBM/ROLM 3270 Coax-to -Twisted-Pair Adapter:  
61X4584**

**Note:** IBM Specified Type 3

Consists of a BNC connector, a coaxial cable, a balun, a telephone twisted-pair, and a 6-pin modular telephone plug.

Used for attaching devices with BNC jacks to telephone wiring.

Documentation: *'IBM/ROLM 3270 Coax-to-Twisted-Pair Adapter' Planning and Installation Guide, GA27-3722.*

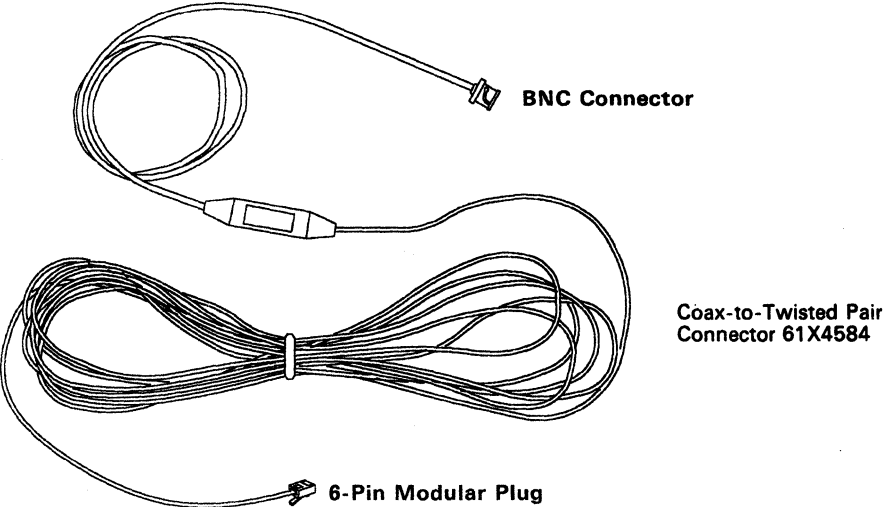

## Cables, Plugs, and Accessories

### IBM 3270 DPC-T3 Direct Attachment Accessory

Cable: 83X9758

Consists of a DPC-T3 connector, 15 feet of telephone twisted-pair, and a 6-pin modular telephone plug.

Used for attaching 3174 control units, 3299 Terminal Multiplexer Models 2 and 3, and new devices to the telephone twisted-pair wiring.

Documentation: *IBM DPC-T3 Supplement to the 3174 Subsystem Control Unit Site Planning*, G126-0215.

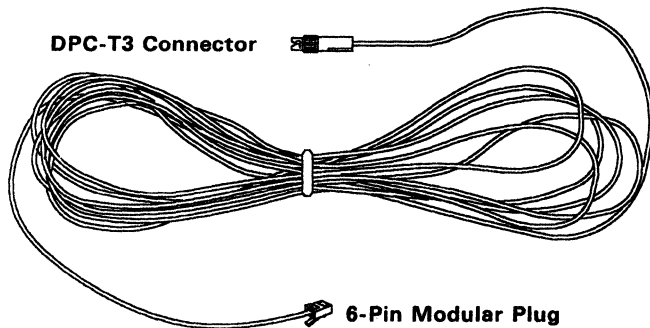

DPC-T3 Direct Connector  
83X9758

### Token-Ring Adapter Wrap Plug:

Used for testing the 3174 Token-Ring Adapter port.

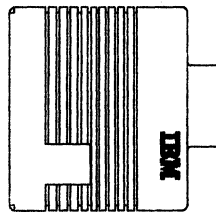

Token-Ring Adapter Wrap Plug 6165899

### 25-Pin D-Shell Connector with a Test/Operate switch: 6423153

25-pin D-Shell Connector

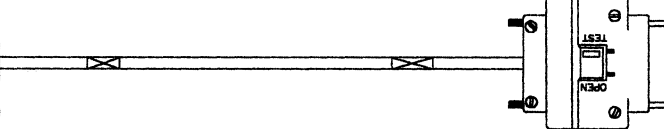
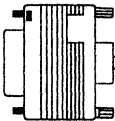

25-pin D-shell Connector with Test/Operate Switch. 6423153

### 25-Pin D-Shell Connector with a Test/Operate switch: 6168155

25-Pin D-Shell Connector

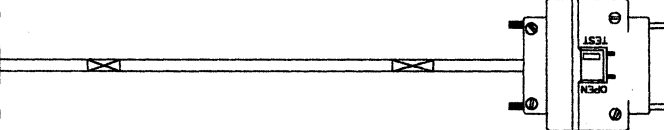
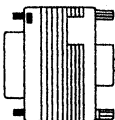

25-Pin D-Shell Connector with Test/Operate Switch. 6168155

**IBM Cabling System Data Connector/25-Pin  
D-Shell Connector: 6165837**

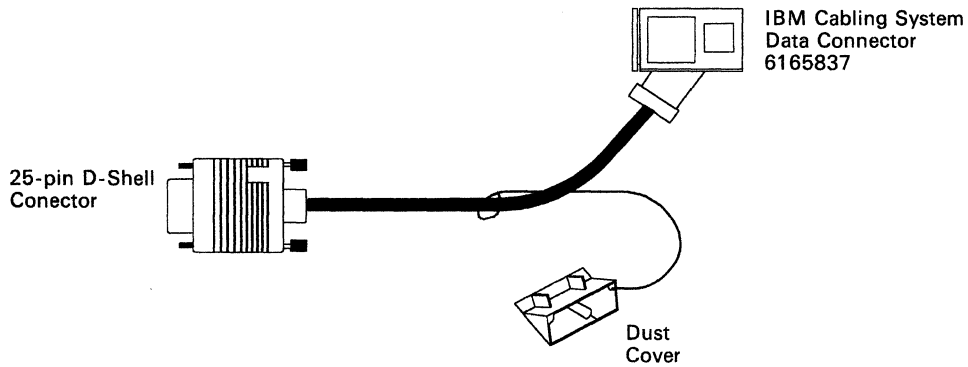

**ASCII Adapter Wrap Plug: 61X4602**

Used for testing the 3174 ASCII Adapter ports.

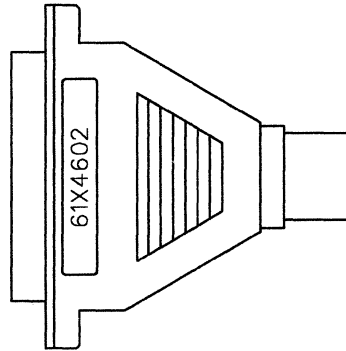

**V.35 Cable Wrap Plug: 61X4603**

Used for testing the following early-production interface cables with one Test/Operate switch:

- |         |         |         |
|---------|---------|---------|
| 6423157 | 6423325 | 6423327 |
| 6423158 | 6423326 | 6423328 |

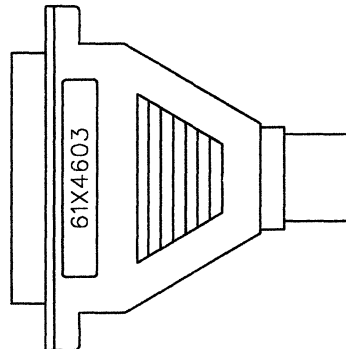

**V.35 Wrap Plug: 6423419**

Used for testing the Type 1 Communications Adapter and the following interface cables:

- |         |         |         |         |
|---------|---------|---------|---------|
| 6423153 | 6423157 | 6423325 | 6423327 |
| 6423158 | 6423326 | 6423328 |         |

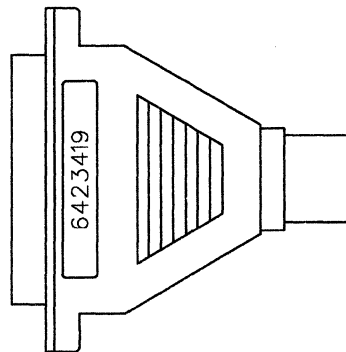

## Cables, Plugs, and Accessories

### V.21 Wrap Plug: 6423420

Used for testing the Type 2 Communications Adapter.

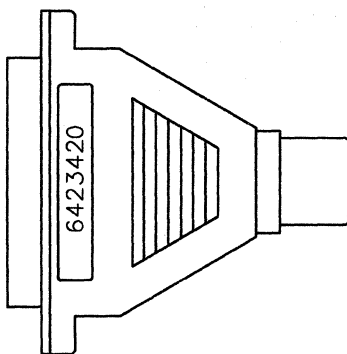

---

## List of Abbreviations

**A**

**A.** (1) Ampere. (2) Angstrom. (3) Attention.

**ac.** Alternating current.

**AEA.** Asynchronous Emulation Adapter.

**AID.** Attention identifier.

**Alt.** Alternate.

**A/N.** Alphanumeric.

**ANSI.** American National Standards Institute.

**APA.** All points addressable.

**APL.** A programming language.

**ARC.** Adapter return code.

**ASCII.** American National Standard Code for Information Interchange.

**ASYNC.** Asynchronous.

**ATTN.** Attention.

**avg.** average.

**AWG.** American Wire Gauge.

**B**

**B.** Busy.

**BIOS.** Basic Input/Output System.

**BIU.** Basic information unit.

**bps.** Bits per second.

**BSC.** Binary synchronous communication.

**Btu.** British thermal unit.

**BTU.** Basic transmission unit.

**C**

**C.** Celsius.

**CAC.** Common adapter code.

**CAW.** Channel address word.

**CC.** Control check, Chain Command (flag).

**CCC.** Copy control character.

**CCITT.** International Telegraph and Telephone Consultative Committee.

**CCW.** Channel command word.

**CD.** (1) Compact disk. (2) Change direction.

**CE.** (1) Customer Engineer. (2) Correctable error. (3) Channel-end.

**CECP.** Country extended code page.

**cfm.** Cubic feet per minute.

**char.** Character.

**CID.** Connection identifier.

**cm.** Centimeter.

**cmd.** Command.

**CMS.** Conversational monitor system.

**cncl.** Cancel.

**CNM.** Communication network management.

**coax.** Coaxial (cable).

**comm.** Communication.

**cont.** Continuous.

**cpu.** Characters per inch.

**cps.** Characters per second.

**CR.** Command Reject.

**CRC.** Cyclic redundancy check.

**CRT.** Cathode-ray tube.

**CRV.** Cryptography Verification.



## Abbreviations

**CSU.** Customer setup.

**CSW.** Channel status word.

**ctr.** Counter.

**CTS.** Clear to Send.

**CU.** Control unit.

**CUE.** Control Unit End.

**CUT.** Control unit terminal.

## D

**D.** Display.

**DAF'.** Destination address field prime (local address of SLU).

**dB.** Decibel.

**DB.** (1) Data base. (2) Device Busy.

**dBa.** Adjusted decibels.

**DBCS.** Double-byte character set.

**dBm.** Decibels based on 1 milliwatt.

**DC.** (1) Data communication. (2) Direct current.

**DCC.** Disconnect command chaining.

**DCE.** Data-circuit-terminating equipment.

**DDS.** (1) Data description specifications. (2) Digital data service.

**DE.** Device-end.

**dec.** Decimal.

**DEL.** The delete character.

**DEMF.** Display Exception Monitoring Facility.

**dev.** Device.

**DFT.** (1) Distributed function terminal. (2) Diagnostic function test.

**DGM.** Data Grade Media.

**DISC.** Disconnect.

**DLE.** Data link escape.

**DM.** Disconnect mode.

**DOS.** Disk Operating System.

**DP.** (1) Data processing. (2) Distribution panel.

**DPC.** Dual-purpose connector.

**DPKT.** Default packet size.

**DR.** Definite response.

**DSL.** (1) Downstream load. (2) Data set label.

**DSR.** Data set ready.

**DTE.** Data terminal equipment.

**dup, DUP.** Duplicate.

**DWND.** Default window size.

## E

**EAB.** Extended Attribute Buffer.

**EAS.** Extended Area Service.

**EAU.** Erase All Unprotected.

**EB.** End bracket.

**EBCDIC.** Extended binary-coded decimal interchange code.

**EC.** Engineering change.

**ECC.** Error-checking and correction.

**ECMA.** European Computer Manufacturer's Association.

**ECSA.** Extended Character Set Adapter.

**EFI.** Expedited flow indicator.

**EIA.** Electronic Industries Association.

**EM.** End of message.

**ENP.** Enable Presentation.

**ENQ.** Enquiry.

**EOF.** End of file.

**EOI.** End of Inquiry.

**EOR.** End of Record.

**EOT.** End-of-transmission (character).

**EPO.** Emergency Power Off.

**EPSN.** Extended packet sequence numbering.

**ERI.** Exception response indicator.

**ERP.** Error recovery procedures.

**ETB.** End-of-transmission-block (character).

**ETX.** End of Text.

**EUA.** Erase Unprotected to Address.

**E/W.** Erase/Write.

**EX.** Exception (response).

## F

**F.** Fahrenheit.

**FCC.** Federal Communications Commission.

**FCS.** Frame checking sequence.

**FERS.** Facility Error Recognition System.

**FF.** Forms feed.

**FID.** Format identifier.

**FIE.** Function interpret error.

**FM.** (1) Frequency modulation. (2) Function management. (3) Field mark.

**FMD.** (1) Function management data. (2) Field macro diagram.

**FMH.** Function management header.

**FRMR.** Frame reject response.

**ft.** Foot (or feet).

## G

**GDDM.** Graphical Data Display Manager.

**GFI.** General format identifier.

**GP.** General Poll.

## H

**h.** Coaxial cable type for indoor installation.

**H.** Height.

**HDLC.** High-level data link control.

**hex.** Hexadecimal.

**HNAD.** Host network (DTE) address.

**HPCA.** High-performance communication adapter.

**HT.** Horizontal Tab.

**Hz.** Hertz.

## I

**I.** Information (format).

**IC.** Insert Cursor.

**ID.** Identification, identifier.

**IEEE.** Institute of Electrical and Electronic Engineers.

**IML.** Initial microcode load.

**in.** inch (or inches).

**I/O.** Input/output.

**IOPT.** Incoming call option.

**IOS.** Input/Output Supervisor.

**IPDS.** Intelligent Printer Data Stream.

**IR.** Intervention Required.

**IRS.** Interrecord-separator character.

**ITB.** End of intermediate transmission block.

## K

**k.** 1000.

**K.** 1024.

**KANA.** Katakana.

**Kb.** Kilobyte; 1024 bytes.

**kbd.** Keyboard.

**kcal/hr.** Kilocalories per hour.

**kg.** Kilogram.

**kVA.** Kilovolt ampere.

## Abbreviations

### L

**L**. Coaxial cable type for indoor or outdoor installations.

**LAN**. Local area network.

**LAPB**. Link access procedure balanced.

**lb**. Pound.

**LC**. Logical channel.

**LCID**. Logical channel identifier.

**LED**. Light-emitting diode.

**LF**. Line feed.

**LIC**. Last in chain.

**LLC**. Logical link control.

**LNA**. Logical network address.

**LPDA**. Link problem determination aid.

**LRC**. Longitudinal redundancy check.

**LSF**. Load Structured Field.

**LT**. Logical terminal.

**LU**. Logical unit.

**lumens/m**. Lumens per square meter.

**LU/SSCP**. Logical unit/system services control point.

### M

**m**. Meter (or meters).

**MAC**. (1) Medium access control. (2) Message authentication code.

**MAP**. Maintenance analysis procedure.

**max**. Maximum.

**mb**. Millibyte; 1024 bytes. Deprecated term for *Kb*.

**Mb**. Megabyte; 1 048 576 bytes.

**MB**. Optical fiber mounting bracket.

**Mbit**. Megabit.

**MDT**. Modified data tag.

**MES**. Miscellaneous Equipment Specification.

**MGN**. Multiground neutral.

**MHS**. Magnetic hand scanner.

**min**. Minimum, minute.

**MIS**. Multiple interactive sessions.

**MLT**. Multiple logical terminals.

**mm**. Millimeter (or millimeters).

**modem**. Modulator-demodulator.

**MPF**. Mapping field.

**MPP**. Maximum presentation position.

**MSR**. Magnetic stripe reader.

**MVS**. Multiple virtual storage.

### N

**NA or N/A**. Not applicable.

**NAK**. Negative acknowledge.

**NAUN**. Nearest active upstream neighbor.

**NCP**. Network Control Program.

**NEC**. National Electrical Code.

**NEMA**. National Electrical Manufacturer's Association.

**NEMF**. Network Error Management Facility.

**NETBIOS**. Network Basic Input/Output System.

**NIA**. Network Interface Adapter.

**NMVT**. Network Management Vector Transport.

**No**. Number.

**NOLLC**. No logical link control.

**NOP**. No operation.

**NPKT**. Negotiated packet size.

**NRZ**. Nonreturn to zero.

**NRZI**. Nonreturn to zero inverted.

**NTT**. Nippon Telephone and Telegraph.

**NUL**. Null.

**NUM.** Numeric.

**NWND.** Negotiated window size.

## O

**OAF'.** Origin address field prime.

**OCIR.** Operator Identification Card Reader.

**OCR.** Optical character recognition.

**OEM.** Original equipment manufacturer.

**OFFP.** Optical fiber patch cable.

**OFRPTR.** IBM 8219 Optical Fiber Repeater.

**OIA.** Operator information area.

**OOPT.** Outgoing call option.

## P

**PA.** (1) Program access. (2) Program attention.

**PAC.** Program authorized credentials.

**PAM.** Printer authorization matrix.

**PBX.** Private branch exchange.

**PC.** Personal Computer.

**PCKT.** Packet.

**PEL.** Picture element.

**pF.** Picofarad.

**PF.** Program function.

**PI.** Pacing indicator.

**PIC.** Problem isolation chart.

**PID.** Product-set ID.

**PIU.** Path information unit.

**PLU.** Primary logical unit.

**PN.** Port Number.

**P/N.** Part Number.

**POST.** Power-On Self Test.

**PRID.** Procedure-related identifier.

**PS.** Programmed symbols.

**PSDN.** Packet switched data network.

**PSH.** Physical services header.

**PSI.** Primary to secondary indicator.

**PSS.** (1) Programmable Store System. (2) Programmed symbol set.

**PSWD.** Password.

**PT.** Program Tab.

**PTT.** Postal Telephone and Telegraph Administration.

**PU.** Physical unit.

**PUID.** Physical unit identification.

**PVC.** Permanent virtual circuit.

## Q

**QFRMR.** Qualified frame reject response.

**QLLC.** Qualified logical link control.

**QRI.** Queued response indicator.

**QSM.** Qualified set mode.

## R

**RA.** Repeat to Address.

**RAM.** Random access memory.

**RB.** Read Buffer.

**RBM.** Read Buffer Modified.

**Rd Mod.** Read Modified.

**RDL.** Remote Data Link.

**REA.** Rural Electrification Administration.

**RECFMS.** Record Formatted Maintenance Statistics.

**REQMS.** Request Maintenance Statistics.

**RFI.** Radio-frequency interference.

**RH.** Request/response header.

**RI.** Ring Indicate.

**RM.** Read Modified.

## Abbreviations

**rms.** Root-mean-square.

**RNR.** Request not ready, receive not ready.

**RO.** Ring Out.

**ROM.** Read-only memory.

**ROS.** Read-only storage.

**RPOA.** Recognized private operating agency.

**RPQ.** Request for price quotation.

**RP-W.** Read Partition-Query.

**R/R.** Request/response.

**RR.** Request ready, receive ready.

**RSP.** Response.

**RTM.** Response Time Monitor.

**RTS.** Request to send.

**RU.** Request/response unit.

**RVI.** Reverse interrupt.

## S

**SA.** Selection addressing.

**SABM.** Set Asynchronous Balance Mode (command).

**SABME.** Set Asynchronous Balance Mode Extended (command).

**SAP.** Service access point.

**SARM.** Set Asynchronous Response Mode.

**SBA.** Set Buffer Address.

**SC.** Status code.

**SCR.** Silicone-controlled rectifier.

**SCS.** SNA character string.

**SDLC.** Synchronous Data Link Control.

**sec.** Second.

**SF.** (1) Special feature. (2) Specify feature. (3) Start field.

**SFAP.** Structured Field and Attribute Processing.

**SFE.** Start Field Extended.

**SHF.** Set Horizontal Format.

**SI.** Suppress Index.

**SIOF.** Start I/O Fast Release.

**SLU.** Secondary logical unit.

**SM.** Status modifier.

**SMS.** Switching Management System.

**SNA.** Systems Network Architecture.

**SNBU.** Switched network backup.

**SNF.** Sequence number field.

**SNRM.** Set Normal Response Mode.

**SOEMI.** Serial Original Equipment Manufacturer Interface.

**SOH.** Start-of-heading character.

**SOR.** Start of record.

**SP.** (1) Space. (2) Specific Poll.

**SPD.** Selector pen detect.

**SPF.** System Productivity Facility.

**SRM.** Set Reply Mode.

**S/S.** Status and sense.

**SS.** Surge suppressor.

**SSCP.** System services control point.

**SSR.** Secure string record.

**STX.** Start of text.

**SUB.** Substitute.

**SVC.** Switched virtual circuit.

**SVF.** Set Vertical Format.

**sw.** Switch.

**SYN.** Synchronous idle.

**SYSGEN.** System generation.

**SYSREQ.** System request.

**T**

**TA.** Terminal adapter.  
**TAF.** Target address field.  
**TC.** Transmission check.  
**TCLS.** Throughput class negotiation.  
**TCU.** Transmission control unit.  
**TH.** Transmission header.  
**TMA.** Terminal multiplexer adapter.  
**TP.** Teleprocessing.  
**TS.** Transmission services.  
**TTD.** Temporary text delay.

**U**

**UA.** Unnumbered acknowledgment.  
**UC.** Unit check.  
**UCW.** Unit control word.  
**UE.** Unit exception.  
**UKPSS.** United Kingdom Packet Switched Service.  
**UL.** Underwriters Laboratory.

**U.S.** United States.  
**US.** Unit separator (character).

**V**

**V.** Volt.  
**VFC.** Vertical forms control.  
**VTAM.** Virtual Telecommunications Access Method.

**W**

**WACK.** Wait before transmit.  
**WCC.** Write control character.  
**WE.** Western Electric.  
**WNDO.** Window.  
**WSF.** Write Structured Field.  
**WT.** World Trade.

**X**

**XGA.** Extended Graphics Adapter.  
**X-off.** Transmitter off.  
**X-on.** Transmitter on.



---

## Glossary

This glossary includes terms and definitions from the *IBM Dictionary of Computing: Information Processing, Personal Computing, Telecommunications, Office Systems, IBM-specific Terms*, SC20-1699.

The terms in this glossary are defined here as they apply to the 3270 Information Display System.

### A

**access control byte.** The byte following the start delimiter in a token or frame. It is used to control access to the ring.

**access method.** A technique for moving data between main storage and input/output devices.

**access priority.** The maximum priority that a token can have for the adapter to use it for transmission.

**access procedure.** The procedure or protocol used to gain access to a shared resource. In a local area network, the shared resource is the medium. The medium access procedures specified by the IEEE 802 standard are CSMA/CD token, bus, and ring.

**access unit.** In an IBM Token-Ring Network, a wiring concentrator. See *multistation access unit*.

**acknowledgment.** The transmission, by a receiver, of acknowledge characters as an affirmative response to a sender.

**active.** Able to communicate on the network. An adapter is active if it is able to pass tokens on the network.

**active logical terminal (LT).** In MLT, the active LT is the currently displayed logical terminal. Synonymous with *foreground logical terminal*. Contrast with *background logical terminal*.

**active monitor.** A function in a single adapter on a ring network that initiates the transmission of tokens and provides token error recovery facilities. Any active adapter on the ring has the ability to provide the active monitor function if the current active monitor fails.

**adapter.** (1) A mechanism for attaching parts, for example, parts having different diameters. (2) See *channel-to-channel adapter, communication adapter, ring interface adapter, staging adapter*. (3) See also *attachment feature*.

**Adapter Support Interface.** The software used to operate IBM Token-Ring Network Adapters in an IBM Personal Computer and to provide a common interface to application programs.

**address.** (1) A value that identifies a register, a particular part of storage, a data source, or a data sink. The value is represented by one or more characters. (2) To refer to a device or an item of data by its address. (3) In word processing, the location, identified by an address code, of a specific section of the recording medium or storage. (4) The location in the storage of a computer where data is stored. (5) In data communication, the unique code assigned to each device or work station connected to a network.

**AEA port.** A communication connector on the Asynchronous Emulation Adapter (AEA).

**AEA port set.** One or more 3174 ports that support individual AEA station sets; they must have the same port (connection) type and modem type, but different station types.

**AEA station.** A 3270 or ASCII display station, printer, or host that communicates through the Asynchronous Emulation Adapter.

**AEA station set.** One or more AEA stations that have the same attributes, for example, line speed and parity.

**alert.** (1) In the IBM Token-Ring Network Manager, a notification appearing on the bottom line of any panel to indicate an interruption or a potential interruption in the flow of data around the ring. (2) In the NetView\* program, a notification about a high-priority event that warrants immediate attention. This data-base record is generated for certain event types that are defined by user-constructed filters.

**alphanumeric field.** A field that may contain any alphabetic, numeric, or special characters.

**alternate 1 initial microcode load (Alt 1 IML).** The action of loading the utility microcode.

**alternate character set.** A character set, located in the terminal, from which characters are obtained for display and printing by using the graphic escape character in the data stream.

**alternate cursor.** An image reversal of each dot in the character cell at the cursor position.

---

\* NetView is a trademark of the International Business Machines Corporation.



## Glossary

**ambient.** Environment.

**American National Standard Code for Information Interchange (ASCII).** A standard code, using a coded character set consisting of 7-bit coded characters (8 bits including parity check), used for information interchange among data processing systems, data communication systems, and associated equipment. The ASCII set consists of control characters and graphic characters.

**appendage.** An application program routine provided to assist in handling a specific occurrence.

**application.** The use to which an information processing system is put, for example, a payroll application, an airline reservation application, a network application.

**application program.** (1) A program written for or by a user that applies to the user's work, such as a program that does inventory control or payroll. (2) A program used to connect and communicate with stations in a network, enabling users to perform application-oriented activities.

**ASCII emulation.** The ability of a 3270 display station or printer to communicate with an ASCII host.

**ASCII pass-through.** The transmission of unmodified data between ASCII display stations or printers and an ASCII host (NCP).

**ASCII pass-through mode.** For an ASCII device attached to a 3174, a mode of operation in which the device communicates with an ASCII host (NCP).

**asynchronous.** Without regular time relationship; unexpected or unpredictable with respect to the execution of program instructions.

**Asynchronous Emulation Adapter (AEA).** In the 3174 Subsystem Control Unit, an adapter that enables an ASCII terminal to communicate with a 3270 host, an ASCII terminal to communicate with an ASCII host through the 3174, and a 3270 terminal to communicate with an ASCII host.

**attach.** To connect a device logically to a ring network so that it can communicate over the network.

**attaching device.** Any device that is physically connected to a network and can communicate over the network.

**attachment feature.** The circuitry by which a cable from a local terminal or a modem for a remote terminal is attached to a 3792 Auxiliary Control Unit or a 3791 Contoller.

**attention (ATTN).** An occurrence external to an operation that could cause an interruption of the operation.

**attention field.** In the 3270 Information Display System, a detectable field in which the designator character is a null, a space, or an ampersand.

**attention identifier (AID).** (1) A code in the inbound 3270 data stream that identifies the source or type of data that follows. (2) A character in a data stream indicating that the user has pressed a key, such as Enter, that requests an action by the system.

**attention interruption.** An I/O interruption caused by a terminal user's pressing an attention key, or its equivalent.

**attention key.** A function key on terminals that, when pressed, causes an I/O interruption in the processing unit.

**attenuation.** A decrease in magnitude of current, voltage, or power of a signal in transmission between points. It may be expressed in decibels or nepers.

**attribute.** (1) A property or characteristic of one or more entities, for example, color, weight, sex. (2) A terminal display language or transformation definition language (TDL) keyword that specifies a particular quality for the TDL object with which it is associated.

**attribute select keyboard.** A keyboard that enables the operator, when permitted by the program, to change the character attributes of the keyed-in character.

**audible alarm.** An alarm that is sounded when designated events occur that require operator attention or intervention before system operation can continue.

**auto-answer.** See *automatic answering*.

**auto-call.** See *automatic calling*.

**automatic answering.** (1) Answering in which the called data terminal equipment (DTE) automatically responds to the calling signal.

**Note:** The call may be established whether or not the called DTE is attended.

(2) A machine feature that permits a station to respond without operator action to a call it receives over a switched line. See also *manual answering*. Contrast with *automatic calling*.

**automatic calling.** (1) Calling in which the elements of the selection signal are entered into the data network contiguously at the full data signaling rate.

**Note:** The selection signal is generated by the data terminal equipment. A limit may be imposed by the design criteria of the network to prevent more than a permitted number of unsuccessful call attempts to the same address within a specified period.

(2) A machine feature that permits a station to initiate a connection with another station over a switched line without operator action. (3) Synonymous with *auto-call*. See also *manual calling*. Contrast with *automatic answering*.

**automatic polling (auto-poll).** (1) A hardware feature of a telecommunications unit that processes a polling list, polling the terminals in order and handling negative responses to polling without interrupting the processing unit. At the end of the list, polling is automatically begun again at the beginning of the list. Synonymous with *auto-poll*. (2) See also *polling*.

**automatic skip (auto-skip).** After entry of a character into the last character position of an unprotected display field, automatic repositioning of the cursor from a protected and numeric field to the first character position of the next unprotected display field.

**auto-poll.** See *automatic polling*.

**auto removal.** Removing a device from the data-passing activity without human intervention. This action is accomplished by the adapter.

**auto-skip.** See *automatic skip*.

## B

**background logical terminal (LT).** In MLT, the background LT is any LT that is not currently displayed. Contrast with *active logical terminal (LT)*.

**backup path.** An alternative path for signal flow through access units and their main ring path cabling. The backup path allows recovery of the operational portion of the network while problem determination procedures are being performed.

**balun.** A transformer for connecting balanced (for instance, twisted-pair) cables to unbalanced (for instance, coaxial) cable by matching the electrical characteristics of the cables.

**bandwidth.** The difference, expressed in Hertz, between the highest and the lowest frequencies of a range of frequencies.

**base color.** The capability of displaying or printing all characters in a field, in one of four colors, on a color terminal by use of combinations of the field protection and the field intensify bits of the field attribute.

**beacon.** Synonym for *beacon message*.

**beacon frame.** Synonym for *beacon message*.

**beacon message.** A frame or message repeatedly transmitted by a station on detection of a line break or outage. Transmission of beacon messages stops when the fault is bypassed or eliminated. Synonymous with *beacon* and *beacon frame*.

**binary synchronous communication (BSC).** Data transmission in which character synchronism is controlled by timing signals generated at the sending and receiving stations.

**blink.** An extended highlighting attribute value (for emphasis) of a field or character.

**buffer.** (1) A routine or storage used to compensate for a difference in rate of flow of data, or time of occurrence of events, when transferring data from one device to another. (2) An isolating circuit used to prevent a driven circuit from influencing the driving circuit. (3) To allocate and schedule the use of buffers. (4) A portion of storage used to hold input or output temporarily.

**buffer address.** The address of a location in the buffer at which one character can be stored.

**buffer storage.** (1) A storage device that is used to compensate for differences in the rate of flow of data between components of a data processing system, or for the time of occurrence of events in the components. (2) In word processing, a temporary storage in which text is held for processing or communication.

**burst.** (1) In data communication, a sequence of signals counted as one unit in accordance with some specific criterion or measure. (2) To separate continuous-form paper into discrete sheets.

**bus.** A type of network topology where the network consists of a bidirectional communication path with defined end points.

**bypass.** To eliminate an attaching device or an access unit from a ring network by allowing the data to flow in a path around it.

## C

**card.** With relation to the 3174, a unit of electronic circuitry contained in a plastic casing (or cassette) and providing the control unit with a specialized function, for example, a Terminal Adapter or an Encrypt/Decrypt Adapter.

**category A terminals.** Terminals that can be attached to the 3174 Subsystem Control Unit and to type A adapters in the 3274 Control Unit. For example, the 3278 and 3279 display stations, the 3287 Models 1, 1C, 2, and 2C, the 3262 Models 3 and 13, and the 3289 Models 1 and 2 printers.

## Glossary

**category B terminals.** Terminals that can be attached to type B adapters in the 3274 Control Unit, for example, the 3277 Display Station and the 3284, 3286, 3287 Models 1 and 2, and 3288 printers.

**central site customizing.** The process of tailoring control unit microcode for each control unit in a network, at the central site.

**central site library.** One or more Library diskettes that contain customizing data and label information for the control units in a network.

**change-screen key.** In MLT, a key or sequence of keys on a display station keyboard used to establish sessions, one at a time, with up to five different hosts.

**channel-attached.** Pertaining to attachment of devices directly by data channels (I/O channels) to a computer. Synonym for *local*. Contrast with *telecommunication-attached*.

**channel command.** An instruction that directs a data channel, control unit, or device to perform an operation or set of operations.

**channel-to-channel adapter.** A hardware device that can be used to connect two channels on the same computing system or on different systems.

**character attribute.** The properties of a character with respect to its color, highlighting, and character set. See also *extended field attribute*.

**character buffer.** The read/write storage used by a partition for storing character or graphic data for display or printing on a terminal.

**character mode.** A mode in which input is treated as alphanumeric data, rather than graphic data.

**character position.** A location on the screen at which one character can be displayed; also, an addressed location in the buffer at which one character can be stored.

**character set.** (1) A defined collection of characters in a loadable or nonloadable set selected by means of a local character set identifier. (2) An attribute type in the extended field and character attributes. (3) An attribute passed between session partners in the Start Field Extended, Modify Field, and Set Attribute orders.

**closed path (or network).** A network in which all the cable paths and wiring closets are directly or indirectly connected.

**cluster.** A station that consists of a control unit (a cluster controller) and the terminals attached to it.

**cluster control unit.** Synonym for *cluster controller*.

**cluster controller.** A device that can control the input/output operations of more than one device connected to it. A cluster controller may be controlled by a program stored and executed in the unit, for example, the IBM 3601 Finance Communication Controller. Or, it may be entirely controlled by hardware, for example, the IBM 3272 Control Unit. See also *cluster* and *cluster controller node*. Synonymous with *cluster control unit*.

**cluster controller node.** A peripheral node that can control a variety of devices. See also *host node* and *terminal node*.

**coaxial cable.** A cable consisting of one conductor, usually a small copper tube or wire, within and insulated from another conductor of larger diameter, usually copper tubing or copper braid.

**command.** An instruction that directs a control unit or device to perform an operation or a set of operations.

**command retry.** A channel and control unit procedure that causes a command to be retried without requiring an I/O interruption.

**communication adapter.** (1) A circuit card with associated software that enables a processor, controller, or other device to be connected to a network. (2) See *V.35 communication adapter* and *X.21 communication adapter*.

**communication control unit.** A communication device that controls transmission of data over lines in a network.

**communication controller.** (1) A device that directs the transmission of data over the data links of a network; its operation may be controlled by a program processed in a processor to which the controller is connected or by a program executed within the device. (2) A type of communication control unit whose operations are controlled by one or more programs stored and executed in the unit. It manages the details of line control and the routing of data through a network. (3) See also *cluster controller*, *communication controller node*, and *transmission control unit*.

**communication controller node.** A subarea node that does not contain a system services control point (SSCP).

**communication management host.** In ACF/TCAM, the host in a communication management configuration that performs all network-control functions in the network except control of locally attached stations of data hosts.

**completion code.** The final return code provided by the adapter as a result of an issued command.

**component.** (1) Hardware or software that is part of a functional unit. (2) A functional part of an operating system, for example, the scheduler or supervisor. (3) In systems with VSAM, a named, cataloged collection of

stored records, such as the data component or index component of a key-sequenced file or alternate index. (4) In System/38 graphics, the representation of a data group on a chart. (5) See *terminal component* and *solid state component*.

**configuration.** (1) The arrangement of a computer system or network as defined by the nature, number, and chief characteristics of its functional units. More specifically, the term *configuration* may refer to a hardware configuration or a software configuration. (2) See also *system configuration*.

**connecting blocks.** Fixtures used to terminate telephone wires in a wiring closet.

**Connection Menu.** A menu on the screen of a display station attached to the 3174 Subsystem Control Unit, from which a user can select an available host.

**connector.** (1) A flowchart symbol that represents a break in a flowline and indicates where the flowline is continued. (2) A means of establishing electrical flow.

**control block.** In the IBM Token-Ring Network, a specifically formatted block of information provided from the application program to the Adapter Support Interface to request an operation.

**control character.** A character used in conjunction with a Write command to specify that a control unit is to perform a particular operation.

**control codes.** The hexadecimal values hex 00 through hex 3F, and hex FF in the 3270 data stream.

**Control diskette.** A customized diskette containing the microcode that describes a particular control unit's attached terminals, and its method of attachment to the host. The customized diskette is mailed to the control unit for which it was generated.

**control function.** Synonym for *control operation*.

**control operation.** (1) An action that affects the recording, processing, transmission, or interpretation of data; for example, starting or stopping a process, carriage return, font change, rewind, and end of transmission. (2) Synonymous with *control function*.

**control unit.** A general term for any device that provides common functions for other devices or mechanisms. The 3174 is an example of a control unit.

**control unit terminal (CUT).** A terminal that relies on the 3174 to interpret the data stream. Examples are the 3178, 3179, 3278, and 3279.

**control unit terminal (CUT) mode.** A host-interactive mode that enables an IBM 3270 Personal Computer customized in this mode to run only one session emulating a 3178, 3179, 3278 Model 2, or 3279 Model S2A.

**controller.** A unit that controls input/output operations for one or more devices.

**conventional 3270.** A locally attached 3270 terminal or a remotely attached 3270 terminal that uses the BSC line discipline.

**conversion.** (1) In programming languages, the transformation between values that represent the same data item but belong to different data types. Information may be lost as a result of conversion because accuracy of data representation varies among different data types. (2) The process of changing from one method of data processing to another or from one data processing system to another. (3) The process of changing from one form of representation to another, for example, to change from decimal representation to binary representation.

**copy control character (CCC).** A character used in conjunction with the Copy command to specify the type of data to be copied.

**copy operation.** An operation that copies the contents of the buffer from one display station or printer to another display station or printer attached to the same control unit.

**cursor.** A unique symbol that identifies a character position in a screen display, usually the character position at which the next character to be entered from the keyboard will be displayed.

**customization.** Procedures that tailor the control unit microcode to fit the various types of display stations and printers and the method of host attachment that a particular control unit will handle.

**customizing display station.** A display station used to perform the customizing procedures; this display station must be attached to port 26-00 of the control unit. Only these display stations can be used for customizing: a 3278, a 3279, a 3178 operating in 3278-emulation mode, a 3179 operating in 3279-emulation mode, or an IBM 3270 Personal Computer operating in control unit terminal (CUT) mode.

**customizing keyboard.** A keyboard used to type in the customizing responses; this keyboard must be a Type-writer, Data Entry, APL (with APL off), or Text (with Text off) keyboard with a QWERTY layout. On a QWERTY layout, the first six characters on the left side of the top row of alphabetic characters are Q, W, E, R, T, Y.

## Glossary

**cyclic redundancy check.** A system of error checking performed at both the sending station and the receiving station after a block check character sequence has been accumulated.

## D

**Data Entry keyboard.** A keyboard layout designed for data entry applications.

**data host.** In an ACF/TCAM communication management configuration, a host that is dedicated to processing applications and does not control network resources, except for its locally attached devices. See also *communication management host*.

**data link.** Any physical link, such as a wire or a telephone circuit, that connects one or more devices or communication controllers.

**data processing (DP).** The systematic performance of operations upon data; for example, handling, merging, sorting, computing.

**data station.** See *station*.

**data stream.** (1) All data transmitted through a data channel in a single read or write operation. (2) A continuous stream of data elements being transmitted, or intended for transmission, in character or binary-digit form, using a defined format. See also *data stream format*.

**data stream format.** In SNA, the format of the data elements (end-user data) in the request unit (RU). See also *3270 data stream* and *SNA character string (SCS)*.

**data terminal equipment (DTE).** That part of a data station that serves as a data source, data sink, or both.

**data transfer.** The movement, or copying, of data from one location and the storage of the data at another location.

**data transfer mode.** Synonym for *data transfer phase*.

**data transfer phase.** (1) The phase of a data call during which data signals can be transferred between data terminal equipments (DTEs) connected by the network. (2) Synonymous with *data transfer mode*.

**decode.** (1) To convert data by reversing the effect of some previous encoding. (2) To interpret a code. (3) Contrast with *encode*.

**default destination.** A destination for display stations and printers that is defined in customization.

**default response.** A response supplied by the customizing program if a different response is not specified during customization.

**delimiter.** A bit pattern that defines the limits of a frame or token on a ring network.

**device.** A mechanical, electrical, or electronic contrivance with a specific purpose.

**diagnostics diskette.** A diskette used by computer users and service personnel to diagnose hardware problems.

**direct access storage.** (1) A storage device that provides direct access to data. (2) See also *immediate access storage* and *random access memory*.

**direct call facility.** A facility that permits calling without requiring the user to provide address selection signals; the network interprets the 'call request' signal as an instruction to establish a connection to one or more predetermined data stations.

**Note:** This facility may permit call setup faster than usual. No special priority is implied over other users of the network establishing a connection. The designated addresses are assigned for an agreed period of time.

**display field.** A group of consecutive characters (in the buffer) that starts with an attribute character (defining the characteristics of the field) and contains one or more alphanumeric characters. The field continues to, but does not include, the next attribute character.

**display frame.** (1) In computer graphics, an area in storage in which a display image can be recorded. (2) In computer micrographics, an area on a microform in which a display image can be recorded.

**distributed function terminal (DFT).** A programmable terminal that can perform operations previously performed by the control unit. These terminals can interpret the 3270 data stream themselves. Examples are the IBM 3270 Personal Computer and the 3290 Information Panel.

**distributed function terminal (DFT) mode.** A host-interactive mode that enables an IBM 3270 Information Display System customized in this mode to run as many as four host sessions. The sessions can emulate a 3178, 3179, 3278 Model 2, or 3279 Model S2A.

**distribution panel.** A wiring board that provides a patch panel function and mounts in a rack.

**dot.** One point in a printer or display block matrix.

**downstream.** (1) In the direction of data flow or toward the destination of transmission. (2) From the processor toward an attached unit or end user. (3) Contrast with *upstream*.

**downstream load (DSL).** The capability of a distributed function terminal to receive its control program from the control unit to which it is attached. A diskette containing the terminal's control program is loaded into the control unit.

**drop.** In the IBM Cabling System, a cable that runs from a faceplate to the distribution panel in a wiring closet.

**Note:** When the IBM Cabling System is used with the IBM Token-Ring Network, a drop may form part of a lobe. Cables between wiring closets are not classified as drops.

**duplex.** In data communication, pertaining to a simultaneous two-way independent transmission.

## E

**emulate.** (1) To imitate one system with another, primarily by hardware, so that the imitating system accepts the same data, executes the same computer programs, and achieves the same results as the imitated computer system. (2) Contrast with *simulate*.

**emulation.** (1) The imitation of all or part of one system by another, primarily by hardware, so that the imitating system accepts the same data, executes the same programs, and achieves the same results as the imitated computer system. (2) The use of programming techniques and special machine features to permit a computing system to execute programs written for another system. (3) Imitation, for example, imitation of a computer or device. (4) See *terminal emulation*. (5) Contrast with *simulation*.

**encode.** (1) To convert data by the use of a code or a coded character set in such a manner that reconversion to the original form is possible. *Encode* is sometimes loosely used when complete reconversion is not possible. (2) Contrast with *decode*.

**equipment rack.** A metal stand for mounting components.

**event.** (1) An occurrence or happening. (2) An occurrence of significance to a task; for example, the completion of an asynchronous operation, such as an input/output operation.

**extended attribute buffer.** The buffer in which the extended field attribute for the 3270 kanji display field is stored.

**extended binary-coded decimal interchange code (EBCDIC).** A coded character set of 256 eight-bit characters.

**extended color.** (1) A capability that allows color terminals to display or print fields or characters in colors using extended field and character attributes. (2) An attribute type in the extended field attribute and character attribute.

**extended field attribute.** Additional field definition to the field attribute that controls defining additional properties such as color, highlighting, character set, and field validation. The extended field attribute is altered by information passed in the Start Field Extended and Modify Field orders.

**extended highlighting.** (1) A function that provides blink, reverse video, and underscore for emphasizing fields or characters on devices supporting extended field attributes and character attributes. (2) An attribute type in the extended field attribute and character attribute. (3) An attribute passed between session partners in the Start Field Extended, Modify Field, and Set Attribute orders.

## F

**faceplate.** A plate for connecting data and voice connectors to a cabling system. It may be wall-mounted or surface-mounted.

**field.** See *display field*.

**field attribute.** A control character stored in the character buffer in the first character position of a field. For those devices supporting the 3270 data stream, a field attribute defines protected/unprotected, alphanumeric/numeric, detectable/nondetectable, display/nondisplay, intensity, and modified data tag (MDT).

**file adapter.** In the 3174, an adapter that provides input/output support for external storage devices, such as a diskette drive.

**flag.** (1) An indicator or parameter that shows the setting of a switch. (2) Any of various types of indicators used for identification, for example, a wordmark. (3) A character that signals the occurrence of some condition, such as the end of a word.

**flow control.** (1) In data communication, control of the data transfer rate. (2) In SNA, the process of managing the rate at which data traffic passes between components of the network. The purpose of flow control is to optimize the rate of flow of message units with minimum congestion in the network, that is, neither to overflow the buffers at the receiver or at intermediate routing nodes nor to leave the receiver waiting for more message units. (3) The methods used to control the flow of information across a network.

**foreground logical terminal (LT).** Synonym for *active logical terminal (LT)*.

## Glossary

**formatted diskette.** A diskette that can be used by the computer to store data.

**formatted display.** A screen display in which a display field (or fields) has been defined as a result of storing at least one attribute character in the display buffer.

**frame.** (1) The portion of a tape, on a line perpendicular to the reference edge, on which binary characters can be written or read simultaneously. (2) A housing for machine elements. (3) The hardware support structure, covers, and all electrical parts mounted therein that are packaged as one entity for shipping. (4) A formatted display. See *display frame*.

**from diskette.** The diskette that provides the data to be transferred.

**from drive.** The drive that provides the data to be transferred.

## G

**gateway.** A functional unit that connects two computer networks of different network architectures.

**gateway node.** A node that is an interface between networks.

**general polling.** (1) An input technique for remote 3270 devices in which special invitation characters are sent to a device control unit instructing that control unit to begin transmission from all devices ready to enter data. (2) See also *polling* and *specific polling*.

**generate.** In 3174 central site customizing, to write a Control diskette containing the customizing data for a particular control unit. Also, to print a mailing address label and a diskette label for a particular control unit.

**get.** In 3174 central site customizing, to select the type of data you want, and its source, and store it in working copy.

## H

**hard error.** An error condition on a network that requires that the network be reconfigured or that the source of the error be removed before the ring can resume reliable operation. Contrast with *soft error*.

**hertz (Hz).** A unit of frequency equal to 1 cycle per second.

**hexadecimal.** (1) Pertaining to a selection, choice, or condition that has 16 possible values or states. (2) Pertaining to a fixed-radix numeration system, with radix of 16. (3) Pertaining to a numbering system with base

of 16; valid numbers use the digits 0 through 9 and characters A through F, where A represents 10 and F represents 15.

**hexadecimal number.** The 1-byte hexadecimal equivalent of an EBCDIC character.

**host.** (1) See *communication management host* and *data host*. (2) See also *host access method*, *host application program*, *host computer*, *host interface*, *host logical unit (LU)*, *host mode*, *host node*, *host processor*, and *host system*.

**host access method.** The access method that controls communication with a domain.

**host application program.** An application program processed in the host computer.

**host attachment.** A mode of SNA communication in which the processor acts as a secondary SNA device.

**host computer.** (1) In a computer network, a computer that provides end users with services such as computation and data bases and that usually performs network control functions. (2) The primary or controlling computer in a multiple-computer installation. (3) A computer used to prepare programs for use on another computer or on another data processing system; for example, a computer used to compile link edit, or test programs to be used on another system. (4) Synonym for *host processor*.

**host interface.** Interface between a network and the host computer.

**host logical unit (LU).** An SNA logical unit (LU) located in a host processor, for example, an ACF/VTAM application program.

**host mode.** The operating mode of an HASP main processor communicating with an HASP work station.

**host node.** (1) A node at which a host processor is located. (2) In SNA, a subarea node that contains a system services control point (SSCP); for example, a System/370 computer with OS/VS2 and ACF/TCAM.

**host processor.** (1) A processor that controls all or part of a user application network. (2) In a network, the processing unit in which resides the access method for the network. (3) In an SNA network, the processing unit that contains a system services control point (SSCP). (4) A processing unit that executes the access method for attached communication controllers. (5) The processing unit required to create and maintain PSS. (6) Synonymous with *host computer*.

**host system.** (1) A data processing system used to prepare programs and operating environments for use on another computer or controller. (2) The data processing system to which a network is connected and with

which the system can communicate. (3) The controlling or highest-level system in a data communication configuration; for example, a System/38 is the host system for the work stations connected to it.

## I

**IBM Cabling System.** A permanently installed wiring system that eliminates the need to rewire when terminals are moved from one location to another within an office complex. It allows transmission of data at very high speeds and is the foundation for installing a local area network.

**idles.** Signals sent along a ring network when neither frames nor tokens are being transmitted.

**immediate access storage.** A storage device whose access time is negligible in comparison with other operating times.

**initial microcode load (IML).** The action of loading the operational microcode.

**input device.** A device in a data processing system by which data may be entered into the system.

**input mode.** A mode in which records can be read from a file.

**input/output (I/O).** (1) Pertaining to a device whose parts can perform an input process and an output process at the same time. (2) Pertaining to a functional unit or channel involved in an input process, output process, or both, concurrently or not, and to the data involved in such a process.

**Note:** The phrase *input/output* may be used in place of *input/output data*, *input/output signals*, and *input/output process* when such a usage is clear in context.

(3) Pertaining to input, output, or both.

**intensified display.** An attribute of a display field; causes data in that field to be displayed at a brighter level than other data displayed on the screen.

**interface.** (1) A shared boundary between two functional units, defined by functional characteristics, common physical interconnection characteristics, signal characteristics, and other characteristics as appropriate. (2) A shared boundary. An interface may be a hardware component to link two devices or a portion of storage or registers accessed by two or more computer programs. (3) Hardware, software, or both, that links systems, programs, or devices.

**intermediate telephone closet.** A room containing connection points for telephone wiring, located between the main telephone closet and work areas.

## J

**jack.** A connecting device to which a wire or wires of a circuit may be attached and that is arranged for insertion of a plug.

## K

**keyboard definition.** A customizing procedure for defining a maximum of four modified keyboard layouts for modifiable keyboards only. Most characters, symbols, and functions can be relocated, duplicated, or deleted from almost any keyboard position.

**keyboard mapping.** A table that defines which keyboard sequences are equivalent to functions on another keyboard.

## L

**layer.** One of the seven layers of the Open Systems Interconnection reference model.

**leased line.** Synonym for *nonswitched line*.

**Library diskette.** A diskette that contains customizing data for some or all of the control units in a network.

**light pen.** A light-sensitive pick device that is used by pointing it at the display surface.

**line control characters.** Characters that regulate the transmission of data over a line; for example, delimiting messages, checking for transmission errors, and indicating whether a station has data to send or is ready to receive data.

**line speed.** (1) The rate at which data is transmitted from one point to another over a telecommunication line. (2) The number of binary digits that can be sent over a telecommunication line in 1 second, expressed in bits per second (bps).

**link.** The logical connection between nodes, including the end-to-end link control procedures.

**link-attached.** Pertaining to the attachment of devices to a central computer through a communication control unit. Contrast with *channel-attached*. Deprecated term for *telecommunications-attached*.

**link connection.** All physical components and protocol machines that lie between the communicating link stations of a link. The link connection may include a switched or nonswitched physical data circuit, a local area network, or an X.25 virtual circuit.

**link station.** (1) A specific place in a service access point that enables an adapter to communicate with another adapter. (2) A protocol machine in a node that



## Glossary

manages the elements of procedure required for the exchange of data traffic with another communicating link station.

**lobe.** In the IBM Token-Ring Network, the section of cable that attaches a device to an access unit. The cable may consist of several segments.

**lobe bypass.** (1) The capability of a lobe attaching unit to disconnect a lobe and its attached data station from a ring network for replacement, relocation, or repair without disrupting network operation. (2) In a star/ring network configuration, removal of a wiring concentrator and an attached lobe from the network when a fault is detected or when an attached lobe must be disconnected for servicing.

**lobe logic.** The portion of the circuitry within an access unit that is associated with a single lobe receptacle on the access unit.

**lobe receptacle.** In the IBM Token-Ring Network, an outlet on an access unit for connecting a lobe.

**local.** (1) In programming languages, pertaining to the relationship between a language object and a block such that the language object has a scope contained in that block. (2) Pertaining to that which is defined and used only in one subdivision of a computer program. (3) Pertaining to a device accessed directly without use of a telecommunication line. (4) Synonymous with *channel-attached*. (5) Contrast with *remote*.

**local area network (LAN).** A data network located on the user's premises in which serial transmission is used for direct data communication among data stations.

### Notes:

1. Communication within a local area network is not subject to external regulation; however, communication across the LAN boundary may be subject to some form of regulation.
2. A local area network does not use store and forward techniques.

**location.** With reference to a 3174, a place within the 3174 chassis where a particular card or adapter is inserted.

**logical terminal (LT).** In MLT, one of five sessions available to share one display station.

**logical unit (LU).** In SNA, a port through which an end user accesses the SNA network in order to communicate with another end user and through which the end user accesses the functions provided by system services control points (SSCPs). An LU can support at least two sessions, one with an SSCP and one with another LU,

and may be capable of supporting many sessions with other logical units. See also *network addressable unit*, *physical unit*, *primary logical unit*, *secondary logical unit*, and *system services control point*.

**loop.** A closed unidirectional signal path connecting input/output devices to a network.

## M

**main ring path.** The part of the ring made up of access units and the cables connecting them.

**main storage.** Program-addressable storage from which instructions and other data can be loaded directly into registers for subsequent processing.

**main telephone closet.** A room where telephone cables enter a building and are connected to building telephone wiring.

**maintenance analysis procedure (MAP).** A maintenance document that gives an IBM service representative a step-by-step procedure for tracing a symptom to the cause of a failure.

**manual answering.** (1) Answering in which a call is established only if the called user signals a readiness to receive the call by means of a manual operation. (2) Operator actions to prepare a station to receive a call on a switched line. Contrast with *automatic answering*.

**manual calling.** (1) Calling that permits the entry of selection signals from a calling data station at an undefined character rate. (2) Operator actions to place a call over a switched line. Contrast with *automatic calling*.

**Note:** The characters may be generated at the data terminal equipment or at the data circuit-terminating equipment.

**Master Control diskette.** A diskette that contains the base microcode, any necessary patches, RPQs, and modified keyboard tables.

**memory.** (1) Program-addressable storage from which instructions and other data can be loaded directly into registers for subsequent execution or processing. (2) Synonymous with main storage.

**microcode.** (1) One or more microinstructions. (2) A code, representing the instructions of an instruction set, that is implemented in a part of storage that is not program-addressable. (3) To design, write, and also to test one or more microinstructions.

**Note:** The term *microcode* represents microinstructions used in a product as an alternative to hard-wired circuitry to implement functions of a processor or other system component. The term *microprogram* means a dynamic arrangement of one or more groups of microinstructions for execution to perform a certain function.

**microcode upgrade diskette.** An upgraded version of a Control diskette that includes new function, such as the ability to handle a new type of display station.

**modem (modulator/demodulator).** A device that converts digital data from a computer to an analog signal that can be transmitted on a telecommunication line, and converts the analog signal received to data for the computer.

**Modify Field (MF) order.** An order that allows specified field attributes to be modified.

**multiple logical terminal device.** A CUT display station attached to the control unit that has been customized to support more than one session; the display station using this function may be attached to the 3174 only through a terminal adapter.

**multiple logical terminal port.** A control unit port that has been customized to support multiple sessions.

**multiple logical terminals (MLT).** In the 3174, a function that provides a CUT-attached fixed-function display station with the ability to interact with as many as five host sessions. Each session is processed as though it were a separate display station.

**multistation access unit.** In the IBM Token-Ring Network, a wiring concentrator that can connect up to eight lobes to a ring.

## N

**native mode.** A 3179 or 3180 operational mode that uses the full capabilities of those models' display and keyboard.

**nearest active upstream neighbor (NAUN).** In the IBM Token-Ring Network, that station sending data directly to a given station on the ring.

**NetView™ program.** A comprehensive network management program that is the basis for central control of both systems for network operations. It supersedes NCCF, NPDA, NLDM, and NPM.

**network.** (1) An arrangement of nodes and connecting branches. Connections are made between data stations. (2) A configuration of data processing devices and software connected for information interchange.

**network addressable unit (NAU).** In SNA, a logical unit, a physical unit, or a system services control point. The NAU is the origin or the destination of information transmitted by the path control network. See also *logical unit*, *physical unit*, and *system services control point (SSCP)*.

**network administrator.** A person who manages the use and maintenance of a network.

**network application program.** A program used to connect and communicate with adapters on a network, enabling users to perform application-oriented activities and to run other application programs.

**network control program node.** In SNA products, a subarea node that contains an ACF/NCP program but not a system services control point (SSCP).

**Network Terminal Option (NTO).** An IBM licensed program that extends the capabilities of the ACF/NCP to support a select group of non-SNA devices.

**node.** An end point of a link or a junction common to two or more links in a network.

**nonswitched line.** (1) A connection between systems or devices that does not have to be made by dialing. Contrast with *switched line*. (2) A telecommunication line on which connections do not have to be established by dialing. Synonymous with *leased line*.

## O

**observer terminal.** In problem determination for the IBM Token-Ring Network, the device used to run the Ring Diagnostic or a network application program that is capable of providing ring status information.

**office.** See *work area*.

**offline test.** A diagnostic test or data collection program that must be run when the 3174 and its connected terminals are not in normal operation.

**ohm.** The practical meter-kilogram-second unit of electric resistance equal to the resistance of a circuit in which a potential difference of 1 volt produces a current of 1 ampere.

**online test.** A diagnostic test or data collection program that is run without interrupting the normal operation of the 3174 and its associated terminals.

**open.** (1) To make an adapter ready for use. (2) A break in an electrical circuit.

**operational diskette.** See *working diskette*.

## Glossary

**operator information area (OIA).** The area below the line near the bottom of the display area where graphics and alphanumeric characters are displayed to define the status of the terminal or the system to the operator.

**optical fiber.** A single, separate optical transmission element comprising a core and a cladding.

**optical fiber cable.** One or more optical fibers with strengthening material and a protective cover.

**optical fiber connector.** Hardware installed on optical fiber cable ends to provide physical and optical cable attachment to a transmitter, a receiver, or a communication patch panel.

**original equipment manufacturer (OEM).** A manufacturer of equipment that may be marketed by another manufacturer.

**output device.** A device in a data processing system by which data may be received from the system.

## P

**padding.** (1) A technique by which a receiving station controls the rate of transmission of a sending station to prevent overrun. (2) In SNA, a technique by which a receiving component controls the rate of transmission of a sending component to prevent overrun or congestion.

**parallel.** (1) Pertaining to a process in which all events occur within the same interval of time, each handled by a separate but similar functional unit; for example, the parallel transmission of the bits of a computer word along the lines of an internal bus. (2) Pertaining to concurrent or simultaneous operation of two or more devices or to concurrent performance of two or more activities in a single device. (3) Pertaining to concurrent or simultaneous occurrence of two or more related activities in multiple devices or channels. (4) Pertaining to the simultaneity of two or more processes. (5) Pertaining to the simultaneous processing of the individual parts of a whole, such as the bits of a character and the characters of a word, using separate facilities for the various parts. (6) Contrast with *serial*.

**parameter.** (1) A variable that is given a constant value for a specified application and that may denote the application. (2) An item in a menu for which the user specifies a value or for which the system provides a value when the menu is interpreted. (3) Data passed between programs or procedures.

**passive wiring concentrator.** A wiring concentrator that does not require a power source. See *wiring concentrator*.

**patch cable.** In the IBM Cabling System and the IBM Token-Ring Network, a length of type 6 cable with data connectors on both ends.

**path.** In a network, a route between any two nodes.

**physical unit (PU).** In SNA, the component that manages and monitors the resources (such as attached links and adjacent link stations) of a node, as requested by an SSCP through an SSCP-SSCP session.

**plenum cable.** A cable that is UL-listed as having adequate fire resistance and low smoke-producing characteristics for installation without conduit in ducts, plenums, and other spaces used for environmental air, as permitted by NEC Articles 725-2(b) and 800-3(d).

**point-to-point connection.** A connection established between two data stations for data transmission. The connection may include switching facilities.

**polling.** (1) On a multipoint connection or a point-to-point connection, the process whereby data stations are invited one at a time to transmit. (2) Interrogation of devices for such purposes as to avoid contention, to determine operational status, or to determine readiness to send or receive data.

**port.** (1) An access point for data entry or exit. (2) A connector on a device to which cables for other devices such as display stations and printers are attached.

**Power-On Self-Test (POST).** A series of diagnostic tests that are run each time the computer's power is turned on.

**Prepare to Read (PTR) command.** A command for a local 3274 Model 1D that allows the terminal to know the next program action.

**primary logical unit (PLU).** In SNA, the logical unit (LU) that contains the primary half-session for a particular LU-LU session. Contrast with *secondary logical unit*.

**primary session.** In MLT, the primary session is the first session defined on a port.

**printer authorization matrix (PAM).** A matrix stored in the control unit that establishes printer assignment and classification.

**private branch exchange (PBX).** A private telephone exchange, automatic or manual, that provides for the transmission of calls to and from the public telephone network.

**problem isolation chart (PIC).** A diagnostic procedure for finding problems with a personal computer or its options.

**program access (PA) key.** On a display device keyboard, a key that produces a call to a program that performs display operations. See also *program function (PF) key*.

**program attention key.** On a display device keyboard, a key that produces an interruption to solicit program action. See also *program access (PA) key* and *program function (PF) key*.

**program function (PF) key.** On a display device keyboard, a key that passes a signal to a program to call for a particular display operation. See also *program access (PA) key*. If a Read Modified command is issued in response to the program function key interruption, the attention identifier (AID) and all display fields in which the modified data tags are set are transferred to the program.

**protected field.** (1) In word processing, preset data or an area that cannot be changed or overridden by an operator without altering the program. (2) On a display device, a display field in which a user cannot enter, modify, or erase data. (3) Contrast with *unprotected field*.

**protocol.** (1) A set of semantic and syntactic rules that determines the behavior of functional units in achieving communication. (2) In SNA, the meanings of and the sequencing rules for requests and responses used for managing the network, transferring data, and synchronizing the states of network components.

**protocol handler.** Programming in an adapter that encodes and decodes the protocol used to format signals sent along a network.

**put.** In 3174 central site customizing, to store data from the working copy into a library member.

## Q

## R

**rack inventory chart.** A chart indicating the location of the components installed in the rack.

**random access memory (RAM).** (1) A storage device into which data is entered and from which data is retrieved in a nonsequential manner. (2) See also *direct access storage*.

**read-only memory (ROM).** A computer's storage area whose contents cannot be modified.

**Receive receptacle.** On the IBM 8219 Optical Fiber Repeater, the receptacle that receives the signal in the main ring.

**receptacle.** See *lobe receptacle*.

**register.** (1) A storage device having a specified storage capacity such as a bit, byte, or computer word, and usually intended for a special purpose. (2) On a calculator, a storage device in which specific data is stored.

(3) In DPCX, a field capable of containing 10 digits, a sign, and a decimal point, that can be used by a program for arithmetic calculations and for program control. (4) On a document-copying machine, accurately to position the image of the original on the copy material.

**remote.** Pertaining to a system, program, or device that is accessed through a telecommunication line. Contrast with *local*.

**repeater.** In a ring network, a device that amplifies or regenerates data signals in order to extend the distance between attaching devices.

**request for price quotation (RPQ).** An alteration or addition to the functional capabilities that the control unit provides.

**response field.** On a display device, a specified area on the display space where the user can enter, modify, or erase response data.

**Response Time Monitor (RTM).** A network management tool that measures and records the transaction times of inbound host attention (AID) operations from display stations that communicate with the host.

**return code.** A hexadecimal value provided by the adapter to indicate the result of an action.

**ring (network).** A network configuration where a series of attaching devices are connected by unidirectional transmission links to form a closed path.

**Ring Diagnostic.** In the IBM Token-Ring Network, a program to be run in an IBM Personal Computer that provides the user with information regarding the performance of the ring.

**ring error limit.** In the Ring Diagnostic, the point at which the number of soft errors can make ring operation unreliable.

**ring in.** In the IBM Token-Ring Network, the receive or input receptacle on an access unit. Contrast with *ring out*.

**ring interface adapter.** A device that assumes the basic data transmission functions of node, such as frame recognition, address decoding, error checking, buffering of frames, fault detection, and, in Token-Ring Networks, token generation.

**ring out.** In the IBM Token-Ring Network, the transmit or output receptacle. Contrast with *ring in*.

**ring sequence.** The order in which devices are attached on a ring network.

**ring status.** The condition of the ring.

## Glossary

**routing.** (1) The assignment of the path by which a message will reach its destination. (2) In SNA, the forwarding of a message unit along a particular path through a network, as determined by parameters carried in the message unit, such as the destination network address in a transmission header.

## S

**secondary logical unit (SLU).** In SNA, the logical unit (LU) that contains the secondary half-session for a particular LU-LU session. Contrast with *primary logical unit*.

**segment.** A section of cable between components or devices on the network. A segment may consist of a single patch cable, multiple patch cables connected, or a combination of building cable and patch cables connected.

**selector pen.** (1) A pen-like instrument that can be attached to a display station. When a program using full-screen processing is assigned to the display station, the pen can be used to select items on the screen or to generate an attention. (2) Synonym for *light pen*.

**serial.** (1) Pertaining to a process in which all events occur one after the other; for example, serial transmission of the bits of a character according to V24 CCITT protocol. (2) Pertaining to the sequential or consecutive occurrence of two or more related activities in a single device or channel. (3) Pertaining to the sequential processing of the individual parts of a whole, such as the bits of a character or the characters of a word, using the same facilities for successive parts. (4) Contrast with *parallel*.

**server.** On a local area network, a data station that provides facilities to other data stations, for example, a file server, a print server, a mail server.

**service access point.** A logical point made available by an adapter where information can be received and transmitted. A single SAP can have many links terminating in it.

**service clearance.** Minimum space required to allow working room for the machine operator and/or the customer engineer for servicing the unit.

**session.** (1) In MLT, synonymous with LT. (2) In SNA, a logical connection between two network addressable units that can be activated, tailored to provide various protocols, and deactivated as requested.

**session limit.** In 3174, the total number of logical terminals or defined AEA default destinations for an AEA port set.

**shared RAM.** Random access storage on the adapter that is shared by the IBM PC.

**simulate.** (1) To represent certain features of the behavior of a physical or abstract system by the behavior of another system; for example, to represent a physical phenomenon by means of operations performed by a computer or to represent the operations of a computer by those of another computer. (2) To imitate one system with another, primarily by software, so that the imitating system accepts the same data, executes the same computer programs, and achieves the same results as the imitated system. (3) Contrast with *emulate*.

**simulation.** (1) The representation of selected characteristics of the behavior of one physical or abstract system by another system. In a digital computer system, simulation is done by software; for example, (a) the representation of physical phenomena by means of operations performed by a computer system, and (b) the representation of operations of a computer system by those of another computer system. (2) Contrast with *emulation*.

**SNA character string (SCS).** A character string composed of EBCDIC controls, optionally intermixed with end-user data, that is carried within a request/response unit.

**soft error.** An intermittent error on a network that requires retransmission. Contrast with *hard error*.

**Note:** A soft error by itself does not affect overall reliability of the network, but reliability may be affected if the number of soft errors reaches the ring error limit.

**solid-state component.** A component whose operation depends on control of electric or magnetic phenomena in solids, for example, a transistor, crystal diode, ferrite core.

**sort.** In 3174 central site customizing, to arrange a list of library members according to date, name, or micro-code level.

**specific polling.** (1) A polling technique that sends invitation characters to a device to find out whether the device is ready to enter data. (2) See also *general polling* and *polling*.

**staging adapter.** (1) An addition to a System/370 Model 158 or 168 Integrated Storage Control (ISC) feature that enables the integrated storage control to operate in a 3850 Mass Storage System. (2) An IBM 3850 Model 3 Storage Control, which is a 3830 Model 2 Storage Control that has been modified to operate in a 3850 Mass Storage System.

**star.** A wiring arrangement in which an individual cable runs from each work area to a concentration point.

**start delimiter.** The first byte of a token or frame. It consists of a special recognizable bit arrangement.

**Start Field (SF) order.** An order that indicates a specified location that contains an attribute byte and not a text character.

**Start Field Extended (SFE) order.** An order that generates an extended field attribute in the EAB and at the current buffer location.

**station.** (1) An input or output point of a system that uses telecommunication facilities; for example, one or more systems, computers, terminals, devices, and associated programs at a particular location that can send or receive data over a telecommunication line. (2) A location in a device at which an operation is performed, for example, a read station. (3) In SNA, a link station.

**stop bit.** Synonym for *stop signal*.

**stop signal.** (1) In start-stop transmission, a signal at the end of a character that prepares the receiving device for reception of a subsequent character. (2) Synonymous with *stop bit*.

**storage.** (1) A unit into which recorded text can be entered, in which it can be retained and processed, and from which it can be retrieved. (2) See also *memory*.

**Note:** The terms *storage* and *memory* are sometimes used loosely as synonyms. In a more precise and useful sense, the term *memory* pertains to the part of storage in which instructions are executed (main storage or execution space) and excludes auxiliary storage devices such as disks, diskettes, mass storage devices, and magnetic tape. The term *memory* is used primarily in microcomputers and calculators, whereas the term *main storage* is used primarily in large and intermediate systems.

**structured field.** A data stream format that permits variable-length data and controls to be parsed into its components without having to scan every byte.

**subsystem.** A secondary or subordinate system, or programming support, usually capable of operating independently of or asynchronously with a controlling system. The 3174 and its attached terminals are referred to as a *subsystem*.

**switched line.** A telecommunication line in which the connection is established by dialing. Contrast with *non-switched line*.

**synchronous.** (1) Pertaining to two or more processes that depend on the occurrences of a specific event, such as common timing signal. (2) Occurring with a regular or predictable time relationship.

**Synchronous Data Link Control (SDLC).** A discipline conforming to subsets of the Advance Data Communication Control Procedures (ADCCP) of the American National Standards Institute (ANSI) and High-level Data Link Control (HDLC) of the International Organ-

ization for Standardization, for managing synchronous, code-transparent, serial-by-bit information transfer over a link connection. Transmission exchanges may be duplex or half-duplex over switched or nonswitched links. The configuration of the link connection may be point-to-point, multipoint, or loop. See also *binary synchronous communication (BSC)*.

**system configuration.** A process that specifies the devices and programs that form a particular data processing system.

**system services control point (SSCP).** In SNA, the focal point within an SNA network for managing the configuration, coordinating network operator and problem determination requests, and providing directory support and other session services for end users of the network. Multiple SSCPs, cooperating as peers, can divide the network into domains of control, with each SSCP having a hierarchical control relationship to the physical units and logical units within its domain.

**Systems Network Architecture (SNA).** The description of the logical structure, formats, protocols, and operational sequences for transmitting information units through, and controlling the configuration and operation of, networks.

**Note:** The layered structure of SNA allows the ultimate origins and destinations of information, that is, the end users, to be independent of and unaffected by the specific SNA network services and facilities used for information exchange.

## T

**telecommunications-attached.** Pertaining to the direct attachment of devices by channels to a host processor. Synonym for *remote*. Contrast with *channel-attached*.

**telecommunication control unit.** See *communication control unit*.

**telecommunication network.** In a telecommunication system, the combination of all terminals and other telecommunication devices and the lines that connect them.

**terminal.** (1) A point in a system or communication network at which data can either enter or leave.

**terminal adapter (TA).** An adapter that provides control for a maximum of 32 terminals; each BNC connector (four in all) on the terminal adapter can control either one terminal that is directly attached or as many as eight terminals that are attached through a terminal multiplexer adapter (located in the 3174) or a 3299 Terminal Multiplexer (located outside the 3174).

**terminal component.** A separately addressable part of a terminal that performs an input or output function, such as the display component of a keyboard-display device or a printer component of a keyboard-printer device.

## Glossary

**terminal emulation.** The capability of a microcomputer or personal computer to operate as if it were a particular type of terminal linked to a processing unit and to access data.

**terminal-initiated logon.** A logon request that originates from the terminal.

**terminal multiplexer.** A device, such as the 3299 Terminal Multiplexer, for interleaving the signals for many devices onto a single coaxial cable.

**terminal multiplexer adapter (TMA).** This adapter is connected to the terminal adapter in the 3174 and provides control for a maximum of eight terminals.

**terminal node.** (1) In a hierarchical data base, a node that has no subordinate records or segments. (2) In SNA products, a peripheral node that is not user-programmable and has less processing capability than a cluster controller node. Examples are nodes consisting of the IBM 3277 Data Station, 3767 Communication Terminal, 3614 Consumer Transaction Facility, and 3624 Consumer Transaction Facility.

**terminal port.** (1) In a network, the functional unit of a node through which data can enter or leave the network. (2) The part of a processor that is dedicated to a single data channel for the purpose of receiving data from or transferring data to one or more external or remote devices.

**terminating room.** See *wiring closet*.

**time-out.** (1) An event that occurs at the end of a predetermined period of time that began at the occurrence of another specified event. (2) A time interval allotted for certain operations to occur; for example, response to polling or addressing before system operation is interrupted and must be restarted. (3) A terminal feature that logs off a user if an entry is not made within a specified period of time.

**Note:** Time-out can be prevented by an appropriate signal.

**to diskette.** The diskette that receives the transferred data.

**to drive.** The drive that receives the transferred data.

**token.** In a local area network, the symbol of authority passed among data stations to indicate the station temporarily in control of the transmission medium.

**Note:** A token is a particular message or bit pattern that signifies permission to transmit.

**token monitor.** Synonym for *active monitor*.

**Token-Ring Network.** (1) A ring network that allows unidirectional data transmission between data stations by a token-passing procedure over one transmission

medium so that the transmitted data returns to the transmitting station. (2) A network that uses a ring topology, in which tokens are passed in a circuit from node to node. A node that is ready to send can capture the token and insert data for transmission.

**translate table.** A table that defines the translation of ASCII to EBCDIC and EBCDIC to ASCII and that allows the use of special characters and nonstandard codes.

**transmission control unit (TCU).** A communication control unit whose operations are controlled solely by programmed instructions from the computing system to which the unit is attached. No program is stored or executed in the unit, for example, the IBM 2702 and 2703 Transmission Controls. Contrast with *communication controller*. Synonymous with *telecommunication control unit*.

**Transmit receptacle.** On the IBM 8219 Optical Fiber Repeater, the receptacle that transmits the signal in the main ring.

**twinaxial cable.** A shielded cable with two conductors inside a larger conductor. The conductors are insulated from the larger conductor and from one another.

**TYPE.** The type number of the card; for example, 9150 is the type number of the Terminal Adapter in the 3174.

**type-1 communication adapter.** The 3174 adapter that supports communication between the 3174 (and its terminals) and a host over telecommunication links using any of these interfaces: (1) RS-232C/V.24 and V.35 for SNA/SDLC, (2) BSC, and (3) X.25. The user selects the appropriate interface.

**type-2 communication adapter.** The 3174 adapter that supports communication between the 3174 (and its terminals) and a host over telecommunication links using either the X.21 interface for SNA/SDLC or the X.25 interface. The user selects the interface.

## U

**unformatted display.** A screen display in which no attribute character (and, therefore, no display field) has been defined.

**unprotected field.** A displayed field in which a user can enter, modify, or delete data. Contrast with *protected field*.

**update.** In 3174 central site customizing, to tailor a library member's customizing data, in working copy, and put it back to the library diskette.

**upgrade.** In 3174 central site customizing, to select a library member and upgrade its data to the microcode level of the Central Site Customizing Procedure diskette.

**upstream.** (1) In the direction opposite to data flow or toward the source of transmission. (2) Toward the processor from an attached unit or end user. (3) Contrast with *downstream*.

**Utility diskette.** A diskette that contains the microcode necessary to run various customizing utilities, for example, to copy portions of a diskette for a backup diskette.

## V

**V.35 communication adapter.** A communication adapter that can combine and send information on one line at speeds up to 64 kbps, and conforms to the CCITT V.35 standard.

**vertical drop distance.** The vertical distance from the faceplate to the raceway, which is in either the ceiling or the floor.

## W

**wide area network (WAN).** A network that provides communication services to a geographic area larger than that served by a local area network.

**wire fault.** An error condition caused by a break in the wires or a short between the wires (or shield) in a segment of cable.

**wiring closet.** A room that contains one or more equipment racks and distribution panels that are used to connect cables.

**wiring concentrator.** In a star/ring network, a lobe concentrator that allows attaching devices to gain access to the ring at a central point, such as a wiring closet or an open work area. See also *lobe* and *lobe bypass*.

**Note:** In the event of a fault in a cable or at a station on the lobe, the wiring concentrator can bypass the fault by disconnecting the lobe from the rest of the ring. Wiring concentrators also simplify reconfiguration and network maintenance.

**work area.** An area in which terminals (such as display stations, keyboards, and printers) are located. Access units may also be located in work areas.

**work station.** An input/output device that allows transmission of data or reception of data as needed to perform a job.

**working copy (WC).** In 3174 central site customizing, a set of customizing data and label data held in main storage, which is tailored to reflect a network control unit's attached terminals, its method of host attachment, and other pertinent information.

**working diskette.** A computer diskette to which files are copied from an original diskette for use in everyday operation.

**wrap test.** A test that checks attachment or control unit circuitry without checking the mechanism itself by returning the output of the mechanism as input. For example, when unrecoverable communication adapter or machine errors occur, a wrap test can transmit a specific character pattern to or through the modem in a loop and then compare the character pattern received with the pattern transmitted.

**wraparound.** The continuation of an operation (for example, a read operation or a cursor movement operation) from the last character position in a buffer to the first character position in the buffer.

**write.** To make a permanent or transient recording of data in a storage device or on a data medium.

## X

**X.21.** In data communication, a recommendation of the International Telegraph and Telephone Consultative Committee (CCITT) that defines the interface between data terminal equipment and public data networks for digital leases and circuit switched synchronous services.

**X.21 communication adapter.** A communication adapter that can combine and send information on one line at speeds up to 64 kbps, and that conforms to CCITT X.21 standards.

**X.25.** In data communication, a recommendation of the CCITT that defines the interface between data terminal equipment and packet switching networks.

## Y

## Z

## 3

**3270 data stream.** Data being transferred from or to an allocated primary or tertiary device, or to the host system, as a continuous stream of data and 3270 Information Display System control elements in character form.

**3270 emulation.** The use of a program that allows a device or system such as a personal computer or a System/38 to operate in conjunction with a host system as if it were a 3270-series display station or control unit.





# Index

## A

ac indicator 2-4  
 ac power indicator 2-5, 3-9  
 accessories, cables, and plugs B-24  
 accessory cable, direct DPC-T3 attachment B-28  
 adapter connections fail, ASCII 3-57  
 adapter connectors, terminal B-22  
 adapter hardware group numbers B-2  
 adapter not respond to incoming call, ASCII 3-75  
 adapter not respond to rotary call, ASCII 3-79  
 adapter test 3-110  
 adapter test, Token-Ring 3-114  
 adapter wrap plug, ASCII B-29  
 adapter wrap plug, Token-Ring B-28  
 adapter, ASCII B-2  
 adapter, coax-to-twisted pair B-27  
 adapter, terminal B-2  
 adapter, Token-Ring B-2  
 address, directly connected 2-12  
 address, indirectly connected 2-12  
 address, terminal port 2-12  
 advance pushbutton 2-7  
 AEA (asynchronous emulation adapter) 1-5  
 AEA adapter worksheet 8A 3-50, 3-84  
 AEA diskette 2-13  
 all connections to ASCII adapter fail 3-57  
 all host connections to ASCII adapter fail 3-91  
 all terminals failing 3-19  
 all terminals on TMA failing 3-21  
 all terminals on 3299 fail 3-23  
 Alt 1 IML tests 3-110  
 alt 1 pushbutton 2-7  
 Alt 2 IML tests 3-108  
 alt 2 pushbutton 2-7  
 ASCII adapter (HG = 21, 22, or 23) B-2  
 ASCII adapter connections fail 3-57  
 ASCII adapter host connections fail, all 3-91  
 ASCII adapter not respond to incoming call 3-75  
 ASCII adapter not respond to rotary call 3-79  
 ASCII adapter wrap plug B-29  
 ASCII host communication links 3-87  
 ASCII host connection problem 3-5, 3-83  
 ASCII host connection to 3174 3-86  
 ASCII host fails, direct 3-93  
 ASCII host fails, nonswitched 3-97  
 ASCII host fails, switched 3-102  
 ASCII host symptom 3-90  
 ASCII terminal communication links 3-53  
 ASCII terminal connection problem 3-4  
 ASCII terminal fails, direct 3-59  
 ASCII terminal fails, nonswitched 3-64  
 ASCII terminal fails, switched 3-71

ASCII terminal problems 3-49  
 ASCII terminal symptom 3-56  
 asynchronous emulation adapter (AEA) 1-5, B-11  
 Asynchronous Emulation Adapter – Test 12 A-22  
 asynchronous emulation adapter feature B-8

## B

balun, coaxial cableless B-25  
 balun, coaxial red B-27  
 balun, coaxial yellow B-26  
 battery replacement, encrypt/decrypt Adapter 2-24  
 BNC connector B-23, B-24  
 BNC jack B-24

## C

cable connectors  
   BNC B-23  
   disconnecting and connecting B-21  
   DPC B-23  
 cable connectors, terminal B-21  
 cable problems 3-13, 3-49, 3-83  
 cable test 3-110  
 cable test, Token-Ring 3-114  
 cable wrap plug, V.35 B-29  
 cable, direct DPC-T3 attachment accessory B-28  
 cable, sequence and control 2-5  
 cable, token-ring adapter 2-8  
 cableless coaxial balun B-25  
 cables 2-8, B-1  
   coaxial 2-8  
   communication 2-8  
   power 2-8  
   Token-Ring 2-8  
 cables, plugs, and accessories B-24  
 cabling worksheet 3-14, 3-16, 3-52, 3-84, 3-86  
 channel interface switch 2-7, 5-5  
 chart, ASCII host symptom/action 3-90  
 chart, ASCII terminal symptom/action 3-56  
 chart, status code 4-4  
 chart, symptom/decision 3-4  
 chart, 3270 terminal symptom/action 3-18  
 check condition indicator 2-6, 3-3, 3-10  
 check status code 3-3  
 check 3174 power 3-7  
 check, online terminal – test 0 A-4  
 checking control unit power 3-7  
 clear pushbutton 2-7  
 coax-to-twisted pair adapter B-27  
 coaxial cable 2-8  
 coaxial cableless balun B-25  
 coaxial red balun B-27  
 coaxial yellow balun B-26

## Index

- collect information 3-13
- collect physical-connection information 3-16
- collect problem information 3-16, 3-49, 3-83
- communication adapter and cable test 3-110
- communication cable 2-8
- communication links hardware B-13
- communication links, ASCII host 3-87
- communication links, ASCII terminal 3-53
- communications, asynchronous emulation adapter B-9
- configuration menu – test 2 A-7
- configurations B-5
- connect cables, how to B-21
- connection menu B-16
- connection overview, 3174 B-2
- connection problem, ASCII host 3-5, 3-83
- connection problem, ASCII terminal 3-4, 3-49
- connection problem, local IBM host 3-5
- connection problem, remote IBM host 3-5
- connection problem, token-ring 3-6
- connection problem, 3270 3-4, 3-13
- connection problems 3-83
- connection problems, terminal or host 3-3
- connection to 3174, ASCII host 3-86
- connection to 3174, host 3-86
- connection, remote host 3-43
- connections B-1
- connections to ASCII adapter fail 3-57
- connectivity B-24
- connector, BNC B-24
- connector, DPC B-24
- connector, DPC-T3 B-24
- connector, sequence and control 2-5
- connector, 25-pin D-shell B-28
- connectors 2-8
  - coaxial 2-8
  - communication 2-8
  - power 2-8
  - Token-Ring 2-8
- connectors, modular telephone plug B-22
- connectors, terminal cable B-21
- control cable 2-5
- control diskette 2-13
- control diskette, setup 5-6
- control unit models, 3174 1-2
- control unit offline, relocation 5-8, 5-20
- control unit power check 3-7
- control unit problem determination 3-1
- control unit relocation 1-7, 5-8, 5-20
- control unit setup 1-7, 5-1, 5-12
- control unit, force offline 3-11
- customer extended problem determination guide 1-6
- customer setup and relocation instructions 5-1
- customizing 2-22, B-18
- customizing guide 1-6
- customizing menu – test 2 A-7
  - configuration questions A-7
  - hardware configuration A-7
  - printer authorization matrix A-7

## D

- D-shell connector B-28
- D-shell data connector/25-pin B-29
- data connector/25-pin D-shell B-29
- data transfer indicator 2-6
- dc power indicator 2-4, 2-20, 3-7
- description, diskette 2-13
- description, status codes 4-2
- description, 3174 1-4
- determine host connection to 3174 3-86
- determine terminal connection to 3174 3-52
- direct ASCII host fails 3-93
- direct ASCII terminal fails 3-59
- direct DPC-T3 attachment accessory cable B-28
- direct line link 3-54, 3-88
- directly connected address 2-12
- directly connected terminal fails 3-38
- disconnect cables, how to B-21
- diskette description 2-13
- diskette drive 2-13
- diskette, AEA 2-13
- diskette, control 2-13
- diskette, DSL 2-13
- diskette, encrypt/decrypt 2-13
- diskette, insert and remove 2-15
- diskette, installing 5-17
- diskette, RPQ 2-13
- diskette, setup control 5-6
- diskette, setup utility 5-6
- diskette, shipping and receiving 2-16
- diskette, storage 2-16
- diskette, utility 2-7, 2-13
- diskettes 1-9
  - drives 2-13
  - handling 2-14
  - inserting and removing 2-15
  - long-term storage 2-16
  - shipping and receiving 2-16
- diskettes, handling 2-14
- display master menu 2-22
- display online logs menu – test 1 A-5
- display online status summary – test 3 A-9
- display online test menu A-3
- double DPC-to-IBM cabling B-25
- DPC connector B-23, B-24
- DPC-to-IBM cabling B-25
- DPC-T3 connector B-24
- DPC-T3 direct attachment accessory cable B-28
- drive, diskette 2-13
- DSL diskette 2-13

**E**

EIA communication cable and connector 3-110  
 encrypt/decrypt battery, replacing 2-24  
 encrypt/decrypt diskette 2-13  
 entering online test mode A-2  
 establishing communications B-3  
 exiting online test mode A-2  
 extended PD guide 1-6

**F**

feature, asynchronous emulation adapter B-8  
 feature, gateway 1-5  
 features, 3174 1-4  
 force control unit offline 3-11

**G**

gateway feature 1-5  
 gateway host status summary A-19  
 green dc power indicator 2-20, 3-7  
 group numbers, 3174 adapter hardware B-2

**H**

handling diskettes 2-14  
 hardware configuration table A-8  
 hardware group numbers, 3174 adapter B-2  
 hardware, communication links B-13  
 help desk 1-7  
 host communication links, ASCII 3-87  
 host connection fails, remote 3-43  
 host connection problem, ASCII 3-5, 3-83  
 host connection problem, IBM local 3-5  
 host connection problem, IBM remote 3-5  
 host connection problems 3-3  
 host connection to 3174 3-86  
 host connections to ASCII adapter fail, all 3-91  
 host fails, ASCII direct 3-93  
 host fails, ASCII nonswitched 3-97  
 host fails, ASCII switched 3-102  
 host symptom, ASCII 3-90  
 how to disconnect and connect cables B-21  
 how to display status 4-2  
   chart 4-4

**I**

IBM host connection problem, local 3-5  
 IBM host connection problem, remote 3-5  
 IBM/ROLM 3270 coax-to-twisted pair adapter B-27  
 IML (initial microcode load) 2-4  
 IML procedure 2-17  
 IML pushbutton 2-6  
 IML tests, Alt 1 3-110  
 IML tests, Alt 2 3-108  
 IML 3174 2-17  
 IML, power control 2-18

indicator, ac 2-4  
 indicator, ac power 3-9  
 indicator, check condition 3-3, 3-10  
 indicator, dc power 2-20, 3-7  
 indicator, offline 2-19, 2-21, 3-11  
 indicators 2-6  
 indicators, 3174 2-2  
 indirectly connected address 2-12  
 information collection 3-13  
 initial microcode load (IML) 2-4  
 initial symptom/action table 3-3  
 insert diskette 2-15  
 installing diskette 5-17  
 instructions, setup and relocation 5-1

**J**

jack, BNC B-24  
 jacks B-23

**K**

keypad 2-7

**L**

link status summary A-18  
   com/res ind A-18  
   link address A-18  
   primary/secondary A-18  
   rec i-frames A-18  
   receive errors A-18  
   trans i-frames A-18  
   transmit errors A-18  
   t1 expired A-18  
 links, ASCII host communication 3-87  
 links, ASCII terminal 3-53  
 links, communication hardware B-13  
 local IBM host connection problem 3-5  
 local power control switch 3-11  
 logical path B-15  
 logs menu - test 1 A-5

**M**

maintenance information manual 1-6  
 master menu, display 2-22  
 menu, connection B-16  
 menu, online test A-3  
 menu, 3174 test A-3  
 model descriptions, 3174 1-4  
 models 1L, 1R, 2R, 3R 1-4  
 models 51R, 52R, 53R 1-4  
 models 81R, 82R 1-4  
 modular telephone plug connectors B-22  
 modular telephone plug, 6-pin B-24

## Index

### N

- nonswitched ASCII host fails 3-97
- nonswitched ASCII terminal fails 3-64
- nonswitched line link 3-54, 3-88
- numbers, 3174 adapter hardware group B-2

### O

- obtain physical-connection information 3-16
- obtain problem information 3-16
- offline control unit, relocation 5-8, 5-20
- offline indicator 2-19, 2-21, 3-11
- offline problems 2-21
- offline tests 1-11, 3-108
- offline, force control unit 3-11
- one direct ASCII host fails 3-93
- one direct ASCII terminal fails 3-59
- one nonswitched ASCII host fails 3-97
- one nonswitched ASCII terminal fails 3-64
- one switched ASCII host fails 3-102
- one switched ASCII terminal fails 3-71
- one terminal on TMA fails 3-29
- one terminal on 3299 fails 3-34
- online configuration menu – test 2 A-7
- online log reset – test 4 A-12
- online logs menu – test 1 A-5
- online port test – test 10 A-20
  - TMA/3299 port tests A-21
- online status summary – test 3 A-9
- online terminal check – test 0 A-4
- online test menu A-3
- online test 12 Asynchronous Emulation Adapter A-22
- online tests 1-11, A-2
  - configuration menu A-7
  - display logs A-5
  - online Token-Ring test A-15
  - port tests A-20
  - reset online log A-12
  - status summary A-9
  - terminal check A-4
  - test menu A-3
  - vital online data A-13
- online Token-Ring test – test 9 A-15
- online vital data – test 5 A-13
- online 3174 2-17
- operational 3174 2-17
- operations with diskettes 1-9
- operations, test 3-108
  - continue 3-108
  - free 3-108
- operator panel 2-6
- operator panel not working 3-3
- operator panel problem 3-10
- overview, 3174 connection B-2

### P

- panel not working 3-3
- panel, operator 2-6
- panels, 3174 2-2
- physical and logical paths B-14
- physical-connection information 3-16
- plug connectors, modular telephone B-22
- plug, ASCII adapter wrap B-29
- plug, Token-Ring adapter wrap B-28
- plug, V.21 wrap B-30
- plug, V.35 cable wrap B-29
- plug, V.35 wrap B-29
- plug, 6-pin modular telephone B-24
- plugs, cables, and accessories B-24
- port address, terminal 2-12
- port numbers 2-8
- port online test – test 10 A-20
- port sets B-19
- port test panel A-20
- port type B-19
- ports 2-8
  - power 2-4
    - ac indicator 2-4
    - dc indicator 2-4
    - panel 2-4
    - switch 2-4
  - power cable 2-8
  - power check, 3174 3-7
  - power control IML 2-18
  - Power Control switch 2-5, 2-18, 5-5
    - Local 2-5
    - Remote 2-5
  - power control switch, local 3-11
  - power cord 3-9
  - power indicator, ac 3-9
  - power indicator, dc 2-4, 2-20, 3-7
  - power switch 2-4, 3-11, 5-5
  - problem determination guide 1-6
  - problem determination, 3174 3-1
  - problem information, collect 3-49, 3-83
  - problem solving 1-11
  - problem, ASCII host connection 3-5, 3-83
  - problem, ASCII terminal connection 3-4, 3-49
  - problem, local IBM host connection 3-5
  - problem, operator panel 3-10
  - problem, remote IBM host connection 3-5
  - problem, token-ring connection 3-6
  - problem, 3270 connection 3-4, 3-13
- procedures
  - all connections to ASCII adapter fail 3-57
  - all terminals failing 3-19
  - all terminals on TMA fail 3-21
  - all terminals on 3299 fail 3-23
  - ASCII adapter not respond to incoming call 3-75
  - ASCII adapter not respond to rotary call 3-79
  - directly connected terminal fails 3-38
  - one direct ASCII terminal fail 3-59
  - one nonswitched ASCII terminal fails 3-64

procedures (*continued*)  
 one switched ASCII terminal fails 3-71  
 one terminal on TMA fails 3-29  
 one terminal on 3299 fails 3-34  
 remote host connection fails 3-43  
 pushbutton, advance 2-7  
 pushbutton, alt 1 2-7  
 pushbutton, alt 2 2-7  
 pushbutton, clear 2-7  
 pushbutton, IML 2-6

## R

re-IML 2-17  
 receiving diskettes 2-16  
 red coaxial balun B-27  
 relocate control unit 5-8, 5-20  
 relocation, control unit offline 5-8, 5-20  
 relocation, Token-Ring cable 5-9  
 relocation, 3174 1-7  
 remote host connection fails 3-43  
 remote IBM host connection problem 3-5  
 remove diskette 2-15  
 reset online log – test 4 A-12  
 RPQ diskette 2-13  
 RTM log A-5

## S

sample cabling worksheet 3-14  
 select ASCII terminal symptom 3-56  
 select 3270 terminal symptom 3-18  
 sequence cable 2-5  
 set up control unit 5-1, 5-12  
 sets B-18  
 setup control diskette 5-6  
 setup utility diskette 5-6  
 setup, 3174 1-7  
 shipping diskettes 2-16  
 single coaxial cableless balun B-25  
 stations B-18  
 status code chart 4-4  
 status code description 4-2  
 status code, check 3-3  
 status codes 1-9  
 status codes, Token-Ring A-16  
 status indicators 2-6  
 status summary A-9  
 status summary, gateway host A-19  
 status summary, Token-Ring adapter A-17  
 status test, Token-Ring A-16  
 storage of diskettes 2-16  
 subsystem connection diagram 3-16, 3-52, 3-86  
 subsystem control unit models, 3174 1-2  
 switch, channel interface 2-7, 5-5  
 switch, local power control 3-11  
 switch, power 2-4, 3-11, 5-5  
 switch, power control 2-18, 5-5

switched ASCII host fails 3-102  
 switched ASCII terminal fails 3-71  
 switched line link 3-54, 3-88  
 switches, 3174 2-2  
 symptom undefined 3-3  
 symptom/action chart, ASCII host 3-90  
 symptom/action chart, ASCII terminal 3-56  
 symptom/action chart, 3270 terminal 3-18  
 symptom/action table 3-3  
 symptom/decision chart 3-4  
 symptom, ASCII host 3-90  
 symptom, ASCII terminal 3-56  
 symptom, 3270 terminal 3-18

## T

table, symptom/action 3-3  
 take 3174 offline 2-21  
   problems 2-21  
 telephone plug connectors B-22  
 telephone plug, 6-pin modular B-24  
 telephone rotary link 3-54, 3-88  
 terminal adapter (HG=26) B-2  
 terminal adapter connectors B-22  
 Terminal Adapter port test (online) A-20  
 terminal cable connectors B-21  
 terminal check – test 0 A-4  
 terminal communication links, ASCII 3-53  
 terminal connection problem, ASCII 3-4  
 terminal connection problem, 3270 3-4  
 terminal connection problems 3-3, 3-13  
 terminal connection to 3174 3-52  
 terminal connectors and cables 2-8  
 terminal fails, ASCII direct 3-59  
 terminal fails, ASCII nonswitched 3-64  
 terminal fails, ASCII switched 3-71  
 terminal fails, directly connected 3-38  
 terminal multiplexer adapter (TMA) 1-4, 1-5  
 terminal on TMA fails, one 3-29  
 terminal on 3299 fails, one 3-34  
 terminal port address 2-12  
 terminal problem, ASCII 3-49  
 terminal problems 3-83  
 terminal symptom, ASCII 3-56  
 terminal symptom, 3270 3-18  
 terminals failing, all 3-19  
 terminals on TMA fail, all 3-21  
 terminals on 3299 fail, all 3-23  
 test menu, display online A-3  
 test menu, online A-3  
 test menu, 3174 A-3  
 test mode A-2  
   entering A-2  
   exiting A-2  
 test mode, entering online A-2  
 test mode, exiting online A-2  
 test operations 3-108  
   continue 3-108  
   free 3-108

## Index

- test 0, online terminal check A-4
  - test 1, display online logs A-5
  - test 10, online port test A-20
  - test 10, port wrap test A-20
  - test 12 Asynchronous Emulation Adapter A-22
  - test 2 – customizing menu A-7
    - configuration questions A-7
    - hardware configuration A-7
    - printer authorization matrix A-7
  - test 2, online configuration menu A-7
  - test 3 – status summary A-9
  - test 3 menu A-9
    - attach A-10
    - cable A-10
    - cable max A-11
    - host A-11
    - lu A-11
    - port address A-10
    - status A-10
    - terminal A-10
  - test 3, display online status summary A-9
  - test 4, reset online log A-12
  - test 5, vital online data A-13
  - test 9, online Token-Ring test A-15
  - test 10 – online port test A-20
  - test, adapter 3-110
  - test, cable 3-110
  - test, Token-Ring adapter 3-114
  - test, Token-Ring cable 3-114
  - tests, offline 1-11, 3-108
  - tests, online 1-11
  - TMA (terminal multiplexer adapter) 1-4, 1-5
  - TMA port test A-21
  - TMA/3299 Model 2 port tests (online) A-21
  - token-ring adapter 1-5
  - Token-Ring adapter (HG=31) B-2
  - Token-Ring adapter and cable test 3-114
  - Token-Ring adapter cable 2-8
  - Token-Ring adapter status summary A-17
    - active links A-17
    - adapter address A-17
    - adapter status A-17
    - customized links A-17
  - Token-Ring adapter wrap plug B-28
  - Token-Ring cable relocation 5-9
  - token-ring connection problem 3-6
  - Token-Ring online test – test 9 A-15
  - Token-Ring status codes A-16
  - Token-Ring status test A-16
  - turn control unit on or off 2-4
- ## U
- undefined symptom 3-3
  - user's guide 1-7
  - utility diskette 2-7, 2-13
  - utility diskette, setup 5-6
- ## V
- V.21 wrap plug B-30
  - V.35 cable wrap plug B-29
  - V.35 communication cable and connector 3-110
  - V.35 wrap plug B-29
  - vital data – test 5 A-13
- ## W
- worksheet, cabling 3-14, 3-52, 3-84, 3-86
  - wrap plug, ASCII adapter B-29
  - wrap plug, Token-Ring adapter B-28
  - wrap plug, V.21 B-30
  - wrap plug, V.35 B-29
  - wrap plug, V.35 cable B-29
- ## X
- X.21 communication cable and connector 3-110
- ## Y
- yellow coaxial balun B-26
- ## Numerics
- 25-pin D-shell connector B-28
  - 3174 connection overview B-2
  - 3174 customizing guide 1-6
  - 3174 description 1-4
  - 3174 features 1-4
  - 3174 IML 2-17
  - 3174 model descriptions 1-4
  - 3174 models 1L, 1R, 2R, 3R 1-4
  - 3174 models 51R, 52R, 53R 1-4
  - 3174 models 81R, 82R 1-4
  - 3174 online 2-17
  - 3174 operational 2-17
  - 3174 panels, switches, indicators 2-2
  - 3174 power check 3-7
  - 3174 problem determination 3-1
  - 3174 setup 5-1, 5-12
  - 3174 subsystem control unit model 1-2
  - 3174 test menu A-3
  - 3174 user's guide 1-7
  - 3270 coax-to-twisted pair adapter B-27
  - 3270 DPC-T3 direct attachment accessory cable B-28
  - 3270 gateway feature 1-5
  - 3270 terminal connection problem 3-4
  - 3270 terminal symptom 3-18
  - 3299 model 2 port test A-21

6-pin modular telephone plug B-24





**IBM 3174 Subsystem Control Unit  
Models 1L, 1R, 2R, and 3R  
User's Guide**

**User's  
Comment  
Form**

**Order No. GA23-0337-1**

Your comments will help us improve the quality of this manual. If you answer a question by checking a No , please explain.

Did you find that the information was:

	<b>Yes</b>	<b>No</b>		<b>Yes</b>	<b>No</b>
Useful	<input type="checkbox"/>	<input type="checkbox"/>	Easy to Understand	<input type="checkbox"/>	<input type="checkbox"/>
Accurate	<input type="checkbox"/>	<input type="checkbox"/>	Well-Written	<input type="checkbox"/>	<input type="checkbox"/>
Complete	<input type="checkbox"/>	<input type="checkbox"/>	Well-Illustrated	<input type="checkbox"/>	<input type="checkbox"/>
Easy to Find	<input type="checkbox"/>	<input type="checkbox"/>	Well-Organized	<input type="checkbox"/>	<input type="checkbox"/>
Easy to Read	<input type="checkbox"/>	<input type="checkbox"/>	Flexible (fit your system)	<input type="checkbox"/>	<input type="checkbox"/>

*Brief explanation*

If you had a problem with a procedure, please include the following information with your comments:

Procedure Number \_\_\_\_\_ Page Number \_\_\_\_\_

What was the problem and how did you solve it?

How could the problem be eliminated and, in general, how could the manual be improved?

We appreciate your comments. They will be sent to the author for review and for whatever action is deemed appropriate. IBM may use or distribute whatever information you supply in any way it believes appropriate without incurring any obligation to you. You may, of course, continue to use the information you supply. No postage is necessary if mailed in the U.S.A. (Elsewhere, an IBM office or representative will be happy to forward your comments.)

If you wish a reply, complete the following (please print):

Your Name \_\_\_\_\_ Company Name \_\_\_\_\_ Division \_\_\_\_\_  
Address \_\_\_\_\_ Department \_\_\_\_\_ Telephone \_\_\_\_\_  
City \_\_\_\_\_ State \_\_\_\_\_ Zip Code \_\_\_\_\_

Note: Staples can cause problems with automatic mail-sorting equipment. Please use pressure-sensitive or other gummed tape to seal this form.

Fold and Tape

Please Do Not Staple

Fold and Tape



NO POSTAGE  
NECESSARY  
IF MAILED  
IN THE  
UNITED STATES

**BUSINESS REPLY MAIL**  
FIRST CLASS      PERMIT NO. 40      ARMONK, N.Y.

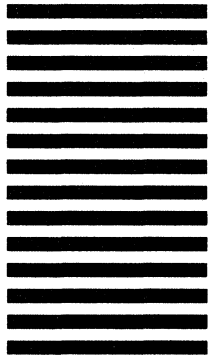

POSTAGE WILL BE PAID BY ADDRESSEE

**International Business Machines Corporation**  
**Dept. E02**  
**P.O. Box 12195**  
**Research Triangle Park, N.C. 27709-9990**

Fold and Tape

Please Do Not Staple

Fold and Tape

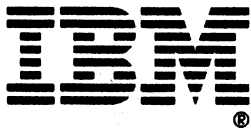



Printed in U.S.A.  
File No. 36/38/370/4300/8100/3174-09

GA23-0337-01

