

IBM 3197 Model D Display Station Setup Instructions

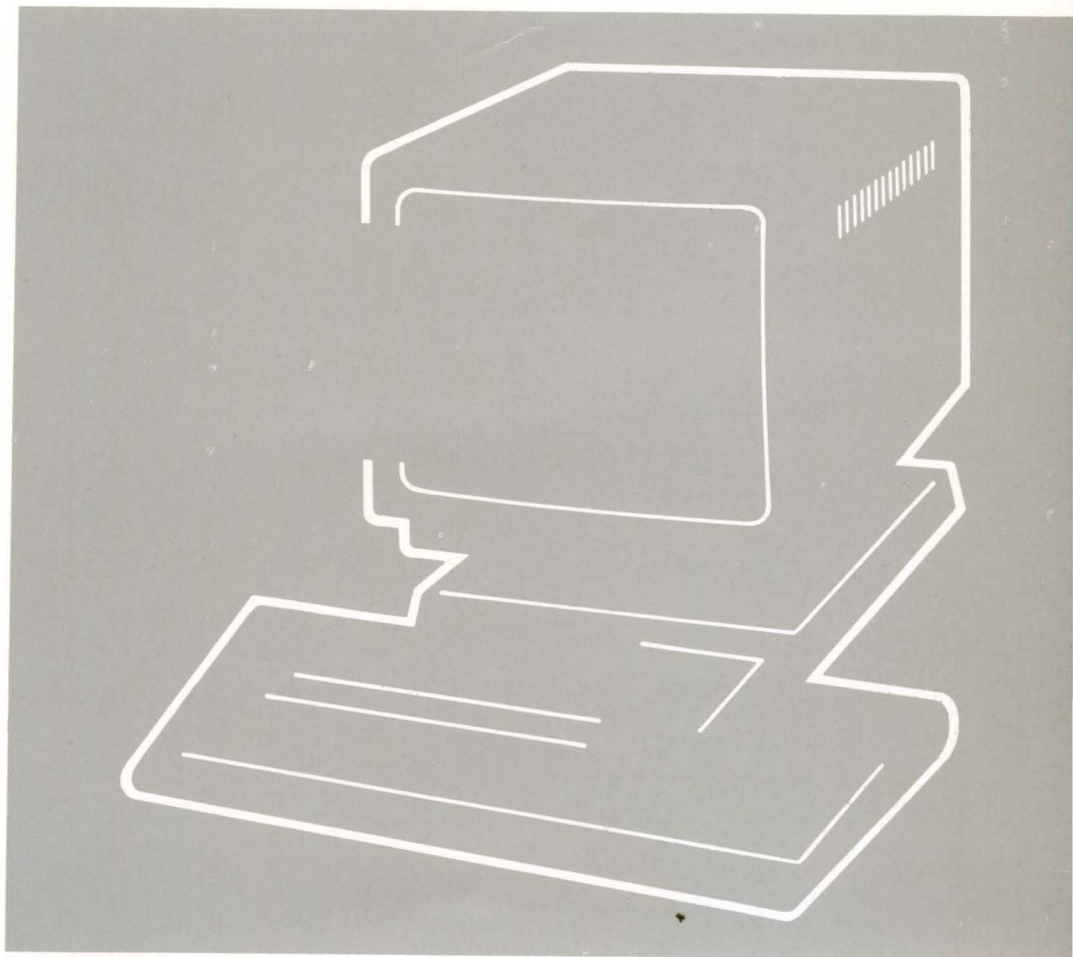

IBM

GA18-2546-1
Part Number 81X5370
File Number S5250/S36/S38-06

IBM 3197 Model D Display Station Setup Instructions

Federal Communications Commission (FCC) Statement

Warning: This equipment generates, uses, and can radiate radio frequency energy and if not installed and used in accordance with the instruction manual, may cause interference to radio communications. It has been tested and found to comply with the limits for a Class A computing device pursuant to Subpart J of Part 15 of FCC Rules, which are designed to provide reasonable protection against such interference when operated in a commercial environment. Operation of this equipment in a residential area is likely to cause interference in which case the user at his own expense will be required to take whatever measures may be required to correct the interference.

The above FCC statement applies only to those machines used in the U.S.

Second Edition (April 1987)

This major revision replaces GA18-2546-0. Changes are made occasionally to the information herein; any such changes will be reported in subsequent revisions.

Reference in this publication to IBM products, programs, or services does not imply that IBM intends to make these available in all countries in which IBM operates. Any reference to an IBM program product in this publication is not intended to state or imply that only IBM's program product may be used. Any functionally equivalent program may be used instead.

Publications are not stocked at the address given below. Requests for IBM publications should be made to your IBM representative or to the IBM branch office serving your locality.

A form for readers' comments is provided at the back of this publication. If the form has been removed, comments may be addressed to IBM Corporation, Publications Development, Department 6R1J, 180 Kost Road, Mechanicsburg, PA 17055 U.S.A. IBM may use or distribute whatever information you supply in any way it believes appropriate without incurring any obligation to you.

Contents

Section 1. Inventorying the Items Received	1
Section 2. Setting Up the Display Station	5
Section 3. Adjusting the Display Station (122-key Typewriter Keyboard)	19
Section 4. Selecting Your Keyboard ID and Character Set (122-key Typewriter Keyboard)	25
Section 5. Selecting Your Terminal Mode (122-key Typewriter Keyboard)	29
Section 6. Adjusting the Display Station (IBM Enhanced Keyboard)	47
Section 7. Selecting Your Keyboard ID and Character Set (IBM Enhanced Keyboard)	53
Section 8. Selecting Your Terminal Mode (IBM Enhanced Keyboard)	57
Section 9. Connecting to a Host System or a Controller	73
Appendix A. Location of Terminator Switches	83

SAFETY PRECAUTION

An improperly wired outlet or plug can place hazardous voltages on accessible metal parts of this display station. The power cord and plug (when supplied) on your display station have been approved for use with this display station and meet the necessary testing laboratory/test house standards. For your safety, the power cord and plug must be connected to a properly wired and grounded outlet. The customer is responsible for the outlet and plug wiring.

If it becomes necessary to change power cord or plug or if the outlet is improperly wired, have the change made by a qualified electrician according to local or national code. A new power cord may be ordered from your IBM sales representative.

Section 1. Inventorying the Items Received

No tools are necessary for setting up your display station.

If you have any problems in setting up the IBM 3197 Model D Display Station, see the *IBM 3197 Model D Display Station Problem Solving Guide, GA18-2547*.

Check each box () as you unpack and identify each item shown on the next page.
If any are missing, call your IBM marketing representative.

Video Element

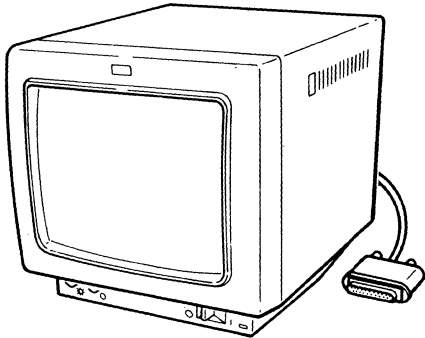

Video Stand

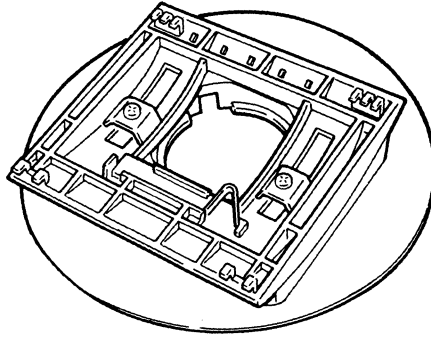

Keyboard

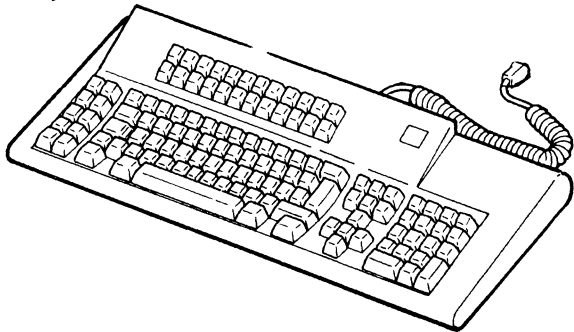

122-key Typewriter Keyboard

Keyboard Overlay

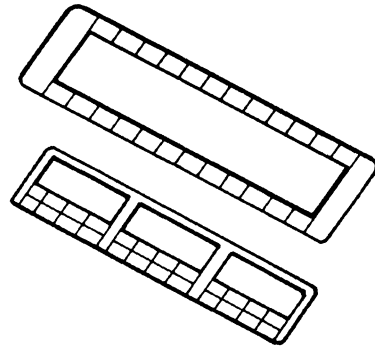

OR

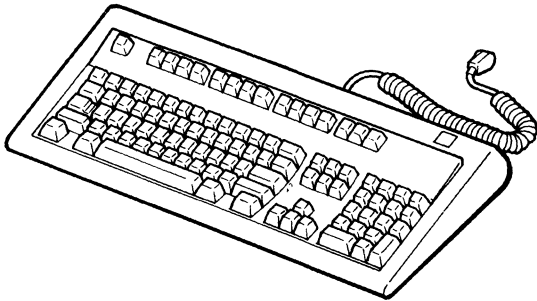

IBM Enhanced Keyboard

Logic Element

Security Keys
(Inserted in the logic element)

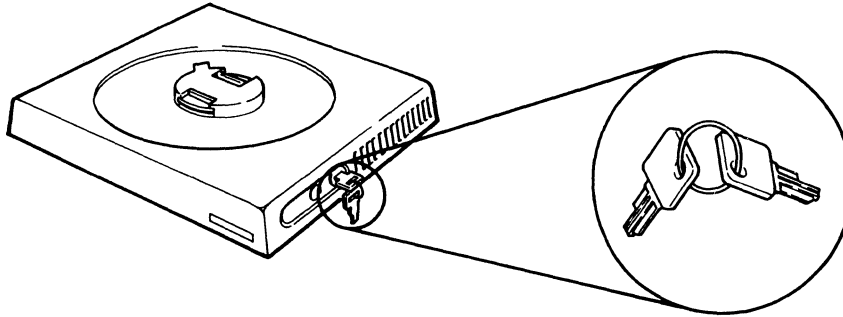

Power Cord

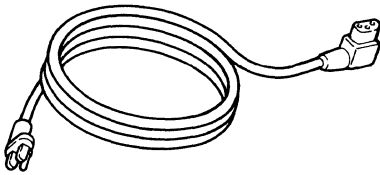

Notice for Customers in Chicago, Illinois:
Two, different-length power cords are shipped with the IBM 3197 Model D; 1.8 m (6 ft) and 2.8 m (9 ft). Do not use the 2.8 m (6 ft) power cord; use the 1.8 m (6 ft) power cord.

IBM 3197 Model D
Display Station
User's Guide,
GA18-2545

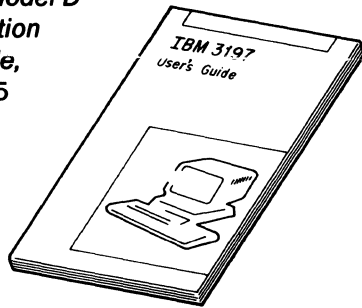

Auto Termination Unit

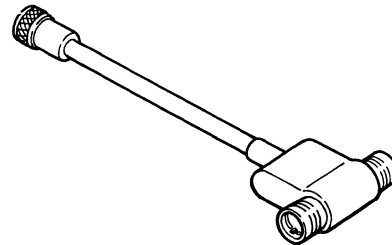

IBM 3197 Model D
Display Station
Problem Solving Guide,
GA18-2547

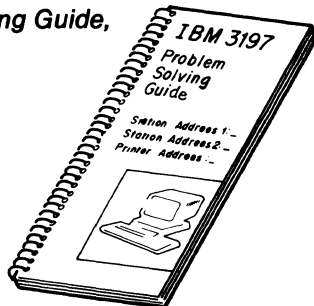

IBM 3197 Model D
Display Station
Setup Instructions,
GA18-2546

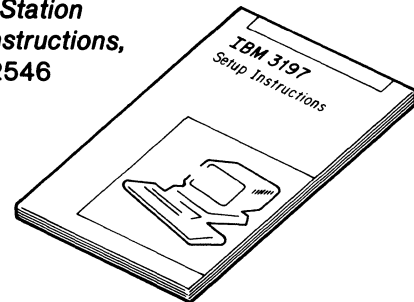

Notes:

1. Save all packaging material for later use if service is required.
2. Record the security key identification number in case the keys are lost and replacement is needed.
3. Store one of the security keys in a safe place.

Section 2. Setting Up the Display Station

Be sure the installation requirements of the *IBM 3197 Display Station Description, GA18-2544*, and the *IBM 5250 Information Display System Planning and Site Planning Guide, GA21-9337*, have been met prior to setting up your display station.

2.1 ATTACHING THE REPAIR IDENTIFICATION (RID) TAGS TO YOUR VIDEO ELEMENT, LOGIC ELEMENT, AND KEYBOARD ELEMENT.

Note: IBM uses the RID tags to determine the maintenance status of your display station. Without these tags, service may be delayed or unobtainable.

2.1.1 Turn the logic element upside down.

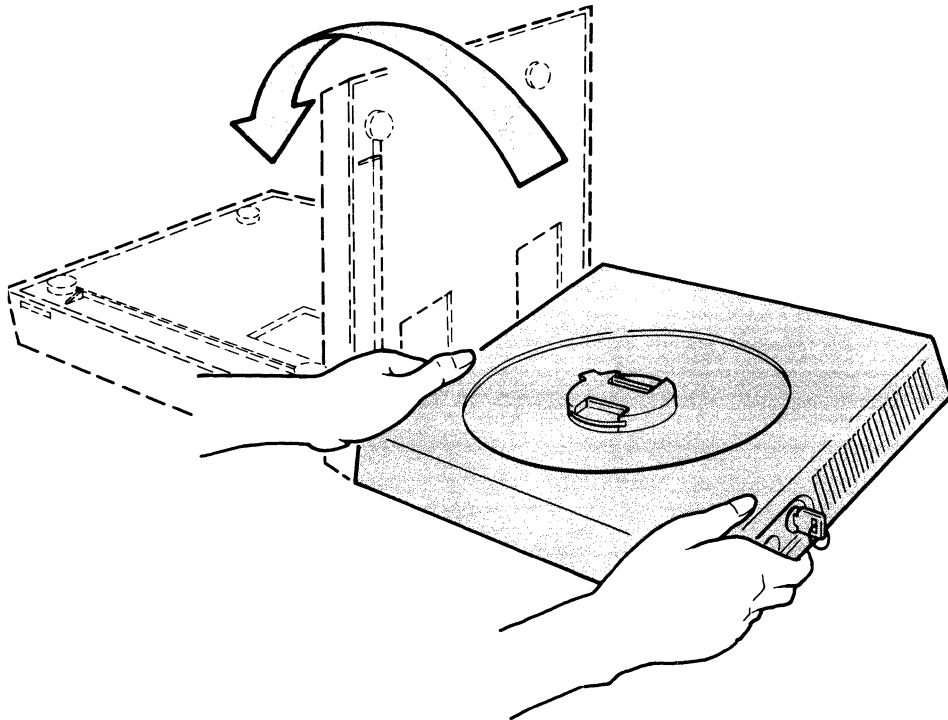

2.1.2 Remove the RID tags from the underside of the logic element.

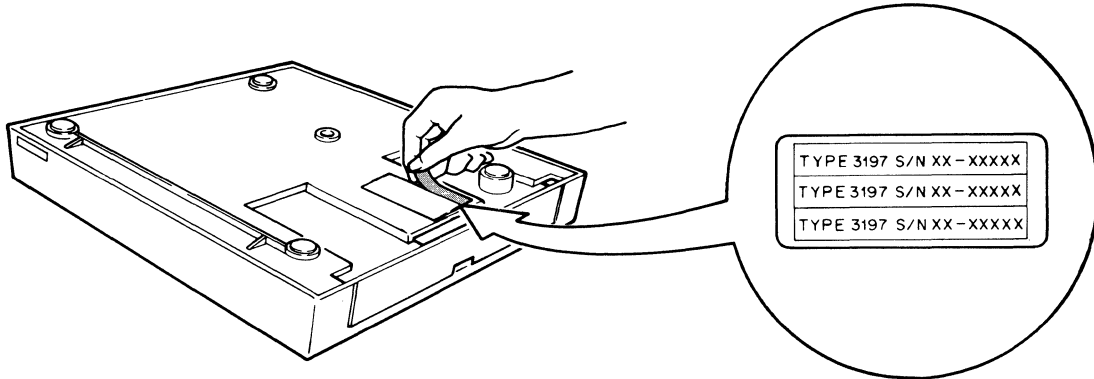

Note: The tags and their location may not appear exactly as shown.

2.1.3 Peel off the RID tags and place one on each of the elements in the locations shown below.

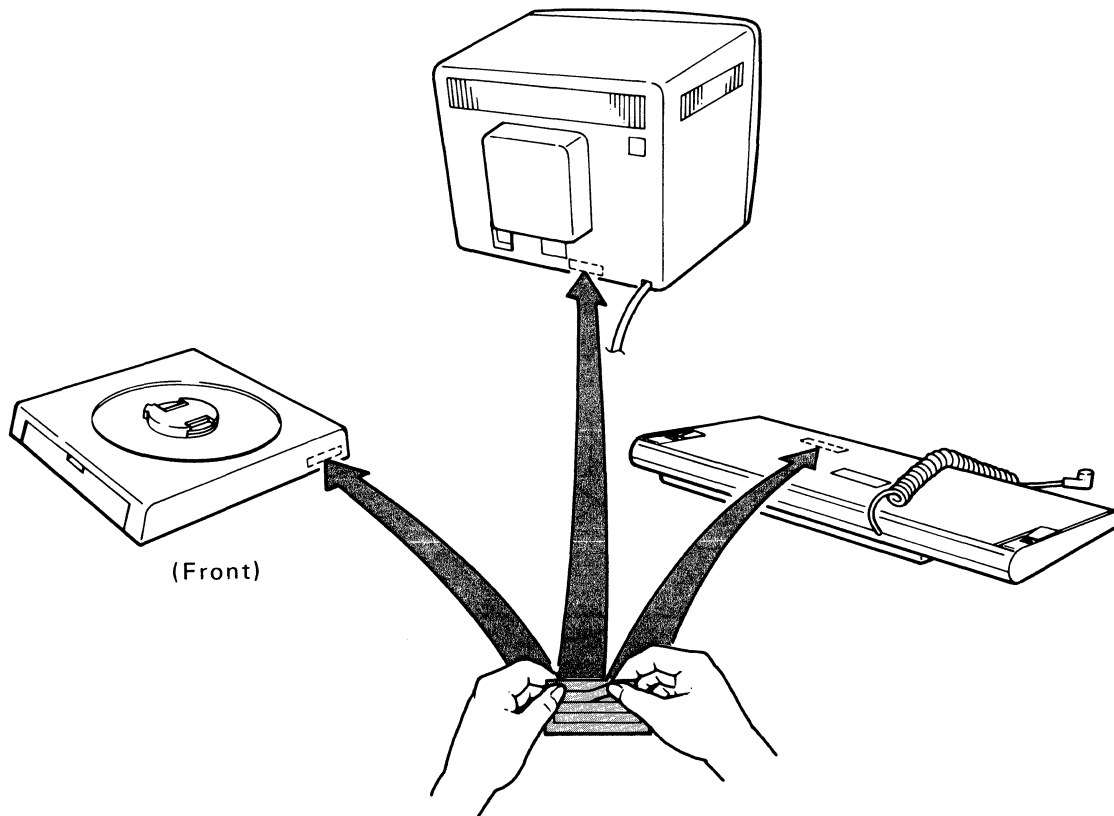

2.2 ATTACHING THE VIDEO STAND TO THE LOGIC ELEMENT.

2.2.1 Place the circular portion of the video stand in the circular recess on top of the logic element, and align the notch and tab.

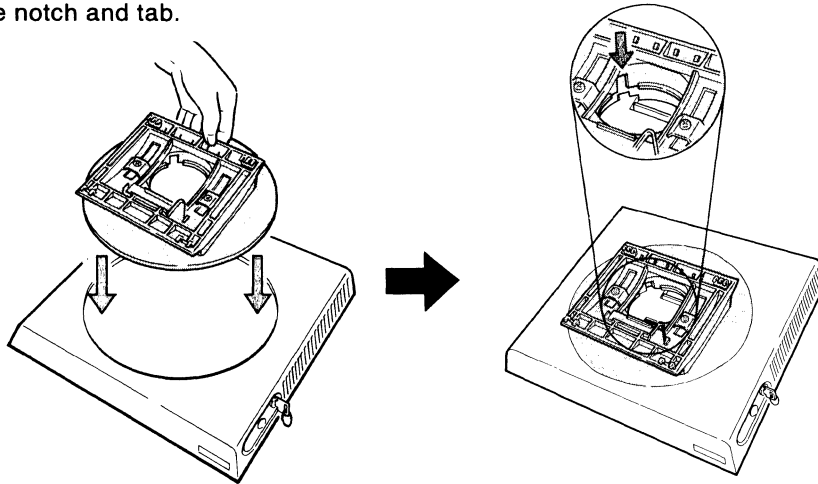

2.2.2 Pinch in the two latches; then release them to lock the video stand into the logic element.

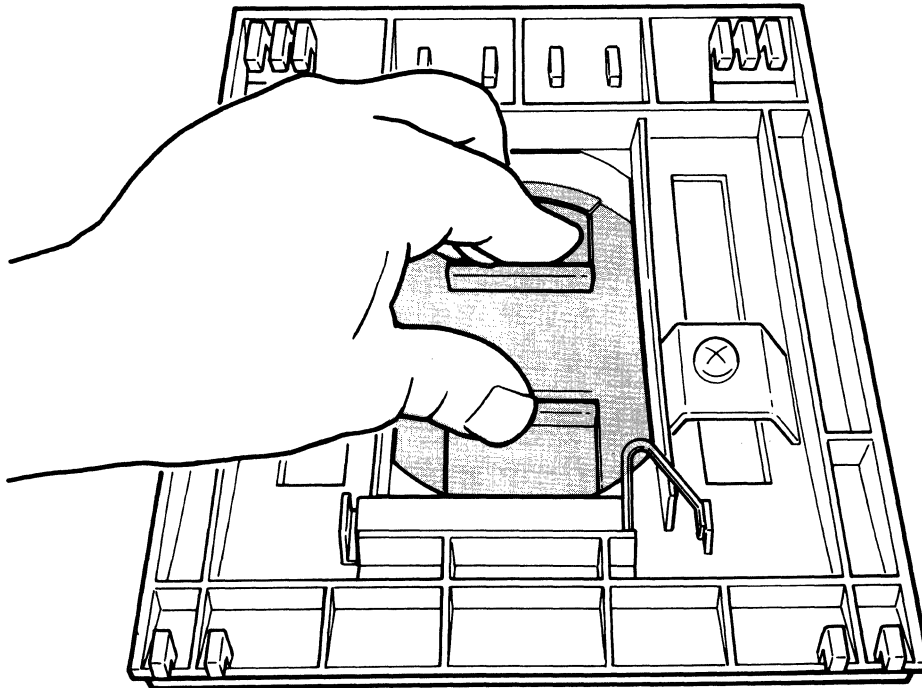

2.2.3 Check the video stand to make sure it is tightly latched onto the logic element.

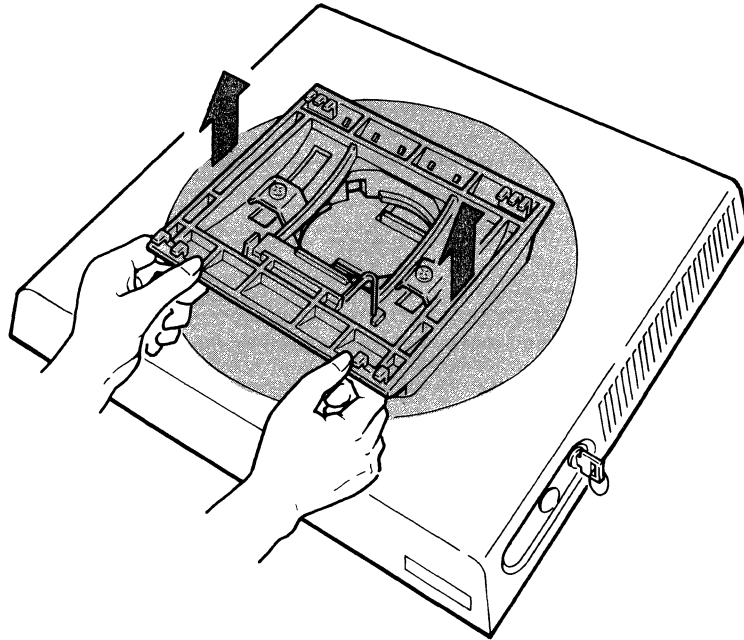

2.3 ATTACHING THE LOGIC ELEMENT TO THE VIDEO ELEMENT.

2.3.1 Move the video element toward you and then turn it upside down.

Note: Make sure the video screen faces you.

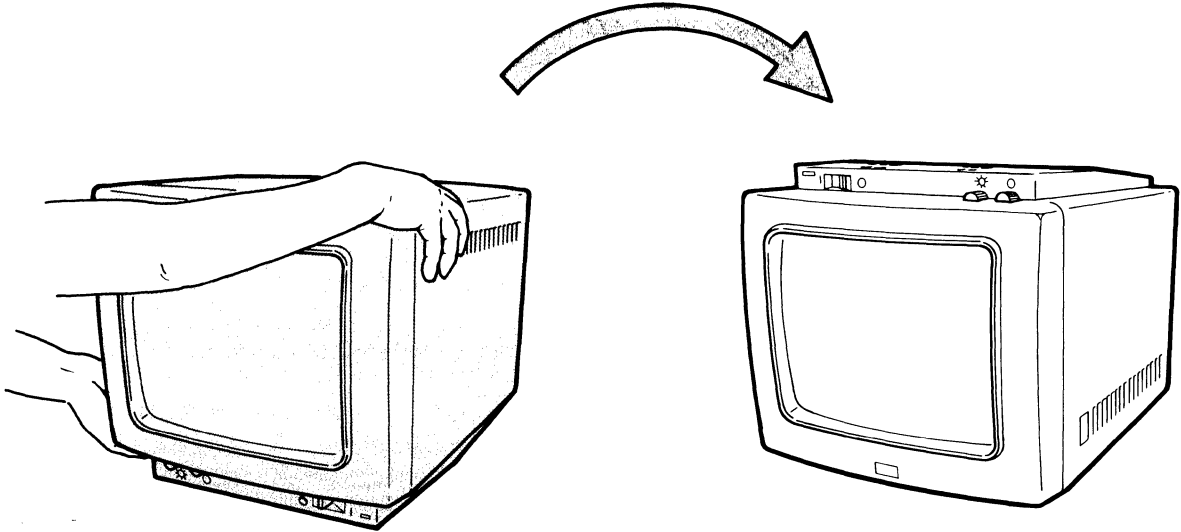

2.3.2 Locate the ten slots on the bottom of the video element.

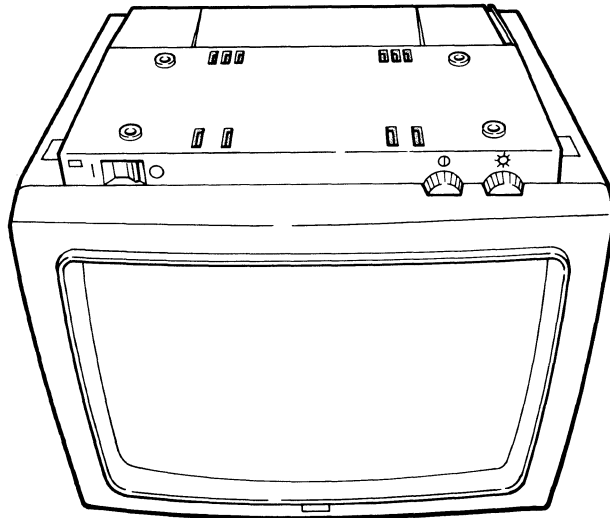

2.3.3 Locate the ten hooks on the top of the video stand.

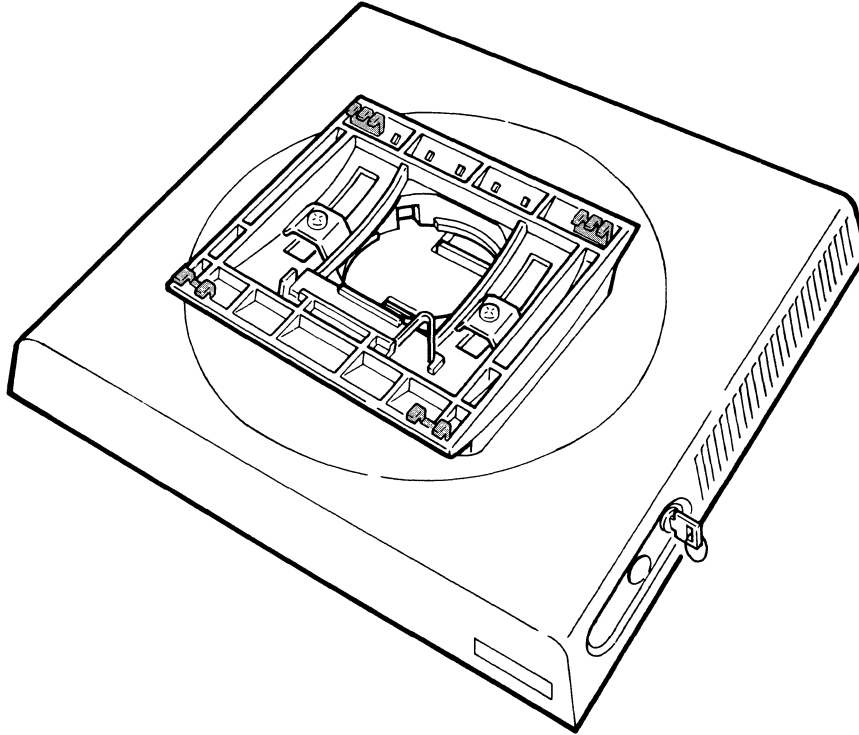

2.3.4 Insert the ten hooks on the video stand into the ten slots on the video element.

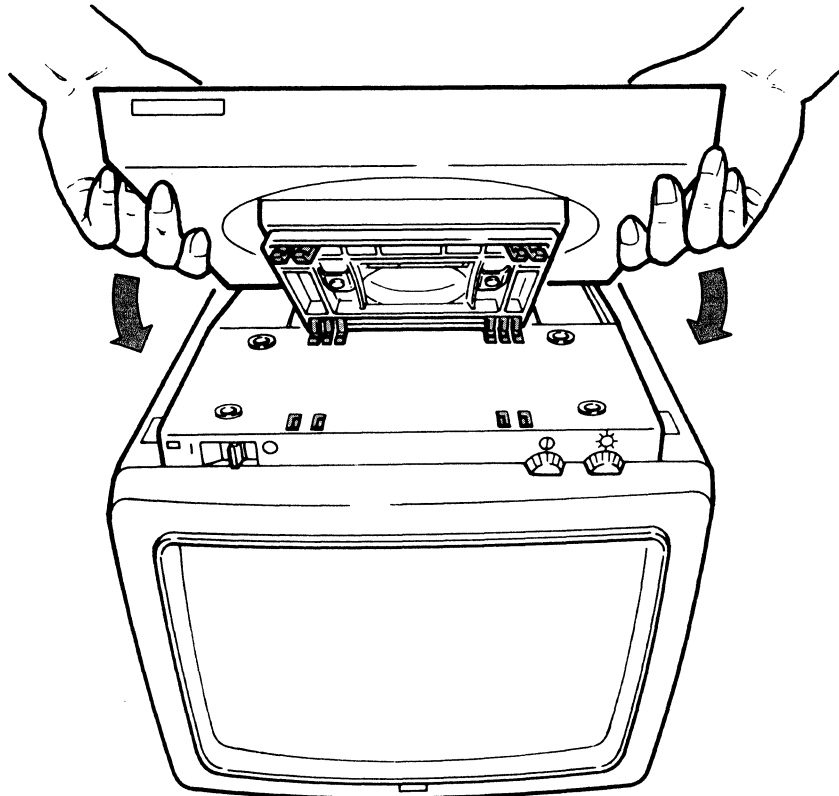

-
- 2.3.5** Hold the front side of the video element, and push the logic element forward (in the same direction the screen faces) until the video stand snaps into place.

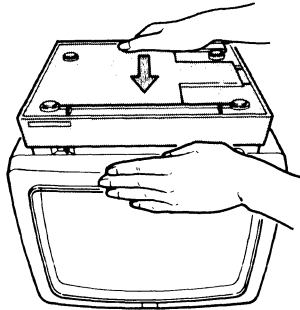

-
- 2.3.6** Make sure the video stand is locked in place by trying to move the logic element forward and backward.

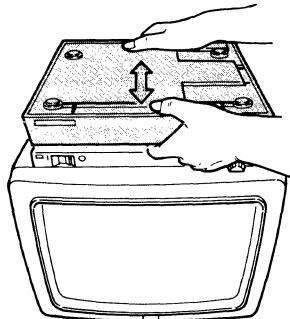

-
- 2.3.7** Move the video element assembly toward you and then turn it right side up.

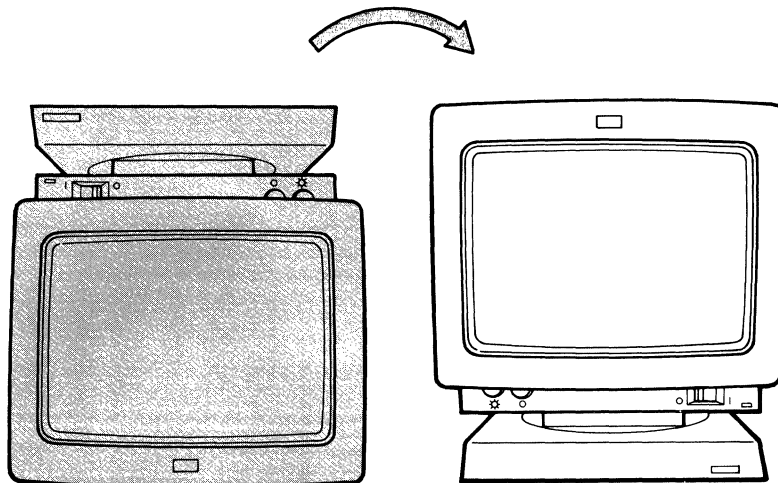

2.4 CONNECTING THE VIDEO AND KEYBOARD CABLES.

2.4.1 Insert the plug on the video cable into the socket on the logic element, then tighten the screws.

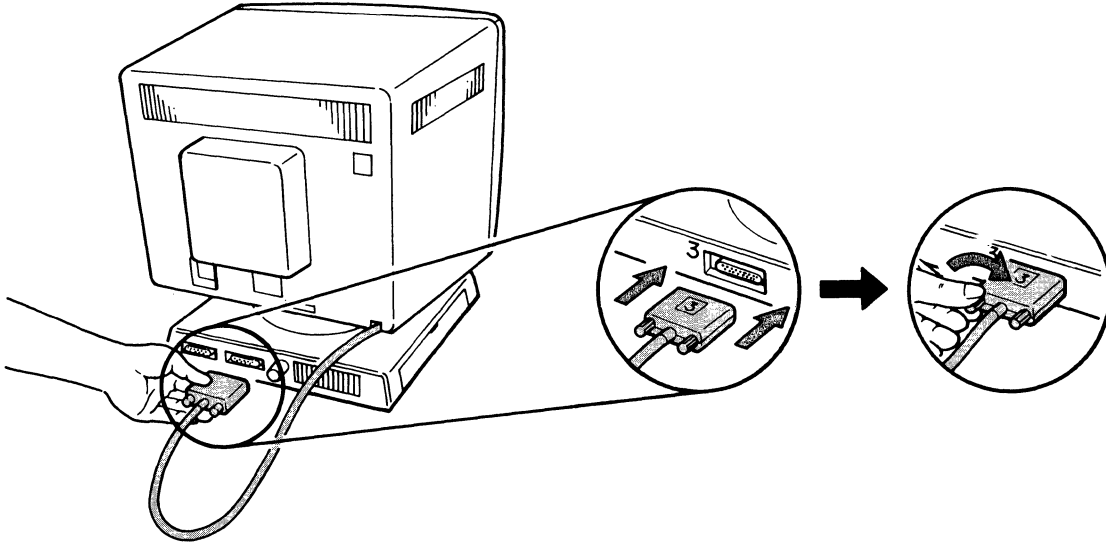

2.4.2 Remove the cap from the keyboard cable plug (if present), hold the plug so that the IBM logo is facing up, then insert the plug into the socket on the side of the logic element.

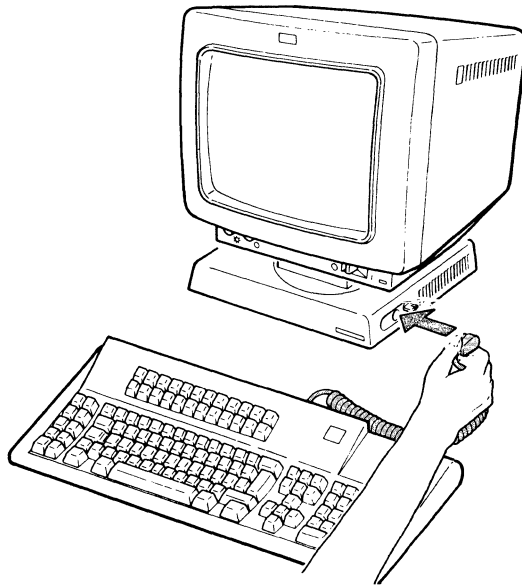

Note: Your keyboard may be different in appearance from the one shown.

2.5 PREPARING THE DISPLAY STATION FOR POWER-ON.

2.5.1 Make sure that the power switch is set to O (off).

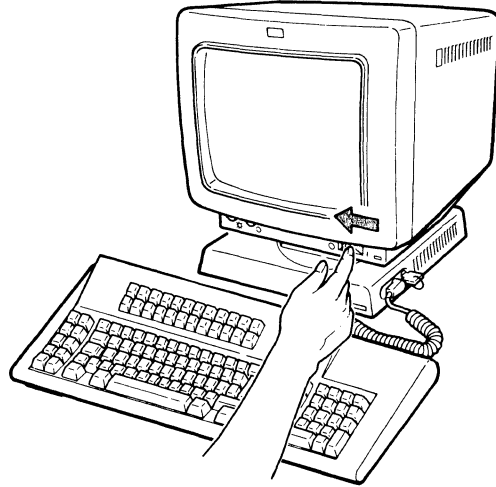

2.5.2 Insert the power cord plug into the power socket on the rear of the video element.

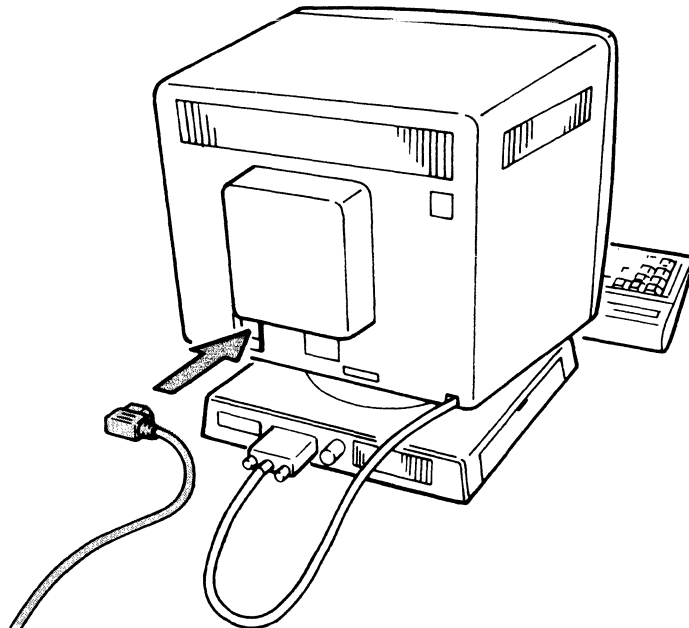

SAFETY PRECAUTION

An improperly wired outlet or plug can place hazardous voltages on accessible metal parts of this display station. The power cord and plug (when supplied) on your display station have been approved for use with this display station and meet the necessary testing laboratory/test house standards. For your safety, the power cord and plug must be connected to a properly wired and grounded outlet. The customer is responsible for the outlet and plug wiring.

If it becomes necessary to change power cord or plug or if the outlet is improperly wired, have the change made according to local or national code. A new power cord may be ordered from your IBM sales representative.

2.5.3 Plug the power cord into a grounded electrical outlet.

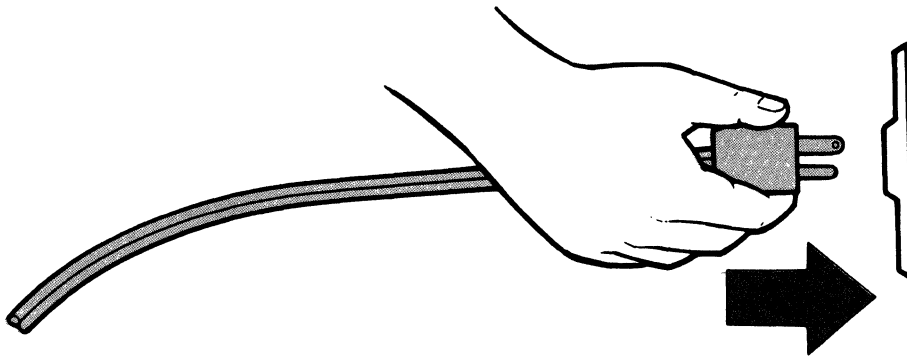

2.5.4 Make sure the security key is inserted in the keylock and turned clockwise.

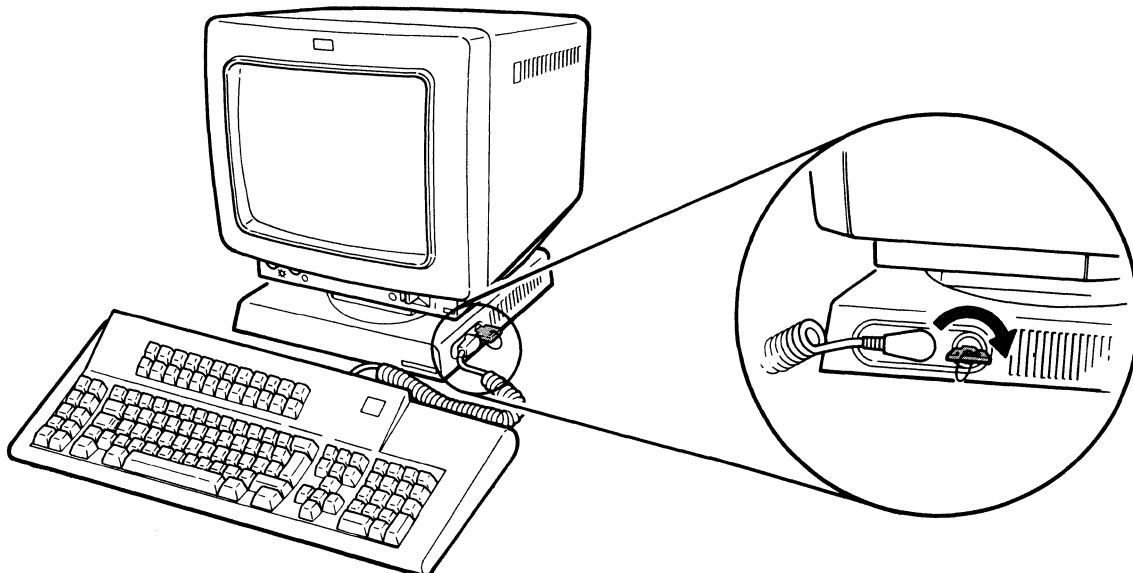



IMPORTANT !

The keyboard operations are different, depending on the keyboard type.

Determine which keyboard type you are using. If your keyboard is:

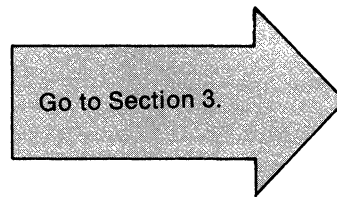
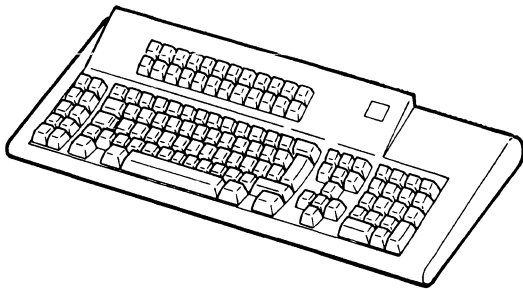

Page 17

(122-key Typewriter Keyboard)

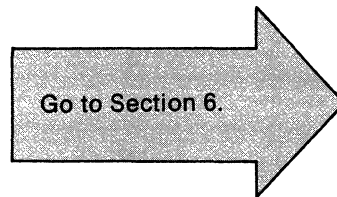
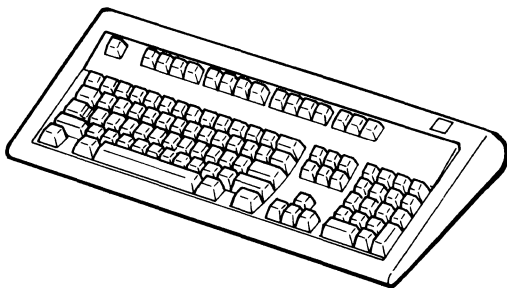

Page 45

(IBM Enhanced Keyboard)

If your keyboard looks like the one shown below,

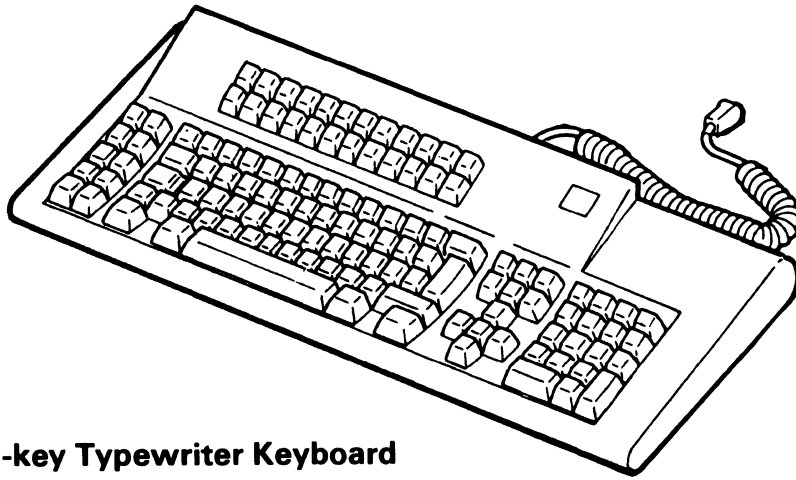

122-key Typewriter Keyboard

CUT AND OPEN THIS PACKAGE WITH A LETTER KNIFE AT THE PERFORATION AS SHOWN BELOW.



3.1.2 Adjust the screen brightness to a comfortable viewing level.

To increase the screen brightness, turn the brightness control clockwise.

To decrease the screen brightness, turn the brightness control counterclockwise.

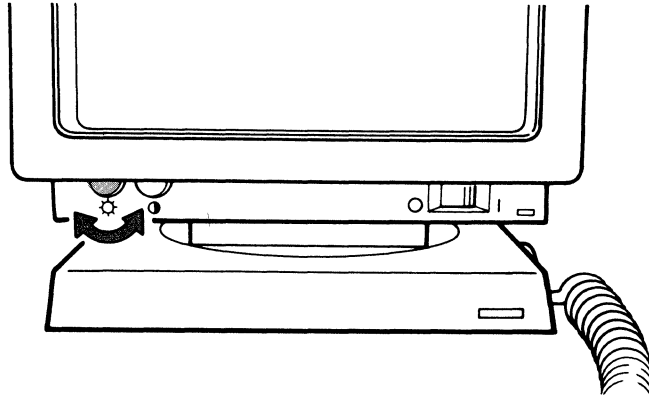

3.1.3 Adjust the screen contrast to a comfortable viewing level.

To increase the screen contrast, turn the contrast control clockwise.

To decrease the screen contrast, turn the contrast control counterclockwise.

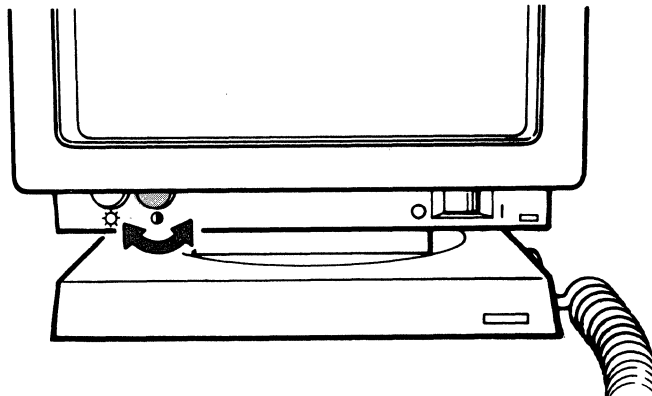

3.1.4 Set the power switch to O (off).

3.2 ADJUSTING THE KEYBOARD SLOPE AND THE VIDEO VIEWING POSITIONS.

3.2.1 Turn the keyboard upside down and flip the legs up from the underside of the keyboard.

- With the keyboard legs down, the slope is 12 degrees.
- With the legs locked on the underside of the keyboard, the slope is 6 degrees.

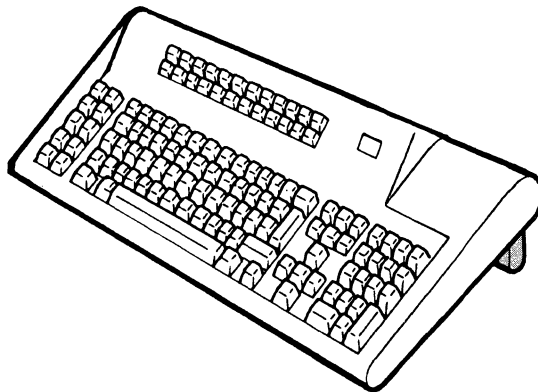
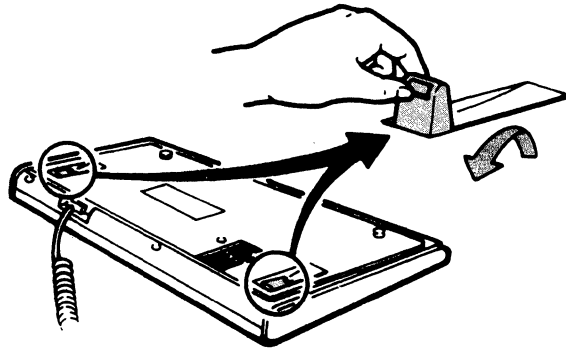
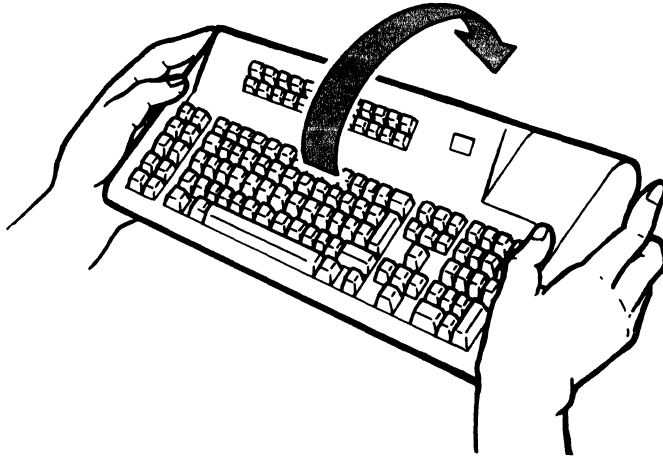

3.2.2 Adjust the video element to the desired viewing position.

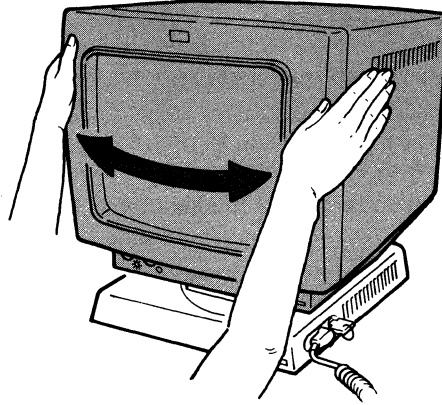

To rotate the video element, place your hands on both sides of the video element near the front edge and turn it left or right.

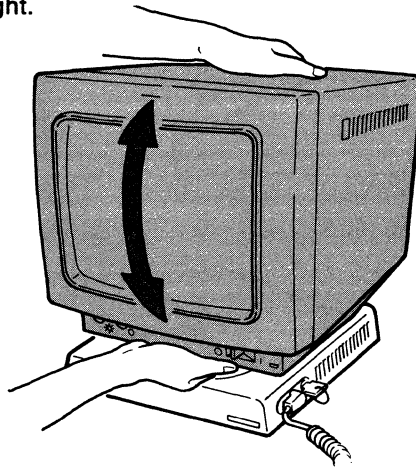

To tilt the video element, place your hands on the upper back edge and front edge of the video element as shown above and move it to the desired position.

3.2.3 Place the keyboard overlay (for setup operation) on your keyboard.

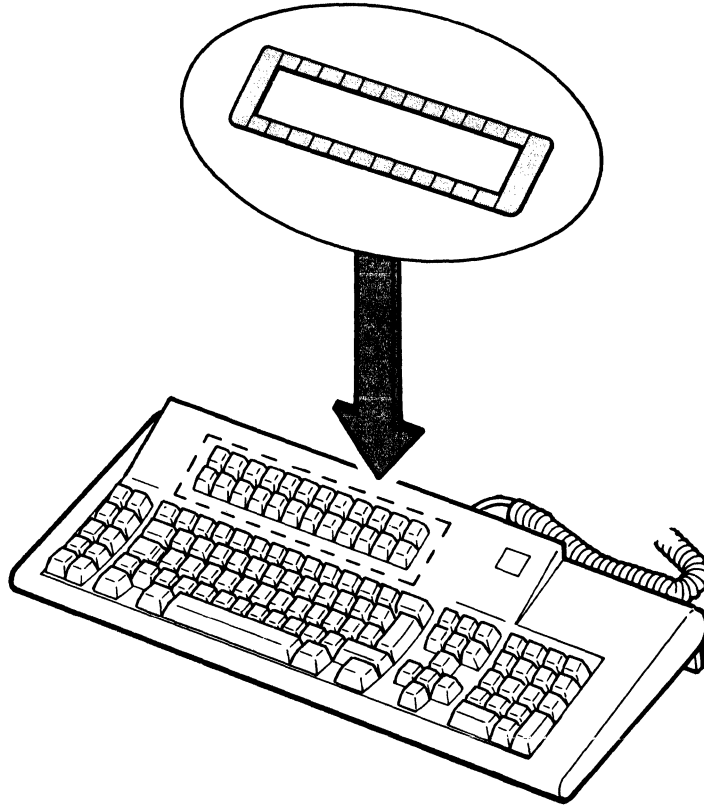

Go to Section 4.

4.1.2. Press the SetUp key.

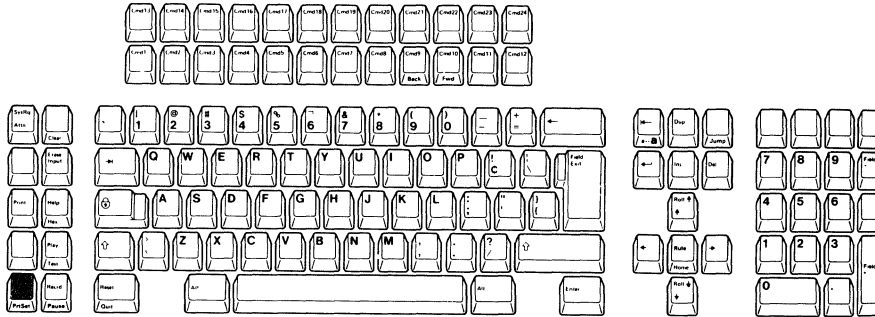

A diamond appears at the bottom of the display screen.

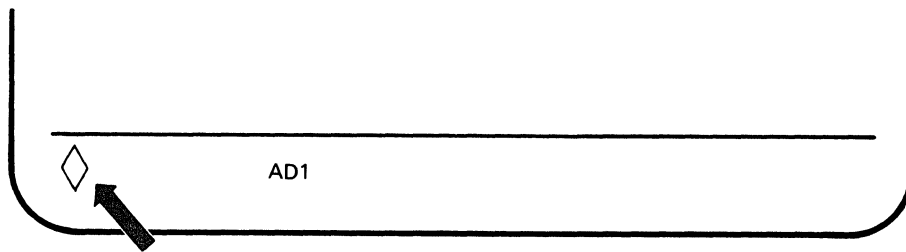

4.1.3 Make sure that the keyboard ID displayed at the bottom of your display is a "--".

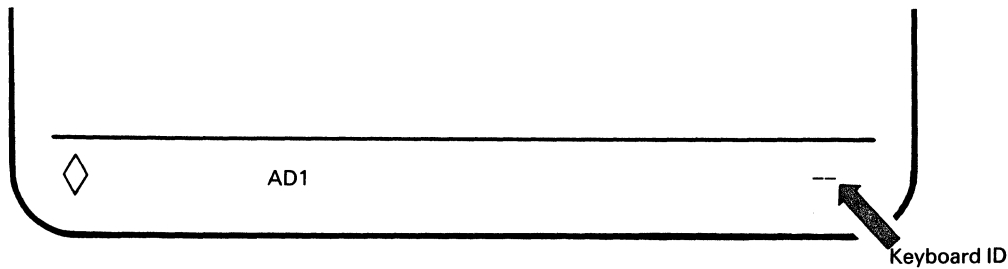

If the displayed keyboard ID is 00 through 63, press and hold the Keyboard ID (Cmd 22) key until a "--" appears. A "--" immediately follows the number 63 when the Keyboard ID key is pressed.

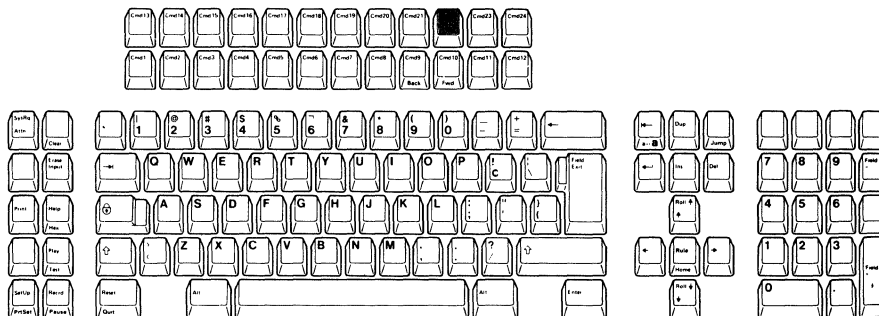

4.2. SELECTING YOUR CHARACTER SET.

- 4.2.1 Obtain a copy of the Setup Work Sheet that is attached to the back of the IBM 3197 Description (GA18-2544) from your supervisor.

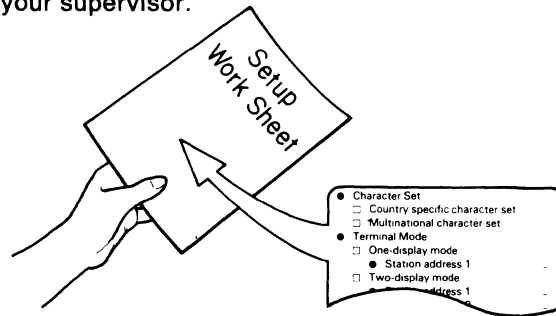

-
- 4.2.2 Check the selection of the Character Set on the Setup Work Sheet.

If the character set you need is country-specific, skip this step and go to step 4.3.
If the character set is multinational, go to step 4.2.3.

- 4.2.3 Press the Cmd 21 key.

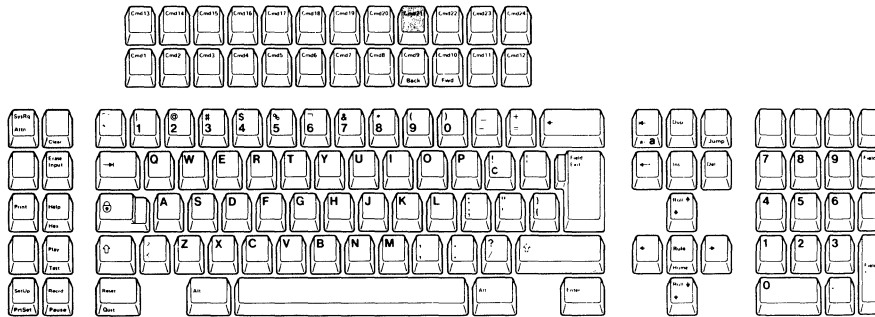

An "M" appears on the operating status line.

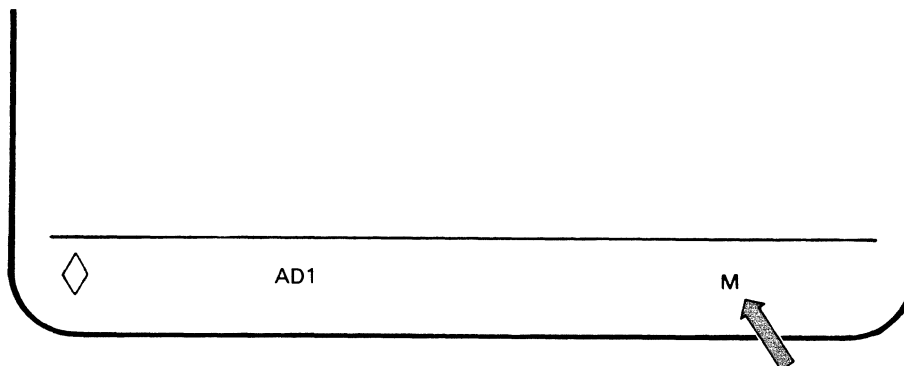

4.3. SAVE THE KEYBOARD ID AND THE CHARACTER SET

4.3.1. Press the SetUp key to end the selections.

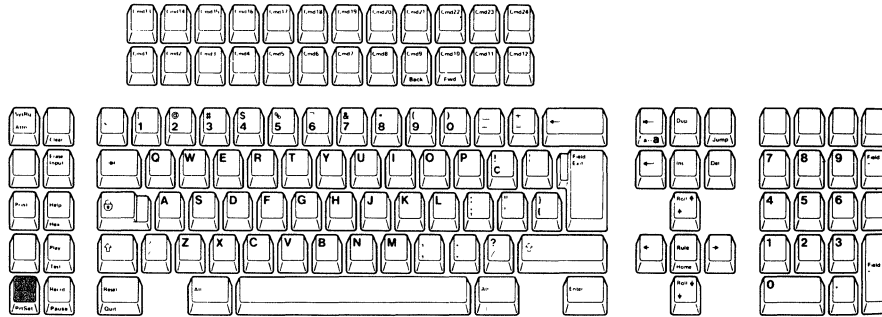

The keyboard ID and the character set are now set and remain the same until you change them.

Go to Section 5.

Section 5. Selecting Your Terminal Mode (122-key Typewriter Keyboard)

YOUR DISPLAY STATION CAN BE OPERATED IN EITHER ONE OF THE FOLLOWING TERMINAL MODES:

- One-Display Mode:** Works as an ordinary display station.
 - Two-Display Mode:** Works as two separate display stations.
 - Display-Printer Mode:** Works as two workstations: one display station and one printer. The printer attached to your display station is controlled by the host system.
-

5.1 SELECTING AN APPROPRIATE TERMINAL MODE.

5.1.1 Check the Setup Work Sheet to find which terminal mode is to be selected. Then record the addresses on the front cover of the *IBM 3197 Model D Problem Solving Guide*.

Note: Each workstation address (for the display station and printer) must be different from the other workstations on this string.

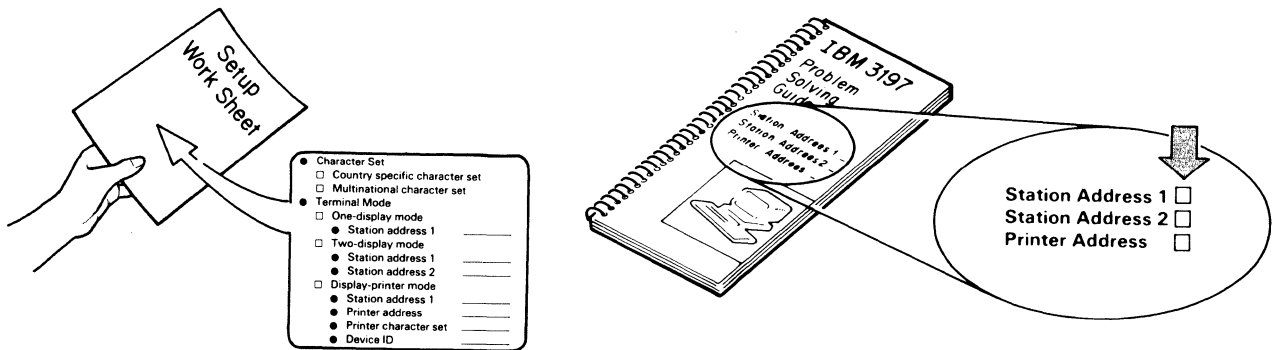

5.1.2 Press the Setup key.

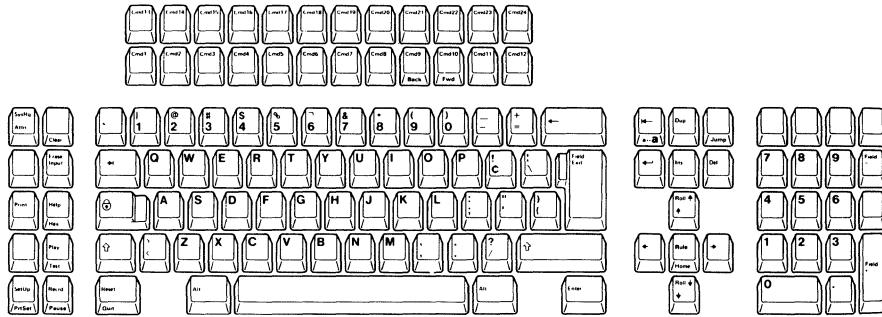

A diamond appears at the bottom of the display screen.

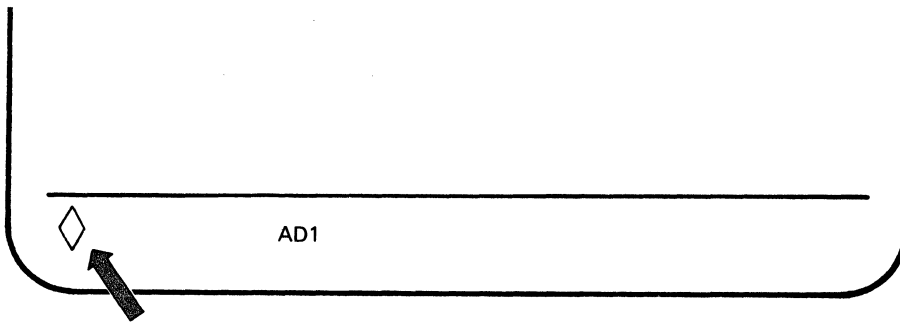

5.1.3 Observe on the operating status line the indication of the current terminal mode.

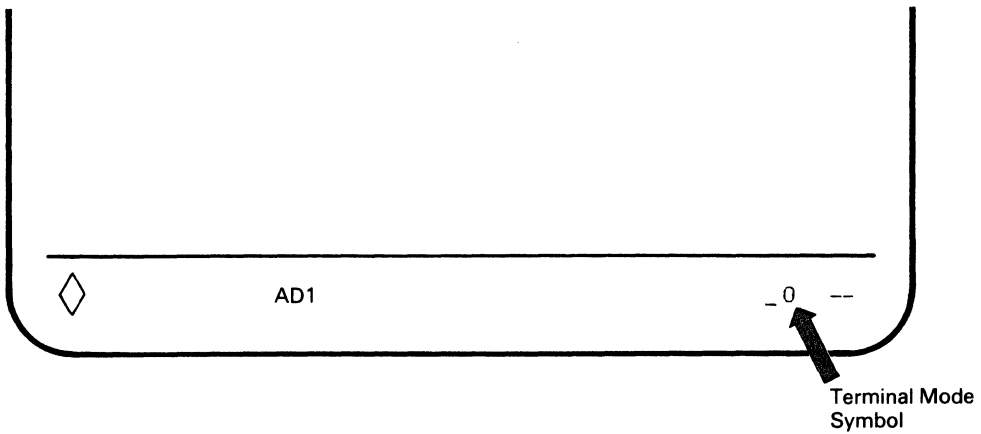

5.1.4 If your terminal mode described in the Setup Work Sheet is:

- **One-Display Mode** ➡ Go to step 5.2.
- **Two-Display Mode** ➡ Go to step 5.3.
- **Display-Printer Mode** ➡ Go to step 5.4.

5.2 **SELECT ONE DISPLAY MODE.**

5.2.1 Make sure that the indication of the terminal mode is "0".

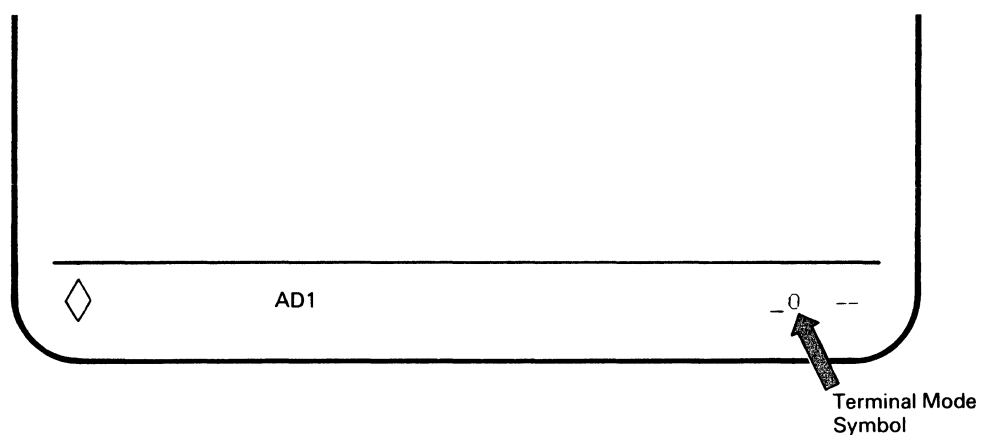

5.2.2 Press and hold the Set Address 1 (Cmd 23) key until the Station Address 1 (a number 0 through 6) that you previously recorded on the front of your IBM 3197 Problem Solving Guide, appears.

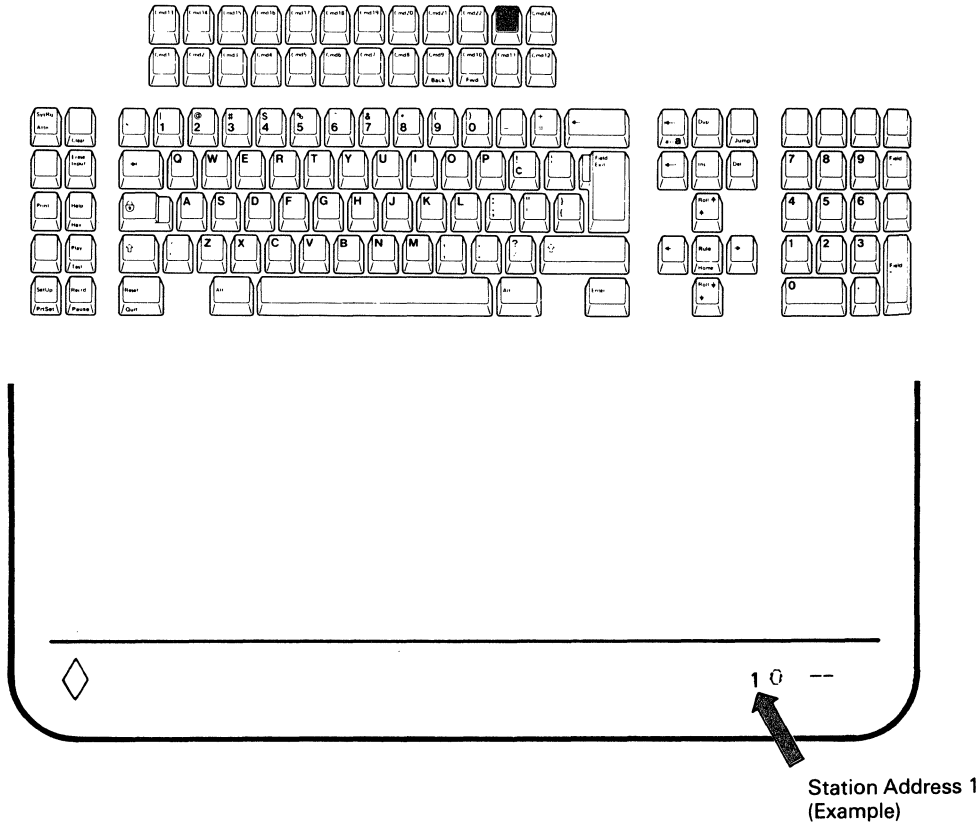

5.2.3 Press the SetUp Key.

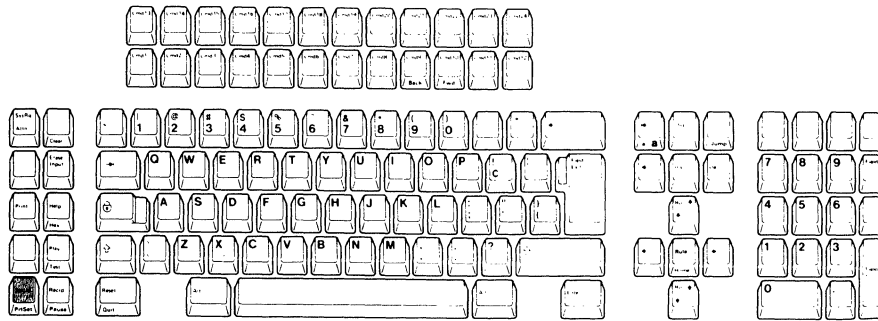

Display Station Address 1 is now set and remains the same until you change it.

5.2.4. Open the document pocket door located at the left side of the logic element and put the IBM 3197 Problem Solving Guide in the compartment. Then close the door.

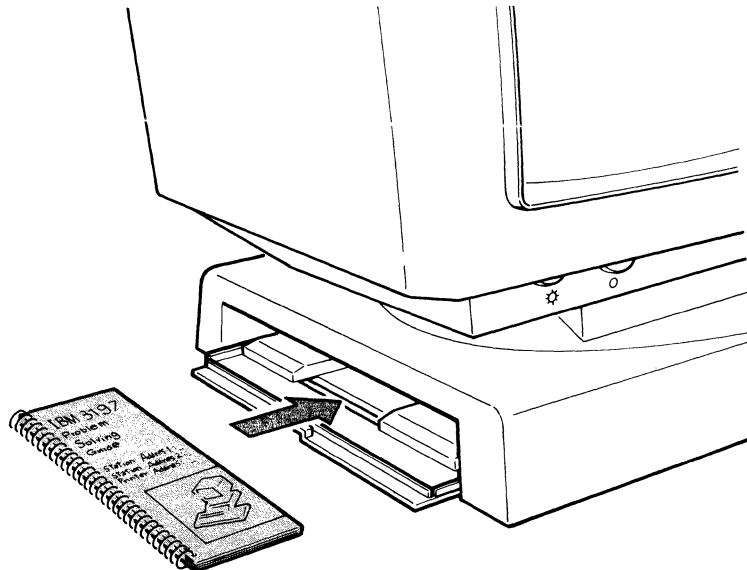

Go to Section 9 on page 73. Connecting to a Host System or a Controller.

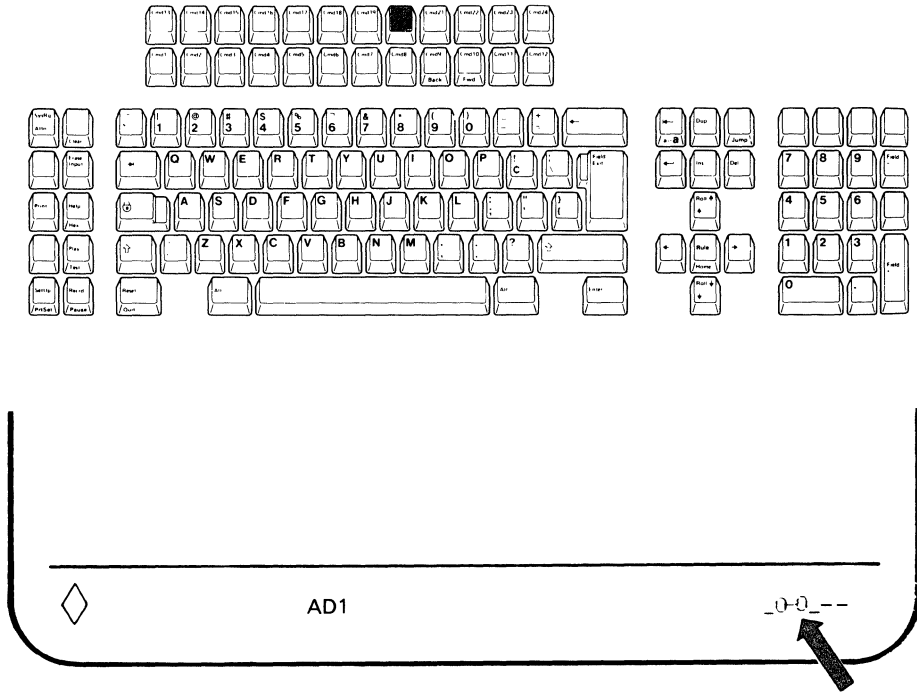

5.3 SELECT TWO-DISPLAY MODE.

5.3.1 Press and release the Terminal Mode (Cmd 20) key until “0-0” appears at the left of the Keyboard ID symbol “--”.

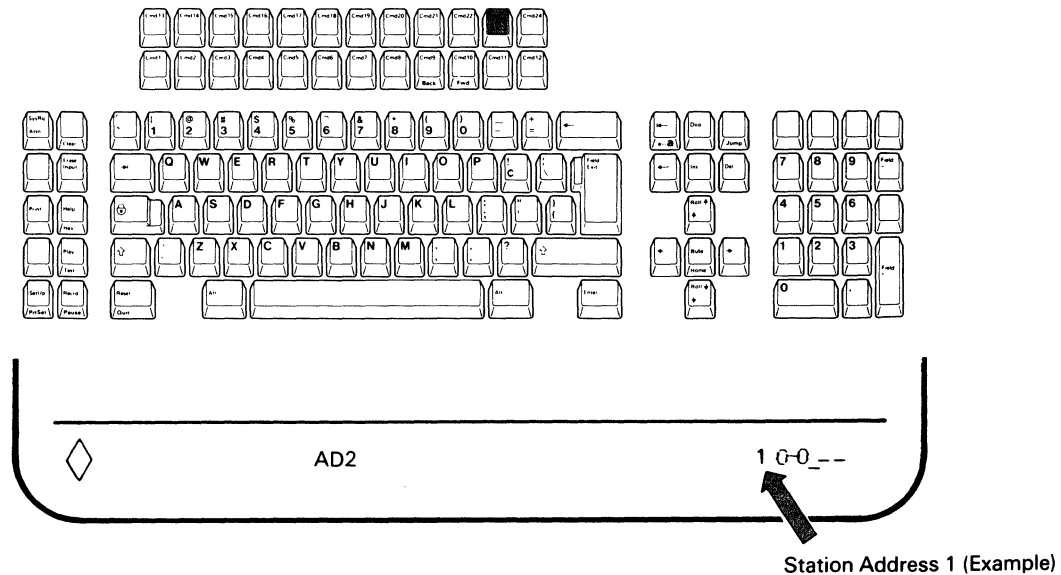

5.3.2 Press and hold the Set Address 1 (Cmd 23) key until the Station Address 1 (a number 0 through 6) that you previously recorded on the front of your IBM 3197 Problem Solving Guide appears and then release the Cmd 23 key.



5.3.3 Press and hold the Set Address 2 (Cmd 24) key until the Station Address 2 (a number 0 through 6) that you previously recorded on the front of your IBM 3197 Problem Solving Guide appears at the right of the Terminal Mode indicator “-” and then release the Cmd 24 key.

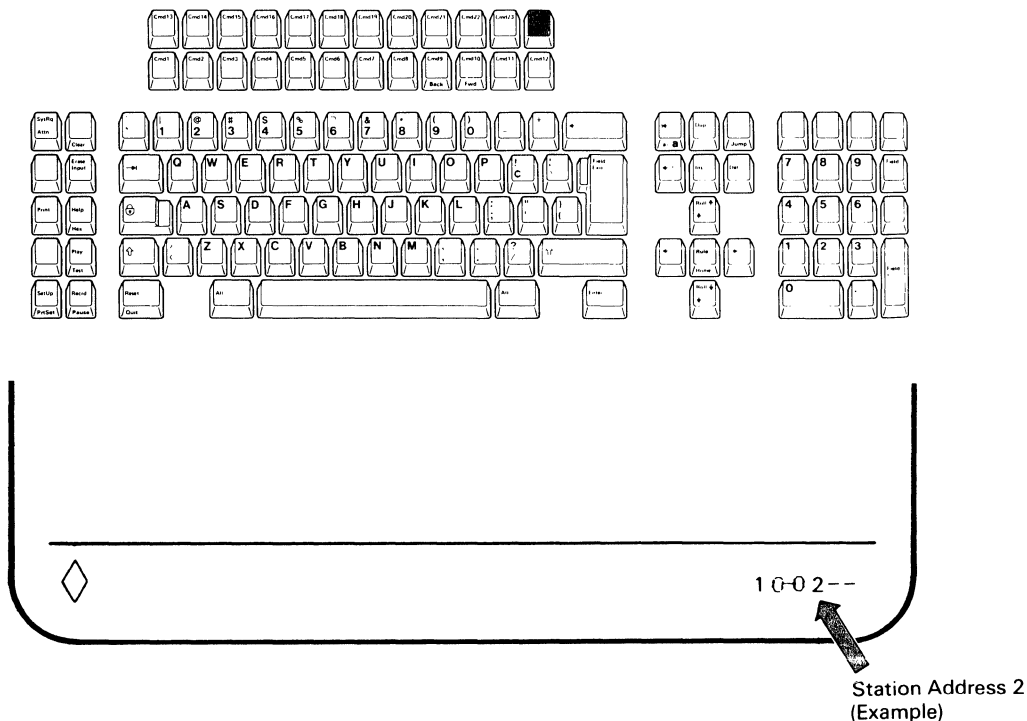

5.3.4 Press the SetUp key.

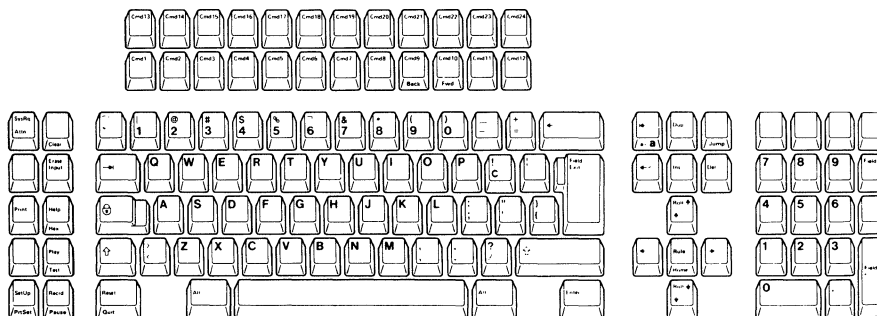

Display Station Addresses 1 and 2 are now set and remain the same until you change them.

-
- 5.3.5** Open the document pocket door located at the left side of the logic element and put the IBM 3197 Problem Solving Guide in the compartment. Then close the door.

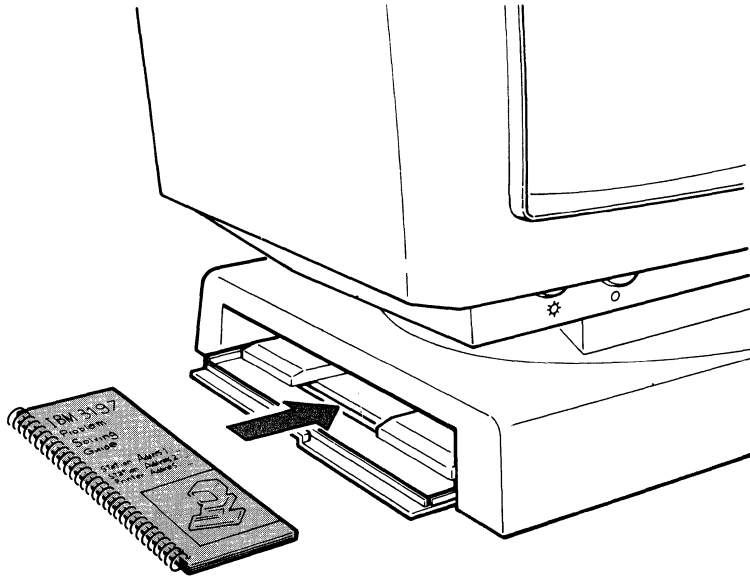

Go to Section 9 on page 73. Connecting to a Host System or a Controller.

5.4 SELECT DISPLAY-PRINTER MODE.

- 5.4.1 Press and release the Terminal Mode (Cmd 20) key until "  " appears at the left of the Keyboard ID symbol "AD1".

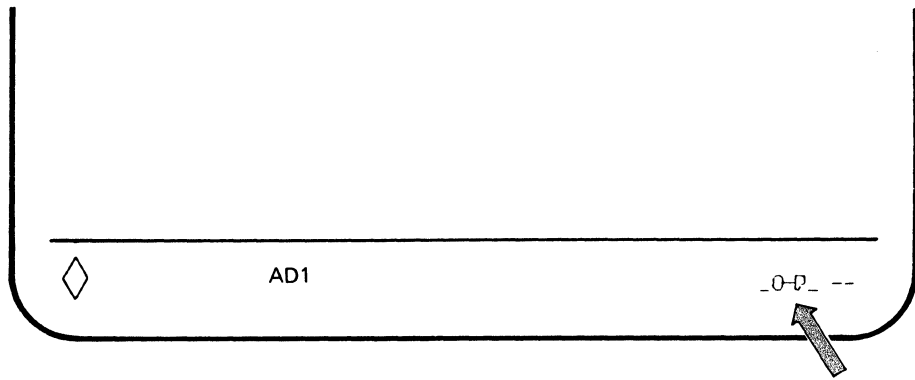
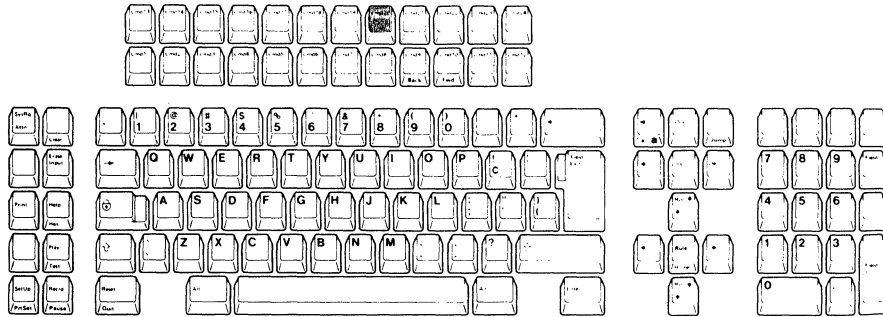

5.4.2 Press and hold the Set Address 1 (Cmd 23) key until the Station Address 1 (a number 0 through 6) that you previously recorded on the front of your IBM 3197 Problem Solving Guide, appears and then release the Cmd 23 key.

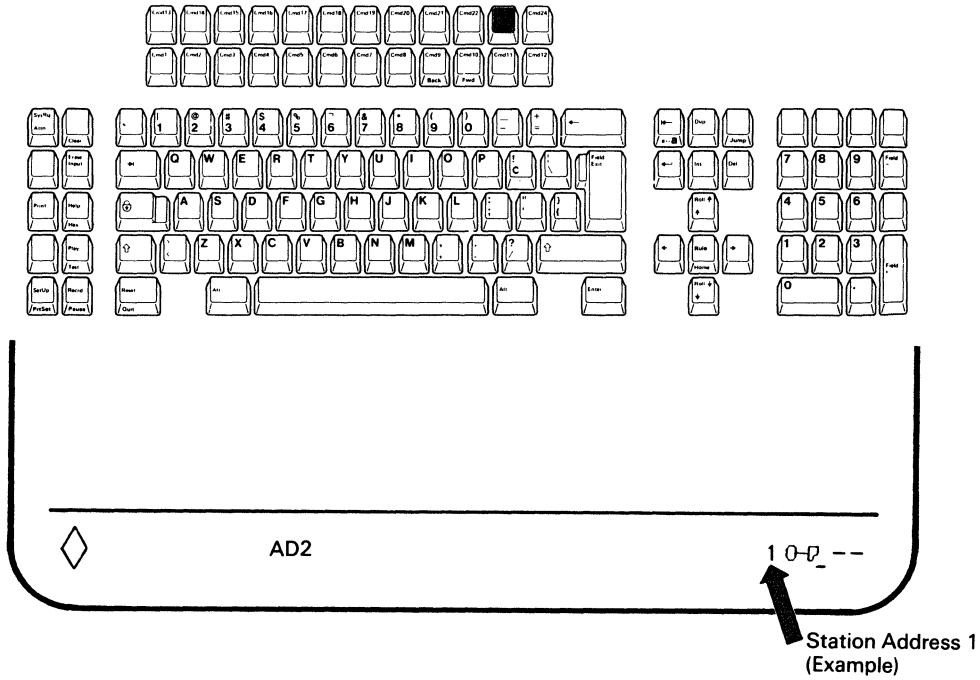

5.4.3 Press and hold the Set Address 2 (Cmd 24) key until the Printer Address (a number 0 through 6) that you previously recorded on the front of your IBM 3197 Problem Solving Guide, appears and then release the Cmd 24 key.

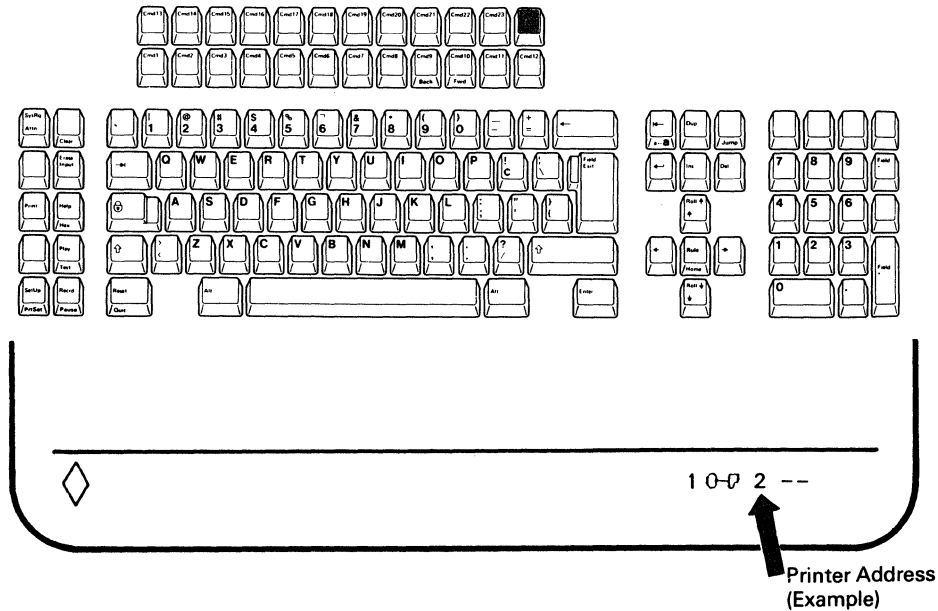

5.4.4 Press the SetUp key.

Display station address 1 and the printer address are now set and remain the same until you change them.

5.5 SELECT PRINTER CHARACTER SET AND DEVICE ID.

Note: Ensure the specified Printer Character Set and Device ID with the Setup Work Sheet or with your supervisor before starting this step.

5.5.1 Press and hold the Alt key and then press the SetUp key to enter printer setup mode.

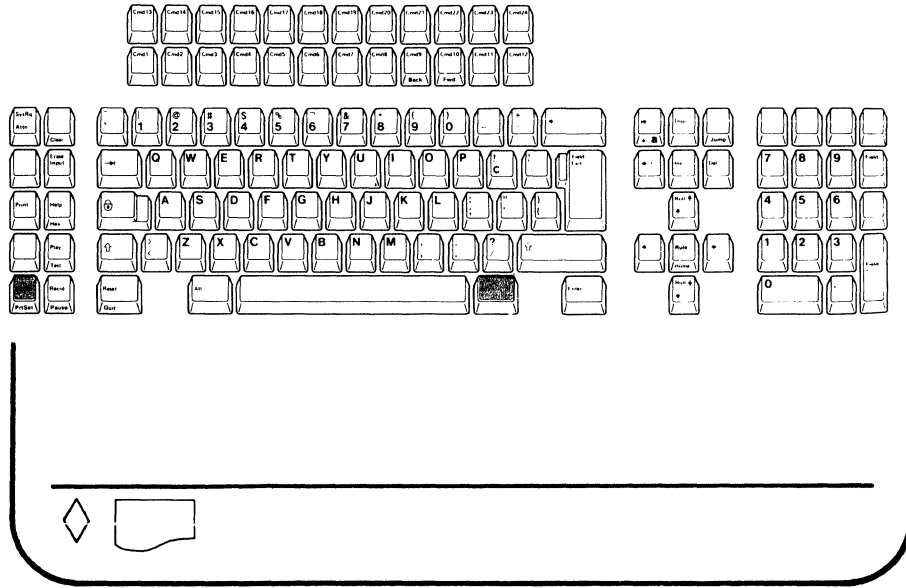

5.5.2 Press and release the Character Set (Cmd 15) key until your planned Printer Character Set: either 437 or 850, appears on the right side of the operating status line.

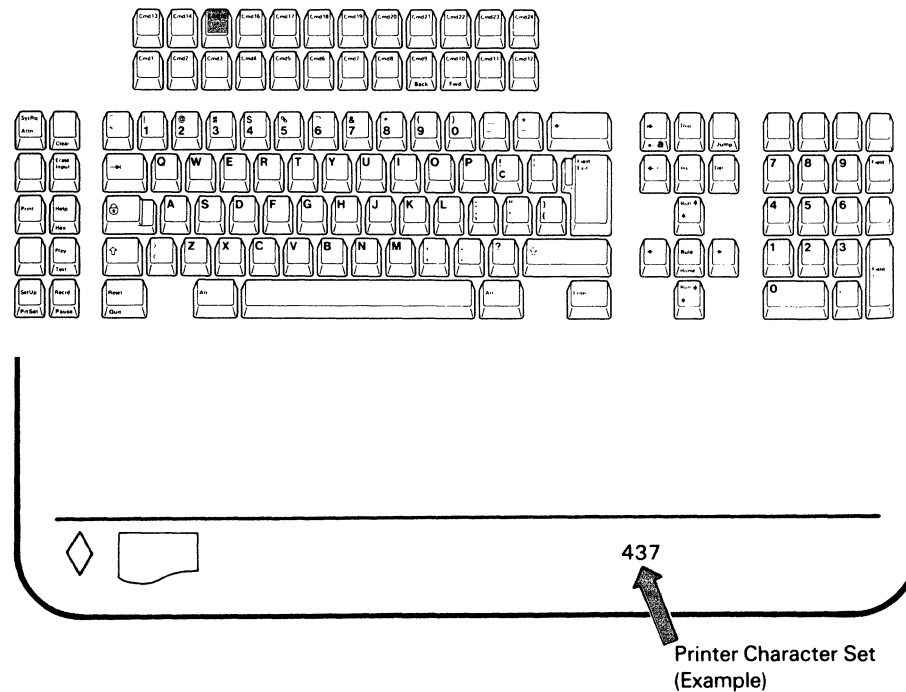

5.5.3 Press and hold the Alt key and then press the Device ID (Cmd 14) key. The operating status line changes to device ID mode and either device ID; 4214 or 5256 will appear.

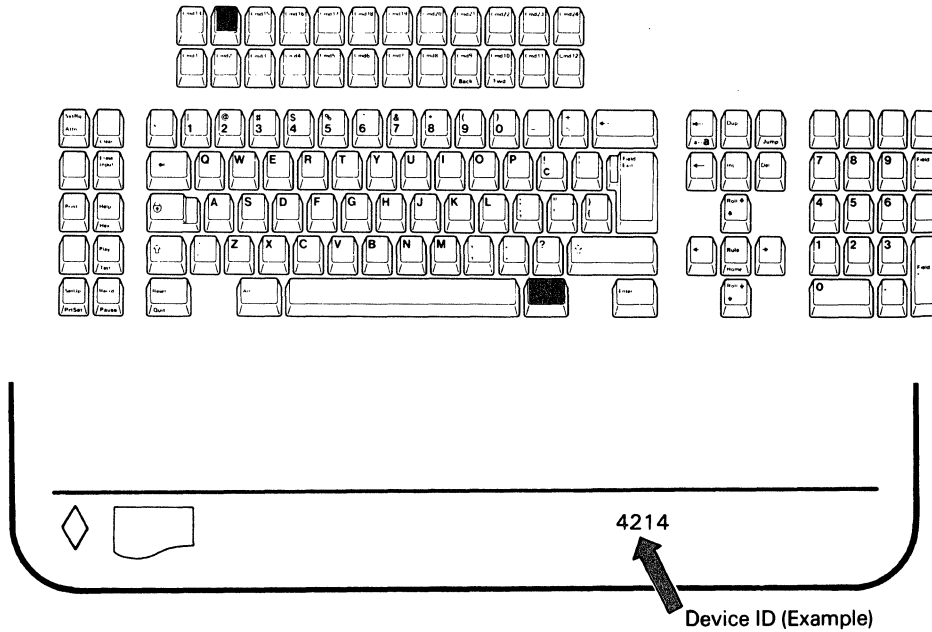

5.5.4 Press and release the Cmd 14 key until the required device ID appears on the operating status line. (Pressing and releasing the Cmd 14 key alternately changes the ID from 4214 to 5256 or from 5256 to 4214.)

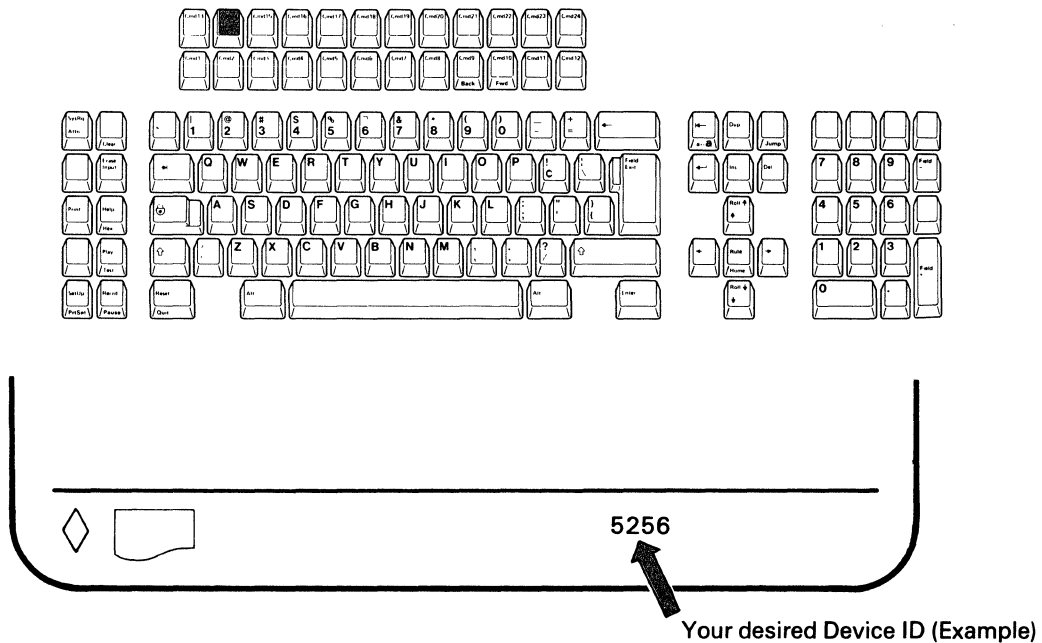

5.5.5 Press and hold the Alt key and then press the Device ID (Cmd 14) key to exit from device ID mode.

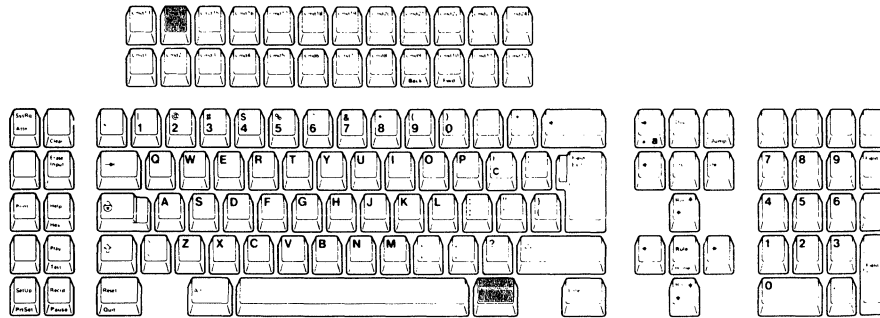

5.5.6 Press and hold the Alt key and then press the SetUp key to exit from printer setup mode.

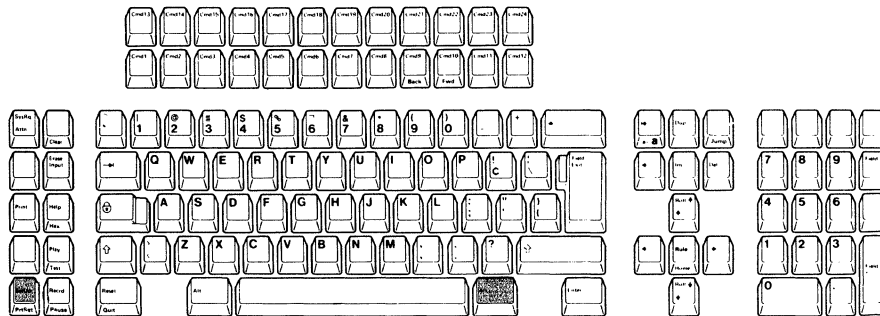

-
- 5.5.7** Open the document pocket door located at the left side of the logic element and put the IBM 3197 Problem Solving Guide in the compartment. Then close the door.

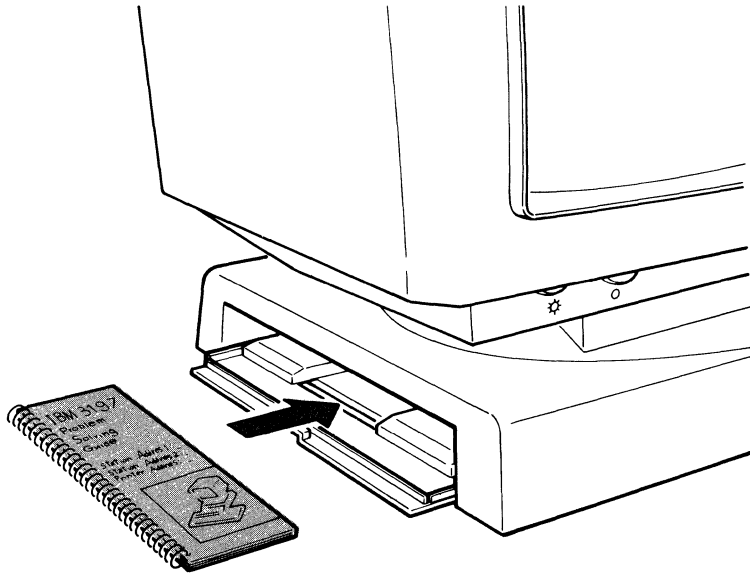

Go to Section 9 on page 73. Connecting to a Host System or a Controller.

If your keyboard looks like the one shown below,

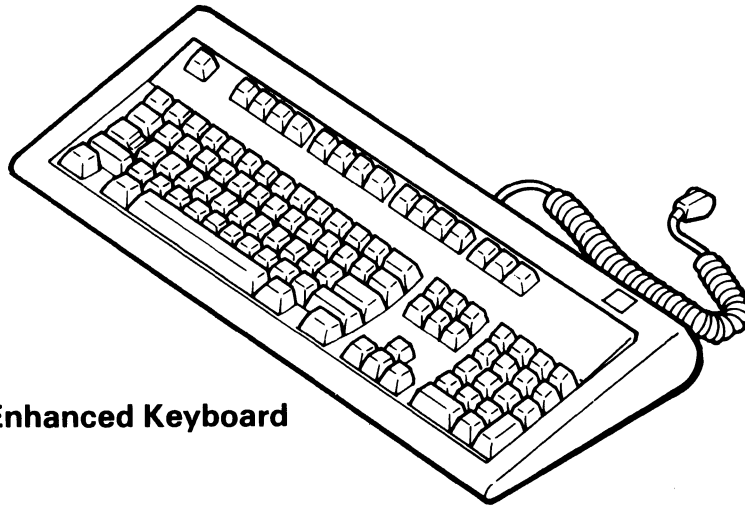

IBM Enhanced Keyboard

CUT AND OPEN THIS PACKAGE WITH A LETTER KNIFE AT THE PERFORATION AS SHOWN BELOW.

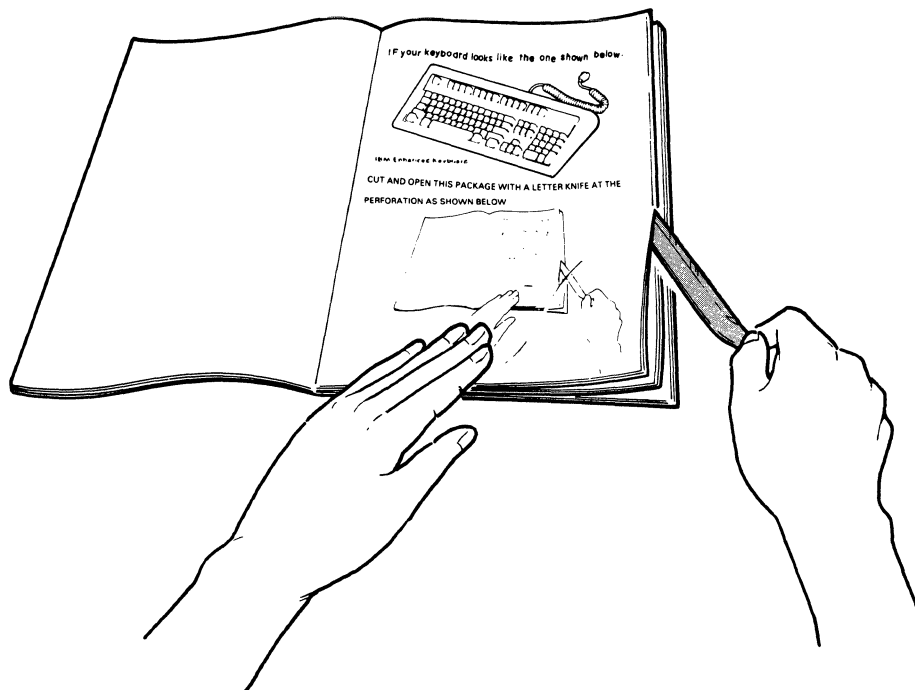

Section 6. Adjusting the Display Station (IBM Enhanced Keyboard)

6.1 ADJUSTING THE BRIGHTNESS AND CONTRAST CONTROL.

- 6.1.1 Press and hold the space bar and set the power switch to | (on) and continue holding the space bar until the following display appears.

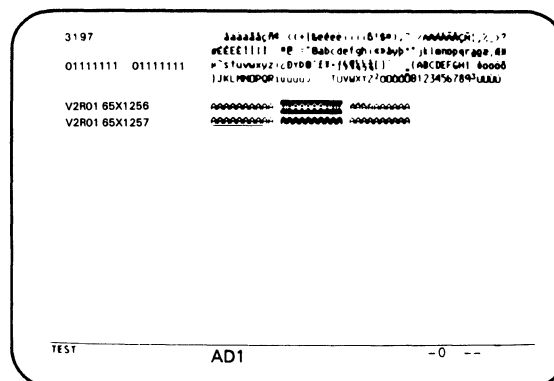
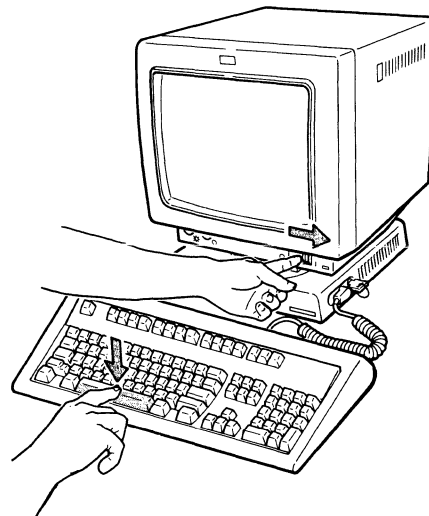

Note: If the above display does not appear, set the power switch to O (off), and repeat step 6.1.1. If the above display still does not appear, refer to the *IBM 3197 Model D Display Station Problem Solving Guide*, GA18-2547.

6.1.2 Adjust the screen brightness to a comfortable viewing level.

To increase the screen brightness, turn the brightness control clockwise.

To decrease the screen brightness, turn the brightness control counterclockwise.

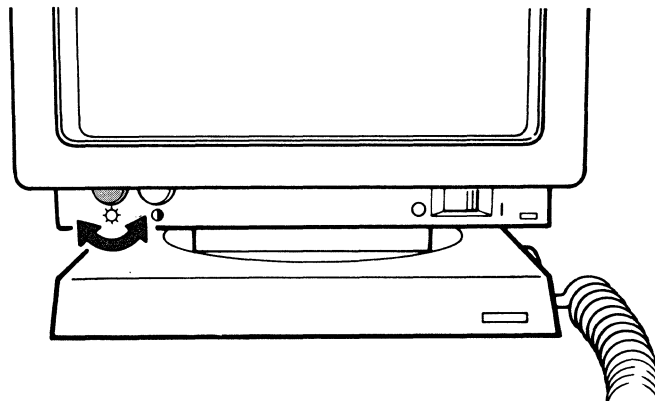

6.1.3 Adjust the screen contrast to a comfortable viewing level.

To increase the screen contrast, turn the contrast control clockwise.

To decrease the screen contrast, turn the contrast control counterclockwise.

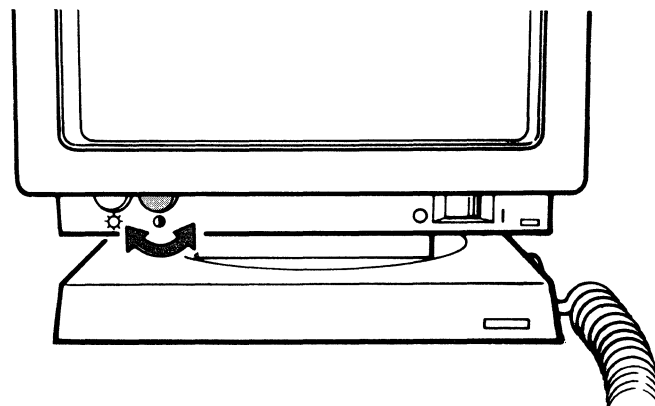

6.1.4 Set the power switch to O (off).

6.2 ADJUSTING THE KEYBOARD SLOPE AND THE VIDEO VIEWING POSITIONS.

6.2.1 Turn the keyboard upside down and flip the legs up from the underside of the keyboard.

- With the keyboard legs down, the slope is 12 degrees.
- With the legs locked underside of the keyboard, the slope is 6 degrees.

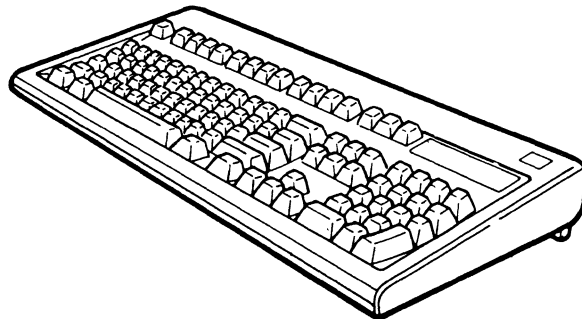
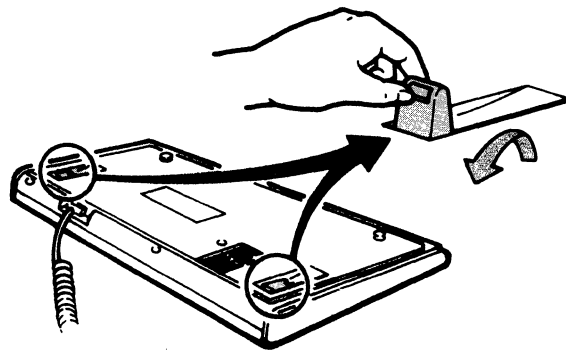
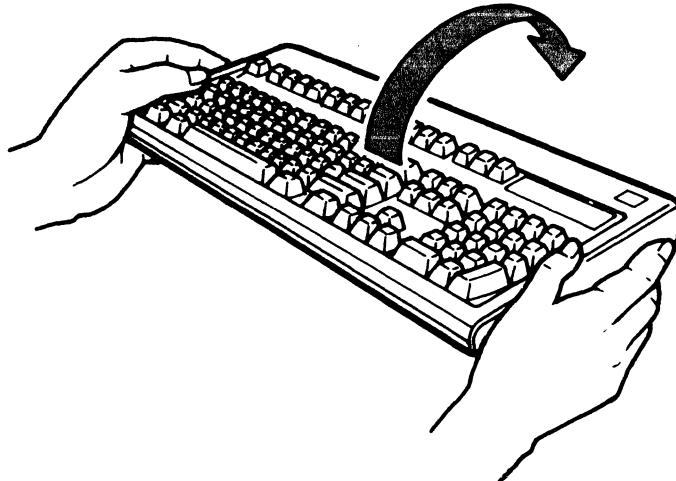

6.2.2 Adjust the video element to the desired viewing position.

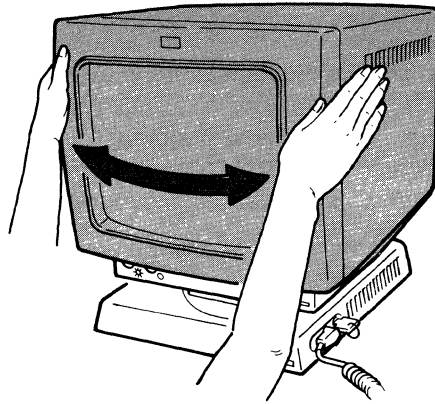

To rotate the video element, place your hands on both sides of the video element near the front edge and turn it left or right.

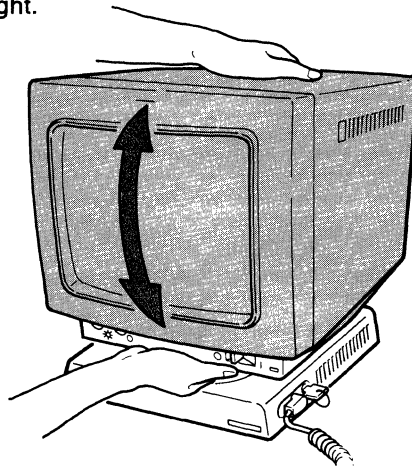

To adjust the tilt of the video element, place your hands on the upper back edge and front edge of the video element as shown above and move it to the desired position.

6.2.3 Place the keyboard overlay (for setup operation) on your keyboard.

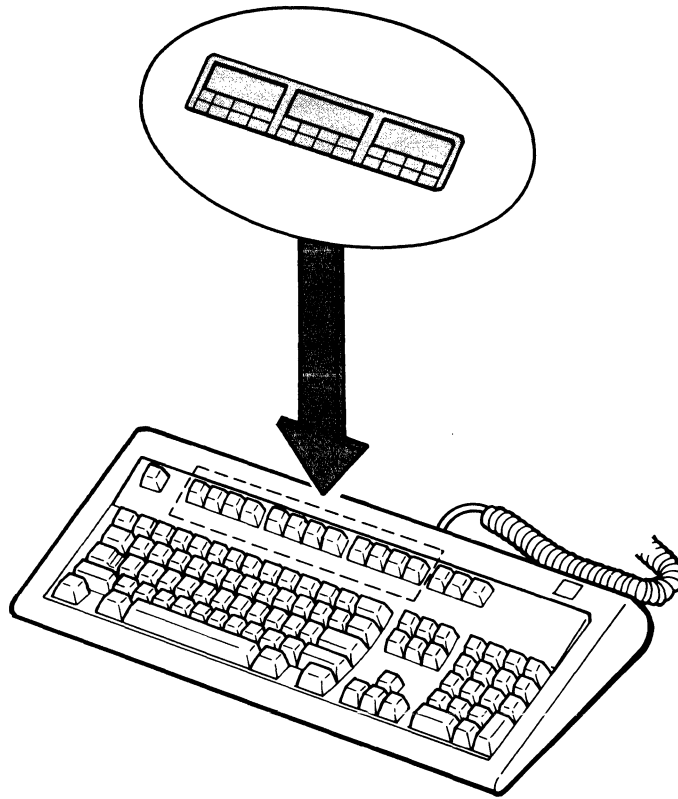

Go to Section 7.

7.1.2. Press and hold the Shift key and then press the SetUp key.

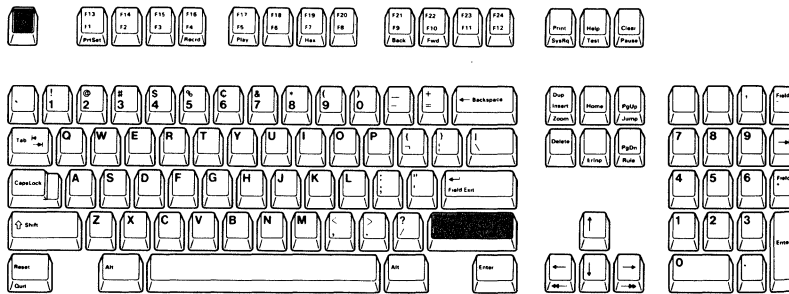

A diamond appears at the bottom of the display screen.

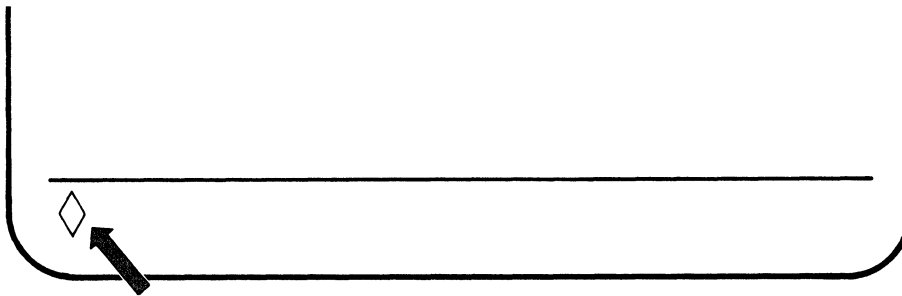

7.1.3 Make sure that the keyboard ID displayed at the bottom of your display is a “--”.

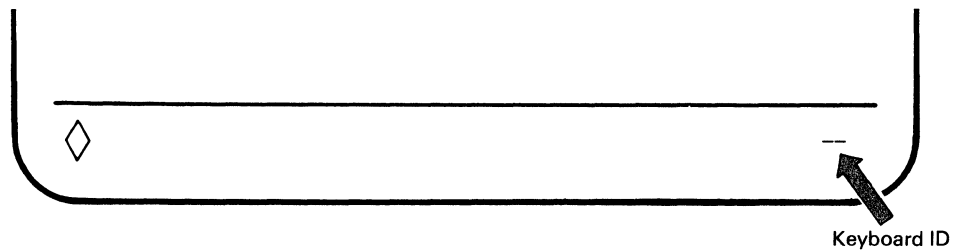

If the displayed ID is 00 through 63, press and hold both the Shift key and the Keyboard ID (F22/F10) key until a “--” appears. A “--” immediately follows the number 63 when the Keyboard ID key is pressed.

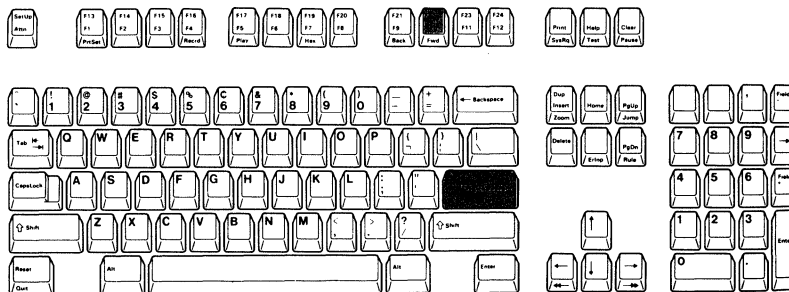

7.2. SELECTING YOUR CHARACTER SET.

- 7.2.1** Obtain a copy of the Setup Work Sheet that is attached to back of the IBM 3197 Description (GA18-2544) from your supervisor.

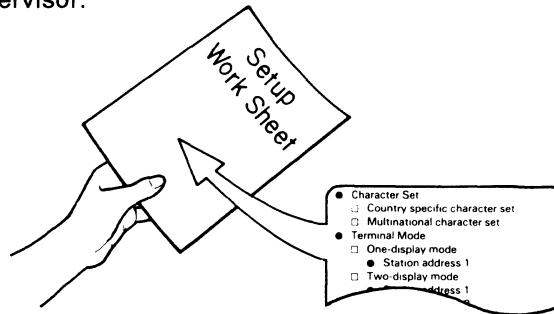

-
- 7.2.2** Check the selection of the Character Set on the Setup Work Sheet.

If the character set you need is Country-specific, skip this step and go to step 7.3.
If the character set is multinational, go to step 7.2.3.

- 7.2.3** Press and hold the Shift key and then press the F21/F9 key.



An "M" appears on the operating status line.

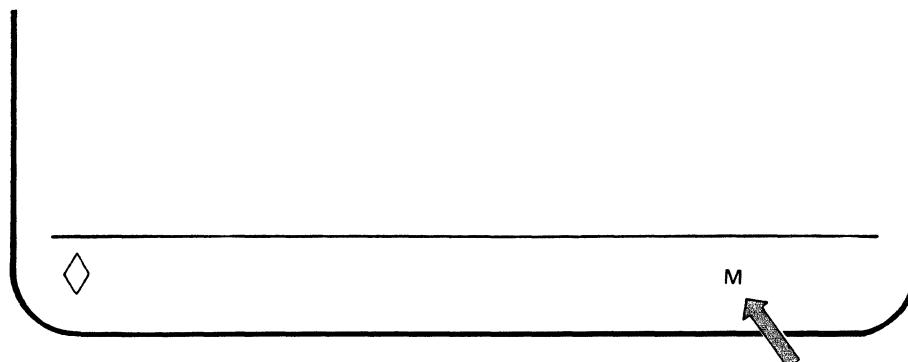

7.3. SAVE THE KEYBOARD ID AND THE CHARACTER SET.

7.3.1. Press and hold the Shift key and then press the SetUp key to end the selections.

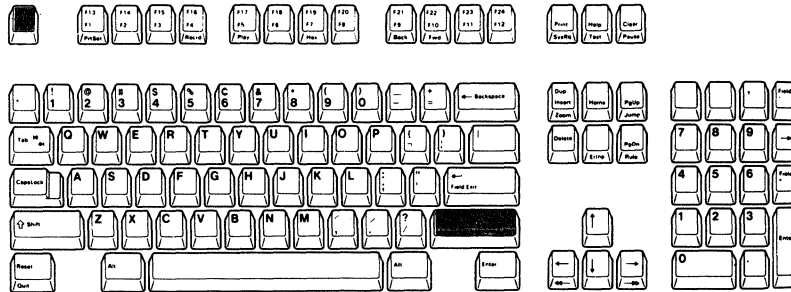

The keyboard ID and the character set are now set and remain the same until you change them.

Go to Section 8.

Section 8. Selecting Your Terminal Mode (IBM Enhanced Keyboard)

YOUR DISPLAY STATION CAN BE OPERATED IN EITHER ONE OF THE FOLLOWING TERMINAL MODES:

- One-Display Mode:** Works as an ordinary display station.
 - Two-Display Mode:** Works as two separate display stations.
 - Display-Printer Mode:** Works as two workstations: one display station and one printer. The printer attached to your display station is controlled by the host system.
-

8.1 SELECTING AN APPROPRIATE TERMINAL MODE.

8.1.1 Check the Setup Work Sheet to find which terminal mode is to be selected. Then record the addresses on the front cover of the *IBM 3197 Problem Solving Guide*.

Note: Each workstation address (for the display station and printer) must be different from the other workstations on this string.

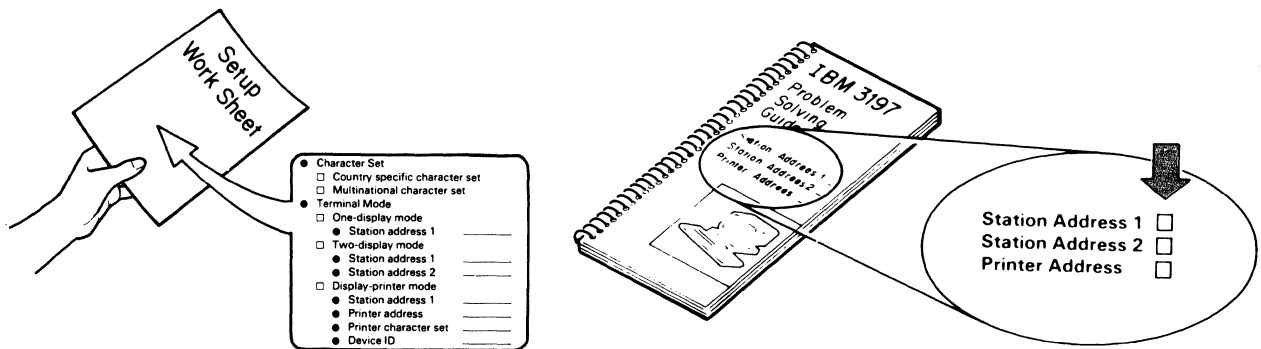

8.1.2 Press and hold the Shift key and then press the SetUp key.

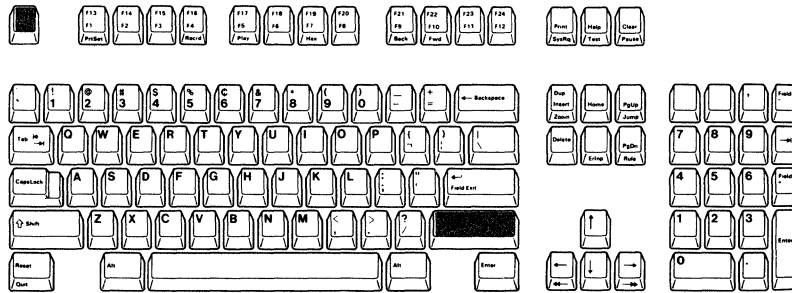

A diamond appears at the bottom of the display screen.

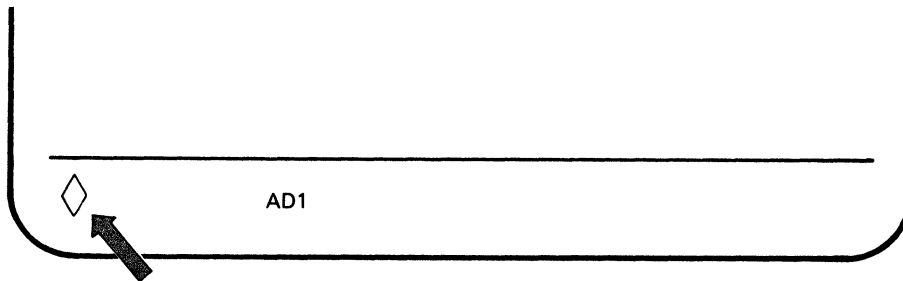

8.1.3 Observe on the operating status line the indication of the current terminal mode.

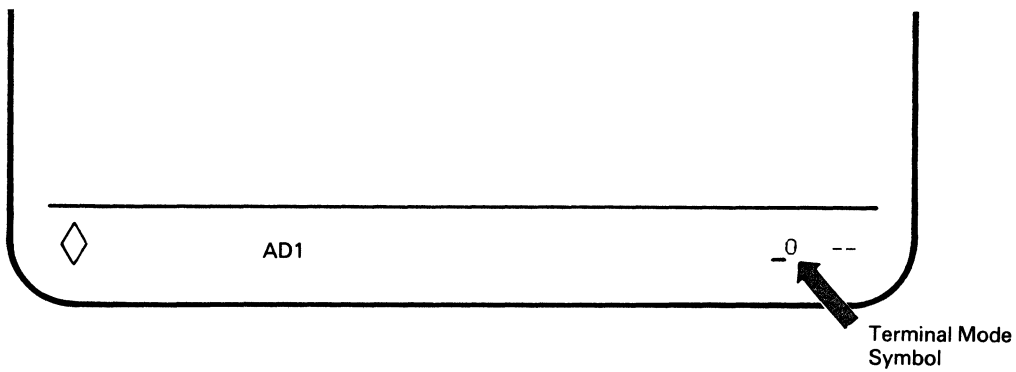

8.1.4 If your Terminal Mode described in the Setup Work Sheet is:

- **One-Display Mode** ➡ Go to step 8.2.
- **Two-Display Mode** ➡ Go to step 8.3.
- **Display-Printer Mode** ➡ Go to step 8.4.

8.2 SELECT ONE-DISPLAY MODE.

8.2.1 Make sure that the indication of the terminal mode is "◊".

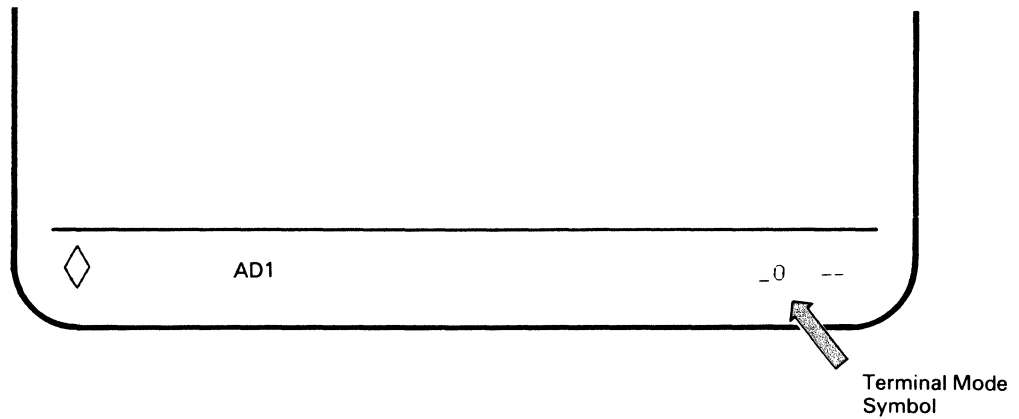

8.2.2 Press and hold the Shift key and then press the Set Address 1 (F23/F11) key until the Station Address 1 that you previously recorded on the front of your IBM 3197 Problem Solving Guide appears.

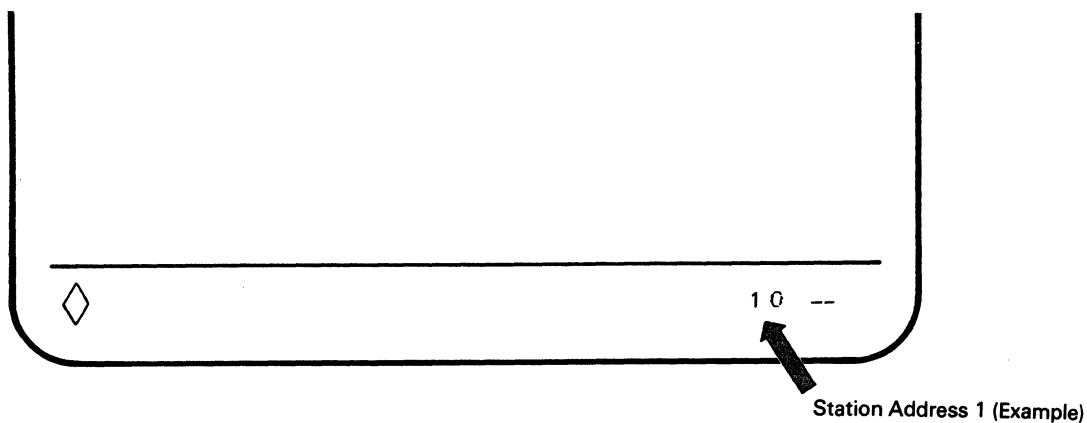
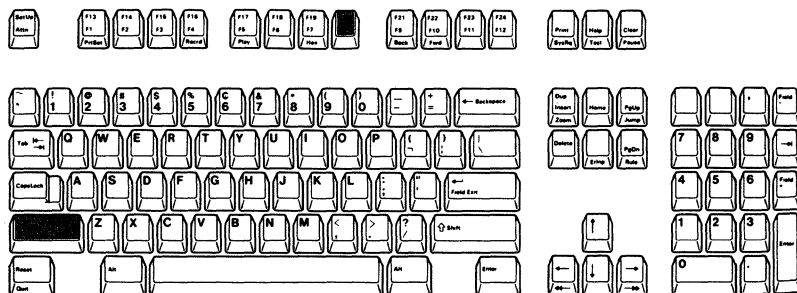

8.2.3 Press and hold the Shift key and then press the SetUp Key.

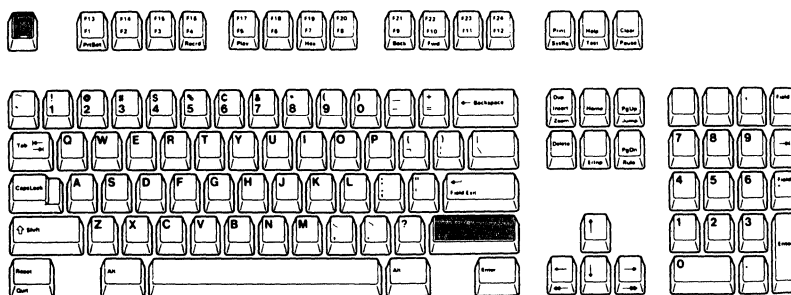

Display Station Address 1 is now set and remains the same until you change it.

8.2.4 Open the document pocket door located at the left side of the logic element and put the IBM 3197 Problem Solving Guide in the compartment. Then close the door.

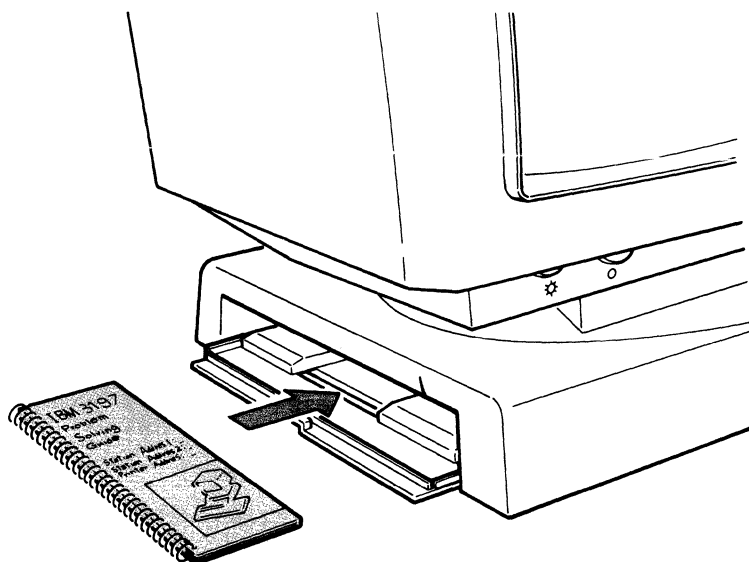

Go to Section 9 on page 73. Connecting to a Host System or a Controller.

8.3 SELECT TWO-DISPLAY MODE.

8.3.1 Press and hold the Shift key and then press and release the Terminal Mode (F20/F8) key until “0-0” appears at the left of the Keyboard ID symbol “_”.

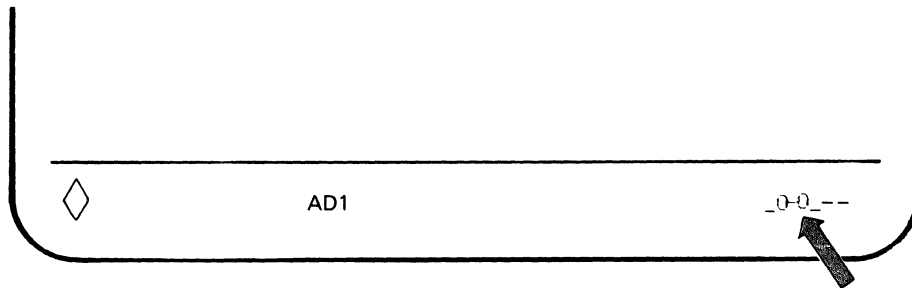
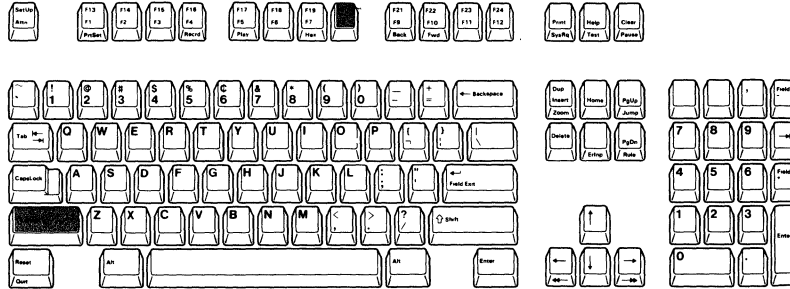

8.3.2 Press and hold the Shift key and then press and release the Set Address 1 (F23/F11) key until the Station Address 1 (a number 0 through 6) that you previously recorded on the front of your IBM 3197 Problem Solving Guide appears and then release the keys.

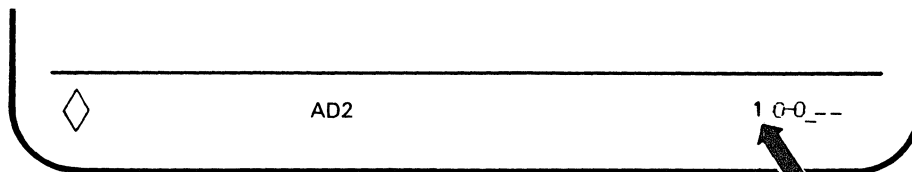
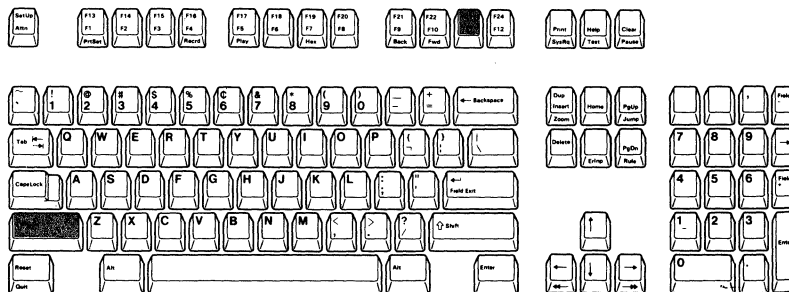

Station Address 1 (Example)

8.3.3 Press and hold both the Shift key and the Set Address 2 (F24/F12) key until the Station Address 2 (a number 0 through 6) that you previously recorded on the front of your IBM 3197 Problem Solving Guide appears at the right of the Terminal Mode indicator “” and then release the F24/F12 key and the Shift key.

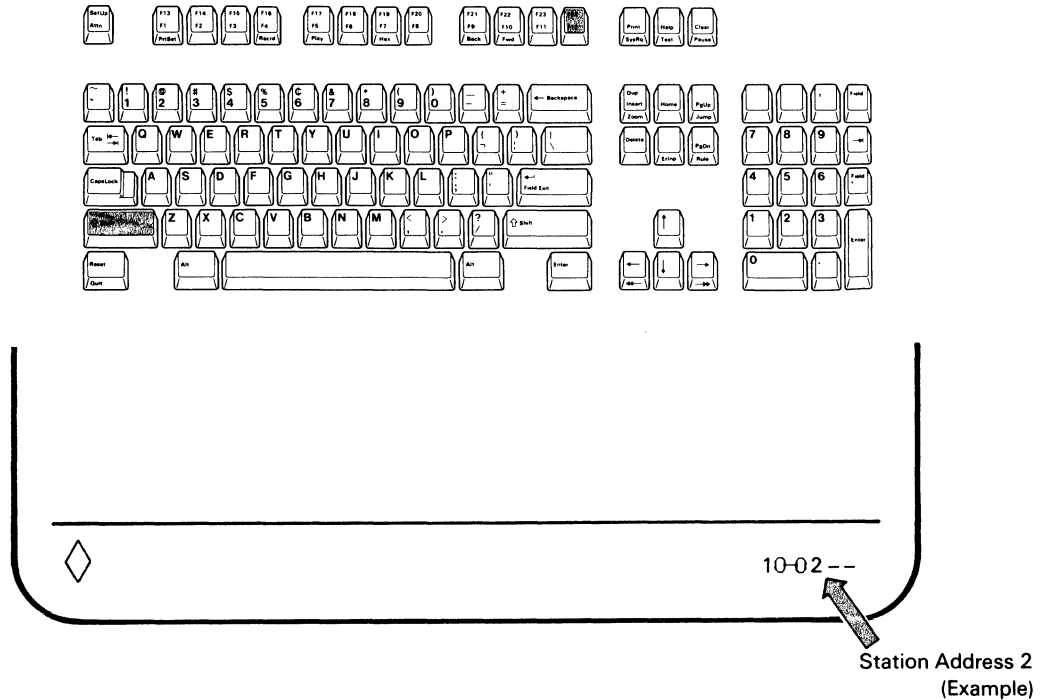

8.3.4 Press and hold the Shift key and then press the SetUp key.

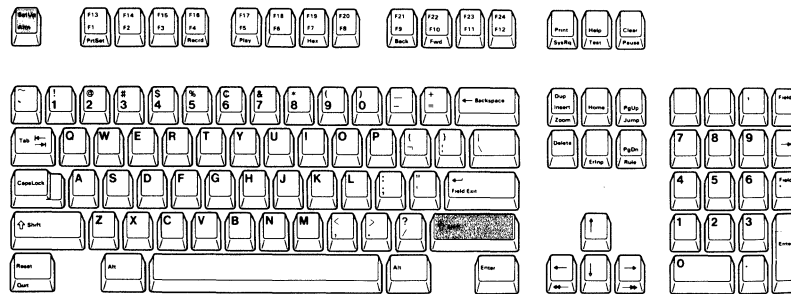

Display Station Addresses 1 and 2 are now set and remain the same until you change them.

-
- 8.3.5** Open the document pocket door located at the left side of the logic element and put the IBM 3197 Problem Solving Guide in the compartment. Then close the door.

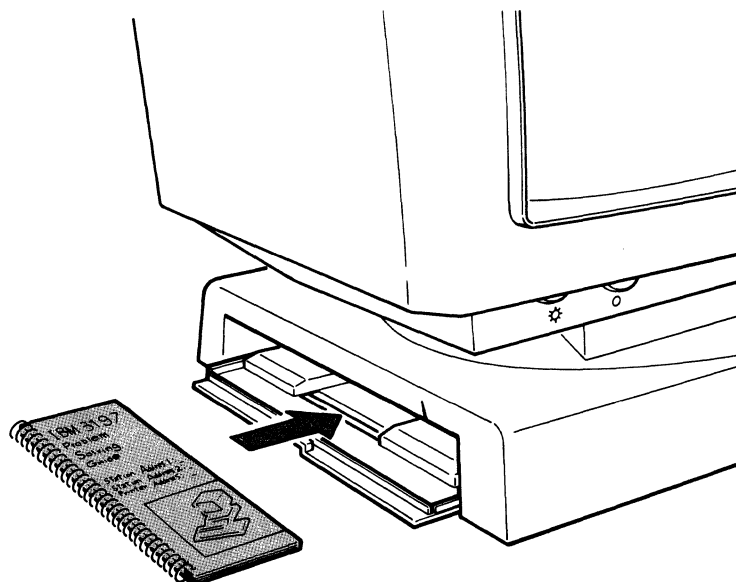

Go to Section 9 on page 73. Connecting to a Host System or a Controller.

8.4 SELECT DISPLAY-PRINTER MODE.

- 8.4.1 Press and hold the Shift key and then press and release the Terminal Mode (F20/F8) key until “” appears at the left of the Keyboard ID symbol “AD1”.

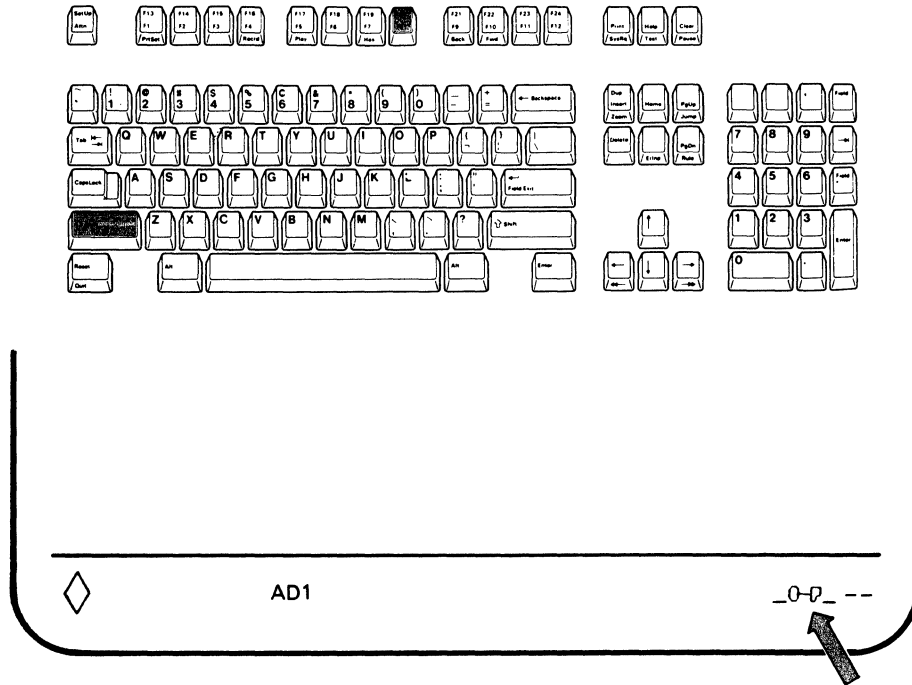

- 8.4.2** Press and hold the Shift key and then press the Set Address 1 (F23/F11) until the Station Address 1 (a number 0 through 6) that you previously recorded on the front of your IBM 3197 Problem Solving Guide appears.

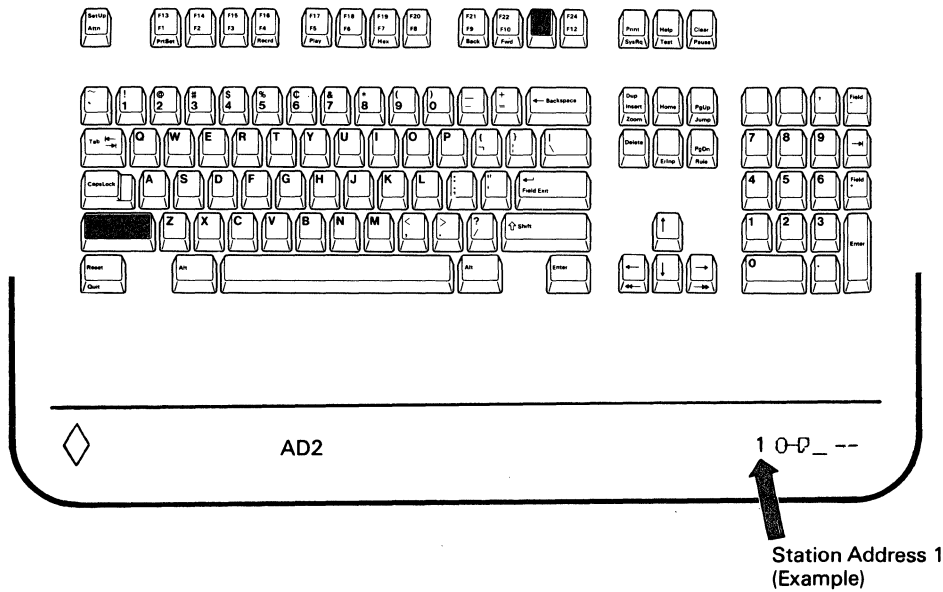

- 8.4.3** Press and hold the Shift key and then press the Set Address 2 (F24/F12) key until the Printer Address (a number 0 through 6) that you previously recorded on the front of your IBM 3197 Problem Solving Guide appears.

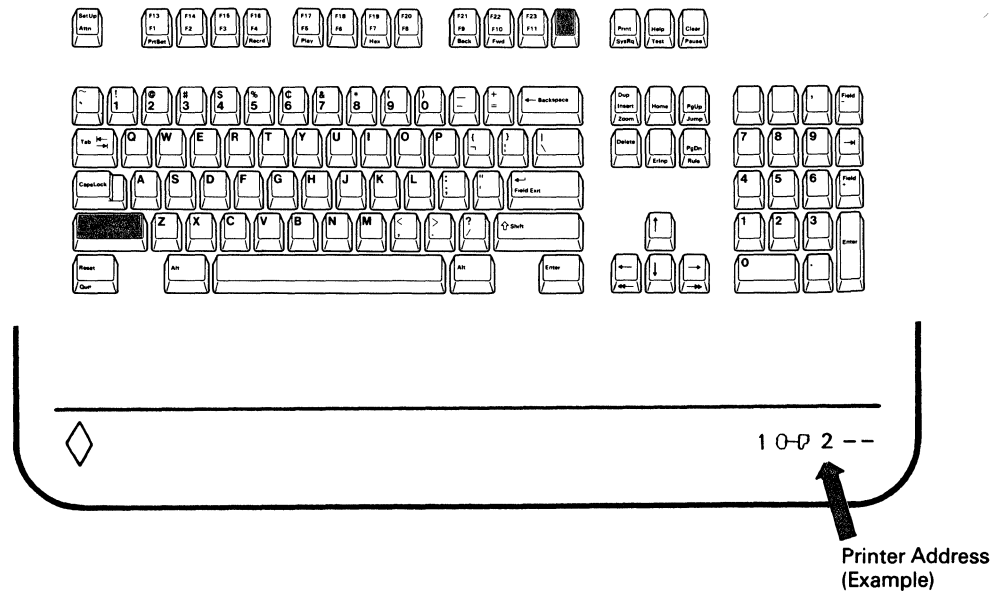

- 8.4.4** Press and hold the Shift key and then press the SetUp key.

Display Station Address 1 and the Printer Address are now set and remain the same until you change them.

8.5 SELECT PRINTER CHARACTER SET AND DEVICE ID.

Note: Ensure the specified Printer Character Set and Device ID with the Setup Work Sheet or with your supervisor before starting this step.

8.5.1 Press and hold the Alt key, then press the PrtSet (F13/F1) key to enter printer setup mode.

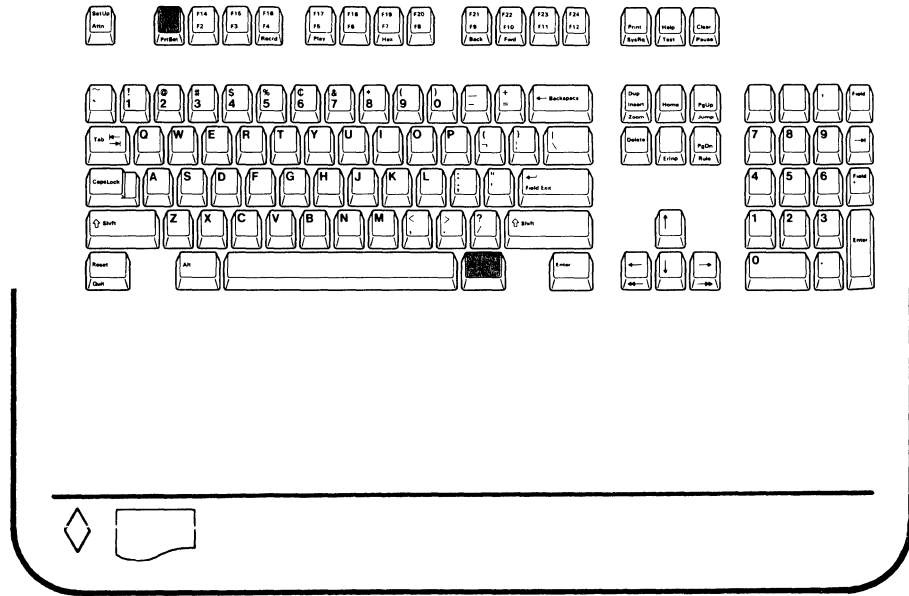

8.5.2 Press and hold the Shift key and then press and release the Character Set (F15/F3) key until your planned Printer Character Set: either 437 or 850, appears on the right side of the operating status line.

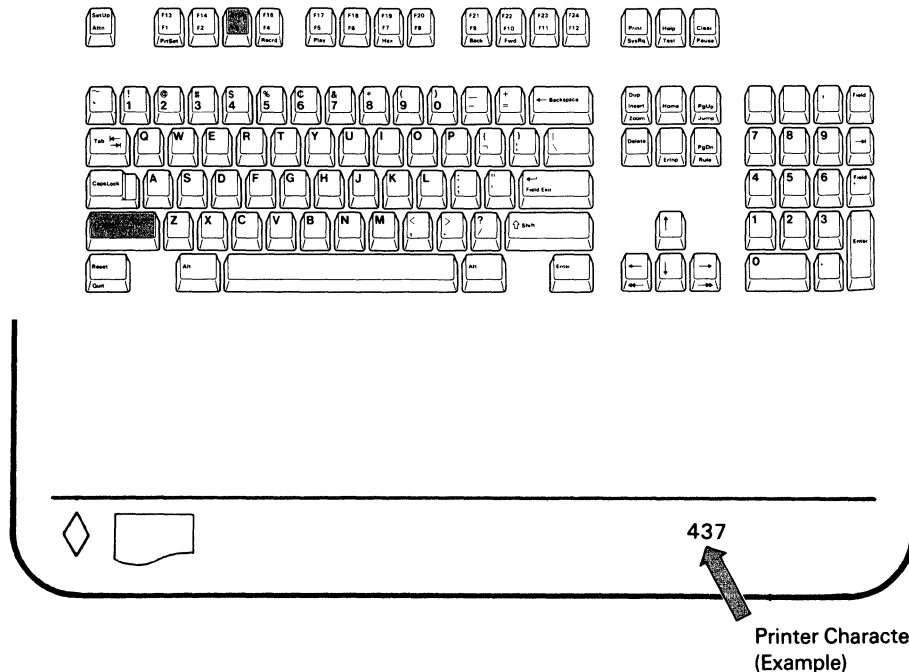

8.5.3 Press and hold the Alt key and then press the Device ID (F14/F2) key. The operating status line changes to device ID mode and either device ID; 4214 or 5256 will appear.

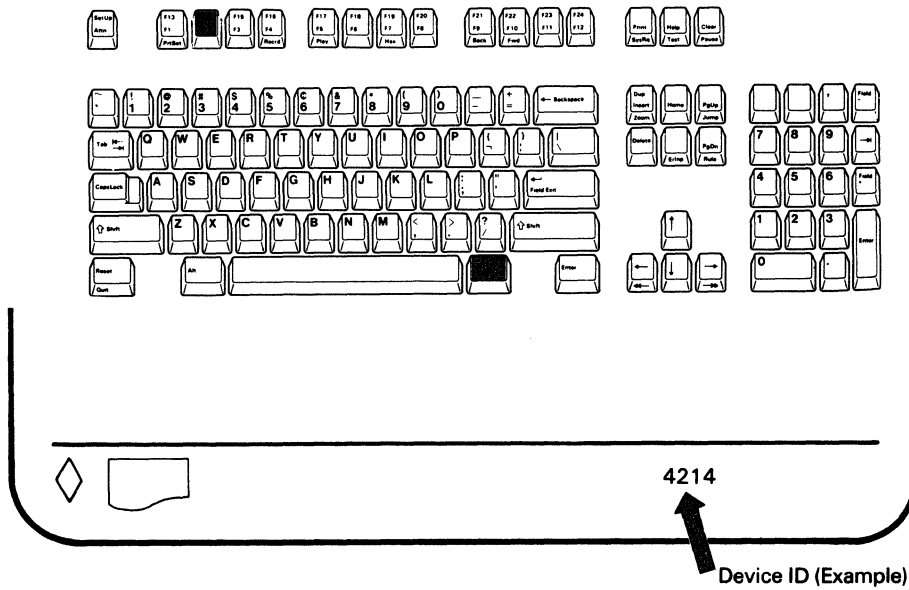

8.5.4 Press and release the F14/F2 key together with the Shift key until the required device ID appears on the operating status line. (Pressing and releasing the F14/F2 key alternately changes the device ID from 4214 to 5256 or from 5256 to 4214.)

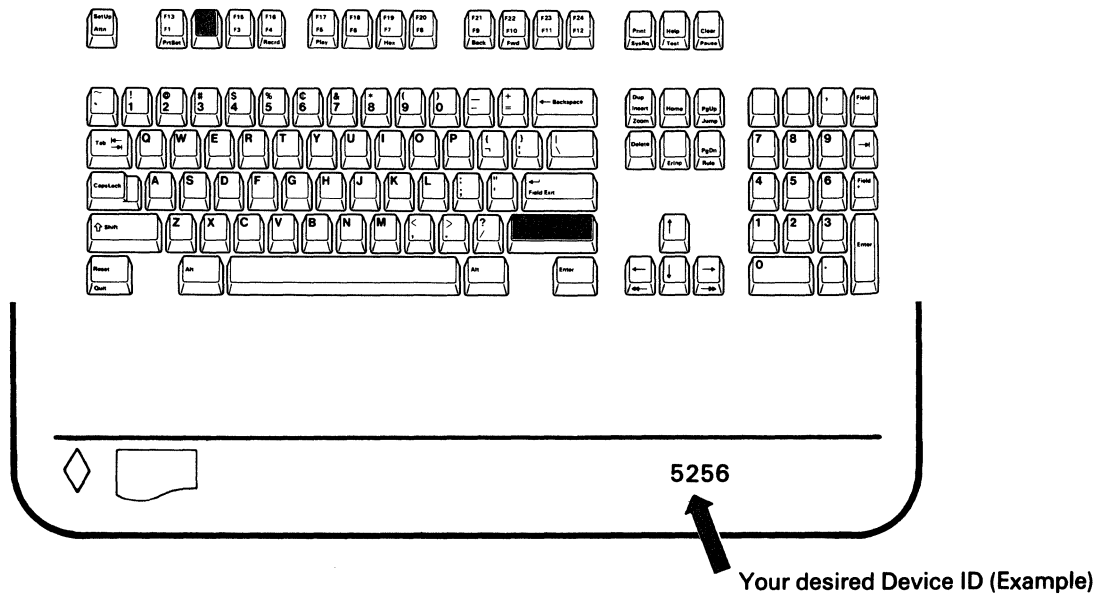

8.5.5 Press and hold the Alt key and then press the Device ID (F14/F2) key to exit from device ID mode.

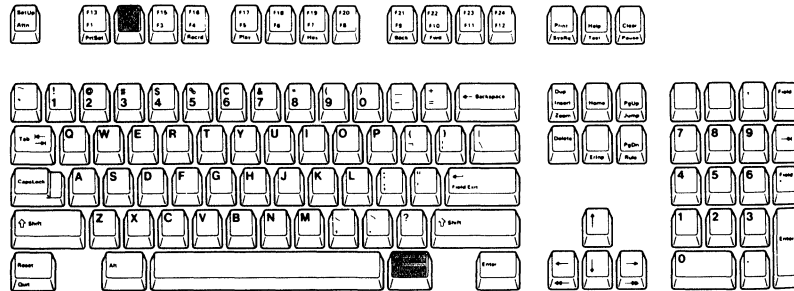

8.5.6 Press and hold the Alt key, and then press the PrtSet (F13/F1) key to exit from printer setup mode.



-
- 8.5.7** Open the document pocket door located at the left side of the logic element and put the IBM 3197 Problem Solving Guide in the compartment. Then close the door.

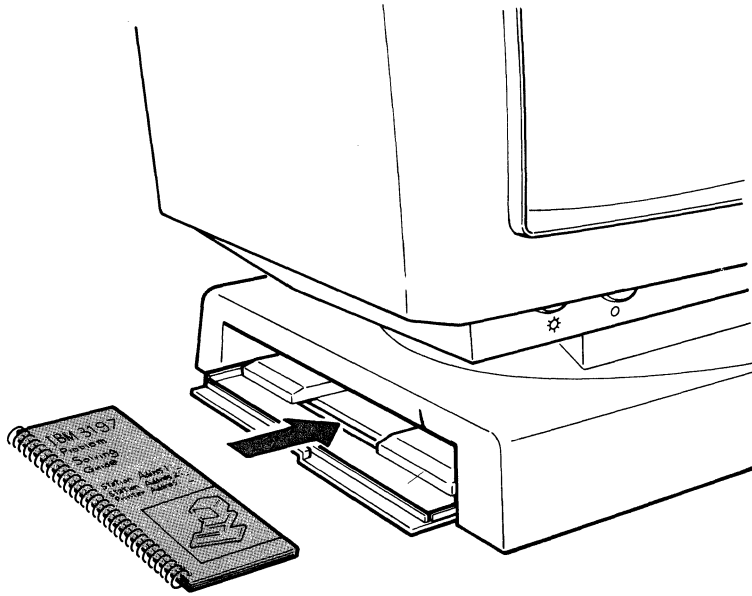

Go to Section 9 on page 73. Connecting to a Host System or a Controller.

Section 9. Connecting to a Host System or a Controller

9.1 BEFORE YOU CONNECT YOUR DISPLAY STATION TO A HOST SYSTEM OR A REMOTE WORKSTATION CONTROLLER, REVIEW YOUR FLOOR PLAN.

SAFETY PRECAUTION

Do not connect or disconnect cables during an electrical storm. You could be seriously injured.

9.1.1 Do the following.

1. Set the power switch to O (off).

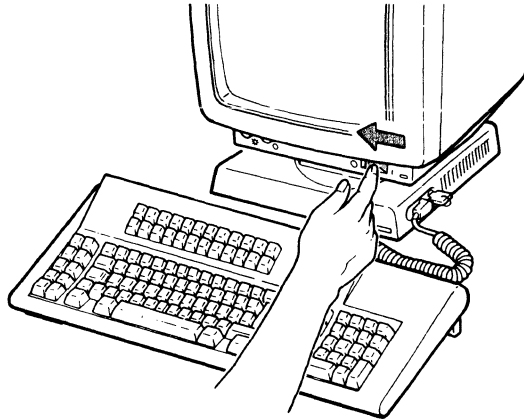

Note: Your keyboard may be different in appearance from the one shown.

2. Disconnect the power cord from the power outlet.

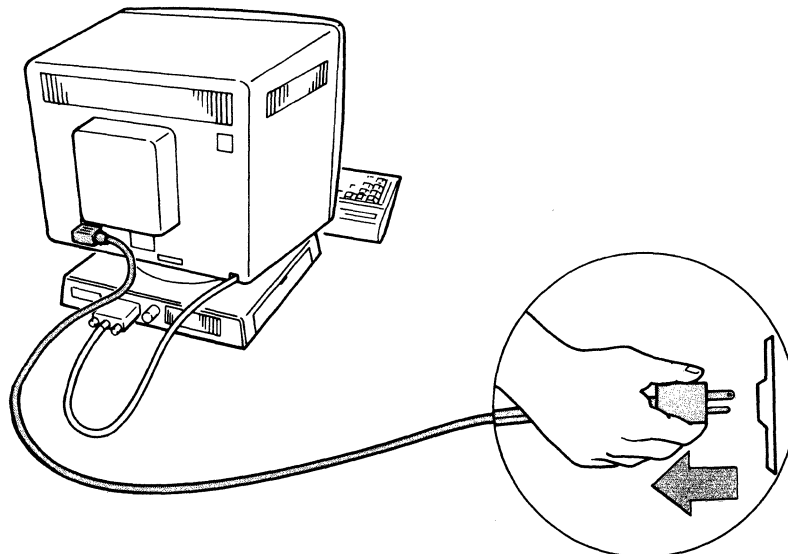

-
- 9.1.2** Align the widest slot of the plug on the auto-termination unit cable with the key in the socket on the rear of the logic element. Then push the plug into the socket and turn the retaining ring clockwise until it is tight.

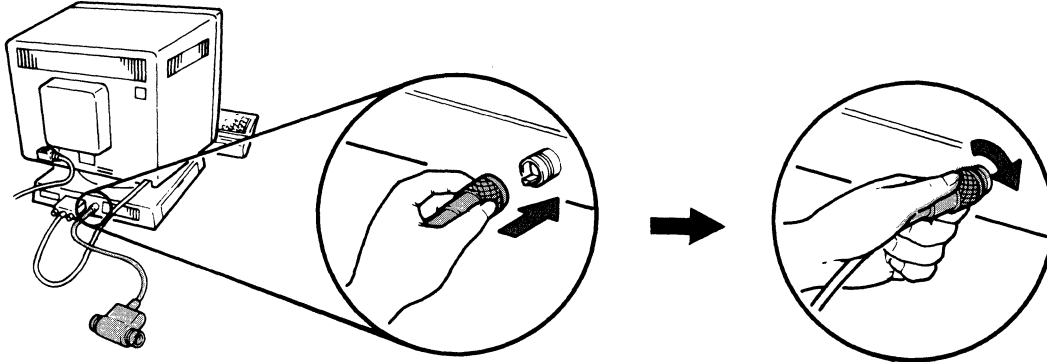

-
- 9.1.3** Locate the correct communications cable. This may be the cable from the host system, the workstation controller, or the previous workstation.

-
- 9.1.4** Align the widest slot of the cable plug with the key in either socket of the auto-termination unit. Then push the plug into the socket and turn the retaining ring clockwise until it is tight.

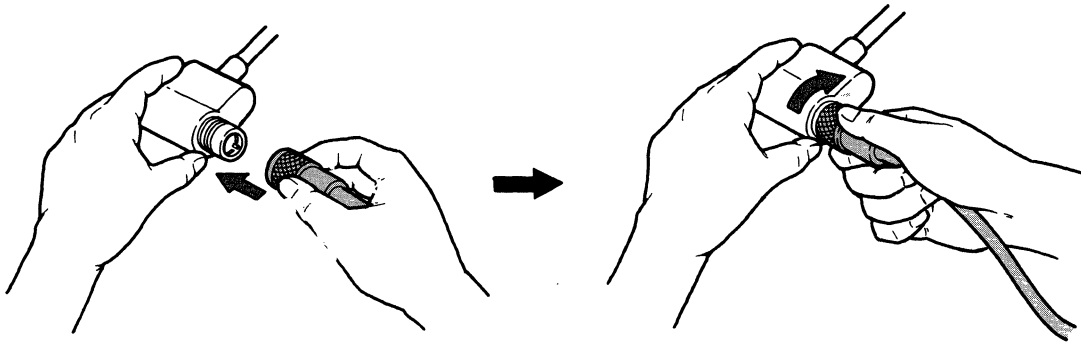

9.1.5 Refer to your floor plan. Is there a workstation (display station or printer) on the cable immediately before your IBM 3197?

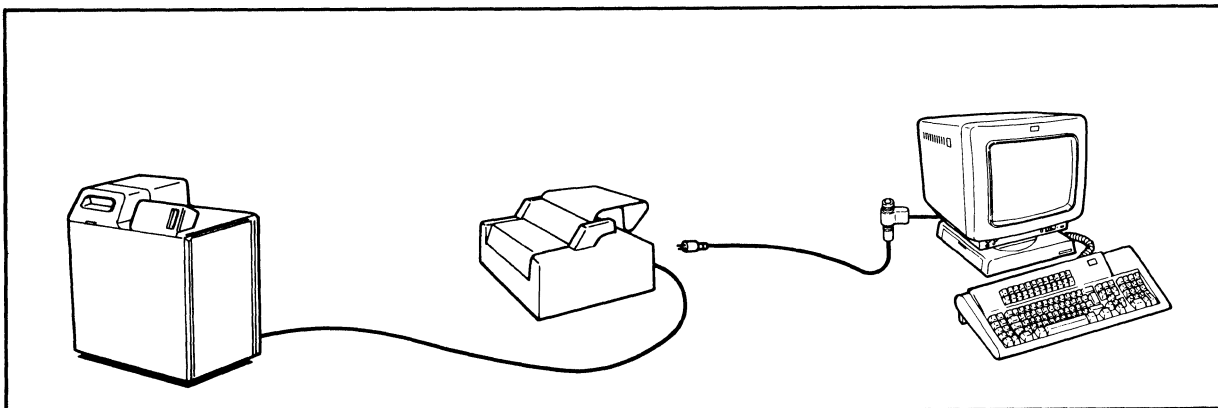

YES: Go to step 9.1.6.

NO: Go to step 9.1.9.

9.1.6 Connect the communications cable to the unused port on the workstation or the unused socket of the auto-termination unit immediately before your IBM 3197.

9.1.7 Does the workstation immediately before yours have a terminator switch? (See Appendix A for locations of terminator switches.)

YES: Go to step 9.1.8.

NO: Go to step 9.1.9.

9.1.8 Make sure that the terminator switch on the workstation immediately before yours is set to 2. See Appendix A for the locations of the terminator switches.

9.1.9. If you have a printer (IBM 4201, IBM 5201 or IBM 4202), attach it to the logic element of your display station.

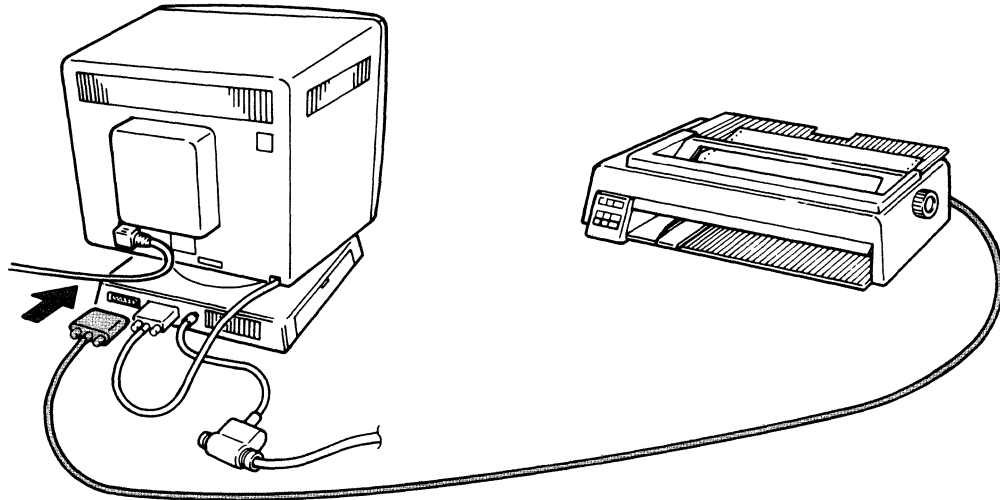

9.1.10 Will the communications cable (the cable that connects to the system or the remote workstation controller) be connected to a 5294 Control Unit?

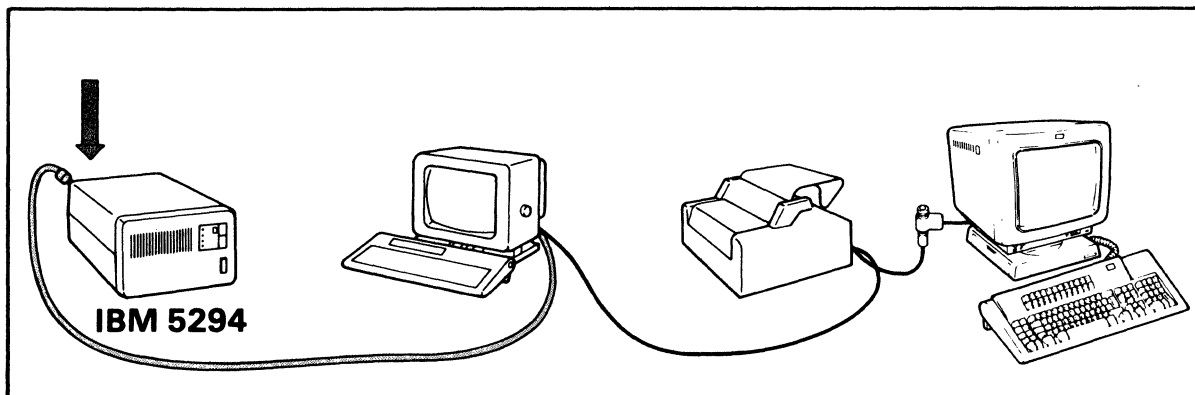

YES: Go to step 9.1.18.

NO: Make sure the communications cable is connected to the host system, then go to step 9.1.11.

9.1.11. If you have a printer, set the power switch of the attached printer to | (on). If not, go to step 9.1.12.

9.1.12. Do the following.

1. Connect the 3197 power cord to a grounded electrical outlet.
 2. Set the 3197 power switch to | (on) to check the communication status between display station 1 and the host system.
-

9.1.13 Within 30 seconds, does a sign-on display (similar to one of the two shown below) appear?

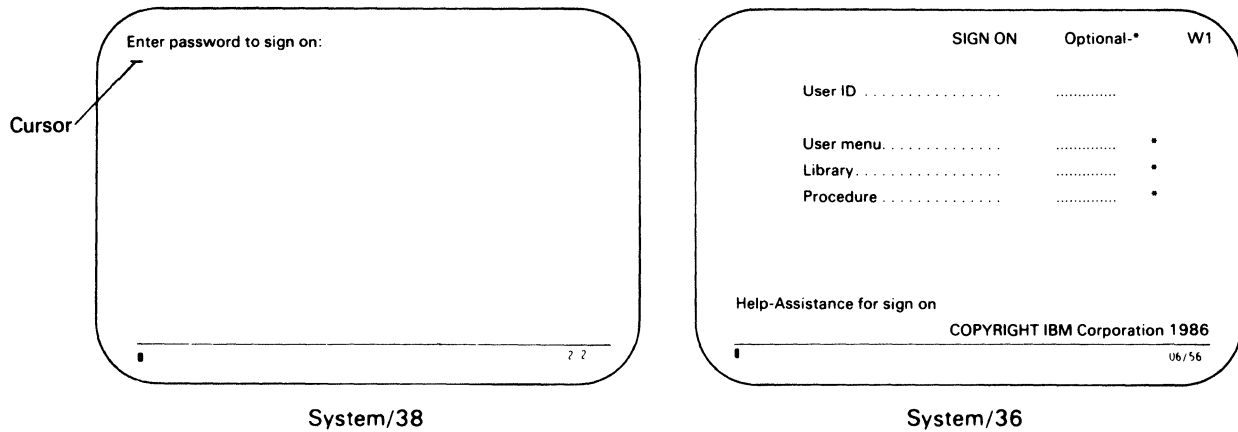

YES: Go to step 9.1.14.

NO: Go to step 9.1.17.

9.1.14. Which of the following terminal modes did you select?

- **One-Display Mode** → Go to step 9.1.18.
- **Two-Display Mode** → Go to step 9.1.15.
- **Display-Printer Mode** → Go to step 9.1.16.

9.1.15 Press and hold the Alt key, and then press the Jump key (blank key for the 122-key Keyboard or Page Up key for the IBM Enhanced Keyboard).

For the 122-key Typewriter Keyboard

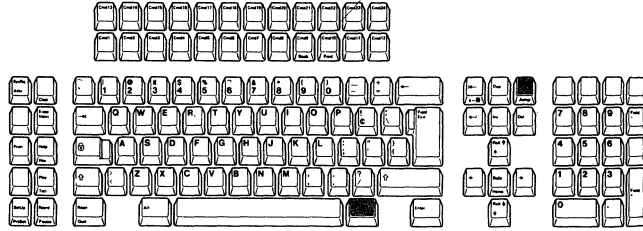
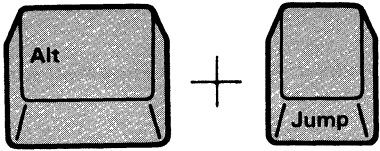

For the IBM Enhanced Keyboard

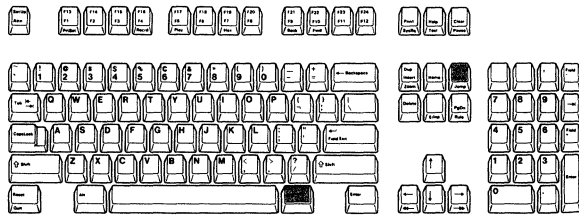
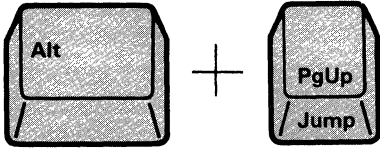

Does a sign-on display (similar to one of the two shown below) appear?

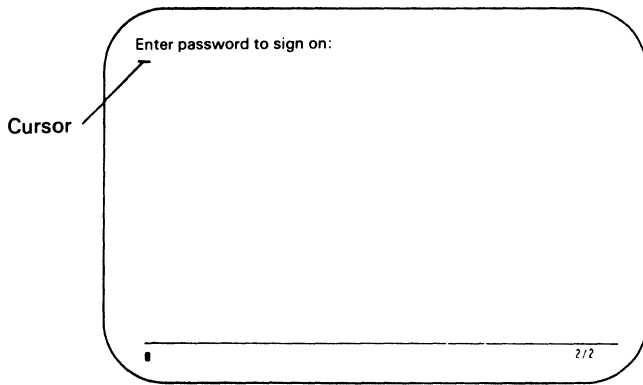

System/38

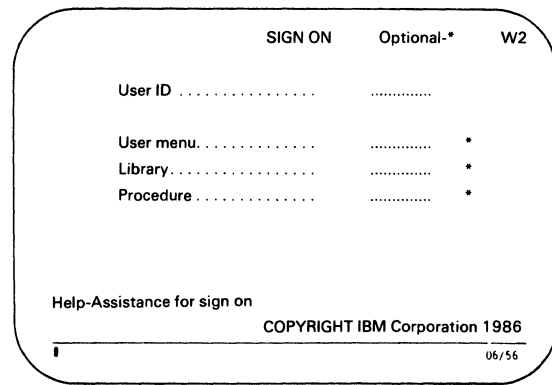

System/36

YES: Go to step 9.1.18.

NO: Go to step 9.1.17.

9.1.16 Press and hold the Alt key, and then press the PrtSet (SetUp key for the 122-key keyboard and F13/F1 key for the IBM Enhanced Keyboard) key.

For the 122-key Typewriter Keyboard

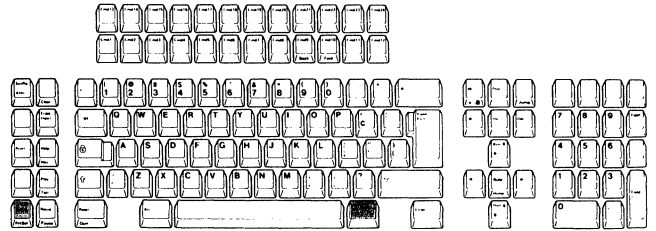
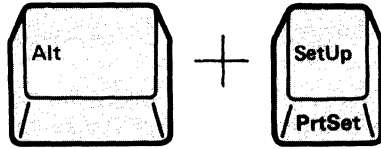

For the IBM Enhanced Keyboard

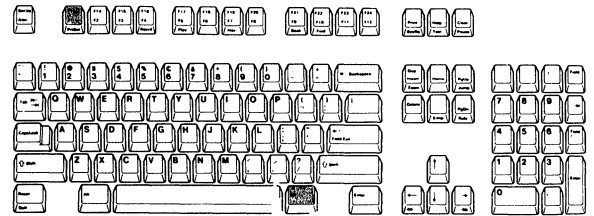
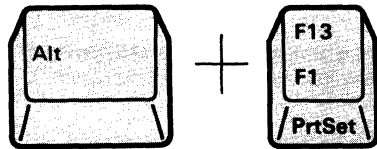

Is the Printer Setup Mode Symbol on the operating status line a  (Solid)?

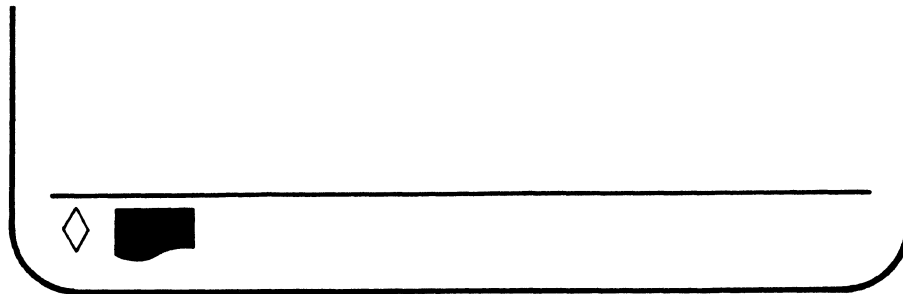

Yes: Press and hold the Alt key and press the PrtSet key, and then go to step 9.1.18.

No: The symbol is . Go to step 9.1.17.

9.1.17

1. Ask the person responsible for system operation to:
 - a. Check that the system to which your display station is connected is operating and is able to recognize your display station.
 - b. Check that your display station has the correct addresses.

Note: Your display may be on a cable where multiple workstations are cabled together. If so, check that each workstation on your cable has the correct address.

2. Set the power switch of your IBM 3197 and the printer (if attached) to O (off). Then make sure that the cables on your display station and the printer (if attached) are connected to the correct sockets and are tightly fastened.
3. If there is a workstation on the cable immediately before your IBM 3197 and it has a terminator switch, make sure that the terminator switch is set to 2. (See Appendix A in this guide for the locations of the terminator switches.)
4. Set the power switch of your IBM 3197 and the printer (if attached) to I (on).
5. Do the conditions in step 9.1.13 occur now?

YES: Go to step 9.1.14.

NO: Go to the *IBM 3197 Model D Problem Solving Guide*, GA18-2547.

9.1.18 Refer to your floor plan. Do you have another workstation (display station or printer) to connect to this display station?

YES: Go to step 9.1.19.

NO: Go to step 9.1.21.

9.1.19 Set the 3197 power switch to O (off) and disconnect the 3197 power cord from the power outlet.

9.1.20 Connect the second cable to the unused port of the auto-termination unit. The other end of this cable will connect to the next workstation.

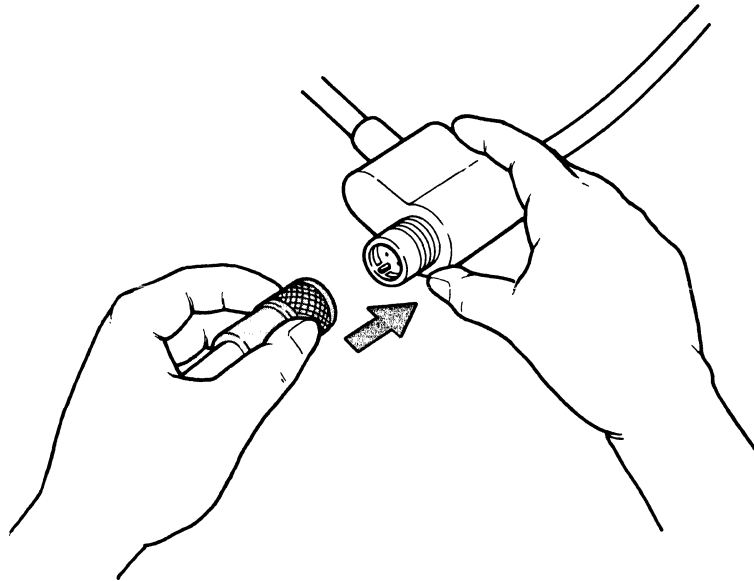

CAUTION

When a second cable is attached to the auto-termination unit, your IBM 3197 is un-terminated. Do not connect the second cable unless the other end is connected to another workstation.

9.1.21 Connect the 3197 power cord to a grounded electrical outlet.

9.1.22

Setup is complete on this display station.

If the communications cable will be connected to a 5294 Control Unit, go to the *IBM 5294 Control Unit Setup Procedure*, GA21-9369.

Appendix A. Location of Terminator Switches

The following illustrations show the location of the terminator switch on the display stations.

Note: Some display stations do not have a terminator switch.

IBM 5251 (Models 1 and 11)

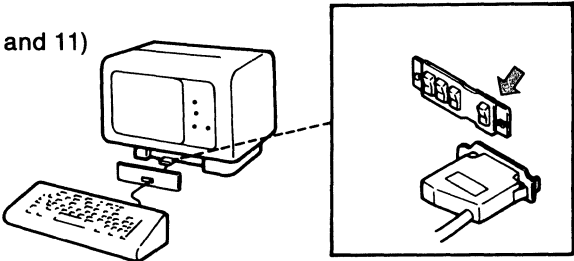

IBM 5291 (Model 1)

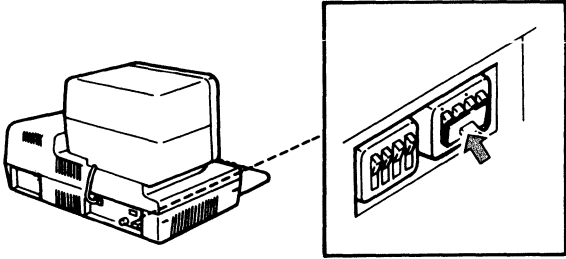

IBM 5291 (Model 2)

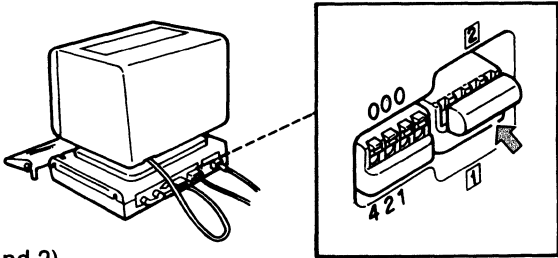

IBM 5292 (Models 1 and 2)

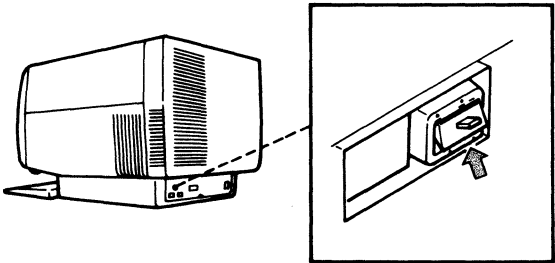

The following illustrations show the location of the terminator switch on printers.

IBM 5219

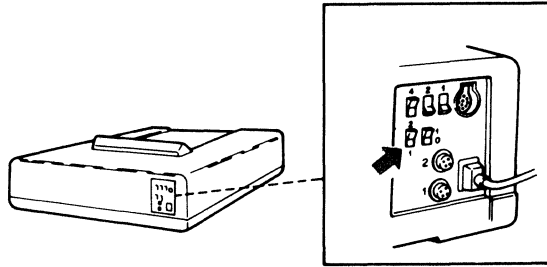

IBM 5244

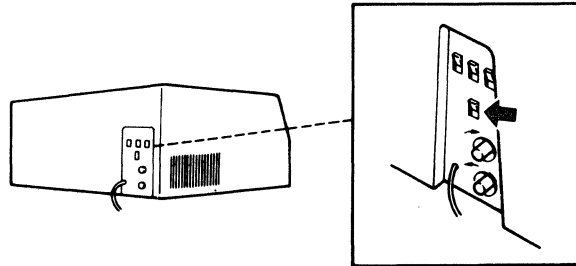

IBM 5225

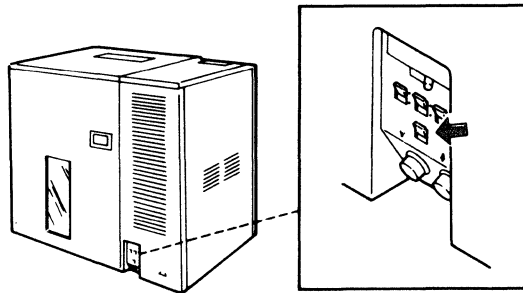

IBM 5256

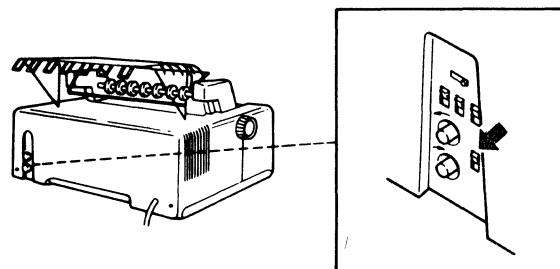

**IBM 3197 Model D Display Station
Setup Instructions
GA18-2546-1**

**READER'S
COMMENT
FORM**

This manual is part of a library that serves as a reference source for systems analysts, programmers, and operators of IBM systems. You may use this form to communicate your comments about this publication, its organization, or subject matter, with the understanding that IBM may use or distribute whatever information you supply in any way it believes appropriate without incurring any obligation to you.

Note: Copies of IBM publications are not stocked at the location to which this form is addressed. Please direct any requests for copies of publications, or for assistance in using your IBM system, to your IBM representative or to the IBM branch office serving your locality.

Possible topics for comment are:

Clarity Accuracy Completeness Organization Coding Retrieval Legibility

If you wish a reply, give your name, company, mailing address, and date:

Cut or Fold Along Line

What is your occupation? _____

Number of latest Newsletter associated with this publication: _____

Thank you for your cooperation. No postage stamp necessary if mailed in the U.S.A. (Elsewhere, an IBM office or representative will be happy to forward your comments or you may mail directly to the address in the Edition Notice on the back of the title page.)

Reader's Comment Form

Cut or Fold Along Line

IBM 3197 Model D Display Station Setup Instructions (File No. S5250/S36/S38-06) Printed in U.S.A. GA18-2546-1

Fold and tape

Please Do Not Staple

Fold and tape



BUSINESS REPLY MAIL

FIRST CLASS PERMIT NO. 40 ARMONK, N.Y.

POSTAGE WILL BE PAID BY ADDRESSEE

International Business Machines Corporation
 Department 6R1J
 180 Kost Road
 Mechanicsburg, PA 17055

NO POSTAGE
 NECESSARY
 IF MAILED
 IN THE
 UNITED STATES

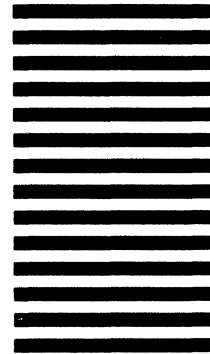

Fold and tape

Please Do Not Staple

Fold and tape

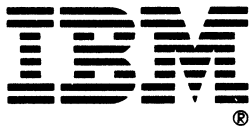

GA18-2546-1
Part Number 81X5370
File Number S5250/S36/S38-06

IBM 3197 Model D Display Station Setup Instructions (File No. S5250/S36/S38-06) Printed in U.S.A. GA18-2546-1

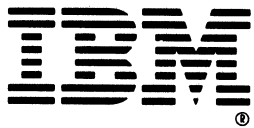

GA18-2546-01

