

GA23-0176-0
File No. S360/S370/S3/4300/8100-09

IBM 3270
Information Display System

3274 Control Unit
Customizing Guide

Configuration Support P
Validation Number 70

Systems

Models 1C, 31C, 51C

The IBM logo, consisting of the letters "IBM" in a bold, sans-serif font, with each letter formed by eight horizontal bars of varying lengths, creating a striped effect.

GA23-0176-0
File No. S360/S370/S3/4300/8100-09

**IBM 3270
Information Display System**

**3274 Control Unit
Customizing Guide**

**Configuration Support P
Validation Number 70**

Models 1C, 31C, 51C

Systems

IBM

First Edition (December 1983)

This publication is for planning only.

References in this publication to IBM products, programs, or services do not imply that IBM intends to make these available in all countries in which IBM operates. Any reference to an IBM program product in this publication is not intended to state or imply that only IBM's program product may be used. Any functionally equivalent program may be used instead.

Publications are not stocked at the address given below. Requests for IBM publications should be made to your IBM representative or to the IBM branch office serving your locality.

A form for readers' comments is provided at the back of this publication. If the form has been removed, address comments to IBM Corporation, Department 52Q, Neighborhood Road, Kingston, N.Y., U.S.A. 12401. IBM may use or distribute whatever information you supply in any way it believes appropriate without incurring any obligation to you.

Preface

This guide is written for customer personnel who are responsible for planning the customization of the IBM 3274 Control Unit with Configuration Support P. The information is organized into five chapters:

Chapter 1, "Introduction to Customizing," describes the customizing operation for Configuration Support P and the tasks that must be performed.

Chapter 2, "Preparing to Customize," addresses the planner. It describes the sequence numbers used when customizing for Configuration Support P. These sequence numbers are associated with functions and features of the 3274 and they guide you through the customization procedure.

Chapter 3, "Initial Customizing Procedure," addresses the operator who will perform the actual customization. It contains a form with the step-by-step procedure.

Chapter 4, "Procedure for Generating a Backup Diskette," addresses the operator who will customize a backup diskette. It contains a form with a step-by-step procedure.

Chapter 5, "Modification Procedure," addresses the operator who will perform the modification. It contains a form with the step-by-step procedure.

To complete customization, you will need to refer to information contained in the *IBM 3270 Information Display System: 3274 Control Unit Planning, Setup, and Customizing Guide*, GA27-2827.

Contents

Chapter 1. Introduction to Customizing 1-1

- Planning and Setup 1-1
- Configuration Support P 1-1
 - X.25: A Brief Description 1-1
 - Customizing for X.25 1-2
- Customizing the 3274 Control Unit 1-3
 - A Backup Diskette 1-4
 - Modifying a Customized Diskette 1-4
 - Subsystem Verification 1-4
 - 3274 Model 31C and 51C Switch Settings 1-4
- Preparation for Customizing 1-5

Chapter 2. Preparing to Customize for Configuration Support P 2-1

- Initial Customizing Questions 2-1
 - 001: Keyboard Validation 2-1
 - 011: Patch Request 2-1
 - 021: Printer Authorization Matrix 2-1
 - 031: RPQ Diskettes Required 2-2
- Sequence Number 999 Panel 2-2
 - 111: Number of Category B Terminals 2-3
 - 112: Number of Category A Terminals 2-3
 - 113: Storage 2-4
 - 121: Keyboard Language/Character Set I/O Interface Code 2-5
 - 141: Magnetic Character Set 2-5
 - 151: 3274 Model Designation 2-6
 - 161: Color Convergence 2-6
 - 213: Between Bracket Printer Sharing 2-6
 - 215: Physical Unit Identification (PUID) 2-6
 - 302: X.25 Secondary Station Address 2-6
 - 311: Modem Wrap (External Modem Only) 2-6
 - 343: Communication Interface Options 2-7
 - 900: Entry Acceptance 2-7
- Sequence Number 332 Panel (X.25) 2-7
 - Sequence Number 332: X.25 Customization Panel 2-7
 - 400: Network Type 2-9
 - 401: Circuit Type (I/O) 2-9
 - 402: Logical Channel Identifier 2-9
 - 403: Logical Link Control 2-9
 - 410: Host DTE Address (HNAD) 2-9
 - 411: 3274 DTE Address 2-10
 - 420: Incoming Call Options (IOPT) 2-10
 - 421: Outgoing Call Options (OOPT) 2-11
 - 430: Negotiated Packet Size (NPKT) 2-11
 - 431: Packet Sequence Numbering 2-12
 - 432: Negotiated Window Size (NWND) 2-12
 - 433: K-Maximum Out 2-12
 - 434: Nonstandard Default Packet Size (DPKT) 2-12
 - 435: Nonstandard Default Window Size (DWND) 2-13
 - 440: Throughput Class Negotiation (TCLS) 2-13
 - 441: Closed User Group (CUG) 2-14
 - 442: Recognized Private Operating Agency (RPOA) 2-14
 - 443: X.25 Keyboard Support Options 2-14
 - 450: Link LVL Transmit Timeout 2-15
 - 451: Number of Retries 2-16
 - 452: CID Password (CID) 2-16
 - 908: X.25 Customization Acceptance 2-16

Chapter 3. Initial Customizing Procedure 3-1

- Initial Customizing Procedure Form 3-3
- Printer Authorization Matrix Form 3-23

Chapter 4. Procedure for Generating a Backup Diskette 4-1

- Backup Diskette Procedure Form 4-3

Chapter 5. Modification Procedure 5-1
Modification Procedure Form 5-3
Printer Authorization Matrix Form 5-21

List of Abbreviations X-1

Index X-3

Figures

- 1-1. Configuration Support P: Information Needed 1-7
- 2-1. Sequence Number 999 Panel before Customization 2-2
- 2-2. Quantity Relationships of 3274 Model 31C and 51C Category A and B Terminals 2-4
- 2-3. Configuration Support P Keyboard Language and Character Set I/O Interface Codes 2-5
- 2-4. Sequence Number 332 Panel 2-8
- 3-1. Valid Key Positions during Customizing 3-17
- 3-2. Valid Key Positions during Customizing When Japanese Katakana and Japanese English Keyboards Are Used 3-18
- 3-3. Operator Codes during Customizing Only 3-19
- 3-4. Steady 8 4 2 1 Indicator Codes during Customizing Only 3-20
- 3-5. Flashing 8 4 2 1 Indicator Codes during Customizing Only 3-21
- 3-6. 8 4 2 1 Indicator Codes during IML That May Result from an Incorrect Customizing Procedure 3-22
- 4-1. Valid Key Positions during Backup Diskette Generation 4-13
- 4-2. Valid Key Positions during Backup Diskette Generation When Japanese Katakana and Japanese English Keyboards Are Used 4-14
- 4-3. Operator Codes during Backup Diskette Generation Only 4-15
- 4-4. Steady 8 4 2 1 Indicator Codes during Backup Diskette Generation Only 4-16
- 4-5. Flashing 8 4 2 1 Indicator Codes during Backup Diskette Generation Only 4-17
- 4-6. Flashing 8 4 2 1 Indicator Codes during IML That May Result from an Incorrect Customizing Procedure 4-18
- 5-1. Valid Key Positions during the Modification Procedure 5-15
- 5-2. Valid Key Positions during the Modification Procedure When Japanese Katakana and Japanese English Keyboards Are Used 5-16
- 5-3. Operator Codes during the Modification Procedure Only 5-17
- 5-4. Steady 8 4 2 1 Indicator Codes during the Modification Procedure Only 5-18
- 5-5. Flashing 8 4 2 1 Indicator Codes during the Modification Procedure Only 5-19
- 5-6. 8 4 2 1 Indicator Codes during the IML That May Result from an Incorrect Customizing Procedure 5-20

Chapter 1. Introduction to Customizing

This book will help you plan the customization of your 3274 Control Unit with Configuration Support P. During the customization procedure, the operator types in responses to a sequentially numbered series of questions (called *sequence numbers*) that appear on the display screen. These sequence numbers are associated with the functions and features of the 3274. Chapter 2 explains the sequence numbers for the Configuration Support P customization procedure. Once you are familiar with the sequence numbers and have chosen the responses necessary for your configuration, mark the responses on a form for the operator to use during customization.

Planning and Setup

The information you need for planning and setup is contained in the *3274 Control Unit Planning, Setup, and Customizing Guide*, GA27-2827.

Configuration Support P

Configuration Support P is available for Models 1C, 31C, and 51C only. This configuration level enables these remote models to communicate via the X.25 communication network. The control storage requirement is 128K bytes (K equals 1024), sufficient for all the functions and features available with Configuration Support P. Distributed function terminals cannot attach to a 3274 Control Unit using Configuration Support P. Terminals in this category are the IBM 3290 Information Panel and the IBM 3270 Personal Computer.

Configuration P supports base color on the attached terminals and the solicitation of summary maintenance statistics from a 3274 Model 1C/Systems Network Architecture (SNA), 31C/SNA, and 51C/SNA through the use of Network Problem Determination Application (NPDA). In addition, these base functions are supported:

- Synchronous Data Link Control (SDLC)/X.25
- High-performance communication adapter (HPCA)
- Local copy
- Host-loadable printer authorization matrix
- 3289 text print control
- SCS printer support
- Error checking and correction (ECC)
- 3178, 3278, and 3279 keyboards.

X.25: A Brief Description

The 3274 X.25 attachment capability enables remote models of the 3274 Control Unit to attach to host systems via an X.25 network, using the protocols defined in the IBM X.25 Data Terminal Equipment/Data Circuit-Terminating Equipment (DTE/DCE) Interface architecture. SNA data is transmitted with these X.25 protocols, identical with existing 3274 SNA attachments. (For more information, refer to *X.25 Interface for Attaching IBM SNA Nodes to Packet-Switched Data Networks*, GA27-3345.) The International Telegraph and Telephone Consultative Committee (CCITT) Recommendation X.25 defines the interface

between local DTE and DCE for attaching data terminal equipment to packet-switched data networks (PSDNs). Packet-switched data networks consist of switching nodes and high-speed transmission links between these nodes.

Users connect their DTE to the DCE via a communication circuit. The DTE attached to a packet-switched data network can be a host processor, a cluster control unit, or a terminal that is sending and receiving data. The DCE is provided by the carrier and located near the DTE.

X.25 defines an interface between a user's DTE and the DCE in the packet network. When using X.25 protocols, the network includes:

- The 3274 Control Unit
- An operator at a 3278, 3279, or equivalent display station with keyboard, that is attached to the 3274
- The X.25 network
- A network interface adapter, or equivalent
- A host central processing unit (CPU)
- An access method, such as virtual telecommunications access method (VTAM)
- Host CPU application programs.

Packets are the basic information unit transmitted through a packet network. For transmission via the network, data is formatted into packets of fixed maximum length. Packet sizes range in the order of 64, 128, 256, and 512 bytes, depending on the particular packet network. The most common size is 128 bytes. In addition to data packets, various types of control packets (for example, a call request packet) can be sent between a DTE and an adjacent DCE.

A logical channel identifier in the packet header associates the packet with a permanent or switched virtual circuit, allowing the network to control the routing of the packet to the receiving DTE. The data packets entering the DCE are routed over the internal packet network to a destination DCE, and the communication processors then route the data to the destination DTE.

For further description of the X.25 function, refer to the *IBM 3270 Information Display Systems X.25 Operation*, GA23-0178.

Customizing for X.25

Customizing the 3274 Control Unit for X.25 involves defining the packet formats and control procedures for the exchange of packets between the DTE and the DCE. Control procedures include establishing and clearing calls, data transfer, flow control, and error recovery.

An X.25 network subscription can include many different facilities. To customize your 3274 Control Unit for X.25 support, you need a copy of your firm's X.25 network subscription, detailing which facilities your subscription includes. The 3274 supports these facilities and provides customizing questions for them:

- Closed user group
- Connection identifier

- Extended packet sequence numbering
- Flow control parameter negotiation (window and packet size)
- Nonstandard default window size
- Nonstandard default packet size
- One-way logical channel out
- One-way logical channel in
- Recognized private operating group selection
- Reverse charging
- Reverse charging acceptance
- Throughput class negotiation.

Customized values for certain X.25 facilities can be modified during the Dial procedure. To allow the values to be changed, for sequence number 443 you must set bit 5 equal to 0 (“display all fields”).

Customizing the 3274 Control Unit

With the 3274 Control Unit, you specify the configuration under which it operates; this is called *customization*. The configuration information is stored on the system diskette mounted inside the 3274, enabling the 3274 to control all the terminals attached to it. The system diskette, delivered with the 3274, also contains the microcode to direct control unit functions and perform diagnostic routines to test the 3274 prior to operating it. But before this diskette can function in your system, you must customize by writing your configuration information on it.

For the initial customization of the system diskette, the operator types in the system parameters at a 3178, 3278, or 3279 display station attached to port A0 of the 3274. As a result of this procedure, a unique configuration table is written on the diskette. In daily operations, the operator inserts this customized diskette in the 3274, presses the On/Off switch to the On position, and then presses the IML (initial microcode load) pushbutton. The 3274 then executes the diagnostic routines stored on the diskette. Upon successful completion of these tests, the 3274 is loaded with the configuration data that was stored on the system diskette during customization. System operation can now begin.

Customizing a 3274 Control Unit usually involves a planner and an operator responsible for performing the customization procedure. The planner identifies and compiles the configuration information needed, enters it on the *Initial Customizing Procedure Form*, and gives the form to the operator. In Chapter 2 you will find a description of the Configuration P sequence numbers and the possible responses that can be entered on the *Initial Customizing Procedure Form*.

During customization, the operator reads the *Initial Customizing Procedure Form* and types in the responses to the customization sequence numbers at a 3178, 3278, or 3279 display station attached to port A0 of the 3274. The display station should be near the 3274 during customization because certain indicator

lights on the 3274 must be observed. (If the operator will be using a 3279 Color Display Station, a color convergence procedure may have to be performed before customization. Appendix E in the *3274 Control Unit Planning, Setup, and Customizing Guide*, GA27-2827, describes the color convergence procedure.)

The operator also uses a *feature* diskette, and often a *language* diskette, during the customizing procedure. The language diskette is used to customize the system diskette for languages other than English (U.S.), Canadian (Bilingual), Canadian French – which are all extended binary-coded decimal interchange code (EBCDIC) – and American National Standard Code for Information Interchange (ASCII) (U.S. English, available in the U.S. only). The feature diskette is used to customize the system diskette for all other cluster parameters. The procedure form in Chapter 3 indicates for the operator when to insert the necessary diskettes and how to type in the responses to the sequence numbers.

A Backup Diskette

Each 3274 Control Unit is shipped with two uncustomized system diskettes. After you customize one diskette, you can customize a second, backup, diskette. Chapter 4 contains the *Backup Diskette Procedure Form*.

Modifying a Customized Diskette

After you have completed the initial customization of the 3274, at a later date you may wish to modify the existing configuration. Chapter 5 contains the *Modification Procedure Form*.

Subsystem Verification

After customizing has been completed, all devices have been attached to the 3274, and an initial microcode load (IML) of the subsystem has been performed, the next step is to verify that the control unit can reach all the attached terminals. The “Subsystem Verification Procedure” is presented in Appendix D of the *3274 Control Unit Planning, Setup, and Customizing Guide*, GA27-2827. Following this procedure, the operator will:

1. Verify the number of Category A and Category B devices configured.
2. Determine whether a device is powered on or off.
3. Determine whether a device has been disabled as a result of a device error.

The planner should give Appendix D to the operator who will perform the customizing procedure.

3274 Model 31C and 51C Switch Settings

You may need to set various switches on the 3274 Models 31C and 51C prior to operating the control unit.

- To set these switches for Model 31C, refer to Appendix G of the *3274 Control Unit Planning, Setup, and Customizing Guide*, GA27-2827.
- To set these switches for the Model 51C, refer to Appendix H of the *3274 Control Unit Planning, Setup, and Customizing Guide*, GA27-2827.

Give the operator who will perform the customization the necessary instructions for setting switches.

Preparation for Customizing

To prepare for customizing, the planner should:

1. Obtain a copy of the X.25 network subscription.
2. Use the sequence number descriptions in Chapter 2 and the *Initial Customizing Procedure Form* in Chapter 3, to compile the information needed for customizing and fill in the form. Figure 1-1 summarizes the sequence numbers.
3. Identify each diskette. A label in the upper right corner of the diskette identifies the diskette type by name, IBM part number, and validation number. The IBM part numbers are:

Feature diskette	6062691
System diskette	6062693
Language diskette	5718440

In addition, you may want to write a unique designation of your own on the label. For example, you could specifically identify it according to the configuration and the 3274 Control Unit in which it is to be customized and used.

4. Enter the responses for every step and sequence number listed on the *Initial Customizing Procedure Form*.
5. Fill out the Printer Authorization Matrix Form at the end of Chapter 3, if it will be used, or if changes will be made to the existing matrix.
6. Give the following information to the operator who will customize the 3274 (you may wish to check off the items you will need):
 - The Color Convergence Procedure (if necessary): Appendix E of the *3274 Control Unit Planning, Setup, and Customizing Guide, GA27-2827*
 - The completed *Initial Customizing Procedure Form*: a multipage form found in Chapter 3 of this book
 - The keyboard layout showing the valid customization keys for the keyboard the operator will be using: Chapter 3 of this book
 - The completed Printer Authorization Matrix Form (if necessary): the form is in Chapter 3 of this book. Information on how to define the printer authorization matrix is located in Appendix C of the *3274 Control Unit Planning, Setup, and Customizing Guide, GA27-2827*.
 - The "Operator Codes" Chart (Figure 3-3)
 - The "8 4 2 1 Indicator Codes" charts (Figures 3-4 and 3-5)
 - Feature and system diskettes

- Language diskette (if necessary)
- RPQ diskette(s) (if necessary)
- The Subsystem Verification Procedure: Appendix D of the *3274 Control Unit Planning, Setup, and Customizing Guide, GA27-2827*
- Instructions for setting Model 31C switches (if necessary): Appendix G of the *3274 Control Unit Planning, Setup, and Customizing Guide, GA27-2827*
- Instructions for setting Model 51C switches (if necessary): Appendix H of the *3274 Control Unit Planning, Setup, and Customizing Guide, GA27-2827*

It may be convenient for the planner at the central or host location to prepare the *Initial Customizing Procedure Form(s)* for several 3274s at other locations and to forward the forms to each location.

Sequence Number	Function	Notes	Response Definition
001	Keyboard validation	1	—
011	Patch request	1	—
021	Printer authorization matrix	2	0 = No 1 = Yes
022	Printer authorization matrix specification	1	See Chapter 2.
031	RPQ diskettes required	3	0 = Not required 1 = One diskette required 2 = Two diskettes required 3 = Three diskettes required
111	Number of Category B terminals	—	See Chapter 2.
112	Number of Category A terminals	—	See Chapter 2.
113	Extended function store	3	See Chapter 2.
121	Keyboard character set language	3	See Chapter 2.
141	Magnetic character set	3	A = No B = Numeric (3277-compatible) C = Alphanumeric (auto entry for nondisplay data) D = Alphanumeric (auto entry for all data)
151	3274 model designation	3	01C, 31C, 51C
161	Color convergence	3	0 = No 1 = Yes
213	Between bracket printer sharing	2	0 = No 1 = Yes
215	Physical unit identification (PUID)	2	See Chapter 2.
302	X.25 secondary station address	2	See Chapter 2.
311	Modem wrap	3	0 = Not possible 1 = Possible
343	Communication interface options	3, 4	See Chapter 2.
400	Network type	5	00 = CCITT 02 = UKPASS or TELENET
401	Circuit type	5	1 = PVC 2 = Incoming SVC 3 = Outgoing SVC 4 = Two-way SVC
402	Logical channel identifier	5	See Chapter 2.
403	Logical link control	5	0 = PSH 1 = QLLC
410	Host DTE address	5	See Chapter 2.
411	3274 DTE address	5	See Chapter 2.

Figure 1-1 (Part 1 of 2). Configuration Support P: Information Needed

Sequence Number	Function	Notes	Response Definition
420	Incoming call options	5	See Chapter 2.
421	Outgoing call options	5	See Chapter 2.
430	Negotiated packet size	5	0 = 64-byte packet 1 = 128-byte packet 2 = 256-byte packet 3 = 512-byte packet
431	Packet sequence numbering	5	0 = modulo 8 1 = modulo 128
432	Negotiated window size	5	See Chapter 2.
433	K-maximum out	5	See Chapter 2.
434	Nonstandard packet size	5	0 = 64-byte packet 1 = 128-byte packet 2 = 256-byte packet 3 = 512-byte packet
435	Nonstandard window size	5	See Chapter 2.
440	Throughput class negotiation	5	See Chapter 2.
441	Closed user group	5	See Chapter 2.
442	Recognized private operating agency	5	See Chapter 2.
443	X.25 keyboard support	5	See Chapter 2.
450	Link LVL transmit timeout	5	See Chapter 2.
451	Number of retries	5	See Chapter 2.
452	CID password	5	See Chapter 2.

Notes:

1. Information is already identified on the Initial Customizing Procedure Form.
2. Obtain information from the system programmer.
3. Obtain information from equipment orders placed with IBM, with the common carrier, and (if necessary) with the modem manufacturer.
4. This parameter must be compatible with the host-system communication controller and/or with the modem.
5. Obtain information from your X.25 network subscription.

Figure 1-1 (Part 2 of 2). Configuration Support P: Information Needed

Chapter 2. Preparing to Customize for Configuration Support P

This chapter describes the sequence numbers that require responses when you are customizing for Configuration Support P. Fill in your responses on the *Initial Customizing Procedure Form* from Chapter 3 and on the *3274 Configuration Data Card (Configuration Support: P)*, GA23-0177. When you need to prepare a *Modification Procedure Form*, in Chapter 5, refer to this chapter for an explanation of the sequence numbers and their responses.

Initial Customizing Questions

The first four questions are displayed on the screen one at a time.

001: Keyboard Validation

The purpose of this question is to verify that a valid keyboard is attached to the control unit, and that all of its keys used in customization are working properly.

The response is already entered on the forms the operator will use. The last two digits of the response, following the space, identify the validation number that must be used with the customizing procedure. This number must be equal to or greater than the validation number on the feature and system diskette labels.

Note: If a data entry keypunch keyboard is used, the New Line key is pressed when ENTER is specified. Also, the PF10 key is pressed when New Line is required. The chapters for initial customizing, modification, and generating a backup diskette each contain charts showing the valid key positions. Be sure to specify the keyboard type, for the operator, on the appropriate procedure form.

011: Patch Request

The response required for this sequence number is already entered in Step 6 on the *Initial Customizing Procedure Form* in Chapter 3. The service representative may use this sequence number to make a diskette patch request.

021: Printer Authorization Matrix

Enter the response that applies to your system:

1 = Yes
0 = No

If you wish to specify a printer authorization matrix, enter a 1. This will cause sequence number 022 to be displayed. This matrix will be established for each 3274 IML. Fill out the *Printer Authorization Matrix Form* at the end of Chapter 3 for initial customization, or the form at the end of Chapter 5 for modifying a configuration. Information on how to define the printer authorization matrix is located in Appendix C of the *3274 Control Unit Planning, Setup, and Customizing Guide*, GA27-2827.

Enter a 0 if any of these conditions applies:

- The printer authorization matrix will be entered *only* by a host application program.

- All printers will be used in system mode, and local copy operations are not desired.
- No printers will be attached to the system.

When 021 is answered with a 1, the next sequence numbers are:

022: Printer Authorization Matrix Specification

The operator will enter the information specified on the Printer Authorization Matrix Form.

901: Printer Authorization Matrix Acceptance

Sequence number 901 appears as part of the sequence number 022 panel (the printer authorization matrix display). This sequence number prompts the operator to enter a 1 after checking all the responses entered. If the 3274 detects unacceptable responses, it automatically changes the 1 back to a 0 and intensifies the brightness of the invalid entries.

031: RPQ Diskettes Required

Enter the number of RPQ diskettes required. No more than three may be specified: 0, 1, 2, or 3.

Sequence Number 999 Panel

The next series of customizing questions are grouped together in one panel that is displayed on the screen. (See Figure 2-1.) When the panel first appears on the screen, some of the response fields are filled with Xs, and default values are supplied for the rest. You must enter a response in any field filled with Xs.

Enter the appropriate responses for your system on the sequence number 999 layout in the *Initial Customizing Procedure Form*.

```

999
111 - 00    112 - XX    113 - XX
121 - XX    141 - A
151 - XXX   161 - 1
213 - 0     215 - 00000
302 - XX    311 - 0     343 - XX
900 - 0

```

Figure 2-1. Sequence Number 999 Panel before Customization

111: Number of Category B Terminals

Specify the number of Category B terminals that can be attached to your 3274, in multiples of 4 (00 to 16). The actual number you have attached at any given time may be smaller than the multiple of 4 that you specify:

- A 2-digit number must be entered. If necessary, use a leading zero. For example, specify 08 for 8.
- Category B terminals:
 - 3277 Models 1 and 2
 - 3284 Models 1 and 2
 - 3286 Models 1 and 2
 - 3287 Models 1 and 2 with the 3271/3272 Attachment (feature 8330)
 - 3288 Model 2

112: Number of Category A Terminals

Specify the number of Category A terminals that can be attached to your 3274, in multiples of 8. The actual number that you have attached at any given time may be smaller than the multiple of 8 that you specify. Enter a 2-digit number (08–32).

- Check that the sum of the number of Category A and B terminals does not exceed 32. If the sum exceeds 32:
 1. For sequence number 111, specify *the actual number* of attached Category B terminals.
 2. Then, for sequence number 112, specify the difference between 32 and the response to sequence number 111 (actual number of attached Category B terminals)

Example: If you had 13 Category B terminals and 17 Category A terminals:

Sequence number 111 would be specified as 13.

Sequence number 112 would be specified as 19 (32 minus 13).

Figure 2-2 shows the relationship between the quantities of Category A and B terminals. Note that, when Category A terminal adapters are added or removed, the host-recognized address of port B0 changes.

- A 2-digit number must be entered. If necessary, use a leading zero; for example, specify 08 for 8.
- Category A terminals:
 - 3178 Models 1 and 2
 - 3230 Model 2
 - 3262 Models 3 and 13
 - 3268 Models 2 and 2C
 - 3278 all models
 - 3279 all models
 - 3287 Models 1 and 2 with the 3274/3276 Attachment (feature 8331)
 - 3287 Models 1C and 2C
 - 3289 Models 1 and 2
 - 5210 Models G01 and G02

		Number of Category A Terminals																																Adapter Type
Quantity		Base								A1								A2								A3								
		1	2	3	4	5	6	7	8	9	10	11	12	13	14	15	16	17	18	19	20	21	22	23	24	25	26	27	28	29	30	31	32	
0		Specify: A08 and B00								Specify: A16 and B00								Specify: A24 and B00								Specify: A32 and B00								
Number of Category B Terminals	1	Note: The 51C is limited to eight A devices and four B devices. Specify: A08 and B04 B0=08*								Specify: A16 and B04 B0=16*								Specify: A24 and B04 B0=24*								Specify: 32-B=A B0=28*								B0=31*
	2																									B0=30*								
	3																									B0=29*								
	4																									B0=27*								
	5	Specify: A08 and B08 B0=08*								Specify: A16 and B08 B0=16*								Specify: A24 and B08 B0=24*								B0=26*								B0=25*
	6																									B0=23*								
	7																									B0=22*								
	8																									B0=21*								
	9	Specify: A08 and B12 B0=08*								Specify: A16 and B12 B0=16*								Specify: 32-B=A B0=19*								Not Permitted								
	10																									B0=20*								
	11																									B0=18*								
	12																									B0=17*								
	13	Specify: A08 and B16 B0=08*								Specify: A16 and B16 B0=16*								Specify: 32-B=A B0=17*																
	14																																	
	15																																	
	16																																	
		Adapter Type																																

*The host-recognized port addresses are sequential, with the first Category A port (port A0) always being address 0 (with the exception of SNA, which is always 02). The first Category B port (port B0) is always the next sequential address after the last Category A port.

Figure 2-2. Quantity Relationships of 3274 Model 31C and 51C Category A and B Terminals

113: Storage

For Configuration Support P, 128K bytes of storage is the only amount allowable.

- Model 1C: Enter either 98 or 99.
 - 98 = Extended Function Store types C1 (feature 3622), C3 (feature 3625), and D2 (feature 3628) are installed.
 - 99 = Extended Function Store types C2 (feature 3623) and D2 (feature 3628) are installed.
- Model 31C: Enter D0.
- Model 51C: Enter C0 or D0.
 - C0 = Extended Function Store types D1 (feature 3630) and D3 (feature 3631) are installed.
 - D0 = Extended Function Store type D2 (feature 3632) is installed, or Extended Function Store type D4 (feature 1800) is installed.

121: Keyboard Language/Character Set I/O Interface Code

Enter a 2-digit number (01 to 28) to specify the keyboard language and character set I/O interface code being used. (See Figure 2-3.) A 2-digit number must be used. If necessary, use a leading zero; for example, enter 07 to specify 7.

Response	Keyboard Language	I/O Interface Code
01	English (U.S.)	English (U.S.)
02	ASCII	English (U.S.) ASCII
03	Austrian/German	Austrian/German
04	Belgian	Belgian
05	Brazilian	Brazilian
06	Canadian (French)	Canadian (French)
07	Danish	Danish/Norwegian
08	Danish	Danish/Norwegian (alternate)
09	Finnish	Finnish/Swedish
10	Finnish	Finnish/Swedish (alternate)
11	French (QWERTY)	French
12	French (AZERTY)	French
13	Austrian/German	Austrian/German (alternate)
14	International	International
15	Italian	Italian
16	Japanese (English)	Japanese (English)
17	Japanese (Katakana)	Japanese (Katakana)
18	Portuguese	Portuguese
19	Spanish	Spanish
20	Spanish	Spanish (alternate)
21	Spanish-speaking	Spanish-speaking
22	English (U.K.)	English (U.K.)
23	Norwegian	Danish/Norwegian
24	Swedish	Finnish/Swedish
25	EBCDIC (WT)	English (U.S.)
26	Norwegian	Norwegian (alternate)
27	Swedish	Finnish/Swedish (alternate)
28	Portuguese	Portuguese (alternate)

Notes:

1. Keyboard layouts and character set interface code information are given in *IBM 3270 Information Display System: Character Set Reference, GA27-2837*.
2. Select an alternate character set I/O interface code only when compatibility with the 3271/3272/3275 data base is required. To facilitate later migration, all systems should be upgraded to the latest 3270 support level.

Figure 2-3. Configuration Support P Keyboard Language and Character Set I/O Interface Codes

141: Magnetic Character Set

Enter the response that applies to your system:

A = None

B = Numeric (3277-compatible)

C = Alphanumeric (auto entry for secure data only)

D = Alphanumeric (auto entry for all data)

151: 3274 Model Designation

Enter the 3274 model type for which you are customizing:

01C, 31C, or 51C.

161: Color Convergence

Enter a 0 if:

- In U.S. and Canada only, the 3279 Color Display Stations attached are *all* model S2A, S2B, or 02X with serial number E0000 or higher, or
- No 3279 Color Display Stations are attached.

Enter a 1 if any other 3279 Color Display Stations are attached.

213: Between Bracket Printer Sharing

1 = Allow between bracket printer sharing.

0 = Do not allow it.

215: Physical Unit Identification (PUID)

The physical unit identification is a 5-character code that identifies the control unit to the host in response to an SDLC XID command. The PUID is required when the 3274 will be used on a switched data link.

If the PUID is used, each control unit in a network should be assigned a unique PUID. Obtain the PUID from the system programmer.

If the PUID is not used in your system, enter 00000.

302: X.25 Secondary Station Address

Enter the 2-character hexadecimal secondary address. This is the address by which the 3274 is identified at the logical link control level. The address should be available from the system programmer.

311: Modem Wrap (External Modem Only)

Enter a 1 if the modem is capable of a DTE-initiated automatic wrap test; enter a 0 if not. The DTE is the 3274 Control Unit. (The wrap test is initiated by the test (DTE) control signal via pin 18 from the 3274 Control Unit.)

If an IBM 3863, 3864, 3865, 3872, 3874, or 3875 modem is used, enter a 1 if the test (DTE) control signal was activated at the time of modem installation.

The Wrap Feature: Determine whether the modem permits data to be wrapped under the control of the 3274 Control Unit or whether the modem has a switch to control the wrap function. If the modem has the wrap capability and wrapping can be controlled from the 3274 Control Unit, this method is recommended.

Enter a 0 if you are unable to determine whether your modem has the wrap option activated. Note, however, that this may require you to recustomize at a later date if you determine that the modem does have the wrap option activated and wish to use the wrap capability.

343: Communication Interface Options

Enter the number of the communication interface that the customized 3274 will use:

00 = CCITT V.35 or V.24 interface/external modem interface
(nonswitched)

01 = DDS adapter

03 = X.21 leased

900: Entry Acceptance

Sequence number 900 appears as part of the sequence number 999 panel. This sequence number prompts the operator to enter a 1 after he or she has checked the entries. If the 3274 detects incorrect responses, it automatically changes the 1 back to a 0, intensifies the brightness of the incorrect entries, and displays an operator code that indicates the incorrect information.

Sequence Number 332 Panel (X.25)

After you have entered all the responses for the sequence number 999 panel and they are accepted, the screen clears and the sequence number 332 panel is displayed on the screen. This is the X.25 Customization Panel, which has 21 customizing questions. Your X.25 network subscription contains the answers to these questions.

Sequence Number 332: X.25 Customization Panel

Figure 2-4 shows how the X.25 panel is first displayed, before any responses are entered. In the upper right corner, your secondary station address will replace the two #s (for example, 01). Your 3274 Control Unit model designation (for example, 51C) will be displayed instead of the three Xs.

332				##/XXX/X25
400 - 00	401 - 4	402 - XXXX	403 - 1	
410 - NNNNNNNNNNNNNNNN			411 - NNNNNNNNNNNNNNNN	
420 - 00000000			421 - 00000000	
430 - 1	431 - 0	432 - 02	433 - 2	
434 - 1		435 - 02		
440 - 9	441 - NN	442 - NNNN	443 - 10100100	
450 - XXXX		451 - XX	452 - NNNNNNNN	
				908 - 0

Figure 2-4. Sequence Number 332 Panel

Looking at the response fields, you will see that some are filled with Xs and Ns, and that default values are supplied for the rest.

X indicates that a response to this question is required.

N indicates that a response is not required. This question is a sequel to another question. Your response to the first question dictates whether this sequel needs to be answered. For example, if your response to question 401 (circuit type) is 1 (permanent virtual circuit), then no response is necessary for questions 410 and 411 (host and 3274 DTE address). If no response is necessary, the operator can just leave the Ns in the response field.

If **default values** are provided, the operator can override the default value with a different response during customization. If a default value is provided for a facility to which you do not subscribe, leave the default value unchanged.

Enter the appropriate responses for your system on the sequence number 332 panel layout in the *Initial Customizing Procedure Form*. We suggest that you answer these questions first:

- 400, 401, 402, 403, 420, 421, 450, and 451.

Then examine the remaining questions.

400: Network Type

This input field defines the network type supported. The default value is 00. If IBM has announced X.25 support for your country's network, and it is not one of the networks specified below, use the default value:

- 00 = CCITT recommended network with announced IBM support not listed below (default).
- 02 = Connection is to UKPSS or TELENET.

401: Circuit Type (I/O)

This input field indicates the type of circuit the 3274 will operate on. The default value is 4. Refer to your network subscription information for your response.

A permanent virtual circuit (PVC) gives users the appearance of an actual end-to-end connection, analogous to a point-to-point SDLC leased connection. It requires no call setup or clearing by the DTE.

A switched virtual circuit (SVC) is a temporary logical connection between two DTEs, analogous to a point-to-point switched line. It is initiated by a DTE signaling a call request to the network and terminated by a clear command from the DTE.

- 1 = Permanent virtual circuit (PVC)
- 2 = Incoming call (from host) only (SVC)
- 3 = Outgoing call (to host) only (SVC)
- 4 = Two-way call (SVC) (default).

402: Logical Channel Identifier

The logical channel identifier for the circuit specified in 401 (circuit type) is included in the outgoing call request packet. Refer to your subscription information for your channel identifier.

Note: Some networks do not permit logical channel 0.

0000–4095 = Channel identifier for the circuit specified in 401

403: Logical Link Control

This input field defines whether qualified logical link control (QLLC) or physical services header (PSH) protocols are used. The default value is 1. QLLC is used by IBM products with integrated X.25 support. PSH support allows the 3274 to communicate with equipment attaching to the network via the network interface adapter box.

- 0 = PSH control
- 1 = QLLC control (default)

410: Host DTE Address (HNAD)

This field contains the host network DTE address. Enter 1 to 15 digits for your address. If your response to question 420 is 1XXXXXXX and question 401 is 2, then you must respond to this question. Otherwise, you may mark Ns (the default) in the field on the response form.

Note: If the response to this question does not fill the entire field, you may enter Ns or blanks wherever you have not entered a numeric character.

411: 3274 DTE Address

This field contains the local DTE address for the 3274. Enter 1 to 15 digits for your address. If your response to question 421 is 1XXXXXXX and question 401 is 3 or 4, then you must respond to this question. Otherwise, you may mark Ns (the default) in the field on the response form.

Note: If the response to this question does not fill the entire field, you may enter Ns or blanks wherever you have not entered a numeric character.

420: Incoming Call Options (IOPT)

This 8-bit field must have either 0's or 1's entered for each bit. The bit settings allow the user to choose how to process fields in an incoming call. Many of the choices refer to optional facilities. Refer to your network subscription information before selecting the bit settings. The default field is all 0's. If question 401 equals 1 or 3, the response to this question must be 00000000.

Any values selected for incoming call options can be changed on a per-call basis during a Dial session if the X.25 keyboard support option specifies that all fields will be displayed on the Dial screen.

Bits	Bit Descriptions
0 1 2 3 4 5 6 7	
	= Reserved
0	= Do not accept packets that include throughput class negotiation.
1	= Negotiate throughput class.
0	= Do not validate CID on incoming calls.
1	= Validate CID on incoming calls.
0	= Do not accept packets that include the negotiated window size facility.
1	= Accept packets that include the negotiated window size facility.
0	= Do not accept packets that include the negotiated packet size facility.
1	= Accept packets that include the negotiated packet size facility.
00	= Do not accept calls with the reverse-charge facility included.
01	= Accept calls with the reverse-charge facility equal to the reverse charge requested.
10	= Accept calls with the reverse-charge facility <i>not</i> requested.
11	= Accept calls with the reverse-charge facility and either reverse charge required or <i>not</i> reverse charge accepted.
0	= Do not validate host (calling) DTE address.
1	= Validate host (calling) DTE address.

421: Outgoing Call Options (OOPT)

This 8-bit field must have either 0's or 1's entered for each bit. The bit settings allow the user to choose the fields to be included in an outgoing call. Many of the choices refer to optional facilities. Refer to your network subscription information before selecting the bit settings. The default field is all 0's. If question 401 equals 1 or 2, the response to this question must be 00000000.

Any values selected for outgoing call options can be changed on a per-call basis during a Dial session if the X.25 keyboard support option specifies that all fields be displayed on the Dial screen.

Bits	Bit Descriptions
0 1 2 3 4 5 6 7	
	= Reserved.
	0 = Do not include the throughput class facility in the call request packet.
	1 = Include the throughput class facility in the call request packet.
	0 = Do not include the CID in the call request packet.
	1 = Include the CID in the call request packet.
	0 = Do not include the negotiated window size facility field in the call request packet.
	1 = Include the negotiated window size facility field in the call request packet.
	0 = Do not include the negotiated packet size facility field in the call request packet.
	1 = Include the negotiated packet size facility field in the call request packet.
	00 = Do not include the reverse-charge facility in the call request packet.
	01 = Request reverse charge via the reverse-charge facility.
	10 = Request <i>no</i> reverse charge via the reverse-charge facility.
	11 = Invalid response.
	0 = Do not supply the 3274 (calling) DTE address in the call request packet.
	1 = Supply the 3274 (calling) DTE address in the call request packet.

430: Negotiated Packet Size (NPKT)

This field is used for the negotiated packet size facility. In 420 (incoming call options), if bit 3 equals 1 (accept packets that include the negotiated packet size facility), this field sets the size limit to which the 3274 may negotiate. In 421 (outgoing call options), if bit 3 equals 1 (include the negotiated packet size facility in the call request packet), this field serves as the requested value.

The default is 1 (128 bytes). Refer to your subscription information for information on the optional negotiation packet size facility.

Note: Although a packet size of 512 can be specified to match the network, the 3274 imposes an upper data limit of 256 for the path information unit size:

- 0 = 64-byte packet
- 1 = 128-byte packet (default)
- 2 = 256-byte packet
- 3 = 512-byte packet

431: Packet Sequence Numbering

This input field indicates whether the extended packet sequence numbering facility is to be used. Refer to your network subscription information for your response. The response to this question will influence your responses to questions 432 and 435. The default is 0 (modulo 8).

- 0 = modulo 8 (default)
- 1 = modulo 128

432: Negotiated Window Size (NWND)

This field is used for the negotiated window size facility. On 420 (incoming call options), if bit 4 equals 1 (accept packets that include the negotiated window size facility), this sets the size limit to which the 3274 may negotiate. On 421 (outgoing call options), if bit 4 equals 1 (include the negotiated window size facility field in the call request packet), this field indicates the requested value. Refer to your network subscription for your response. The default is 02.

- 01–07 = Range for modulo 8 (if 431 equals 0)
- 01–11 = Range for modulo 128 (if 431 equals 1)

433: K-Maximum Out

This field specifies the maximum number of link level I-frames that the 3274 transmits before waiting for an acknowledgment. Your network subscription information indicates the correct response. The default is 2.

- 1–7 = Maximum number of link level I-frames (default = 2)

434: Nonstandard Default Packet Size (DPKT)

This field contains the packet size value to which you subscribed in your X.25 network agreement. The default is 1. This value is used to select the 3274 packet size when:

- In 421 (outgoing call option), bit 3 equals 0 (*not* to include the negotiated packet size facility in the outgoing call packet), or
- An incoming call packet does *not* include the negotiated packet size facility.

This value can be entered by an operator on a per-call basis, overriding default or customized values.

Note: Although a packet size of 512 can be specified to match the network, the 3274 imposes an upper data limit of 256 for the path information unit size:

- 0 = 64-byte packet
- 1 = 128-byte packet (default)
- 2 = 256-byte packet
- 3 = 512-byte packet

435: Nonstandard Default Window Size (DWND)

This field contains the packet window size value subscribed to in your X.25 network agreement. This value is used to select the 3274 window size when:

- In 421 (outgoing call option), bit 4 equals 0 (*not* to include the negotiated window size facility in the outgoing call packet), or
- An incoming call packet does *not* include the negotiated window size facility.

The default is 02. Refer to your network subscription for the value for this field:

- 01–07 = Range for modulo 8 (if 431 equals 0)
- 01–11 = Range for modulo 128 (if 431 equals 1)

This value can be entered by an operator on a per-call basis, overriding default or customized values.

440: Throughput Class Negotiation (TCLS)

Throughput class negotiation is a network facility that sets priority for packets. Refer to your network subscription information for the response to this question. The default is 9.

On 421 (outgoing call options), if bit 6 equals 1 (include the throughput class negotiation facility in the call request packet), this field supplies the value. On 420 (incoming call options), if bit 6 equals 1 (negotiate throughput class on an incoming call request packet), the 3274 accepts the request value if it is less than or equal to the customized value. If not, the customized value is returned.

- 3 = 75 bps
- 4 = 150 bps
- 5 = 300 bps
- 6 = 600 bps
- 7 = 1200 bps
- 8 = 2400 bps
- 9 = 4800 bps (default)
- A = 9600 bps
- B = 19,200 bps
- C = 48,000 bps

This value can be entered by an operator on a per-call basis, overriding default or customized values.

441: Closed User Group (CUG)

A response to this question is optional. Enter a value to be included in the closed-user-group facility in an outgoing call request packet. If the field is left with Ns, blanks, or nulls, the closed-user-group facility is not included in the outgoing call request packet.

Consult your network subscription information for your response.

00–99 = Include closed-user-group facility in outgoing call request packet.

Note: If the response is a number with less than two digits, use a leading zero. For example, if your response is 6, enter 06 on the response form. If there is no response to this question, enter two Ns on the response form.

This value can be entered by an operator on a per-call basis, overriding default or customized values.

442: Recognized Private Operating Agency (RPOA)

A response to this question is optional. Enter a value for the recognized private operating agency facility if this applies to your system.

If the field is left with Ns, this facility is not included in the outgoing call request packet.

0000–9999 = Recognized private operating agency

Note: If the response is a number with less than four digits, use leading zeros. For example, if your response is 57, enter 0057 on the response form. If there is no response for this question, enter four Ns on the response form.

This value can be entered by an operator on a per-call basis, overriding default or customized values.

443: X.25 Keyboard Support Options

This field allows you to choose how to use X.25 Extension mode keys. The X.25 keys used in the Dial procedure are Extension, DIAL, LOCAL, COMM (Communicate), DISC (Disconnect), and LOAD MATRIX. For more information about the function of these keys during the Dial procedure, refer to *X.25 Operation*, GA23-0178.

Typically, the device attached to port 0 has access to all the X.25 Switched function keys. The LOAD MATRIX key function is assigned only to port 0. During customization, however, the other keys may be assigned to all ports, or certain keys may be deleted.

During the Dial procedure, the operator can change customized values for certain X.25 facilities on a per-call basis. To make this possible, set bit 5 equal to 0 (“display all fields”).

The default values specified in the response field are 10100100.

Note: If PVC was the response to number 401 (response equals 1), bits 0, 1, and 5 have no meaning and are ignored.

Bits	Bit Descriptions
0 1 2 3 4 5 6 7	
	= Reserved
0	= If no SNA sessions are active, pressing the DISC (SVC) or LOCAL (PVC) key performs the disconnect or local mode operation. If any sessions are active, pressing the key once inhibits the keyboard. Pressing the key twice initiates the operation (default).
1	= The DISC (SVC) or LOCAL (PVC) key immediately performs the disconnect or local mode operation, regardless of active sessions.
0	= Display all fields on the Dial screen. This allows the operator to change customized or default values on a per-call basis.
1	= Display only the HNAD field on the Dial screen. This allows the operator to enter only the number to be called (default).
0	= X.25 keys are supported on port 0 only (default).
1	= X.25 keys are supported on all ports.
00	= X.25 LOCAL and COMM keys are not supported on the 3274.
01	= X.25 LOCAL and COMM keys are supported on port 0 regardless of the bit 4 value.
10	= X.25 LOCAL and COMM keys are supported per bit 4 (default).
11	= Invalid.
00	= X.25 DISC key is not supported on the 3274.
01	= X.25 DISC key is supported on port 0, regardless of the bit 4 value.
10	= X.25 DISC is supported per bit 4 (default).
11	= Invalid.

450: Link LVL Transmit Timeout

The link level transmit timeout is usually referred to as either T_1 or T_p . This value is specified in 0.1-second intervals and set to the value required by each individual network. Refer to your network subscription for your response. The 3274 timer will be $\pm 20\%$ of the value specified. For values greater than 25.0 seconds (0250 input), the lower (tenths) digit is ignored. For example, 0277 is treated as 27 seconds. The response range is:

0001–2540

451: Number of Retries

The number of retries is usually referred to as N_p or N_2 . Set this value to the number of retries required by the individual network. Refer to your network subscription for your response. The response range is:

01–99

452: CID Password (CID)

The connection identifier (CID) response is optional. On 420 (incoming call options), if bit 5 equals 1 (validate the CID on incoming packets), this field is used for the validation. On 421 (outgoing call options), if bit 5 equals 1 (include the CID in the call request packet), this input field supplies the CID.

This 8-character password can have alpha and numeric characters.

Note: If your password has fewer than eight characters, enter Ns for the blanks on the response form.

908: X.25 Customization Acceptance

Sequence number 908 appears as part of the sequence number 332 panel (X.25 customization). This sequence number prompts the operator to enter a 1 after he or she has checked all the responses entered. If the 3274 detects unacceptable responses, it automatically changes the 1 back to a 0, intensifies the brightness of the incorrect entries, and displays an operator code that indicates the incorrect information.

Chapter 3. Initial Customizing Procedure

This chapter contains the *Initial Customizing Procedure Form*. This is used to customize the 3274 Control Unit for the first time. When changes are required after the 3274 has been successfully customized, use the *Modification Procedure Form* in Chapter 5.

Copy the customization responses on the *Initial Customizing Procedure Form* and on the *3274 Configuration Data Card (Configuration Support: P)*, GA23-0177, supplied with the 3274. Store the card in the diskette storage area of the 3274, for future use.

In addition to the completed *Initial Customizing Procedure Form*, the planner should give the operator:

- Keyboard diagrams showing the valid key positions for customizing (Figures 3-1 and 3-2)
- An “Operator Codes” chart that gives the meaning and recommended actions for the operator codes that may appear on the display screen during the customization procedure (Figure 3-3)
- “8 4 2 1 Indicator Codes” charts that give the meaning and recommended actions for the indicator codes that routinely appear on the 3274 control panel during the customizing procedure (Figures 3-4 and 3-5)
- An “8 4 2 1 Indicator Codes” chart that gives the meaning and recommended actions for the indicator codes that may appear on the 3274 control panel during IML because of improper customizing (Figure 3-6)
- A *Printer Authorization Matrix Form*, which may be used with sequence number 022.

These figures follow the *Initial Customizing Procedure Form*.

Operator: Before you begin the customizing procedure, read over this form. Check to make sure that your planner has provided answers for every question. This is a step-by-step procedure for entering the information needed to customize the 3274 Control Unit. *If you do not get the expected result in any step, start over at Step 1. If you still do not get the expected result, report the problem to your planner.*

Step 1. Check the Control Unit.

Check that the power is switched on for the 3274 Control Unit. The display station that will be used to customize should be attached to port A0 of the control unit.

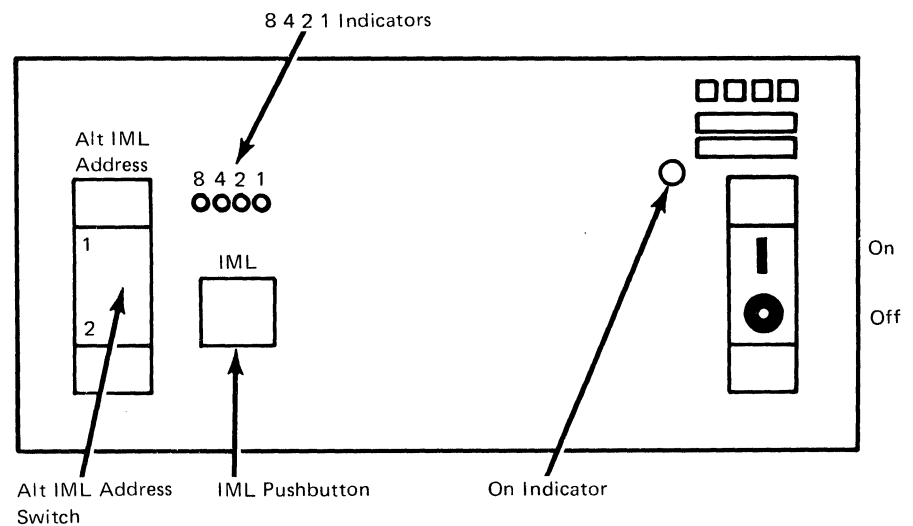

On the 3274 control panel (shown above), there are four indicator lights labeled 8 4 2 1. The lights can be *on* or *off*, and the pattern in which they are turned on or off makes a code designed to show you the progress of the customization procedure and to let you know whether you need to take any specific action. There are both steady light indicator codes and flashing light indicator codes. A flashing light usually indicates that you need to take an action, the next step in the process. If an error occurs during customizing, the 8 4 2 1 indicator codes may help you locate the cause:

- An indicator that is *on* (lighted up) is called a *1*.
- An indicator that is *off* (not lighted) is called a *0* (zero).

For example:

8 4 2 1
* * o * = 1 1 0 1

Charts of the indicator codes and their meaning (Figures 3-4 and 3-5) are located at the end of this form.

Step 2. Check the Keyboard.

You need to work at a 3178, 3278, or 3279 display station with a keyboard attached. Check that the display station has its power switched on, and that it is attached to port A0 of the 3274 Control Unit. You will use this type of keyboard:

- Typewriter
- Data Entry Keypunch
- Data Entry
- Japanese Katakana Typewriter
- Japanese Katakana Data Entry
- Japanese English Typewriter

When you are customizing, only certain keys will be active. Turn to Figures 3-1 and 3-2 at the end of this form, to see which keys on your keyboard can be used for customizing.

Step 3. Collect the Diskettes.

To customize the control unit, you will need these diskettes. Obtain them from your planner.

- Feature diskette
- System diskette
- Language diskette (if necessary)
- RPQ diskette(s) (if necessary)
 1. _____
 2. _____
 3. _____

Step 4. Check for the Forms You Need.

As you answer the customizing questions, you may need extra forms with information entered by your planner. These forms checked by the planner should be attached to this form:

- Printer Authorization Matrix Form
- Subsystem Verification Procedure
- Instructions for Setting 3274 Model 31C Modem Address Switches
- Instructions for Setting 3274 Model 51C Transmit Level Switches

Step 5. Insert the Feature Diskette.

a. All Models except 51C

1. Open the customer access door, and locate the diskette reader enclosure.

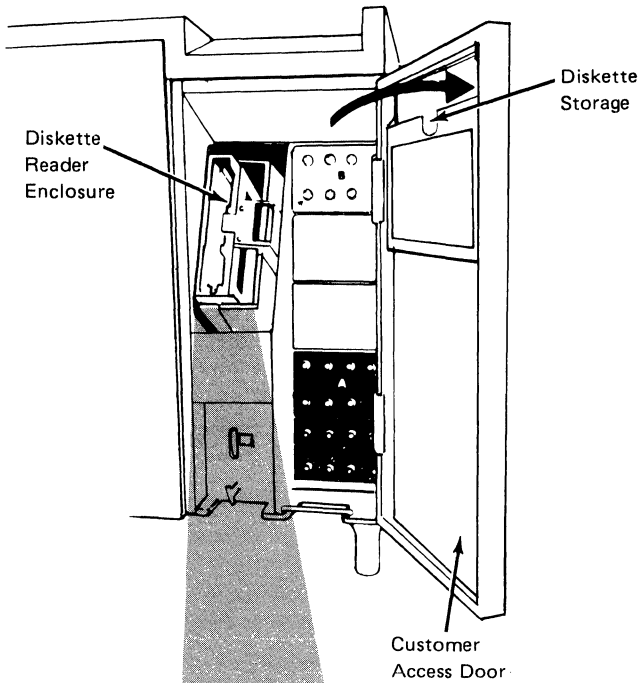

2. Open the diskette reader enclosure door by pressing the latch to the right.

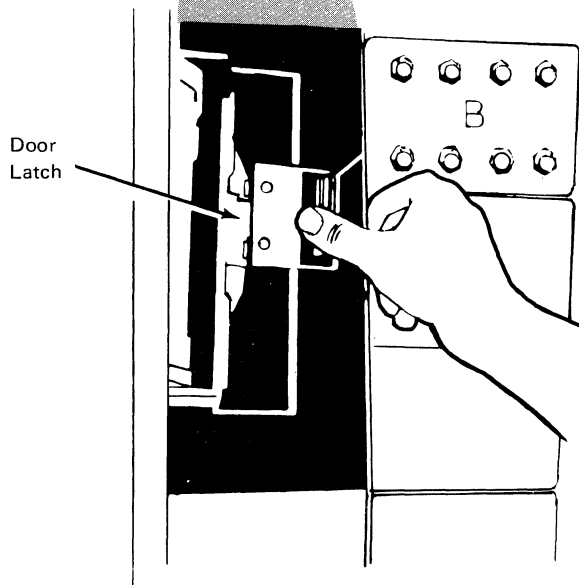

3. Remove the feature diskette to be used with the 3274 from its gray protective envelope, and insert it squarely into the enclosure. Note that the diskette label position is to the right.

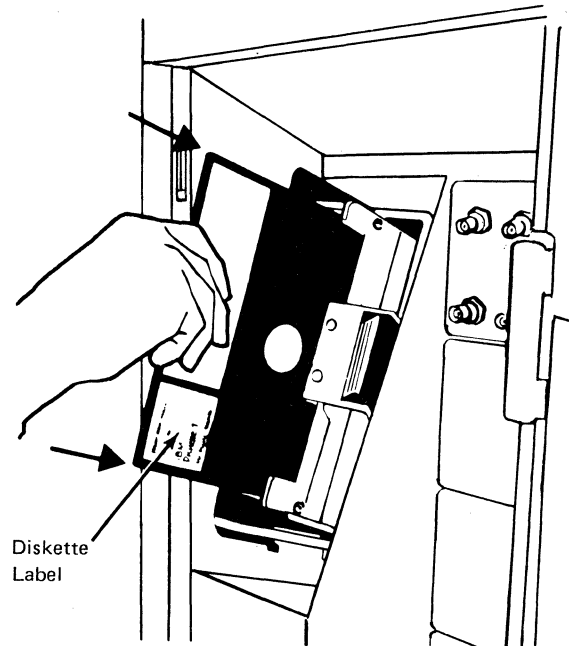

4. Close the diskette reader enclosure door by pushing the door to the left until it latches (clicks).

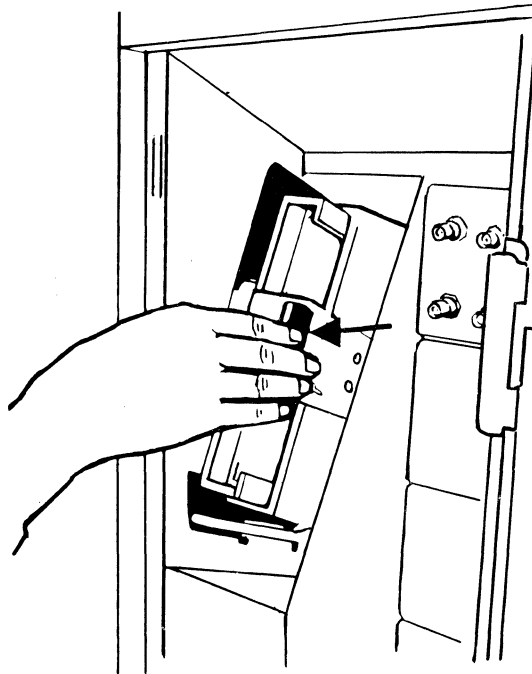

5. Press the IML pushbutton and release it.

6. Within 1 minute, you should see this steady indicator code:

8 4 2 1
0 0 0 1

If you are using a 3279 Color Display Station, refer to Appendix E in the *3274 Control Unit Planning, Setup, and Customizing Guide, GA27-2827*, for instructions on the convergence procedure.

b. Model 51C

1. Open the diskette reader by turning the lever counterclockwise to the vertical position.

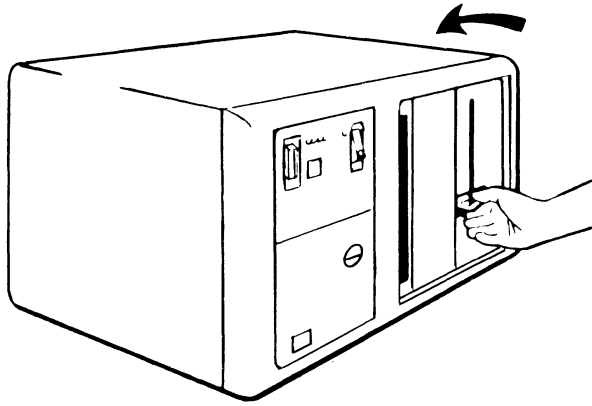

2. Remove the feature diskette to be used with the 3274 from its gray protective envelope, and insert it squarely into the enclosure. Note that the diskette label position is on your left.

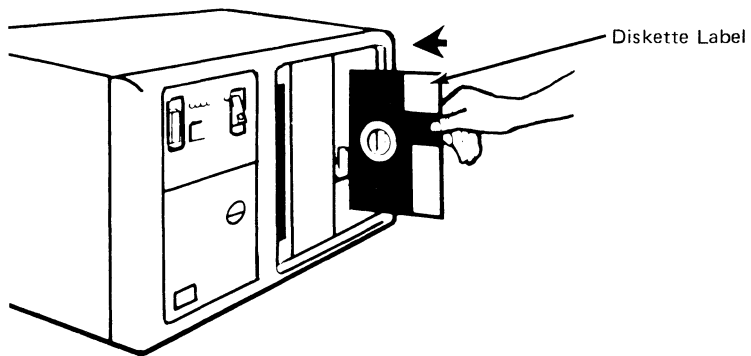

3. Close the diskette reader by turning the lever to the horizontal position.

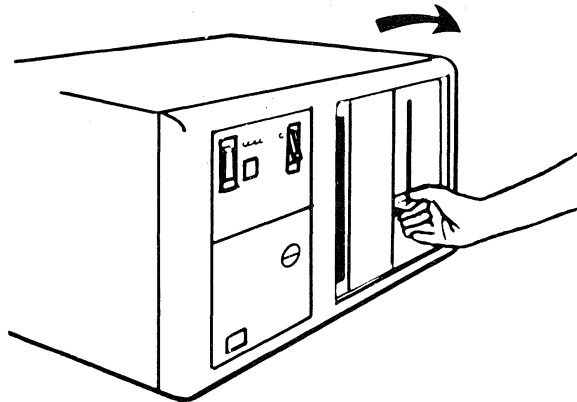

4. Press the IML pushbutton and release it.
5. Within 1 minute, you should see this steady indicator code:

8 4 2 1
0 0 0 1

If you are using a 3279 Color Display Station, refer to Appendix E in the *3274 Control Unit Planning, Setup, and Customizing Guide, GA27-2827*, for instructions on the convergence procedure.

Step 6. Enter Responses for the Initial Customizing Questions.

The first few questions you need to answer for customization will be presented on your screen one by one, in sequence. Then the remaining questions will be grouped together and presented in a panel that will be displayed on your screen.

Before you begin to enter the responses to the customizing questions, read these instructions:

1. If any spaces are blank, ask your planner about them.
2. Enter the responses as they are marked on this form. After you have entered a response, a program checks your entries. If there are any problems, the invalid response is displayed with intensified brightness and an operator code is displayed at the upper center screen. The operator code will help you figure out the problem. A list that explains the meaning of each code (Figure 3-3) is included with this form.
3. Use only the cursor move keys or the Tab key to position the cursor.

Sequence Number 001

The first sequence number is 001. Look for it in the upper left corner of your screen (shown below).

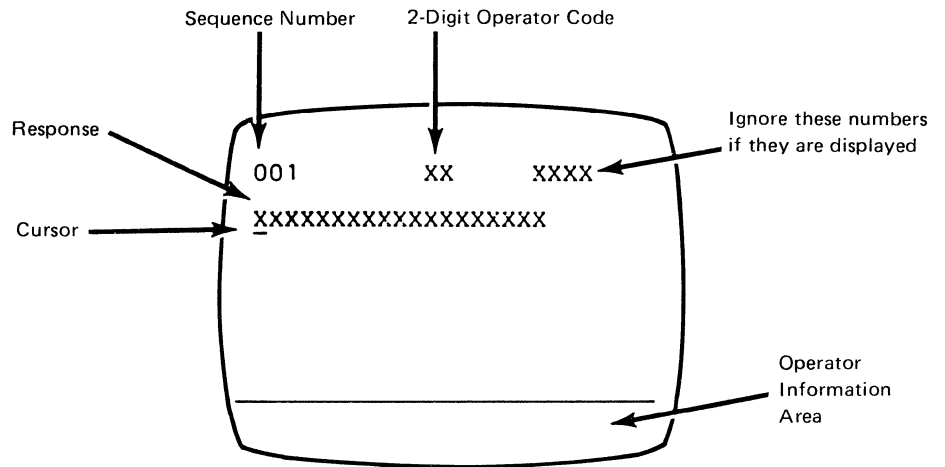

Beneath the sequence number is a row of Xs, which you will replace when you type in the response to sequence number 001. If the response you enter is acceptable, a new sequence number is displayed. If the response is unacceptable, a 2-digit operator code is displayed in the upper center portion of the screen. See Figure 3-3 for the meaning of this code.

Note: If a 74- or 88-key Japanese English or Katakana keyboard is used, press the key circled on the keyboard illustrated in Figure 3-2. The keyboard will be locked for about 10 seconds. When the keyboard unlocks, you can enter your response to sequence number 001.

1. **Response:** 1234567890ABCDEF
2. Press the spacebar once.
3. Type in the 2-digit validation number that is printed on the *system* diskette label.
4. Press ENTER.

Sequence Number 011

The default response displayed on the screen is 0.

1. **Response:** 0
2. Press ENTER.

Sequence Number 021

The default response displayed on the screen is 0.

1. Response:

2. Press ENTER.

If the response is 1, the **Sequence Number 022** panel is displayed next. Using the *Printer Authorization Matrix Form* attached to this form, enter the responses to the questions on the panel. Follow the instructions on the form. If the response to number 021 is 0, sequence number 031 is displayed next.

Sequence Number 031

Type in the number (0–3) of RPO diskettes being used. The default response displayed on the screen is 0.

1. Response:

2. Press ENTER.

Step 7. Enter Responses for the Sequence Number 999 Panel.

This is how the sequence number 999 panel looks when it is first displayed on your screen; some of the response fields are filled with Xs, and default values are supplied for the rest:

999			
111 - 00	112 - XX	113 - XX	
121 - XX	141 - A		
151 - XXX	161 - 1		
213 - 0	215 - 00000		
302 - XX	311 - 0	343 - XX	
			900 - 0

Your planner has recorded the responses for this customization on the sequence number 999 layout below. These responses may change the default values.

999		
111 --	<input type="text"/>	<input type="text"/>
112 --	<input type="text"/>	<input type="text"/>
113 --	<input type="text"/>	<input type="text"/>
121 --	<input type="text"/>	<input type="text"/>
141 --	<input type="text"/>	
151 --	<input type="text"/>	<input type="text"/>
161 --	<input type="text"/>	
213 --	<input type="text"/>	
215 --	<input type="text"/>	<input type="text"/>
302 --	<input type="text"/>	<input type="text"/>
311 --	<input type="text"/>	
343 --	<input type="text"/>	<input type="text"/>
		900 -- 0

1. Type in the responses your planner has recorded for each sequence number. Just press the Tab (→) key to move the cursor left to right, from one sequence number to the next.

Note: If there is a 1-digit response for a 2-digit box, use leading zeros (for example, 02 for 2).
2. After the last response is entered, the sequence number 999 panel is displayed with all the responses you entered. Check your entries with those marked on the sequence number 999 layout. If you need to change any of your entries, move the cursor to the entry to be changed and type in the new response. Do not try to change the sequence number itself.
3. When all the entries are correct, move the cursor to the 0 (zero) after sequence number 900, and change it to a 1.
4. Press ENTER.

If any entry is unacceptable, the entry to sequence number 900 is changed back to 0 and the unacceptable response is displayed more brightly. (On the 3279, the intensified characters change to white and red instead of blue and green.) The upper center portion of the screen displays a 2-digit operator code. If several responses are intensified, then the displayed operator code will refer to the responses in numeric order, from largest to smallest.

1. Correct the response to the largest sequence number that is intensified.
2. Press ENTER. The operator code will change to explain the next error.
3. Continue correcting the responses by repeating steps 1 and 2 until there are no intensified sequence numbers. This means all the entries are corrected. Move the cursor to the 0 (zero) after sequence number 900, and change it to a 1.
4. Press ENTER.
5. If there are still unacceptable entries intensified, report the problem.

Step 8. Enter Responses for the Sequence Number 332 Panel.

This is how the sequence number 332 panel looks when it is first displayed on your screen, before you enter any responses; some of the response fields are filled with Xs and Ns, while default values are supplied for the rest.

```

332                                     ##/XXX/X25
400 - 00           401 - 4       402 - XXXX   403 -1
410 - NNNNNNNNNNNNNNNN          411 - NNNNNNNNNNNNNNNN
420 - 00000000          421 - 00000000
430 - 1           431 - 0       432 - 02     433 - 2
434 - 1           435 - 02
440 - 9           441 - NN      442 - NNNN   443 - 10100100
450 - XXXX          451 - XX    452 - NNNNNNNN
                                     908 - 0

```

Here is the sequence number 332 layout with the responses your planner entered.

332

400 -	<input type="text"/>	401 -	<input type="text"/>	402 -	<input type="text"/>	403 -	<input type="text"/>
410 -	<input type="text"/>					411 -	<input type="text"/>
420 -	<input type="text"/>					421 -	<input type="text"/>
430 -	<input type="text"/>	431 -	<input type="text"/>	432 -	<input type="text"/>	433 -	<input type="text"/>
434 -	<input type="text"/>			435 -	<input type="text"/>		
440 -	<input type="text"/>	441 -	<input type="text"/>	442 -	<input type="text"/>	443 -	<input type="text"/>
450 -	<input type="text"/>			451 -	<input type="text"/>	452 -	<input type="text"/>

908 - 0

Before you begin to enter the responses on the 332 panel, read these instructions:

1. If any spaces are blank, ask your planner about them.
2. Enter the responses as your planner has written them. If any spaces are filled with Ns, leave the Ns in the response field on the panel.
3. Note how the responses to these questions must be entered:

410, 411, and 452: The response to these questions may not fill the entire field. You may leave Ns wherever you have not entered an alphanumeric character. If you press EOF to clear to the end of the field, a slash (/) will be displayed to mark the end of the original response field. Should you ever modify the response entered for this question, note that the slash (/) space is the last one in which a character may be entered.

441: If the response is a 1-digit number, use a leading zero (for example, 06 for 6). Blanks cannot be used. If there is no response to this question, leave the Ns unchanged.

442: If the response is a number with less than four digits, use leading zeros (for example, 0356 to 356). Blanks cannot be used. If there is no response to this question, leave the Ns unchanged.

After you have made all the entries and checked them, follow these steps:

1. Move the cursor to the 0 (zero) entry following the 908 at the bottom right of the display.
2. Change the 0 entry to a 1, and press ENTER.

If all your entries are acceptable, sequence number 332 is cleared from the screen.

3. If any entry is unacceptable, the entry to sequence number 908 is changed back to 0 and the unacceptable response is displayed more brightly. (On the 3279, the intensified characters change to white and red instead of blue and green.) The upper center portion of the screen displays a 2-digit operator code. (These codes are explained in Figure 3-3.) If several responses are intensified, then the displayed operator code will refer to the responses in numeric order, from largest to smallest.

- Correct the response to the largest sequence number that is intensified.
- Press ENTER. The operator code will change to explain the next error.
- Continue correcting the responses, as described above, until there are no intensified sequence numbers. This means all the entries are corrected. Move the cursor to the 0 (zero) after sequence number 908, and change it to a 1.
- Press ENTER.
- If all the entries are acceptable, sequence number 332 is cleared from the screen. If there are still unacceptable entries intensified, report the problem.

Step 9. Change Diskettes.

Within 2 minutes, the 8 4 2 1 indicator code on the control panel will flash one of the following codes:

1100:

1. Replace the feature diskette with the RPQ diskette. *Do not press the IML pushbutton.* (If you do press the IML pushbutton, begin again at **Step 5.**) After you insert the RPQ diskette, the steady code will change to 0111 within 30 seconds.

2. If the indicator code again flashes 1100, either additional RPQ diskettes are needed, or you inserted a non-RPQ diskette. Repeat the procedure for each additional RPQ diskette. *At no time should you press the IML pushbutton.*
3. When the indicator code flashes 1110, the RPQ diskette procedure is completed. Reinsert the feature diskette. *Do not press the IML pushbutton.*
4. Within 2 minutes, the 8 4 2 1 indicator code will flash 1101 or 1011. (Those indicators are explained below.)

1101:

1. Replace the feature diskette with the language diskette. *Do not press the IML pushbutton.* (If you do press the IML pushbutton, begin again at **Step 5**.) Within 30 seconds, the indicator code will change to 0111 and then to flashing 1011 within 1 minute.
2. When the indicator code is flashing 1011, replace the language diskette with the system diskette. *Do not press the IML pushbutton.* Within 1 minute, the 8 4 2 1 indicator code will change to a 1000 and remain this way for approximately 15 minutes. (If errors occur during this 15-minute period, a flashing 8 4 2 1 indicator code will appear. The meaning of these codes is explained in Figures 3-4 and 3-5.) Then the steady indicator code will change to 1111. Customizing is successfully completed. Go to **Step 10**.

1011:

Replace the feature diskette with the system diskette. *Do not press the IML pushbutton.* (If you do press the IML pushbutton, begin again at **Step 5**.) Within 1 minute, the steady 8 4 2 1 indicator code will change to a 1000 and remain this way for approximately 15 minutes. (If errors occur during this 15-minute period, a flashing 8 4 2 1 indicator code will appear. The meaning of these codes is explained in Figures 3-4 and 3-5.) Then the steady indicator code will change to 1111. Customizing is successfully completed. Go to **Step 10**.

Step 10. IML the 3274.

1. Check with your supervisor to be sure that the 3274 is attached to its communication facility.
2. Make sure the system diskette is inserted in the 3274.
3. Press the IML pushbutton. During the IML operation, errors may occur because of improper customizing. The 8 4 2 1 indicator codes in Figure 3-6 should help you detect these errors.

4. After the IML operation is initiated, if the **X** symbol appears with no communication reminders in your display screen's operator information area for more than 1 minute, contact your host system operator to make sure the control unit is being polled.

Step 11. Store the Configuration Data Card.

We suggested that you copy the responses to the sequence numbers on the *IBM Configuration Data Card (Configuration Support: P)*, GA23-0177. The card is supplied with this control unit. For future reference, store the card in the pocket provided. The pocket is located on the inside of the 3274 operator access door on Models 1, 21, and 31, or in the diskette storage area on the front of the Model 51C.

Step 12. Verify the Subsystem.

If a Subsystem Verification Procedure has been given to you, perform that procedure.

Step 13. Set the Switches.

If you have been given instructions for setting 3274 Model 31C or 51C switches, follow those instructions.

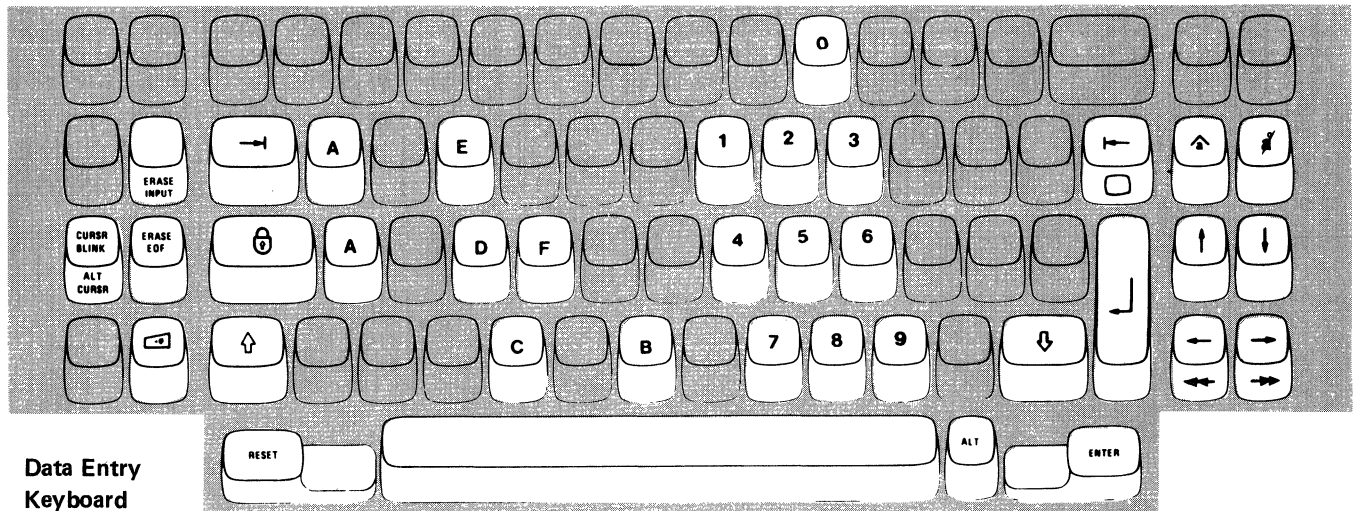
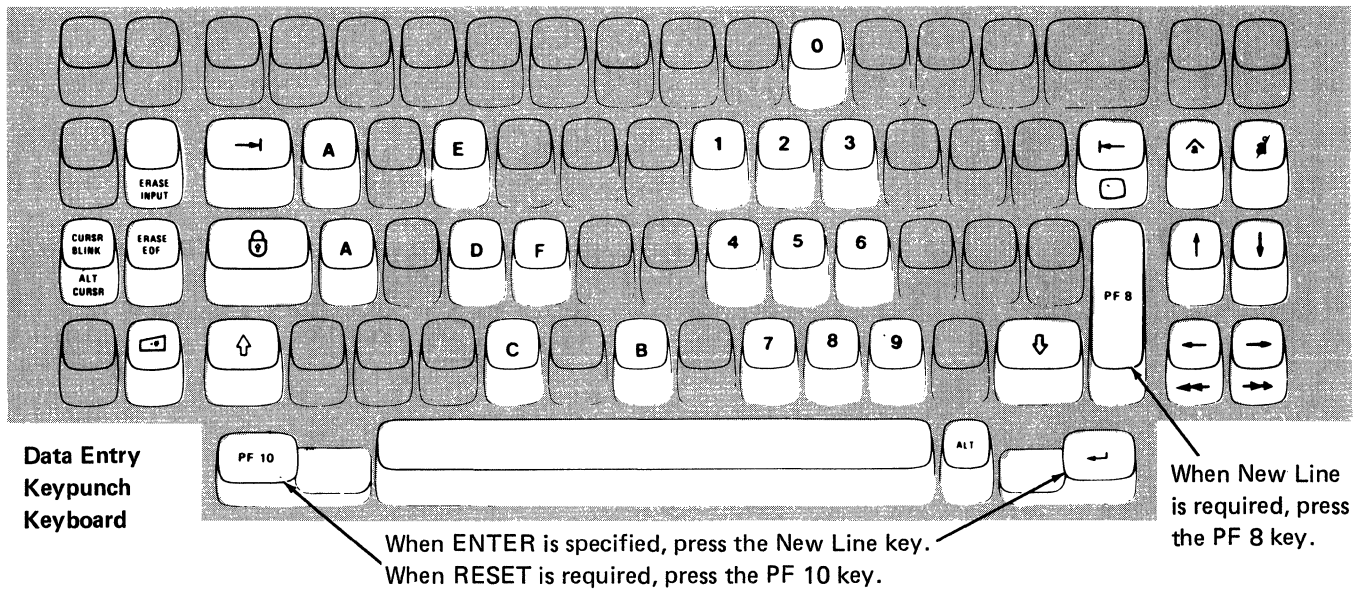
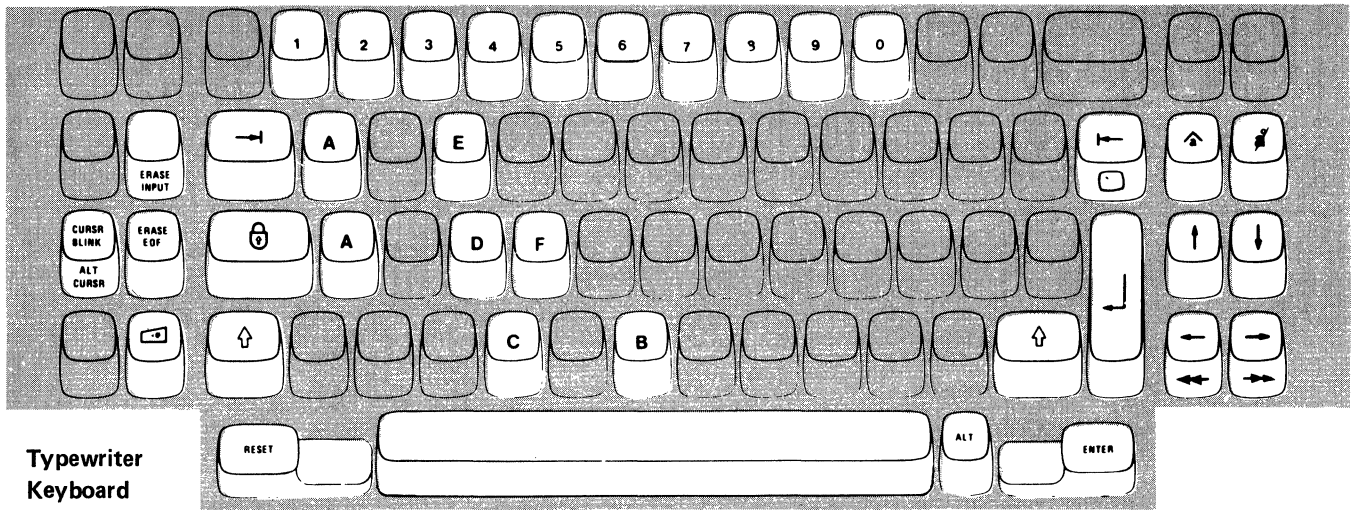

Note: During customizing, only certain key positions are valid. Only those key positions shown above are to be used.
Figure 3-1. Valid Key Positions during Customizing

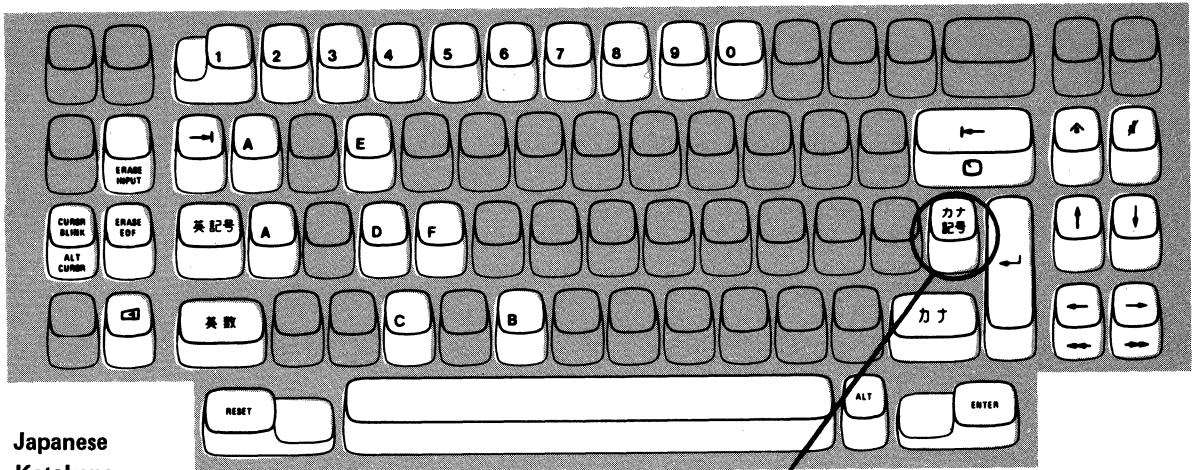

Japanese
Katakana
Typewriter
Keyboard

Press this key when sequence number 001 appears in the upper left corner of the 3278 screen.

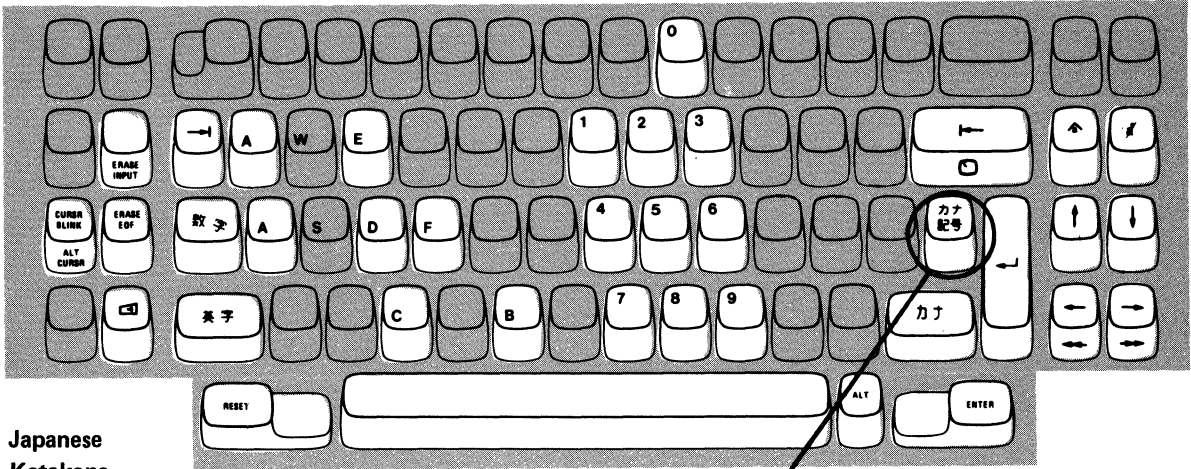

Japanese
Katakana
Data Entry
Keyboard

Press this key when sequence number 001 appears in the upper left corner of the 3278 screen.

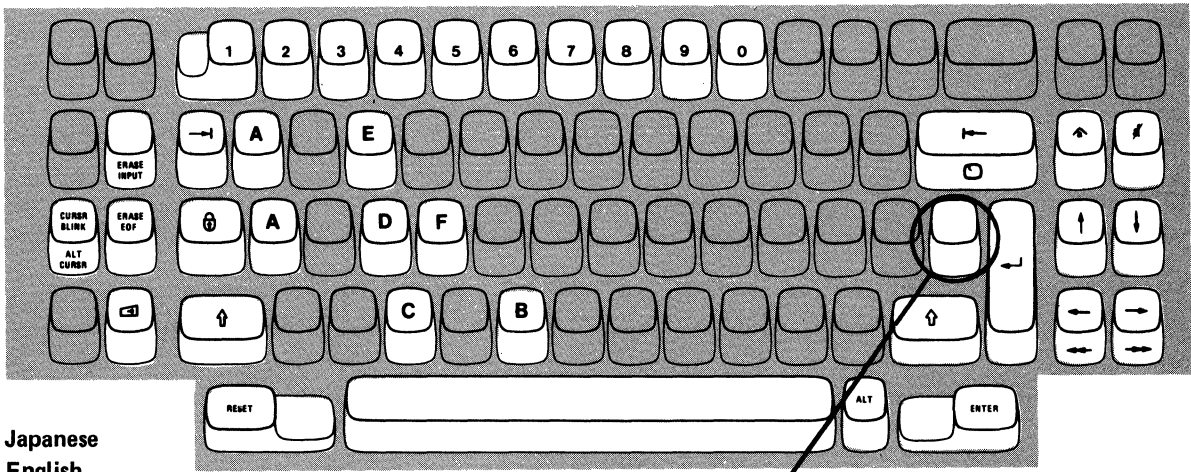

Japanese
English
Typewriter
Keyboard

Press this key when sequence number 001 appears in the upper left corner of the 3278 screen.

Note: These drawings show the valid keys for both the 76- and 88-key keyboards. The PF keys located on the right side of the 88-key keyboards are not shown and are not valid during this procedure.

Figure 3-2. Valid Key Positions during Customizing When Japanese Katakana and Japanese English Keyboards Are Used

Code	Meaning	Action
01	One or more of the first 10 characters are incorrect.	Enter the correct response.
02	One or more of the 11th to 17th characters, including the space, are incorrect.	Enter the correct response.
03	1. One of the last two characters you entered in response to sequence number 001 is incorrect, or 2. The diskette release level is not the same as the documentation level.	1. Enter the correct response. 2. Restart after matching diskette and documentation levels.
11 ¹	You entered an invalid response (too many characters, value too high or too low, wrong character, etc.).	Enter the correct response.
12 ¹	You entered other than 01C, 31C, or 51C in response to sequence number 151 (3274 model designation).	Enter the correct response.
13 ¹	Your response has too few characters.	Enter the correct response.
14 ¹	The numeric total of the responses you entered for sequence numbers 111 (number of Category B terminals) and 112 (number of Category A terminals) is greater than 32 (01C, 31C) or 12 (Model 51C).	Enter the correct responses.
21 ¹	You made an unacceptable change during the modify sequence (number 999).	Recheck the entries, and correct them.
41	The X.25 network type (400) is invalid.	Check the network type values and enter a valid response to 400.
42	The incoming call options (420) response included "Validate Host DTE Address," but the address was not entered in response to 410.	Either respond to 410 with the host address or do not include "Validate Host DTE Address" in response to 420.
43	1. The circuit type (401) chosen requires a host address (410). 2. The outgoing call options chosen included "Validate 3274 DTE Address," but the address was not entered in response to 411. 3. The response to 421 was invalid.	1. Either change the response to 401 or provide a host DTE address (410). 2. Either respond to question 411 with the 3274 address or do not include "Validate 3274 DTE Address" in response to 421. 3. Check 421 and enter a valid response.
44	Negotiated window size (432) or nonstandard window size (435) conflicts with packet sequence numbering (431).	If 431 equals 0, then 432/435 must equal 01–07 (two digits). If 431 equals 1, then 432/435 must equal 01–11 (two digits).
45	The circuit type (401) is invalid.	Check the circuit type values and correct the response.
46	An invalid X.25 keyboard support (443) was selected.	Check the X.25 keyboard support and correct the response.
47	No CID password was initialized (452), but a CID is required for call options (420 and/or 421).	Either change call options to remove the CID requirement or enter a CID password (452).
99	Your entries are acceptable, but the entry for sequence number 900 or 901 has not been changed to a 1.	Change the 900 or 901 entry to a 1.

¹If any entry is unacceptable, the entry for sequence number 900 is changed back to 0 (zero) and the unacceptable value is intensified.

Figure 3-3. Operator Codes during Customizing Only

Steady Code	Diskette Mounted	Meaning	Action
0001	Feature	Customizing being performed	None.
0010	Any (indication lasts for 3 minutes or more)	Diskette improperly inserted or an internal 3274 error	Insert diskette properly and retry.
0011	Feature	Customizing being performed	None.
0100	Feature	Patch, printer authorization matrix, or RPQ being performed	None.
0101	Feature	Configuration being performed	None.
0110	Feature	Modification being performed	None.
0111	Feature, language, or RPQ	Normal 3274 operation	None.
1000	System (customizing in process)	Normal 3274 operation	None.
1001	Any	Internal 3274 error	Retry. If the error recurs, follow your local procedure for problem recovery.
1010	Any	Internal 3274 error	Retry. If the error recurs, follow your local procedure for problem recovery.
1101	Any (customizing procedure in progress)	<ol style="list-style-type: none"> 1. IML pushbutton pressed while diskette is being changed, or 2. A bad or uncustomized system diskette is being used 	<ol style="list-style-type: none"> 1. Recustomize. Do not press the IML pushbutton unless instructed to do so. 2. Insert a good customized system diskette.
1111	System (IML not performed)	Customizing is completed	IML can be performed.

Figure 3-4. Steady 8 4 2 1 Indicator Codes during Customizing Only

Flashing Code ¹	Diskette Mounted	Meaning	Action
0000 1010	System	A diskette read error occurred.	Retry. If the error recurs, follow your local procedure for problem recovery.
0000 1011	Any	System diskette request	Insert system diskette.
0000 1100	Any	RPQ diskette request	Insert RPQ diskette.
0000 1101	Any	Language diskette request	Insert language diskette.
0000 1110	Any	Feature diskette request	Insert feature diskette.
0100 0010	System	Configuration on system diskette being used for update-diskette procedure is not compatible with this 3274	Use a system diskette with a compatible configuration.
1000 0001	System	Uncustomized system diskette being used during update procedure	Use customized system diskette.
1001 0110	Any	Wrong level diskette being used	Use correct level diskette.
1111 0001	Feature	On/Off switch or TEST key pressed instead of ENTER	Retry. If the error recurs, follow your local procedure for problem recovery.
	System	Internal 3274 error	Follow your local procedure for problem recovery.
1111 0011	Feature	Internal 3274 error	Follow your local procedure for problem recovery.
1111 0100	System	Internal 3274 error	Retry. If the error recurs, follow your local procedure for problem recovery.
1111 0101	System	Internal 3274 error	Retry. If the error recurs, follow your local procedure for problem recovery.
	Feature	On/Off switch or TEST key on the 3278 pressed instead of ENTER	
1111 0110	RPQ	Incompatible RPQs	Follow your local procedure for problem recovery.
	Feature	Internal 3274 error	
1111 0111	System	Internal 3274 error	Follow your local procedure for problem recovery.
1111 1000	System	Internal 3274 error	Follow your local procedure for problem recovery.
1111 1001	System	Internal 3274 error	Follow your local procedure for problem recovery.
1111 1010	Any	Internal 3274 error	Follow your local procedure for problem recovery.
1111 1011	System	Internal 3274 error	Follow your local procedure for problem recovery.
1111 1100	Any	Diskette drive error or a bad diskette	Retry. If the error recurs, follow your local procedure for problem recovery.
1111 1101	System or feature	Diskette drive error or a bad diskette	Retry. If the error recurs, follow your local procedure for problem recovery.
1111 1110	Any	Internal 3274 error	Retry. If the error recurs, follow your local procedure for problem recovery.

¹ These codes will flash alternately as shown, for example, 0000, 1011, 0000, 1011.

Figure 3-5. Flashing 8 4 2 1 Indicator Codes during Customizing Only

Steady Code	Flashing Code ¹	Diskette Mounted	Meaning	Action
—	0000 0101	System	Internal 3274 error or wrong response to sequence number 113 during customizing	Check response to sequence number 113, and retry. If the error recurs, follow your local procedure for problem recovery.
—	0000 0110	System	Internal 3274 error or wrong response to sequence number 111, 112, or 151 during customizing	Check response to sequence number 111, 112, or 151 and retry. If the error recurs, follow your local procedure for problem recovery.
—	0000 0111	System	1. Internal 3274 error, or 2. Wrong response to sequence number 311 or 343, or 3. The 3274 is not connected to the communication facility	1 and 2. Check responses to sequence numbers 311 and 343, and retry. 3. Connect the 3274 to the communication facility. If the error recurs, follow your local procedure for problem recovery.
—	0000 1000	System	Internal 3274 error or wrong response to sequence number 111 during customizing	Check response to sequence number 111, and retry. If the error recurs, follow your local procedure for problem recovery.
1101	—	System	Uncustomized system diskette	Insert customized system diskette.
1110	—	System	Insufficient storage	Check response to sequence number 113, and retry. If the error recurs, follow your local procedure for problem recovery.

¹ These codes will flash alternately as shown, for example, 0000, 0101, 0000, 0101.

Note: These indicators may be caused by something other than incorrect customizing. Further aids can be found in the *IBM 3270 Information Display System: 3274 Control Unit Problem Determination Guide*, GA27-2850.

Figure 3-6. 8 4 2 1 Indicator Codes during IML That May Result from an Incorrect Customizing Procedure

Printer Authorization Matrix Form

In response to sequence number 022, enter the characters (below) supplied by the planner in the appropriate groups on your display screen. If a group already is displayed as AA M XXXX YYYY YYYY, your entry will overwrite these characters. When you have completed all your entries, move the cursor to the zero after sequence number 901 at the bottom of the screen, change it to a 1, and press ENTER. Any entry that is not valid will be intensified at this time and the 1 you entered will change back to a 0 (zero). Correct the invalid entry, and return to 901. Again, change the zero to a 1, and press ENTER. When all entries are valid, the printer authorization matrix display will be replaced by the next customizing sequence number. (If, at any time during this procedure, you wish to cancel any entries you have just made, change the 0 (zero) after the 901 to A and press ENTER.) Return to your original instructions.

To delete an entry, move the cursor (with cursor-move keys or tab key) to the leftmost position of the entry (the Printer Port Address) and press the spacebar twice. The entire matrix, or as many entries as desired, can be deleted in this manner. After all changes have been made, press ENTER. All deleted entries will be displayed as AA M XXXX YYYY YYYY. When the matrix is satisfactorily defined, move the cursor to the zero after sequence number 901, change it to a 1, and press ENTER.

	Printer Port Address		Printer Mode	Printer Class Assignment				Source Device List						
	A	A	M	X	X	X	X	Y	Y	Y	Y	Y	Y	Y
1)	-	-	-	-	-	-	-	-	-	-	-	-	-	-
2)	-	-	-	-	-	-	-	-	-	-	-	-	-	-
3)	-	-	-	-	-	-	-	-	-	-	-	-	-	-
4)	-	-	-	-	-	-	-	-	-	-	-	-	-	-
5)	-	-	-	-	-	-	-	-	-	-	-	-	-	-
6)	-	-	-	-	-	-	-	-	-	-	-	-	-	-
7)	-	-	-	-	-	-	-	-	-	-	-	-	-	-
8)	-	-	-	-	-	-	-	-	-	-	-	-	-	-
9)	-	-	-	-	-	-	-	-	-	-	-	-	-	-
10)	-	-	-	-	-	-	-	-	-	-	-	-	-	-
11)	-	-	-	-	-	-	-	-	-	-	-	-	-	-
12)	-	-	-	-	-	-	-	-	-	-	-	-	-	-
13)	-	-	-	-	-	-	-	-	-	-	-	-	-	-
14)	-	-	-	-	-	-	-	-	-	-	-	-	-	-
15)	-	-	-	-	-	-	-	-	-	-	-	-	-	-
16)	-	-	-	-	-	-	-	-	-	-	-	-	-	-

	Printer Port Address		Printer Mode	Printer Class Assignment				Source Device List							
	A	A	M	X	X	X	X	Y	Y	Y	Y	Y	Y	Y	Y
17)	-	-	-	-	-	-	-	-	-	-	-	-	-	-	-
18)	-	-	-	-	-	-	-	-	-	-	-	-	-	-	-
19)	-	-	-	-	-	-	-	-	-	-	-	-	-	-	-
20)	-	-	-	-	-	-	-	-	-	-	-	-	-	-	-
21)	-	-	-	-	-	-	-	-	-	-	-	-	-	-	-
22)	-	-	-	-	-	-	-	-	-	-	-	-	-	-	-
23)	-	-	-	-	-	-	-	-	-	-	-	-	-	-	-
24)	-	-	-	-	-	-	-	-	-	-	-	-	-	-	-
25)	-	-	-	-	-	-	-	-	-	-	-	-	-	-	-
26)	-	-	-	-	-	-	-	-	-	-	-	-	-	-	-
27)	-	-	-	-	-	-	-	-	-	-	-	-	-	-	-
28)	-	-	-	-	-	-	-	-	-	-	-	-	-	-	-
29)	-	-	-	-	-	-	-	-	-	-	-	-	-	-	-
30)	-	-	-	-	-	-	-	-	-	-	-	-	-	-	-
31)	-	-	-	-	-	-	-	-	-	-	-	-	-	-	-

Chapter 4. Procedure for Generating a Backup Diskette

Each 3274 Control Unit is shipped with two uncustomized system diskettes. The planner customizes one diskette with the initial customizing procedure in Chapter 3 and uses that diskette as the primary IML diskette. The second system diskette may be used as a backup for the primary IML diskette.

Fill out the *Backup Diskette Procedure Form* that the operator will use. Give the completed *Backup Diskette Procedure Form* and the following information to the operator who will generate the backup system diskette:

- Keyboard diagrams showing the valid key positions for customizing (Figures 4-1 and 4-2)
- An “Operator Codes” chart that gives the meaning and recommended actions for the operator codes that may appear on the display screen during the customization procedure (Figure 4-3)
- “8 4 2 1 Indicator Codes” charts that give the meaning and recommended actions for the indicator codes that routinely appear on the 3274 control panel during the customizing procedure (Figures 4-4 and 4-5)
- An “8 4 2 1 Indicator Codes” chart that gives the meaning and recommended actions for the indicator codes that may appear on the 3274 control panel during IML because of improper customizing (Figure 4-6).

These figures follow the *Backup Diskette Procedure Form*.

Operator: Before you begin the backup customization procedure, read over this form. Check to make sure that your planner has provided answers for every question. This is a step-by-step procedure for creating a backup system diskette for an existing 3274 Control Unit configuration. *If you do not get the expected result in any step, start over at **Step 1**. If you still do not get the expected result, report the problem to your planner.*

Step 1. Check the Control Unit.

Check that the power is switched on for the 3274 Control Unit. The display station that will be used to customize should be attached to port A0 of the control unit.

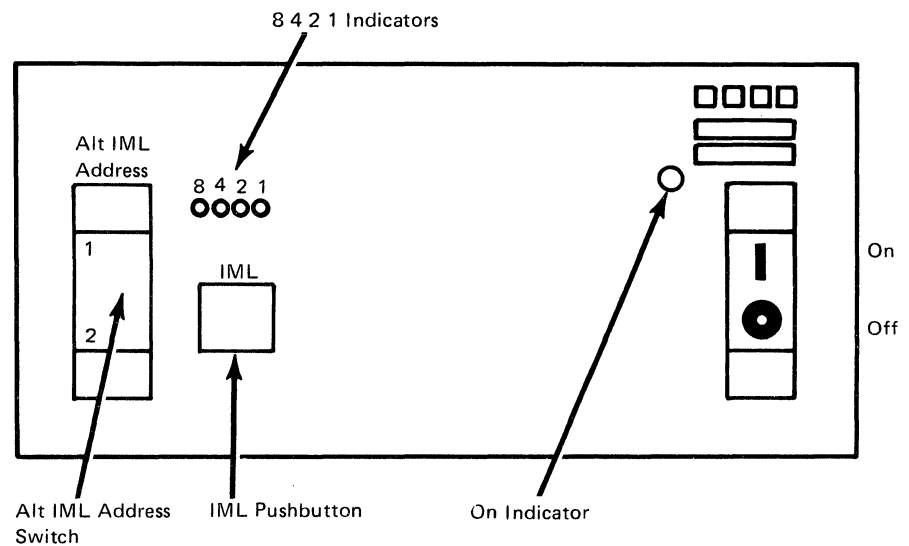

On the 3274 control panel (shown above), there are four indicator lights labeled 8 4 2 1. The lights can be *on* or *off*, and the pattern in which they are turned on or off makes a code designed to show you the progress of the customization procedure and to let you know whether you need to take any specific action. There are both steady light indicator codes and flashing light indicator codes. A flashing light usually indicates that you need to take an action, the next step in the process. If an error occurs during customizing, the 8 4 2 1 indicator codes may help you locate the cause:

- An indicator that is *on* (lighted up) is called a 1.
- An indicator that is *off* (not lighted) is called a 0 (zero).

For example:

```

8 4 2 1
* * o * = 1 1 0 1

```

Charts of the indicator codes and their meaning (Figures 4-4 and 4-5) are located at the end of this form.

Step 2. Check the Keyboard.

You need to work at a 3178, 3278, or 3279 display station with a keyboard attached. Check that the display station has its power switched on, and that it is attached to port A0 of the 3274 Control Unit. You will use this type of keyboard:

- Typewriter
- Data Entry Keypunch
- Data Entry
- Japanese Katakana Typewriter
- Japanese Katakana Data Entry
- Japanese English Typewriter

When you are customizing, only certain keys will be active. Turn to Figures 4-1 and 4-2 at the end of this form, to see which keys on your keyboard can be used for customizing.

Step 3. Collect the Diskettes.

To customize a backup diskette, you will need these diskettes. Obtain them from your planner.

- Feature diskette
- Customized system diskette (to be duplicated)
- Backup system diskette (to be customized)
- Language diskette (if necessary)
- RPQ diskette(s) (if necessary)

1. _____
2. _____
3. _____

Step 4. Insert the Feature Diskette.

a. All Models except 51C

1. Open the customer access door, and locate the diskette reader enclosure.

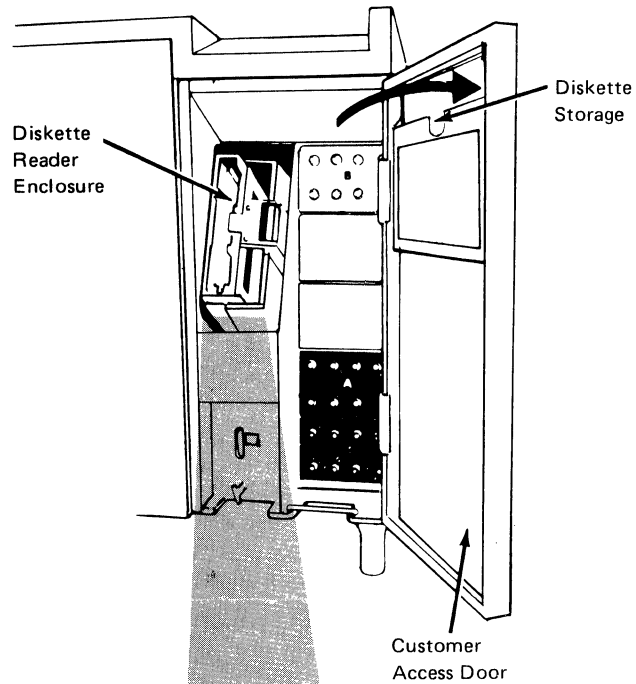

2. Open the diskette reader enclosure door by pressing the latch to the right.

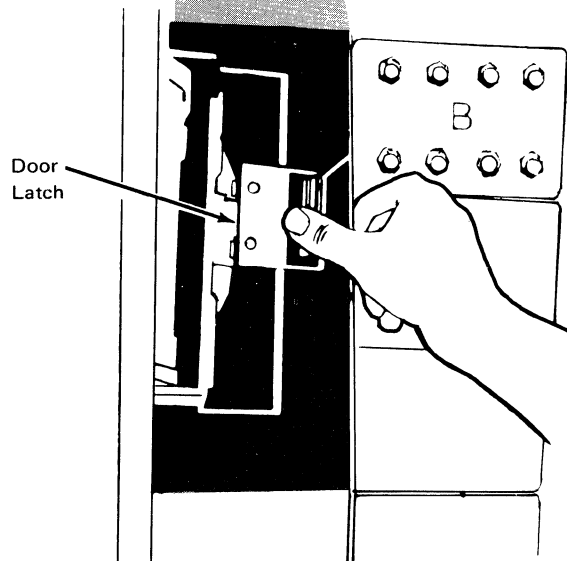

3. Remove the feature diskette to be used with the 3274 from its gray protective envelope, and insert it squarely into the enclosure. Note that the diskette label position is to the right.

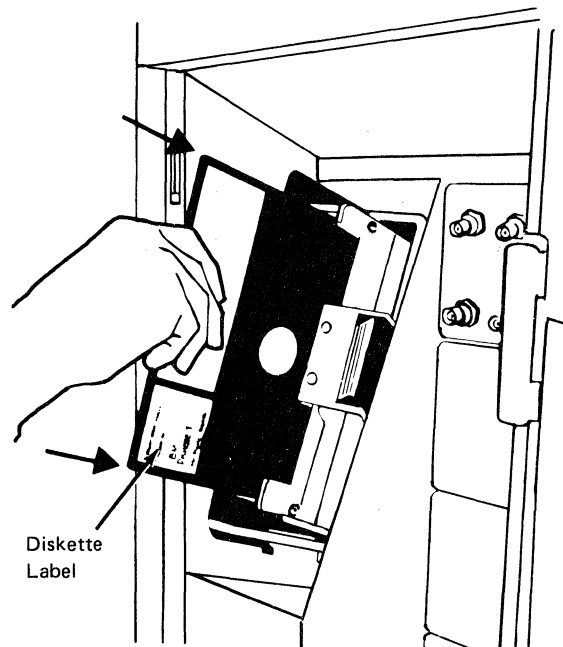

4. Close the diskette reader enclosure door by pushing the door to the left until it latches (clicks).

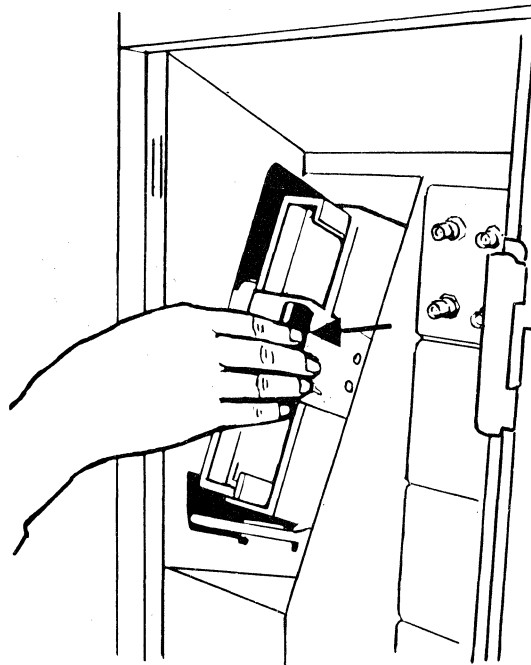

5. While holding the Alt IML Address switch in position 1, press and release the IML pushbutton.

6. Then release the Alt IML Address switch. Within 2 minutes, you should see this flashing indicator code:

0 1 0 1

b. Model 51C

1. Open the diskette reader by turning the operator lever to the vertical position.

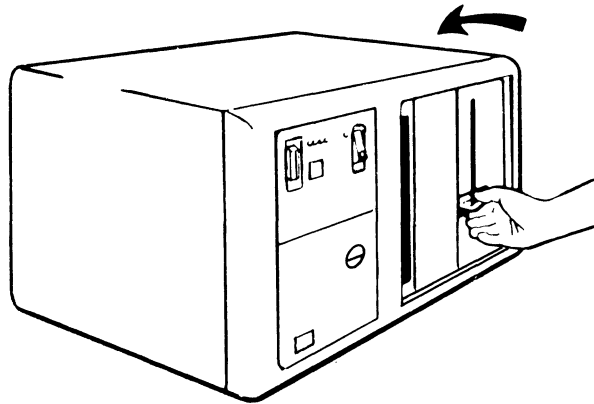

2. Remove the diskette to be used with the 3274 from its gray protective envelope, and insert it squarely into the enclosure. Note that the diskette label position is on your left.

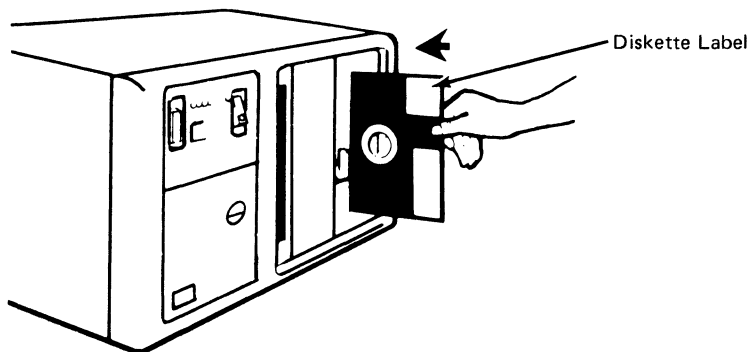

3. Close the diskette reader by turning the operator lever to the horizontal position.

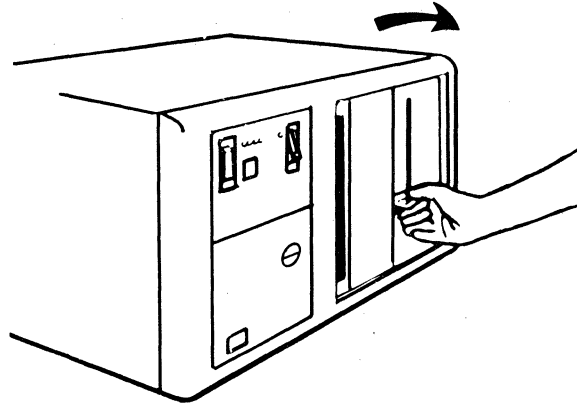

4. While holding the Alt IML Address switch in position 1, press and release the IML pushbutton.
5. Then release the Alt IML Address switch. Within 2 minutes, you should see this flashing indicator code:

0 1 0 1

Step 5. Insert the Customized System Diskette.

Remove the feature diskette and insert the customized system diskette into the 3274. Within 1 minute, the 8 4 2 1 indicator code will be flashing 1110. Remove the customized system diskette.

Step 6. Insert the Feature Diskette Again.

Insert the feature diskette again. Within 1 minute, the 8 4 2 1 indicator code will be a steady 0001.

If you are using a 3279 Color Display Station, refer to Appendix E in the *3274 Control Unit Planning, Setup, and Customizing Guide, GA27-2827*, for instructions on the convergence procedure.

Step 7. Enter Responses for the Initial Questions.

The first few questions you need to answer for customization are presented on your screen one by one, in sequence. (The questions are called *sequence numbers*.) Then the remaining sequence numbers are grouped together and presented in panels displayed on your screen.

Before you begin to enter the responses to the customizing questions, read these instructions:

1. If any spaces are blank, ask your planner about them.
2. Enter the responses as they are marked on this form. After you have entered a response, a program checks your entries. If there are any problems, the invalid response is displayed with intensified brightness and an operator code is displayed at the upper center portion of the screen. The operator code will help you figure out the problem. A list that explains the meaning of each code (Figure 4-3) is included with this form.
3. Use only the cursor move keys or the Tab (→) key to position the cursor.

Sequence Number 001

The first sequence number is 001. Look for it in the upper left corner of your screen.

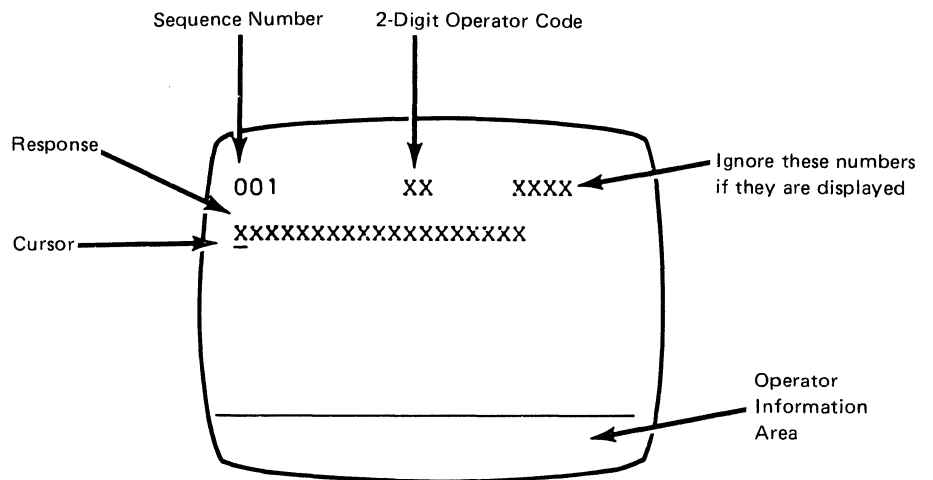

Beneath the sequence number is a row of Xs, which you will replace when you key in the response.

Note: If a 76- or 88-key Japanese English or Katakana keyboard is used, press the key circled on the keyboard illustrated in Figure 4-2. The keyboard will be locked for about 10 seconds. When the keyboard unlocks, you can enter your response to sequence number 001.

1. **Response:** 1234567890ABCDEF
2. Press the spacebar once.
3. Type in the 2-digit validation number that is printed on the *system* diskette label.
4. Press ENTER.

Sequence Number 011

The default response displayed on the screen is 0.

1. **Response:** 0
2. Press ENTER.

Sequence Number 021

At this time, either sequence number 021 is displayed (meaning no printer authorization matrix has been defined) or the defined matrix is displayed.

1. If sequence number 021 is displayed, the default is 0 (zero).
 - Press ENTER.
2. If the printer authorization matrix is displayed:
 - Move the cursor to the entry after 901 (at the bottom of the screen) and change it to a 1.
 - Press ENTER.

Sequence Number 031

Type in the number (0–3) of RPQ diskettes being used. The default is 0 (zero).

1. **Response:**
2. Press ENTER.

Step 8. Enter Response for the Sequence Number 999 Panel.

A panel of sequence numbers should now be displayed on your screen.

1. Move the cursor to the zero after sequence number 900, and change it to a 1.
2. Press ENTER.

Step 9. Enter Response for the Sequence Number 332 Panel.

The entire panel should now be displayed on your screen.

1. Move the cursor to the 0 (zero) after sequence number 908, and change it to a 1.
2. Press ENTER.

Step 10. Change Diskettes.

Within 2 minutes, the 8 4 2 1 indicator code on the control panel will flash one of the following codes:

1100:

1. Replace the feature diskette with the RPQ diskette. *Do not press the IML pushbutton.* (If you do press the IML pushbutton, begin again at Step 4.) After you insert the RPQ diskette, the steady code will change to 0111 within 30 seconds.
2. If the indicator code again flashes 1100, either additional RPQ diskettes are needed or you inserted a non-RPQ diskette. Insert each additional RPQ diskette. *At no time should you press the IML pushbutton.*
3. When the indicator code flashes 1110, the RPQ diskette procedure is completed. Reinsert the feature diskette. *Do not press the IML pushbutton.*
4. Within 2 minutes, the 8 4 2 1 indicator code will flash 1101 or 1011. (Those indicators are explained below.)

1101:

1. Replace the feature diskette with the language diskette. *Do not press the IML pushbutton.* (If you do press the IML pushbutton, begin again at Step 4.) Within 30 seconds, the indicator code will change to 0111 and then to flashing 1011 within 1 minute.

2. When the indicator code is flashing 1011, replace the language diskette with the backup system diskette. *Do not press the IML pushbutton.* Within 1 minute, the 8 4 2 1 indicator code will change to 1000 and remain that way for approximately 15 minutes. (If errors occur during this 15-minute period, a flashing 8 4 2 1 indicator code will appear. The meaning of these codes is explained in Figures 4-4 and 4-5.) Then the steady code indicator will change to 1111 (all lights on), indicating that the backup system diskette has been successfully generated.

1011:

Replace the feature diskette with the backup system diskette. *Do not press the IML pushbutton.* (If you do press the IML pushbutton, begin again at **Step 4**.) Within 1 minute, the 8 4 2 1 indicator code will change to 1000 and remain this way for approximately 15 minutes. (If errors occur during this 15-minute period, a flashing 8 4 2 1 indicator code will appear. The meaning of these codes is explained in Figures 4-4 and 4-5.) Then the steady code indicator will change to 1111 (all lights on), indicating that the backup system diskette has been successfully generated.

The newly created backup system diskette may now be used as well as the existing customized diskette. When you are sure the 3274 is attached to the appropriate communication facility, you may use the backup system diskette to initiate an IML of the 3274. During IML, errors may occur because of improper backup diskette generation. Check Figure 4-6 for the meaning of those indicator codes that you will see.

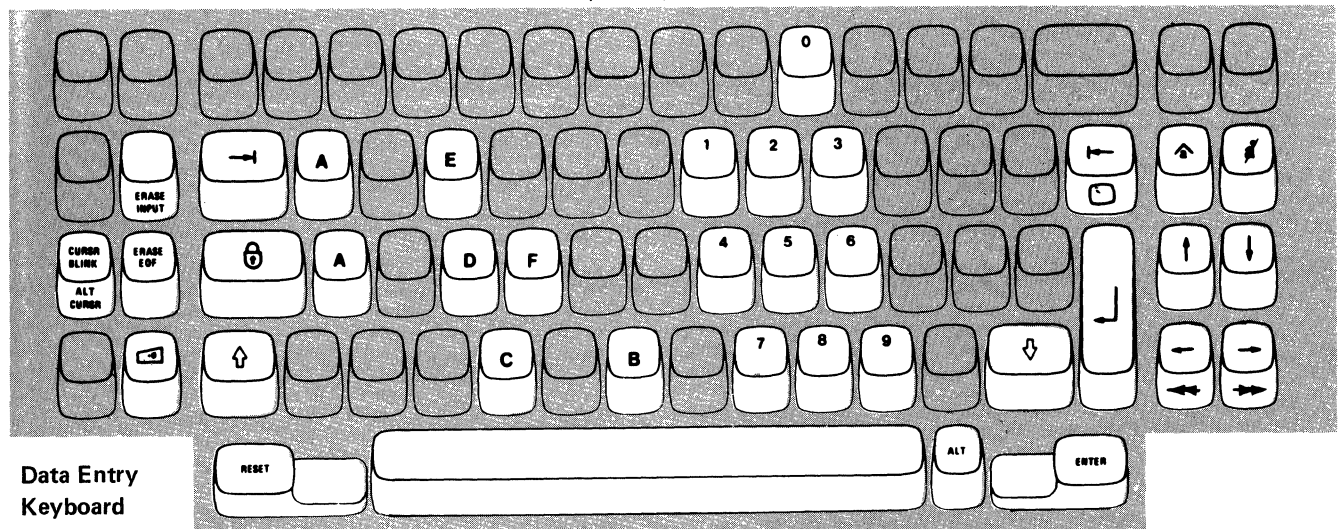
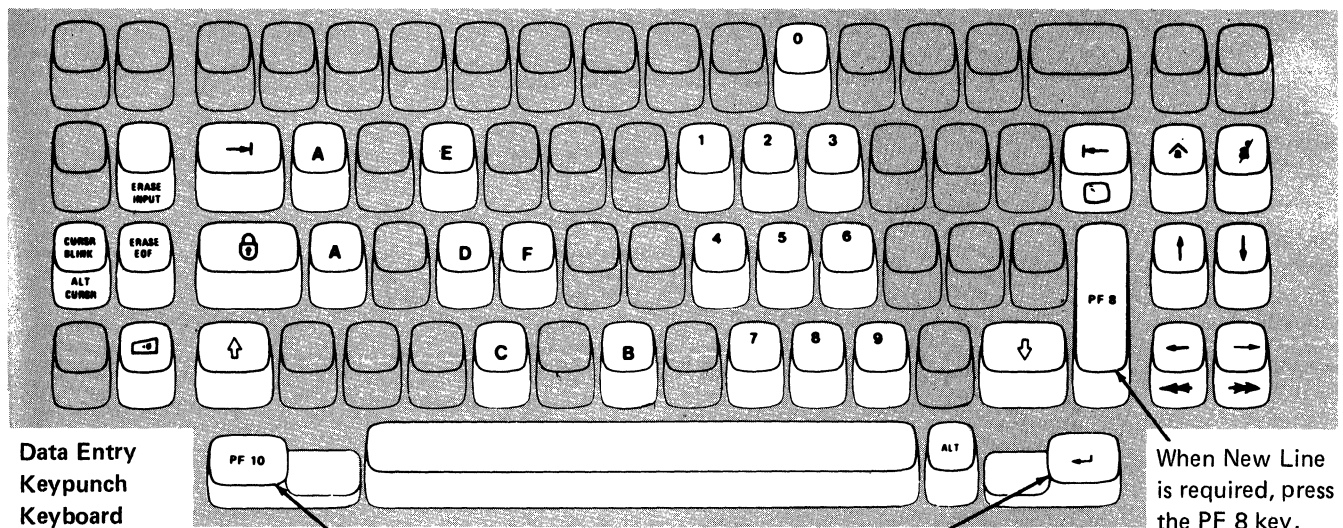
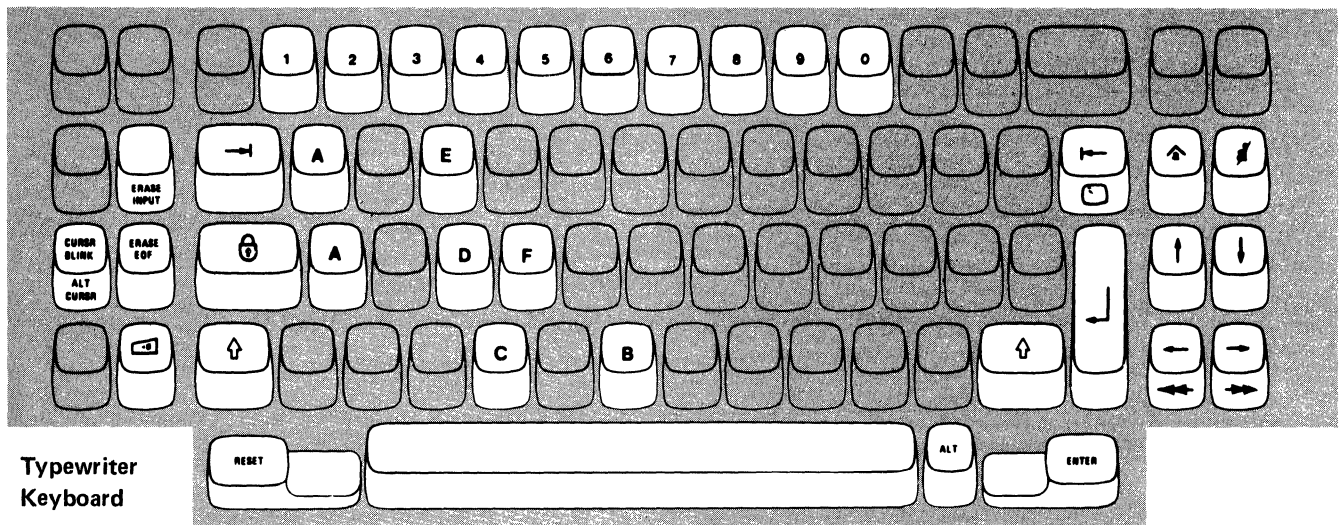

Note: During backup diskette generation, only certain key positions are valid. Only those key positions shown above are to be used.

Figure 4-1. Valid Key Positions during Backup Diskette Generation

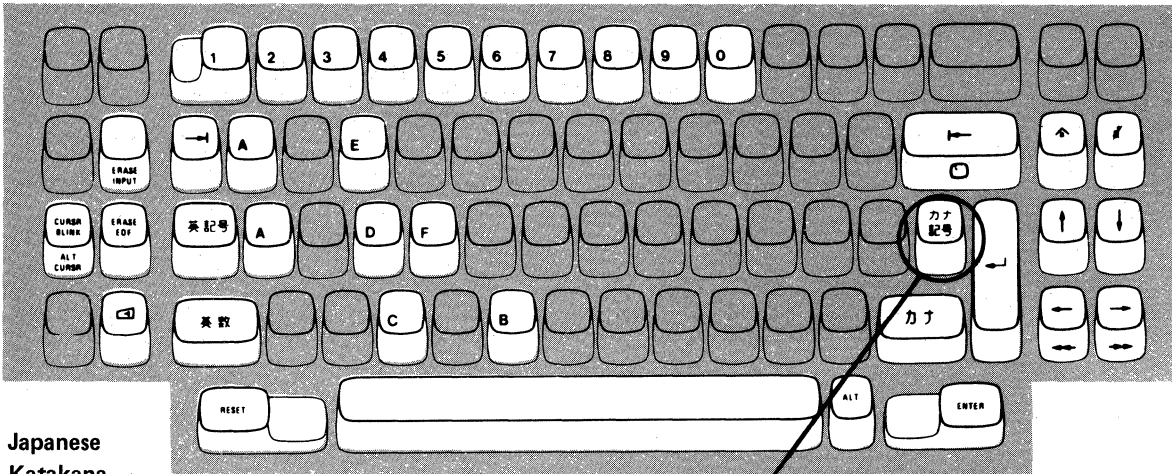

Japanese
Katakana
Typewriter
Keyboard

Press this key when sequence number 001 appears in the upper left corner of the screen.

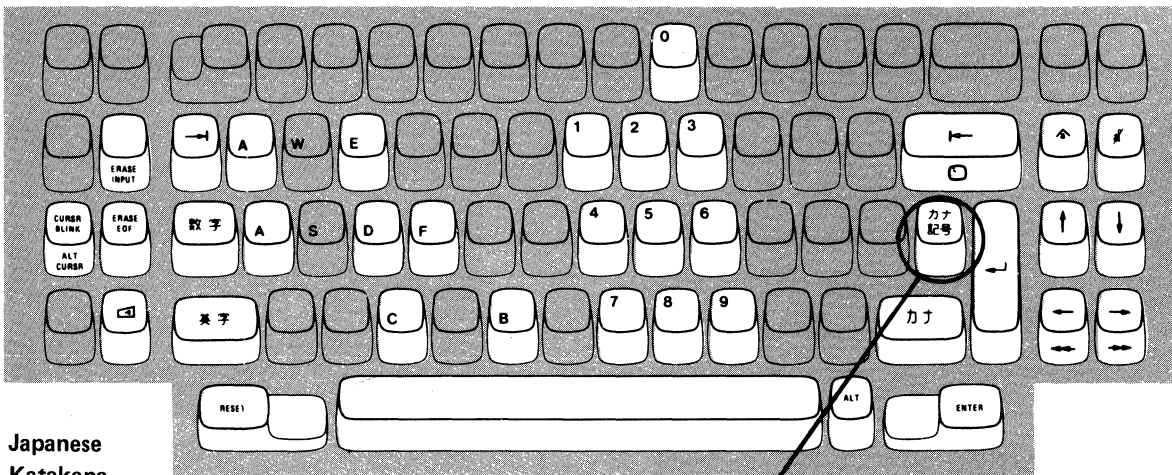

Japanese
Katakana
Data Entry
Keyboard

Press this key when sequence number 001 appears in the upper left corner of the screen.

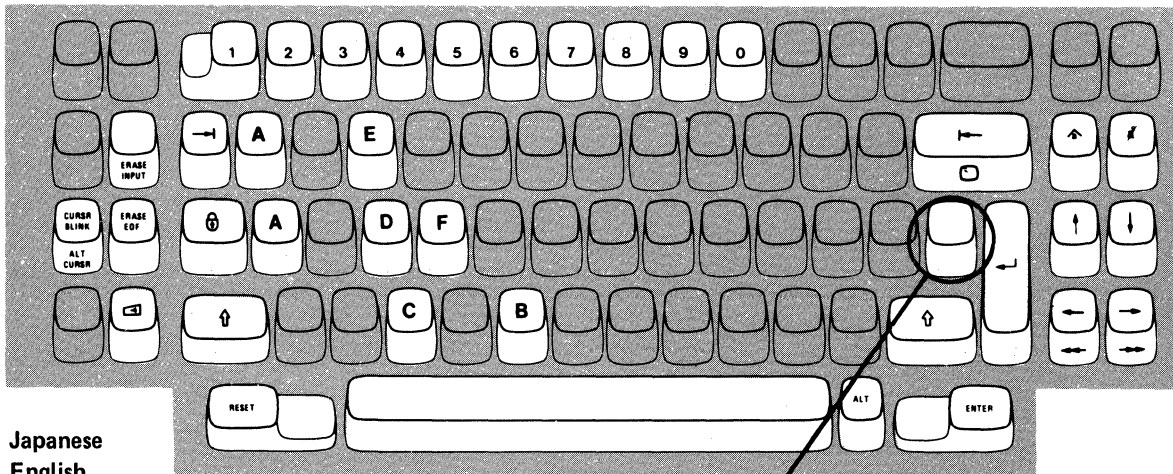

Japanese
English
Typewriter
Keyboard

Press this key when sequence number 001 appears in the upper left corner of the screen.

Note: These drawings show the valid keys for both the 76- and 88-key keyboards. The PF keys located on the right side of the 88-key keyboards are not shown and are not valid during this procedure.

Figure 4-2. Valid Key Positions during Backup Diskette Generation When Japanese Katakana and Japanese English Keyboards Are Used

Code	Meaning	Action
01	One or more of the first 10 characters are incorrect.	Enter the correct response.
02	One or more of the 11th to 17th characters, including the space, are incorrect.	Enter the correct response.
03	1. One of the last two characters you entered in response to sequence number 001 is incorrect, or 2. The diskette release level is not the same as the documentation level.	1. Enter the correct response. 2. Restart after matching diskette and documentation levels.
11 ¹	You entered an invalid response (too many characters, value too high or too low, wrong character, etc.).	Enter the correct response.
12 ¹	You entered other than 01C, 31C, or 51C in response to sequence number 151 (3274 model designation).	Enter the correct response.
13 ¹	Your response has too few characters.	Enter the correct response.
14 ¹	The numeric total of the responses you entered for sequence numbers 111 (number of Category B terminals) and 112 (number of Category A terminals) is greater than 32 (01C, 31C) or 12 (Model 51C).	Enter the correct responses.
21 ¹	You made an unacceptable change during the modify sequence (number 999).	Recheck the entries, and correct them.
41	The X.25 network type (400) is invalid.	Check the network type values and enter a valid response to 400.
42	The incoming call options (420) response included "Validate Host DTE Address," but the address was not entered in response to 410.	Either respond to 410 with the host address or do not include "Validate Host DTE Address" in response to 420.
43	1. The circuit type (401) chosen requires a host address (410). 2. The outgoing call options chosen included "Validate 3274 DTE Address," but the address was not entered in response to 411. 3. The response to 421 was invalid.	1. Either change the response to 401 or provide a host DTE address (410). 2. Either respond to question 411 with the 3274 address or do not include "Validate 3274 DTE Address" in response to 421. 3. Check 421 and enter a valid response.
44	Negotiated window size (432) or nonstandard window size (435) conflicts with packet sequence numbering (431).	If 431 equals 0, then 432/435 must equal 01–07 (two digits). If 431 equals 1, then 432/435 must equal 01–11 (two digits).
45	The circuit type (401) is invalid.	Check the circuit type values and correct the response.
46	An invalid X.25 keyboard support (443) was selected.	Check the X.25 keyboard support and correct the response.
47	No CID password was initialized (452), but a CID is required for call options (420 and/or 421).	Either change call options to remove the CID requirement or enter a CID password (452).
99	Your entries are acceptable, but the entry for sequence number 900 or 901 has not been changed to a 1.	Change the 900 or 901 entry to a 1.

¹If any entry is unacceptable, the entry for sequence number 900 is changed back to 0 (zero) and the unacceptable value is intensified.

Figure 4-3. Operator Codes during Backup Diskette Generation Only

Steady Code	Diskette Mounted	Meaning	Action
0001	Feature	Customizing being performed	None.
0010	Any (indication lasts for 3 minutes or more!)	Diskette improperly inserted or an internal 3274 error	Insert diskette properly and retry.
0011	Feature	Customizing being performed	None.
0100	Feature	Patch, printer authorization matrix, or RPQ being performed	None.
0101	Feature	Configuration being performed	None.
0110	Feature	Modification being performed	None.
0111	Feature, language, or RPQ	Normal 3274 operation	None.
1000	System (customizing in process)	Normal 3274 operation	None.
1001	Any	Internal 3274 error	Retry. If the error recurs, follow your local procedure for problem recovery.
1010	Any	Internal 3274 error	Retry. If the error recurs, follow your local procedure for problem recovery.
1101	Any (customizing procedure in progress)	1. IML pushbutton pressed while diskette is being changed, or 2. A bad or uncustomized system diskette is being used	1. Recustomize. Do not press the IML pushbutton unless instructed to do so. 2. Insert a good customized system diskette.
1111	System (IML not performed)	Customizing is completed	IML can be performed.

Figure 4-4. Steady 8 4 2 1 Indicator Codes during Backup Diskette Generation Only

Flashing Code ¹	Diskette Mounted	Meaning	Action
0000 0101	Any	System diskette request	Insert system diskette.
0000 1010	System	A diskette read error occurred.	Retry. If the error recurs, follow your local procedure for problem recovery.
0000 1011	Any	System diskette request	Insert system diskette.
0000 1100	Any	RPQ diskette request	Insert RPQ diskette.
0000 1101	Any	Language diskette request	Insert language diskette.
0000 1110	Any	Feature diskette request	Insert feature diskette.
0100 0010	System	Configuration on system diskette being used for update-diskette procedure is not compatible with this 3274	Use a system diskette with a compatible configuration.
1000 0001	System	Uncustomized system diskette being used during update procedure	Use customized system diskette.
1001 0110	Any	Wrong-level diskette being used	Use correct-level diskette.
1111 0001	Feature	On/Off switch or TEST key pressed instead of ENTER	Retry. If the error recurs, follow your local procedure for problem recovery.
	System	Internal 3274 error	Follow your local procedure for problem recovery.
1111 0011	Feature	Internal 3274 error	Follow your local procedure for problem recovery.
1111 0100	System	Internal 3274 error	Retry. If the error recurs, follow your local procedure for problem recovery.
1111 0101	System	Internal 3274 error	Retry. If the error recurs, follow your local procedure for problem recovery.
	Feature	On/Off switch or TEST key on the 3278 pressed instead of ENTER	
1111 0110	RPQ	Incompatible RPQs	Follow your local procedure for problem recovery.
	Feature	Internal 3274 error	
1111 0111	System	Internal 3274 error	Follow your local procedure for problem recovery.
1111 1000	System	Internal 3274 error	Follow your local procedure for problem recovery.
1111 1001	System	Internal 3274 error	Follow your local procedure for problem recovery.
1111 1010	Any	Internal 3274 error	Follow your local procedure for problem recovery.
1111 1011	System	Internal 3274 error	Follow your local procedure for problem recovery.
1111 1100	Any	Diskette drive error or a bad diskette	Retry. If the error recurs, follow your local procedure for problem recovery.
1111 1101	System or feature	Diskette drive error or a bad diskette	Retry. If the error recurs, follow your local procedure for problem recovery.
1111 1110	Any	Internal 3274 error	Retry. If the error recurs, follow your local procedure for problem recovery.

¹ These codes will flash alternately as shown, for example, 0000, 1011, 0000, 1011.

Figure 4-5. Flashing 8 4 2 1 Indicator Codes during Backup Diskette Generation Only

Steady Code	Flashing Code ¹	Diskette Mounted	Meaning	Action
—	0000 0101	System	Internal 3274 error or wrong response to sequence number 113 during customizing	Check response to sequence number 113, and retry. If the error recurs, follow your local procedure for problem recovery.
—	0000 0110	System	Internal 3274 error or wrong response to sequence number 111, 112, or 151 during customizing	Check response to sequence number 111, 112, or 151 and retry. If the error recurs, follow your local procedure for problem recovery.
—	0000 0111	System	1. Internal 3274 error, or 2. Wrong response to sequence number 311 or 343, or 3. The 3274 is not connected to the communication facility	1 and 2. Check responses to sequence numbers 311 and 343, and retry. 3. Connect the 3274 to the communication facility. If the error recurs, follow your local procedure for problem recovery.
—	0000 1000	System	Internal 3274 error or wrong response to sequence number 111 during customizing	Check response to sequence number 111, and retry. If the error recurs, follow your local procedure for problem recovery.
1101	—	System	Uncustomized system diskette	Insert customized system diskette.
1110	—	System	Insufficient storage	Check response to sequence number 113, and retry. If the error recurs, follow your local procedure for problem recovery.

¹ These codes will flash alternately as shown, for example, 0000, 0101, 0000, 0101.

Note: These indicators may be caused by something other than incorrect customizing. Further aids can be found in the *IBM 3270 Information Display System: 3274 Control Unit Problem Determination Guide*, GA27-2850.

Figure 4-6. Flashing 8 4 2 1 Indicator Codes during IML That May Result from an Incorrect Customizing Procedure

Chapter 5. Modification Procedure

The *Modification Procedure Form* is used to modify an existing 3274 configuration. The planner uses the form contained in this chapter only after initially customizing the 3274, as described in Chapter 3.

Note: Changes to any of the following sequence numbers will cause extensive configuration changes. To change these sequence numbers, use the initial customizing procedure in Chapter 3. Plan carefully before making these changes.

- 151 Model designation
- 302 X.25 secondary station address
- 343 Communication interface options.

After the changes are made, be sure that they are recorded on the *IBM 3274 Configuration Data Card (Configuration Support: P)*, GA23-0177, stored in the diskette storage area of the 3274.

The planner should fill out the *Modification Procedure Form* that the operator will use. Then the planner should give the form and the following information to the operator who will perform the modification procedure:

- Keyboard diagrams showing the valid key positions for customizing (Figures 5-1 and 5-2)
- An "Operator Codes" chart that gives the meaning and recommended actions for the operator codes that may appear on the display screen during the modification procedure (Figure 5-3)
- "8 4 2 1 Indicator Codes" charts that give the meaning and recommended actions for the indicator codes that routinely appear on the 3274 control panel during the modification procedure (Figures 5-4 and 5-5)
- An "8 4 2 1 Indicator Code" chart that gives the meaning and recommended actions for the indicator codes that may appear on the 3274 control panel during IML because of improper modification (Figure 5-6)
- A *Printer Authorization Matrix Form*, which may be used with sequence number 022.

These figures follow the *Modification Procedure Form*.

Operator: Before you begin the customizing procedure, read over this form. Check to make sure that your planner has provided answers for every question. This is a step-by-step procedure for modifying an existing 3274 Control Unit configuration. *If you do not get the expected result in any step, start over at Step 1. If you still do not get the expected result, report the problem to your planner.*

You can negate the modification procedure at any time before Step 11 by inserting the customized system diskette and pressing the IML pushbutton. This action will return your system to the previous customization level.

Step 1. Check the Control Unit.

Check that the power is switched on for the 3274 Control Unit. The display station that will be used to customize should be attached to port A0 of the control unit.

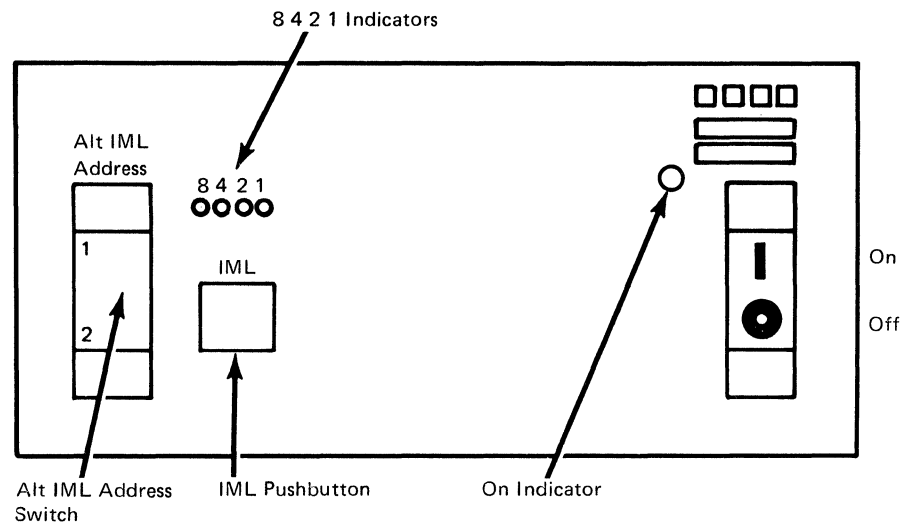

On the 3274 control panel (shown above), there are four indicator lights labeled 8 4 2 1. The lights can be *on* or *off*, and the pattern in which they are turned on or off makes a code designed to show you the progress of the customization procedure and to let you know whether you need to take any specific action. There are both steady light indicator codes and flashing light indicator codes. A flashing light usually indicates that you need to take an action, the next step in the process. If an error occurs during the customizing procedure, the 8 4 2 1 indicator codes may help you locate the cause:

- An indicator that is *on* (lighted up) is called a 1.
- An indicator that is *off* (not lighted) is called a 0 (zero).

For example:

8 4 2 1
* * o * = 1 1 0 1

Charts of the indicator codes and their meaning (Figures 5-4 and 5-5) are located at the end of this form.

Step 2. Check the Keyboard.

You need to work at a 3178, 3278, or 3279 display station with a keyboard attached. Check that the display station has its power switched on, and that it is attached to port A0 of the 3274 Control Unit. You will use this type of keyboard:

- Typewriter
- Data Entry Keypunch
- Data Entry
- Japanese Katakana Typewriter
- Japanese Katakana Data Entry
- Japanese English Typewriter

When you are customizing, only certain keys will be active. Turn to Figures 5-1 and 5-2, at the end of this form, to see which keys on your keyboard can be used for customizing.

Step 3. Collect the Diskettes.

To customize the control unit, you will need these diskettes. Obtain them from your planner.

- Feature diskette
- Customized system diskette
- Language diskette (if necessary)
- RPO diskette(s) (if necessary)

1. _____
2. _____
3. _____

Step 4. Check for the Form You Need.

If this form is checked, you need a copy with the information entered by your planner:

- Printer Authorization Matrix Form

Step 5. Insert the Feature Diskette.

a. All Models except 51C

1. Open the customer access door, and locate the diskette reader enclosure.

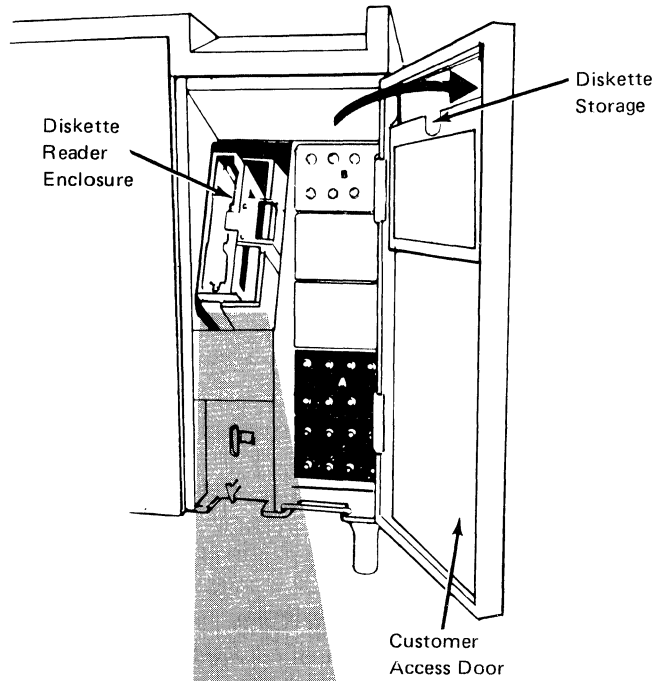

2. Open the diskette reader enclosure door by pressing the latch to the right.

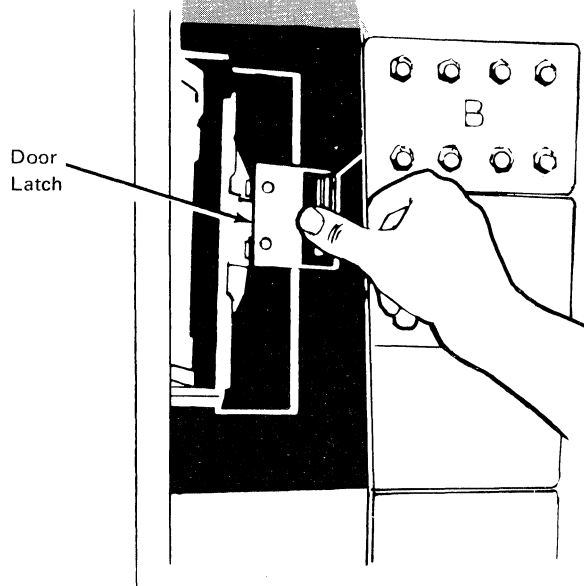

3. Remove the feature diskette to be used with the 3274 from its gray protective envelope, and insert it squarely into the enclosure. Note that the diskette label position is to the right.

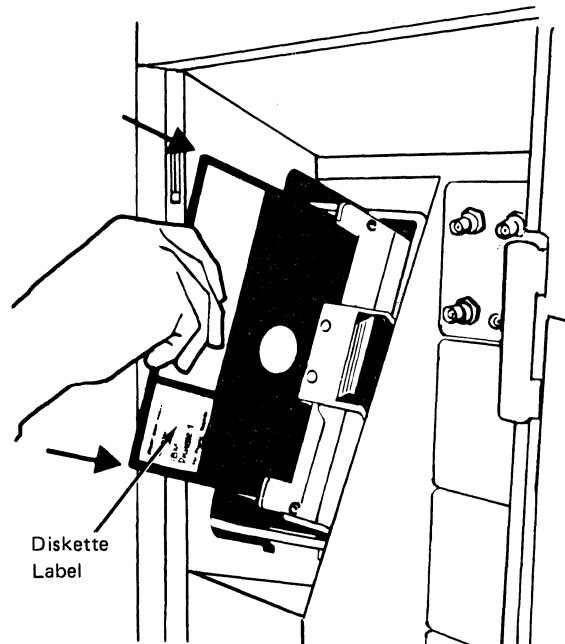

4. Close the diskette reader enclosure door by pushing the door to the left until it latches (clicks).

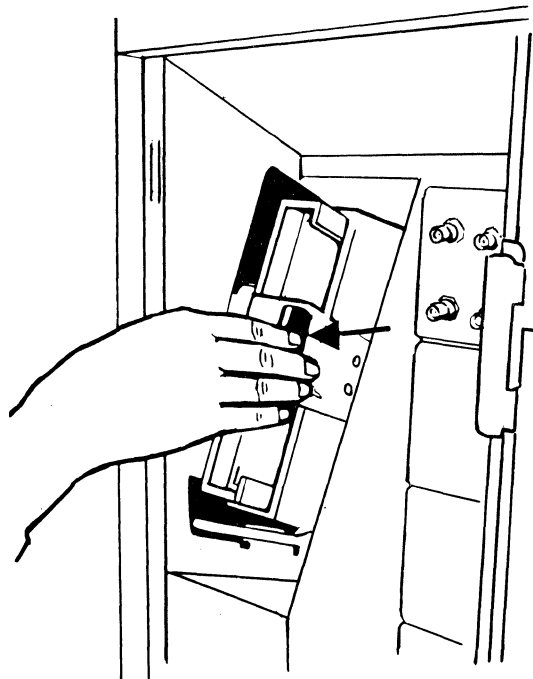

5. While holding the Alt IML Address switch in position 1, press and release the IML pushbutton.

6. Then release the Alt IML Address switch. Within 2 minutes, you should see this flashing indicator code:

8 4 2 1
1 0 1 1

b. Model 51C

1. Open the diskette reader by turning the operator lever to the vertical position.

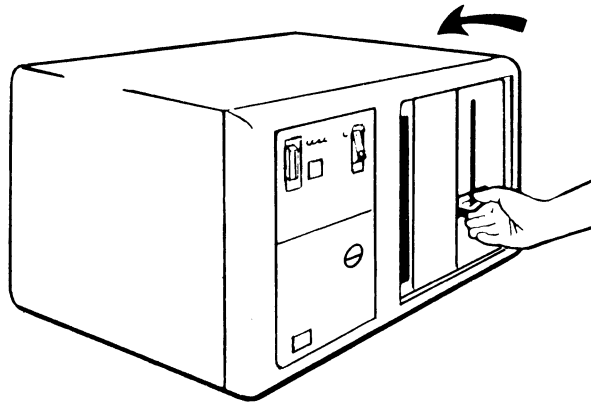

2. Remove the feature diskette to be used with the 3274 from its gray protective envelope, and insert it squarely into the enclosure. Note that the diskette label position is on your left.

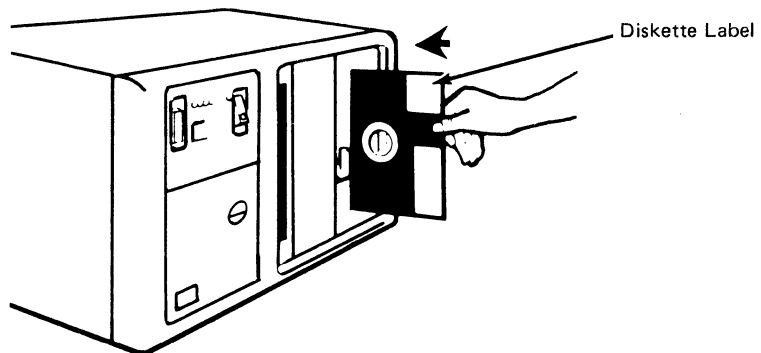

3. Close the diskette reader by turning the operator lever to the horizontal position.

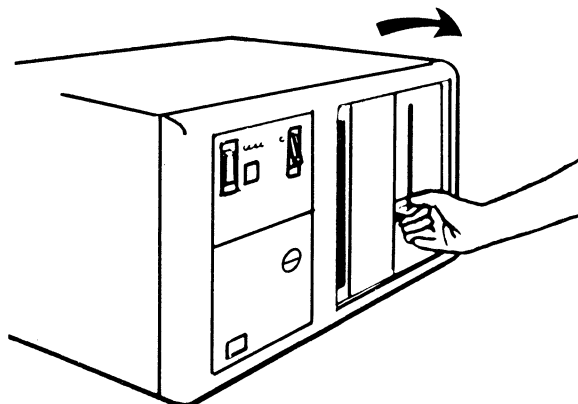

4. While holding the Alt IML Address switch in position 1, press and release the IML pushbutton.

5. Then release the Alt IML Address switch. Within 2 minutes, you should see this flashing indicator code:

8 4 2 1
1 0 1 1

Step 6. Insert the Customized System Diskette.

Remove the feature diskette and insert the customized system diskette into the 3274. Within 1 minute, the 8 4 2 1 indicator code will be flashing 1110. Remove the customized system diskette.

Step 7. Insert the Feature Diskette Again.

Insert the feature diskette again. Within 1 minute, the 8 4 2 1 indicator code will be a steady 0001.

If you are using a 3279 Color Display Station, refer to Appendix E in the *3274 Control Unit Planning, Setup, and Customizing Guide, GA27-2827*, for instructions on the convergence procedure.

Step 8. Enter Responses for the Initial Modification Questions.

The first few questions you need to answer for customization are presented on your screen one by one, in sequence. (The questions are called *sequence numbers*.) Then the remaining sequence numbers are grouped together and presented in panels displayed on your screen.

Before you begin to enter the responses to the customizing questions, read these instructions:

1. Enter the responses as they are marked on this form. After you have entered a response, a program checks your entries. If there are any problems, the invalid response is displayed with intensified brightness and an operator code is displayed at the upper center portion of the screen. The operator code will help you figure out the problem. A list that explains the meaning of each code (Figure 5-3) is included with this form.

2. Use only the cursor move keys or the Tab key to position the cursor.

Sequence Number 001

The first sequence number is 001. Look for it in the upper left corner of your screen.

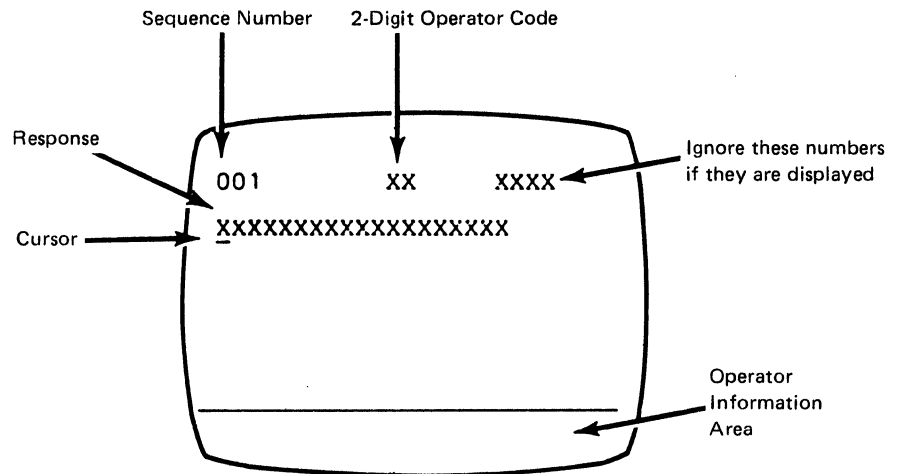

Beneath the sequence number is a row of Xs, which you will replace when you key in the response. If the response you enter is acceptable, a new sequence number is displayed. If the response is unacceptable, a 2-digit operator code is displayed in the upper, center portion of the screen. See Figure 5-3 for the meaning of this code.

Note: If a 76- or 88-key Japanese English or Katakana keyboard is used, press the key circled on the keyboard illustrated in Figure 5-2. The keyboard will be locked for about 10 seconds. When the keyboard unlocks, you can enter your response to sequence number 001.

1. **Response:** 1234567890ABCDEF
2. Press the spacebar once.
3. Type in the 2-digit validation number that is printed on the *system* diskette label.
4. Press ENTER.

Sequence Number 011

The default response displayed on the screen is 0.

1. **Response:** 0
2. Press ENTER.

Sequence Number 021

At this time, either sequence number 021 is displayed (if no printer authorization matrix was defined at customization) or the defined matrix is displayed.

1. If sequence number 021 is displayed, the default is 0 (zero). If you have not been given a *Printer Authorization Matrix Form*:

Press ENTER.

2. If sequence number 021 is displayed, and you have been given the *Printer Authorization Matrix Form*:

- Type in 1.
- Press ENTER.
- **Sequence Number 022** (a panel) is displayed. Follow the instructions on the form.

3. If **Sequence Number 022** (Printer Authorization Matrix) is displayed and you want to make changes, enter the changes. After you have finished:

- Move the cursor to the entry after 901 (at the bottom of the screen) and change it to a 1.
- Press ENTER.

4. If **Sequence Number 022** (Printer Authorization Matrix) is displayed and you have no changes to make:

- Move the cursor to the entry after 901 (at the bottom of the screen) and change it to a 1.
- Press ENTER.

Sequence Number 031

Type in the number (0–3) of RPQ diskettes being used. The default response displayed on the screen is 0.

1. Response:

2. Press ENTER.

Step 9. Enter Changes for the Sequence Number 999 Panel.

A panel of sequence numbers should now be displayed on your screen. On the layout below, your planner has recorded the changes to be made.

999		
111 - <input type="text"/>	112 - <input type="text"/>	113 - <input type="text"/>
121 - <input type="text"/>	141 - <input type="text"/>	
151 - <input type="text"/>	161 - <input type="text"/>	
213 - <input type="text"/>	215 - <input type="text"/>	
302 - <input type="text"/>	311 - <input type="text"/>	343 - <input type="text"/>
900 - 0		

1. Change the responses as required. Just press the Tab (\rightarrow) key to move the cursor left to right from one sequence number to the next.

Note: If there is a 1-digit response for a 2-digit box, use leading zeros (for example, 02 for 2).

2. After all the changes have been made, check your entries with those marked on the sequence number 999 layout. If you need to change any of your entries, move the cursor to the entry to be changed and type in the new response. Do not try to change the sequence number itself.

3. When all the entries are correct, move the cursor to the 0 (zero) after sequence number 900, and change it to a 1.

4. Press ENTER.

If any entry is unacceptable, the entry to sequence number 900 is changed back to 0 and the unacceptable response is displayed more brightly. (On the 3279, the intensified characters change to white and red instead of blue and green.) The upper center portion of the screen displays a 2-digit operator code. If several responses are intensified, then the displayed operator code will refer to the responses in numeric order, from largest to smallest:

1. Correct the response to the largest sequence number that is intensified.

2. Press ENTER. The operator code will change to explain the next error.

3. Continue correcting the responses, as described in steps 1 and 2, until there are no intensified sequence numbers. This means all the entries are corrected. Move the cursor to the 0 (zero) after sequence number 900, and change it to a 1.

4. Press ENTER.

5. If there are still unacceptable entries intensified, report the problem.

Step 10. Enter Changes for the Sequence Number 332 Panel.

The entire panel should now be displayed on your screen.

Here is the sequence number 332 layout with the changes to be made.

332		##/XXX/25	
400 - <input type="text"/>	401 - <input type="text"/>	402 - <input type="text"/>	403 - <input type="text"/>
410 - <input type="text"/>	411 - <input type="text"/>		
420 - <input type="text"/>	421 - <input type="text"/>		
430 - <input type="text"/>	431 - <input type="text"/>	432 - <input type="text"/>	433 - <input type="text"/>
434 - <input type="text"/>	435 - <input type="text"/>		
440 - <input type="text"/>	441 - <input type="text"/>	442 - <input type="text"/>	443 - <input type="text"/>
450 - <input type="text"/>	451 - <input type="text"/>	452 - <input type="text"/>	
			908 - 0

1. Change the responses as required. Just press the Tab (→) key to move the cursor left to right from one sequence number to the next.

Note: If there is a 1-digit response for a 2-digit box, use leading zeros (for example, 02 for 2).

410, 411, and 452: The response to these questions may not fill the entire field. You may leave Ns wherever you have not entered an alphanumeric character. If you press EOF to clear to the end of the field, a slash (/) will be displayed to mark the end of the original response field. Should you ever modify the response entered for this question, note that the slash (/) space is the last one in which a character may be entered.

2. After all the changes have been made, check your entries with those marked on the sequence number 332 layout. If you need to change any of your entries, move the cursor to the entry to be changed and type in the new response. Do not try to change the sequence number itself.
3. When all the entries are correct, move the cursor to the 0 (zero) after sequence number 908, and change it to a 1.
4. Press ENTER.

If any entry is unacceptable, the entry to sequence number 908 is changed back to 0 and the unacceptable response is displayed more brightly. (On the 3279, the intensified characters change to white and red instead of blue and green.) The upper center portion of the screen displays a 2-digit operator code. If several responses are intensified, then the displayed operator code will refer to the responses in numeric order, from largest to smallest:

1. Correct the response to the largest sequence number that is intensified.
2. Press ENTER. The operator code will change to explain the next error.
3. Continue correcting the responses as described, until there are no intensified sequence numbers. This means all the entries are corrected. Move the cursor to the 0 (zero) after sequence number 908, and change it to a 1.
4. Press ENTER.
5. If there are still unacceptable entries intensified, report the problem.

Step 11. Change Diskettes.

Within 2 minutes, the 8 4 2 1 indicator code on the control panel will flash one of the following codes:

1100:

1. Replace the feature diskette with the RPQ diskette. *Do not press the IML pushbutton.* (If you do press the IML pushbutton, begin again at **Step 5.**) After you insert the RPQ diskette, the steady code will change to 0111 within 30 seconds.
2. If the indicator code again flashes 1100, additional RPQ diskettes are needed. Repeat the procedure for each additional RPQ diskette. *At no time should you press the IML pushbutton.*
3. When the indicator code flashes 1110, the diskette procedure is completed. Reinsert the feature diskette. *Do not press the IML pushbutton.*

4. Within 2 minutes, the 8 4 2 1 indicator code will flash 1101 or 1011. Those indicators are explained below.

1101:

1. Replace the feature diskette with the language diskette. *Do not press the IML pushbutton.* (If you do press the IML pushbutton, begin again at **Step 5**.) Within 30 seconds, the indicator code will change to 0111 and then to flashing 1011 within 1 minute.
2. When the indicator code is flashing 1011, replace the language diskette with the system diskette. *Do not press the IML pushbutton.* Within 1 minute, the 8 4 2 1 indicator code will change to 1000 and remain this way for approximately 15 minutes. (If errors occur during this 15-minute period, a flashing 8 4 2 1 indicator code will appear. The meaning of these codes is explained in Figures 5-4 and 5-5.) Then the steady indicator code will change to 1111. Customizing is successfully completed. Go to **Step 12**.

1011:

Replace the feature diskette with the system diskette. *Do not press the IML pushbutton.* (If you do press the IML pushbutton, begin again at **Step 5**.) Within 1 minute, the steady 8 4 2 1 indicator code will change to 1000 and remain this way for approximately 15 minutes. (If errors occur during this 15-minute period, a flashing 8 4 2 1 indicator code will appear. The meaning of these codes is explained in Figures 5-4 and 5-5.) Then the steady indicator code will change to 1111. Customizing is successfully completed. Go to **Step 12**.

Step 12. IML the 3274.

1. Check with your supervisor to be sure that the 3274 is attached to its communication facility.
2. Make sure the system diskette is inserted in the 3274.
3. Press the IML pushbutton. During the IML operation, errors may occur because of improper customizing. The 8 4 2 1 indicator codes in Figure 5-6 should help you detect these errors.

Step 13. Store the Configuration Data Card.

Copy the responses to the sequence numbers onto the *IBM Configuration Data Card (Configuration Support: P)*, GA23-0177. For future reference, store the card in pocket provided. The pocket is located on the inside of the 3274 operator access door on Models 1, 21, and 31, or in the diskette storage area on the front of the Model 51C.

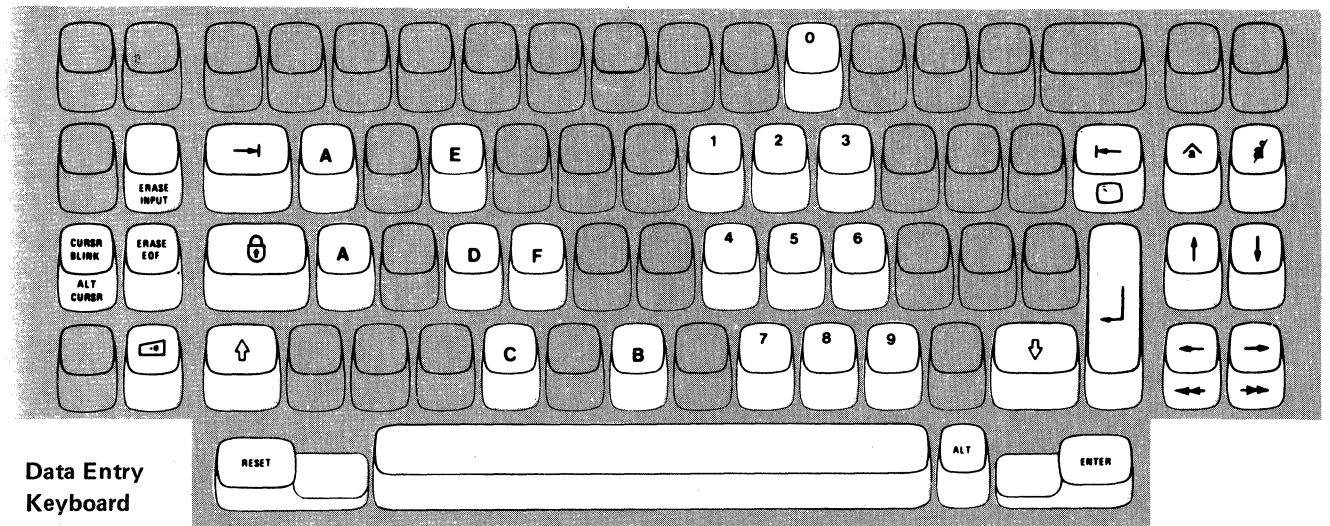
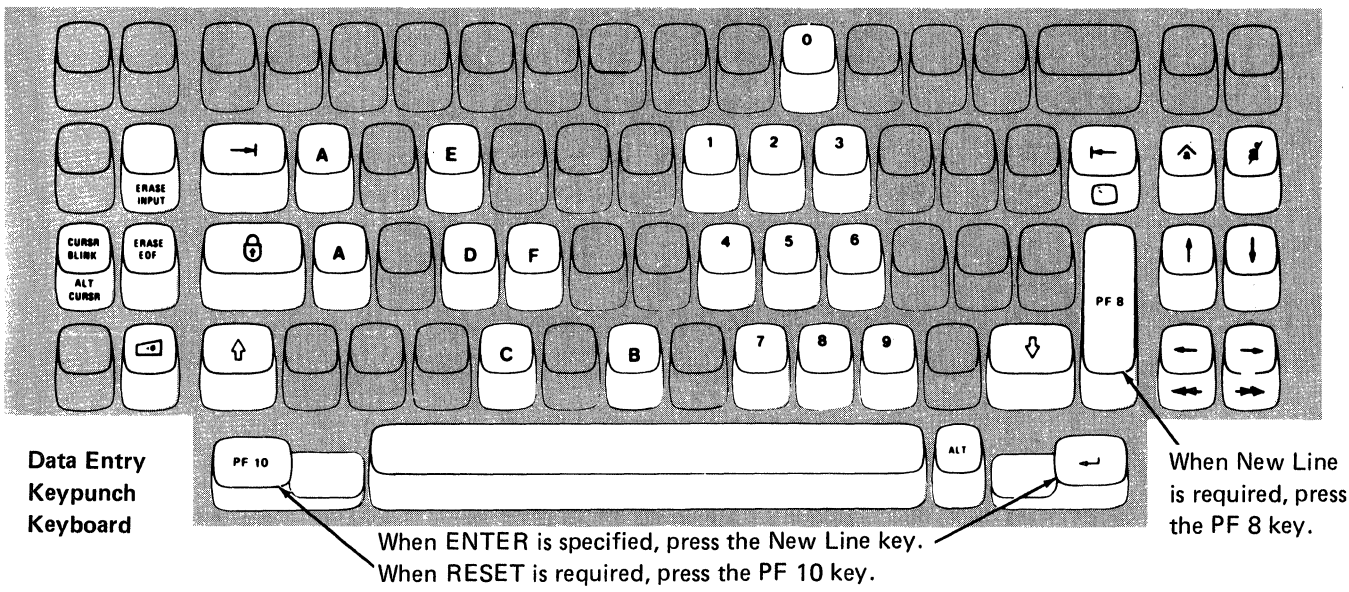
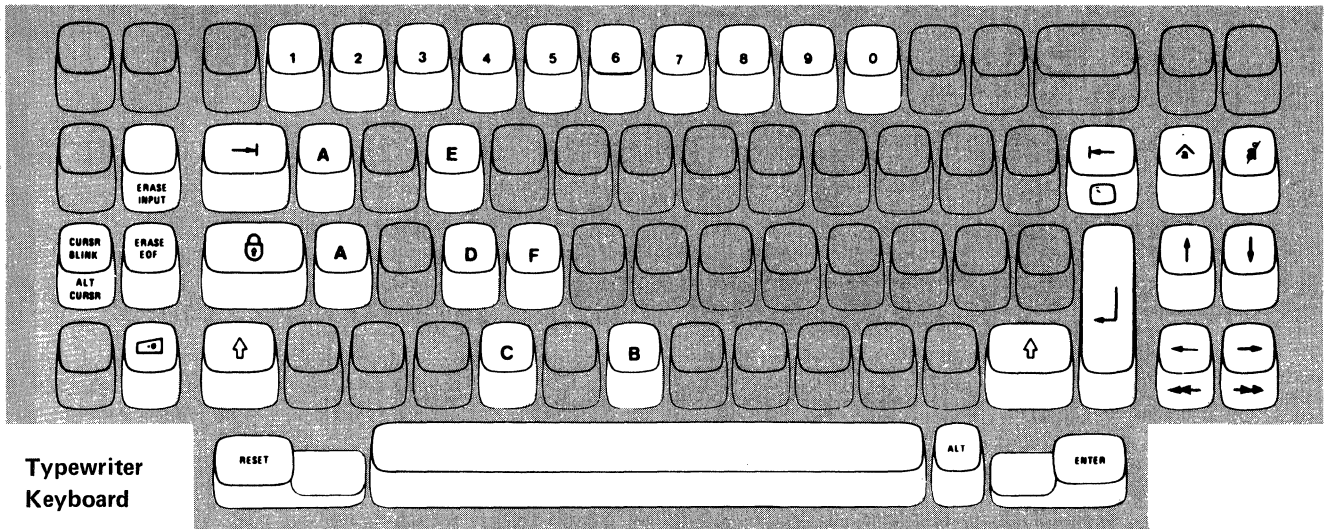

Note: During the modification procedure, only certain key positions are valid. Only those key positions shown above are to be used.

Figure 5-1. Valid Key Positions during the Modification Procedure

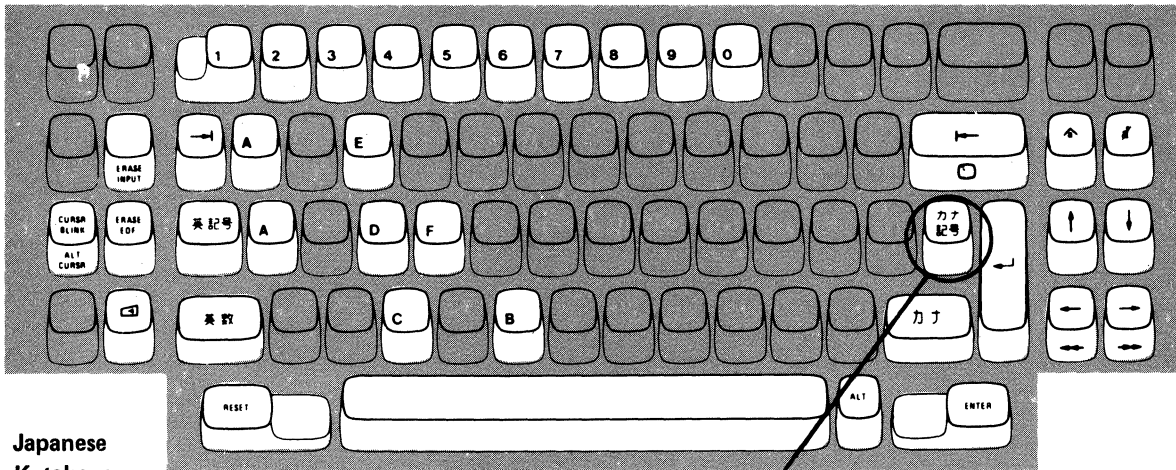

Japanese
Katakana
Typewriter
Keyboard

Press this key when sequence number 001 appears in the upper left corner of the screen.

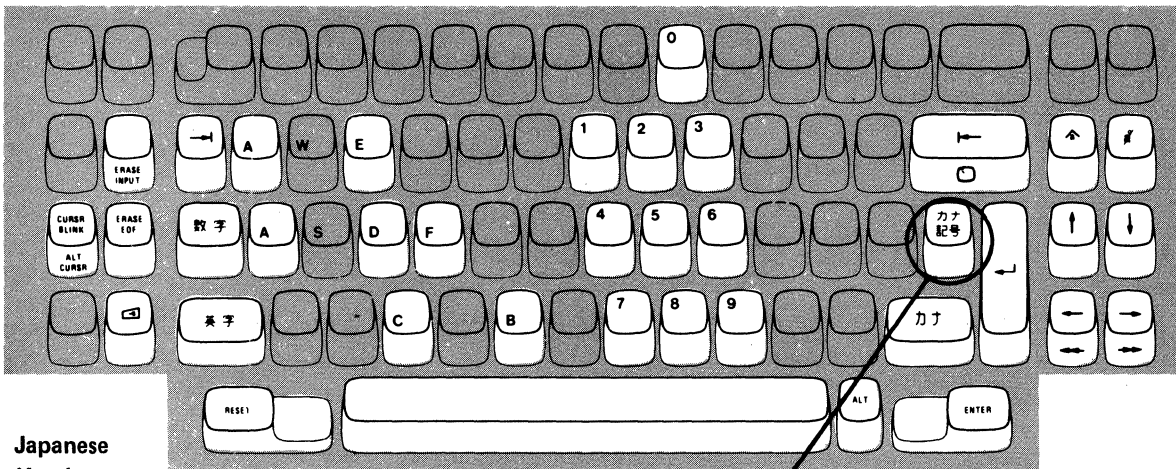

Japanese
Katakana
Data Entry
Keyboard

Press this key when sequence number 001 appears in the upper left corner of the screen.

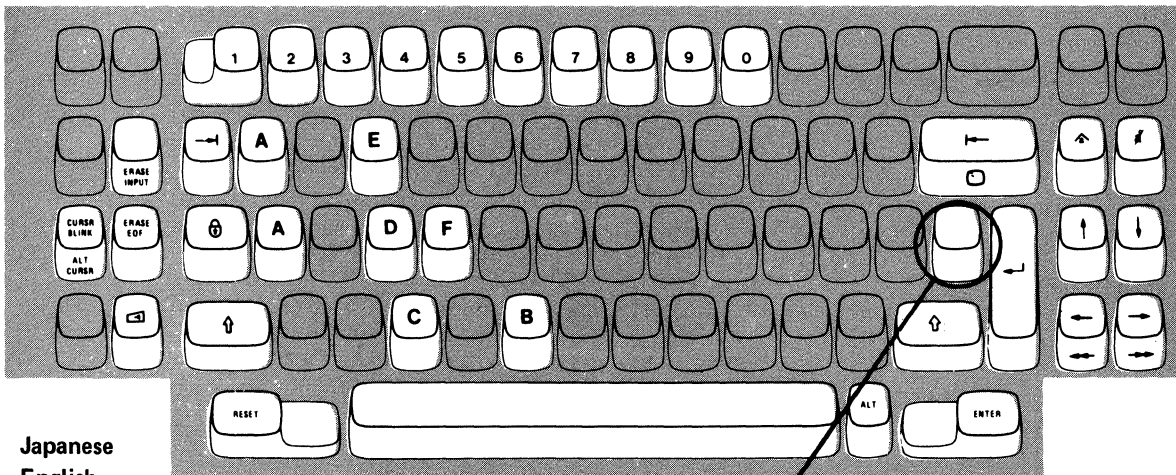

Japanese
English
Typewriter
Keyboard

Press this key when sequence number 001 appears in the upper left corner of the screen.

Note: These drawings show the valid keys for both the 76- and 88-key keyboards. The PF keys located on the right side of the 88-key keyboards are not shown and are not valid during this procedure.

Figure 5-2. Valid Key Positions during the Modification Procedure When Japanese Katakana and Japanese English Keyboards are Used

Code	Meaning	Action
01	One or more of the first 10 characters are incorrect.	Enter the correct response.
02	One or more of the 11th to 17th characters, including the space, are incorrect.	Enter the correct response.
03	1. One of the last two characters you entered in response to sequence number 001 is incorrect, or 2. The diskette release level is not the same as the documentation level.	1. Enter the correct response. 2. Restart after matching diskette and documentation levels.
11 ¹	You entered an invalid response (too many characters, value too high or too low, wrong character, etc.).	Enter the correct response.
12 ¹	You entered other than 01C, 31C, or 51C in response to sequence number 151 (3274 model designation).	Enter the correct response.
13 ¹	Your response has too few characters.	Enter the correct response.
14 ¹	The numeric total of the responses you entered for sequence numbers 111 (number of Category B terminals) and 112 (number of Category A terminals) is greater than 32 (01C, 31C) or 12 (Model 51C).	Enter the correct responses.
21 ¹	You made an unacceptable change during the modify sequence (number 999).	Recheck the entries, and correct them.
41	The X.25 network type (400) is invalid.	Check the network type values and enter a valid response to 400.
42	The incoming call options (420) response included "Validate Host DTE Address," but the address was not entered in response to 410.	Either respond to 410 with the host address or do not include "Validate Host DTE Address" in response to 420.
43	1. The circuit type (401) chosen requires a host address (410). 2. The outgoing call options chosen included "Validate 3274 DTE Address," but the address was not entered in response to 411. 3. The response to 421 was invalid.	1. Either change the response to 401 or provide a host DTE address (410). 2. Either respond to question 411 with the 3274 address or do not include "Validate 3274 DTE Address" in response to 421. 3. Check 421 and enter a valid response.
44	Negotiated window size (432) or nonstandard window size (435) conflicts with packet sequence numbering (431).	If 431 equals 0, then 432/435 must equal 01–07 (two digits). If 431 equals 1, then 432/435 must equal 01–11 (two digits).
45	The circuit type (401) is invalid.	Check the circuit type values and correct the response.
46	An invalid X.25 keyboard support (443) was selected.	Check the X.25 keyboard support and correct the response.
47	No CID password was initialized (452), but a CID is required for call options (420 and/or 421).	Either change call options to remove the CID requirement or enter a CID password (452).
99	Your entries are acceptable, but the entry for sequence number 900 or 901 has not been changed to a 1.	Change the 900 or 901 entry to a 1.

¹If any entry is unacceptable, the entry for sequence number 900 is changed back to 0 (zero) and the unacceptable value is intensified.

Figure 5-3. Operator Codes during the Modification Procedure Only

Steady Code	Diskette Mounted	Meaning	Action
0001	Feature	Customizing being performed	None.
0010	Any (indication lasts for 3 minutes or more)	Diskette improperly inserted or an internal 3274 error	Insert diskette properly and retry.
0011	Feature	Customizing being performed	None.
0100	Feature	Patch, printer authorization matrix, or RPQ being performed	None.
0101	Feature	Configuration being performed	None.
0110	Feature	Modification being performed	None.
0111	Feature, language, or RPQ	Normal 3274 operation	None.
1000	System (customizing in process)	Normal 3274 operation	None.
1001	Any	Internal 3274 error	Retry. If the error recurs, follow your local procedure for problem recovery.
1010	Any	Internal 3274 error	Retry. If the error recurs, follow your local procedure for problem recovery.
1101	Any (customizing procedure in progress)	1. IML pushbutton pressed while diskette is being changed, or 2. A bad or uncustomized system diskette is being used	1. Recustomize. Do not press the IML pushbutton unless instructed to do so. 2. Insert a good customized system diskette.
1111	System (IML not performed)	Customizing is completed	IML can be performed.

Figure 5-4. Steady 8 4 2 1 Indicator Codes during the Modification Procedure Only

Flashing Code ¹	Diskette Mounted	Meaning	Action
0000 0101	Any	System diskette request	Insert system diskette.
0000 1010	System	A diskette read error occurred.	Retry. If the error recurs, follow your local procedure for problem recovery.
0000 1011	Any	System diskette request	Insert system diskette.
0000 1100	Any	RPQ diskette request	Insert RPQ diskette.
0000 1101	Any	Language diskette request	Insert language diskette.
0000 1110	Any	Feature diskette request	Insert feature diskette.
0100 0010	System	Configuration on system diskette being used for update-diskette procedure is not compatible with this 3274	Use a system diskette with a compatible configuration.
1000 0001	System	Uncustomized system diskette being used during update procedure	Use customized system diskette.
1001 0110	Any	Wrong-level diskette being used	Use correct-level diskette.
1111 0001	Feature	On/Off switch or TEST key pressed instead of ENTER	Retry. If the error recurs, follow your local procedure for problem recovery.
	System	Internal 3274 error	Follow your local procedure for problem recovery.
1111 0011	Feature	Internal 3274 error	Follow your local procedure for problem recovery.
1111 0100	System	Internal 3274 error	Retry. If the error recurs, follow your local procedure for problem recovery.
1111 0101	System	Internal 3274 error	Retry. If the error recurs, follow your local procedure for problem recovery.
	Feature	On/Off switch or TEST key on the 3278 pressed instead of ENTER	
1111 0110	RPQ	Incompatible RPQs	Follow your local procedure for problem recovery.
	Feature	Internal 3274 error	
1111 0111	System	Internal 3274 error	Follow your local procedure for problem recovery.
1111 1000	System	Internal 3274 error	Follow your local procedure for problem recovery.
1111 1001	System	Internal 3274 error	Follow your local procedure for problem recovery.
1111 1010	Any	Internal 3274 error	Follow your local procedure for problem recovery.
1111 1011	System	Internal 3274 error	Follow your local procedure for problem recovery.
1111 1100	Any	Diskette drive error or a bad diskette	Retry. If the error recurs, follow your local procedure for problem recovery.
1111 1101	System or feature	Diskette drive error or a bad diskette	Retry. If the error recurs, follow your local procedure for problem recovery.
1111 1110	Any	Internal 3274 error	Retry. If the error recurs, follow your local procedure for problem recovery.

¹ These codes will flash alternately as shown, for example, 0000, 1011, 0000, 1011.

Figure 5-5. Flashing 8 4 2 1 Indicator Codes during the Modification Procedure Only

Steady Code	Flashing Code ¹	Diskette Mounted	Meaning	Action
—	0000 0101	System	Internal 3274 error or wrong response to sequence number 113 during customizing	Check response to sequence number 113, and retry. If the error recurs, follow your local procedure for problem recovery.
—	0000 0110	System	Internal 3274 error or wrong response to sequence number 111, 112, or 151 during customizing	Check response to sequence number 111, 112, or 151 and retry. If the error recurs, follow your local procedure for problem recovery.
—	0000 0111	System	<ol style="list-style-type: none"> 1. Internal 3274 error, or 2. Wrong response to sequence number 311 or 343, or 3. The 3274 is not connected to the communication facility 	<ol style="list-style-type: none"> 1 and 2. Check responses to sequence numbers 311 and 343, and retry. 3. Connect the 3274 to the communication facility. If the error recurs, follow your local procedure for problem recovery.
—	0000 1000	System	Internal 3274 error or wrong response to sequence number 111 during customizing	Check response to sequence number 111, and retry. If the error recurs, follow your local procedure for problem recovery.
1101	—	System	Uncustomized system diskette	Insert customized system diskette.
1110	—	System	Insufficient storage	Check response to sequence number 113, and retry. If the error recurs, follow your local procedure for problem recovery.

¹ These codes will flash alternately as shown, for example, 0000, 0101, 0000, 0101.

Note: These indicators may be caused by something other than incorrect customizing. Further aids can be found in the *IBM 3270 Information Display System: 3274 Control Unit Problem Determination Guide*, GA27-2850.

Figure 5-6. 8 4 2 1 Indicator Codes during the IML That May Result from an Incorrect Customizing Procedure

Printer Authorization Matrix Form

In response to sequence number 022, enter the characters (below) supplied by the planner in the appropriate groups on your display screen. If a group already is displayed as AA M XXXX YYYYY YYYYY, your entry will overwrite these characters. When you have completed all your entries, move the cursor to the zero after sequence number 901 at the bottom of the screen, change it to a 1, and press ENTER. Any entry that is not valid will be intensified at this time and the 1 you entered will change back to a 0 (zero). Correct the invalid entry, and return to 901. Again, change the zero to a 1, and press ENTER. When all entries are valid, the printer authorization matrix display will be replaced by the next customizing sequence number. (If, at any time during this procedure, you wish to cancel any entries you have just made, change the 0 (zero) after the 901 to A and press ENTER.) Return to your original instructions.

To delete an entry, move the cursor (with cursor-move keys or tab key) to the leftmost position of the entry (the Printer Port Address) and press the spacebar twice. The entire matrix, or as many entries as desired, can be deleted in this manner. After all changes have been made, press ENTER. All deleted entries will be displayed as AA M XXXX YYYYY YYYYY. When the matrix is satisfactorily defined, move the cursor to the zero after sequence number 901, change it to a 1, and press ENTER.

	Printer Port Address		Printer Mode	Printer Class Assignment				Source Device List							
	A	A	M	X	X	X	X	Y	Y	Y	Y	Y	Y	Y	Y
1)	-	-	-	-	-	-	-	-	-	-	-	-	-	-	-
2)	-	-	-	-	-	-	-	-	-	-	-	-	-	-	-
3)	-	-	-	-	-	-	-	-	-	-	-	-	-	-	-
4)	-	-	-	-	-	-	-	-	-	-	-	-	-	-	-
5)	-	-	-	-	-	-	-	-	-	-	-	-	-	-	-
6)	-	-	-	-	-	-	-	-	-	-	-	-	-	-	-
7)	-	-	-	-	-	-	-	-	-	-	-	-	-	-	-
8)	-	-	-	-	-	-	-	-	-	-	-	-	-	-	-
9)	-	-	-	-	-	-	-	-	-	-	-	-	-	-	-
10)	-	-	-	-	-	-	-	-	-	-	-	-	-	-	-
11)	-	-	-	-	-	-	-	-	-	-	-	-	-	-	-
12)	-	-	-	-	-	-	-	-	-	-	-	-	-	-	-
13)	-	-	-	-	-	-	-	-	-	-	-	-	-	-	-
14)	-	-	-	-	-	-	-	-	-	-	-	-	-	-	-
15)	-	-	-	-	-	-	-	-	-	-	-	-	-	-	-
16)	-	-	-	-	-	-	-	-	-	-	-	-	-	-	-

	Printer Port Address		Printer Mode	Printer Class Assignment				Source Device List							
	A	A	M	X	X	X	X	Y	Y	Y	Y	Y	Y	Y	Y
17)	-	-	-	-	-	-	-	-	-	-	-	-	-	-	-
18)	-	-	-	-	-	-	-	-	-	-	-	-	-	-	-
19)	-	-	-	-	-	-	-	-	-	-	-	-	-	-	-
20)	-	-	-	-	-	-	-	-	-	-	-	-	-	-	-
21)	-	-	-	-	-	-	-	-	-	-	-	-	-	-	-
22)	-	-	-	-	-	-	-	-	-	-	-	-	-	-	-
23)	-	-	-	-	-	-	-	-	-	-	-	-	-	-	-
24)	-	-	-	-	-	-	-	-	-	-	-	-	-	-	-
25)	-	-	-	-	-	-	-	-	-	-	-	-	-	-	-
26)	-	-	-	-	-	-	-	-	-	-	-	-	-	-	-
27)	-	-	-	-	-	-	-	-	-	-	-	-	-	-	-
28)	-	-	-	-	-	-	-	-	-	-	-	-	-	-	-
29)	-	-	-	-	-	-	-	-	-	-	-	-	-	-	-
30)	-	-	-	-	-	-	-	-	-	-	-	-	-	-	-
31)	-	-	-	-	-	-	-	-	-	-	-	-	-	-	-

List of Abbreviations

ASCII. American National Standard Code for Information Interchange.

CCITT. International Telegraph and Telephone Consultative Committee.

CID. Connection identifier.

CPU. Central processing unit.

CUG. Closed user group.

DCE. Data-circuit-terminating equipment.

DDS. Digital data service.

DPKT. Default packet size.

DTE. Data terminal equipment.

DWND. Default window size.

EBCDIC. Extended binary-coded decimal interchange code.

ECC. Error checking and correction.

HDLC. High-level data link control.

HNAD. Host network (DTE) address.

HPCA. High-performance communication adapter.

IML. Initial microcode load.

I/O. Input/output.

IOPT. Incoming call options.

LLC. Logical link control.

LVL. Level.

NPDA. Network Problem Determination Application.

NPKT. Negotiated packet size.

NWND. Negotiated window size.

OOPT. Outgoing call options.

PF. Program function.

PSDN. Packet-switched data network.

PSH. Physical services header.

PUID. Physical unit identification.

PVC. Permanent virtual circuit.

QLLC. Qualified logical link control.

RPOA. Recognized private operating agency.

SDLC. Synchronous Data Link Control.

SNA. Systems Network Architecture.

SVC. Switched virtual circuit.

TCLS. Throughput class negotiation.

VTAM. Virtual telecommunications access method.

Index

B

backup diskette 1-4
between bracket printer sharing (213) 2-6

C

changing diskettes 3-14
CID password (452) 2-16
circuit type (401) 2-9
closed user group (441) 2-14
color convergence (161) 2-6
communication interface options (343) 2-7
configuration support P 1-1
 information needed 1-8
control panel indicator lights 3-3
customization
 backup diskette 1-4
 diskettes required 3-4
 modifying a diskette 1-4
 operator codes 3-19
 preparation 1-5
 valid key positions 3-17, 3-18
customizing procedure form
 backup diskette 4-3
 initial 3-3
 modification 5-3

D

diskettes
 changing 3-14
 insertion 3-5, 3-7

E

entry acceptance (900) 2-7

F

forms
 backup diskette procedure 4-3
 initial customizing procedure 3-3
 modification procedure 5-3

H

host DTE address (410) 2-9

I

incoming call options (420) 2-10
indicator codes
 flashing 8 4 2 1 3-21
 incorrect customizing 3-22
 steady 8 4 2 1 3-20
indicator codes, 8 4 2 1 3-3
initial customizing procedure form 3-3

inserting a diskette
 all models except 51C 3-5
 Model 51C 3-7

K

K-maximum out (433) 2-12
keyboard language/character set I/O interface code
 (121) 2-5
keyboard types 3-4
keyboard validation (001) 2-1

L

link LVL transmit timeout (450) 2-15
logical channel identifier (402) 2-9
logical link control (403) 2-9

M

magnetic character set (141) 2-5
Model 31C switch settings 1-4
Model 51C switch settings 1-4
modem wrap (311) 2-6
modifying a diskette 1-4

N

negotiated packet size (430) 2-11
negotiated window size (432) 2-12
network type (400) 2-9
nonstandard default packet size (434) 2-12
nonstandard default window size (435) 2-13
number of category A terminals (112) 2-3
number of category B terminals (111) 2-3
number of retries (451) 2-16

O

operator codes 3-19
outgoing call options (420) 2-11

P

packet sequence numbering (431) 2-12
panel
 332 2-7
 999 2-2
patch request (011) 2-1
physical unit identification (PUID) (215) 2-6
planning and setup 1-1
printer authorization matrix (021) 2-1
printer authorization matrix form 3-23

R

recognized private operating agency (442) 2-14
RPQ diskettes required (031) 2-2

S

sequence numbers

- 001 keyboard validation 2-1
- 011 patch request 2-1
- 021 printer authorization matrix 2-1
- 031 RPQ diskettes required 2-2
- 111 number of category B terminals 2-3
- 112 number of category A terminals 2-3
- 113 storage 2-4
- 121 keyboard language/character set I/O interface code 2-5
- 141 magnetic character set 2-5
- 151 3274 model designation 2-6
- 161 color convergence 2-6
- 213 between bracket printer sharing 2-6
- 215 physical unit identification (PUID) 2-6
- 302 X.25 secondary station address 2-6
- 311 modem wrap (external modem only) 2-6
- 332 X.25 customization panel 2-7
- 343 communication interface options 2-7
- 400 network type 2-9
- 401 circuit type 2-9
- 402 logical channel identifier 2-9
- 403 logical link control 2-9
- 410 host DTE address 2-9
- 411 3274 DTE address 2-10
- 420 incoming call options 2-10
- 420 outgoing call options 2-11
- 430 negotiated packet size 2-11
- 431 packet sequence numbering 2-12
- 432 negotiated window size 2-12
- 433 K-maximum out 2-12
- 434 nonstandard default packet size 2-12
- 435 nonstandard default window size 2-13
- 440 throughput class negotiation 2-13
- 441 closed user group 2-14
- 442 recognized private operating agency 2-14
- 443 X.25 keyboard support options 2-14

- 450 link LVL transmit timeout 2-15
- 451 number of retries 2-16
- 452 CID password 2-16
- 900 entry acceptance 2-7
- 908 X.25 customization acceptance 2-16
- 999 panel 2-2

storage (113) 2-4

subsystem verification 1-4

switch settings

- Model 31C 1-4
- Model 51C 1-4

T

- throughput class negotiation (440) 2-13

X

X.25, description of 1-1

- X.25 customization acceptance (908) 2-16
- X.25 customization panel (332) 2-7
- X.25 keyboard support options (443) 2-14
- X.25 secondary station address (302) 2-6

3

- 3274 DTE address (411) 2-10
- 3274 model designation (151) 2-6

8

- 8 4 2 1 indicator codes 3-3

Order No. GA23-0176-0

This manual is part of a library that serves as a reference source for systems analysts, programmers, and operators of IBM systems. This form may be used to communicate your views about this publication. They will be sent to the author's department for whatever review and action, if any, are deemed appropriate. Comments may be written in your own language; use of English is not required.

IBM may use or distribute any of the information you supply in any way it believes appropriate without incurring any obligation whatever. You may, of course, continue to use the information you supply.

Note: Copies of IBM publications are not stocked at the location to which this form is addressed. Please direct any requests for copies of publications, or for assistance in using your IBM system, to your IBM representative or to the IBM branch office serving your locality.

How did you use this publication?

- | | | | |
|--------------------------|-------------------------------------|--------------------------|------------------------|
| <input type="checkbox"/> | As an introduction | <input type="checkbox"/> | As a text (student) |
| <input type="checkbox"/> | As a reference manual | <input type="checkbox"/> | As a text (instructor) |
| <input type="checkbox"/> | For another purpose (explain) _____ | | |

Is there anything you especially like or dislike about the organization, presentation, or writing in this manual? Helpful comments include general usefulness of the book; possible additions, deletions, and clarifications; specific errors and omissions.

Page Number:

Comment:

Note: Staples can cause problems with automated mail sorting equipment.
Please use pressure sensitive or other gummed tape to seal this form.

What is your occupation? _____

Newsletter number of latest Technical Newsletter (if any) concerning this publication: _____

If you wish a reply, give your name and address:

IBM branch office serving you _____

Thank you for your cooperation. No postage stamp necessary if mailed in the U.S.A. (Elsewhere, an IBM office or representative will be happy to forward your comments or you may mail directly to the address in the Edition Notice on the back of the title page.)

Reader's Comment Form

Fold and tape

Please Do Not Staple

Fold and tape



NO POSTAGE
NECESSARY
IF MAILED
IN THE
UNITED STATES

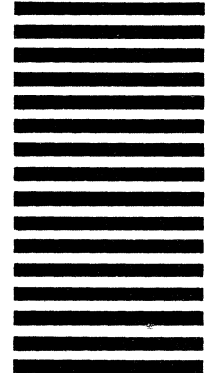

BUSINESS REPLY MAIL
FIRST CLASS PERMIT NO. 40 ARMONK, N.Y.

POSTAGE WILL BE PAID BY ADDRESSEE:

International Business Machines Corporation
Department 52Q
Neighborhood Road
Kingston, New York 12401

Fold and tape

Please Do Not Staple

Fold and tape

Cut or Fold Along Line

IBM 3270 Information Display System 3274 Control Unit Customizing Guide Configuration Support P (File No. S360/S370/S3/4300/8100-09) Printed in U.S.A. GA23-0176-0



IBM 3270 Information Display System
3274 Control Unit Customizing Guide
Configuration Support P Validation Number 70

READER'S
COMMENT
FORM

Order No. GA23-0176-0

This manual is part of a library that serves as a reference source for systems analysts, programmers, and operators of IBM systems. This form may be used to communicate your views about this publication. They will be sent to the author's department for whatever review and action, if any, are deemed appropriate. Comments may be written in your own language; use of English is not required.

IBM may use or distribute any of the information you supply in any way it believes appropriate without incurring any obligation whatever. You may, of course, continue to use the information you supply.

Note: Copies of IBM publications are not stocked at the location to which this form is addressed. Please direct any requests for copies of publications, or for assistance in using your IBM system, to your IBM representative or to the IBM branch office serving your locality.

How did you use this publication?

- | | | | |
|--------------------------|-------------------------------------|--------------------------|------------------------|
| <input type="checkbox"/> | As an introduction | <input type="checkbox"/> | As a text (student) |
| <input type="checkbox"/> | As a reference manual | <input type="checkbox"/> | As a text (instructor) |
| <input type="checkbox"/> | For another purpose (explain) _____ | | |

Is there anything you especially like or dislike about the organization, presentation, or writing in this manual? Helpful comments include general usefulness of the book; possible additions, deletions, and clarifications; specific errors and omissions.

Page Number:

Comment:

Note: Staples can cause problems with automated mail sorting equipment.
Please use pressure sensitive or other gummed tape to seal this form.

What is your occupation? _____

Newsletter number of latest Technical Newsletter (if any) concerning this publication: _____

If you wish a reply, give your name and address:

IBM branch office serving you _____

Thank you for your cooperation. No postage stamp necessary if mailed in the U.S.A. (Elsewhere, an IBM office or representative will be happy to forward your comments or you may mail directly to the address in the Edition Notice on the back of the title page.)

Reader's Comment Form

Cut or Fold Along Line

IBM 3270 Information Display System 3274 Control Unit Customizing Guide Configuration Support P (File No. S360/S370/S3/4300/8100-09) Printed in U.S.A. GA23-0176-0

Fold and tape

Please Do Not Staple

Fold and tape



NO POSTAGE
NECESSARY
IF MAILED
IN THE
UNITED STATES

BUSINESS REPLY MAIL
FIRST CLASS PERMIT NO. 40 ARMONK, N.Y.

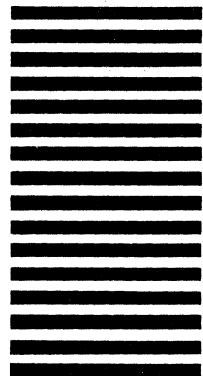

POSTAGE WILL BE PAID BY ADDRESSEE:

International Business Machines Corporation
Department 52Q
Neighborhood Road
Kingston, New York 12401

Fold and tape

Please Do Not Staple

Fold and tape



GA23-0176-0

IBM 3270 Information Display System 3274 Control Unit Customizing Guide Configuration Support P (File No. S360/S370/S3/4300/8100-09) Printed in U.S.A. GA23-0176-0

