

GA21-9246-4

File No. S5250/S34/S38-00

IBM 5250 Information Display System
IBM 5251 Display Station
IBM 5252 Dual Display Station
IBM 5225 Printer
IBM 5256 Printer
Introduction

INTRODUCTION



GA21-9246-4

File No. S5250/S34/S38-00

IBM 5250 Information Display System
IBM 5251 Display Station
IBM 5252 Dual Display Station
IBM 5225 Printer
IBM 5256 Printer
Introduction

INTRODUCTION

Fifth Edition (January 1980)

This is a major revision of, and obsoletes, GA21-9246-3. Because the changes and additions are extensive, this publication should be reviewed in its entirety.

Changes are periodically made to the information herein; these changes will be reported in new editions of this publication.

This publication is for planning purposes only. The information contained in this manual concerning the 5225 Printer, the 2400 bps integrated modem, and the 4800 bps integrated modem, is subject to change before any of these products become available.

Use this publication only for the purposes stated in the *Preface*.

Publications are not stocked at the address below. Requests for copies of IBM publications and for technical information about the system should be made to your IBM representative or to the branch office serving your locality.

This publication could contain technical inaccuracies or typographical errors. Use the Reader's Comment Form at the back of this publication to make comments about this publication. If the form has been removed, address your comments to IBM Corporation, Publications, Department 245, Rochester, Minnesota 55901. IBM may use and distribute any of the information you supply in any way it believes appropriate without incurring any obligation whatever. You may, of course, continue to use the information you supply.

Preface

This publication describes the IBM 5250 Information Display System. The 5250 consists of the 5251 Display Station, the 5252 Dual Display Station, the 5225 Printer, the 5256 Printer. These work stations attach directly to a host system or to a 5251 Display Station Model 2 or 12, which is capable of remote communications with a host system via the SNA/SDLC (systems network architecture/synchronous data link control) line discipline. The flexibility of configuring these work stations allows the 5250 Information Display System to be placed in most areas that require the services of a computer center.

The objective of this publication is to help the reader achieve a general understanding of the display system and how the display system can expand the capabilities of a data processing system.

This publication is divided into five chapters:

- Chapter 1 provides a general introduction to the 5250 Information Display System.
- Chapter 2 describes each machine and the special features.
- Chapter 3 discusses the functional capabilities.
- Chapter 4 describes how a display system can be used in data processing applications.
- Chapter 5 provides some additional information, such as planning the installation, setting up the machines, reliability and serviceability.

The reader is expected to have a basic knowledge of data processing and data communications, but prior knowledge of display systems is not a requirement.

Related Publications

- *IBM 5250 Information Display System Planning and Site Preparation Guide*, GA21-9337
- *IBM 5251 Display Station Models 1 and 11 Setup Procedure*, GA21-9286
- *IBM 5251 Display Station Models 1 and 11 IBM 5252 Dual Display Station Operator's Guide*, GA21-9248
- *IBM 5252 Dual Display Station Setup Procedure*, GA21-9288
- *IBM 5251 Display Station Models 2 and 12 Setup Procedure*, GA21-9289
- *IBM 5251 Display Station Models 2 and 12 Operator's Guide*, GA21-9323
- *IBM 5256 Printer Setup Procedure*, GA21-9290
- *IBM 5256 Printer Operator's Guide*, GA21-9260
- *IBM 5250 Information Display System Keyboard Template Assignment Sheet and Display Screen Layout Sheet*, GX21-9271
- *IBM Data Communication Concepts*, GC21-5169
- *Form Design Reference Guide for Printers*, GA24-3488

Contents

CHAPTER 1. INTRODUCTION	1
Highlights of the 5250 Information Display System	1
Advantages of a Display System	4
A Sample Configuration	5
CHAPTER 2. UNITS AND FEATURES	7
5251 Models 2 and 12 Display Station (Remote Communications)	9
5251 Models 1 and 11 Display Stations (Directly Attached)	13
5252 Dual Display Station (Directly Attached)	14
5225 and 5256 Printers (Directly Attached)	15
5225 Printer (Directly Attached)	15
5256 Printer (Directly Attached)	18
Features	19
Audible Alarm	22
Cable Thru	22
Cluster Features	22
Communications Features	24
Expanded Function	25
Keyboards	26
Keylock	30
Magnetic Stripe Reader	30
Selector Light Pen	30
CHAPTER 3. FUNCTIONAL CAPABILITIES	31
5251 and 5252 Display Stations	31
Command Functions	31
Character Sets	34
Display Control and Highlighting Attributes	34
Format Control	35
Help Function	37
Keyboard Signal	37
Communications	37
5225 and 5256 Printers	38
Character Sets	38
Bidirectional Printing	38
CHAPTER 4. APPLICATIONS	39
Display System Environment	39
Inquiry	40
Data Entry	41
Sample Application	42
CHAPTER 5. ADDITIONAL CONSIDERATIONS	45
Planning the Installation	45
Setting Up the System	45
Reliability and Serviceability	46
INDEX	47



Chapter 1. Introduction

The 5250 Information Display System is a family of work stations that brings the capabilities of the host system to the user. (*Host system* is a term used to describe the controlling or highest level system in a data or text communications configuration.) The 5250 system offers display stations and printers that are designed for interactive data entry and inquiry applications. The system consists of the 5251 Display Station, the 5252 Dual Display Station, the 5225 Printer, and the 5256 Printer. These work stations can be located away from the host system in areas such as a sales counter, an order entry department, and a shipping department.

The 5250 system offers a variety of features allowing you to tailor the 5250 Information Display System and the host system to your current data processing needs and to plan for additional display products as your business grows.

Highlights of the 5250 Information Display System

The display stations of the 5250 Information Display System offer the following:

- Centralized or distributed data entry, display, and printing.
- Direct attachment to the host system.
- Remote communications with the host system via the SNA/SDLC line protocol.
- Local operation through a maximum length of 1525 meters (5000 feet) of twinaxial cable or 610 meters (2000 feet) of coaxial cable.
- Remote data communications up to 9,600 bits per second.
- A 960 or 1,920 character display.
- The capability to enter, display, and print both uppercase and lowercase alphabetic characters.
- A keyboard with a key arrangement similar to a standard typewriter or with a data entry arrangement.
- A typewriter-like keyboard with a 10-key numeric pad for rapid entry of numeric data.
- A data entry keyboard with either embedded numeric keys in a key entry format or with proof arrangement (similar to a 10-key calculator keyboard).
- The capability to select up to 24, programmable, command functions.

- A security Keylock feature and, under program control, the capability to enter data without the data being displayed.
- A Cluster or Dual Cluster feature for the direct attachment of additional work stations.
- A Cable Thru feature for the connection in series with other directly attached work stations.
- A Selector Light Pen feature for selecting data fields from the display screen for system input.
- A Magnetic Stripe Reader feature for input from credit cards, ID cards, and other documents with magnetic encoded stripes.
- A printing speed range of 40 characters per second to 560 lines per minute.

The 5225 Printer offers the following:

- Four models with maximum printing speed of 280, 400, 490, or 560 lines per minute.
- The capability of direct attachment to a host (System/34 only) or to a remote display station with a Cluster feature or a Dual Cluster feature.
- The capability to print data processing reports on correspondence size continuous forms with condensed printing at 15 characters.
- A selectable print spacing of 10 or 15 characters per inch (host or operator controlled).
- A maximum print line of 132 characters at 10 characters per inch or 198 characters at 15 characters per inch.
- The capability to connect in series with other directly attached work stations.
- Bidirectional wire matrix line printing.
- Full look-ahead capability for optimized output.
- The capability of being either a work station printer or a system printer.
- The capability to print uppercase and lowercase.
- The capability to print on continuous forms that have one to six parts (original plus five carbons).
- A selectable line spacing of 6 or 8 lines per inch (host or operator controlled).
- An Audible Alarm feature.

The 5256 Printer offers the following:

- A printing speed of 40, 80, or 120 characters per second.
- The capability of direct attachment to a host system or a remote display station with a Cluster feature or a Dual Cluster feature.
- The capability to connect in series with other directly attached work stations.
- Bidirectional serial matrix printing.
- Full look-ahead capability for optimized throughput.
- The capability of being either a work station printer or a system printer.
- A maximum print line of 132 characters.
- The capability to print uppercase and lowercase.
- The capability of using individual or continuous forms.
- The capability to print on continuous forms that have one to six parts (original plus five carbon copies).
- A print position spacing of 10 characters per inch.
- A selectable line spacing of 6 or 8 lines per inch (operator controlled).
- An Audible Alarm feature.

Advantages of a Display System

The IBM 5250 Information Display System can be located away from the host system in areas that often require the services of the computer center. A display system brings the system to the user and enables the user to enter data directly into the system. Thus, the user can eliminate unnecessary transcribing and transferring forms and documents. As a result, current information is available when and where it is needed.

The display system reduces errors in the handling of data. The area operator who first enters the data can more easily discover data entry errors and is more qualified to correct them than personnel in the computer center. This concept also reduces the clerical activities at the computer center.

Some processing activity at the computer center is eliminated because a remote display station can process keystrokes and fields according to your program requirements. This processing is done by a remote display station:

- To relieve the host system processing unit of highly repetitive and burdensome operations.
- To reduce the amount of data and control information transferred between the processing unit and the remote display station.
- To improve the speed of response in accepting and processing keystrokes.
- To improve the ability to provide timely feedback to the operator, especially when operator or machine errors occur.

A Sample Configuration

Your business needs should determine the number of display stations and printers for the host system. You can begin with a minimum configuration in a centralized environment. Later, to provide maximum efficiency for each function the host system must serve, you could decentralize the data processing operation by placing display stations and printers in the user's areas throughout the organization. The configuration can be expanded as the data processing needs of your business change and grow.

Figure 1 shows a sample configuration. The upper section shows work stations that are directly attached to the host system. This arrangement consists of a system console and data entry station, system printer, and a dual display station in the computer center for centralized data entry. A printer is directly attached to the host system through the dual display station's Cable Thru feature. This feature should be considered for all directly attached work stations not only because it allows relocation flexibility, but also because it can save expense, especially when the twinaxial cable length approaches 1525 meters (5000 feet).

For decentralized interactive data entry or communications with the host system at distances greater than 1525 meters (5000 feet), the display stations capable of remote communications use the SNA/SDLC line discipline to communicate with the host system. These display stations can be equipped with a Cluster feature, which allows them to control directly attached work stations.

Directly attached work stations can be connected to the host system or to a display station's Cluster feature by two methods.

One method, as shown in the lower right section of Figure 1, is to individually cable each work station back to the Cluster feature. Another method, as shown in the lower left section of Figure 1, allows the cable from one work station to be connected to another work station, and so forth, in series, back to the Cluster feature. These work stations must have the Cable Thru feature to be connected in series. The Cable Thru feature and Cluster features are described in the *Features* section of this manual. The *Applications* chapter describes the uses for the 5250 Information Display System.

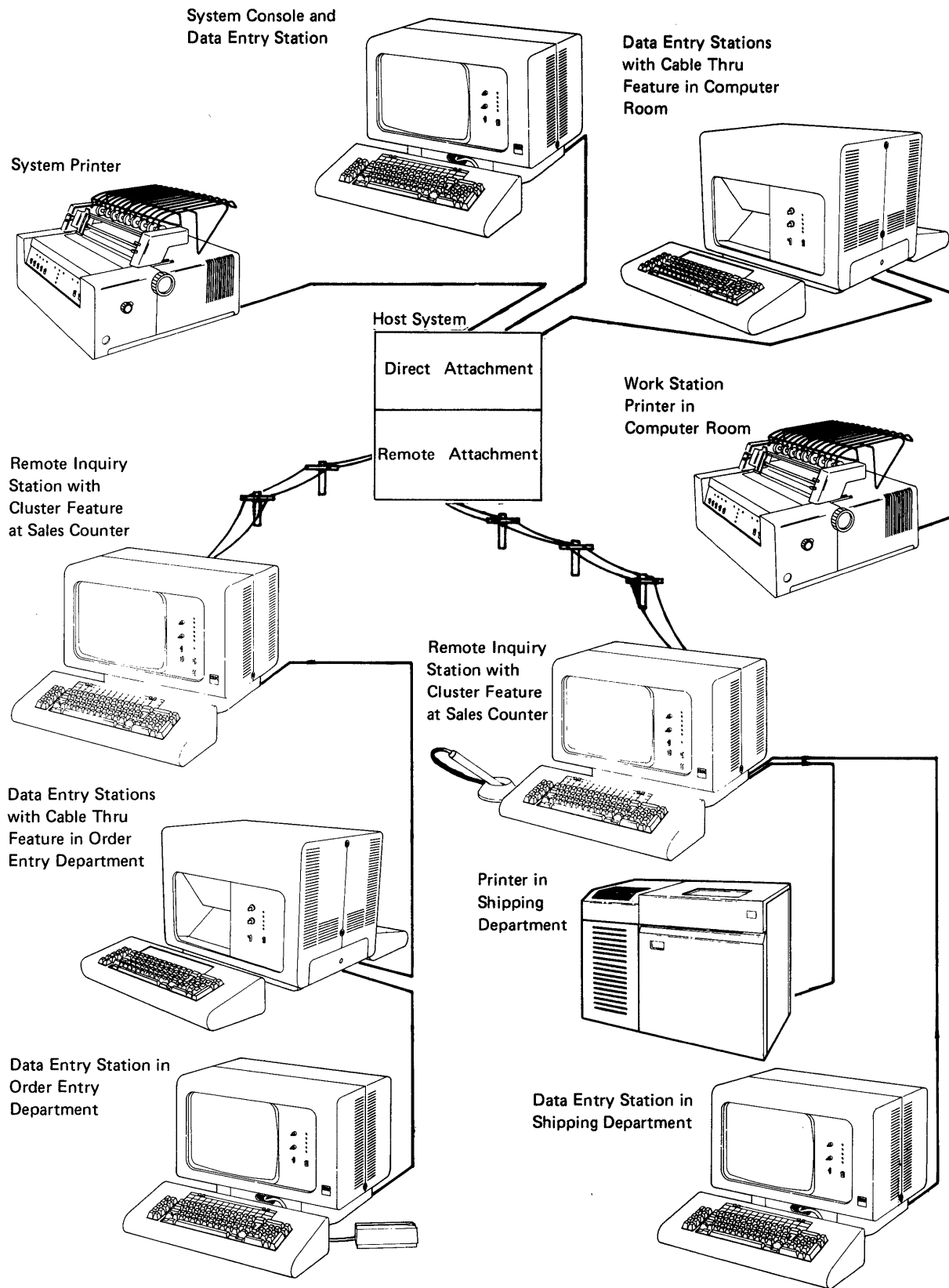

Note: The 5225 Printer might not be supported by all host systems. Check with your IBM sales representative to determine if your system supports the use of the 5225 Printer.

Figure 1. A Sample Configuration for the IBM 5250 Information Display System

Chapter 2. Units and Features

The previous chapter described the IBM 5250 Information Display System, its advantages, and some of the uses of the display station and printer. This chapter gives detailed descriptions of the 5251, 5252, 5225, and 5256, and it describes the features of each device.

- The 5251 Display Station is offered in four models:
 - Model 1 is a directly attached work station with a 960-character display.
 - Model 2 is a remote communicating work station with a 960-character display.
 - Model 11 is a directly attached work station with a 1,920-character display.
 - Model 12 is a remote communicating work station with a 1,920-character display.
- The 5252 Dual Display Station is a directly attached work station with two keyboards and two 960-character displays.
- The 5225 Printer is a directly attached wire matrix line printer and is offered in four models. Each model can print up to 132 positions per line at 10 characters per inch or 198 positions per line at 15 characters per inch:
 - Model 1 prints at a maximum rate of 280 lines per minute at 10 characters per inch or at 195 lines per minute at 15 characters per inch for line lengths up to 7.4 inches.
 - Model 2 prints at a maximum rate of 400 lines per minute at 10 characters per inch or at 290 lines per minute at 15 characters per inch for line lengths up to 9.8 inches.
 - Model 3 prints at a maximum rate of 490 lines per minute at 10 characters per inch or at 355 lines per minute at 15 characters per inch for line lengths up to 11.8 inches.
 - Model 4 prints at a maximum rate of 560 lines per minute at 10 characters per inch or at 420 lines per minute at 15 characters per inch for line lengths up to 13.0 inches.
- The 5256 Printer is a directly attached serial matrix printer and is offered in three models:
 - Model 1 prints at a maximum rate of 40 characters per second.
 - Model 2 prints at a maximum rate of 80 characters per second.
 - Model 3 prints at a maximum rate of 120 characters per second.

Directly attached display stations and printers can be connected by twinaxial or coaxial cable to:

- A port on the host system
- A 5251 Model 2 or 12 with a Cluster or Dual Cluster feature
- Another 5251 Model 1 or 11 with the Cable Thru feature
- A 5252 with Cable Thru feature
- A 5225 with Cable Thru feature
- A 5256 with Cable Thru feature

Twinaxial cable is a shielded cable with two conductors that can be used indoors or outdoors. Coaxial cable is a shielded cable with one conductor that is available in two types to accommodate indoor and outdoor use. Coaxial cable is intended for use by systems with existing coaxial cable connections. In order to use coaxial cable to connect display stations to the host system (or to a Model 2 or 12 with the Cluster feature), a twinaxial-coaxial adapter must be installed at each end of each cable run.

You may purchase preassembled cables from IBM or assemble your own from bulk cable and connectors. Cable information is given in the *IBM 5250 Information Display System Planning and Site Preparation Guide, GA21-9337*.

5251 MODELS 2 AND 12 DISPLAY STATION (REMOTE COMMUNICATIONS)

Figure 2 shows the 5251 Model 12 Display Station. The Model 12 and the Model 2 (which resembles the Model 12) are single keyboard display stations that communicate with the host system via communications facilities. The Model 2 displays up to 12 lines of information with 80 characters each and the Model 12 displays up to 24 lines of information with 80 characters each. These display stations use the SNA/SDLC line discipline and operate in half-duplex mode on point-to-point switched or nonswitched facilities, or on multipoint nonswitched facilities. Both models provide display control and highlighting characteristics as described in Chapter 3 *Functional Capabilities*.

These display stations have one keyboard, a display screen, display indicators, and a control panel. The keyboard options are the same for all models of the 5251 and are described in the *Features* section of this chapter.

A cursor, which is normally visible on the display when power is on, resembles a high intensity underscore and can be positioned anywhere on the display either manually by operator keying or automatically by the system program. The cursor indicates where the next character can be entered. The display station character set consists of uppercase and lowercase letters, numerics, and special characters. Each character is displayed in an 8 by 16 dot matrix.

Five display indicators keep the operator constantly informed of the operational status of the display station. These indicators appear on the display next to the permanent legends. A dash indicates that the system is in the inactive state; a bright rectangle indicates that the system is in the active state. The following system or operator actions apply when the rectangle (indicating active status) appears next to the display indicators.

Display Indicator	Action Allowed or Taken
System Available	The display station is ready to accept commands.
Message Waiting	The system has one or more messages for you.
Keyboard Shift	The keyboard is in Upper Shift on the typewriter-like keyboard or Numeric Shift on the data entry keyboard.
Insert Mode	The system allows data to be inserted into an existing field (from the keyboard) without destroying existing data.
Input Inhibited	Data cannot be entered from the keyboard.

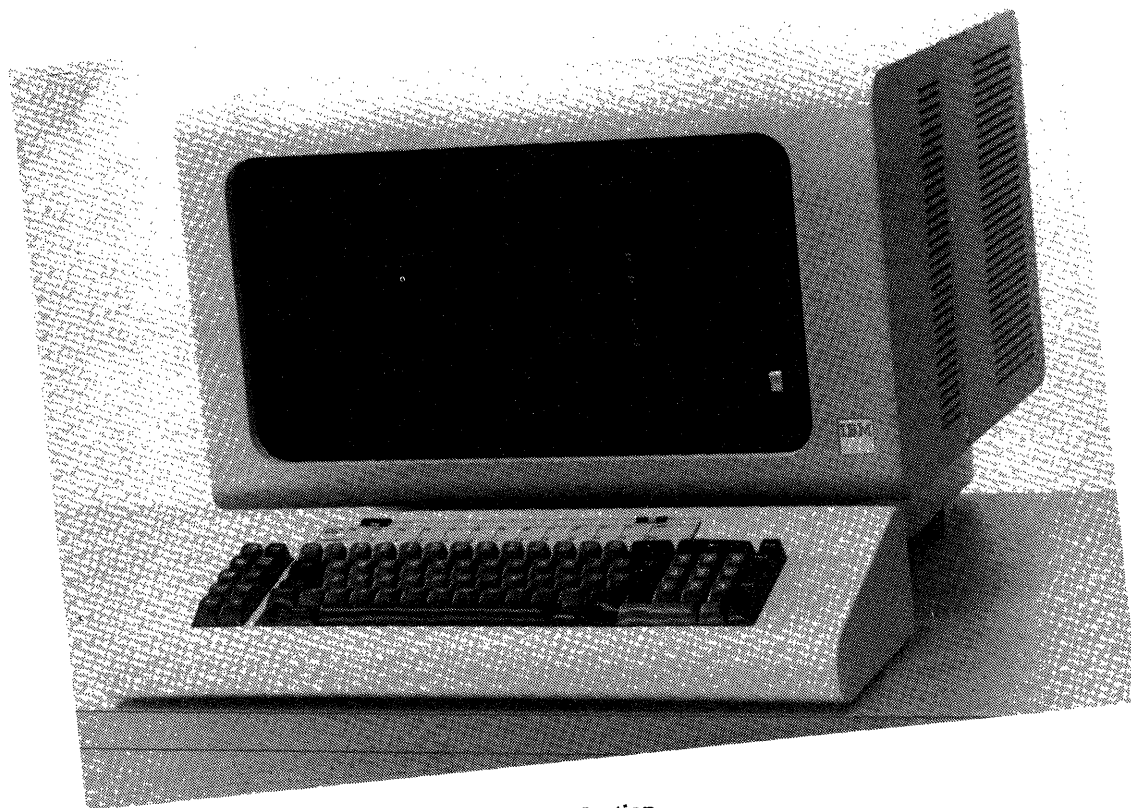
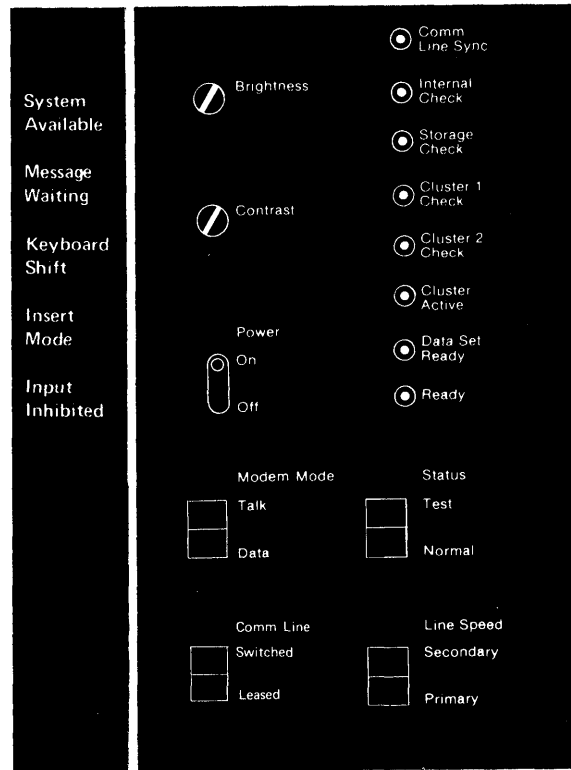

Figure 2. IBM 5251 Model 12 Display Station

The controls for adjusting display screen brightness and contrast (between normal and high-intensity fields) are on the control panel. These controls allow the operator to make adjustments in the range commonly required for different lighting conditions.



This panel also contains lights that provide communications and Cluster feature status information. These lights generally indicate when:

- The display station is ready for use.
- The data communications equipment is ready to communicate with the host system.
- Communications is active between the Model 2 or 12 and any directly attached display stations or printers.

Arrangements for the communications services must be made by the customer. You can refer to the *IBM Data Communication Concepts, GC21-5169*, for general information about data communications. The publication also describes the components of a data communications system, explains the benefits of data communications, and describes how data communications can be used with data processing.

The next illustration shows several conventional methods for connecting the host system to the Model 2 or 12 by nonswitched communications lines. It also shows the 5251 Model 2 or 12 with the Dual Cluster feature. The Cluster or Dual Cluster feature allows display stations and printers to be attached to and controlled by the 5251 Model 2 or 12 instead of attaching directly to the host system.

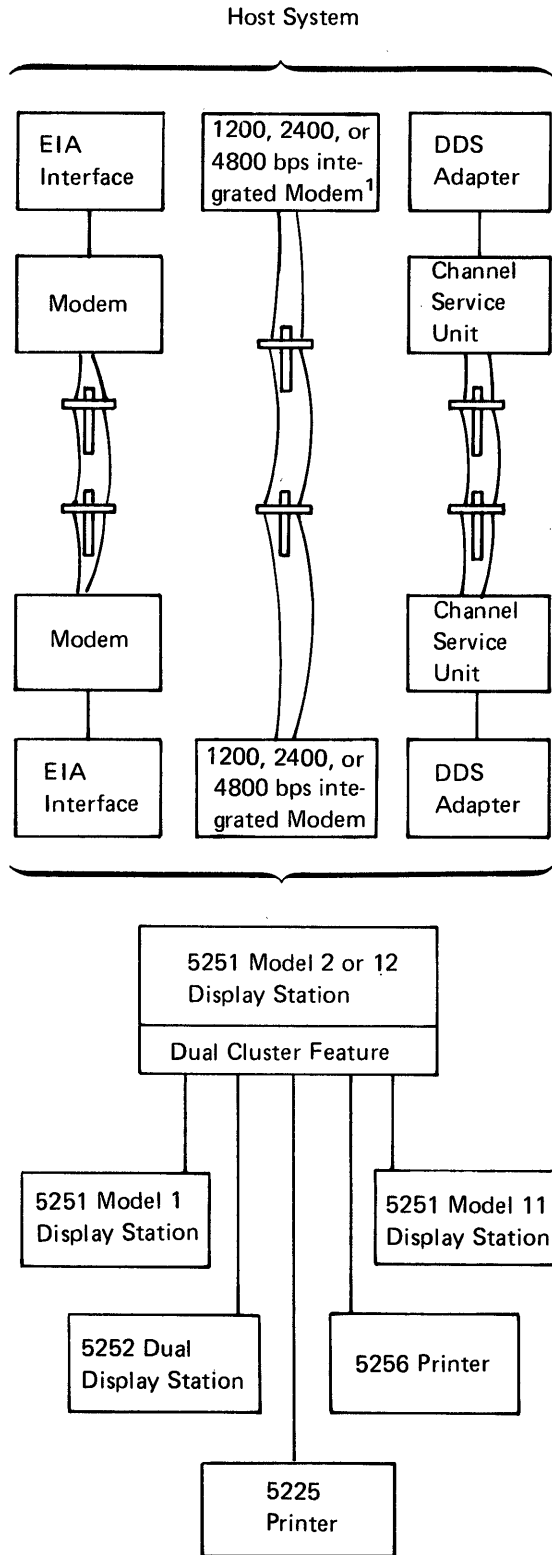

¹All host systems might not have compatible integrated modems.

5251 MODELS 1 AND 11 DISPLAY STATIONS (DIRECTLY ATTACHED)

Figure 3 shows the 5251 Model 11 Display Station. The Model 11 and the Model 1 (which resembles the Model 11) are single keyboard display stations for interactive data entry and inquiry applications at locations that require a single display work station. They attach directly to a host system or to a 5251 Model 2 or 12 Display Station.

The Model 1 displays up to 12 lines of information with 80 characters each and the Model 11 displays up to 24 lines of information with 80 characters each. Both models provide display control and highlighting characteristics as described in Chapter 3, *Functional Capabilities*.



Figure 3. IBM 5251 Model 11 Display Station

The Models 1 and 11 like the Models 2 and 12, have one keyboard, a display screen, display indicators, and a control panel. The display indicators and control panel lights keep the operator informed of the display station's operational status.

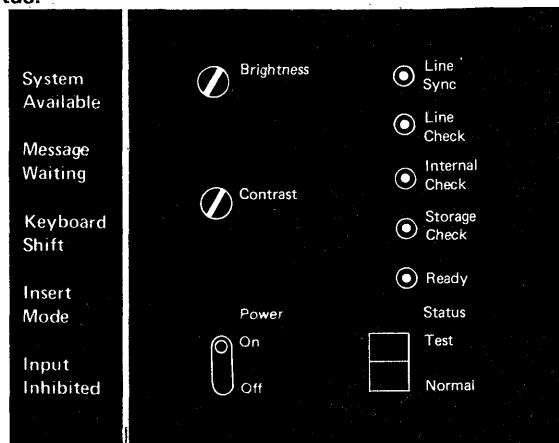

5252 DUAL DISPLAY STATION (DIRECTLY ATTACHED)

The 5252 Dual Display Station is shown in Figure 4. This display station is designed for use by two operators when multiple display stations are required at a specified location. The 5252 attaches directly to a host system or to a 5251 Model 2 or 12 Display Station.

A dual display station has two movable keyboards that are connected to a common display unit by a short cable. The common display unit is divided in half both logically and optically to provide two work stations, which allow each operator to view a separate 960-character display with up to twelve lines of 80 characters each.

The 5252 provides the same display control and highlighting of individual fields as the 5251; it also uses the same keyboards. The control panel, which is on the primary side of the 5252, is like the control panel on the 5251 Models 1 and 11. The similarities between the 5251 and 5252 keyboards, display, and control panel allow your operators to use either work station and maintain effective keying rates.

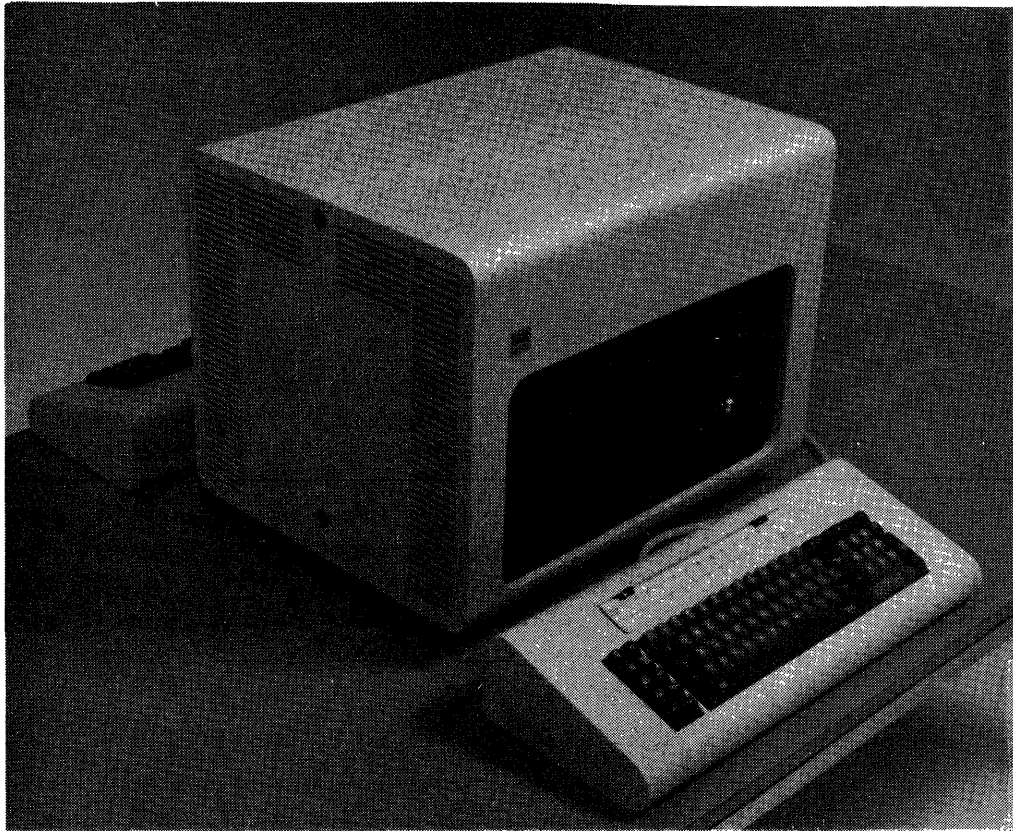

Figure 4. IBM 5252 Dual Display Station

5225 AND 5256 PRINTERS (DIRECTLY ATTACHED)

The 5250 Information Display System can use either the 5225 Printer or the 5256 Printer to print information that is displayed at a 5251 or 5252 display station, or output that comes from a system program.

5225 Printer (Directly Attached)

The 5225 Printer, shown in Figure 5, is a fully buffered, 132-position or 198-position, wire matrix line printer with front panel controls. The printer attaches directly to a host system or a 5251 Model 2 or 12 Display Station with a Cluster or Dual Cluster feature.

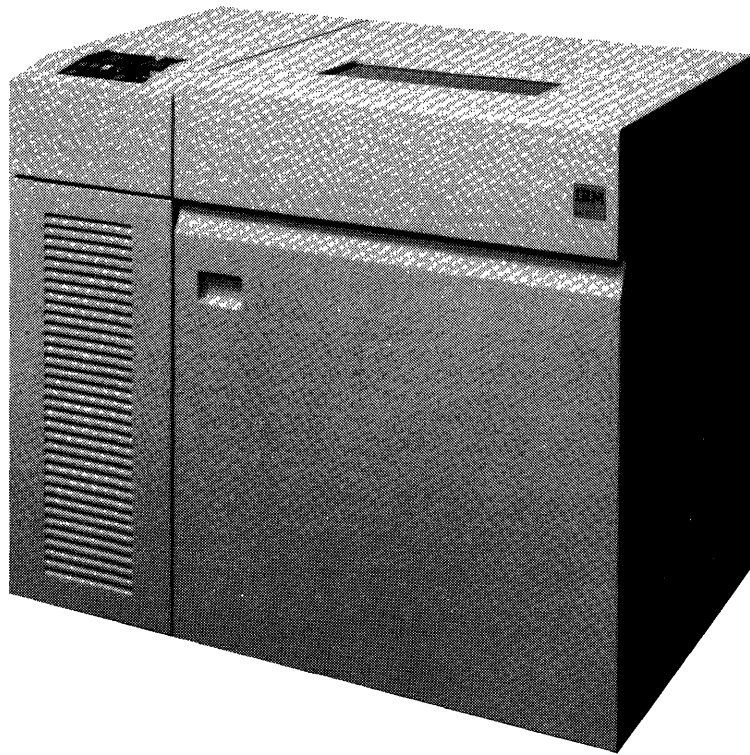
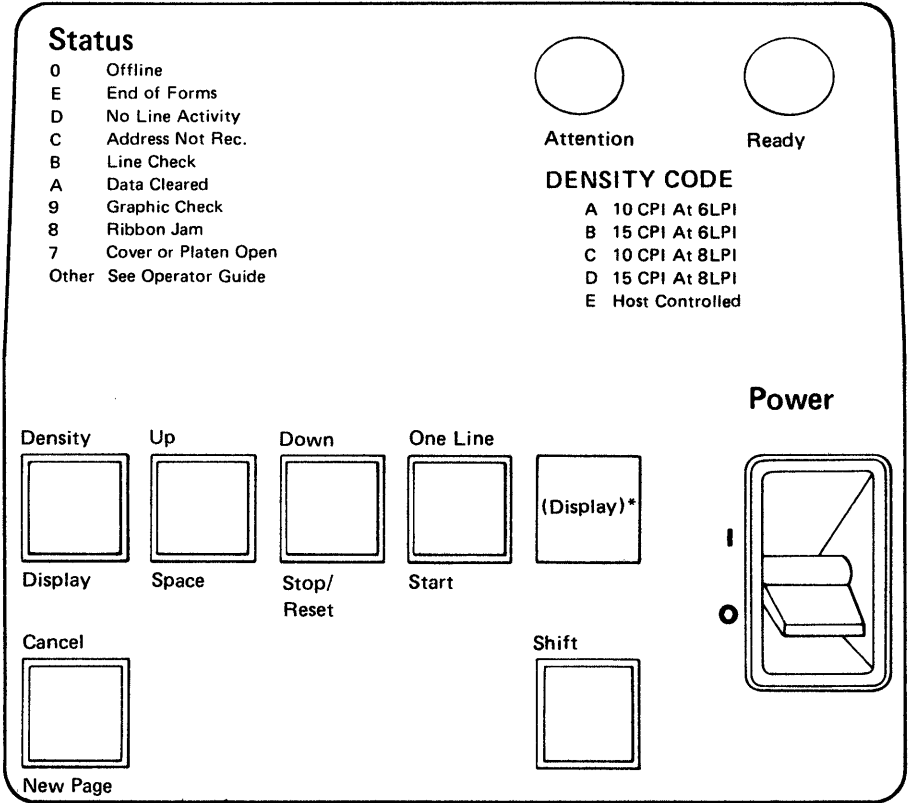

Figure 5. IBM 5225 Printer

The average printing rate depends on the model of the printer used and the format of the printed data on the page. The 5225 prints bidirectionally and has look-ahead capability. This capability reduces the print head movement because it does not require the print head to move to a margin before printing. Instead, the print head continues to print while moving in either direction, thus increasing throughput.

The control panel is located on the front of the printer. On the control panel are six keys, two indicator lights, a Power switch, and the operator panel display.



*Display status and density codes

The Mode switch, shown in Figure 6, is located behind the front door on the 5225 Printer. The On Line and Buffer Print positions on the Mode switch permit printing to be controlled by the using system. All other positions are offline and do not allow printing to be initiated from the using system.

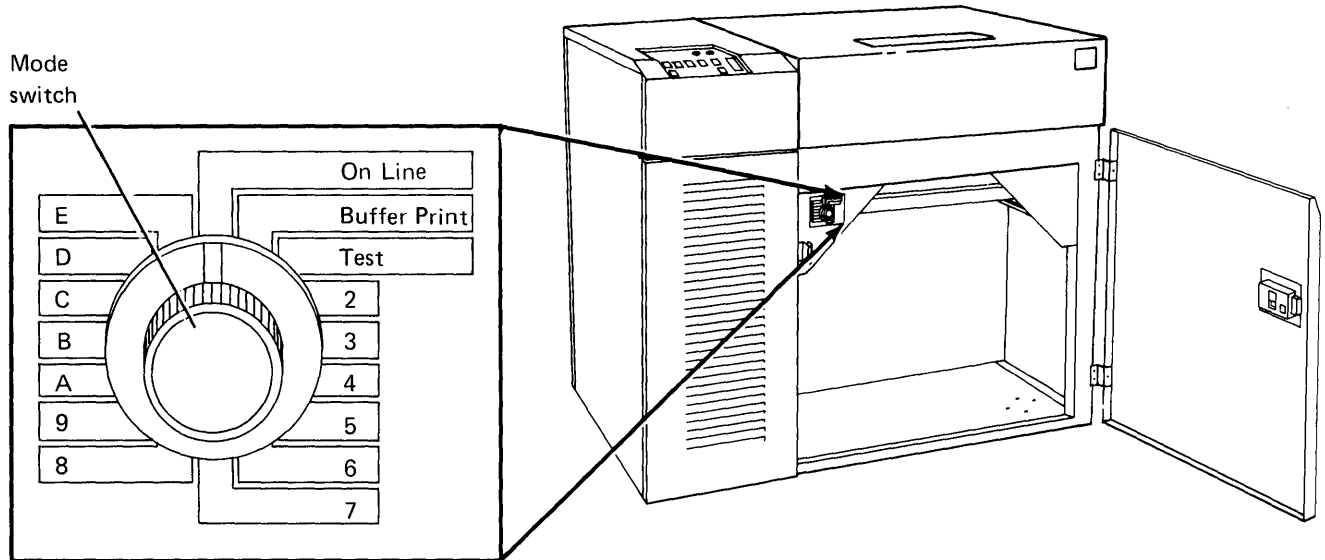

Figure 6. Mode Switch

Continuous forms are used on the 5225 Printer. The printer accepts forms of up to six parts, but forms consisting of more than four parts should be tested under operating conditions to determine suitability of feeding and legibility of the print.

Continuous forms can be 3 to 17.7 inches wide. Refer to the *Form Design Reference Guide for Printers, GA24-3488*, for general form-design information, such as, form length, weight, fastenings, and other form-related items that should be considered when forms are designed.

5256 Printer (Directly Attached)

The 5256 Printer, shown in Figure 7, is a fully buffered, 132-position, serial matrix printer with front panel controls and an easy-to-remove forms tractor. The printer attaches directly to a host system or to a 5251 Model 2 or 12 Display Station with a Cluster or Dual Cluster feature.

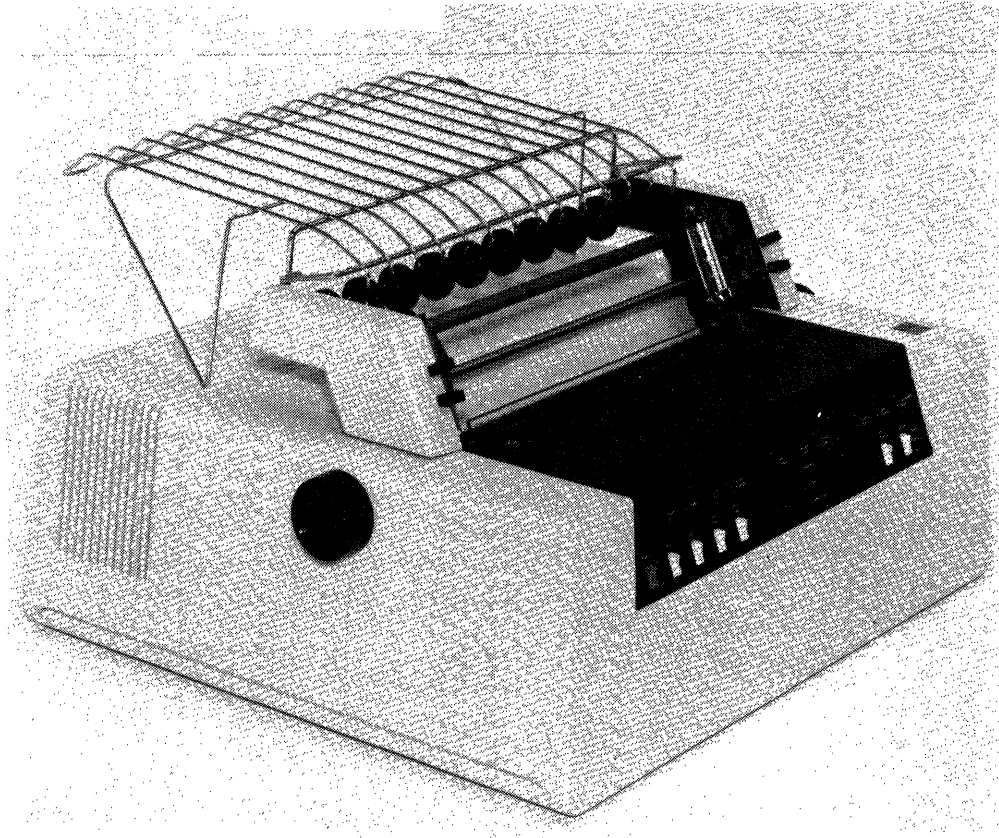
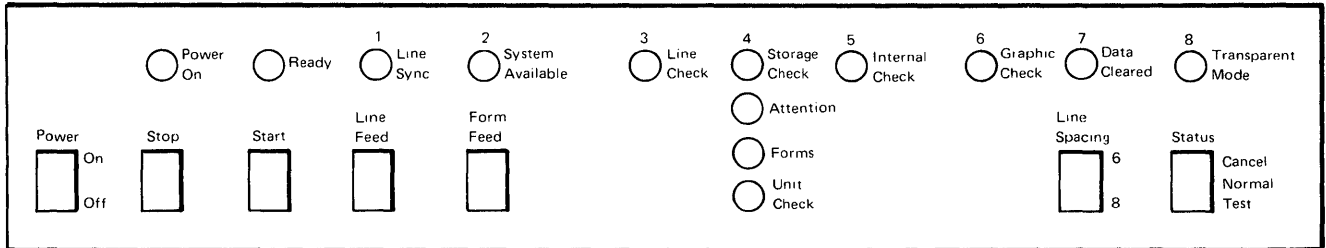

Figure 7. IBM 5256 Printer

The average printing rate depends on the model of printer used and the format of the printed data on the page. The 5256 prints bidirectionally and has look-ahead capability. This capability reduces the print head movement because it does not require the print head to move to a margin before printing. Instead, the print head continues to print while moving in either direction, thus increasing throughput.

The control panel is on the front of the printer. On the control panel are 13 lights, a Power switch, a Status switch, and five functional switches including a Line Spacing switch, which can be used to select either 6 or 8 lines per inch. When the Status switch is set to Test, the lights numbered 1 through 8 take on alternative meanings and are used for problem determination.



Continuous or individual forms can be used in the 5256 Printer. The printer accepts forms of up to six parts, but forms consisting of more than four parts should be tested under operating conditions to determine suitability of feeding and legibility of the print.

Continuous forms can be 3 to 15 inches wide, and individual forms can be 6 to 14.5 inches wide. Refer to the *Form Design Reference Guide for Printers*, GA24-3488, for general form-design information, such as, form length, weight, fastenings, and other form-related items that should be considered when forms are designed.

The forms tractor is required for continuous forms, but it can be easily removed when the printer is being used for individual forms. A Forms Stand feature permits stacking of continuous forms above floor level.

FEATURES

This section describes the features for the 5250 Information Display System.

The following chart shows the standard functions and features for the 5250 Information Display System. Standard functions are described in Chapter 3, *Functional Capabilities*.

Standard Function or Special Feature	5251 Display Station Models				5252 Dual Display Station	5225 Printer Models 1, 2, 3, and 4	5256 Printer Models 1, 2, and 3
	1	2	11	12			
Audible Alarm	Std	Std	Std	Std	Std	Feat	Feat
Cable Thru	Feat	N/A	Feat	N/A	Feat	Feat	Feat
Cluster	N/A	Feat	N/A	Feat	N/A	N/A	N/A
Communications	N/A	Std	N/A	Std	N/A	N/A	N/A
DDS Adapter	N/A	Feat	N/A	Feat	N/A	N/A	N/A
EIA Interface	N/A	Feat	N/A	Feat	N/A	N/A	N/A
1200 bps Integrated Modem (nonswitched)	N/A	Feat	N/A	Feat	N/A	N/A	N/A
1200 bps Integrated Modem (switched with manual answer)	N/A	Feat	N/A	Feat	N/A	N/A	N/A
2400 bps Integrated Modem (nonswitched)	N/A	Feat	N/A	Feat	N/A	N/A	N/A
2400 bps Integrated Modem (switched with auto answer)	N/A	Feat	N/A	Feat	N/A	N/A	N/A
4800 bps Integrated Modem (nonswitched)	N/A	Feat	N/A	Feat	N/A	N/A	N/A
4800 bps Integrated Modem (switched with auto answer)	N/A	Feat	N/A	Feat	N/A	N/A	N/A
Internal Clock	N/A	Feat	N/A	Feat	N/A	N/A	N/A
Data Entry Keyboard	Feat ¹	Feat ¹	Feat ¹	Feat ¹	Feat ¹	N/A	N/A
Data Entry Keyboard with proof arrangement	Feat ¹	Feat ¹	Feat ¹	Feat ¹	Feat ¹	N/A	N/A
Direct Attachment	Std	N/A	Std	N/A	Std	Std	Std
Display Field Attributes	Std	Std	Std	Std	Std	N/A	N/A
Blink							
Column Separator							
High Intensity							
Nondisplay							
Reverse Image							
Underscore							
Display Screen Filter	Feat	Feat	Feat	Feat	N/A	N/A	N/A
Dual Cluster	N/A	Feat	N/A	Feat	N/A	N/A	N/A
Expanded Function	N/A	Feat	N/A	Feat	N/A	N/A	N/A
Copy-to-Printer	N/A	Feat	N/A	Feat	N/A	N/A	N/A
Magnetic Stripe Reader Control	N/A	Feat	N/A	Feat	N/A	N/A	N/A
Selector Light Pen Control	N/A	Feat ¹	N/A	Feat ¹	N/A	N/A	N/A
Self-Check Number	N/A	Feat	N/A	Feat	N/A	N/A	N/A

Legend

Feat—Available Features

N/A—Not Applicable

Std—Standard Function

¹Some host systems might not support this feature. Consult your IBM sales representative to determine whether your system will support this feature.

Standard Function or Special Feature	5251 Display Station Models				5252 Dual Display	5225 Printer Models 1, 2, 3, and 4	5256 Printer Models 1, 2, and 3
	1	2	11	12			
Format Control	Std	Std	Std	Std	Std	N/A	N/A
Field Edit and Control							
Forms Stand	N/A	N/A	N/A	N/A	N/A	Std	Feat
Help Function	Std	Std	Std	Std	Std	N/A	N/A
Keyboard Signal	Std	Std	Std	Std	Std	N/A	N/A
Keylock	Feat	Feat	Feat	Feat	Feat	N/A	N/A
Magnetic Stripe Reader	Feat	Feat	Feat	Feat	Feat	N/A	N/A
Multinational Character Set	Feat	Feat	Feat	Feat	Feat	Feat	Feat
10-Key Numeric Pad	Std ²	Std ²	Std ²	Std ²	Std ²	N/A	N/A
Selector Light Pen	Feat ¹	Feat ¹	Feat ¹	Feat ¹	N/A	N/A	N/A
Twinaxial-Coaxial Adapter	Feat	Feat	Feat	Feat	Feat	Feat	Feat
Typewriter-like Keyboard	Std	Std	Std	Std	Std	N/A	N/A
Uppercase/Lowercase	Std	Std	Std	Std	Std	Std	Std
1,920-Character Single Display	N/A	N/A	Std	Std	N/A	N/A	N/A
960-Character Dual Display	N/A	N/A	N/A	N/A	Std	N/A	N/A
960-Character Single Display	Std	Std	N/A	N/A	N/A	N/A	N/A

Legend

Feat—Available Features

N/A—Not Applicable

Std—Standard Function

¹Some host systems might not support this feature. Consult your IBM sales representative to determine whether your system will support this feature.

²The 10-key numeric pad is standard on the typewriter-like keyboard; it is not available on the data entry keyboard.

Audible Alarm

The Audible Alarm feature, available for the 5225 and the 5256 Printers, alerts the operator to problems that require attention. For example, the alarm sounds if the printer detects an error that would stop printing or if the Attention light comes on.

The Audible Alarm can be effectively used when operator intervention is required; for example, it may be used either during a wait or when the printer is unattended. There is a manual volume control for this alarm at the rear of the printer.

The Audible Alarm is a standard function on all display stations.

Cable Thru

The Cable Thru feature provides the capability of attaching multiple display stations or printers to a single cable. A maximum length of 1525 meters (5000 feet) of twinaxial cable or 610 meters (2000 feet) of coaxial cable is allowed between a host system or a 5251 Model 2 or 12 and the last work station on the cable thru line. When coaxial cable is used to attach work stations to the host system or to a Model 2 or 12, only one work station may be cabled thru, and the cable thru line must be of twinaxial cable and must not exceed 30 meters (100 feet) in length. The Cable Thru feature is not required on the last work station on the cable thru line, but should be considered for added flexibility when moving work stations.

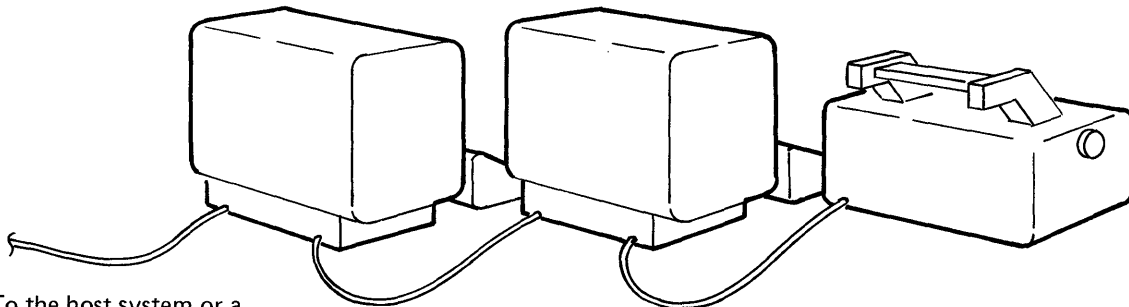

To the host system or a
5251 Model 2 or 12

Display stations and printers with the Cable Thru feature have an additional cable connector and station address switches. The address switches are used to assign a unique address to each station on a cable. Station addresses must be assigned prior to setting up the display system or when the host system is configured.

Cluster Features

Two mutually exclusive cluster features (Cluster or Dual Cluster) are available for attaching the Model 2 or 12 directly to 5225 Printers, 5256 Printers, 5251 Model 1 or 11 Display Stations, or 5252 Dual Display Stations. The Cluster feature provides four cable connections and allows the attachment of up to four work stations. The Dual Cluster feature provides eight cable connections and allows the attachment of up to eight work stations. The 5252 counts as two work stations because of its two keyboards.

Figure 8 shows three 5251 Model 2 or 12 Display Stations in cluster configurations: one display station has the Cluster feature, and the other two display stations have the Dual Cluster feature. Each 5251 Model 2 or 12 is controlling the maximum number of directly attached work stations.

This illustration also shows two methods for connecting directly attached work stations to the Model 2 or 12. The cables can be connected directly between the Model 2 or 12 and the work station, or the cables can be connected between two work stations when they have the Cable Thru feature. Both methods can be used in a cluster configuration. Whichever method you choose, the farthest attached work station on each line can be no more than 1525 meters (5000 feet) away from the host system or the 5251 Model 2 or 12 when twinaxial cable is used and no more than 610 meters (2000 feet) away when coaxial cable is used. When coaxial cable is used, only one work station can be a cable thru; the second work station must be within 30 meters (100 feet) and be attached by twinaxial cable. (Coaxial cable will only support two attached work stations for each port.)

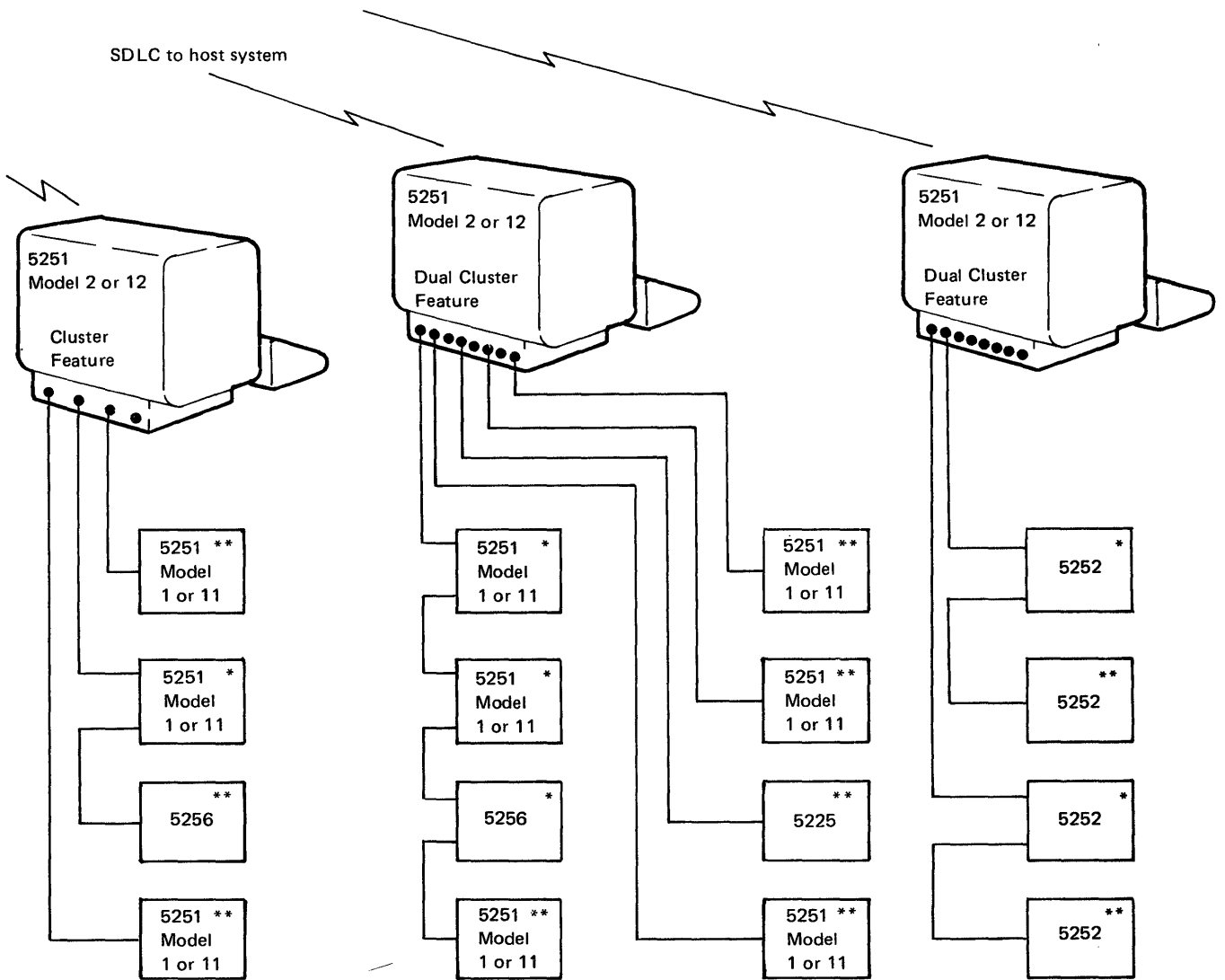

*Cable Thru feature

**Cable Thru feature recommended

Figure 8. Cluster Configurations

Communications Features

Internal Clock

The Internal Clock feature provides clocking of the data on and off the communications line at 1,200 bits per second. This feature is required only when the attached modem¹ does not provide its own clocking.

DDS Adapter

The DDS (Digital Data Service) Adapter feature allows the 5251 Model 2 or 12 to be connected to an AT & T nonswitched (leased) Data-Phone² Digital Service Network. The DDS Adapter provides an interface to a DDS channel service unit, which is the customer site termination to the network. The digital network provides the Model 2 or 12 user with data rates of 2,400; 4,800; or 9,600 bits per second (bps) on the communications line.

EIA Interface

The EIA (Electronic Industries Association) Interface feature provides the 5251 Model 2 or 12 with an interface for attaching an external modem which meets the EIA Standard RS-232C characteristics. The external modem can be either an IBM modem or a non-IBM modem. The modems must be compatible at each end of the communications line. The modem attachment is made via an IBM-supplied communications cable. You can obtain additional modem interface information from your IBM representative.

Integrated Modems

Integrated modems allow connection to either a customer owned communications line or a common carrier provided nonswitched or switched communications line. The 5251 Model 2 or 12 can utilize the following integrated modems:

- 1200 bps (Internal Clock feature required)

Nonswitched – Connection is directly to the line via an IBM-supplied cable.

Switched (with manual answer) – In the US and Canada, connection to the line is via an external CDT type data coupler. In World Trade countries (except Canada), connection to the line is via an integrated World Trade coupler.

¹This feature is necessary for 1200 bps Integrated modems.

²Trademark of American Telephone & Telegraph Co.

- 2400 or 4800 bps with remote half-speed control (Internal Clock feature not required).

Nonswitched – Connection is directly to the line via an IBM-supplied cable.

Switched (with auto answer) – In the US, connection to the line is via an integrated protective coupler (provided as part of the 2400 or 4800 bps Integrated Modem feature). In Canada, connection to the line is via an external CBS type data coupler (which is provided by the customer or the common carrier) and the integrated coupler adapter. In World Trade countries (except Canada), connection to the line is via an integrated World Trade coupler (provided as part of the 2400 or 4800 bps Integrated Modem feature).

Expanded Function

The Expanded Function feature includes copy-to-printer, self-check number capabilities, Magnetic Stripe Reader control, and Selector Light Pen control¹.

The Copy-to-Printer feature provides for the direct transfer and printing of a display image from a directly or remotely attached display station to a printer attached to the 5251 Model 2 or 12. The selection and allocation of the printer is controlled by the system program.

The Self-check feature provides a method of checking the accuracy of a field as it is being entered. As a field is being entered, a self-check digit is computed. After the field has been entered, the last digit entered in the field is compared with the computed self-check digit for a correct match. The self-check number detects incorrect entering of a single digit, single transpositions, and double transpositions. The 5251 Model 2 or 12 uses either modulus 10 or 11, two standard algorithms, to verify the self-check digit.

The Magnetic Stripe Reader Control feature is provided for the Magnetic Stripe Reader connected to the 5251 Model 2 or 12 and for those magnetic stripe readers connected to attached 5251 Models 1 and 11 and the 5252.

The Selector Light Pen Control feature is provided for the Selector Light Pen connected to the 5251 Model 2 or 12 and for those selector light pens connected to attached 5251 Models 1 and 11.

¹Some host systems may not support all features. Consult your IBM sales representative for details on your host system.

Keyboards

There are three different keyboards available for the display stations: the typewriter-like keyboard, the data entry keyboard, and the data entry keyboard with proof arrangement.¹ A cable connects the chosen keyboard to the display unit and allows the keyboard to be placed in the most convenient work position. The typewriter-like keyboard, shown in Figure 9, includes the basic keyboard arrangement found on a standard typewriter and an extra set of numeric keys arranged like those on a calculator keyboard.

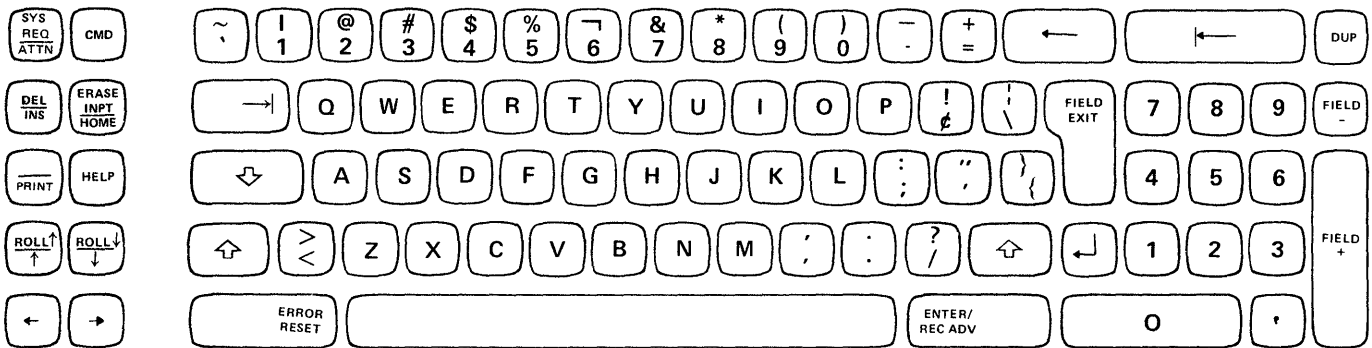
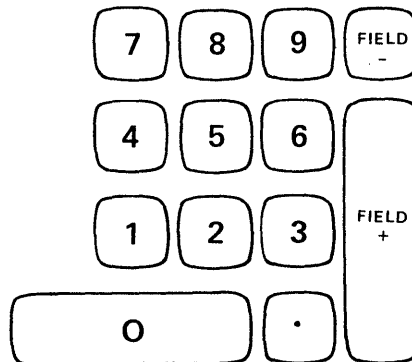

Figure 9. Typewriter-like Keyboard

The numeric 10-key cluster (shown below) is convenient to use when entering numeric data.



¹Some host systems may not support all features. Consult your IBM sales representative for details on your host system.

The data entry keyboard, shown in Figure 10, provides a key arrangement similar to that used on key punches, IBM 3741 Data Entry Stations, and IBM System/3 consoles. This keyboard is also available with the Proof Arrangement feature. This feature contains a numeric configuration similar to a 10-key calculator keyboard. The Proof Arrangement can be selected to either complement the skills of the operator or to fulfill the requirements of the application.

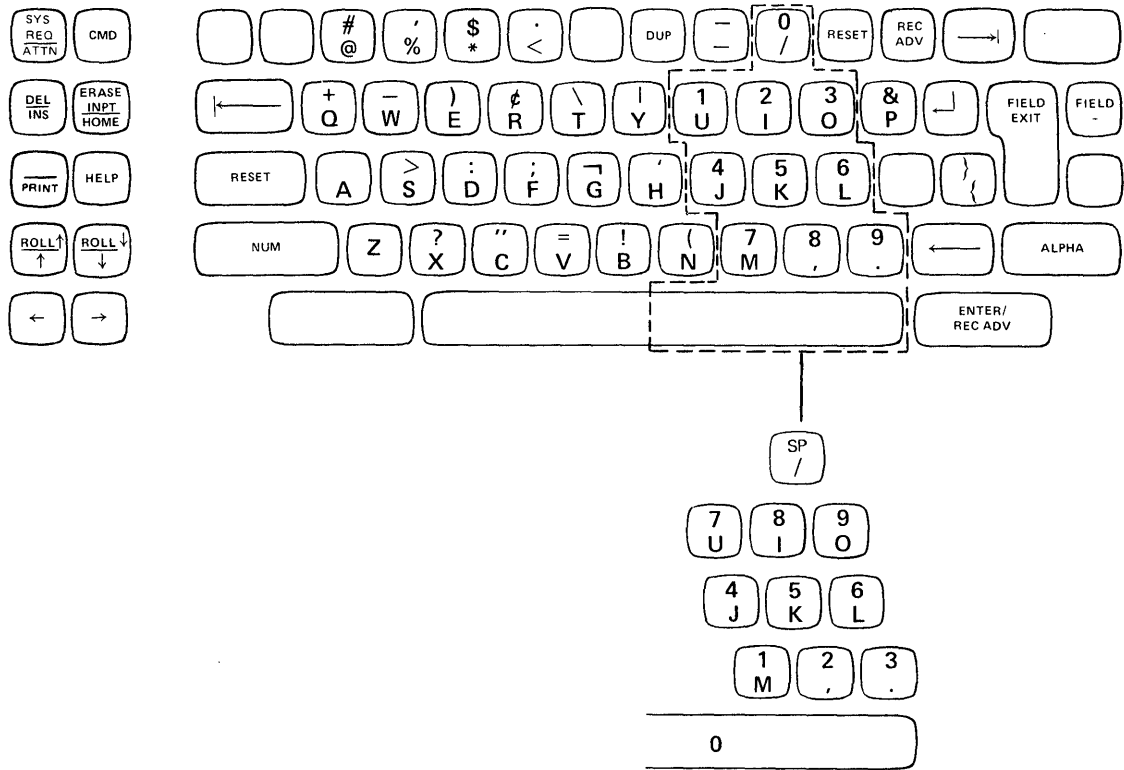

Figure 10. Data Entry Keyboard with the Proof Arrangement Feature

The keyboards have several types of keys to accomplish specific purposes:

- The standard alphameric keys (letters, numbers, and special symbols) to enter data
- Cursor movement keys to position the cursor
- Function control keys to communicate with the host system
- A command key that permits selection of 24 programmable, command functions, assigned to the top row of keys

The alphabetic keys, special symbol keys, numeric keys, spacebar, and cursor control keys repeat their function. The operator simply keeps the desired key pressed and the display station performs the action once, pauses, then automatically repeats the function at the rate of approximately 10 repetitions per second.

Cursor movement keys permit rapid positioning of the cursor to any character position on the display. In upper shift on the typewriter-like keyboard or numeric shift on the data entry keyboard, cursor movement keys permit movement of lines of data on the screen, when so programmed. (The cursor itself does not move.) These keys cause the cursor to move in the direction indicated by the arrows on the keytop.

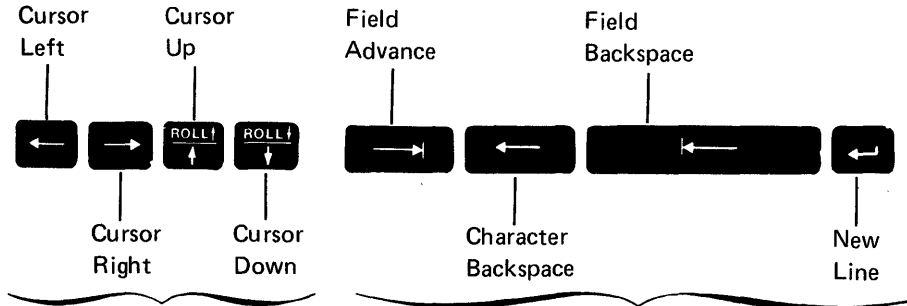

These keys move the cursor to any location.

These keys move the cursor only to locations programmed to accept operator input.

Figure 11 shows the function control keys. These keys perform system-related functions as well as operations on the display station.











	Function	Description
	System Request	Used with the Enter key to initiate the sign-on procedure.
	Attention	Used to signal the host system.
	Command	Assigns the alternative functions for the top row of keys.
	Delete	Causes the character above the cursor to be deleted and moves to the left, one position, all characters that are to the right of the cursor and in the same field.
	Insert	Used to select Insert mode. Insert mode allows characters to be inserted into a field while the character above the cursor and all following characters in the field are shifted to the right.
	Erase Input	Blanks all operator entered data and fields that the operator has modified.
	Home	Returns the cursor to the home position (first input position of the first input field) or requests a record backspace if the cursor is at the home position.
	Print	Requests that the information that appears on the display screen to be printed.
	Help	Used to request additional information about an error or to request help from the system.
 	Roll	Used to request that the host system move the displayed information up or down to change the effective viewing area.

Figure 11. Function Control Keys

Keylock

The Keylock feature, which is available for all display station models, provides a lock and key that can be used to disable the display station whenever it is to be left unattended. When the key is in the locked position or is removed from the display station, the operator is unable to enter or display data. When the key is in the unlocked position, data entry and display are allowed. The key cannot be removed when it is in the unlocked position.

Magnetic Stripe Reader

The Magnetic Stripe Reader feature, which is available for all display station models, provides the capability of reading numeric encoded information from a magnetic stripe. The stripe can be used on credit cards, operator identification badges, and other magnetic encoded documents. The magnetic stripe can be encoded with up to 128 numeric characters, including control characters. This feature can enhance system data security by requiring a preliminary access to sign on. The Expanded Function feature is required on the Model 2 or 12 when a magnetic stripe reader is connected to the Model 2 or 12 or to an attached display station. Two magnetic stripe readers can be connected to a 5252 Dual Display Station.

Selector Light Pen

The Selector Light Pen feature, which is available for all models of the 5251 Display Station, is a pen-like device that permits the operator to select fields of data from the display screen for system input. The Expanded Function feature is required on the 5251 Model 2 or 12 when a selector light pen is connected to the Model 2 or 12 or to an attached Model 1 or 11.¹

¹Some host systems might not support the Selector Light Pen feature. Consult your IBM sales representative to determine whether your system will support this feature.

Chapter 3. Functional Capabilities

The 5250 Information Display System offers a wide range of functional capabilities that enhance both system and operator control over data flow and application performance.

5251 AND 5252 DISPLAY STATIONS

This section describes the functional capabilities of the display station.

Command Functions

Twenty-four additional functions can be assigned to the top row of keys. This capability allows unique adaptability of the display station to your own applications. The additional functions can be written on a template, and the template can be placed in the recessed area above the top row of keys. Extra templates are provided with each display station. These extra templates make it convenient to use a separate template for each application.

Display Mode	13	14	15	16	17	18	19	20	21	22	23	24	Clear
	1	2	3	4	5	6	7	8	9	10	11	12	Test Request

The *IBM 5250 Information Display System Keyboard Template Assignment Sheet and Display Screen Layout Sheet, GX21-9271*, applies to both the 5251 and 5252 and can be used to document the additional functions (see Figure 12).

The Cmd key (command key) is used to select the command functions.

Pressing the Cmd key and then pressing one of the top row keys selects command functions 1 through 12, or Test Request. Pressing the Cmd key, then holding down the Upper Shift key on the typewriter-like keyboard or the Numeric Shift key on the data entry keyboard and pressing one of the top row of keys selects Display Mode, command functions 13 through 24, or Clear.

- *Clear* is used to blank every character position on the display screen and to position the cursor at the first character position on line 1.
- *Test Request* is used to select an interactive procedure for checking communication between the display station and the host system.
- *Display Mode* allows the operator to select the display mode best suited for the light level. Light characters can be displayed on a dark background or dark characters can be displayed on a light background.

Figure 12 (Part 1 of 2)



**5250 Information Display System
Keyboard Template Assignment Sheet and
Display Screen Layout Sheet**

Format Name _____ Description _____

Job Name _____ Sheet _____ of _____

Originated by _____ Date _____

Display Mode	13	14	15	16	17	18	19	20	21	22	23	24	Clear
	1	2	3	4	5	6	7	8	9	10	11	12	Test Request

Keyboard Template Assignments

1	
2	
3	
4	
5	
6	
7	
8	
9	
10	
11	
12	
13	
14	
15	
16	
17	
18	
19	
20	
21	
22	
23	
24	

Address comments concerning this form to IBM Corporation, Department 245, Rochester, Minnesota 55901.

File No. S5250/S34/S38-89

GX21-9271-1 UM/050*
Printed in U.S.A.

*Number of forms per pad could vary slightly.

Character Sets

The standard 5251 and 5252 character sets consist of 96 alphabetic characters in both uppercase and lowercase, numerics, and special symbols. Keyboards and displayable character sets are provided for the following countries: Austria, Belgium, Brazil, Canada (English), Canada (French), Denmark, Finland, France, Germany, Italy, Japan (English), Japan (Katakana), Norway, Portugal, Spain, Spanish-speaking countries, Sweden, the United Kingdom, and the United States. The Multinational Character Set feature is also available. This feature contains all the characters and special symbols for all the preceding countries except Japan (Katakana).

Display Control and Highlighting Attributes

The 5251 and 5252, with the host system, provide data entry control by data field. Each data field is established by a field attribute preceding the first position of the field. The field attribute, which is written by the system program, uses a single nondisplayed character position and serves as a visual separation between successive fields. A field can be started at any character position of the display and is variable in length. The attributes are shown in Figure 13.

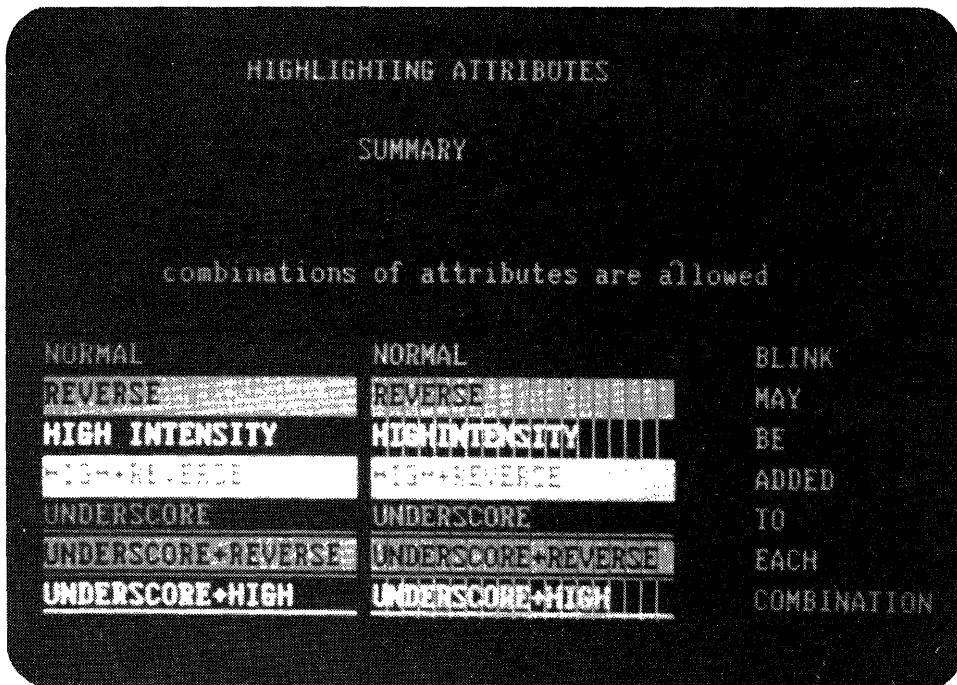

Figure 13. Highlighting Attributes

Blink: Causes all characters in the field to blink repeatedly to attract the operator's attention. The entire field is blinked at the rate of approximately one and one-half times per second.

Column Separator: Causes all characters in the field to be preceded by and followed by a vertical bar. Column separators at the same column position on successive rows will appear on the display as a continuous or broken vertical line.

High Intensity: Causes the characters in a field to be displayed at a brighter intensity than other data on the screen. The Contrast control on the control panel can be used to adjust the brightness of high intensity fields.

Nondisplay: Allows data to be entered without being displayed. This attribute is beneficial in applications for which there are security restrictions. An identification can be entered in nondisplay fields to prevent unauthorized viewing.

Reverse Image: Causes the characters in the field to be displayed as either a dark graphic on a light background or, if Display Mode had been previously selected by the display operator, light characters on a dark background. The preceding display capabilities, with blink cursor, can be used to alert the operator that an error has occurred or that a specified action must be performed.

Underscore: Places a continuous line under all positions of the field.

Format Control

The following field edit and control functions are provided by the host system or by the 5251 Model 2 or 12.

Alpha Only

Fields specified as alpha only allow only the characters A through Z, comma, period, hyphen, and blank to be entered.

Alphanumeric Entry

A field specified as alphanumeric allows the operator to enter all characters on the keyboard. Manual shift is required to enter uppercase and symbols on the upper part of the key.

Auto Enter

A field specified as auto enter causes the same function as if the operator pressed the Enter key at the conclusion of entering information for that field.

Bypass

A field specified as bypass restricts information from being entered. This field is skipped over whenever the cursor appears within the field.

Duplicate Enable

A field specified as duplicate enable allows the operator to press the Dup key. The Dup function is typically interpreted by the application program to mean duplicate this field from the previous record.

Field Exit Required

A field specified as field exit required requires that a field exit key, cursor movement key, or any other nondata key, be used to exit the field. If the operator attempts to leave a field defined as field exit required by using a data key, an error will be displayed.

Mandatory Entry

A field specified as mandatory entry requires that at least one character must be entered in the field.

Mandatory Fill

A field specified as mandatory fill requires that if one character is entered in the field, the entire field must be filled.

Monocase

Alphabetic data entered into fields defined as monocase will automatically be entered, displayed, stored, and transmitted as uppercase (capitals). If the uppercase character is not included on the keyboard (or in a particular language character set), the lowercase character will be used. Monocase does not affect special characters or numbers.

Numeric Only

A field specified as numeric only accepts only the characters 0 through 9, plus, comma, period, hyphen, and blank.

Right Adjust

A right-adjust field allows data entered into the field to be moved to the right field boundary when the Field Exit, Field +, or Field - key is pressed. If the field is not filled, the positions to the left of those characters entered by the operator are filled with either zeros or blanks.

Signed Numeric

Signed numeric fields reserve the units position of that field for display of the sign: minus for negative, and blank for positive. For example, a six-position signed numeric field can use only five positions for operator entered data; the sixth position is reserved for the sign. Pressing the Field Exit key results in the positive indication. In addition, a signed numeric field allows only 0 through 9 to be entered and the numbers are automatically right-adjusted with blank fill or zero fill as requested.

Help Function

If the operator does not understand an error code, the Help key can be used to request additional information about the error. The Help function can also be used in an application program to provide help that is not related to an error condition.

Keyboard Signal

A keyboard signal can be programmed to produce an audible tone for approximately one second. The keyboard signal can be effectively used as a ready signal during a wait.

Communications

The 5251 Display Stations Models 2 and 12 include a communications adapter for communicating with the host system. The communications adapter performs the general functions common to SNA/SDLC (systems network architecture/synchronous data link control). SNA/SDLC is a line discipline, using centralized control, for synchronous transmission by buffered work stations on a data transmission link. SDLC includes error detection and recovery procedures that permit automatic error recovery for transmission errors occurring on the data link. Therefore, SDLC results in increased transmission efficiency and utilization of common carrier facilities.

After SDLC receives the data and acknowledges the validity of the data, it routes the data to SNA for processing. SNA formally defines the functional responsibilities of communications system components. The 5251 Model 2 or 12, an SNA communications product, can perform functions that were formerly done by the host system. These functions can include device control and data formatting. Because these functions are placed in the Model 2 or 12, application programs and additional 5250 Information Display System products can be added or changed without affecting other elements of the communications system.

5225 and 5256 PRINTERS

This section describes the functional capabilities of the 5225 Printer and the 5256 Printer.

Character Sets

The 5225 and 5256 character sets consist of characters in both uppercase and lowercase, numerics, and special symbols. Character sets are provided for the following countries: Austria, Belgium, Brazil, Canada (English), Canada (French), Denmark, Finland, France, Germany, Italy, Japan (English), Japan (Katakana), Norway, Portugal, Spain, Spanish-speaking countries, Sweden, the United Kingdom, and the United States. The Multinational Character Set feature is also available. This feature contains all the characters and special symbols for all the preceding countries except Japan (Katakana). The Japan (Katakana) character set for the 5225 and 5256 Printers contains the 128 characters available on the display station Katakana keyboard.

Bidirectional Printing

Bidirectional printing is the ability to print from left to right and from right to left. Bidirectional printing and concurrent tabbing with high-speed line feeding makes the average printing rate dependent on the length of the printed line, the model of the printer, the amount of tabbing within the printed line and the amount of line feeding between printed lines. Bidirectional printing and dual print buffers increase the throughput of the printer.

Dual Print Buffers

The 5225 Printer uses two 256-byte receive buffers and two 198-byte print buffers. The 5256 Printer uses two 256-byte receive buffers and two 132-byte print buffers. When a block of data is received, the printer formats the data into print lines. Then as each print line is formatted, printing is started and formatting of the next print line is initiated. Two print buffers are used to ensure that the formatting is one line ahead of the printing.

Chapter 4. Applications

This chapter describes the display system environment, discusses two general areas where display systems can be used, and then describes a sample application.

Display System Environment

Business firms of different sizes and branch locations of larger companies are considering display systems because they:

- Increase productivity through system/operator interaction.
- Provide fast update and visual verification of system files.
- Extend system data files to using departments.
- Provide fast system console response.

Two or more display stations can be used at the same time. For example, a purchasing agent can use a display station for inventory control while a clerk is using another display station to fill customer orders. Figure 14 shows a typical display system environment.

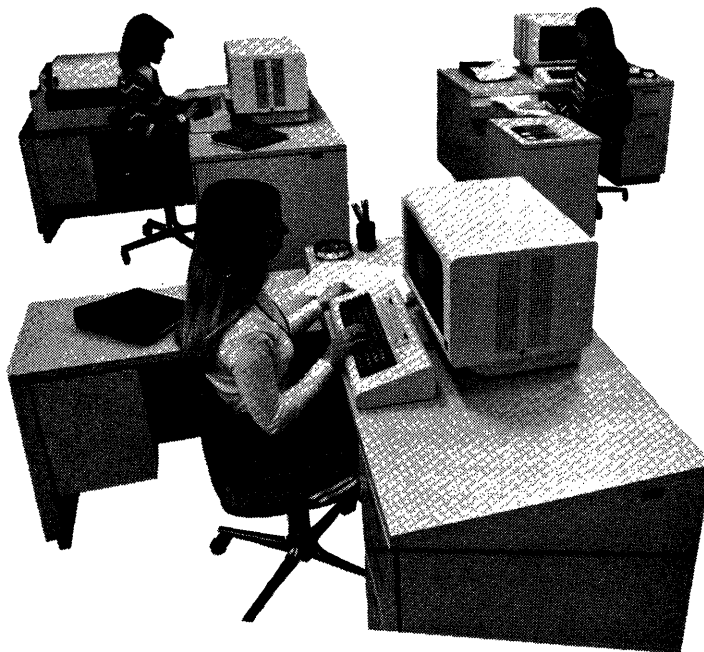

Figure 14. Display System Environment .

The display station operator can treat displayed information as if it were pages in a book. The operator looks at one display (page) at a time, makes additions and corrections to the data in the format displayed on the screen, checks each display (page) for accuracy, and extracts the needed information.

Operators will find the display station easy to use. The keyboard can be selected with a layout similar to a typewriter or with a data entry arrangement. Information can be entered in free or formatted form. In free form, the sequence of items entered is important, but the location of the items on the display screen is not. In formatted form, the operator usually enters information opposite a prompting message.

A display station has capabilities that make selected data fields easily identified. High intensity, reverse image, blink, underscore, and the column separator are useful capabilities in an application in which exceptions must be apparent. These capabilities are also useful for inquiry and data entry applications.

Inquiry

A display station used for inquiry allows the operator to have access to a computer data file. The operator typically asks one or more short questions (inquiries) by entering a specified code. When it is supported, the Selector Light Pen feature can be used to select the desired information. The system responds by displaying information. The response might be lengthy and require the operator to read and interpret the information displayed. Based on the first system response, the operator might enter another question. While the operator is reading the displayed information, the system addresses other display stations or does other work until the operator again requests more information.

Upon completion of an assignment, an operator can sign off and return to other work. Meanwhile, someone else can use the display station. In this way, the display station can be shared by people with different work requirements.

The number of display stations to be shared depends on the number and frequency of questions, the duration of an inquiry session, and the locations of departments or persons needing access to the host system.

Inquiry with Update

The ability to find and change a record, called inquiry with update, is a natural follow-on to inquiry. Changes sometimes must be made to records being referred to by inquiry. For example, a hospital patient's medication orders may have to be changed quickly according to changes in the patient's condition, or a hotel guest's bill may have to be updated just before checkout.

Data Entry

There are two common types of data entry applications; both involve continuous operation of the display station. In the first type, the operator can be preparing a document such as a sales order. The system guides the preparation of the order and supplies some of the data to be printed. The operator enters the customer number, item numbers, and quantities. The system can be programmed to supply the customer name and address, unit prices, description, and price extensions for the items ordered.

The second type of data entry application provides for data recording in much the same way as an offline key entry device is used to punch cards or write diskettes. With a display station, the information is entered directly into the host system as data files.

Sample Application

An order from a customer initiates many activities in the business cycle. An order enters the data processing cycle in written form, on what is called a source document. How this source document is written and who writes it will vary from company to company. In many cases, an order form is filled out by the salesman and delivered directly. In other businesses, salesmen or customers might phone in orders, which are written down by an order clerk as the orders come in.

The 5250 Information Display System offers a display station and printer for performing the functions related to entering information into the system and printing reports. For example, the display station is used for creating the customer order file and the printer is used for printing invoices and picking slips. The following description of the order entry application is simplified to show the role of the display station.

The operator begins the daily activity by entering the sign-on command, with or without a password. (The Magnetic Stripe Reader feature can be used as a security feature when its use is required by the host system to complete sign-on.) If a password is requested by the program, the display station's nondisplay capability can be used to retain confidentiality of the code. The Keylock feature can also be used to prevent unauthorized use of the display station.

Next, the system displays an application menu, which is a list of jobs that can be performed. A menu simplifies the operator's duties by displaying a code corresponding to the job; this eliminates the need for the operator to know procedures and commands. The operator simply enters a code corresponding to the job and enters a password if one is required. When it is supported, the Selector Light Pen feature can be used to select the desired job. From the following display, assume the operator selected the code for the order entry application.

COMMAND	MENU: MENU1
1. STOCK STATUS INQUIRY	13.
2. ORDER ENTRY	14.
3. INQUIRY OF ORDER STATUS	15.
4. WORK ORDER RELEASE	16.
5. WORK ORDER INQUIRY	17.
6. PRODUCT STRUCTURE INQUIRY	18.
7. WHERE USED INQUIRY	19.
8. ROUTING INQUIRY	20.
9. WORK IN PROCESS UPDATE	21.
10.	22.
11.	23.
12.	24.

ENTER NUMBER, COMMAND, OR OCL.

<- READY

The order entry process is an interactive procedure, with the operator entering information and the system responding with information from the customer master file and the item master file. To begin the order entry process, the operator enters the customer number. The system then compares this number to the customer master file and responds by displaying an order format with the SOLD TO name and address and the customer number or by displaying an error message when an invalid customer number is entered.

The customer number entered by the operator.

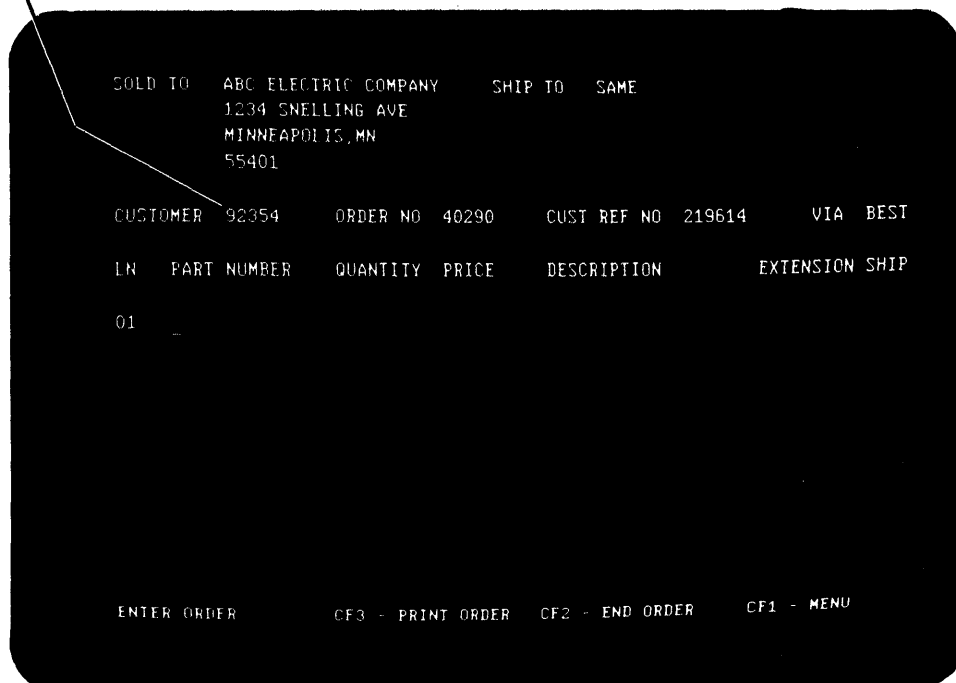

The screenshot shows a terminal window with the following text:

```
SOLD TO  ABC ELECTRIC COMPANY  SHIP TO  SAME
          1234 SNELLING AVE
          MINNEAPOLIS, MN
          55401

CUSTOMER 92354  ORDER NO 40290  CUST REF NO 219614  VIA BEST

LN  PART NUMBER  QUANTITY  PRICE  DESCRIPTION  EXTENSION  SHIP

01  _

ENTER ORDER  CF3 - PRINT ORDER  CF2 - END ORDER  CF1 - MENU
```

A callout line points from the text 'The customer number entered by the operator.' to the 'CUSTOMER 92354' field in the terminal output.

After confirming the customer name and address and entering other heading information (if required), the operator is ready to begin entering line item information. The operator would normally enter the part number and quantity and then press the Enter key. Mandatory entry could be specified for the part number field whereas the quantity field, if not entered, would default to 1. After the system validates these entries, the price and description will be displayed; the system calculates and displays the price extension, and the operator can visually verify the line. The high intensity or blink field attributes could be used to get the operator's attention if an incorrect part number was entered.

The part number and quantity entered by the operator.

```

SOLD TO  ABC ELECTRIC COMPANY  SHIP TO  SAME
          1234 SNELLING AVE.
          MINNEAPOLIS, MN.
          55401

CUSTOMER 92354  ORDER NO 40290  CUST REF NO 219614  VIA BEST

LN  PART NUMBER  QUANTITY  PRICE  DESCRIPTION  EXTENSION SHIP
01  2890         2        1.46  INSULATOR   2.92      2
02  214          1       12.30  RELAY       12.30     1
03  1478         6        6.06  BATTERY    36.36     6

TAX      2.06
FREIGHT  5.16

TOTAL   58.80

ENTER ORDER  CF3 - PRINT ORDER  CF2 - END ORDER  CF1 - MENU
  
```

Three options are available to the operator while entering the order. For example, the command function keys can be programmed to print the order (CF3), end the order (CF2), or return to the application menu (CF1). These functions are displayed at the bottom of the display.

After the entire order has been entered, the system calculates the taxes and shipping charges, and then compares the total amount of the order with the customer's credit limit in the customer master file. The total amount is displayed or a message is displayed indicating that the order exceeded the credit limit. The message could be displayed in reverse image or blinked to emphasize the error condition.

After all orders are entered, the operator uses CF1 to return to the application menu and select another job. The system retains the order information for updating the item master file and for printing invoices and management reports.

Chapter 5. Additional Considerations

Planning the Installation

You should read the *IBM 5250 Information Display System Planning and Site Preparation Guide, GA21-9337*, to determine how to best prepare your site for arrival of the equipment.

Some of the topics discussed in the *Planning and Site Preparation Guide* are:

- Space requirements
- Environment
- Furniture
- Electrical requirements
- Cable specifications
- Cable assembly procedures
- Unit specifications

Careful advance planning and scheduling make it possible for you to set up the equipment with minimum interruption of the daily work routine.

Setting Up the System

After planning and preparing the location, you will be ready to set up the display system.

When the equipment arrives, plan to have two people available to set the machines in place. The 5225 Printer must be wheeled into place; it weighs approximately 250 kg (560 lbs). All other machines weigh from 34-45 kg (75-100 lbs); they can be lifted from the cartons and set in place. Set up the equipment by following the step-by-step instructions provided with each machine.

No tools or access to the inner parts of the machine will be required. The complete process consists of unpacking the machines, locating the machines in the prepared areas, connecting the cables, and performing a checkout procedure to verify that they operate properly.

The instructions should be retained for future reference if the machines are subsequently moved to other areas.

Reliability and Serviceability

The 5251, 5252, 5225, and 5256 incorporate some of the latest technological advances in the industry and use high-quality components to increase reliability of the machines. Should a problem occur, IBM has included procedures that allow the operator either to correct the problem or to accurately describe the problem to the service representative.

Error Codes

Error codes tell the operator that an incorrect operation was attempted or that the host system is not responding properly. Use of the Help key allows some error codes to be displayed with a message that explains the situation and how to correct the situation. Additional error code information is contained in the appropriate operator's guide.

Basic Testing Routines

The operator can use basic testing routines to periodically check out all operations of the machines. On the display station, the operator selects Test Request; on the 5225 Printer, the operator moves the Mode switch to Test; on the 5256 Printer, the operator moves the Status switch to Test. The operator's guides tell the operator what to expect from the basic testing routines and what to do if the routines should detect a problem.

Problem Determination

When a problem is suspected, the operator should determine the operational status of the machine before calling the service representative. This can be done using the problem determination procedures in the operator's guides. These procedures are designed for use by an operator who has little or no data processing experience. They will guide the operator step-by-step in determining whether the problem was caused by an incorrect operating procedure, a common carrier transmission problem, or a machine failure. For example, the procedures suggest that the operator verify the operating procedure used when the problem occurred. If the problem is within the display station or printer, the procedures assist the operator in gathering pertinent information and inform the operator what to report when calling the service representative. The operator's description of the problem will speed the repair action by the service representative.

Where more than one page reference is given, the major reference is first.

- additional considerations 45
- advantages, display system 4, 39
- alpha only 35
- alphameric entry 35
- applications
 - display system 39
 - sample 42
- attachment to system 1, 4
 - direct 13, 20
 - remote 9
- attention 29
- attribute 34
- audible alarm, printer 22, 20
- auto enter 36

- basic testing routines 46
- bidirectional printing 38
- blink 35, 20
- bypass 36

- cable thru feature 22, 2, 20
 - application 4, 7
- character backspace 28
- character set
 - display station 34
 - printer 38
- clear 31
- cluster features 22, 20
 - application 5, 7
- coaxial cable 8, 23, 1
- column separator 35, 20
- command functions 31
- command key 31, 28
- communications 8, 37
 - adapter 37
 - features 24, 20
- configuration sample 5
- control panel
 - display station 11, 13
 - 5225 Printer 16
 - 5256 Printer 19
- copy-to-printer 25, 20
- cursor 9
- cursor movement keys 28

- data entry 41
- data entry keyboard 27, 20
- data security 30, 42
- DDS adapter 24, 20
- delete 29
- direct attachment 13, 20
- display
 - control and highlighting attributes 34
 - control by data field 34
 - control panel 11, 13
 - field attributes 20
 - indicators 9
 - lights 11, 13
 - mode 31
 - row and character arrangement 9, 32
 - screen filter 20
 - screen layout sheet 31
 - system environment 39
- dual cluster 22, 20
- dual display station, 5252 14, 7
- dual print buffers 38
- duplicate enable 36

- EIA interface 24, 20
- erase input 29
- error codes 46
- expanded function feature 25, 20, 30

- features 19, 7
- field advance 28
- field backspace 28
- field exit required 36
- format control 35, 21
- forms design 17, 19
- forms stand 21
- function control keys 29
- functional capabilities 31

half-duplex 9
help function 37, 21
help key 29
high intensity 35, 20, 44
highlights, display system 1
home 29
host system 1, 5

indicators, display 9
input inhibited indicator 9
inquiry 5, 40
 with update 40
insert 29
insert mode indicator 9
installation, planning the 45
integrated modems 24, 20
internal clock 24, 20
introduction 1

keyboards 26
keyboard shift indicator 9
keyboard signal 37, 21
keyboard template 31
keyboard template assignment sheet 32
keylock feature 24, 2, 21

language group
 display station 34
 printer 38
light pen, selector 30, 25, 21
line spacing, printer 16, 19
lowercase
 display station 34, 21
 printer 38, 21

magnetic stripe reader 30, 25, 21
 control 30, 25, 20
mandatory entry 36, 44
mandatory fill 36
menu 42
message waiting indicator 9
mode switch 17
modem 24, 12
monocase 36
multinational character set 34, 38, 21

nondisplay 35, 42, 20
nonswitched lines 24, 9
numeric only 36
humeric 10-key cluster 26, 21

password 42
planning the installation 45
print 29
printer
 control panel 16, 19
 forms 17, 19
 highlights 2
 lights 16, 19
 speeds 7
 5225 15, 2, 7, 38
 5256 18, 3, 7, 38

problem determination 46
proof arrangement 27, 20

reliability and serviceability 46
remote communications 9
reverse image 35, 40, 20
right adjust 37
roll 29

sample application 42
sample configuration 5
SDLC 9, 1
security 24, 2
selector light pen 30, 25, 21
 control 30, 25, 20
self-check number 25, 20
serviceability and reliability 46
setting up the system 45
signal, keyboard 37
signed numeric 37
SNA 9, 1
standard functions 20
switched lines 24, 9
system available indicator 9
system request 29

template, keyboard 31
test request 31, 46
twinaxial cable 8, 1, 4
twinaxial-coaxial adapter 8, 21
typewriter-like keyboard 26, 21

underscore 35, 40, 20
units and features 7
uppercase/lowercase
 display station 34, 21
 printer 38, 21

10-key cluster, numeric 26, 21
960-character dual display 7, 21
960-character single display 7, 21
1200 bps integrated modem 24, 20
1920-character single display 7, 21
2400 bps integrated modem 25, 20
4800 bps integrated modem 25, 20
5225 printer 15, 2, 7, 38
5250 highlights 1
5251 display station 7
 models 1 and 11 13, 7
 models 2 and 12 9, 7
5252 dual display station 14, 7
5256 printer 18, 3, 7, 38

Please use this form only to identify publication errors or request changes to publications. Technical questions about IBM systems, changes in IBM programming support, requests for additional publications, etc, should be directed to your IBM representative or to the IBM branch office nearest your location.

Error in publication (typographical, illustration, and so on). **No reply.**

Page Number Error

Inaccurate or misleading information in this publication. Please tell us about it by using this postage-paid form. We will correct or clarify the publication, or tell you why a change is not being made, provided you include your name and address.

Page Number Comment

Note: All comments and suggestions become the property of IBM.

Name _____

Address _____

● No postage necessary if mailed in the U.S.A.

Cut Along Line

Fold

Fold



FIRST CLASS
PERMIT NO. 40
ARMONK, N. Y.

BUSINESS REPLY MAIL
NO POSTAGE STAMP NECESSARY IF MAILED IN THE UNITED STATES

POSTAGE WILL BE PAID BY ADDRESSEE

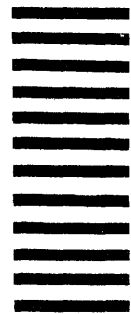

IBM Corporation
General Systems Division
Development Laboratory
Publications, Dept. 245
Rochester, Minnesota 55901

Fold

Fold

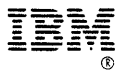

International Business Machines Corporation

**General Systems Division
4111 Northside Parkway N.W.
P.O. Box 2150
Atlanta, Georgia 30301
(U.S.A. only)**

**General Business Group/International
44 South Broadway
White Plains, New York 10601
U.S.A.
(International)**

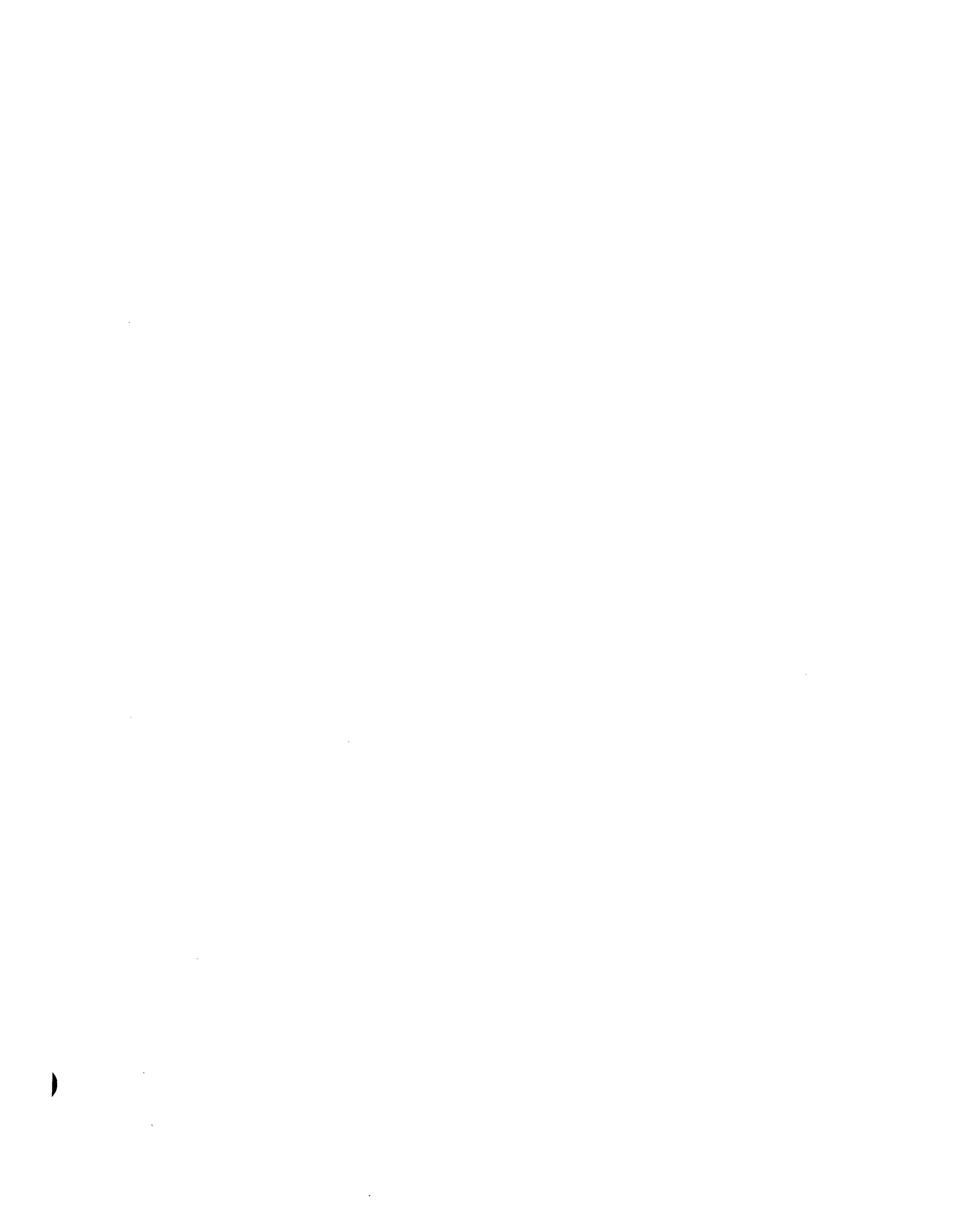



International Business Machines Corporation

**General Systems Division
4111 Northside Parkway N.W.
P.O. Box 2150
Atlanta, Georgia 30301
(U.S.A. only)**

**General Business Group/International
44 South Broadway
White Plains, New York 10601
U.S.A.
(International)**



International Business Machines Corporation

**General Systems Division
4111 Northside Parkway N.W.
P.O. Box 2150
Atlanta, Georgia 30301
(U.S.A. only)**

**General Business Group/International
44 South Broadway
White Plains, New York 10601
U.S.A.
(International)**

IBM 5250 Information Display System Introduction (File No. S5250/S34/S38-00) Printed in U.S.A. GA21-9246-4