

IBM

**Electronic
Data-Processing
Machines**

**TYPE
705**

PRELIMINARY MANUAL OF OPERATION

MINOR REVISION (June, 1957)

This edition, Form 22-6627-4, is a minor revision of the preceding edition but does not obsolete Form 22-6627-3. Principal changes in this edition are:

<i>Page</i>	<i>Subject</i>
101	New paragraph on checking on the card punch.
—	Section "Independent Operation" deleted; refer to " <i>Operator's Manual for 704-705 Auxiliary Equipment</i> , Form 22-6733, for this material.

Copyright 1955 by
International Business Machines Corporation
590 Madison Avenue, New York 22, N. Y.
Printed in U. S. A.

Form 22-6627-4

CONTENTS

	<i>Page</i>	<i>Page</i>
INTRODUCTION		
Storage	5	
Character Code System	10	
Input-Output Devices	11	
Stored Program	16	
Logical Ability	17	
DATA-CONVERSION OPERATIONS		
Card-to-Tape Conversion through Memory	19	
Tape-to-Card Conversion through Memory	22	
ARITHMETIC INSTRUCTIONS		
Addition: $A \pm B = T$	24	
Crossfooting: $A + B - C = T$	27	
Multiplication: $A \times B = P$	28	
Multiplication with Half Adjustment	30	
Shift Instructions	30	
Division: $A \div B = Q$	32	
Gross Pay Calculation	34	
DATA-TRANSMISSION OPERATIONS		
Memory-to-Memory Transmission, Five Characters	36	
Memory-to-Memory Transmission, Single Characters	38	
Transmission, Read while Writing	40	
Transmission via Storage Units; Sequence Checking	41a	
END-OF-FILE PROCEDURES		
Input-Output Indicators	45	
Control Instructions	47	
Balance Forward by Adding to Memory	49	
End of File, Read while Writing	53	
End of File, Transfer Any	55	
CHECKING PROCEDURES		
Check Indicators		56
Input Data Checks		57
Output Data Checks		58
Systems Checks		63
TABLE LOOK-UP		
Description		67
OTHER INSTRUCTIONS		
Record Arrangement for Printing		73
Tape-Controlled Carriage		75
Write and Erase Memory		80
Normalizing Accumulator and Auxiliary Storage		82
Program Switch		83
Digit Selection and Decoding		86
GROUPING RECORDS		
Description		91
OPERATING SPEEDS		
Description		95
MACHINE COMPONENTS		
Card Reader, Type 714		96
Card Punch, Type 722		101
Printer, Type 717		102
Typewriter		104
Magnetic Drum Storage Unit, Type 734		105
Magnetic Tape Unit, Type 727		106
Operator's Console		108
REFERENCE		
Operation Chart		115
Character Code Chart		116
Index		117

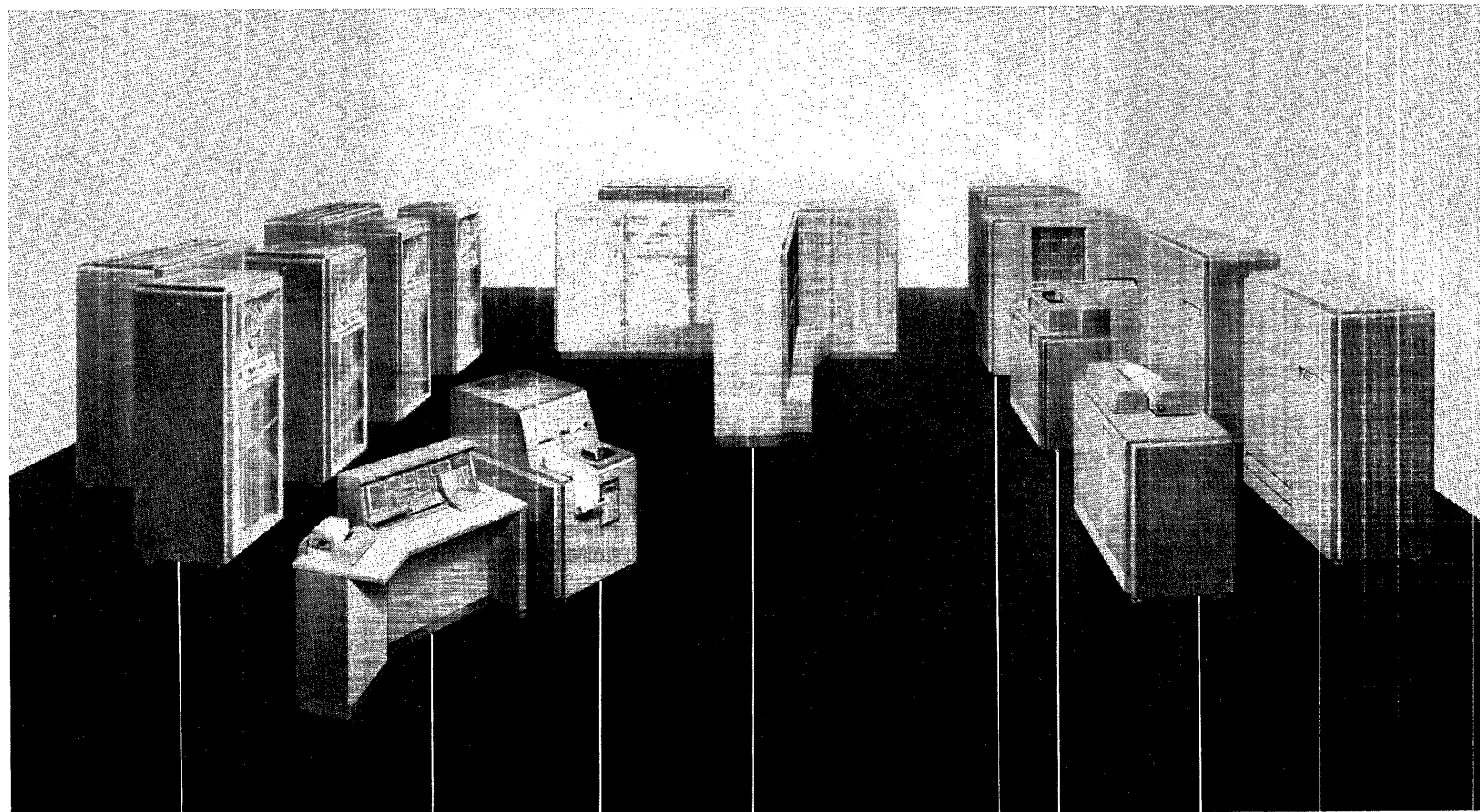

727 Magnetic Tape Units

Operator's Console

714 Card Reader

705 Central
Processing Unit

734 Magnetic Drum
Storage Unit

722 Card Punch

717 Printer

AN INSTALLATION OF IBM ELECTRONIC DATA-PROCESSING MACHINES
TYPE 705 AND ASSOCIATED EQUIPMENT

ELECTRONIC DATA-PROCESSING MACHINE

Type 705

THE VOLUME and complexity of modern record keeping is the growing concern of science, government, and industry everywhere. The control, processing, and evaluation of data are vital phases of every enterprise, no matter how large or small. Data processing needs are also widely diversified. They change not only with the size or type of organization but with the particular application as well.

The IBM Type 705 is a new concept in the field of data processing. Economical, accurate, and capable of operating at electronic speeds, the Type 705 is an integrated system of record reading and writing devices, interconnected through a central processing and control unit. Both IBM cards and magnetic tape can be fed into the system with results prepared on cards, tape, or printed reports.

All units are controlled through the highly flexible medium of the stored program. A program is a series of coded instructions, pertaining to a given problem, which may be placed in the magnetic core memory of the machine by the operator.

The interchangeability of the various record handling units provides still further flexibility of the machine. Transcription from cards to tape, tape to cards, or tape to printer can all be accomplished while other operations involving functions of the central processing unit are being carried on.

The 705 has been developed after intensive study of the requirements of IBM's customers. Its design is carefully planned, not only from an engineering and production point of view, but from the standpoint of the ultimate user as well.

The result is equipment which has been explored for a variety of applications. For example, the 705 can be applied to many present accounting routines. It can also effectively mechanize clerical operations which have previously been considered beyond the capabilities of other types of equipment.

STORAGE

A TOTAL of 40,000 characters can be stored within the main storage unit of the Type 705. Characters

may be letters of the alphabet, decimal numbers, or any of eleven punctuation marks or symbols used in report printing.

Characters may be stored in any sequence to form fields of various sizes. A group of related fields may in turn be combined in any convenient arrangement to form records. In a data-processing system, a record may be of any length within the capacity of the storage unit. Once stored in a specified location, the record is retained or "remembered" until a new record is inserted in the same location. A highly flexible system for addressing individual character positions in storage makes possible the rapid selection of any stored record, group of records, field, or individual character within a record.

Additional storage is provided by an accumulator storage unit of 256-character capacity and 15 auxiliary storage units with a total capacity of 256 characters. One or more magnetic drums are available as optional equipment with a capacity of 60,000 characters each.

Practically unlimited storage can be obtained on magnetic tape.

Core Memory

Extremely high-speed processing of information in or out of the main storage unit or "memory" is accomplished by the use of magnetic cores. Each core is a small doughnut-shaped ring of ferromagnetic material.

The cores can "remember" information indefinitely, and recall in a few millionths of a second. When a wire is inserted through the hollow center of the ring, a current passed along the wire will set up a magnetic field around the wire. This magnetizes the ring. When the current is removed, the ring remains magnetized. If the current is sent along the wire in the opposite direction, the magnetic field set up around the wire is reversed. If the current is again removed, the ring will again remain magnetized but its magnetic state will be opposite to that which remained after the first current was removed.

If the first magnetic state can be called positive, the second can be called negative. The positive state may be used to represent 1, the negative zero.

Figure 1A is a schematic of a core with current passing through two wires, one horizontal and one vertical, which magnetize the core in the positive state. Current passing through the two wires in the reverse direction causes the core to be magnetized in the negative (Figure 1B). In the 705, the positive core may be said to have a value of 1, and the negative core a value of 0. The sense wire is used to read the status of the core.

Figure 1C shows a 7-place core plane (matrix) illustrating the principle of core storage. The field 0000125+ is stored in binary coded form. Each vertical column in the matrix is made up of the seven rows of binary bits used in 705 character coding. (This coding system is explained in detail in the section on character coding.) All cores in a column are negative except those that make up the values stored in that column.

For example, the units digit 5 of the field is represented by a one in the 1 and 4 rows of the right-hand column. Two ones in the A and B rows of the same column represent the plus sign for the field. The tens digit 2 in the field is represented by a one in the 2 row of the second column. A one in the C row is used for checking purposes.

The coding of characters within the machine need not concern the operator or programmer during normal operation. Data are read by the input devices directly as punched in standard IBM cards or as recorded on tape. Results are obtained in the same direct manner without operator decoding from binary or other forms of notation.

The reading and interpretation of an instruction to locate information in memory is performed in .034 milliseconds (thousandths of a second) by a system of parallel character reading. Characters are read or stored at the rate of .017 milliseconds each. A record of 100 characters can, therefore, be located and transferred to accumulator storage from memory in 1.734 milliseconds, or in slightly more than 1.7 thousandths of a second. Similarly, rearrangement of data in memory can be accomplished by direct parallel transfer of data from one section to another, five characters at a time.

All data to be processed by the various components of the 705 must pass through core memory, except when the independent operations of transcription from cards to tape, tape to cards, and tape to printer are performed. Figure 2 shows the organization of data transmission. Figure 3 shows a typical magnetic core assembly.

Accumulator and Auxiliary Storage Units

The accumulator and auxiliary storage units are small magnetic core memories which store information temporarily from memory. Operations may then be performed on this information without changing the original field or record that remains in memory. The various operations are not actually performed by these units, however, but are executed in the arithmetic and logical unit (Figure 4).

Accumulator and auxiliary storage can rearrange data in memory. Fields, records, or any portion of either, can be taken from one location in memory to a storage unit and from there can be relocated in another part of memory to form any desired arrange-

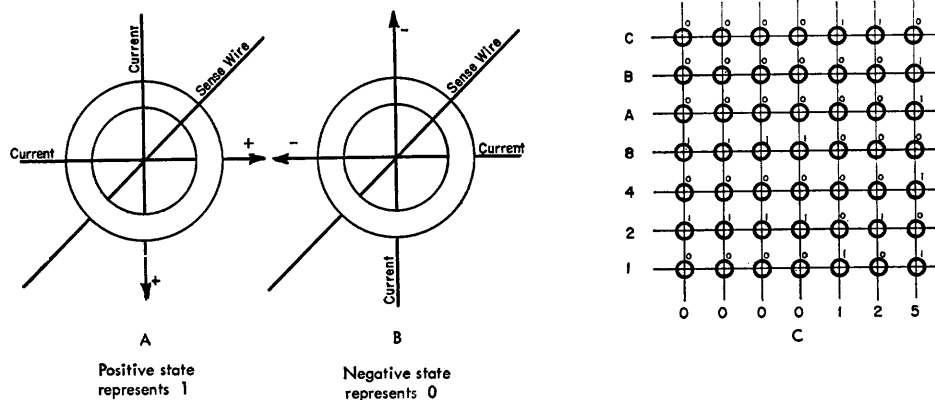

FIGURE 1. SCHEMATIC, MAGNETIC CORE STORAGE

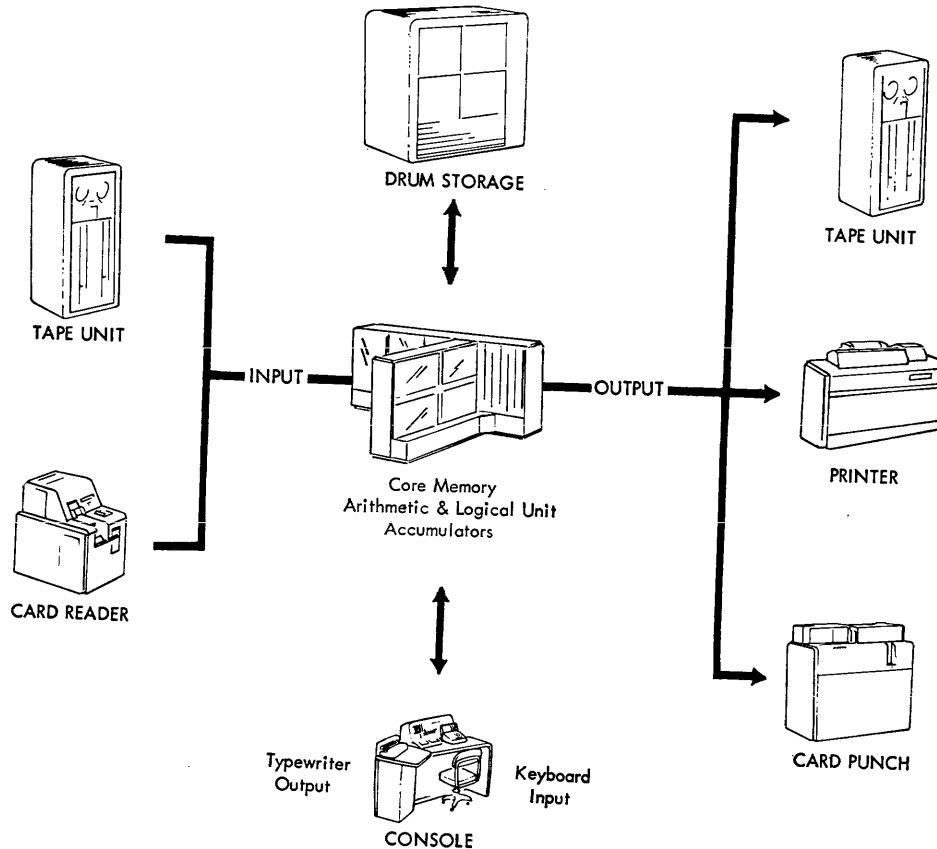

FIGURE 2. ORGANIZATION OF DATA TRANSMISSION

ment. Data cannot be transferred directly from one unit to another, but must first pass through memory.

A field in accumulator or auxiliary storage may also be compared against a field in memory. Comparison indicators register a high or equal condition resulting from this comparison (Figure 4). A low comparison is not registered, and one set of indicators serves the accumulator and all auxiliary storage units. The sequence of operations within a procedure may be varied, depending upon whether the factor in the particular storage unit is higher, lower, or equal to a specified factor in memory.

When arithmetic operations are performed, accumulator or auxiliary storage contains one of the two fields to be used in a calculation. The second field is in memory. To calculate $A + B = T$, the factor A is in a storage unit while B is in memory. After the operation of adding is completed in the arithmetic and logical unit, the result T replaces A in the storage unit. The result of the calculation always replaces the original field in the storage unit, with one excep-

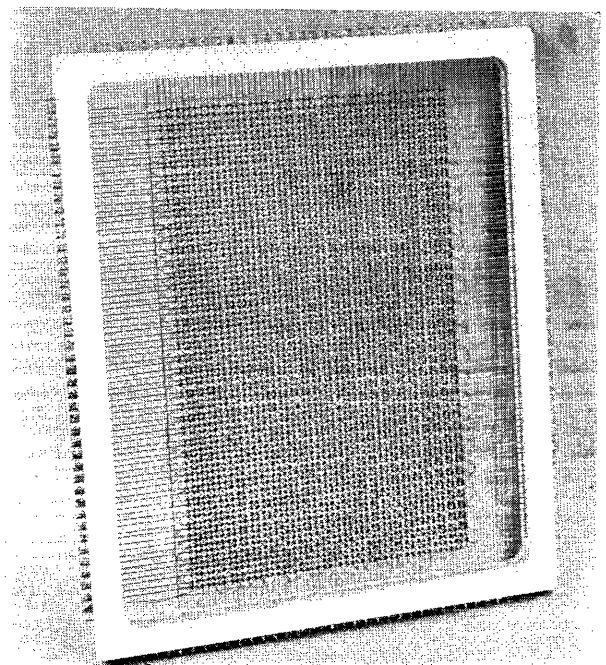

FIGURE 3. MAGNETIC CORE ASSEMBLY

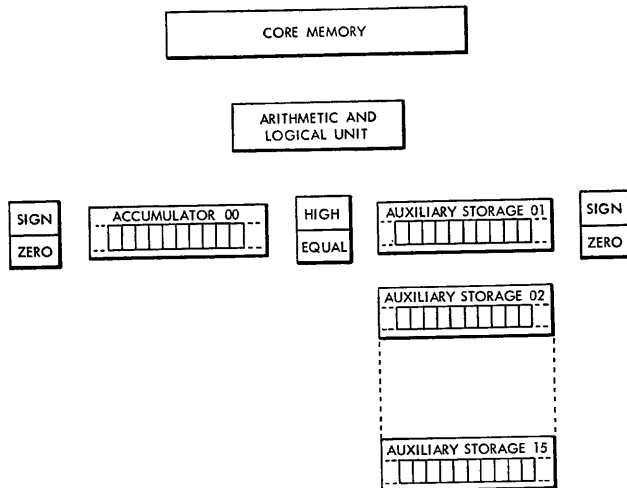

FIGURE 4. SCHEMATIC, STORAGE, MEMORY AND ALU

tion. A result may be added directly to a field in memory from a storage unit. In this instance, the result in the storage unit remains unchanged. (See "Add to Memory.")

Positive and negative fields are stored as true numbers in accumulator or auxiliary storage. Two sets of sign indicators register the sign of the fields; one set serves accumulator storage, the other set serves all auxiliary storage units. The sequence of operations within a procedure may be changed depending upon whether the sign of accumulator or auxiliary storage is plus or minus, or the result is zero.

One accumulator storage and fifteen auxiliary storage units are provided. The number 00 identifies the accumulator, with a capacity of 256 characters. The fifteen auxiliary units are identified by the numbers 01 through 15. Units 01-14 have a capacity of 16 characters each; unit 15 has a capacity of 32 characters.

A special character called a storage mark always occupies one position of accumulator and auxiliary storage. This character marks the left-hand limit of the storage contents. The mark automatically appears in the proper position next to the highest order character of the stored field. The mark is represented in text by the letter *a* and internally in the 705 by 0 00 0000. It is peculiar to these storage units and cannot appear in memory.

The starting point counter, containing the location of the right-hand character in the stored field, sets the right-hand limit to the field. All operations in-

volving a field in either accumulator or auxiliary storage, therefore, operate only on those characters located between the storage mark and the starting point counter.

The field in either accumulator or auxiliary storage can be shortened or extended to the left by shifting the storage mark. Only a field in accumulator storage can be shortened or extended to the right by shifting the starting point counter. The position of the starting point counter in auxiliary storage units is fixed.

The operations of multiplication and division are also restricted to accumulator storage and cannot be performed in auxiliary storage.

Accumulator storage 00 can be represented in the form of a circle with 255 available positions and a storage mark. In Figure 5, a field of six positions is marked off by the starting point counter and the storage mark.

Auxiliary storage units 1-15 can also be represented as being grouped to form a circle with the units arranged in sequence around the circle (Figure 6). A storage mark in each unit is automatically placed next to the highest order character of a stored field. By certain shift operations, coupling of auxiliary units enlarges capacity in one or more units up to the total capacity of the 256-position circle.

Arithmetic and Logical Unit

The arithmetic and logical unit contains an add-subtract unit, controls for effecting multiplication and division, controls for comparing the contents of accumulator and auxiliary storage with memory, and other circuits. These components do not store information, but instead merely operate on the characters as they pass through. Their function is to receive data from memory and operate on it in

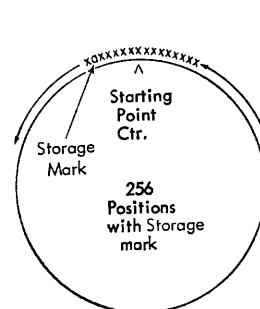

FIGURE 5. SCHEMATIC, ACCUMULATOR STORAGE

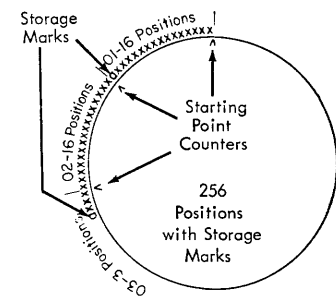

FIGURE 6. SCHEMATIC, AUXILIARY STORAGE UNITS

accordance with instructions obtained from the stored program. Results are always stored in accumulator storage, auxiliary storage, or in memory, depending upon the instruction.

Magnetic Drum

Magnetic drums provide additional storage capacity in the 705. Each drum is a metal cylinder, 10.7 inches in diameter and 12.5 inches in length, coated with a material which can be easily magnetized (Figure 7). Information is written on the cylindrical surface in the form of magnetized spots while the drum is rotating at high speed. This writing is placed along a number of parallel channels located side by side across the length of the drum. The drum is divided into 300 addressable sections and each section can store up to 200 characters.

The average time required to locate the first character position of a drum section during a reading or writing operation is 8.0 milliseconds. Thereafter, characters can be read from or written consecutively on the drum at the rate of .04 milliseconds per character.

From one to thirty drums are available with the 705, providing a possible total storage capacity of 1,800,000 characters. Drum recording is permanent. It remains after the power supply to the machine is turned off. Writing information on the drum erases information previously written in the same location.

The drum may be used for storage of program sub-

outines, intermediate results, rate tables, or other information.

Magnetic Tape

The 705 uses magnetic tape as the principal record and file storage medium. The tape is physically similar to the plastic tape used in sound recording devices. It is composed of a layer of magnetic oxide material coated on one surface of a plastic tape.

Light in weight (1 ounce per 100 feet), yet strong (8 pounds tensile strength), a full reel is 2400 feet long and 10½ inches in diameter. Lengths as short as 50 feet may be used. Tape is wound on a plastic reel weighing about 12 ounces (Figure 8).

Information is recorded in the form of magnetized spots as the tape moves at the rate of about 75 inches per second. Reading and backspacing speeds are the same. Characters are written at a density of 200 to the inch. The tape unit can be accelerated to proper reading or writing speeds in 1/100 of a second.

Magnetic tape may be used for repeated processing to reduce recording costs. Information is automatically erased before new information is written. The lightweight, compact, and durable quality of the tape provides ideal permanent record storage with further savings in space. One full reel of tape holds the equivalent of 25,000 eighty-column cards in unit records, or 60,000 cards when records are grouped in blocks of ten records per block (Figure 9).

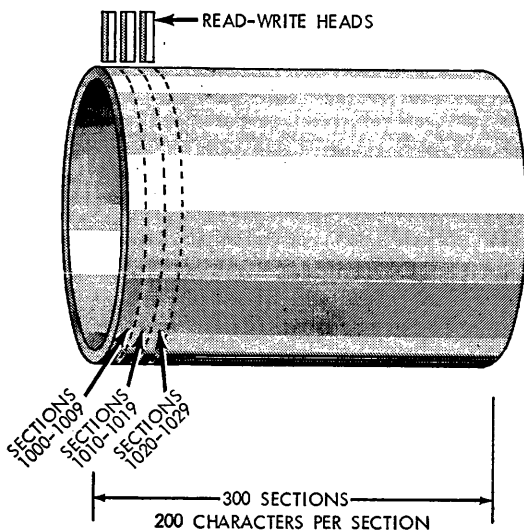

FIGURE 7. SCHEMATIC, MAGNETIC DRUM

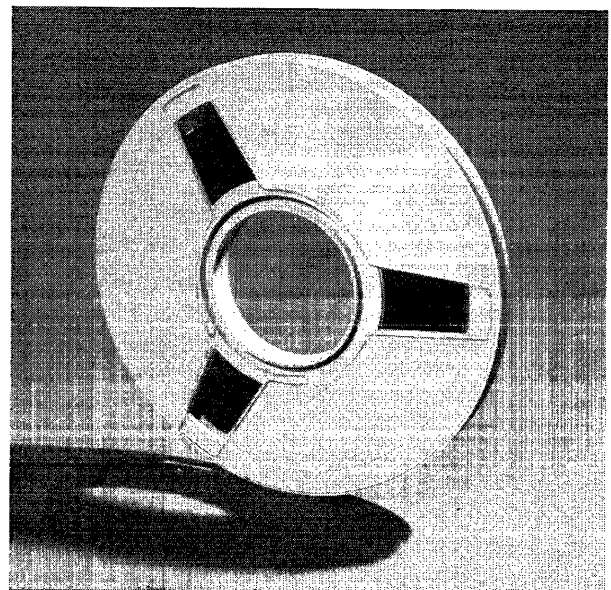

FIGURE 8. MAGNETIC TAPE AND REEL

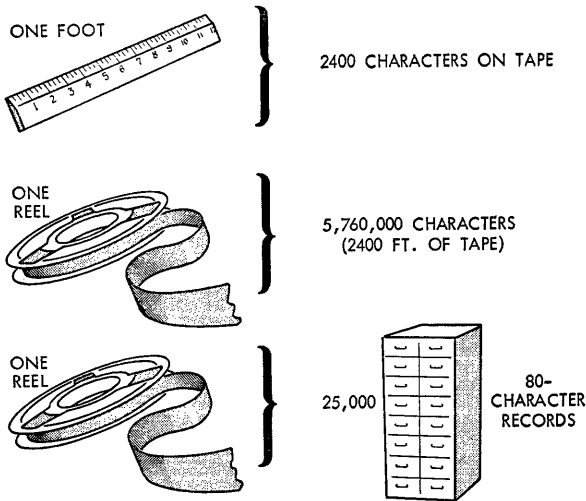

FIGURE 9. SCHEMATIC, MAGNETIC TAPE STORAGE

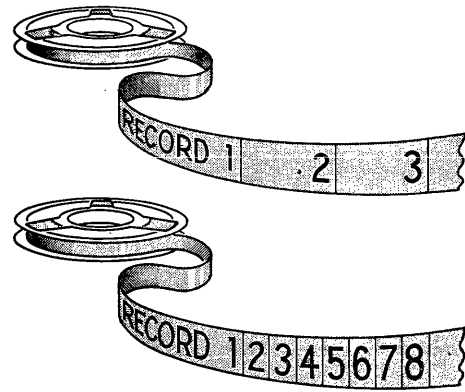

FIGURE 10. SCHEMATIC, VARIABLE RECORD LENGTH

Record length on tape is extremely flexible and can be of any practical length within the capacity of memory. A record may thus contain one or several thousand characters. Variable record length makes possible the recording of complete historical data about a person or product in one record (Figure 10). Records are separated on the tape by a 3/4 inch record gap. A record may also consist of a number of different fields and each field may vary in length.

Reels are rewound after reading or writing at an average rate of 500 inches per second, or an estimated 1.2 minutes for a full reel, allowing for acceleration and deceleration time. Reflective spots, placed on the tape by the operator at any desired point, are photo-

electrically sensed to indicate the physical end of the tape and the load point.

CHARACTER CODE SYSTEM

FIGURE 11 illustrates the coding system used for data recording on the IBM punched card. Punching takes place in two main areas, the lower numerical section and the upper zone section.

The numerical section is further divided into ten horizontal rows, one row for each digit 0-9. The zone section is divided into three horizontal rows, 0, 11, and 12. The zero row is common to both zone and numerical sections.

The card is divided into 80 vertical columns. A total of 80 characters may be punched in one card, each character occupying one of the 80 columns.

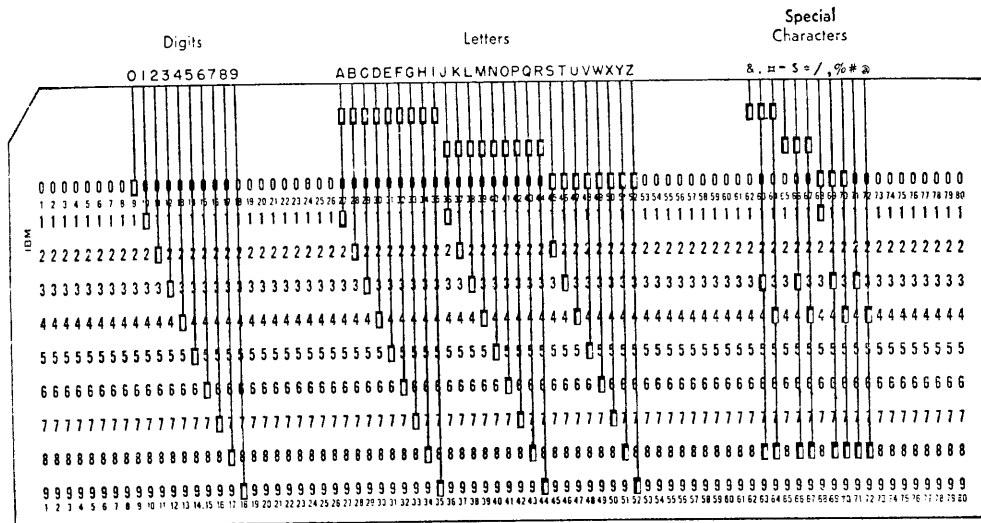

FIGURE 11. CHARACTER CODING, IBM CARD

When punched in their proper rows, holes can be automatically identified as characters by the 705 and other IBM accounting machines, the digits by single punches in the numerical section, and the letters of the alphabet and special characters by combinations of zone and digit punching.

The 12 zone with one of the digits 1 through 9 is recognized by IBM electric accounting machines as one of the letters A through I, the 11 zone with the digits 1 through 9 as J through R, and the 0 zone with the digits 2 through 9 as S through Z. Eleven special characters are recognized by the various combinations of zone and digit punches shown in Figure 11.

Figure 12 represents a section of magnetic tape with 705 character coding shown schematically. Actually, recording is not visible to the eye.

The tape is divided into three sections:

1. The zone section of two horizontal rows or "tracks," called A and B.
2. The numerical section of four tracks, each track with an assigned value of 8, 4, 2, or 1, respectively.
3. The checking section of one track, called C, used for checking purposes only.

Recording is accomplished by changing the state of magnetization of the oxide coating on the tape from positive to negative or from negative to positive. The change in magnetization represents a one; the lack of change represents a zero. The arrangement of these ones and zeros in combinations in the seven tracks forms digits, letters, and special characters.

Ones placed in the proper numerical tracks are used to represent digits. For example, the digit 6 is represented by placing a one in tracks 4 and 2,

thereby making the total value of the ones equal to 6. All other tracks are zero.

The same code structure used by electric accounting machines is also used by the 705 to represent letters and special characters. A one in both A and B tracks represents the 12 zone, a one in the B track with a zero in the A track represents the 11 zone, and a zero in the B track with a one in the A track represents the zero zone. A zero in both A and B tracks corresponds to no zoning on the card when only numerical rows are punched. The various combinations of ones in the zone and numerical tracks used to represent letters and special characters are also shown in Figure 12.

The check channel contains a one whenever the sum of the ones in the numerical and zoning portions of the character is odd, and a zero if the sum of the ones is even. The machine performs a character-code check on the transmission, reading, and recording of all data, to insure that each character has an even total number of ones including zone, numerical, and check positions.

The code system shown on tape in Figure 12 is used in all components of the 705, including memory, accumulator and auxiliary storage, and drum storage.

The conversion of the 705 code system to or from IBM card code is automatic whenever a card reader, printer, or punch is used.

INPUT-OUTPUT DEVICES

DATA can be entered into the 705 system from both IBM cards and magnetic tape. Results can be printed, punched into IBM cards, or written on magnetic tape, all in the same procedure. Any practical number of input or output devices—such as card readers, tape

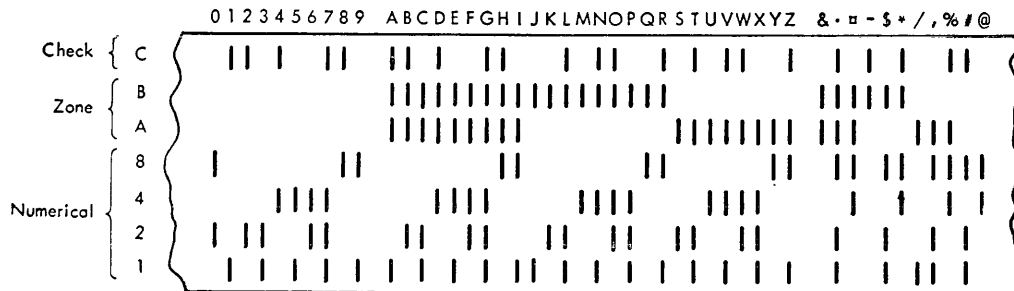

FIGURE 12. CHARACTER CODING, 705 EDPM

units, card punches, and printers—may be used for complete flexibility of entering data into the system and recording final results.

Input-output devices used in the 705 system for data processing may also be used in separate, independent operations of converting cards to tape, tape to cards, or tape to printed report. These operations do not require the central processing unit and can be performed as auxiliary functions of the system. As a result, the capacity of the 705 can be used entirely for data processing when relieved of routine transcription operations.

The machine handles both numerical and alphabetic characters and a variety of symbols with equal facility in reading, recording, or internal processing.

Card Reader

The IBM card is an important source document in the data-processing system. The 705 can further process punched cards prepared by other IBM accounting machines and record the results either on magnetic tape, other punched cards, or printed records.

For handling card input data, the 705 can be equipped with card readers which read cards into core memory at the rate of 250 cards per minute. The Type 714 Card Reader reads the standard IBM punched hole coding. Figure 13 is a schematic of the feed unit and card stations in the card reader.

Cards are first fed into a control or check station. A second station reads the cards into 92 positions of magnetic core record storage where each record is held until it is called for during a read operation. After the reading operation, the record is transmitted to 705 memory at high speed. Further instructions can be executed while a following card record is being transferred to record storage. Calculations made from one card record may be transmitted to other output units. These units may, in turn, begin writing results while record storage is being refilled from the next card.

Two checks insure accuracy of card reading. The transmission from record storage to memory, as read from the second read station, is compared against the reading at the first station. A character-code check is also made from record storage to memory. An error condition is indicated to the operator and may stop the machine or cause special corrective operations to be performed automatically.

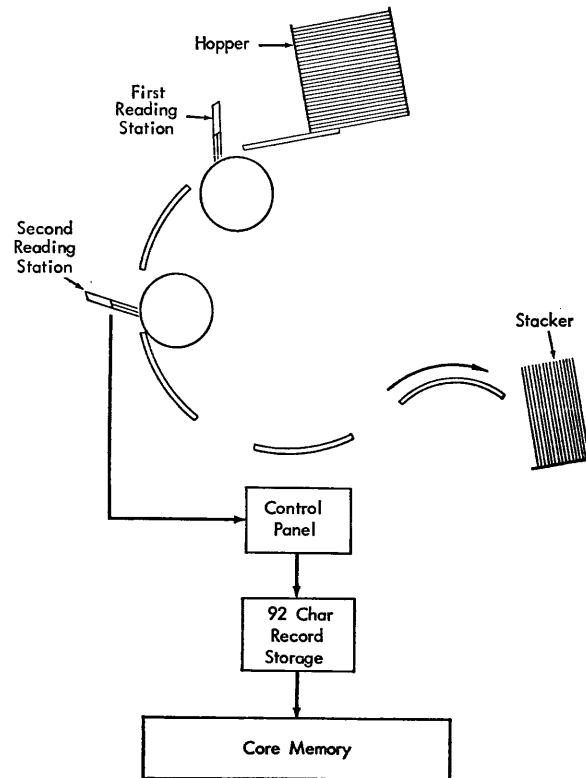

FIGURE 13. SCHEMATIC, CARD READER FEED

A control panel (Figure 14), provides additional flexibility in the card reader. Through the use of the control panel, a card record can be read into memory just as it is to be used by the 705. The following operations are possible:

1. Deletion of unnecessary card fields.
2. Rearrangement of card fields in any desired order.
3. Signing of fields.
4. Splitting of multiple punched columns to conform to 705 character coding.
5. Elimination of unwanted 11 and 12 punches.
6. Emitting of constant data.

A grouping feature permits the grouping of two card records in memory during a single read operation. The total capacity of record storage is 92 characters, allowing up to 46 characters to be read from any given card while grouping records. The same card columns must be used from the two card records.

The section "Machine Components" contains a detailed description of the switches, signal lights, control panel, and other operating features of the card reader. Each card reader requires a control unit

	1	2	3	4	5	6	7	8	9	10	11	12	13	14	15	16	17	18	19	20
A	1				5					10					15					20
B	21				25					30					35					40
C	41				45		FIRST			50		READ			55					60
D	61				65					70					75					80
E	1				5					10					15					20
F	21				25					30					35					40
G	41				45		CHECK			50		ENTRY			55					60
H	61				65					70					75					80
J	81				85					90		92								
K	TO CHECK ENTRY				GR SW				X-12										X-12	
L	X	DIG	RSM					0-9				COLUMN							0-9	
M	12	12	RM				COMMON					SPLITS							COMMON	
N																				
P							DIGIT SELECTORS													TO REC STOR ENTRY
Q	C	12	X	0	1	2	3	4	5	6	7	8	9		X	DIG	RSM			
R																12	12	RM		
S	1				5					10					15					20
T	21				25					30					35					40
U	41				45		SECOND			50		READ			55					60
V	61				65					70					75					80
W	1	COMMON			5					10					15	COMMON				20
X		1st CYCLE					ALTERNATORS									1st CYCLE				
Y		2nd CYCLE														2nd CYCLE				
Z	21	COMMON			25					30					35	COMMON				40
AA		1st CYCLE					ALTERNATORS									1st CYCLE				
AB		2nd CYCLE														2nd CYCLE				
AC	41	COMMON			45				X-12										X-12	
AD		1st CYCLE ALT							0-9			COLUMN							0-9	
AE		2nd CYCLE							COMMON			SPLITS							COMMON	
AF	1				5					10					15					20
AG	21				25					30					35					40
AH	41				45		RECORD STORAGE ENTRY			50					55					60
AJ	61				65					70					75					80
AK	81				85					90		92								

FIGURE 14. CARD READER CONTROL PANEL

containing the power supply and timing, decoding, and other circuits for reading cards into memory.

Tape Unit

The tape unit performs a reading or writing operation on magnetic tape. Figure 15 shows schematically the position of the tape reels in relation to the read-write heads and the feed rollers. A loop of tape is fed through vacuum columns on both sides of the read-write heads, to permit constant feeding speed without waiting for the reels to accelerate or decelerate when starting and stopping.

A proper read or write operation calls into use the tape unit, as well as other components of the 705.

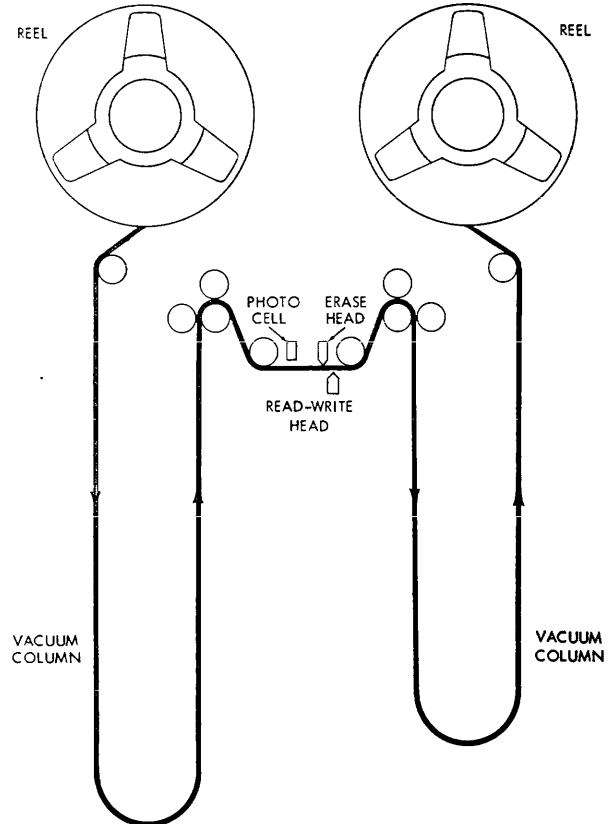

FIGURE 15. SCHEMATIC, TAPE UNIT FEED

A dial arrangement on the unit may assign a single tape unit to any one of ten different numbers (addresses).

Information read or written on tape is given a character-by-character code check. An error detected in reading a tape, for example, can cause one of two corrective measures. First, the machine can be stopped upon detecting an error. Second, the unit can be operated automatically to backspace the tape and reread the record with an excellent probability that the record will read accurately the second time.

A tape control unit contains certain common circuits to handle up to ten tape units. Each additional ten units require a separate control unit.

Two tape units may be used simultaneously for reading while writing. At the same time that a record or a group of records is read into memory from tape, another record or group of records may be written from memory onto tape. Two areas of memory must be set aside for this operation, one for reading in and the other for writing out.

The time to read and write a 200-character record is 23.40 milliseconds, including time to start the two

units. When a record read in is longer than a record read out, the machine automatically waits for the longer record before continuing operations.

The section "Machine Components" contains a detailed description of operating keys and signal lights.

Card Punch

The Type 722 punches cards as output records from 705 memory at the rate of 100 cards per minute. The record is first transmitted to 80 positions of magnetic core record storage at high speed. From there it is transferred to the card punch. The 705 may then continue operation while the card is being punched.

A record is sent to punch record storage in exactly the same arrangement in which it is stored in memory. The record may be arranged in memory to fit established card fields before it is punched. Figure 16 shows schematically the feed stations in the card punch.

Information transmitted to card punch record storage from memory is given a character code check. Card punching is read at a brush station and compared with the transmission from memory. An error is indicated to the operator. The machine may stop on error or it may take special corrective operations automatically, depending upon whether the error

occurred during punching or during transmission to record storage.

Each card punch requires a control unit containing the necessary decoding, checking and timing circuits. A detailed description of operating keys and lights on the card punch is contained in the section on machine components.

Printer

The 705 can be equipped with any practical number of printers for direct printed output from 705 memory. Each printer, a modified IBM Type 407, has 120 print wheels with 47 characters each (Figure 17). The maximum printing speed is 150 lines per minute.

During a writing operation which specifies a printer, the record is first transmitted to 120 positions of the printer record storage. From there it is printed as one line of characters while the 705 continues other operations. Calculations, or reading and writing with other input or output devices, may take place while a line is being printed.

Information within each line is printed in exactly the same order in which it is stored in memory. Any arrangement of data to fit report forms must be made in memory before the writing operation is performed.

An automatic form-feeding carriage controls form

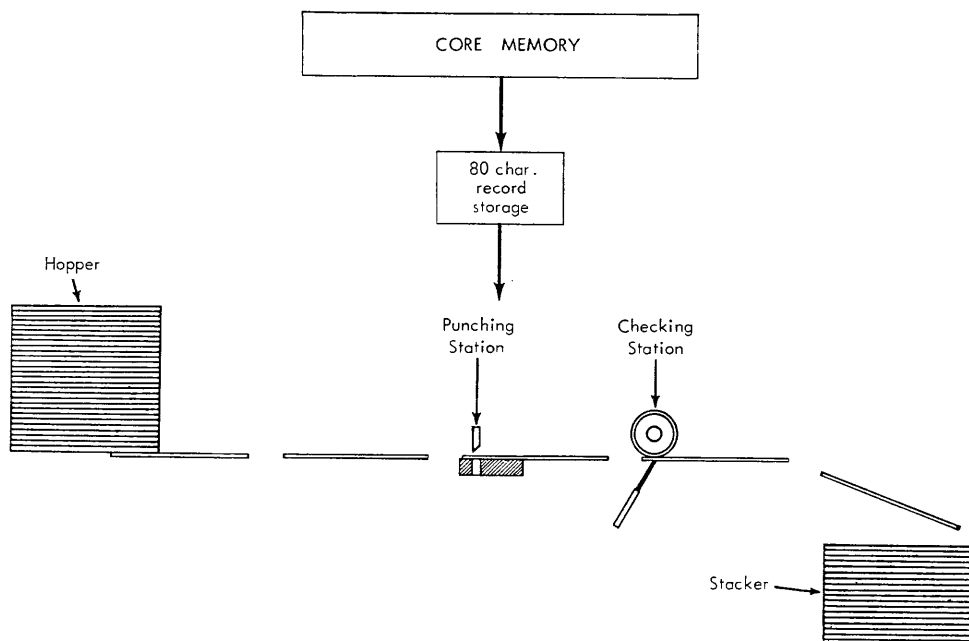

FIGURE 16. SCHEMATIC, CARD PUNCH FEED

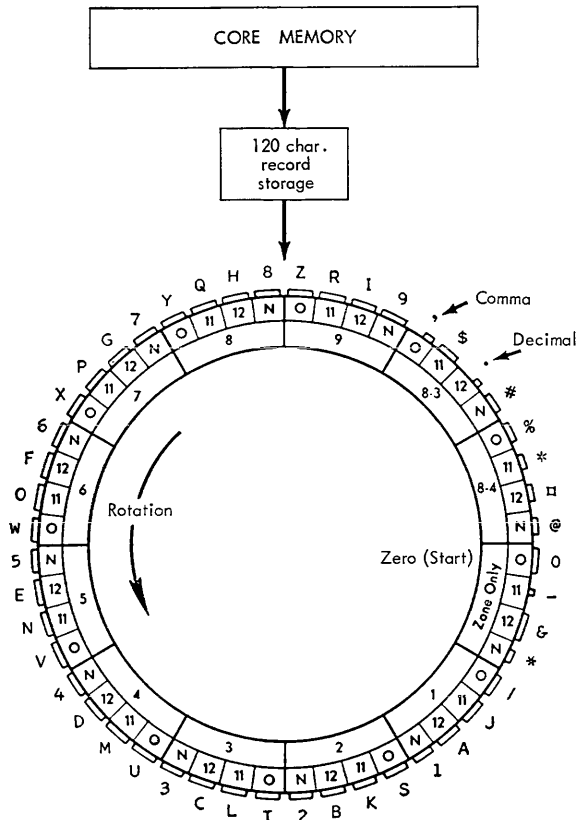

FIGURE 17. SCHEMATIC, PRINT WHEEL

spacing. Either the 705 or the carriage control switch on the printer controls operation of the carriage.

The accuracy of printing is checked in two ways. Information sent from memory to record storage is given a character-by-character code check. The position of the print wheels is sensed during the print cycle and compared with the record sent from memory. Either error condition is indicated to the operator and may stop the machine or cause special automatic corrective operations to be performed depending upon the type of error. Refer to the section "Machine Components" for a detailed description of operating devices associated with the printer.

Typewriter

A typewriter which is supplied with the 705 can print from memory, one character at a time, at about 600 characters per minute. The typewriter has no record storage unit and prints directly from memory. All other operations stop during the use of the typewriter (Figure 18).

Special conditions encountered during the course of a procedure such as end-of-file, exception records,

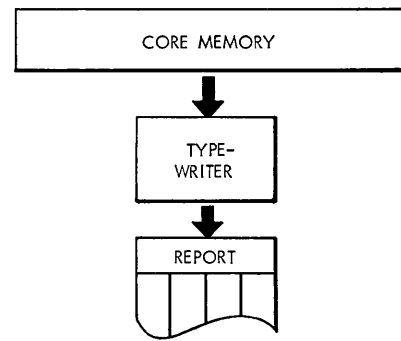

FIGURE 18. SCHEMATIC, TYPEWRITER AND MEMORY

and unmatched records, can be typed automatically for the operator. Accounting control totals, batch totals, or other control information can be supplied at predetermined intervals during a problem to aid over-all control of an application. Records can be arranged in memory before typing to fit report forms.

The contents of memory may be examined by using the typewriter, when the machine is under manual control. The typewriter unit is attached to the operator's console.

Operator's Console

The operator's console is a separate unit of the 705 (Figure 19). It provides a means of supervising all functions of the system. The console is used to:

1. Control the machine manually.
2. Indicate errors.
3. Determine the status of machine circuits, registers and counters.
4. Determine the contents of memory and accumulator storage.
5. Revise the contents of memory.

Four main types of controls are on the console:

Neon lights and indicators enable the operator to display at any given time the contents of memory, character by character, or to display a character being acted upon by accumulator or auxiliary storage units. In effect, the manipulation, calculation, or processing of data can be "seen" by the use of the neons.

Operating keys turn the power on or off; place the machine in automatic, manual, or display status; reset certain checking circuits; clear memory; and clear accumulator and auxiliary storage.

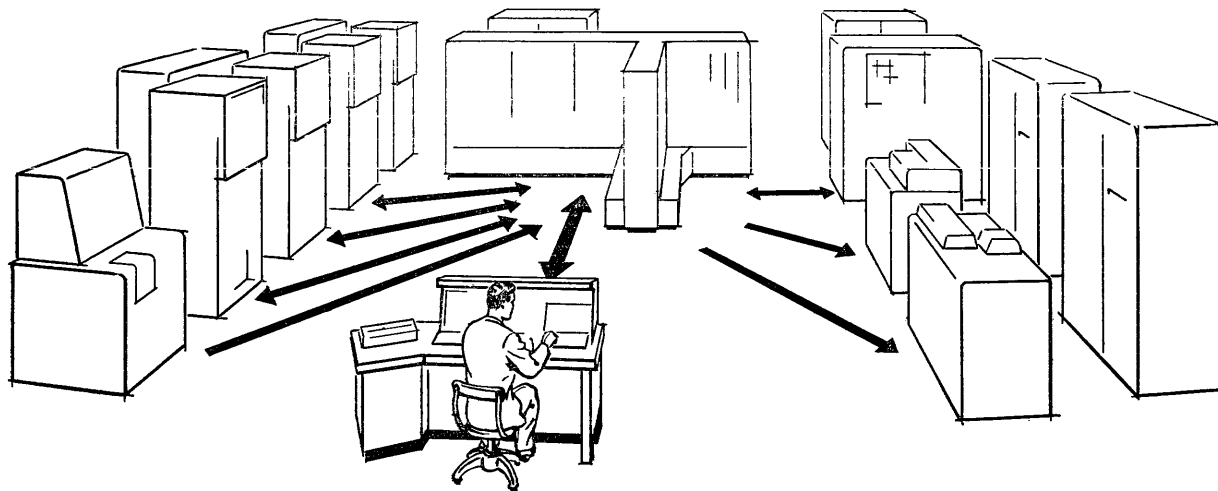

FIGURE 19. SCHEMATIC, OPERATOR'S CONSOLE

Checking switches provide the operator with an option either to stop the machine when an error condition is detected, or to continue the problem with automatic corrective operations, if possible.

Alteration switches are used to vary the sequence of machine operations according to predetermined plan.

The *keyboard* is used for manual entry of data directly into memory. Directions from the keyboard may also control machine operations.

Refer to the section "Machine Components" for detailed description of the various devices on the operator's console.

STORED PROGRAM

THE STORED program controls the completely flexible and automatic operation of the 705. A program is a series of coded operational steps arranged in a particular sequence. When stored in memory, the program can be interpreted by the machine, which can then work the problem or procedure accordingly. Each step of the program is referred to as an "instruction" to the machine and must include:

1. One of the various operations which can be performed, such as reading or adding.
2. An indication as to what component of the machine is involved in the operation, such as

the card reader, alteration switch, or indicator, or what factors in memory or accumulator or auxiliary storage units are to be operated upon.

In the central processing unit, these instructions are interpreted by electronic circuits, either in the sequence in which they are stored or in the sequence dictated by the instructions themselves.

Setting up a program for data processing usually requires several stages of preparation.

1. Analyze the procedure to break it down in terms of the basic steps performed by the 705. Arrange these steps in the combinations and sequences that produce the desired results. One method is to prepare a detailed procedure or flow chart.

2. Write these steps, to be performed by the machine in working the procedure, in the form of coded instructions in the corresponding combinations and sequences shown by the flow chart. This is the program.

3. Read the program into memory, either from punched cards or tape, by a loading procedure.

4. Store data necessary for working the procedure in memory during loading. Data may include constants, dates, tables, or other pertinent information.

5. Set the machine to the location of the first instruction in memory by depressing the reset key, by manual instruction, or by the loading procedure.

6. When started, the machine executes the first instruction and finds and executes succeeding instructions automatically.

Instruction

An instruction consists of two parts:

1. The *operation part*, which tells the machine what function to perform. A single character, either a letter or a number, designates each possible operation. See Operation Chart, Figure 121. To the machine, for example, the letter Y means READ, and the number 4 means COMPARE. The 705 can perform 36 separate operations, including reading, writing, comparing, arithmetic operations, and others.

2. The *address part*, which is either the memory location of data to be operated upon or the machine unit to be used. Each address consists of four characters.

Instructions may be stored on drum, tape, or cards, but at the time they are to be executed by the machine, they must be stored in memory (Figure 20). Each time an operation is performed, the machine looks up the instruction in memory, executes it, and then goes back to memory for the next instruction. Instructions are always executed in sequence according to their location in memory until this normal sequence is interrupted by a transfer instruction. By transfer operations, any instruction in memory can be selected, regardless of its position in the program.

The machine operates entirely without the use of control panels except when reading cards. The two parts of an instruction are scanned in a single character cycle by parallel read out. The cycle time to read and interpret an instruction from memory prior to execution is .034 milliseconds.

LOGICAL ABILITY

IT is important that the program is stored in memory in exactly the same manner as data. The only distinction between the two is the way in which they are interpreted by the machine. An instruction address, for example, may be treated arithmetically as data. The instruction operation part may be modified or even changed entirely by inserting a character code in the same way that fields or characters are manipulated in a record. One instruction can thus call for the modification of another instruction. It can direct the machine to compute a new address part or to substitute another operation part. Conversely, if for any reason data were entered in the

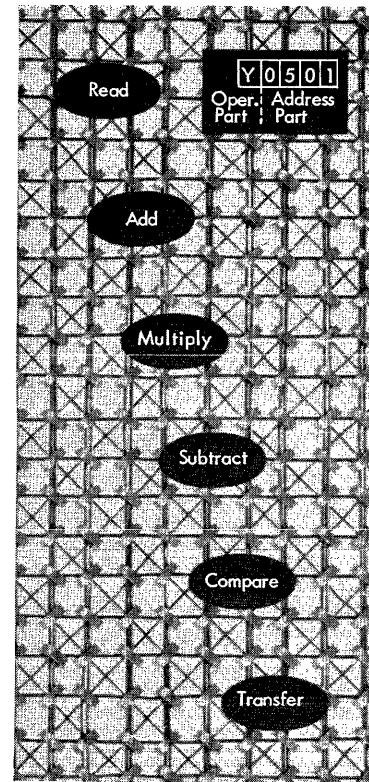

FIGURE 20. SCHEMATIC, INSTRUCTIONS IN CORE MEMORY

memory location of instructions, the data could be acted upon as an instruction.

A program arrangement may direct the machine to choose among several instructions, depending upon the results obtained in the course of the problem. Or, relocation of instructions in memory may change the sequence of steps within the program. These characteristics give the machine the ability to cope automatically with special circumstances encountered in a procedure (Figure 21). Logical ability of the 705 allows it do clerical work previously considered too complex for machine methods. The stored program concept can be applied to a wide variety of clerical functions—table look-up, analysis, distribution, filing, and many others.

Address System

Each one of the 40,000 positions in memory is numbered from 0000 to 39,999. This serial number of a memory position is known as its address.

The address part of an instruction must consist of only four characters. To indicate the upper 30,000

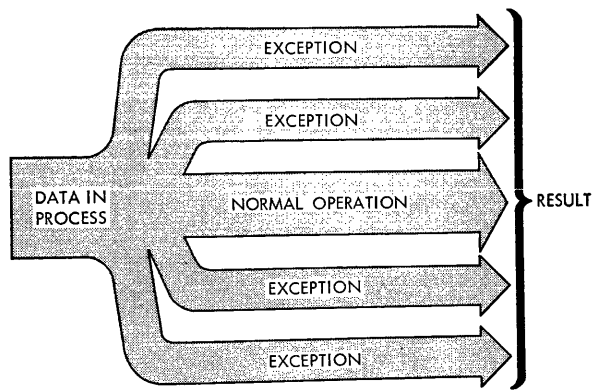

FIGURE 21. EXCEPTION PROCESSING

positions of memory (actually a five-character address), a zero zone is placed over the high order position of the address to indicate memory positions 10,000 through 19,999, a minus zone to indicate positions 20,000 through 29,999, and a plus zone for positions 30,000 through 39,999. When an instruction is placed in memory which specifies such an address, the zone is interpreted by the machine as referring to the upper 20,000 positions of memory. The absence of the zone indicates to the machine that the address specifies the lower section of memory, locations 0000 through 9999.

For convenience in writing the program, the addresses of memory locations between 10000 and 19999 are written with a dash over the high-order position. Addresses in the text written $\bar{0}000$ through $\bar{9}999$, therefore, refer to the upper 10,000 positions of memory; those written 0000 through 9999 refer to the lower 10,000 positions. Addresses which refer to the upper 20,000 positions are not shown.

Each stored character occupies one position of memory. The location of any information in memory can be specified exactly by the address of the memory positions where it is stored. Since all memory positions are addressable, data need not be handled in uniform lengths of blocks or words. Records can be of variable lengths within the same procedure.

All components of the machine, as well as individual positions of memory, have addresses so that

they may be called upon by the operation part of an instruction. The following addresses are assigned.

ADDRESS	COMPONENTS
0000-9999	First 10,000 positions of memory
$\bar{0}000\text{-}\bar{9}999$	Second 10,000 positions of memory
0100-0199	Card readers
0200-0299	Tape units
0300-0399	Card punches
0400-0499	Printers
0500	Typewriter
1000-9999	Drum sections
0911-0919	Alteration switches
0900	Instruction check indicator
0901	Machine check indicator
0902	Read-write check indicator
0903	Printer-punch check indicator
0904	Overflow check indicator
0905	Sign check indicator

Symbolic Programming

When a program is stored in memory, each instruction is placed in five particular positions of memory. This position of the instruction is its memory location. Normally, the series of instructions is arranged in adjacent ascending locations of memory, five positions of memory to each instruction. The programmer must assign the memory location of instructions and must reserve additional memory space for data, records, constants, and so on.

All examples of programs in this manual are shown with actual assigned positions of memory. Several systems have been devised to enable the programmer to simply number instructions in sequence without regard to actual location. This is called "symbolic programming." By special processing on punched cards, a program so written can be converted to actual memory location on EAM equipment, 650 MDDPM, or on the 705 itself. Information about these program "assembly" methods is available in *Program Brief 4* and *6*. Additional information will be published as new systems are developed.

DATA-CONVERSION OPERATIONS

A DATA-processing procedure may use many or all of the various operations which the machine can perform. This section explains those operations pertaining to converting records from cards to tape, from tape to cards, and from tape to printer. Normally, these simple procedures are independent, auxiliary operations that do not use memory or the arithmetic and logical units of the machine. This is particularly true if no calculation, sorting, or re-arrangement of records is involved.

However, for illustrating and explaining the basic principles of the stored program, the data conversions programmed in this section are done through memory. Assume that usually the conversion would be a part of more complex procedures involving other instructions to be explained in later sections.

It should also be clearly understood that the following examples are not intended to be primary applications of an installation. They are offered only as illustrations of basic principles of operation. For example, end-of-file routines, checking procedures, and error correction are omitted from the introductory problems. The problems are presented in the sequence best suited for learning machine principles, and not in order of their importance.

CARD-TO-TAPE CONVERSION THROUGH MEMORY

FIGURE 22 illustrates the flow of information for processing data from cards to magnetic tape. The procedure, when first reduced to basic machine steps, requires five instructions described as follows:

1. Select a card reader.
2. Read a card record from this selected unit into memory.
3. Select a tape unit.
4. Write the record from memory on tape, using the previously selected unit.
5. Transfer to the first operation and repeat the program until all cards are processed.

The programmed instructions select two machine units, a card reader and a tape unit. Two operations

are performed, reading the card record and writing on tape. The transfer operation is inserted to "loop" the program until all card records are processed.

Each of the above steps instructs the machine. As previously stated, an instruction consists of both an operation part and address part. The select operation (step 1) must, therefore, specify the address of the unit to be used, in this case, card reader 0100.

Each character of the card record wired on the control panel to record storage must occupy one position of memory. The address part of the instruction specifies the memory position that stores the first character of the record. In step 2 this is address 1201 (Figure 22).

A *record storage mark* is normally wired on the control panel into the position of record storage

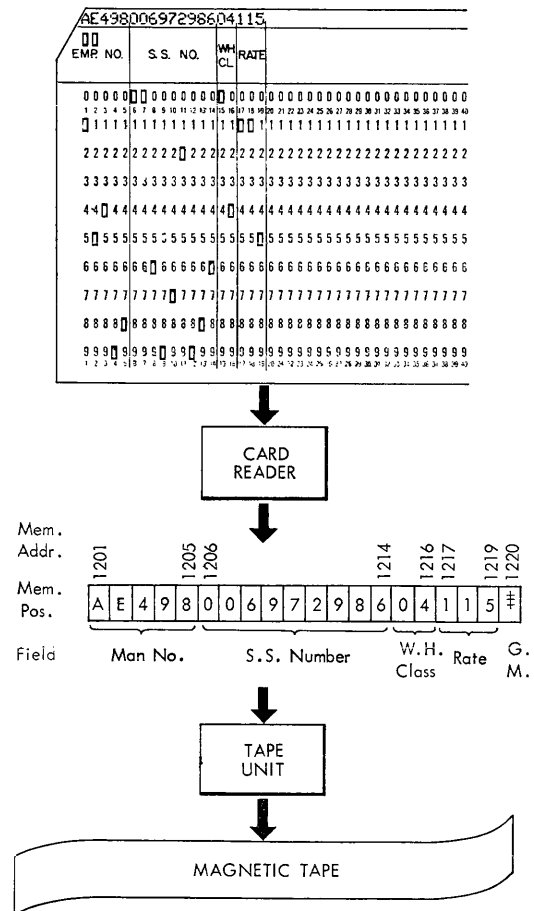

FIGURE 22. DATA CONVERSION, CARD TO TAPE

immediately following the last significant character of the card record. The mark then limits the length of the record read into memory. For example, if the card record is 19 columns long, the record storage mark can be wired into the 20th position of record storage. Only 19 columns of the card are read into memory, rather than all 80 columns including 61 blank columns. This feature also applies to auxiliary card-to-tape operation.

A special character, called a group mark, may be wired on the control panel to mark the end of records in memory for a write instruction. In the text, the symbol # indicates a group mark. The card code punches for the group mark are 12-8-5. This code may be a part of the card record or it may be originated from the control panel when needed.

To read a group mark into position 1220 in Figure 22, the record storage mark is wired into position 21 and the group mark is emitted into position 20. In this way the length of the record is properly defined in memory.

Step 3 specifies, by the address part of the instruction, which unit is to be used for writing. The address of the tape unit is 0200.

Step 4 indicates the location in memory of the first character of the record to be written by the last selected unit.

Step 5 specifies, by the address part, the location in memory of the next instruction to be executed.

The program, with abbreviated operations and proper addresses, is shown in Figure 23.

To be executed by the machine, the program must be stored in memory. The mnemonic instruction abbreviations are used merely for convenience in writing the program; they *are not stored in memory*. The operation code of one character and its related address make up five characters for each instruction. When stored in memory, beginning at address 0000, the program would appear as in Figure 24.

The address of an instruction is considered to be

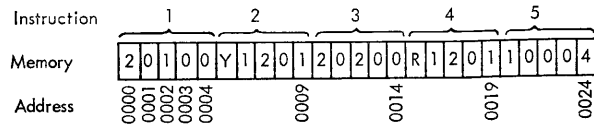

FIGURE 24. PROGRAM, CARD TO TAPE IN MEMORY

the memory location of the right-hand digit of the address part. Because the 705 can scan the five positions of an instruction in a single cycle, instructions must be located in a specific manner in memory. Programs are stored so that each instruction makes a five-character memory group. The left-hand character of any group must be located in a memory position with an address ending in 0 or 5. Therefore, the location of the right-hand digit of the instruction address part must be stored at a memory position with an address ending in 4 or 9. In Figure 24, the address of instruction 1 is 0004, instruction 2 is 0009, and so on.

The transfer instruction may now be given the address of the memory location of the first instruction. The machine transfers to memory location 0004 and executes the instruction it finds there. The completed program for converting cards to tape may now be written, as shown in Figure 25.

The following sections explain each machine operation used in the above program.

Select (2—SEL)

The various units of the machine are called into use during a program by preceding the address part of the instruction by a select operation part. In this way, the machine differentiates between a memory address and the address of a component. The address 0100, for example, when preceded by an *add* operation part, instructs the machine to add data stored at memory location 0100. When the address is preceded by a *select* operation part, the instruction refers to card reader 0100.

Instruction		Description
Operation	Address	
SEL	0100	Card reader
RD	1201	Memory address
SEL	0200	Tape unit
WR	1201	Memory address
TR		Repeat program

FIGURE 23. PROGRAM, CARD TO TAPE

Instruction Location	Instruction		
	Operation Abbrev.	Operation Code	Address
0004	SEL	2	0100
0009	RD	Y	1201
0014	SEL	2	0200
0019	WR	R	1201
0024	TR	1	0004

FIGURE 25. PROGRAM, CARD TO TAPE

Only one unit can be selected at a time and the selected device remains selected until another select instruction is given.

Read (Y—RD)

1. The read instruction is used to store a record in core memory from an input unit or a drum. Records are read from record storage when using a card reader; they are read directly from a tape unit or drum section. A select instruction is first given to specify the unit to be used for reading.

2. Information is read into memory successively from left to right, starting at the memory address specified by the address part of the read instruction. For example, when reading a card, the instruction READ 1201 (Figure 25) reads the first character from record storage into memory position 1201, the second into position 1202, the third into 1203, and so on. Sensing the record storage mark wired from the control panel terminates the read operation from cards. If no record storage mark is wired, all 92 positions of record storage are read into core memory. Unwired positions or blank columns of the card are converted to blank characters in memory.

3. All characters, including blank characters, of the unit record or group of records, are read into memory by the read instruction. The first character of the tape record is stored in the memory position specified by the address part of the instruction, the second character in the next higher address, and so on. The reading operation from tape is terminated by sensing the inter-record gap.

4. In drum reading, the first character stored in the drum section (specified by the address part of the select instruction) is stored in the memory position specified by the read instruction. Sensing the drum mark terminates reading from the drum.

Write 00 (R—WR)

1. The write instruction transmits a record from memory to the record storage unit of the card punch or printer. From there it is punched in a card or printed on a report form. Records from memory are transmitted directly to the tape unit to be used for writing, to the drum section to be used for storage, or to the typewriter. The write instruction does not affect the record in memory.

2. Information is written from memory successively from left to right, starting at the memory position specified by the address part of the instruction and continuing until a group mark is reached. Accumulator 00 is specified to indicate that information written is limited by the group mark.

For example, when writing on tape, the instruction WR 00 1201 (Figure 25) places the character stored in memory position 1201 on the tape as the first character of the record, position 1202 as the second character, 1203 as the third, and so on until the group mark is sensed. The group mark in memory stops the writing operation and a record gap is automatically spaced on the tape.

When cards are being punched, the character stored in the memory position specified by the address part of the write instruction is punched in column 1. The second character from memory is punched in column 2, the third in column 3, and so on until the group mark is reached. If the length of the record is less than 80 columns, the remaining columns in the card remain unpunched. Records longer than 80 characters are punched in successive cards by a single write instruction. The write status is maintained and subsequent operations are delayed until the last block of records has been read into record storage. The 81st character of the record in memory is punched in column 1 of the second card.

On the printer, the first character of the record specified in memory is printed by print wheel 1, the second by print wheel 2, and so on until 120 characters have been written. If the length of the record is less than 120 characters, the remaining print wheels do not print. Records longer than 120 characters are printed on successive lines by a single write instruction. The write status is maintained and subsequent operations are delayed until the last block of characters has been read into record storage.

Note: The carriage switch on the printer may be set to PROGRAM. In this case, the first character of the record stored in memory is used for skipping and space control. The section "Machine Components" explains this procedure more fully.

Rearrangement of record fields for writing is discussed under the store-for-print instruction and in later program examples.

When writing on the drum, the group mark in memory is converted to a drum mark at the end of the record.

3. No write operation will result if the write instruction is addressed to the memory address of a group mark. The machine will proceed to the next instruction.

Write 01 (R—WR)

The rules for WR 00 also apply to WR 01 with the following differences:

1. Information is written from left to right, starting at the memory position specified by the address of the instruction and continues until memory position 19999 is reached. This position of memory is not written but it causes the proper end of record device (drum mark, inter-record gap) to be recorded.

2. Record marks or group marks have no effect upon the execution of the instruction. They are written out on the selected unit with all other characters.

The WR 01 instruction is useful for writing out or “dumping” the complete contents of memory in check-point routines. It can also be used to examine memory beginning at any address while checking out or changing a program.

Transfer (I—TR)

The transfer instruction is used to change the sequence in which instructions of a program are executed. The address part of the instruction specifies the memory address of the right-hand digit of the next instruction to be executed.

1. Select a tape unit.
2. Read a record from tape into memory.
3. Select a card punch.
4. Punch the record from memory into a card.
5. Transfer to repeat the instructions until all records are processed.

For this problem, assume that a group mark has been previously placed in memory location 17028.

Figure 27 shows the program steps. Memory addresses are assigned to each instruction.

0004. Select tape unit 0200.

0009. Read a unit record from the tape into memory, beginning at address 17001. Continue to read

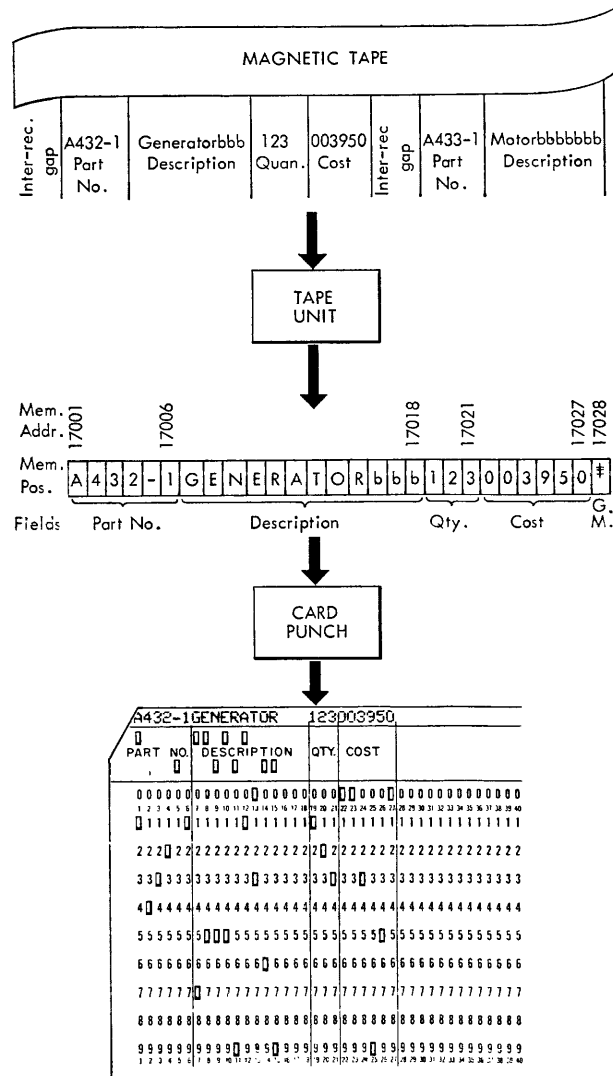

FIGURE 26. DATA CONVERSION, TAPE TO CARD

TAPE-TO-CARD CONVERSION THROUGH MEMORY

THE 705 can process information stored on magnetic tapes as input data and punch the results in IBM cards. IBM accounting machines may further process cards prepared by the card punch. Figure 26 shows the flow of data from the tape through memory to the card punch.

Program, Tape-to-Card

The program for tape-to-card conversion is also reduced to sequential steps conforming to the various 705 operations, as follows:

Instruction Location	Instruction		Address
	Operation Abbrev.	Operation Part	
0004	SEL	2	0200
0009	RD	Y	7001
0014	SEL	2	0300
0019	WR	R	7001
0024	TR	1	0004

FIGURE 27. PROGRAM, TAPE TO CARD

the tape into successively higher memory positions until the inter-record gap is reached.

0014. Select card punch 0300.

0019. Write the record stored in memory beginning with address 17001 and continue to write out successively higher-order memory positions until the group mark is reached. Punch a card.

0024. Transfer to the instruction located at memory address 0004 and repeat the program until all records are processed.

Program, Tape-to-Card and Printer

Information from tape can be punched in cards and also written on the printer during the same procedure by the program shown in Figure 27, with two additional instructions as follows: (1) a select instruction to select the printer and (2) a write instruction to transmit the record from memory to the printer. Figure 28 shows the complete program, with assigned memory locations for each instruction.

Instruction Location	Instruction		Address
	Operation Abbrev.	Operation Part	
0004	SEL	2	0200
0009	RD	Y	7001
0014	SEL	2	0300
0019	WR	R	7001
0024	SEL	2	0400
0029	WR	R	7001
0034	TR	1	0004

FIGURE 28. PROGRAM, TAPE TO CARD AND PRINTER

ARITHMETIC INSTRUCTIONS

THE 705 adds, subtracts, multiplies, and divides when given arithmetic instructions. These instructions can be applied to data stored in accumulator storage, auxiliary storage (except multiply and divide) or in memory. They are normally applied to specific numerical factors or fields, such as factors developed during calculation or fields selected from records.

To select a field from memory to be acted upon by an arithmetic instruction, the field is always addressed by the memory location of its units digit. The remaining digits of the field are automatically read from right to left until a non-numerical character is reached. All characters, including blanks, are considered non-numerical, except the digits 0-9. Thus, a numerical field in memory is defined as beginning with the address of its units digit and extending to, but not including, the next left non-numerical character.

Field A in Figure 29 is defined by an arithmetic instruction as containing the digits stored in the addresses 7005 through 7001, while field B contains the digits in addresses 7012 through 7006. The addresses of fields A and B are 7005 and 7012, respectively.

Arithmetic instructions should always be addressed to "signed" fields. Both positive and negative fields in memory should be signed. Numerical fields are signed by placing a plus or minus sign indication over the units digit of the field. On the 705, the equivalent of the 12 zone in punched cards (one, one) indicates the plus sign, and the X zone (one, zero) the minus sign. The sign indication actually converts a numerical digit to a non-numerical character in the same manner that an X or 12 punch over a digit punch in IBM cards forms a letter of the alphabet.

The absence of a zone or the presence of a zero zone does not satisfy the requirements for a signed field. When an unsigned field is addressed by an arithmetic instruction, the sign is interpreted as plus. The correct arithmetic is performed but the machine indicates an error condition. (Refer to "Sign Check Indicator.")

ADDITION: $A \pm B = T$

FOUR machine operations permit the addition or subtraction of factors from memory in accumulator or auxiliary storage. They are reset and add, add, reset and subtract, and subtract. The store instruction is used to place the results of calculations in memory properly signed and defined by non-numerical characters.

Zone coding over the hundreds and tens position of an arithmetic instruction address designates either accumulator storage or any particular auxiliary storage unit. Figure 30 tabulates the codes for the accumulator and all auxiliary storage units. To simplify program writing, a column on the program sheet is reserved for the number of the storage unit to be used (00 for the accumulator, 01-15 for auxiliary storage). It is assumed that the zone coding is

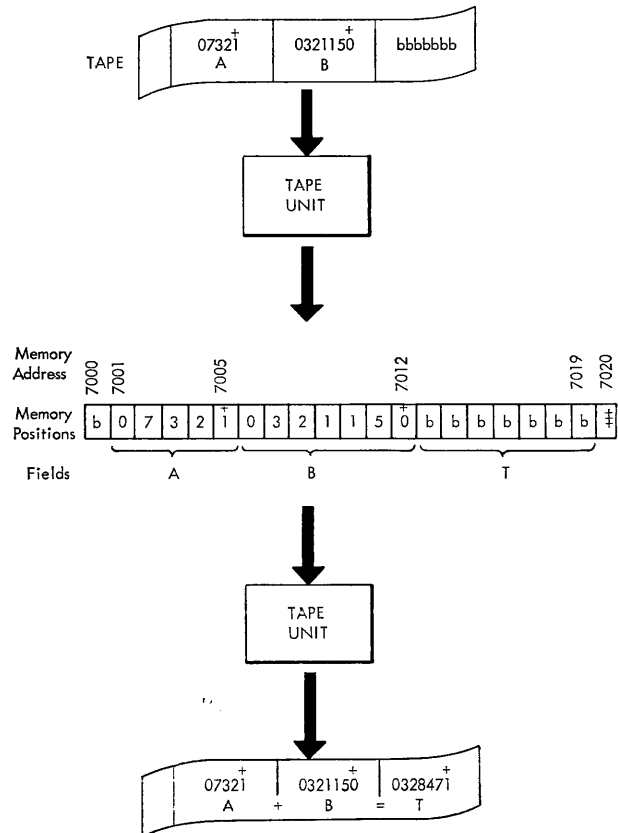

FIGURE 29. $A + B = T$

Acc. or Aux. Storage		Address			
Number	No. of Positions	Thousands	Hundreds	Tens	Units
00	256		00	00	
01	16		00	01	
02	16		00	10	
03	16		00	11	
04	16		01	00	
05	16		01	01	
06	16		01	10	
07	16		01	11	
08	16		10	00	
09	16		10	01	
10	16		10	10	
11	16		10	11	
12	16		11	00	
13	16		11	01	
14	16		11	10	
15	32		11	11	

00 indicates no zone; 01 indicates zero zone;
10 indicates X zone; 11 indicates 12 zone

FIGURE 30. ACCUMULATOR AND AUXILIARY STORAGE TABLE

given to the necessary addresses before the program is placed in memory.

Reset and Add (H—RAD)

1. The reset and add instruction enters a numerical field from memory into accumulator or auxiliary storage. The address part of the instruction specifies the location of the field and the storage unit to be used.

Digits are entered into storage starting with the specified right-hand digit of the memory field and continuing from *right* to *left* until a non-numerical character is sensed. This non-numerical character is not entered into storage. The zoning of the addressed digit of the memory field is removed before this digit is entered into storage.

2. The accumulator or auxiliary storage sign is set to plus when the addressed memory character has plus zoning and is set to minus when the character has minus zoning. If the addressed character has neither plus nor minus zoning, an error is indicated and the sign of the field is interpreted as plus. (Refer to "Sign Check Indicator.") The sign is always set to plus when the result in storage is zero.

3. The left-hand limit of the storage field is automatically set by a storage mark (*a*) stored next to the last digit entered from memory.

The field A (Figure 29), when placed in storage by the reset and add instruction, would appear as *a07321*.

When the memory field exceeds the capacity of an auxiliary storage unit, the field automatically extends into the adjacent unit with proper positioning of the storage mark in this unit (Figure 6).

4. The reset and add instruction does not affect the field in memory.

5. Special Case: When the numerical portion of the character addressed by the instruction is 0000 (& — blank), the character is entered into storage as a zero (0 00 1010). The accumulator or auxiliary storage sign and the sign check indicator are set according to the rules stated above.

EXAMPLES, RESET AND ADD

MEMORY	STORAGE BEFORE		STORAGE AFTER		SIGN CHECK
	STORAGE	SIGN	STORAGE	SIGN	IND.
$\overline{4456}$ ₊	a23456	+	a456	—	
$\overline{4456}$ ₋	a23456	—	a456	+	
$\overline{4b56}$ ₊	a1234	+	a56	+	
$\overline{4456}$ ₊	a1234	—	a456	+	ON
$\overline{E456}$ ₊	a2345	+	a456	—	
$\overline{T000}$ ₊	a1111	+	a000	+	See note
$\overline{4bbb}$ ₊	a111	+	a0	+	ON
ST	a4567	+	a3	+	ON

Note: Because the resulting field is zero, the sign is set to PLUS.

Add (G—ADD)

1. The add instruction adds a numerical field in memory to a factor in accumulator or auxiliary storage. The address part of the instruction specifies the location of the field and the storage unit to be used.

Digits are added into storage starting with the specified right-hand digit of the memory field and continuing from right to left until a non-numerical character is sensed. This non-numerical character is not added into storage.

2. The result in the storage unit is the sum of the storage factor and the specified memory field. The result replaces the original storage factor.

3. The accumulator or auxiliary storage sign is set according to the rules of algebra for addition. When the addressed character has neither plus nor minus zoning, an error is indicated and the sign of the field is interpreted as plus. (Refer to "Sign Check Indi-

cator.”) The sign is always set to plus when the result in storage is zero.

4. The left-hand limit of the result is automatically set by a storage mark which is stored next to the highest order digit. The length of the result is equal to the longer of the two fields being added, unless a carry is made out of the high-order position. In this case, the result is extended one position to include the carry as its most significant digit, the storage mark is positioned to the left of this digit, and the overflow check indicator is turned on. (Refer to “Overflow Check Indicator.”)

When the overflow exceeds the capacity of an auxiliary storage unit, the carry is made into the adjacent unit with proper positioning of the storage mark in this unit.

5. The add instruction does not affect the field in memory.

EXAMPLES, ADD

MEMORY	STORAGE BEFORE		STORAGE AFTER		CHECK IND.
	STORAGE	SIGN	STORAGE	SIGN	
+6235	a23	+	a258	+	
+6235	a23	—	a212	+	
+6235	a23	+	a212	—	
+6235	a23	+	a258	+	Sign check on
+12345	a15	+	a2360	+	Sign check on
b89	a20	—	a109	—	Overflow check on
b89	a89	+	a00	+	

Store (F—ST)

1. A numerical field in the accumulator or auxiliary storage is placed in memory by a store instruction. The address part of the instruction specifies the location in memory where the field is to be placed and the storage unit to be used.

2. The right-hand digit of the storage field is stored at the specified memory address. The remaining digits to the left are stored in successively lower memory positions until the storage mark is sensed. All digits from the position of the starting point counter to the storage mark are stored.

3. The sign of the accumulator or auxiliary storage is converted to plus or minus zoning and is placed over the units position of the field in memory.

4. When the character in the next lower memory position is numerical, this character is signed plus to

properly define the stored field. A non-numerical character is not affected.

5. The store instruction does not affect the field in accumulator or auxiliary storage.

Note: The store instruction should not be used on non-numerical fields in storage. Invalid characters in memory may result.

EXAMPLES, STORE

ACCUMULATOR		MEMORY BEFORE	MEMORY AFTER
STORAGE	SIGN		
a48	—	+ 1729	+ 1748
a67	+	+ 1729	+ 1767
a592	—	+ 3415	+ 3592
a738	+	+ 3415	+ 3738
a7468	—	FRAME	F7468
a35	—	@16	@35

Program, Addition

Figure 31 shows the program for $A + B = T$.

0004. Tape unit 0200 is selected.

0009. The tape record, including blank characters, is read into memory from left to right, beginning at address 7001 and continuing to address 7019. It is assumed that a blank has been stored previously in address 7000 and a group mark at address 7020.

0014. The proper positions of accumulator storage are reset and field A is entered. Field A is defined in memory as beginning with the signed digit 1 in memory address 7005 and continuing successively to the left until the non-numerical blank character is sensed.

0019. Field B is added to field A. The result is placed in accumulator storage. The sign of storage is plus.

0024. The result T is stored in memory at address 7019. The sign of the accumulator (plus) is placed over the units digit of the field T at address 7019.

INSTR. LOCATION	INSTRUCTION		STOR. CODE	ACCUMULATOR 00	Z	AUXILIARY STORAGE 01-15	Z
	OPER.	ADDRESS					
0004	SEL	0200					
0009	RD	7001					
0014	RAD	7005	00	a07321	+		
0019	ADD	7012	00	a0328471	+		
0024	ST	7019	00	a0328471	+		
0029	SEL	0201					
0034	WR	7001	00				
0039	TR	0004					

FIGURE 31. PROGRAM, $A + B = T$

The character at address 7012, the first position of the next left-hand field, is already signed. Therefore, field *T* is limited in memory to the characters found at addresses 7019 to 7013 inclusive. The factor in the accumulator is unaffected by the store instruction.

0029. Tape unit 0201 is selected.

0034. The unit record stored in memory, beginning at address 7001, is written from left to right up to the group mark in 7020. The record in memory is unaffected by this instruction.

0039. A transfer instruction is given to repeat the program for successive records in the tape unit.

CROSSFOOTING: $A + B - C = T$

THE TAPE record shown in Figure 32 is to be read into memory at addresses 13988 to 14014 inclusive. A group mark is stored at address 14015. Fields *A*, *B*, and *C* are signed plus. The entire record is to be written on tape after calculation.

Reset and Subtract (Q-RSU)

1. The reset and subtract instruction enters a numerical field from memory into accumulator or aux-

iliary storage. The address part of the instruction specifies the field location and the storage unit used.

Digits are entered into storage starting with the specified right-hand digit of the memory field and continuing from *right to left* until a non-numerical character is sensed. This non-numerical character is not entered into storage.

The zoning of the addressed digit of the memory field is changed to 00 zoning before this digit is entered into storage.

2. The accumulator or auxiliary storage sign is set to minus when the addressed memory character has plus zoning and is set to plus when the character has minus zoning. If the addressed character has neither plus nor minus zoning, an error is indicated and the sign of the field is interpreted as plus. (Refer to "Sign Check Indicator.") The sign is always set to plus when the result in storage is zero.

3. The left-hand limit of the storage field is automatically set by a storage mark (*a*) stored next to the last digit entered from memory.

When the memory field exceeds the capacity of an auxiliary storage unit, the field automatically extends into the adjacent unit with proper positioning of the storage mark in this unit (Figure 6).

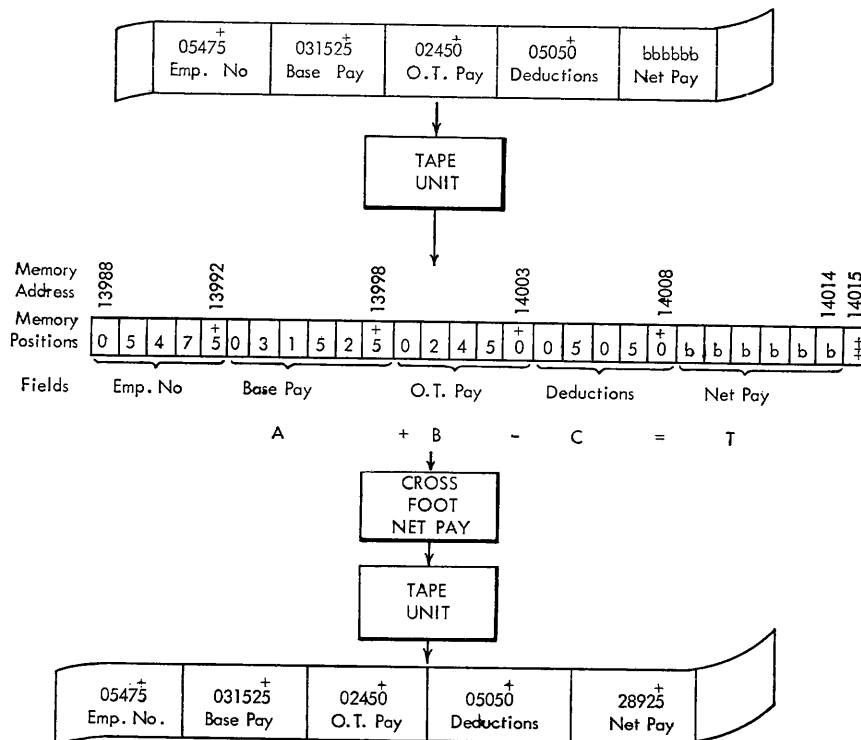

FIGURE 32. $A + B - C = T$

4. The field in memory is not affected by the reset and subtract instruction.

5. Special case: When the numerical portion of the character addressed by the instruction is 0000 (& — blank), the character is entered into storage as a zero (0 00 1010). The accumulator and auxiliary storage sign and the sign check indicator are set according to the rules stated above.

EXAMPLES, RESET AND SUBTRACT

MEMORY	STORAGE BEFORE		STORAGE AFTER		SIGN CHECK IND.
	STORAGE	SIGN	STORAGE	SIGN	
4456 ⁺	a11111	+	a456	+	
4456 ⁺	a1	—	a456	—	
4b56 ⁺	a11	+	a56	—	
r0000 ⁺	a1	—	a0000	+	See note
4bbb	a111	—	a0	+	ON
st	a11	—	a3	—	ON
A1	a1	—	a1	—	ON

Note: Since the resulting storage field is zero, the sign is set to PLUS.

Subtract (P—SUB)

1. The subtract instruction subtracts a numerical field in memory from a factor in accumulator or auxiliary storage. The address part of the instruction specifies the location of the field and the storage unit to be used.

Digits are subtracted from storage starting with the specified right-hand digit of the memory field and continuing from right to left until a non-numerical character is sensed. This non-numerical character is not subtracted from storage.

2. The result in accumulator or auxiliary storage is the difference between the storage factor and the specified memory field. The result replaces the original storage factor.

3. The accumulator or auxiliary storage sign is set according to the rules of algebra for subtraction. When the addressed character has neither plus nor minus zoning, an error is indicated and the sign of the field is interpreted as plus. (Refer to "Sign Check Indicator.") The sign is always set to plus when the result in storage is zero.

4. The left-hand limit of the result is automatically set by a storage mark stored next to the highest order digit.

The length of the result equals the longer of the two fields being subtracted, unless a carry is made out of the highest order position. In this case, the result is extended one position to include the carry as its most significant digit, the storage mark is positioned to the left of this digit, and the overflow check indicator is turned on. (Refer to "Overflow Check Indicator.")

When the overflow exceeds the capacity of an auxiliary storage unit, the carry is made into the adjacent unit with proper positioning of the storage mark in this unit.

5. The subtract instruction does not affect the field in memory.

Program, $A + B - C = T$

Figure 33 shows the program for $A + B - C = T$. 0004. Select tape unit 0200.

0009. Read the tape record into memory beginning with address 13988.

0014. Reset and add field *A* into auxiliary storage unit 01.

0019. Add field *B* from memory to the contents of auxiliary storage 01 to obtain the result of $A + B$.

0024. Subtract field *C* in auxiliary storage 01 to obtain the result *T*.

0029. Store the result *T* in memory at address 14014.

0034. Select tape unit 0201.

0039. Write out the completed record, beginning at address 13988. It is assumed that a group mark has been placed at memory address 14015.

0044. Transfer to repeat the program for succeeding records.

MULTIPLICATION: $A \times B = P$

THE RECORD shown in Figure 34 is stored in memory from tape at addresses 10706 through 10719 inclusive. The field *P* is blank and is to be calculated. The entire record is to be written on tape after calculation.

Multiply (V — MPY)

1. The multiply instruction causes a field in memory to be multiplied by a factor in accumulator storage 00.

2. The multiplicand is the field in memory speci-

INSTR. LOCATION	INSTRUCTION		STOR. CODE	ACCUMULATOR 00		AUXILIARY STORAGE 01-15	
	OPER.	ADDRESS		ACCUMULATOR	SIGN	STORAGE	SIGN
0004	SEL	0200					
0009	RD	3988					
0014	RAD	3998	01		a031525	+	
0019	ADD	4003	01		a033975	+	
0024	SUB	4008	01		a028925	+	
0029	ST	4014	01		a028925	+	
0034	SEL	0201					
0039	WR	3988	00				
0044	TR	0004					

FIGURE 33. PROGRAM, $A + B - C = T$

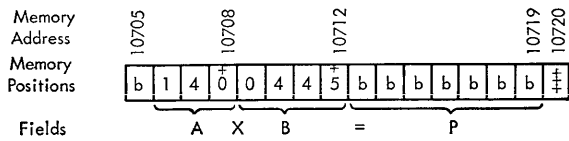

FIGURE 34. $A \times B = P$

fied by the address part of the instruction.

3. The multiplier is the accumulator factor.
4. The product is developed in accumulator storage 00. The number of digits in the product is equal to the sum of the number of digits in the multiplier and multiplicand. A maximum product of 128 digits can be obtained. Only accumulator 00 can be used for multiplication.
5. The resulting accumulator sign is plus if both multiplier and multiplicand have like signs, and minus if they have unlike signs.
6. Only numerical fields can be used in multiplication. The use of non-numerical fields produces inconsistent results.
7. When the addressed character of the field in memory has neither plus nor minus zoning, an error is indicated and the sign of the field is interpreted as plus. (Refer to "Sign Check Indicator.")
8. The multiplier may be recovered in accumulator storage by executing the instruction SHR 0128. (Refer to "Shorten.")

EXAMPLES, MULTIPLY

MEMORY	ACC. 00 BEFORE		ACC. 00 AFTER		CHECK IND.
	STORAGE	SIGN	STORAGE	SIGN	
280	a7	—	a560	—	
b3	a2	+	a06	+	
\$25	a31	—	a0775	+	
65	a007	+	a0035	—	
b5	a007	+	a0035	+	Sign check ON

Program, Multiplication

Figure 35 shows the program for $A \times B = P$.

- 0004. Select tape unit 0203.
- 0009. Read the record into memory beginning at address 10706.
- 0014. Reset and add A into accumulator storage 00.
- 0019. Multiply A by B . The product is developed in accumulator 00. The number of digits in the product is equal to the sum of the digits in A and B , including insignificant zeros.
- 0024. The result P of seven digits is stored in memory at address 10719.
- 0029. Select tape unit 0200.
- 0034. Write the completed record on tape from memory, beginning at address 10706.
- 0039. Transfer to instruction 0004 to repeat the program.

INSTR. LOCATION	INSTRUCTION		STOR. CODE	ACCUMULATOR 00		AUXILIARY STORAGE 01-15	
	OPER.	ADDRESS		ACCUMULATOR	SIGN	STORAGE	SIGN
0004	SEL	0203					
0009	RD	0706					
0014	RAD	0708	00		a140	+	
0019	MPY	0712	00		a0062300	+	
0024	ST	0719	00		a0062300	+	
0029	SEL	0200					
0034	WR	0706	00				
0039	TR	0004					

FIGURE 35. PROGRAM, $A \times B = P$

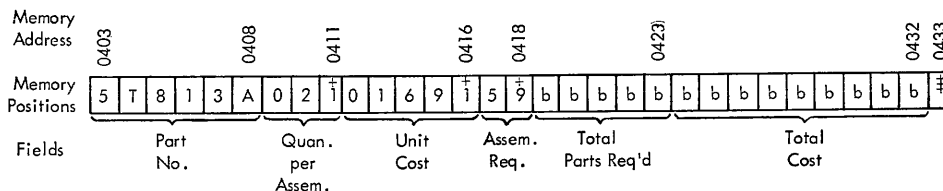

FIGURE 36. $A \times B = P$ (ROUNDED)

MULTIPLICATION WITH HALF ADJUSTMENT

THE PRODUCT, P , may be half adjusted in accumulator 00 at any position by use of the round instruction. The record shown in Figure 36 is stored in memory from tape. Computations to be made in the record are as follows:

- Quantity of parts per assembly \times Assemblies required = Total quantity of parts required.
- Total quantity of parts required \times Unit cost (3 decimals) = Total cost.
- Adjust total cost to the nearest cent.

Round (E—RND)

1. The round instruction moves the starting point counter of accumulator 00 to the left the number of positions specified by the address part of the instruction. Only accumulator 00 can be specified. The field remaining in storage is limited to those digits between the accumulator mark and the new position of the starting point counter.

2. A 5 is added to the digit to the right of the final position of the starting point counter. Any resulting carry is added to the units digit of the remaining storage field.

3. When a carry is made out of the high-order position of the original field, the result is extended one position to the left to include the carry, and the overflow check indicator is turned on. (Refer to "Overflow Check Indicator.")

4. The instruction ROUND 0000 has no effect.

5. When the result in accumulator storage is zero, the sign is always set to plus.

6. When the position where the 5 is to be added happens to contain a storage mark, the 5 is placed in

the accumulator at this point, but a storage mark is placed to the left of the starting point counter. Thus, the result has a zero field length. In this case the overflow check indicator is turned on.

EXAMPLES, ROUND

INSTRUCTION	ACC. 00 BEFORE		ACC. 00 AFTER		CHECK IND.
	STORAGE	SIGN	STORAGE	SIGN	
RND 0002	a5653	+	a57	+	
RND 0002	a5653	—	a57	—	
RND 0004	a98912	+	a10	+	Overflow on
RND 0001	a349	+	a35	+	
RND 0002	a0049	—	a00	+	
RND 0003	a146a41	+	a14a	+	Overflow on

Program, Multiplication with Half Adjustment

Figure 37 shows the program for completion of the record shown in Figure 36.

0004. Select tape unit 0200.

0009. Read the record into memory, beginning at memory address 0403.

0014. Reset and add the quantity of assemblies required at address 0418.

0019. Multiply quantity of assemblies \times parts per assembly = total quantity of parts required.

0024. Store total quantity of parts required at address 0423.

0029. Multiply parts required \times unit cost = total cost. Unit cost contains three decimals.

0034. Adjust total cost to nearest cent by ROUND 0001.

0039. Store total cost at address 0432.

0044. Select tape unit 0201.

0049. Write the record on tape. Assume that a group mark has been placed in memory at address 0433.

0054. Transfer to repeat the program.

INSTR. LOCATION	INSTRUCTION		STOR. CODE	ACCUMULATOR 00	Z C S	AUXILIARY STORAGE 01-15	Z C S
	OPER.	ADDRESS					
0004	SEL	0200					
0009	RD	0403					
0014	RAD	0418	00	a59	+		
0019	MPY	0411	00	a01239	+		
0024	ST	0423	00				
0029	MPY	0416	00	a0002095149	+		
0034	RND	0001	00	a000209515	+		
0039	ST	0432	00				
0044	SEL	0201					
0049	WR	0403	00				
0054	TR	0004					

FIGURE 37. PROGRAM, $A \times B = P$ (ROUNDED)

SHIFT INSTRUCTIONS

THE 705 can perform shift instructions to adjust field length in accumulator or auxiliary storage units. Fields may be lengthened to the right or left with the addition of zeros, or may be shortened by moving the storage mark or the starting point counter as required. These instructions are useful for eliminating insignificant zeros from calculated results, coupling auxiliary storage units, adjusting the dividend and

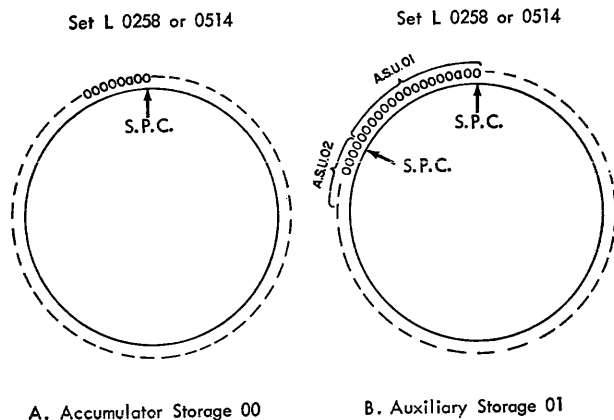

FIGURE 40. SCHEMATIC, SET LEFT INSTRUCTION

as SET LEFT 0002. All positions, except the third position to the left of the starting point counter, contain zeros.

When auxiliary storage units are specified by these instructions, the storage mark is placed in the same position as for SET LEFT 0002. All positions of the auxiliary storage circle contain zeros, except the third position to the left of the starting point counter of the specified storage unit. This position contains the storage mark.

5. The instruction SET 0000 places a storage mark at the position of the starting point counter, turns on the zero indicator, and sets the sign of accumulator or auxiliary storage to plus.

EXAMPLES, SET LEFT

INSTRUCTION	STORAGE BEFORE	SIGN	STORAGE AFTER	SIGN
SET 0004	a52	—	a0052	—
SET 0002	a0052	+	a52	+
SET 0001	a52	+	a2	+
SET 0003	a2000	—	a000	+

Shorten (C—SHR)

1. The shorten instruction shifts the starting point counter of accumulator storage to the left. The number of positions moved is specified by the address part of the instruction.

2. Because the field in storage consists of those characters between the position of the starting point counter and the storage mark, the movement of the starting point counter to the left has the effect of removing characters from the right end of the storage field.

3. The instruction SHORTEN 0000 has no effect. The position of the starting point counter when

using address parts greater than 0256 can be found by considering the circular nature of accumulator storage and its total capacity of 256 positions. Thus, SHORTEN 0769, 0257, and 0001 all have the same effect.

4. When, as a result of a shorten instruction, the field in accumulator storage is zero, the accumulator sign is always set to plus.

EXAMPLES, SHORTEN

INSTRUCTION	ACCUMULATOR BEFORE		ACCUMULATOR AFTER	
	STORAGE	SIGN	STORAGE	SIGN
SHR 0002	a1246	+	a12	+
SHR 0001	a1246	—	a124	—
SHR 0000	a1246	—	a1246	—
SHR 0002	a0046	—	a00	+

Lengthen (D—LNG)

1. The lengthen instruction shifts the starting point counter of accumulator storage to the right. The address part of the instruction specifies the number of positions to be moved.

2. A zero is inserted to the right of the field in storage for each position moved by the starting point counter. The number of zeros inserted is designated by the address part of the instruction.

3. A storage mark is always placed in the position to the right of the starting point counter. This occurs even in the case of LNG 0000, which performs no lengthening function. Because of the circular nature of accumulator storage, an address part greater than 0254 fills accumulator storage with 255 zeros and a storage mark. The final position of the starting point counter can be found by repetitive subtraction of 256 from the address part. The remainder, following the last subtraction, indicates the position of the counter.

EXAMPLES, LENGTHEN

INSTRUCTION	ACCUMULATOR BEFORE	ACCUMULATOR AFTER
LNG 0002	a5723	a572300
LNG 0005	a1	a100000
LNG 0001	a4689	a46890

DIVISION: $A \div B = Q$

The fields A and B are stored in memory at addresses 16026 and 16028, respectively, as shown in Figure 41. The quotient Q is to be stored at address 16031. Field A contains four decimals, field B two decimals, and Q one decimal.

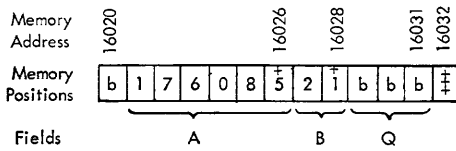

FIGURE 41. $A \div B = Q$

Divide (W—DIV)

1. The divide instruction causes a factor in accumulator storage 00 to be divided by the field in memory specified by the address part of the instruction. The memory field is the divisor and the accumulator factor is the dividend. The quotient is developed in accumulator storage.

2. The number of digits in the quotient is equal to the number of digits in the dividend less the number of digits in the divisor, including insignificant zeros. A maximum dividend length of 128 digits can be used.

3. The dividend must contain a greater number of digits than the divisor. Otherwise, the division is ignored, the zero indicator is turned on, and the machine proceeds to the next instruction.

The divisor must have a greater absolute value than an equal number of digits taken from the left end of the dividend. For example, $7 \div 2$ cannot be performed because the divisor, 2, is less than the dividend 7; $07 \div 2$ can be performed because the divisor 2, is of greater value than the high-order digit of the dividend, 0; $12345 \div 13$ can be performed because the divisor, 13, is of greater value than the two high-order digits of the dividend, 12. This rule can be satisfied by inserting zeros in the high-order positions of the dividend as required. If this rule is not satisfied:

- a. The overflow check indicator and the zero indicator turn on.
- b. The division is not completed.

- c. A single zero replaces the contents of accumulator storage.
- d. The machine proceeds to the next instruction.
- e. The accumulator sign remains the same as that of the replaced dividend.

4. The accumulator sign is plus if the divisor and dividend have like signs, and minus if they have unlike signs.

5. When the right-hand character of the field in memory has neither plus nor minus zoning, an error is indicated and the sign of the field is interpreted as plus. (Refer to "Sign Check Indicator.")

6. Only numerical fields may be used in division. Non-numerical fields produce inconsistent results.

7. After division, the remainder may be recovered in either of two ways:

- a. By multiplying the quotient by the divisor and subtracting the result from the dividend.
- b. By performing a shorten operation with an address part equal to 0128 minus the length of the divisor. (Refer to "Shorten.")

The quotient is developed to the right of the storage mark which is positioned 128 positions to the left of the storage mark defining the dividend. The remainder always occupies the same accumulator positions as the original dividend. For example, after dividing 02333 by 111, accumulator storage would appear as in Figure 42A.

If a SHORTEN 0128 instruction is given, the starting point counter moves 128 positions to the left and stops under the position containing the second zero to the right of the remainder storage mark (Figure 42B). However, the starting point counter is to be placed under the 2. This position is three positions (number of digits in divisor) to the right. Therefore, SHORTEN 0125 places the starting point counter properly (Figure 42C). The storage mark to the right of

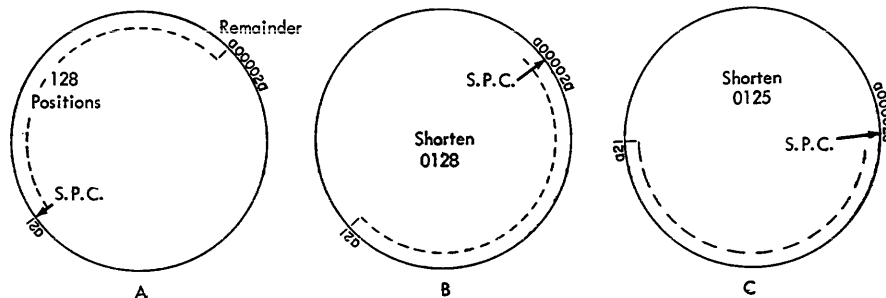

FIGURE 42. SCHEMATIC, SHORTEN INSTRUCTION

the remainder is placed there automatically at the beginning of the division operation and is used to stop the division.

The number of significant digits in the remainder can never exceed the number of digits in the divisor. Therefore, it is usually advantageous to set left the number of digits in the divisor before storing or using the remainder.

EXAMPLES, DIVISION

MEMORY	ACCUMULATOR BEFORE		ACCUMULATOR AFTER		CHECK IND.
	STORAGE	SIGN	STORAGE	SIGN	
A50 ⁺	a2501	+	a50	+	
b50 ⁺	a511	+	a0	+	Zero on Overflow on
b50 ⁺	a55	+	a55	+	Zero on
b50 ⁻	a12700	+	a254	-	
b50 ⁺	a12700	+	a254	+	Sign check on
b50 ⁺	a604	-	a0	-	Zero on Overflow on

NOTE: Division by zero always violates the rule that the divisor must be greater than the value of an equal number of digits taken from the left end of the dividend. However, when zero is divided by zero, the violation of this rule does not turn on the overflow check indicator. Division by zero results in a quotient of zero, ones and a zero, or all ones.

In most divisions, it is necessary to know a great deal about the divisor and its relationship to the dividend. Where this is not the case, it is recom-

mended that a transfer-on-zero instruction be inserted to determine whether the dividend is a zero. If it is a zero, a transfer may be made to examine the divisor or take other corrective action.

Program, Division

Figure 43 shows the program for $A \div B = Q$.

0004. Select tape unit 0200.

0009. Read the record into memory beginning at address 16021.

0014. Reset and add the dividend *A* into accumulator storage.

0019. Divide *A* by *B* to produce the quotient *P* in accumulator storage.

0024. Half-adjust *Q* one position.

0029. Store *Q* at memory address 16031.

0034. Select tape unit 0201.

0039. Write the record on tape. Assume a group mark has been placed at address 16031.

0044. Transfer to repeat the program.

GROSS PAY CALCULATION

PROGRAMMING a section of a payroll problem further demonstrates the combined use of the previously discussed arithmetic instructions.

The payroll data are received on tape and are stored in memory as shown in Figure 44. Fields are: man number, incentive earnings, hourly earnings, overtime allowance hours, and regular hours. The calculations to be performed are:

$$\text{Average Rate} = \frac{\text{Regular Earnings} + \text{Incentive Earnings}}{\text{Regular Hours}}$$

$$\text{Overtime Amount} = \text{Average Rate} \times \text{Overtime Allowance Hours}$$

$$\text{Gross Pay} = \text{Regular Earnings} + \text{Incentive Earnings} + \text{Overtime Amount}$$

INSTR. LOCATION	INSTRUCTION		STOR. CODE	ACCUMULATOR 00		AUXILIARY STORAGE 01-15	
	OPER.	ADDRESS		NUM.	SIGN	NUM.	SIGN
0004	SEL	0200					
0009	RD	0201					
0014	RAD	0206	00	a176085	+		
0019	DIV	0208	00	a8385	+		
0024	RND	0001	00	a839	+		
0029	ST	0201	00				
0034	SEL	0201					
0039	WR	0201	00				
0044	TR	0004					

FIGURE 43. PROGRAM, $A \div B = Q$

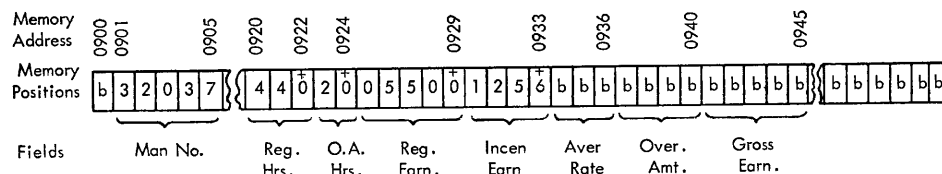

FIGURE 44. GROSS PAY CALCULATION

Program, Gross Pay Calculation

Figure 45 is the program for gross pay calculation.

0004. Select tape unit 0200.

0009. Read the record into memory beginning at address 0901.

0014. Reset and add regular earnings into accumulator storage.

INSTR. LOCATION	INSTRUCTION		STOR. CODE	ACCUMULATOR 00	Z 0 5	AUXILIARY STORAGE 01-15	Z 0 5
	OPER.	ADDRESS					
0004	SEL	0200					
0009	RD	0901					
0014	RAD	0929	00	a05500	+		
0019	ADD	0933	00	a06756	+		
0024	SET	0006	00	a006756	+		
0029	LNG	0002	00	a00675600	+		
0034	DIV	0922	00	a01535	+		
0039	RND	0001	00	a0154	+		
0044	SET	0003	00	a154	+		
0049	ST	0936	00				
0054	MPY	0924	00	a03080	+		
0059	RND	0001	00	a0308	+		
0064	ST	0940	00				
0069	ADD	0929	00	a05808	+		
0074	ADD	0933	00	a07064	+		
0079	ST	0945	00				
0084	SEL	0201					
0089	WR	0901	00				
0094	TR	0004					

FIGURE 45. PROGRAM, GROSS PAY CALCULATION

0019. Add incentive earnings to regular earnings. The result is the dividend to be divided by regular hours.

0024. One zero is added to the left of the dividend

to insure that the absolute value of the divisor is always greater than an equal number of digits taken from the left end of the dividend.

0029. The divisor (regular hours) has one decimal, the quotient (average rate) has two decimals, and the quotient is to be half adjusted, making a total of four decimals to point off in the dividend. Because the dividend now has only two decimals, it must be lengthened two positions by adding zeros. The number of decimals in the quotient, plus the number of decimals in the divisor, plus one for half-adjustment, equals the number of positions to the right of the decimal point in the dividend.

0034. Divide:

$$\text{Average Rate} = \frac{\text{Regular Earnings} + \text{Incentive Earnings}}{\text{Regular Hours}}$$

0039. Half-adjust the average rate to the nearest cent.

0044. Adjust average rate to three positions.

0049. Store average rate.

0054. Multiply: Average rate \times overtime allowance hours = overtime earnings.

0059. Adjust overtime earnings to the nearest cent.

0064. Store overtime earnings.

0069. Add regular earnings + overtime earnings.

0074. Add incentive earnings = gross pay.

0079. Store gross pay.

0084. Select tape unit 0201.

0089. Write the record on tape.

0094. Transfer to repeat the program.

DATA-TRANSMISSION OPERATIONS

THIS section explains various methods of moving data in the 705 from one memory location to another. The machine provides the programmer with complete flexibility of record handling, including transmission directly from memory to memory, from memory to the storage units, and from storage units to memory. Data to be transmitted from one storage unit to another, however, must pass through memory. The transmission may affect an entire record in one operation or may specify particular fields, groups of fields, or individual characters.

Two or more records can be combined within the machine, either with or without calculation, to form any desired arrangement of output information for punching in cards, printing on report forms, or writing on tape. Conversely, single records can be split to form several records in any arrangement and transcribed by one or more of the output units. Any or all of the various input-output devices may be used during a single procedure to handle the record forms: cards, tape, or printed reports.

The following two sections illustrate the use of receive and transmit instructions for 5-character and single-character transmissions.

MEMORY-TO-MEMORY TRANSMISSION, FIVE CHARACTERS

THE RECORD shown in Figure 46 is read from tape unit 0200 into memory locations 6000-6499 inclusive. The record is to be transmitted to a work area starting with memory location 11560. After transmission, the record is written on output tape unit 0201.

The last character of the record is a *record mark*. This special character may be a part of the record on tape, as shown in Figure 46, or it may be placed in the proper memory position at the end of the record by instructions in the program. The character

may also originate from the control panel of the card reader (Figure 120).

The record mark serves two purposes:

1. When placed in the proper position at the end of the record, it stops 5-character transmission of the record from one memory location to another in much the same manner as a group mark limits a writing operation.
2. It may be written between records on tapes when records are grouped into blocks. In this case, each block is separated by the inter-record gap; records within the block are separated by record marks. This procedure is more fully explained in the section on grouping records.

Two instructions are used to transmit the record in Figure 46, five characters at a time.

Receive (U—RCV)

1. The address part of receive instruction specifies the location in memory which will receive the record during transmission.

2. When blocks of five characters are received, the address part specifies the memory location of the fifth character to be received and must *always have a units digit of 4 or 9*. The address, therefore, refers to memory addresses with a units digit of either 4 or 9. The total number of characters to be received, including the record mark, *must be evenly divisible by 5*. The location of the record mark controls the length of the record received.

3. When individual characters or fields are received one character at a time, the address part of the instruction specifies the memory location of the first character to be received. The address may then specify any memory address, not necessarily one with a units digit of 4 or 9. The transmit instruction controls the number of characters received.

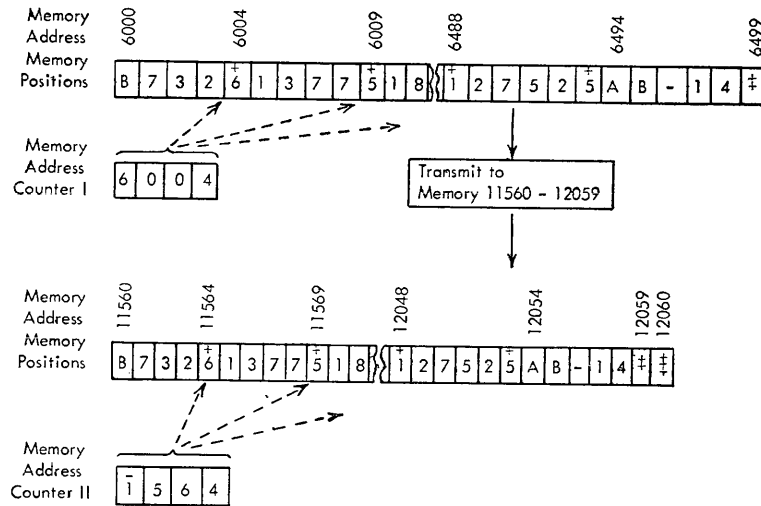

FIGURE 46. MEMORY-TO-MEMORY TRANSMISSION, FIVE-CHARACTER

4. The address of the receive instruction is placed in memory address counter II (MAC II). This counter advances five positions after each block of five characters has been transmitted, or by single positions depending upon how the transmit instruction is controlled.

Transmit (9—TMT)

1. The transmit instruction specifies the location in memory from which the record is to be transmitted to the receiving area.

2. The address part of the instruction specifies the type of transmission, five-character groups or single characters.

- a. When accumulator 00 is specified, the transmission is by five-character groups. The record mark limits transmission.
- b. When auxiliary storage units are specified, the storage mark in the selected unit limits the number of characters transmitted. During transmission, the storage unit is checked for a storage mark beginning at the right-hand position. This check is made for each character transmitted until the storage mark is sensed. Sensing the mark stops the operation.

Any auxiliary storage unit may be used. The stor-

age mark is usually adjusted by a set left instruction or properly positioned as a result of calculation.

3. When blocks of five characters are transmitted, the address part specifies the memory location of the fifth character to be transmitted and must always have a units digit of 4 or 9.

4. Transmission in blocks of five characters is limited by the record mark which would normally be the last character of the record. The address of this limiting mark must always have a units digit of 4 or 9 and the total number of characters transmitted, including the record mark, *must be evenly divisible by five*. A record mark in other positions of memory is transmitted like any other character and does not limit transmission.

5. When individual characters or fields are transmitted, one character at a time, the address part of the instruction specifies the memory location of the first character to be transmitted. The address may then specify any memory address, not necessarily one with a units digit of 4 or 9.

6. The address of the transmit instruction is placed in memory address counter I (MAC I). This counter advances five positions after each block of five characters has been transmitted, or by single positions, depending upon how the operation is controlled.

7. The original record is not affected by the transmit operation.

8. The time for transmission of five-character groups may be computed as follows:

$$.017 + (N/5 \times .018) \text{ milliseconds}$$

where .017 is the time to read and interpret the transmit instruction and N is the total number of characters to be transmitted. Thus, the time to transmit the 500-character record in Figure 46 is $.017 + (100 \times .018)$ milliseconds, or 1.817 milliseconds.

The time for transmission by single characters is as follows:

$$.034 + (N \times .018) \text{ milliseconds}$$

where .034 is the time to read and interpret the transmit instruction and N is the total number of characters to be transmitted. The time to transmit 500 characters is therefore $.034 + (500 \times .018)$ milliseconds, or 9.034 milliseconds.

The high-speed, five-character transmission is the fastest method of transferring data in memory. It would normally be used to transmit entire records, while the single-character transmission is used for movement of individual characters or fields.

Program, Transmitting Five Characters

Figure 47 is the program for transmitting five-character groups.

0004. Select tape unit 0200.

0009. Read the record into memory beginning at the address 6000.

0014. Set memory address counter II to address 11564 to prepare to receive the first five characters of the record.

0019. Set memory address counter I to address 6004, to transmit the first five characters to the location specified by the receive instruction. Because accumulator 00 is specified, transmission continues in five-character groups until the record mark is reached at address 6499. Both memory address counters advance five positions at a time.

0024. Continue the main body of the program.

0494. Select tape unit 0201.

0499. Write the record beginning at address 11560.

0504. Transfer to repeat the program.

INSTR. LOCATION	INSTRUCTION		STOR. CODE	ACCUMULATOR 00	Z	AUXILIARY STORAGE 01-15	Z
	OPER.	ADDRESS					
0004	SEL	0200					
0009	RD	6000					
0014	RCV	11564					
0019	TMT	6004	00				
0024	RAD		04				
0494	SEL	0201					
0499	WR	11560	00				
0504	TR	0004					

FIGURE 47. PROGRAM, MEMORY-TO-MEMORY TRANSMISSION, FIVE-CHARACTER

MEMORY-TO-MEMORY TRANSMISSION, SINGLE CHARACTERS

TWO RECORDS are read into memory as shown in Figure 48. Record A is a portion of a master payroll record on tape. Record B is an employee rate and occupation change notice on IBM cards.

A record mark is included as the last character of record A. A group mark is emitted from the card reader as the last character of record B. Record A is transmitted to work area C in blocks of five characters. Since the total number of characters in record A is not divisible by five, one blank position of memory at address 16035 is included in the transmission. The rate, occupation names, and date are placed in the work area by single character transmission. Auxiliary storage units are adjusted to control the transmission as "housekeeping" program steps before the records are read into memory.

The matching of input tapes and card records by employee number is omitted from the problem.

Program, Transmitting Single Characters

Figure 49 is the program for single-character transmission from memory to memory.

0004, 0009, 0014, 0019. The storage marks in auxiliary storage units 01, 02, 03 and 04 are adjusted to control transmission of the group marks and the rate, occupation name and date fields to record C. These preliminary steps are referred to as "housekeeping" instructions and need to be executed only once for all records to be processed. Once the stor-

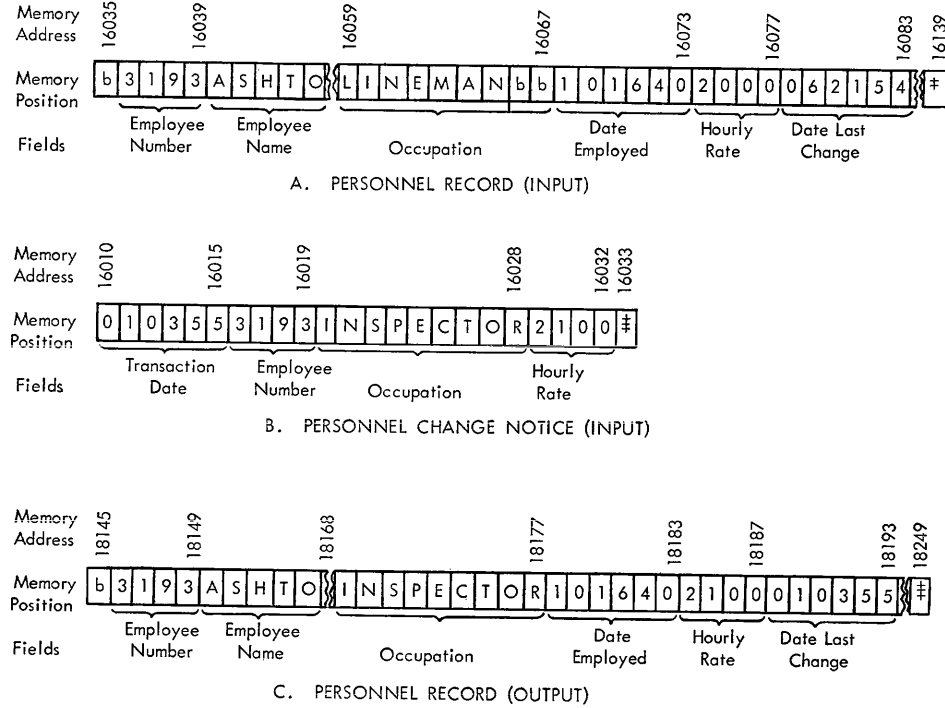

FIGURE 48. MEMORY-TO-MEMORY TRANSMISSION, SINGLE CHARACTER

age marks are placed, they remain in their respective locations throughout the entire procedure, provided their position is not changed by other instructions in the program.

INSTR. LOCATION	INSTRUCTION OPER.	ADDRESS	STOR. CODE	ACCUMULATOR 00	24 25 26 27 28 29 30 31 32 33 34 35 36 37 38 39 40 41 42 43 44 45 46 47 48 49 50 51 52 53 54 55 56 57 58 59 60 61 62 63 64 65 66 67 68 69 70 71 72 73 74 75 76 77 78 79 80 81 82 83 84 85 86 87 88 89 90 91 92 93 94 95 96 97 98 99 100	AUXILIARY STORAGE 01-15	SIGN
0004	SET	0001	01				
0009	SET	0004	02				
0014	SET	0006	03				
0019	SET	0009	04				
0104	SEL	0200					
0109	RD	0306					
0114	SEL	0100					
0119	RD	0100					
0124	RCV	0149					
0129	TMT	0309	00				
0134	RCV	0169					
0139	TMT	0200	04				
0144	RCV	0184					
0149	TMT	0209	02				
0154	TMT	0310	03				
0159	RCV	0249					
0164	TMT	0333	01				
0169	SEL	0201					
0174	WR	0146	00				
0179	TR	0104					

FIGURE 49. PROGRAM, MEMORY-TO-MEMORY TRANSMISSION, SINGLE CHARACTER

- 0104. Select tape unit 0200.
- 0109. Read the tape record into memory beginning at address 16036. Location 16035 is assumed to be blank.
- 0114. Select card reader 0100.
- 0119. Read the card record into memory beginning at address 16010.
- 0124. Set MAC II to memory address 18149 to receive the first five characters of record A.
- 0129. Set MAC I to memory address 16039 to transmit the first five characters of record A to the location specified by the receive instruction. Accumulator 00 is specified for five-character transmission. The transmission continues, in blocks of five characters, until the record mark is sensed.
- 0134. Set MAC II to 18169 to receive the first character of occupation name from the card record.
- 0139. Set MAC I to 16020 to transmit the first character of occupation name. Auxiliary storage unit 04 is specified to limit single-character transmission to the nine characters of the field.
- 0144. Set MAC II to 18184 to receive the first character of hourly rate from the card record.
- 0149. Set MAC I to 16029 to transmit hourly rate.

Auxiliary storage unit 02 is specified to control the transmission of the four-character field.

0154. Set MAC I to 16010 to transmit transaction date from the card. MAC II has been properly positioned at 18188 during transmission of hourly rate and does not need to be reset by a second receive instruction. The counter remains set to this address until another receive instruction is given or until stepped to a new address by a transmit instruction. The transmission of the 6-character transaction date field is controlled by specifying auxiliary storage unit 03.

0159. Set MAC II to 18249 to receive a group mark.

0164. Transmit the group mark from the card record at memory address 16033. The group mark replaces the record mark transmitted by the instruction at memory location 0129.

0169. Select tape unit 0201.

0174. Write the record on tape, beginning at memory address 18146. The group mark placed at location 18249 stops the writing operation.

0179. Transfer to repeat the program from the instruction located in memory position 0104.

TRANSMISSION, READ WHILE WRITING

A RECORD or group of records may be read into memory from tape and at the same time another record or group of records may be written from memory onto tape. Two areas of memory must be set aside for this operation, one for reading in and the other for writing out.

The record shown in Figure 50 is a portion of a materials and supply record on tape. Housekeeping instructions read the first record into the input area. The record is transmitted to an output area where the amount field is calculated and stored at the end of the record. The record is written on tape from the output area and at the same time the second record is read into the input area. Simultaneous reading and writing is continued for all succeeding records.

In Figure 50 it is assumed that a record mark and a group mark have been previously placed at memory addresses 19049 and 19655, respectively.

Read-while-Writing (S—RWW)

1. The read-while-writing instruction conditions a selected input tape unit to retain its selected status. It prepares the unit to read, but reading is not actually accomplished until a subsequent write or write-and-erase instruction is given to the output tape unit. (Refer to "Write and Erase.")

2. The address part of the instruction specifies the memory location into which the input data are to be read. After the output tape unit is selected, the simultaneous reading and writing operation begins when the write or write-and-erase instruction is given.

3. The time of execution is determined by the longest record or group of records read or written. The time to read and write a 200-character record would be as follows:

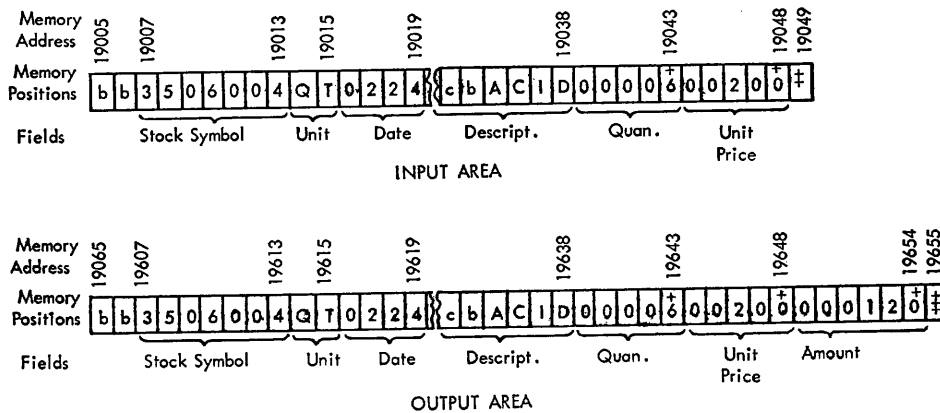

FIGURE 50. TRANSMISSION, READ WHILE WRITING

10.00 milliseconds (access time to tape)
 13.40 (.067 milliseconds × 200 characters)
 23.40 milliseconds (total time to read and write a 200-character record)

When the record read in is longer than the record written out, or vice versa, the machine waits for the longer record before continuing with the program.

4. Only two tape units at a time may be used for simultaneous reading and writing. One of the units must be assigned an address with the units digit odd; the other, an address with the units digit even. It is possible, however, to modify the addresses in such a way that any two input and output units may be selected during one data-processing procedure. For example, for one read-while-writing operation, the input tape could be 0201 and the output 0200. The next operation could specify an input 0208 and an output 0205, and so on.

One control unit on the 705 can accommodate ten tape units. Two signal cables are attached to the control unit. One is to be used for odd-numbered tape units and one for even-numbered units. Only tape units with odd-numbered addresses may be connected to the odd cable; only those with even-numbered addresses may be connected to the even cable. Figure 51 shows the ten tape units attached to the control unit, five on each side. The control unit itself has the first three digits of the tape addresses which in Figure 51 are 020. The tape units are assigned the units digit of the address, which must be set to an

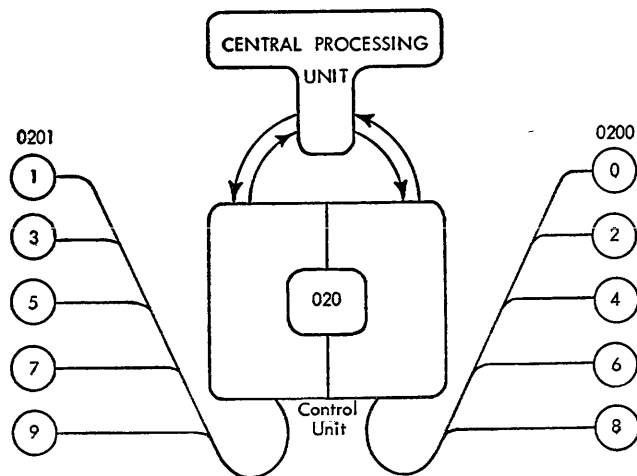

FIGURE 51. TAPE CONTROL UNIT, READ WHILE WRITING

even number to read in through the control unit and an odd number to write out, or vice versa.

When separate control units are used for input and output, such as 020 and 021, there is no restriction on the assignment of tape unit addresses.

5. The read-while-writing operation cannot be performed using overlapping input and output areas in memory.

6. The setting of memory address counter II controls the reading of a record into memory. The setting of MAC I controls the writing of a record from memory.

Program Read-while-Writing

Figure 52 is the program for the read-while-writing problem shown in Figure 50.

0004. Select input tape 0200.

0009. Read the first record into memory beginning at location 19007.

0104. Prepare to transmit the record from input area to output area in five-character blocks.

0109. Transmit the record, specifying accumulator 00. The record mark in memory position 19049 stops the transmission. The number of characters in the record is not divisible by five. Therefore, two blank positions of memory are included in the record for transmission.

0114. Reset and add the quantity field in accumulator 00.

0119. Multiply: quantity × unit price = amount. Unit price has three decimals.

INSTR. LOCATION	INSTRUCTION		STOR. CODE	ACCUMULATOR 00	Z 01	AUXILIARY STORAGE 01-15	Z 02
	OPER.	ADDRESS					
0004	SEL	0200					
0009	RD	9007					
0104	RCV	9609					
0109	TMT	9009	00				
0114	RAD	9643	00	α00006	+		
0119	MPY	9648	00	α0000001200	+		
0124	RND	0001	00	α000000120	+		
0129	SET	0006	00	α000120	+		
0134	ST	9654	00				
0139	SEL	0200					
0144	RWW	9007					
0149	SEL	0201					
0154	WR	9607	00				
0159	TR	0104					

FIGURE 52. PROGRAM, READ WHILE WRITING

0124. Round amount to the nearest cent.

0129. Adjust the amount field to six positions. It must be known that the total value of any item will not exceed six digits.

0134. Store amount in the output area. The record mark previously placed in position 19649 by the transmit instruction is erased.

0139. Select input tape unit 0200.

0144. Condition unit 0200 to remain selected until the next write instruction is given.

0149. Select output tape unit 0201.

0154. Read a record into memory beginning at memory location 19007 as specified by the read-while-writing instruction. Write the record beginning at memory address 19607.

0154. Transfer to repeat the program beginning with the instruction at memory location 0104. The instructions at 0004 and 0009 are used only to read in the first record.

Placing Group Marks

The read-while-writing operation is also useful for placing a group mark at the end of a record of variable length after it has been read into memory.

For example, assume that a group mark is stored in memory at address 6001. Auxiliary storage unit 01 is set to a length of one. The following instructions will automatically place the group mark at end of the record read into memory.

```
SEL  0200  Select input tape.
RWW  7001  Prepare to read next record, set
           MAC II.
SEL  0201  Select output tape.
WR   8001  Read next record while writing
           previous record.

TMT  6001 01 Transmit group mark.
```

The RWW instruction sets MAC II to the memory address of the first character of the record to be read into memory. When reading is completed, the setting of MAC II is equal to the address of one memory position beyond the address of the final character read. The transmit instruction carries a group mark to be placed at this address. Only one character is transmitted because transmission is maintained by ASU 01.

When only a reading operation is to be performed,

the group mark may be placed by the following instructions:

```
SEL  0200  Select input tape.
RWW  7001  Set MAC II.
RD   xxxx  (any address)
TMT  6001 01 Transmit group mark.
```

The RWW instruction in this case causes MAC II to be used to control reading. The address of the instruction is the memory position of the first character of the read area. The address of the read instruction is not used since the reading is controlled by the setting of MAC II. When reading is completed, the setting of MAC II is equal to the address of one memory position beyond the address of the final character read. A group mark is automatically transmitted to this position from address 6001.

The method of using the setting of MAC II to place a group mark is also useful for the transmission of variable length records from an input area to an output area, as follows:

```
RCV  8004
TMT  7004 00 Transmit record to output area.
TMT  6004 00 Transmit group mark.
```

The transmit instructions are coded 00 to transmit in blocks of five characters. It is assumed that a record mark is properly placed at the end of the record at 7000 to limit high-speed transmission.

After transmission is completed, the setting of MAC II is equal to the address of the fifth memory position beyond the position of the record mark in the output area. Therefore the character at address 6000 through 6004 must be #bbb‡ (a group mark, three blanks, and a record mark).

TRANSMISSION VIA STORAGE UNITS; SEQUENCE CHECKING

THE ACCUMULATOR and auxiliary storage units of the 705 can store either alphabetic or numerical data with equal facility. Single characters, fields, or complete records can be placed in storage as required.

Once stored, the data can be compared against other data in memory or transferred to one or more locations in memory. Addresses, operation codes, or complete instructions may be placed in a storage unit

and transferred to modify or replace other instructions in the program. Unsigned numerical fields may be placed in storage for comparison or for rearrangement of records without the use of arithmetic instructions. These operations are accomplished by using load, unload and compare instructions.

Figure 53 illustrates a problem of sequence checking. An inventory record, to be stored in memory, is now on tape. The file of records is to be checked to determine if the records are in ascending numerical sequence by part number. If any out-of-sequence or equal records are discovered, those records are to be written on the typewriter for checking by the operator. When the sequence is correct, unit cost is developed, and the record is transmitted to an output area and written on tape. A work area of memory is provided for storage of man number from the previous record. A group mark has been placed in memory location 15865 and must be moved to both input and output areas.

Load Storage (8—LOD)

1. The load instruction permits single characters, any series of characters, or fields to be entered into accumulator or auxiliary storage from memory.
2. The number of characters or length of the field loaded into storage is determined by the position of the storage mark relative to the starting point counter. The load instruction may be preceded by a set left instruction to adjust storage to the size of the field to be loaded.

3. The address part of the instruction specifies the location of the right-hand character of the field in memory and the storage unit to be used. Characters are loaded from right to left from memory until the specified storage space is filled.

4. The accumulator or auxiliary storage sign is always set to plus by a load instruction.

5. The field, character, or series of characters in memory are not affected.

EXAMPLES, LOAD

MEMORY	STORAGE BEFORE		STORAGE AFTER	
	STORAGE	SIGN	STORAGE	SIGN
ABCbbb12345	a7310	+	a2345	+
ABCbbb12345	a12345678901	-	aABCbbb12345	+
ABCbbb12345	a00	+	a45	+
ABCbbb12345	a00000012	+	abbb12345	+

Unload Storage (7—UNL)

1. The unload instruction is used to place the contents of accumulator or auxiliary storage in memory.
2. The length of the field unloaded into memory is equal to the number of positions in the storage unit.
3. The right-hand character of the designated storage unit is unloaded into the memory position specified by the address part of the instruction. Remaining characters in storage are entered successively into memory from right to left until a storage mark is sensed.
4. The accumulator or auxiliary storage sign has no effect upon the data placed in memory.
5. The contents of accumulator or auxiliary storage are not affected.

EXAMPLES, UNLOAD

STORAGE	SIGN	MEMORY BEFORE	MEMORY AFTER
a3748	-	B0229	B3748
a450	+	1576	1450
aAB12	+	134CD	1AB12
ab\$bb	+	0000	b\$bb

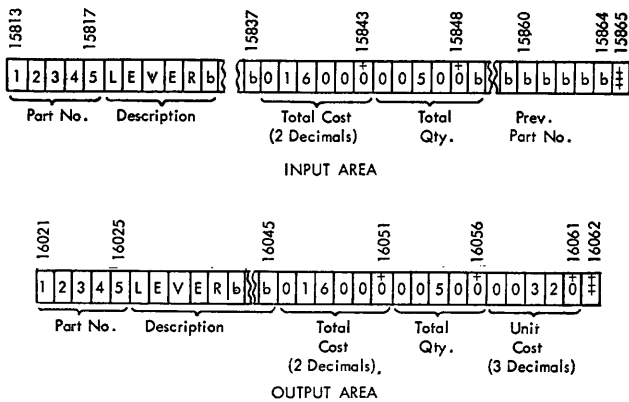

FIGURE 53. SEQUENCE CHECKING

Compare (4—CMP)

1. The compare instruction compares the contents of accumulator or auxiliary storage with the portion of memory specified by the address part of the in-

struction. The particular storage unit to be used is also specified by the address.

2. The comparison begins between the specified character in memory and the right-hand character of the designated storage unit. The comparison proceeds from right to left, character by character, between storage and memory until a storage mark is sensed. The results of the comparison are determined in the usual way; that is, the most significant characters are those on the left. The number of characters compared is equal to the number of positions in the storage field.

3. All characters that can appear in memory may be compared. The tape mark, drum mark, and storage mark do not normally appear in memory. The record mark and group mark can be compared. The ascending sequence of characters is as follows:

Blank & . □ ≡ — \$ * / , % # @ ⁺0
 A through I ⁰ J through R † S through Z
 0 through 9

4. The results of a comparison are made available in the program by means of two comparison indicators, high and equal (Figure 4). When the storage field is higher than memory, the high indicator is turned on. When the two fields are equal, the equal indicator is turned on. When the storage field is lower than memory, neither indicator is turned on.

5. The comparison indicators may be referred to in the program or "interrogated" by a special transfer instruction. For example, when a comparison turns on the high indicator, a following transfer-on-high instruction effects a transfer to the location of the program step specified by the transfer instruction. In this way, supplementary program routines may be introduced as a result of comparisons.

6. The machine contains only one pair of comparison indicators. They may be turned on by the results of comparisons in either accumulator or auxiliary storage units. Indicators are changed only by execution of a subsequent comparison step in the program. This step may also involve any storage unit. Indicators are not changed by interrogation and may be interrogated any number of times between comparisons.

7. Either the results of calculation or data loaded into storage may be compared against a portion of

memory. However, a calculated result appears in storage without a sign indication over the right-hand digit while a numerical field in memory usually appears with a signed right-hand digit. A comparison between such fields would be unequal because of the sign.

EXAMPLES, COMPARE

STORAGE	MEMORY	INDICATORS	
		HIGH	EQUAL
a1234 ⁺	\$1234 ⁺		On
a1234	\$1234 ⁺	On	
a1234 ⁺	\$2345 ⁺		
aTYPEb702	TYPEb701	On	
aSMITHbbb	WARFIELD		
aSMITHbbb	SMITHbbb		On
aSMITHbbb	JONESbbb	On	

Transfer on High (K—TRH)

1. The transfer-on-high instruction interrogates the high comparison indicator. When the indicator is on, the machine transfers to the instruction specified by the address part of the transfer-on-high instruction.

2. If the high indicator is not on, a transfer is not made and the machine proceeds to the next instruction.

3. The instruction can be used during any program step following a comparison.

4. The instruction can be used any number of times between comparisons without turning the indicator off.

Transfer on Equal (L—TRE)

1. The transfer-on-equal instruction interrogates the equal comparison indicator. When the indicator is on, the machine transfers to the instruction specified by the address part of the transfer on equal instruction.

2. If the equal indicator is not on, a transfer is not made and the machine proceeds to the next instruction.

3. The instruction can be used during any program step following a comparison.

4. The instruction can be used any number of times between comparisons without turning the indicator off.

Program, Sequence Checking

Figure 54 is the program for the problem shown in Figure 53.

0004. Adjust auxiliary storage unit 01 to one position.

0009. Load the group mark from location 15865.

0014. Unload group mark at end of input record. If records are out of sequence, the input area is written out on the typewriter.

0019. Unload group mark at end of output record. Records in sequence are written out from this area.

0024. Adjust auxiliary storage unit 02 to five positions. The five-position part number from each record is loaded into this unit for comparison with the preceding record.

0029. Adjust auxiliary storage unit 03 to 20 positions. This unit is used to monitor the transmission of part name from input to output area. Units 03 and 04 are coupled by this instruction.

0034. Select input tape unit.

0039. Read in the first record, beginning at memory address 15813.

0044. Load part number into ASU 02.

0049. Compare the input record part number with the part number from the previous record. The comparison for the first record is made against blanks and, therefore, is always high.

0054. When the input record is higher than the previous record, the records are in ascending sequence. The high indicator is turned on and a transfer is made to the instruction located in memory address 0074. When the input record is lower than, or equal to, the previous record, the high indicator is not turned on and the next instruction is executed without a transfer.

0059. A low or equal condition selects the typewriter.

0064. Write out the input record, beginning at memory address 15813.

0069. Transfer to read in another record.

0074. Unload the part number from ASU 02 into the working area. This instruction is reached only when records are in sequence.

0079. Unload the part number into the output area.

0084. Set MAC II to prepare to receive part name into the output area.

0089. Transmit part name to output area. ASU 03 is specified to limit transmission to 20 characters.

0094. Reset and add total cost into accumulator storage 00.

0099. Store total cost in output area.

0104. Adjust the accumulator storage 00 to nine positions to place three zeros to the left of the dividend.

0109. Lengthen the dividend by two zeros. The dividend is now four decimals to permit a three-decimal quotient with half adjustment.

0114. Divide total cost by quantity to get unit cost.

INSTR. LOCATION	INSTRUCTION		STOR. CODE	ACCUMULATOR 00	Z	AUXILIARY STORAGE 01-15	S
	OPER.	ADDRESS					
0004	SET	0001	01				
0009	LOD	5865	01				
0014	UNL	5849	01				
0019	UNL	6062	01				
0024	SET	0005	02				
0029	SET	0020	03				
0034	SEL	0200					
0039	RD	5813					
0044	LOD	5817	02			a12345	+
0049	CMP	5864	02				
0054	TRH	0074					
0059	SEL	0500					
0064	WR	5813	00				
0069	TR	0034					
0074	UNL	5864	02				
0079	UNL	6025	02				
0084	RCV	3026					
0089	TMT	5818	03				
0094	RAD	5843	00	a016000	+		
0099	ST	6051	00				
0104	SET	0009	00	a000016000	+		
0109	LNG	0002	00	a00001600000	+		
0114	DIV	5848	00	a003200	+		
0119	RND	0001	00	a00320	+		
0124	ST	3061	00				
0129	RCV	3052					
0134	TMT	5844	02				
0139	SEL	0200					
0144	RWW	5813					
0149	SEL	0201					
0154	WR	3021	00				
0159	TR	0044					

FIGURE 54. PROGRAM, SEQUENCE CHECKING

0119. Half adjust unit cost.
0124. Store unit cost in output area.
0129. Set MAC II to prepare to receive quantity into the output area.
0134. Transmit quantity to output area. ASU 02 is specified to limit transmission to five characters. The output record is now complete.
0139. Select input tape unit.
0144. Prepare to read while writing.
0149. Select output tape unit.
0154. Write output tape beginning at memory address 16021. Read in a new record beginning at address 15813.
0159. Transfer to load part number. Instructions in locations 0004 through 0029 are housekeeping instructions. Instructions in locations 0034 and 0039 are needed only for the first record, or to replace a record which is out of sequence.

END-OF-FILE PROCEDURES

EACH input or output unit in the 705 system, except the card punch and typewriter, is equipped with an indicator to signal an end-of-file condition. Whenever a unit is selected by a program instruction, the input-output indicator associated with that unit is also automatically selected. The instruction SEL 0200, therefore, not only selects a tape unit, but also selects the input-output indicator for that unit.

An indicator is either on or off. It may be turned on by any of the conditions listed under "Input-Output Indicators." Once an indicator is turned on, it remains on until it is turned off either by the program or by a manual operation.

The status of an indicator is tested or interrogated by a transfer-on-signal instruction in the program. This instruction usually follows immediately after reading or writing operations. When an indicator is turned on by an end-of-card-file, end-of-tape, or other condition, a transfer is made to an instruction location specified by the transfer-on-signal instruction. End-of-file instructions are normally included as subroutines in the program. When the indicator is off, a transfer on signal has no effect and the machine continues to the next instruction of the main program.

The end-of-file subroutine or branch program may be arranged in a variety of ways, depending upon operating conditions. For example, the typewriter may be used to notify the operator that a tape unit is in end-of-file condition. The machine may then be programmed to stop while reels are changed, or to automatically select an alternate unit and continue operation. Other control instructions may automatically rewind a completed reel.

By prearranged manual switch settings, the operator can, after putting in the last group of cards, make the machine automatically select program instructions to continue operation after an end of file has been signaled. Such operation might include final total calculation and printing.

When two or more tape units are being used to read or write a single file on multiple reels, an end-of-file signal on the first reel can change the select instruction address to specify the second tape unit. Reading or writing can continue on the second reel

without loss of operating time while the first reel is automatically rewound. Reading can continue alternately between two units until the installation of the last reel is noted by alteration switch setting.

When several related records are processed in or out of the system during the same procedure, an end of one input record file can cause program modification to consider only those records remaining to be processed. Calculation or reading steps for the completely processed records are then ignored.

INPUT-OUTPUT INDICATORS

THE PROBLEM illustrated in Figure 55 represents a simple end-of-file procedure using one input tape unit and one output tape unit. The input records are read into memory in the area shown and the total cost field is computed. When an end-of-file condition is signaled on either tape a transfer to a branch program is made where the proper reel is rewound, the tape mark is written, the operator is notified by typed instructions, and the machine is stopped to permit a reel change. A constant area is shown where the typed messages with group marks have been stored during program loading. It is assumed that there is only one reel of input tape. However, because the output record is longer than the input, the output tape might require two reels.

Photo-sensing Marker

Photo-sensing markers, also referred to as "reflective spots," are placed on the tape to enable the tape units to sense the beginning and ending of the writing spaces and to prevent writing off the end of the tape. The markers are small pieces of plastic, one inch by 3/16 inch, coated with vaporized aluminum on one side and with adhesive on the other. When they are pasted to the base (uncoated) side of the tape, reflected light from the bright surface of the spots is sensed by photoelectric cells as either the load point at the beginning of the reel or the physical end of the reel.

At least ten feet of tape must be allowed at the beginning of the reel as a leader for threading the

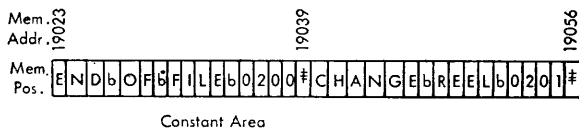
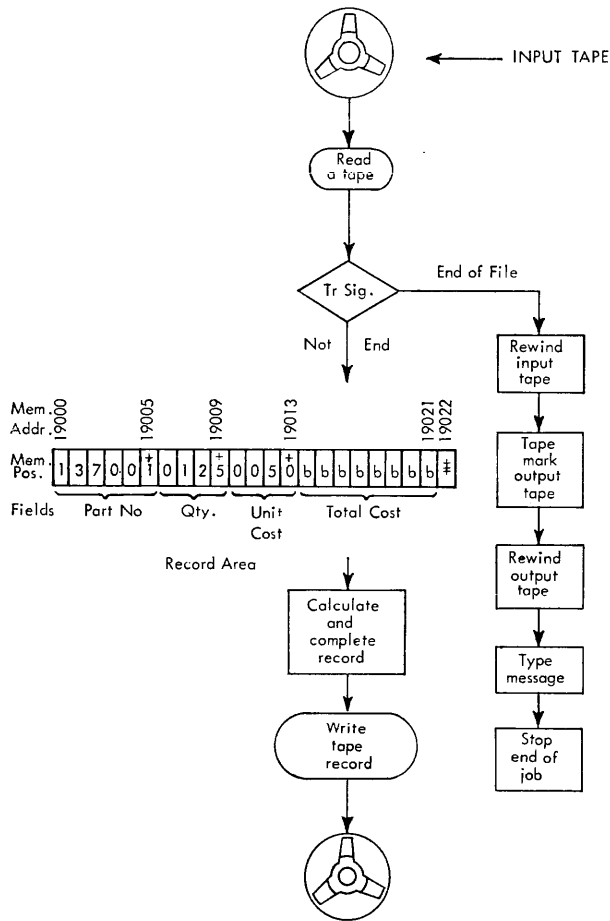

FIGURE 55. TAPE END OF FILE

tape over the feed rolls and the read-write heads. Information should not be recorded in this space. More than ten feet of leader may be allowed before writing, however, by placing a marker any desired distance from the end of the tape. The one-inch dimension of the marker must be parallel to the edge of the tape. To indicate load point, the marker must be no more than 1/32 of an inch from the channel 1 edge of the tape, the edge nearest the operator when the reel is mounted (Figure 56).

Approximately 18 feet of tape is also normally reserved between the end-of-reel marker and the end of the tape attached to the hub of the reel. This space includes at least ten feet of leader and enough tape to hold a record of 20,000 characters after the

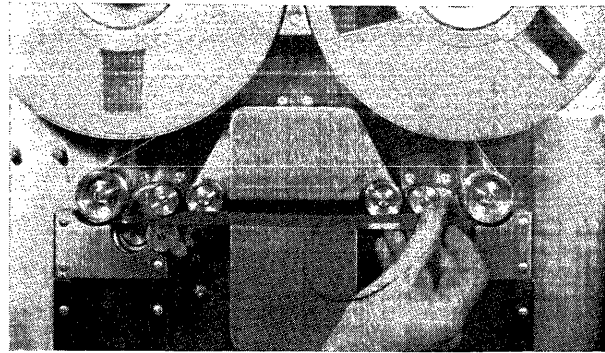

FIGURE 56. PHOTO-SENSING MARKER, LOAD POINT

end of the reel is sensed. Any useful length over ten feet may be allowed to permit writing additional records after the marker is sensed.

To indicate end of reel, the marker must be placed no more than 1/32 of an inch from the C channel edge of the tape, the edge nearest the tape unit when the reel is mounted (Figure 57).

The reflective spot turns on the tape unit input-output indicator *only* when it is placed in the end-of-reel position on the tape and when the tape unit is in write status.

Tape Mark

The tape mark is a special character written on tape when the end-of-reel marker is sensed or when the last record of a file has been written. It is emitted from the machine by a control instruction. The tape mark is a unit record of one character and is always written after the record gap (Figure 58).

The tape mark serves either as an end-of-file or end-of-reel indication when the tape is in read status. When sensed during the execution of a read instruc-

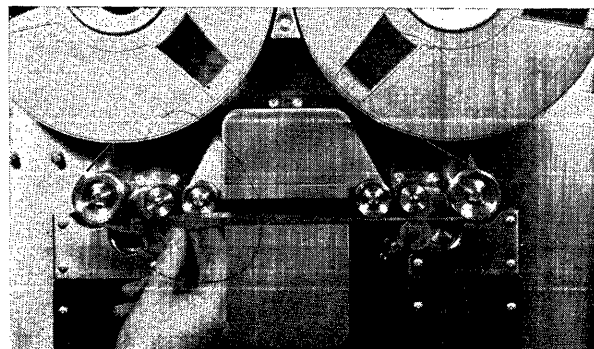

FIGURE 57. PHOTO-SENSING MARKER, END OF REEL

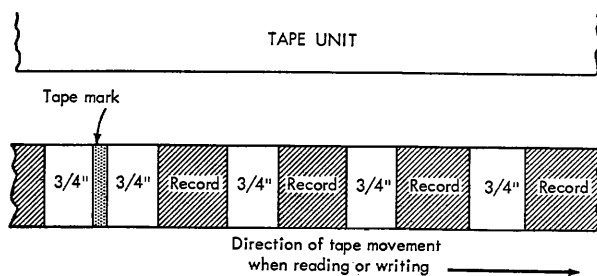

FIGURE 58. SCHEMATIC, TAPE MARK

tion, it turns on the input-output indicator. The mark is not transmitted into memory as a record.

Tape Unit Indicator

Each tape unit is provided with an input-output indicator which indicates the end of a reel or file. The indicator can be turned on by any of the following:

1. Sensing the end-of-reel marker while writing.
2. Sensing the tape mark as a unit record while reading.
3. Using an ION instruction in the program when a tape unit was last selected.

The indicator can be turned off by:

1. Depressing the unload key on the tape unit to remove the reel.
2. An IOF instruction in the program when a tape unit was last selected.

Card Reader Indicator

Each card reader is provided with an input-output indicator which is turned on when a read instruction involving that card reader is given after the last card has been read from record storage. The indicator is turned off by:

1. Loading record storage by feeding cards.
2. An IOF instruction when the card reader was last selected.

Printer Indicator

Each printer is provided with an input-output indicator which indicates the end of a page. It is turned on by the overflow signal obtained from channel 12 of the carriage control tape. The indicator is turned on after the next write instruction involving that printer is given (Figure 59). The indicator is turned off by:

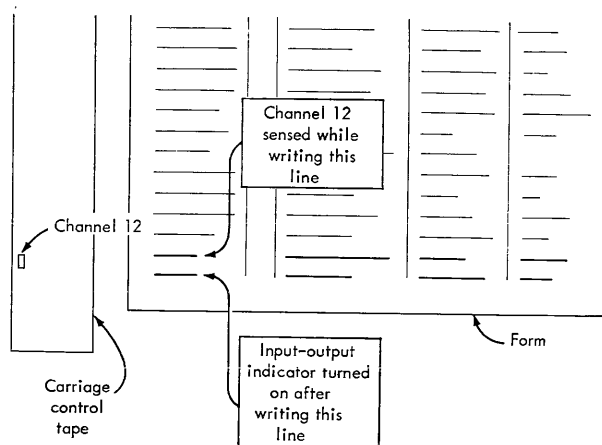

FIGURE 59. PRINTER INPUT-OUTPUT INDICATOR

1. Using an IOF instruction in the program when a printer was last selected.
2. Depressing the printer start key.

Drum Indicator

The input-output indicator of a drum is turned on if an attempt is made to read or write beyond the limits of the drum. The indicator is turned off by using an IOF instruction in the program when a drum section was last selected.

CONTROL INSTRUCTIONS

SIX CONTROL instructions control various features of the input-output units and turn on and off the input-output indicators. The control instruction always applies to the last selected unit. The address part of the control instruction specifies the feature to be controlled as follows:

Control 0000 (3—IOF)

The input-output indicator of the unit previously selected, if on, is turned off. This instruction refers to printers, tape units, drums, and card readers.

Control 0001 (3—WTM)

A tape mark is written on tape by the last selected unit. The writing of this special character is checked in the same way as the writing of characters from memory. (Refer to "Checking Procedures.")

Control 0002 (3—RWD)

The tape on the last unit selected is rewound.

Control 0003 (3—ION)

The input-output indicator on the *tape unit* last selected, if off, is turned on. The instruction may be used for tape units only.

Control 0004 (3—BSP)

The tape on the unit last selected is backspaced one unit record. An error in reading or writing can cause backspacing under program instruction.

Control 0005 (3—SUP)

This instruction applies to printers and punches only. It prevents printing or punching of information from record storage for one cycle. The instruction is normally used to prevent printing or punching when a read-write error has occurred from memory to record storage. Under program control, the record storage can be reloaded from memory after an error condition has been recognized and the corrected record printed or punched ("Checking Procedures").

Transfer-on-Signal (O—TRS)

The transfer-on-signal instruction causes a program transfer when the last previously selected indicator is on. The indicator may be an input-output indicator, an alteration switch, or a check indicator. The transfer is made to the memory address specified by the address part of the instruction.

When the transfer on signal is executed, the selected check indicator is automatically turned off. The input-output indicators are turned off as explained under "Control Instructions." The alteration switches are manually operated.

When the transfer-on-signal instruction address is coded for an auxiliary storage unit, it becomes a transfer-on-ready instruction for use with the Tape Record Coordinator. If a TRC is not connected to the 705, and the transfer-on-signal is coded for some auxiliary storage unit, no transfer will be made.

Stop (J—HLT)

Execution of this instruction stops the machine. Depressing the start key causes the machine to read and execute the next instruction.

Several stops may be included in a program for the convenience of the operator. An error in reading or writing, an end-of-file condition, or various other situations may be programmed to stop or "halt" operation. The address part of the stop instruction can be read from the console when a stop occurs. The address, therefore, may be coded to indicate to the operator why machine operation has been interrupted. In the following problem, HLT 0001 indicates the end of input file. Any address can be given to the instruction.

Program, End-of-File

Figure 60 is the program for end-of-file on input and output tapes.

0004. Adjust ASU 01 to one position.

0009. Get group mark.

0014. Put group mark at end of record.

0019. Select input tape 0200.

0024. Read the tape record.

0029. Transfer on signal. A transfer is effective when a tape mark is read as the last record from the input tape. The machine transfers to the end-of-file subroutine, beginning at location 0069.

INSTR. LOCATION	INSTRUCTION		STOR. CODE	ACCUMULATOR 00	Z	AUXILIARY STORAGE 01-15	Z
	OPER.	ADDRESS					
0004	SET	0001	01			OX	+
0009	LOD	9039	01			OX	+
0014	UNL	9022	01				
0019	SEL	0200					
0024	RD	9000					
0029	TRS	0069					
0034	RAD	9009	00	a0125	+		
0039	MPY	9013	00	a00000125	+		
0044	ST	9021	00				
0049	SEL	0201					
0054	WR	9000	00				
0059	TRS	0104					
0064	TR	0019					
0069	RWD						
0074	SEL	0201					
0079	WTM	0001					
0084	RWD						
0089	SEL	0500					
0094	WR	9023	00				
0099	HLT	0001					
0104	WTM						
0109	RWD						
0114	SEL	0500					
0119	WR	9040	00				
0124	HLT	0002					
0129	TR	0019					

FIGURE 60. PROGRAM, END OF FILE

0034. Reset and add the quantity field into accumulator 00.
0039. Multiply quantity by unit cost to get total cost.
0044. Store total cost in the record at address 19021.
0049. Select output tape 0201.
0054. Write out the record on tape.
0059. Transfer on signal. A transfer is effective when a reflective spot is sensed during a write operation. This may happen when the output unit runs out of tape before the input unit is at end-of-file.
0064. Transfer to repeat the program.
0069. Rewind the input tape. This instruction is executed when the transfer on signal has been activated by a tape mark on the input tape. In this case, all records in the file have been read.
0074. Select the output tape.
0079. Write a tape mark to record the end-of-file on the output tape.
0084. Rewind the output tape.
0089. Select the typewriter.
0094. Write out the message that the input tape is at end-of-file.
0099. Stop the machine for the end of the job.
0104. Write a tape mark on the output tape when a reflective spot has been sensed while writing the output record.
0109. Rewind the output tape.
0114. Select the typewriter.
0119. Write a message to the operator to change reels on the output tape unit.
0124. Stop the machine to permit the operator to change reels.
0129. After the reel change, depressing the start key transfers the machine to repeat the program and continue operation.

BALANCE FORWARD BY ADDING TO MEMORY

THE RECORDS illustrated in Figure 61 are used in an inventory control procedure. Three records are involved.

1. The inventory record is on tape in ascending sequence by part number. The record includes fields for stock balance and quantity of parts on order, required and available.

Stock Balance + On Order — Requirements = Available.

2. Requirements records are on cards, in sequence by part number. The record shows the quantity of a given part required during a particular period to meet a production schedule. Requirements are to be entered in the proper field on the corresponding inventory control record and a new availability is to be calculated. Credit availability indicates that not enough parts are in stock and on order to meet requirements. A group mark and record mark are wired from the control panel of the card reader.

3. When credit availability is indicated, a signal card is punched with a record of the balance to indicate that additional parts must be ordered. Because the numerical fields of the tape record are signed both plus and minus, it is necessary to remove the plus sign before punching an order, to conform to other card records with which the signal card is to be processed.

Figure 61 shows in flow chart form the memory areas assigned to records and an outline of the steps to be followed in the procedure. It is assumed that there is only one inventory record for each part number and that all requirement records match. However, each inventory record may not have a corresponding requirement record.

Add to Memory (6—ADM)

1. The add-to-memory instruction adds a field in accumulator or auxiliary storage to a field in memory. The storage unit and the memory field are specified by the address part of the instruction.
2. The result replaces the original memory field.
3. The field in storage is unchanged.

The fields from storage may be added to memory in two ways depending upon whether the memory field is signed or unsigned.

Signed Memory Field. The addition follows the rules of algebra. The addressed field in memory starts with its right-hand signed digit and continues to the left until a non-numerical character is reached. Any carry-over of the result beyond the position of the next non-numerical character in memory is ignored and the overflow check indicator is *not* turned on. Only numerical portions of the character

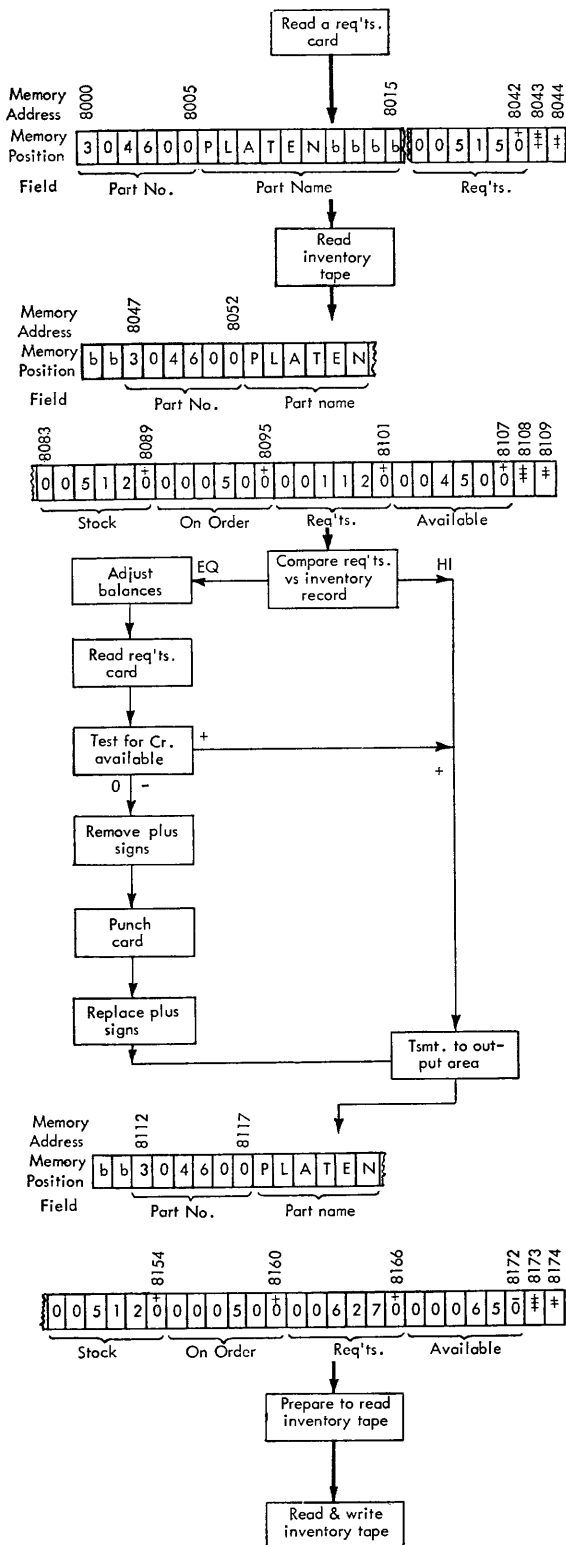

FIGURE 61. BALANCE FORWARD

in storage are added. Both plus and minus fields in storage may be added. The proper sign of the result is placed over the addressed character in memory.

EXAMPLES, ADD TO MEMORY (SIGNED FIELDS)

ACC. OR AUX. STORAGE	SIGN	MEMORY BEFORE	MEMORY AFTER
a33	+	5663	5696
a25	-	5425	5400
a625	+	4676	4301
a676	-	4625	4051
a12676	-	4625	4051
a12121	-	B456	B335
a3	+	A&	A3

Unsigned Memory Field. The addition is not algebraic. It begins with the right-hand digit of accumulator or auxiliary storage and the addressed character in memory and continues from right to left until the storage mark is reached.

When non-numerical characters, including blanks, are encountered in the memory or storage fields, both zones and digits are added. The zone positions of the characters are added separately as binary numbers. Any carry-over is added to the next high-order zone position, except a carry beyond the last character of the storage field into the position of the storage mark, which is disregarded.

The numerical parts of the characters are added decimally. Any carry-over is added only to the numerical part of the next high-order position, except a carry-over beyond the last character of the storage field into the accumulator or auxiliary storage mark.

Any carry from the numerical portion of the last character of the field is binarily added to the zone of that character. Any carry from the zone of the last character is disregarded.

The three possible zones are indicated in the following example by placing binary notation over the numerical portion of the character. The zero zone is numbered 01, the eleven zone 10, and the twelve zone 11. In binary, this corresponds to zones 1, 2, and 3, respectively.

EXAMPLES, ADD TO MEMORY (UNSIGNED FIELD)

ACC. OR AUX STORAGE	SIGN	MEMORY BEFORE	MEMORY AFTER
00 00		00 00 00 00	00 00 00 00
a 4 0	+	W 1 2 3 4	W 1 2 7 4
a 0 9 0 0	+	R 0 1 1 1 1	R 0 2 0 1 1
a 9 9 0 0	+	R 0 1 1 1	R 0 0 1 1
a &	+	2 6	2 6
a -	-	2 6	2 6
a 9 9 0 0	+	R 0 1 1 1	R 0 0 1 1

Sign (T—SGN)

1. The sign instruction is used to remove any zone from a memory character and place it in accumulator or auxiliary storage as an ampersand or dash. The character affected and the storage unit used are specified by the address part of the instruction.

2. When the zoning of the addressed character in memory is minus, a dash (minus zone) is placed in the storage unit and the storage sign is set to minus.

3. When the zoning of the addressed character in memory is other than minus, an ampersand (plus zone) is placed in storage and the storage field length is set to one position. The storage sign is set to plus.

4. The addressed character remains in memory with 00 zoning unless that character is an ampersand (&), a dash (—) or a blank. In these cases, the character remaining in memory is a blank.

5. The sign placed in accumulator or auxiliary storage as an ampersand (plus) or a dash (minus) may be given to any character in memory that is not already zoned. The add-to-memory is used for this purpose and the character to be signed is specified by the address part of the add to memory instruction.

EXAMPLES, SIGN

BEFORE			AFTER		
ACC. OR AUX. STORAGE	SIGN	MEMORY CHARACTER	ACC. OR AUX. STORAGE	SIGN	MEMORY CHARACTER
a123456	+	B	a&	+	2
aEDPM	+	R	a—	—	9
a&	+	4	a—	—	4
a16AB	—	4	a&	+	4
a16AB	+	&	a&	+	b
a16AB	+	—	a—	—	b
a16AB	+	b	a&	+	b

Transfer on Plus (M—TRP)

1. The transfer on plus instruction causes a program transfer when the sign of accumulator storage or the sign of the auxiliary storage units is plus (Figure 4). The address part of the instruction specifies the memory location of the next instruction to be executed after the transfer. The address must also specify either accumulator storage (00) or any of the auxiliary storage units (01-15).

Transfer on Zero (N—TRZ)

1. The transfer on zero instruction causes a program transfer when the zero indicator of accumulator storage or of the auxiliary storage units is turned on. The accumulator zero indicator is turned on when the contents of accumulator storage consists of characters having zero numerical portions. The auxiliary storage units zero indicator is turned on when the contents of the last used unit consists of characters having zero numerical portions (Figure 4). These characters are zero, plus or minus signed zero, and the record mark (Figure 121).

2. The address part of the instruction specifies the memory location of the next instruction to be executed after the transfer. The address must also specify either accumulator storage (00) or any of the auxiliary storage units (01-15).

3. When a storage field consists of characters having zero numerical portions, the sign indicator is set to plus. Therefore, if a distinction is to be made between zero and plus, the transfer on zero must precede the transfer on plus.

Note: As a result of an incompleting division operation, the accumulator contents may be zero with the minus sign of the replaced dividend. See "Divide."

Program, Add to Memory and Sign

Figure 62 is the program for the problem illustrated in Figure 61.

0004. Select card reader 0100.

0009. Read the first requirements record into memory beginning at address 8000.

0014. Adjust ASU 01 to two positions.

0019. Prepare to receive at address 8108.

0024. Transmit the group mark and record mark to addresses 8108 and 8109, respectively. ASU 01 is specified to limit transmission to two single characters.

0029. Adjust ASU 01 to six positions.

0034. Select input tape unit 0200.

0039. Read the first inventory control record into memory beginning at address 8047.

The above instructions are used only once during the procedure to adjust storage units and place the first two records in memory.

0044. Load the part number from the requirements record into ASU 01. The storage unit was

INSTR. LOCATION	INSTRUCTION		STOR. CODE	ACCUMULATOR 00	SIGZ	AUXILIARY STORAGE 01-15	SIGZ
	OPER.	ADDRESS					
0004	SEL	0100					
0009	RD	8000					
0014	SET	0002	01			axx	+
0019	RCV	8108					
0024	TMT	8043	01				
0029	SET	0006	01			axxxxxx	+
0034	SEL	0200					
0039	RD	8047					
0044	LOD	8005	01			a304600	+
0049	CMP	8052	01				
0054	TRH	0154					
0059	RAD	8042	02			a005150	+
0064	ADM	8101	02				
0069	RSU	8042	02			a005150	-
0074	ADM	8107	02				
0079	SEL	0100					
0084	RD	8000					
0089	RAD	8107	02			a000650	
0094	TRZ	0104	02				
0099	TRP	0154	02				
0104	SGN	8089	03			a&	+
0109	SGN	8095	04			a&	+
0114	SGN	8101	05			a&	+
0119	SGN	8107	06			a-	+
0124	SEL	0300					
0129	WR	8047					
0134	ADM	8089	03				
0139	ADM	8095	04				
0144	ADM	8101	05				
0149	ADM	8107	06				
0154	RCV	8114					
0159	TMT	8049	00				
0164	SEL	0200					
0169	RWW	8047					
0174	SEL	0201					
0179	WR	8112	00				
0184	TR	0044					

FIGURE 62. PROGRAM, BALANCE FORWARD

positioned to six positions at instruction location 0029.

0049. Compare requirements record part number against inventory control part number.

0054. Transfer to instruction location 0154 when requirements part number is higher than inventory control part number. When comparison is equal, no transfer is made and the machine continues to the following instruction.

0059. Reset and add the requirements quantity from the requirements record into ASU 02.

0064. Add the requirements quantity to the inventory control record requirements field in memory location 8101.

0069. Reset and subtract the requirements quantity from the requirements record into ASU 02.

0074. Subtract the requirements quantity from the inventory control record available field in memory location 8107.

0079. Select card reader 0100.

0084. Read the requirements record into memory beginning at address 8000.

0089. Reset and add the adjusted inventory control available field in ASU 02.

0094. When the available quantity is zero, transfer to punch a signal card at instruction location 0104.

0099. When the available quantity is plus, transfer to transmit the inventory control record to the output area.

0104, 0109, 0114, 0119. Remove signs from the inventory control record fields and store in ASU's 03, 04, 05 and 06, respectively.

0124. Select card punch 0300.

0129. Punch a card, beginning at memory location 8047.

0134, 0139, 0144, 0149. Replace the signs over the inventory control record fields from ASU's 03, 04, 05 and 06, respectively.

0154. Prepare to receive at address 8049.

0159. Transmit the inventory control record to the output area. Transmission is by five-character groups, including group and record marks, because accumulator storage 00 is specified.

The total number of characters is not divisible by 5; therefore, two blanks are also included in the record.

0164. Set input tape unit 0200.

0169. Prepare to read while writing.

0174. Select output tape unit 0201.

0199. Read an inventory control record beginning at memory location 8047. Write a record from the output area beginning at memory address 8112.

0184. Transfer to instruction location 0044 to load in the new part number from the card record and repeat the program.

Sign Storage for Auxiliary Storage Units

Because all auxiliary storage units share the same sign indicator, the sign of a result developed in one unit may be changed by subsequent calculation involving other units.

Figure 63 illustrates a method of storing the sign of an ASU in memory where it can be referred to at any point later in the program. Memory location 18009 is reserved for the storage of the sign of ASU 07 after the execution of a subtract instruction. Any available location can be used to store the sign as a plus or minus over any single digit. In Figure 63,

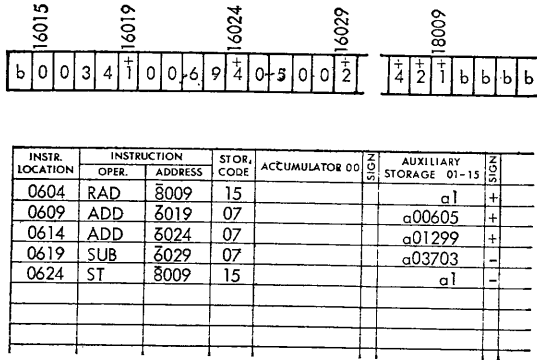

FIGURE 63. SIGN STORAGE, AUXILIARY STORAGE UNITS

the operation is begun with a plus one in memory position 18009.

0604. Reset and add the plus one in ASU 15. The sign trigger for all auxiliary storage units is now plus, including ASU 07.

0609, 0614, 0619. Obtain a result in ASU 07 by adding and subtracting the factors shown in memory. The sign trigger is now set to minus because there is a minus factor in ASU 07.

0024. Store the one in ASU 15 in memory location 18009 with the minus sign developed by the subtract operation in ASU 07. The condition of the sign trigger is now stored for use later in the program.

END-OF-FILE, READ WHILE WRITING

THE PROBLEM shown in Figure 61 may also be used to illustrate the end-of-file procedure for read-while-writing operations.

Assume that the input-output units used are one card reader, one input tape and one output tape unit. The input tape file may be on more than one reel; therefore, the output tape is also on multiple reels. Figure 64 is a flow chart of the end-of-file routines.

When either input or output tape units sense the end of file, the operator is properly notified, the machine is stopped for reel change, and normal operation continues after the change. When the operator loads the last input reel, an alteration switch is set accordingly, and the machine transfers to an end-of-file routine and stops for the end of job.

Alteration Switch

Six alteration switches are provided on the operator's console with addresses of 0911 to 0916 inclusive. The operator may turn them on or off manually.

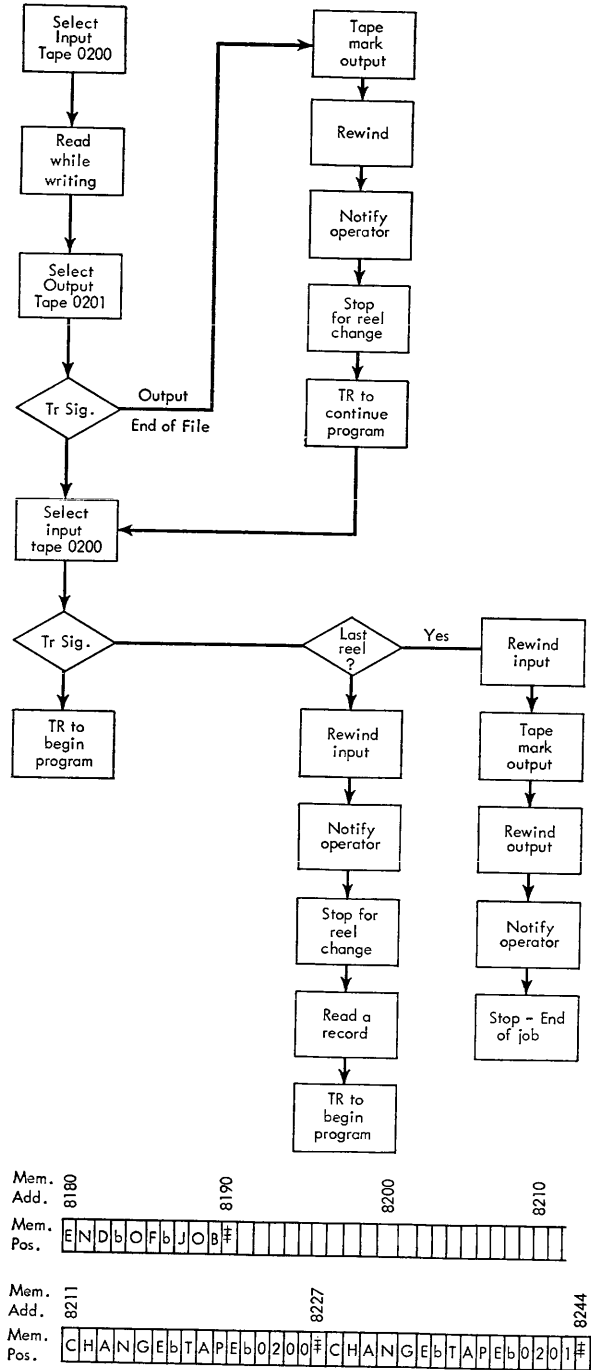

FIGURE 64. END OF FILE

Switches are selected in the program in the same manner as any other component in the 705 system. Any switch can be specified by the address part of a select instruction.

A transfer-on-signal instruction may test the condition of a selected switch in the program. When the

switch is on, a transfer is made to the memory location specified by the address part of the transfer-on-signal instruction. When the switch is off, no transfer is made and the machine proceeds with the next program instruction.

Program, End-of-File

Figure 65 is the program for end-of-file shown in Figure 64. The program is written as added instructions to the balance forward program in Figure 62.

0164. Select the input tape.

0169. Prepare to read while writing.

0174. Select the output tape.

0179. Write the output tape; read the input tape.

0184. Transfer on end-of-file signal from the output tape. The transfer is effective only when the end of file is sensed on the output tape because 0201 was the last unit selected.

0189. To test for end of file on input tape, unit 0200 is reselected.

0194. Transfer if an end-of-file signal was sensed from input tape during the read-while-writing operation.

0199. No end of file; transfer to repeat the program.

END OF OUTPUT FILE

0204. Write a tape mark on the output tape.

0209. Rewind the output tape.

0214. Select the typewriter.

0219. Write a message to the operator; change the reel.

0224. Stop while the reel change is made.

0229. Transfer to continue the program (Figure 62).

END OF INPUT FILE

0234. Select alteration switch 0911.

0239. Transfer if the switch is on, indicating that this is the end of the last reel of input.

0244. Select the input tape.

0249. Rewind the input tape.

0254. Select the typewriter.

0259. Write a message; change the reel.

0264. Stop while the reel change is made.

0269. Select the input tape.

0274. When the end of file is sensed, a tape mark is read as a unit record. A single read instruction must be given to read in the next record for processing.

0279. Transfer to repeat the program.

END OF JOB

0284. Select input tape unit 0200.

0289. Rewind the input tape.

0294. Select output tape unit 0201.

0299. Write a tape mark.

0304. Rewind the output tape.

0309. Select the typewriter.

0314. Write the end-of-job message.

0319. Stop for end of job.

INSTR. LOCATION	INSTRUCTION		STOR. CODE	ACCUMULATOR 00	Z SIG	AUXILIARY STORAGE 01-15		Z SIG
	OPER.	ADDRESS						
0164	SEL	0200						
0169	RWW	8047						
0174	SEL	0201						
0179	WR	8112						
0184	TRS	0204						
0189	SEL	0200						
0194	TRS	0234						
0199	TR	0044						
		End of Output File						
0204	WTM							
0209	RWD							
0214	SEL	0500						
0219	WR	8228						
0224	HLT	0001						
0229	TR	0189						
		End of Input File						
0234	SEL	0911						
0239	TRS	0284						
0244	SEL	0200						
0249	RWD							
0254	SEL	0500						
0259	WR	8211						
0264	HLT	0002						
0269	SEL	0200						
0274	RD	8047						
0279	TR	0044						
		End of Job						
0284	SEL	0200						
0289	RWD							
0294	SEL	0201						
0299	WTM							
0304	RWD							
0309	SEL	0500						
0314	WR	8180						
0319	HLT	0003						

FIGURE 65. PROGRAM, END OF FILE

END OF FILE, TRANSFER ANY

THE TEST for an end-of-file condition during a read-while-writing operation may be simplified in the main program routine by the use of a transfer-any instruction.

Transfer Any (I—TRA)

1. The transfer-any indicator is turned on whenever an input-output or check indicator is turned on.
2. When the indicator is on, a transfer is made to the memory location specified by the address part of the instruction.
3. The transfer-any indicator is turned off by the transfer itself.

Program, End-of-File

Figure 66 is the program using transfer any to test for end of file during a read-while-writing operation. Figure 61 shows the records.

- 0164. Select input tape 0200.
- 0169. Prepare to read while writing.
- 0174. Select output tape 0201.
- 0179. Write the output tape.
- 0184. Transfer if any input output indicator has been turned by the read-while-writing operation. A

transfer is also effective if any check indicator has been turned on.

0189. No indicator is on. Transfer to repeat the program.

0194. The output tape is the last selected unit. If the input-output indicator of that unit is on, a transfer is made to end-of-file routine for output tape (Figure 65).

0199. When the indicator for the output unit is not on, select the input unit to test for end of file.

0204. Transfer to the end-of-file routine for the input tape if the indicator is on (Figure 65).

0209. Transfer to routine to test for error indicators, if desired.

INSTR. LOCATION	INSTRUCTION		STOR. CODE	ACCUMULATOR 00	Z 0 5	AUXILIARY STORAGE 01-15	Z 0 5
	OPER.	ADDRESS					
0164	SEL	0200					
0169	RWW	8047					
0174	SEL	0201					
0179	WR	8112					
0184	TRA	0194					
0189	TR	0044					
0194	TRS						
0199	SEL	0200					
0204	TRS						
0209	TR						

FIGURE 66. PROGRAM, END OF FILE, TRA

CHECKING PROCEDURES

ACCURACY is an essential requirement of the data-processing system. To meet this requirement the 705 provides various checking devices. The programmer can use these devices entirely at his own discretion. Two types of checks may be made:

1. Checks upon the handling of data within the machine, including the check for legitimate instructions, overflow, sign and character coding. Sign and overflow check indicators have been previously referred to in the section "Arithmetic Instructions."
2. Checks upon the reading and writing of data by input-output units.

CHECK INDICATORS

THIS section contains schematic diagrams of the input-output checking methods, descriptions of the various check indicators, and problems illustrating how checking is included in the program.

The 705 has six check indicators to provide the operator with a check on the accuracy of data being processed. These indicators are associated with separate switches on the operator's console.

In many cases, it is not necessary to interrupt machine operation when an error condition is detected. The programmer can include special branch programs to handle certain types of errors as exceptions. An error in reading a record from tape, for example, may be programmed to backspace the tape and reread the record. If a correct reading is obtained the second time, normal machine operation continues. If the error persists, machine operation can be interrupted or the incorrect record can be noted and operation continued.

The indicator switch setting on the operator's console gives the choice of programming around an error or stopping the machine. When a switch is set to AUTOMATIC, the error detected by the corresponding check indicator causes an automatic machine stop. To resume operation, the indicator may be turned off by depressing the start key on the console.

When a switch is set to PROGRAM, the corresponding check indicator may be interrogated during the program and an error does not automatically stop the machine. The particular instruction during which the error is detected is carried out and the machine proceeds to the next instruction.

A check indicator is interrogated by two instructions: select, followed by transfer on signal. The select instruction specifies the proper indicator. The transfer-on-signal address transfers the program to the first instruction of a subroutine which is to be followed if an error is detected. The transfer is made only when the indicator has been turned on by an error condition. Machine operation is not interrupted when the error is corrected by the branch program. The transfer-on-signal instruction turns the indicator off.

Check indicators and their assigned addresses are:

Instruction Check Indicator	0900
Machine Check Indicator	0901
Read-Write Check Indicator	0902
Record Check Indicator	0903
Overflow Check Indicator	0904
Sign Check Indicator	0905

Instruction Check Indicator 0900

The instruction check indicator turns on when:

1. A character code error is detected during instruction time.
2. An invalid operation part is encountered going to the operation register.
3. The operation part is incorrectly interpreted.
4. The units position of the address part of any transfer instruction, or a transmit instruction specifying accumulator 00, is not 4 or 9.

It is recommended that the switch associated with this indicator be turned to AUTOMATIC to cause a machine stop when an error is detected. Programming around this type of error is usually impractical. With the switch set to AUTOMATIC, the machine stops during the character cycle in which the error occurred.

Machine Check Indicator 0901

The machine check indicator is turned on when a character code error is detected during the execution of all instructions (except read) in which data are transferred from accumulator or auxiliary storage or memory. These instructions include:

ADD	MPY	ST	WR	SET
SUB	DIV	SPR	WRE	SHR
RAD	LOD	ADM	SGN	RND
RSU	UNL	TMT	CMP	LNG
				NTR

When the indicator switch is turned to AUTOMATIC, the machine stops during the character cycle in which the error occurred except if an error occurs during the execution of write or write and erase. In this case, the indicator will be turned on but no automatic stop will occur. Such an error may be detected by programming. The read-write check indicator will also be turned on.

Read-Write Check Indicator 0902

The read-write indicator turns on when a character code error is detected during the execution of a read, write, read-while-writing, or write-and-erase instruction. The indicator also turns on when an error is detected in reading the holes in the card or by the longitudinal check in tape reading. The indicator, therefore, checks the transmission of data from all input units to memory. It also checks the transmission of all output data from memory to the drum, tape unit, card punch record storage, printer record storage, and typewriter. The indicator turns on if an attempt is made to read or write beyond the limits of the drum or if an error occurs in recording a tape mark.

When the indicator switch is turned to AUTOMATIC, an error stops the machine after the instruction is executed.

Record Check Indicator 0903

The record check indicator turns on when an error is detected by the brush-compare method on the punch and by the echo-check method on the printer. An error in card punching is detected as the card passes a brush station after it has been punched. If an error occurs, the record check indicator turns on during the execution of the next write or write-

and-erase instruction to that card punch.

An error in printing is detected by sensing the position of each print wheel during the print cycle. If an error occurs, the indicator turns on during the execution of the next write or write-and-erase instruction involving that printer.

In both cases, when the switch for this indicator is on AUTOMATIC, an error stops the machine at the end of the punching or printing cycle during which the indicator was turned on. At this time the error card is the last card to go into the punch stacker. The incorrect line of printing immediately precedes the last printed line.

Overflow Check Indicator 0904

The overflow check indicator is turned on during an add or subtract operation when the number of digits in the result is greater than the number of digits in the longer of the two fields. An overflow is indicated as a result of a round operation, if a carry-over is made out of the high-order position of the accumulator storage field.

The indicator is turned on by a divide instruction when the divisor does not have a greater absolute value than an equal number of digits taken from the left end of the dividend. When the error switch for this indicator is turned to AUTOMATIC, an error stops the machine during the execution of the instruction.

Sign Check Indicator 0905

The sign check indicator turns on if a field addressed by a reset and add, add, reset and subtract, subtract, multiply, or divide instruction does not have plus or minus zoning over the right-hand digit.

When the switch for this indicator is on AUTOMATIC, an error stops the machine during the character cycle following the one in which the error was detected.

INPUT DATA CHECKS

Card Reader

The 705 checks all information read from IBM cards automatically in two ways (Figure 67).

1. At the first read station, the number of holes in each horizontal row of the card, for the columns wired from the control panel, is determined to be

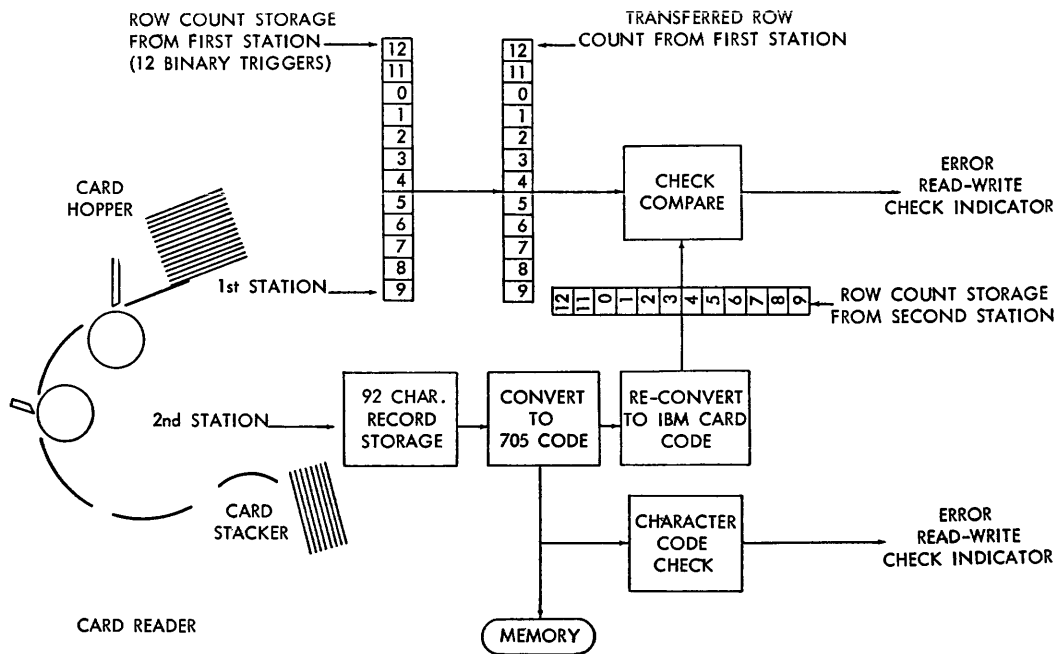

FIGURE 67. CARD INPUT CHECK

odd or even. This information is stored, one row at a time, in a temporary storage device consisting of 12 binary triggers. Each trigger can indicate only one of two possible conditions, odd or even. When the card has passed the first station, the odd-even count for all 12 rows is transferred to a second set of triggers where it is retained during the next card cycle. The first set of triggers is then free to accept the row count for the following card. The information at the first station is used only for checking.

At the second read station, the card columns wired from the control panel are stored in record storage. When a read instruction is given, the card record in record storage is converted to the 705 character code and is sent to memory. The 705 code is also re-converted to the IBM card code and an odd-even count is again made of each row. This information is stored in a third set of 12 triggers and is compared with the count obtained and stored when the card was read at the first read station. A difference in comparison turns on the read-write check indicator.

2. The card record read from record storage into memory is given the same character-by-character check as that given all data handled within the machine. An error also turns on the read-write check indicator. Note that if the indicator is turned on, it will be after the complete card record has been read from record storage into memory.

Tape Unit (Read)

The machine automatically checks all information read from tape in two ways (Figure 68).

1. A character code check is made on each character of information entering memory from the tape unit. This is a vertical check, character by character, to insure that an even number of ones on the tape have been sensed and transmitted correctly by the read head. An error turns on the read-write check indicator.

2. An even count check is made on each of the seven tape channels at the end of every record. This is a horizontal check to insure that the entire record has been correctly sensed and transmitted by the read head. A failure turns on the read-write check indicator. Seven neon indicators on the tape control unit show in which of the seven channels a reading failure occurs. Note that the read-write indicator is turned on after the complete tape record in which an error occurred has been read into memory.

OUTPUT DATA CHECKS

Card Punch

All punching of IBM cards by the 705 is automatically checked in two ways (Figure 69).

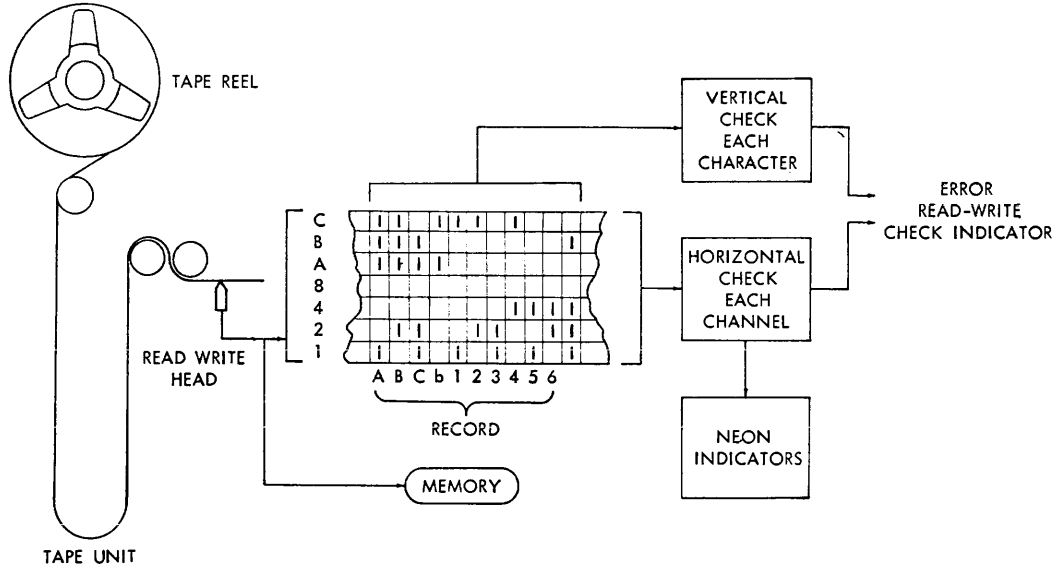

FIGURE 68. TAPE INPUT CHECK

1. A card record to be punched from memory when a write instruction is given is first converted from the 705 character code to the IBM card code. The entire record is stored in an 80-column record storage unit. During this operation, the machine determines whether the number of holes in each horizontal row of the card record is odd or even. The row count information is temporarily stored by an arrangement of 12 binary triggers. Each trigger can indicate one of the two conditions, odd or even.

Trigger storage is identical with the storage de-

scribed for the card reader. The row count is transferred to a second set of triggers where it is retained until the next write instruction is given. The first set of triggers is then free to accept a row count for the next record from memory. The card is punched at the punch station.

When the next write instruction is given, the card passes the punch brushes. Again the machine determines whether the number of holes in each horizontal row is odd or even. This row count of the punched card is transferred, one row at a time, to a third

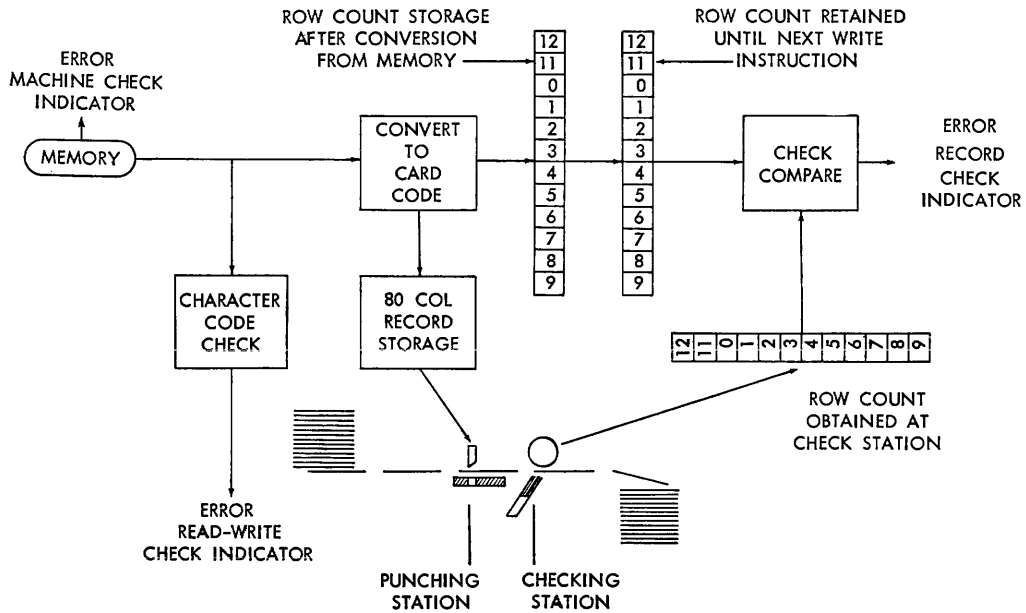

FIGURE 69. CARD OUTPUT CHECK

set of 12 triggers. The row count is compared with the count obtained and stored when the record was read from memory. An error turns on the record check indicator.

2. The record to be punched is also given a character-by-character check, when transmitted to record storage, in the same way as for all data handled within the machine. An error turns on the read write check indicator. Note that the read-write check indicator turns on before the card record is punched. If the indicator is interrogated by a transfer-on-signal instruction immediately following the write instruction, punching can be prevented by an SUP instruction. Record storage can then be reloaded with the same record and another trial for error can be carried out. Punching can be prevented until record storage is correctly loaded.

If a character code error exists in the data being transmitted from memory to record storage, the machine check indicator is also turned on.

The record check indicator is turned on after the card in error has passed the brush station.

Printer

All printing of information from the 705 is checked in two ways (Figure 70).

1. The record to be printed from memory is converted from the 705 character code to IBM card code and is stored in a 120-character record storage unit. A horizontal row count is taken for the numerical portion of the entire record. The result is stored by

11 binary triggers. Each trigger indicates one of two conditions, odd or even, for each row of impulses making up the characters for the entire record. Nine triggers store the count for the rows one through nine; two store the count for special characters. The record is then printed from record storage as one line of characters on the report form.

The characters printed are read back from the printer by sensing the position of each print wheel during the print cycle. A row count of the impulses from the numerical portions of all characters in the printed record is determined and the result is stored as odd or even by 11 triggers. A comparison is made with the count obtained and stored when the record was read from memory. A difference in comparison turns on the record check indicator.

2. The record to be printed is also given a character-by-character code check when it is transmitted to record storage, as are all data handled within the machine. An error in this transmission turns on the read-write check indicator.

Note that the read-write check indicator turns on when an error is detected from memory to record storage. If the indicator is interrogated by a transfer-on-signal instruction immediately following the write instruction, an SUP instruction can delay printing. Record storage can then be reloaded for a second trial for printing. This corresponds to a punching delay when a write instruction is given to the card punch. Printing can be prevented until record storage is correctly loaded.

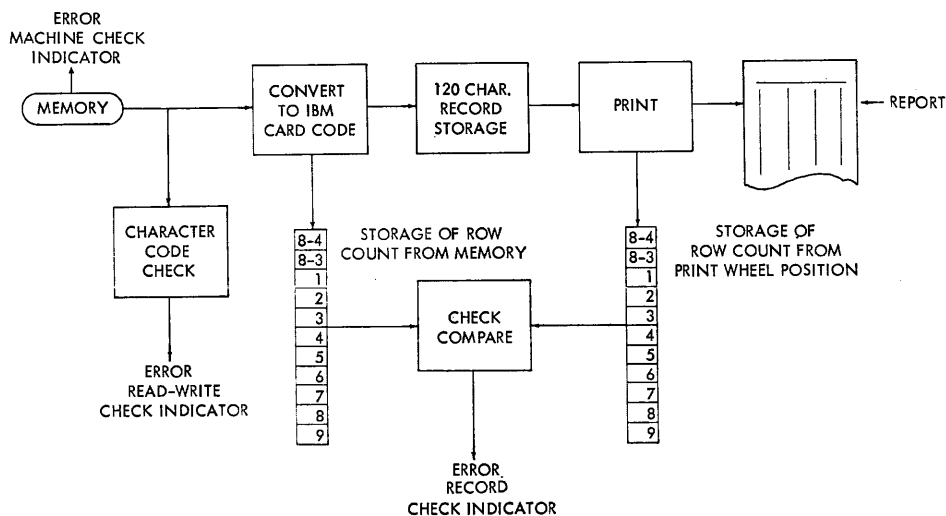

FIGURE 70. PRINTING CHECK

If a character code error exists in the data being transmitted from memory to record storage, the machine check indicator is also turned on.

A printing error turns on the record check indicator during the execution of the next write instruction involving that printer.

Tape Unit (Write)

The 705 also checks automatically all information written on tape (Figure 74).

Records read from memory to tape are transmitted directly through the tape control unit to the write head. The records are written magnetically in the 705 character code in the seven tape tracks (Figure 12). While a record is being written, the machine makes an odd-even check of the total number of ones in each separate track. At the end of every record an extra one is inserted where necessary to make the total count in each track even. The check for an even number of ones is made whenever the tape record is read.

The impulses to the write heads from memory are returned to a register in the control unit in the same pattern in which they were received. From there they are transmitted back to the 705. The same character-by-character check is given these "echo" impulses as is given all data handled within the machine.

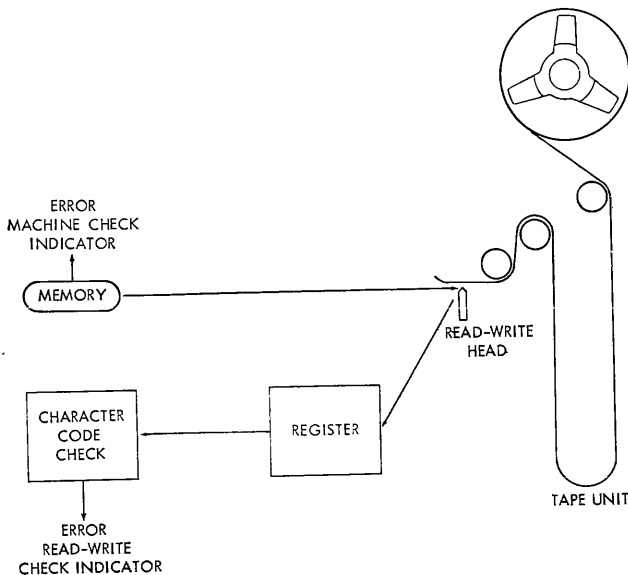

FIGURE 71. TAPE OUTPUT CHECK

An error turns on the read-write check indicator after the execution of the write instruction. In addition, if a character code error exists in the data being transmitted from memory to tape, the machine check indicator is also turned on.

Program, Error Correction

The record shown in Figure 72 is read from tape. After each read operation, a check is made for a read-write error. If an error is discovered, the tape is backspaced and the record is reread. If the error persists, the tape is backspaced and read a third time. The machine stops if an error occurs the third time.

Salesmen's commissions are computed when records are read correctly and the completed record is written on tape. Assume that constants are in memory as shown. Figure 73 is the program.

- 0004. Adjust ASU 01 to one position.
- 0009. Get group mark.
- 0014. Put group mark at end of record.
- 0019. Reset and add a 2 in ASU 02.
- 0024. Select input tape record 0200.
- 0029. Read the tape record into memory beginning at address 8014.
- 0034. Select the read-write check indicator.
- 0039. Test the condition of the indicator by a transfer-on-signal instruction. If the indicator is on, an error in reading has occurred and a transfer is made to the correction routine in the program.
- 0044. Reset and add commission percentage.
- 0049. Multiply: Percent by sales amount to get commission amount.
- 0054. Round to adjust the commission amount to the nearest cent.
- 0059. Adjust the commission amount to five positions.
- 0064. Store commission amount.
- 0069. Select output tape 0201.
- 0074. Write the completed record.
- 0079. Transfer to repeat the program.

Memory Address	1001	1002	1003	1004	8014	8016		8023	8025		8030	8031										
Memory Positions	b	2	1	#	3	6	9	0	0	3	7	6	5	0	0	3	b	b	b	b	b	
Fields	Constants				Sales No.			Sales Amt.			Comm. %		Comm. Amt.									
	Record Area																					

FIGURE 72. ERROR CORRECTION

INSTR. LOCATION	INSTRUCTION		STOR. CODE	ACCUMULATOR 00	Z	AUXILIARY STORAGE 01-15	Z
	OPER.	ADDRESS					
0004	SET	0001	01				
0009	LOD	1004	01			a#	
0014	UNL	8031	01				
0019	RAD	1002	02			a2	+
0024	SEL	0200					
0029	RD	8014					
0034	SEL	0902					
0039	TRS	0084					
0044	RAD	8025	00	a03	+		
0049	MPY	8023	00	a000112950	+		
0054	RND	0002	00	a0001130	+		
0059	SET	0005	00	a01130	+		
0064	ST	8030	00				
0069	SEL	0201					
0074	WR	8014	00				
0079	TR	0019					
Correction Routine							
0084	SEL	0200					
0089	BSP						
0094	SUB	1003	02			a1	+
0099	TRP	0029	02				
0104	HLT	0001					

FIGURE 73. PROGRAM, ERROR CORRECTION

CORRECTION ROUTINE

- 0084. Select input tape 0200.
- 0089. Backspace the input tape.
- 0094. Subtract 1 from ASU 02 to count the reread.
- 0099. Transfer to reread when ASU 02 is plus.
- 0104. ASU 02 is not plus. The record has been read three times. Stop the machine.

Program, Error Correction with End of File

Figure 75 illustrates a program written to provide for end-of-file condition and read-write checking when processing either input or output records.

Assume that a tape record is read into memory locations 19000-19105 inclusive (Figure 74). A check is made for both end of file and read-write error. When the end of file is sensed, the input tape is rewound and the machine stops. When an error occurs in reading, the record is read twice more. When the error persists, machine operation stops.

After calculation (omitted from the program), the completed record is written on the printer. Writing is checked for a read-write error when loading record

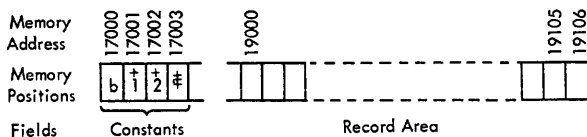

FIGURE 74. END OF FILE AND ERROR CORRECTION

storage and for a record error from record storage to the print wheels (Figure 70). Machine operation is stopped after three errors have occurred while loading record storage or it is stopped for any record error.

- 0004. Adjust ASU 01 to one position.
- 0009. Get a group mark.
- 0014. Put a group mark in the record.
- 0019. Get plus 2 in ASU 01.
- 0024. Get plus 2 in ASU 02.
- 0029. Select the input tape.
- 0034. Read the record.
- 0039. Transfer when any indicator has been turned on during a read operation.

INSTR. LOCATION	INSTRUCTION		STOR. CODE	ACCUMULATOR 00	Z	AUXILIARY STORAGE 01-15	Z	
	OPER.	ADDRESS						
0004	SET	0001	01					
0009	LOD	7003	01			a#	+	
0014	UNL	9106	01					
0019	RAD	7002	01			a2	+	
0024	RAD	7002	02			a2	+	
0029	SEL	0200						
0034	RD	9000						
0039	TRA	0429						
0044								
↓								
0404	Main Routine							
0409	SEL	0400						
0414	WR	9000						
0419	TRA	0489						
0424	Main Routine							
Input End of File and Error Correction								
0429	SEL	0902						
0434	TRS	0449						
0439	SEL	0200						
0444	TRS	0474						
0449	SEL	0200						
0454	BSP							
0459	SUB	7001	01			a1	+	
0464	TRP	0034	01					
0469	HLT	0001						
0474	RWD							
0479	HLT	0002						
0484	TR							
Output End of File and Error Correction								
0489	SEL	0901						
0494	TRS	0529						
0499	SEL	0902						
0504	TRS	0539						
0509	SEL	0903						
0514	TRS	0564						
0519	SEL	0400						
0524	TRS	To end-of-page routine						
0529	HLT	0003						
0534	TR	0409						
0539	SEL	0400						
0544	SUP							
0549	SUB	7001	02			a1	+	
0554	TRP	0414	02					
0559	HLT	0004						
0564	HLT	0005						

FIGURE 75. PROGRAM, END OF FILE AND ERROR CORRECTION

- 0044. Continue with main routine of program.
- 0404. This is the last step of the main routine.
- 0409. Select the printer.
- 0414. Write the completed record on the printer.
- 0419. Transfer when any indicator has been turned on during a write operation.
- 0424. Continue with program.

INPUT END OF FILE WITH ERROR CORRECTION

- 0429. Test for read-write error.
- 0434. With 0920 on, transfer to reread input record.
- 0439. Reselect input tape unit.
- 0444. Test for end of file and transfer if input-output indicator is on.
- 0449. Reselect input tape.
- 0454. Backspace one record.
- 0459. Count record backspaced.
- 0464. Reread record if counter is plus.
- 0469. Stop if counter is minus.
- 0474. Rewind input tape.
- 0479. Stop for reel change or end of job.
- 0484. Transfer to read first record of new reel or to end-of-job routine.

OUTPUT END OF FILE WITH ERROR CORRECTION

- 0489. Test for machine error.
- 0494. With 0901 on, transfer to stop for correction.
- 0499. Test for read-write error.
- 0504. When 0920 is on, transfer to rewrite output record.
- 0509. Test for record error.
- 0514. With 0903 on, transfer to stop for correction.
- 0519. Reselect printer.
- 0524. Test for end of page. If input-output indicator is on, transfer to end-of-page routine.
- 0529. Machine error. Stop for manual control.
- 0534. If error is corrected, transfer to rewrite. If record cannot be corrected, transfer to reread and recompute.
- 0539. Reselect the printer.
- 0544. Suppress printing.
- 0549. Count one error.
- 0554. Transfer to rewrite if counter is plus.
- 0559. Stop if counter is minus.
- 0564. Stop for record error.

SYSTEMS CHECKS

SYSTEMS checks can be defined as any checks other than those made by the built-in check circuits in the 705. This is a broad category and includes such programmable checks as record counts, hash totals, control totals, proof figures, limit checks, and crossfooting balance checks. All of these checks can be programmed easily and are powerful tools for program checking.

The systems checks which are to be incorporated in a program should be designed during the original planning phase. At this time all of the needed information is available and any necessary changes in the logic of the program can be made easily. What kind of systems check to use depends upon the program to be checked. Systems checks designed for a specific program generally are unique to that program. Some general techniques applicable to any program are described here.

Record Count

A record count is simply a count of the number of records in a file. This count is made each time the file is written and is carried as an additional record at the end of the file. The count is made again when the file is being read for processing to see that all records in the file have been read in.

Hash Total

A hash total is a total of an important numerical or alphanumerical field (such as part number) for all records. It checks that all of the records written on the last processing run have been read in during the present cycle. It is similar to a record count, except that the hash total gives an additional check that all part numbers have been read in correctly. The hash total is carried as an additional record at the end of the file. This total may be computed as the original tape is written, or during a subsequent machine run.

The hash total may also be computed for certain vital fields in a single record. This total is carried as an additional field in each record and can be checked whenever that record is read into memory. Hash totals must be accumulated by use of the add-to-memory instruction if alphanumerical fields are part of the total.

Control Total

A control total is a predetermined total of some amount or quantity field in a file of records. During the processing, a sum of this field is accumulated and checked against the control total. The control total can be in the form of a grand total for all input data, or an intermediate or minor total for each control group in the file. An example of the use of control totals is a simple payroll where a predetermined total is made of the employee hours per pay period. During the processing of the payroll, a total of hours per employee is accumulated and at the end of the program, the two totals are compared.

Proof Figures

Proof figures are sometimes used to check an important multiplication in a program. The proof figure is usually additional information carried in the record. An example of this is the multiplication of quantity by cost required in grocery billing. The check is based on a relationship between cost and a so-called proof cost. An arbitrary fixed figure Z , larger than any normal cost, is set up. Then the proof cost is expressed by the formula: $\text{Cost} + \text{proof cost} = Z$

When quantity is multiplied by cost, it is also multiplied by proof cost. Normally, two of the totals needed for the check, quantity and quantity times cost, are accumulated during the program. The other factor needed for the check (quantity times proof cost) is also accumulated in the program. Now it is possible at any point to check as follows:

$$\begin{aligned} \Sigma (\text{Quantity} \times \text{Cost}) + \Sigma (\text{Quantity} \times \text{Proof Cost}) \\ = \Sigma (\text{Quantity} \times Z) \end{aligned}$$

The left side of the equation can be calculated by a single addition of the two progressive totals accumulated during the program. The right side of the equation can be calculated by a multiplication of the accumulated quantity and the factor Z . This check insures that each particular multiplication was performed correctly. This type of check applies to other applications by the same general approach, that of adding check information.

Limit Check

A limit check is the test of a field in a record or a total in the program to see if certain predetermined

limits have been exceeded. An example of this would be a transaction code which is known to include only numbers 0 through 5. In the program, a check should be made to see that the code does not exceed 5.

Another limit check applies to reasonableness. For example, certain totals are known to vary not more than 10 per cent between processing cycles. This check can be easily programmed.

A further use of this check is in a table look-up operation. If a value is known to be in a given table, the modified table address may be checked against the address of the upper table value to verify correctness of the search. If the search begins to exceed the limits of the table, an error has occurred and corrective action should be taken.

Crossfooting Balance Checks

Crossfooting balance checks are useful in many programs. An example is in payroll calculation. During the processing of each record in a payroll, independent totals are accumulated of gross pay, taxes, social insurance, deductions, and net pay. These totals can be crossfooted and checked at any point in the program. For example, the total gross pay at any point should equal total net pay, plus total deductions, social insurance, and taxes.

Preventive Maintenance

The 705 system is efficiently maintained by a competent staff of engineers equipped with the latest techniques and devices. Daily, they run exhaustive diagnostic and test programs with machine voltages set at marginal levels to detect and remove any elements which are on the verge of deterioration. Elements which fail at marginal voltage levels probably would still operate correctly at the regular voltage levels. However, replacing them at this point provides extra safety during 705 operation. Each control unit for the various input-output units has a special customer engineering test station to aid servicing. Also, each component unit (card reader, printer, and so on) can be adequately tested and maintained independently of the central processing unit. The central processing unit itself is supplied with complete marginal test facilities. These preventive maintenance test facilities and procedures can relieve the system

of any fixed errors and greatly reduce the possibility that intermittent errors will occur during a subsequent operating run. Therefore, the 705 checking procedures assume that only infrequent, intermittent errors or transient errors should occur during operation.

Payroll, Gross to Net

The payroll record shown in Figure 76 is written on magnetic tape and is used as input data on tape unit 0200. The following calculations are included in the program.

- Withholding tax = [gross pay - (tax class × 13.00)] × 18%. If no tax is deducted, zeros are entered into the tax space in the record.
- Withholding year-to-date = previous period tax-to-date + current tax.
- FICA = 2% of gross earnings, provided previous gross does not equal or exceed \$4200.00. If earnings this period make year-to-date gross equal to or over \$4200.00, then only the difference between previous year-to-date gross and \$4200 is taxable.
- Quarter-to-date FICA = previous tax-to-date + current tax.
- Year-to-date gross = current gross + previous year-to-date gross.
- Net pay = gross - withholding - FICA.

The output record is also written on tape. A read-while-writing operation is used to increase tape reading and writing speeds. Constant data are stored in memory as shown. Figure 77 is the program.

Program, Payroll Gross to Net

- 0004, 0009, 0014. Place the group mark at the end of the output record.
- 0019, 0024. Place four zeros in ASU 01.
- 0029, 0034. Place three zeros in ASU 02.
- 0039. Select the input tape unit.
- 0044. Read the first record.
- 0049, 0054. Transmit the input record to the output area.
- 0059. Get withholding tax class.
- 0064. Tax class × 1300 = exemption amount.
- 0069. Compare the difference between exemption

Memory Address	1000	1003	1005	1006	1012	1013		
Memory Position	1	3	0	0	1	8		
Constants								
Mem. Pos.	1	3	4	8	9	6		
Mem. Pos.	2	5	4	1	5	0		
Mem. Pos.	0	0	0	3	5	7		
Mem. Pos.	4	2	9	4	5	1		
Mem. Pos.	8	5	7	5	8	5		
Mem. Pos.	7	5	7	5	8	5		
Fields	Pay Per.	Man No.	Tax Cl.	Yr-to-date gross	Yr-to-date with.	Quar. FICA	Gross pay	R. M.

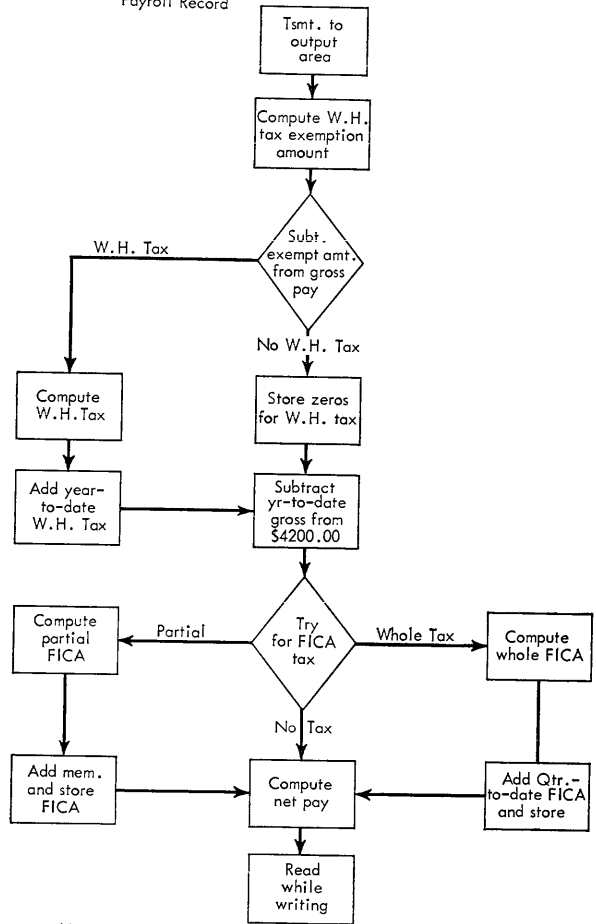

Mem. Addr.	12020	12021	12026	12027	12033	12039	12043	12048
Mem. Pos.	1	3	4	8	9	6	2	5
Mem. Pos.	4	3	3	5	7	5	0	3
Mem. Pos.	5	7	4	8	3	0	4	5
Mem. Pos.	1	8	5	7	5	8	5	7
Fields	Pay Per.	Man No.	Tax Cl.	Yr-to-date gross	Yr-to-date with.	Quar. FICA	Gross pay	
Memory Address	12052	12055	12060	12061				
Memory Position	2	1	7	4	1	0	0	1
Memory Position	6	1	6	3	0	1	#	
Fields	W.H. tax	FICA	Net pay					

FIGURE 76. PAYROLL, GROSS TO NET

amount and gross. If plus, this is the taxable amount for withholding tax. If it is minus or zero, no tax is taken.

INSTR. LOCATION	INSTRUCTION		STOR. CODE	ACCUMULATOR 00	Z (0) (1)	AUXILIARY STORAGE 01-15	Z (0) (1)
	OPER.	ADDRESS					
0004	SET	0001	01			ax	
0009	LOD	1013	01			a#	+
0014	UNL	2061	01				
0019	RAD	1012	01			a420000	+
0024	SET	0004	01			a0000	+
0029	RAD	1012	02			a420000	+
0034	SET	0003	02			a000	+
0039	SEL	0200					
0044	RD	1150					
0049	RCV	2024					
0054	TMT	1154	00				
0059	RAD	2027	00	a5	+		
0064	MPY	1003	00	a06500	-		
0069	ADD	2048	00	a12075	+		
0074	TRZ	0084	00				
0079	TRP	0094	00				
0084	ST	2052	01				
0089	TR	0119					
0094	MPY	1005	00	a0217350	+		
0099	RND	0002	00	a02174	+		
0104	SET	0004	00	a2174	+		
0109	ST	2052	00				
0114	ADM	2039	00				
0119	RAD	1012	00	a420000	+		
0124	SUB	2033	00	a005000	+		
0129	TRZ	0139	00				
0134	TRP	0149	00				
0139	ST	2055	02				
0144	TR	0199					
0149	SUB	2048	00	a013575	-		
0154	TRP	0169					
0159	ADD	2048	00	a005000	+		
0164	TR	0174					
0169	RAD	2048	00	a18575	+		
0174	MPY	1006	00	a001000	+		
0179	RND	0002	00	a00100	+		
0184	SET	0003	00	a100	+		
0189	ST	2055	00				
0194	ADM	2043	00				
0199	RAD	2048	00	a18575	+		
0204	ADM	2033	00				
0209	SUB	2052	00	a16401	+		
0214	SUB	2055	00	a16301	+		
0219	ST	2060	00				
0224	SEL	0200					
0229	RWW	1150					
0234	SEL	0201					
0239	WR	2020	00				
0244	TR	0049					

FIGURE 77. PROGRAM, PAYROLL GROSS TO NET

0074. Test for zero taxable amount. Transfer to store zeros.

0079. Test for plus exemption amount. Transfer to multiply by 18%.

0084. Store zero; remainder is minus.

0089. Transfer to calculate FICA.

0094. Multiply the plus exemption amount by 18% to get withholding tax amount.

0099. Round the tax amount to nearest cent.

0104. Adjust the tax amount to four positions.

0109. Store the tax amount in the output record.

0114. Add tax to year-to-date withholding in the output record.

0119. Reset and add 420000.

0124. Subtract the previous year-to-date gross from 420000. If the result is zero or minus, no FICA tax is to be taken. If the result is plus, whole or partial tax is taken.

0129. Test for a zero result. Transfer to store zeros.

0134. Test for a plus result. Transfer to try for whole or partial tax.

0139. Store zeros in the FICA field of the output record when the result is minus.

0144. Transfer to calculate net pay.

0149. Subtract the current gross from the result obtained at 0134. When this result is plus or zero, the whole FICA tax is taken.

0154. Test for a plus result. Transfer to calculate FICA.

0159. The result is minus. Add back the current gross to obtain the partial gross taxable for FICA.

0164. Transfer to calculate partial FICA.

0169. Get current gross pay.

0174. Multiply the result in accumulator storage by 2% to obtain either the whole or partial FICA tax.

0179. Round the tax amount to the nearest cent.

0184. Adjust the tax amount to three places.

0189. Store the FICA tax in output record.

0194. Add to quarter-to-date FICA tax.

0199. Get the current gross for calculation of net pay.

0204. Add the current gross to year-to-date gross in the output record.

0209, 0214. Gross — withholding tax — FICA = net pay.

0219. Store net pay in the output record.

0224. Select the input tape unit.

0229. Read while writing.

0234. Select the output tape unit.

0239. Write the output record and read the input record.

0244. Transfer to transmit the input record to the output memory area.

TABLE LOOK-UP

MANY types of procedures include as a basic operation the matching of detail transactions against a previous balance record. Usually the purpose of associating detail with balance records is to revise the balance to include the detail. In IBM accounting practice, three main steps are involved:

1. Arranging the detail in sequence by some field common to both detail and balance forward cards.
2. Matching and merging the detail with the balance forward records by a common field.
3. Summarizing to revise the balance forward and also printing a report to record new balances.

Other preliminary procedures may involve a separate coding operation where, instead of a balance record, a table look-up is required. This may be necessary to price, code, classify, or perform calculations on detail transactions before they are associated with balance cards. Three main steps are also involved in this procedure:

1. Arranging the detail in sequence by some field common to the detail and the table cards.
2. Matching and merging detail with table cards.
3. Transcribing a factor from the table to the detail card by gang punching or reproducing.

In clerical operations, the preliminary step of sorting the detail items is often omitted. Only the table, catalog, ledger or reference material is arranged in sequence. Detail items are compared one at a time against the reference material by looking down the left-hand column of the table until the matching field is discovered.

If the operation is a table look-up, a transcription is made from the table to the detail transaction. In a posting operation, the detail item is posted to the balance record and a new balance is calculated.

Drum Storage

Drum storage may be used in the 705 for both table look-up and balance forward operation. From one to thirty magnetic drum storage units are available with the 705, each with a maximum capacity of 60,000 characters.

While the drum is revolving at high speed, information can be written magnetically on its surface in much the same manner as data are recorded on tape. Also, as on tape, recording is permanent and may be retained after the power is turned off. Writing over a section erases any information previously written.

Each drum is divided into 300 addressable sections and each section can store up to 200 characters. The average time required to locate the first character position of a section by a reading or writing operation is 8 milliseconds. Thereafter, characters can be read from or written consecutively on the drum at a rate of .040 milliseconds per character.

The drum is called into use by a select instruction. The address part of the instruction specifies the section to be operated upon. Addresses 1000-1299 specify the sections on the first drum, addresses 1300 to 1599 the sections on the second drum, 1600 to 1899 the third drum, and so on.

A read, write, or write-and-erase operation may follow the select instruction. Information is read from the drum starting with the first character of the section specified by the select instruction. It is read into memory, starting with the memory position specified by the reading instruction. Reading continues until a drum mark is sensed.

Information is written on the drum from memory, starting with the memory location specified by the write instruction. The first character from memory is written in the first position of the drum section specified by the select instruction. Writing continues until a group mark is sensed. The writing operation then stops and a drum mark is placed on the drum in the next higher storage position.

Reading or writing can pass from one drum section to another until a drum or group mark is sensed. An attempt to read or write beyond the limit of the drum turns on the read-write check indicator and also the drum input-output indicator used especially to detect this error. The input-output indicator is turned off by a subsequent read, write or write-and-erase instruction for the drum, or it may be turned off by an IOF instruction. A select and transfer-on-signal instruction turns off the read-write indicator.

Drum Search (Table Look-up) Problem

The following problem illustrates table look-up combined with balance-forward calculation. The problem also shows how instructions may be modified according to conditions encountered when each record is read into memory.

The cost of each labor ticket in a cost accounting procedure is to be applied against its proper shop order account number. Each labor ticket is an IBM card, punched with the shop order number, a suffix number, and cost (Figure 78).

The cumulative costs of all open shop orders are stored on the magnetic drum. In each drum section there are 13 seven-digit shop order numbers in ascending sequence with their associated costs. A control number of 9999999 is stored after the last cost in each section.

The suffix number of the labor ticket is the address of the proper drum section where the corresponding costs are stored. As each labor ticket is read into the 705, the correct drum section is selected and read into memory. The labor ticket is then compared against the drum record by order number, until the matching number is located. Cost is adjusted for this number and the series of job numbers is again stored on the drum. If the order number is not found in

the drum section selected, the control 9's cause a transfer to a subroutine in the program where the unmatched labor ticket is punched out as an error transaction.

The loading program for putting balance-forward records on the drum is not included in this problem. A typical card record with matching drum record is shown below. Assume that required constant data have been placed in the machine by the loading procedure. Figure 79 is the program.

CARD RECORD

FIELD	NO. OF CHARACTERS	EXAMPLE	ADDRESS
Man no.	5	07163	4001-4005
Shop order no.	7	QR7170B	4012
S. O. suffix	4	1206 ⁺	4016
S. O. cost	5	00941 ⁺	4021
Group mark	1		4022

DRUM RECORD

FIELD	NO. OF CHARACTERS	EXAMPLE	ADDRESS
S. O. no.	7	QR5133A	2001-2007
Cost	7	0012395 ⁺	2014
S. O. no.	7	QR7170B	2021
Cost	7	0048636 ⁺	2028
Other S. O. no. and cost			2029-2182
Control no.	7	9999999	2189
Group mark	1		2190

CONSTANTS

Address of first drum S. O. no.	5	b2007 ⁺	5004
Factor to adjust compare address	4	0014 ⁻	5008
Factor to adjust cost address	4	0007 ⁺	5012
Group mark	1		5013

Program, Drum Search

HOUSEKEEPING

- 0004. Set ASU 01 to one position.
- 0009. Get group mark from constant area.
- 0014, 0019. Place group mark at the end of the card and drum record areas.
- 0024. Get the address of the first shop order number in the drum record in ASU 02. The address is used to reset the compare instruction address each time a new card record is read.
- 0029, 0034. Get the constants 0014 and 0007 for

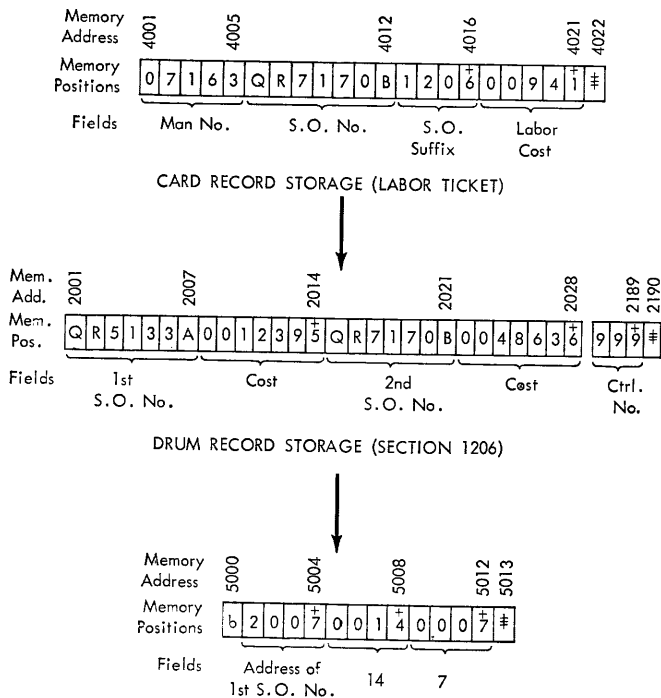

FIGURE 78. DRUM SEARCH

INSTR. LOCATION	INSTRUCTION		STOR. CODE	ACCUMULATOR 00	Z (0) (1)	AUXILIARY STORAGE 01-15	Z (0) (1)
	OPER.	ADDRESS					
Housekeeping							
0004	SET	0001	01			ax	
0009	LOD	5013	01			a#	+
0014	UNL	2190	01				
0019	UNL	4022	01				
0024	RAD	5004	02			a2007	+
0029	RAD	5008	03			a0014	+
0034	RAD	5012	04			a0007	+
0039	SET	0004	05			axxxx	
0044	UNL	0094	02				
Read Records							
0049	SEL	0100					
0054	RD	4001					
0059	RAD	4016	06				
0064	UNL	0074	06				
0069	UNL	0159	06				
0074	SEL	[1206]					
0079	RD	2001					
Compare Card to Drum Record							
0084	SET	0007	00				
0089	LOD	4012	00				
0094	CMP	[2007]	00				
0099	TRH	0124					
0104	TRE	0134					
Error							
0109	SEL	0300					
0114	WR	4001	00				
0119	TR	0044					
High Comparison							
0124	ADM	0094	03				
0129	TR	0094					
Equal Comparison							
0134	ADM	0094	04				
0139	LOD	0094	05				
0144	UNL	0154	05				
0149	RAD	4021	00	a00941			+
0154	ADM	[2028]					
0159	SEL	[1206]					
0164	WR	2001					
0169	TR	0044					

FIGURE 79. PROGRAM, DRUM SEARCH

use in adjusting the compare and add-to-memory instruction addresses for searching the drum record and adjusting the shop order cost.

0039. Set ASU 04 to four places.

0044. Reset the address of the compare instruction at address 0094.

READ RECORDS

0049. Select the card reader 0100.

0054. Read a card record into memory.

0059. Get the suffix number from the card record.

This is the drum section where the shop order number QR7170B is stored.

0064, 0069. Unload the address of the drum section into a select instruction at location 0074 and 0159.

0074. Select the drum section given by the labor ticket suffix number.

0079. Read the drum section into memory.

COMPARE CARD TO DRUM RECORD

0084. Set accumulator 00 to seven positions.

0089. Get the shop order number from the labor ticket.

0094. Compare the labor ticket shop order number to the first shop order number on the drum record.

0099. When the comparison is high, transfer to adjust the compare instruction address 14 positions. This is the address of the second shop order number on the drum record.

0104. When the comparison is equal, transfer to adjust the compare instruction address seven positions. This is the address of the corresponding cumulative cost on the drum record.

0109. When the comparison is low, all job numbers on the drum section have been compared and the labor ticket is being compared against 9999999.

SELECT THE CARD PUNCH

0114. Punch out the unmatched labor ticket as an error.

0119. Transfer to reset the compare instruction address and read another card.

HIGH COMPARISON

0124. Add 14 to the compare instruction address from ASU 03.

0129. Transfer to compare against the next shop order number. This loop is repeated until an equal or low comparison is made.

EQUAL COMPARISON

0134. The address of the compare instruction at 0094 is now the address of the matched shop order number on the drum record. Add seven to this address to obtain the address of the cumulative cost.

0139. Load the address of cumulative cost into ASU 05.

0144. Place the address of cumulative cost into the add-to-memory instruction at 0154.

0149. Get the cost from the labor ticket.

0154. Add the cost from the labor ticket to the cumulative cost in the drum record.

0159. Select the drum section corresponding to the labor ticket shop order number suffix.

0164. Write the drum record on the selected section.

0169. Transfer to repeat the program.

Table Look-up, Binary Search

A second method of searching a table may be used, which approximates clerical filing precedures. In such a filing or searching operation, the search through any given file or table usually begins at some index point nearest to a particular item. From this point, a trial search is made at the center of a group between index points. For example, in manually searching for an item in a file cabinet of punched cards, the first search is in the drawer which is indexed to include the item. The second step would be to examine a particular card at about the center of the drawer in relation to the item being looked for. If the card examined in the drawer is higher than the item looked for, it may be assumed that the desired item is in the lower section of the drawer (assuming that the cards in the drawer are in ascending sequence by the item control field). Conversely, if the card examined is lower than the item looked for, the desired item is in the upper section of the drawer.

In the 705, the index point may specify a drum section or sections. The desired portion of the table may then be "pulled out" into memory to make the detailed search. However, instead of beginning the search with the first item of the table in memory, the program may direct the machine to proceed directly to the item at the center. A comparison is then made to determine whether the desired item is in the upper or lower half of the table.

When it has been determined which half of the file contains the item being searched for, this portion of the file is again divided in half and the process is repeated. The machine successively reduces the area of search by halves until the item is located.

The following formulas express this method of search.

$$1. \frac{N_0 + 1}{2} = N_1 \text{ (rounded)}$$

$$2. \frac{N_1}{2} = N_2 \text{ (rounded)}$$

$$3. \frac{N_2}{2} = N_3 \text{ (rounded)}$$

N_0 is the number of items in the table. N_1, N_2, N_3 , etc., represent the location in the table of the successive search operations. To adapt the formula for machine use, several facts about the table must be established.

1. The reference portion of the items in the table must be in ascending sequence.

2. The length of all the items in the table, including the reference facts, should be equal. The search in memory is conducted by modifying the addresses of various instructions. This modification must be by a fixed number of memory positions.

3. The number of factors in the table must be known in order to reserve the proper space in memory for a given portion of the table.

4. The address in memory of both the first and last items in the table must be known in order to limit the search to the specific portion of memory in which the table is located.

Figure 80 shows the arrangement of 8 items in memory as a simple table. Using the binary search formula, locate the number 14. The necessary constants are as follows:

CONSTANT DATA	EXAMPLE	MEMORY ADDRESS
Number items in table		
plus one ($N_0 + 1$)	+	
	b9	0500
Constant .5	+	
	5	0501
Length of items	+	
	02	0503
Calculating address for		
searching the table	+	
	0399	0507
Number to be located		
in the table	+	
	14	0509
Minus one	-	
	01	0513
Constant one	01	0513
Address of first item	+	
	0401	0517
Address of last item	+	
	0415	0521

Mem. Pos.	0399	0401	0403	0405	0407	0409	0411	0413	0415
Mem. Addr.	b	0	8	1	2	1	4	1	6
	+	+	+	+	+	+	+	+	+

TABLE

0500	0501	0503	0507	0509	0511	0513	0517	0521
b	9	5	0	2	0	3	9	9
+	+	+	+	+	+	+	+	+

CONSTANTS

$$1. \frac{N+1}{2} = N_1 \text{ (Rounded)}$$

$$\frac{8+1}{2} = 4.5 \text{ or } 5$$

Length = -2
Calculated Address = 0409

$$2. \frac{N_1}{2} = N_2 \text{ (Rounded)}$$

$$\frac{5}{2} = 2.5 \text{ or } 3$$

Length = +2
Calculated Address = 0403

$$3. \frac{N_2}{2} = N_3 \text{ (Rounded)}$$

$$\frac{3}{2} = 1.5 \text{ or } 2$$

Length = -2
Calculated Address = 0407

$$4. \frac{N_3}{2} = N_4 \text{ (Rounded)}$$

$$\frac{2}{2} = 1$$

Length = +2
Calculated Address = 0405

INSTR. LOCATION	OPER	ADDRESS	STOR. CODE	STORAGE 00	SIGN
0004	SET	0004	01	αxxxx	+
0009	RAD	0500	00	α9	+
0014	CMP	0513	00		
0019	TRH	0029			
0024					
0029	MPY	0501	00	α45	+
0034	RND	0001	00	α5	+
0039	ST	0500	00		
0044	MPY	0503	00	α10	+
0049	ADM	0507	00		
0054	LOD	0507	01	α0409	+
0059	CMP	0517	01		
0064	TRH	0094			
0069					
0074					
0079					
0084					
0089					
0094	CMP	0521	01		
0099					
0104	UNL	0114	01		
0109	SET	0002	00		+
0114	LOD	(0409)	00	α21	+
0119	CMP	0509	00		
0124	TRH	0139			
0129					
0134					
0139	SGN	0503	02	α&	+
0144	SGN	0511	02	α-	-
0149	ADM	0511	02		
0154	ADM	0503	02		
0159	TR	0009			
0164					

INSTRUCTION	OPER	ADDRESS	STOR. CODE	STORAGE 00	SIGN
RAD	0500	00		α5	+
CMP	0513	00			
TRH	0029				
MPY	0501	00		α25	+
RND	0001	00		α3	+
ST	0500	00			
MPY	0503	00		α006	-
ADM	0507	00			
LOD	0507	01		α0403	+
CMP	0517	01			
TRH	0094				
SGN	0503	02		α-	-
SGN	0513	02		α&	+
ADM	0503	02			
TR	0009				
CMP	0521	01			
UNL	0114	01			
SET	0002	00			
LOD	(0403)	00		α12	
CMP	0509	00			
TR	0074				

INSTRUCTION	OPER	ADDRESS	STOR. CODE	STORAGE 00	SIGN
RAD	0500	00		α3	+
CMP	0513	00			
TRH	0029				
MPY	0501	00		α15	+
RND	0001	00		α2	+
ST	0500	00			
MPY	0503	00		α004	+
ADM	0507	00			
LOD	0507	01		α0407	+
CMP	0517	01			
TRH	0094				
CMP	0521	01			
UNL	0114	01			
SET	0002	00			
LOD	(0407)	00		α16	+
CMP	0509	00			
TRH	0139				
SGN	0503	02		α&	+
SGN	0511	02		α-	-
ADM	0511	02			
ADM	0503	02			
TR	0009				

INSTRUCTION	OPER	ADDRESS	STOR. CODE	STORAGE 00	SIGN
RAD	0500	00		α2	+
CMP	0513	00			
TRH	0029				
MPY	0501	00		α10	+
RND	0001	00		α1	+
ST	0500	00			
MPY	0503	00		α002	-
ADM	0507	00			
LOD	0507	01		α0405	+
CMP	0517	01			
TRH	0094				
CMP	0521	01			
UNL	0114	01			
SET	0002	00			
LOD	(0405)	00		α14	+
CMP	0509	00			
TRE	0164				

FIGURE 80. PROGRAM, BINARY SEARCH

Program, Binary Search

Figure 80 is the program to locate the number 14 in the table shown stored in memory between locations 0400 and 0415 inclusive. Four searches are necessary to locate the number. The contents of the various storage units are shown during each calculation of *N* and the comparison of 14 with the number at location *N*.

Figure 81 is the complete program written in the normal manner.

- 0004. Adjust ASU 01 to four positions.
- 0009. Reset and add *N*.
- 0014. Compare *N* to 1.
- 0019. *N* is higher than 1; continue the program.
- 0024. *N* is equal to 1. This condition indicates that the number being searched for is not in the table.
- 0029. Get one-half of *N*.
- 0034. Round *N* one position.
- 0039. Store *N* for next calculation.
- 0044. Multiply *N* by the length factor, in this case 02. The result is the number of memory posi-

INSTR. LOCATION	INSTRUCTION		STOR. CODE	ACCUMULATOR 00	AUXILIARY STORAGE 01-15	
	OPER	ADDRESS			SIGZ	SIGZ
0004	SET	0004	01			
0009	RAD	0500	00			
0014	CMP	0513	00			
0019	TRH	0029	00			
0024	HLT	0001				
0029	MPY	0501	00			
0034	RND	0001	00			
0039	ST	0500	00			
0044	MPY	0503	00			
0049	ADM	0507	00			
0054	LOD	0507	01			
0059	CMP	0517	01			
0064	TRH	0094				
0069	TRE	0104				
0074	SGN	0503	02			
0079	SGN	0513	02			
0084	ADM	0503	02			
0089	TR	0009				
0094	CMP	0521	01			
0099	TRH	0139				
0104	UNL	0114	01			
0109	SET	0002	00			
0114	LOD	()	00			
0119	CMP	0509	00			
0124	TRH	0139				
0129	TRE	0164				
0134	TR	0074				
0139	SGN	0503	02			
0144	SGN	0511	02			
0149	ADM	0511	02			
0154	ADM	0503	02			
0159	TR	0009				
0164						

FIGURE 81. PROGRAM, BINARY SEARCH

tions from the beginning address of the table when N is located.

0049. Add to beginning address. The result is the actual address in memory where the search is to be made. For the first search this is 0409, for the second, 0403, and so on.

0054. Get the calculated address in ASU 01.

0059. Compare the calculated address against the lower limit of the table. The search cannot be made beyond the limits of the table in memory.

0064. The calculated address is higher than the lower limit. Transfer to compare against the upper limit.

0069. The calculated address is equal to the first address in the table. Transfer to compare the number.

0074, 0079, 0084. Change the length field to plus. The sign of the length field controls the search up or down the table.

0089. Transfer to recalculate N .

0094. Compare the calculated address against the upper limit of the table.

0099. The calculated address is beyond the upper limit of the table.

0104. Unload the calculated address in a load instruction.

0109. Adjust accumulator storage to two positions.

0114. Get the number at the calculated address.

0119. Compare the number at the calculated address against 14.

0124. The number is higher than 14. Transfer to change the length field to minus and search lower in the table.

0129. Number 14 is located in the table. Transfer to continue the program.

0134. The number is lower than 14. Transfer to change the length field to plus and search higher in the table.

0139, 0144, 0149, 0154. Change the sign of the length field to minus.

0159. Transfer to recalculate N .

0164. (Start of routine when number is located.)

OTHER INSTRUCTIONS

THIS section describes in detail additional operations of the 705. These operations rearrange records in memory for printing, eliminate repetitive information when printing and eliminate insignificant zeros in storage fields. The no-operation instruction illustrates the setting of one type of program switch.

RECORD ARRANGEMENT FOR PRINTING

WHEN a write instruction follows the selection of a printer, data are "written out" of memory from left to right beginning with the character specified by the address part of the write instruction. Information is transmitted to printer record storage, character by character, exactly as received from memory until the group mark is reached.

In normal programming, consider the report form and arrange fields in memory to fit this particular form before giving a write instruction. Allow one position in the record for each print wheel space of the printed line, including special characters, commas, decimals, and blanks. Insignificant zeros to the left of digits in arithmetical fields are normally dropped before printing by use of the store-for-printing instruction.

Indicative fields, descriptions, or other portions of a record can be shifted in memory to conform to the printing arrangement by the use of load and unload instructions. Amount fields from accumulator storage are stored in memory for printing by the store-for-print instruction.

Store for Print (5—SPR)

1. The store-for-print instruction normally is used to transfer a numerical field from accumulator or auxiliary storage to memory. However, alphabetic fields may also be stored.

2. When the sign of the storage unit is plus, a blank is stored in the memory position specified by the address part of the instruction.

3. When the sign of the storage unit is minus, a dash is stored in the memory position specified by the address part of the instruction.

4. The numerical storage field is stored in the memory positions directly to the left of the sign

position. The storage mark determines the left limit of the field to be stored.

5. When decimals or commas are encountered in memory, these memory positions are skipped and the digits are stored in successively lower address positions.

6. Insignificant zeros, characters with zero numerical portion, and commas in the resulting field in memory are replaced by blanks. The characters $\frac{+}{-}$, $\frac{+}{-}$, and $\frac{+}{-}$ are stored as $\frac{+}{-}$ 0 0, respectively. Zeros to the right of a decimal point are not replaced.

7. The store-for-print instruction must always be applied to fields of known length. For example, to store in a ten-position (plus punctuation) memory field, the storage unit must contain ten digits. If it contains less, the resulting memory field may include remaining high-order digits from a previous field.

8. The field in the storage unit remains unchanged by this instruction.

EXAMPLES, STORE FOR PRINT

ACC. STORAGE	ACC. SIGN	MEMORY BEFORE	MEMORY AFTER
a007638	+	\$2135.146	\$bb76.38b
a0071834	—	bb,bbb.bbb	bbb718.34-
a0000000	+	bbb,bbb.bbb	bbbbbbb.00b
a0473829	—	bb,bbb.bbb	b4,738.29-
aABCDE	+	bb.bbbb	AB.CDEb
$\frac{+}{+}$ a04612	+	bb.bbbb	b4.612b
aABCbD	+	bb.bbbb	AB.C $\frac{+}{-}$ Db

Store-for-Print Problem

The tape record shown in Figure 82 is read into memory from tape unit 0209. The record is prepared for printing in a print line area with one space between each field to fit a predetermined form layout. Each tape record is listed on the report form. Commas and decimal points from the constant data area are placed in the print line to properly punctuate the value and unit cost fields. Commas are restored after each record has been printed.

The first three digits of item number from the tape record are checked for sequence. A change in item number indicates that a total value should be printed. A total print line is indicated with the words "total value" inserted to identify this line on the

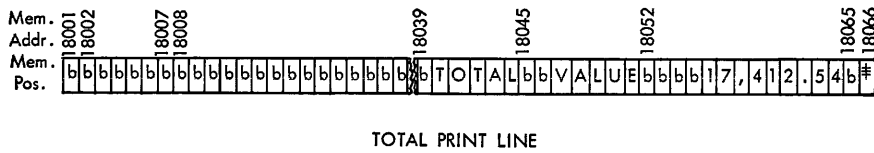
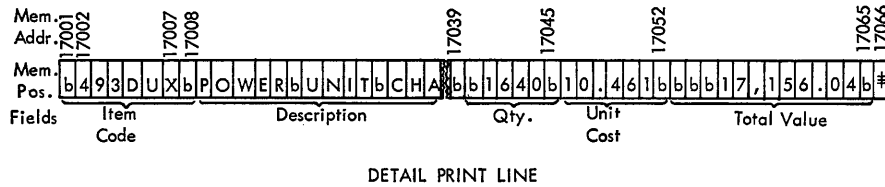
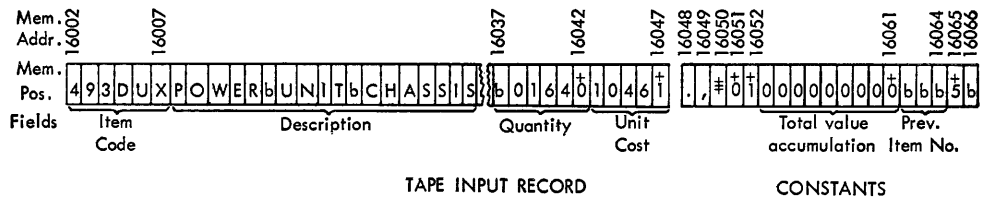

COST REPORT				
Item	Description	Qty.	Unit Cost	Value
493DUX	POWER UNIT CHASSIS	1640	10.461	17,156.04
493DUR	MOTOR GENERATOR	10	25.650	256.50
	TOTAL VALUE			17,412.54
494DUX	POWER CABLE ASSEMBLY	2419	1.168	2,825.29

FIGURE 82. STORE FOR PRINT

report form. Total value is accumulated in a separate area of memory until ready for printing.

It is assumed that all memory positions have been cleared to blanks before the program is loaded into the machine. It is also assumed that all necessary signs, symbols and constants are placed in memory by the program loading routine. The carriage control switch is set to double space.

Program, Store for Print

Figure 83 is the program for the store-for-print problem.

HOUSEKEEPING

0004, 0009, 0014, 0019. Place the group mark in the print line areas.

0024, 0029, 0034, 0039. Place the decimal points in the print line areas.

0044. Adjust ASU 02 to three positions.

0049. Adjust ASU 03 to six positions.

0054. Adjust ASU 04 to 30 positions.

0059. Get a comma in ASU 01.

0064. Get a zero in ASU 06.

0069. Get nine zeros in ASU 06.

0074. Reset the total accumulation area to zero.

0079, 0084, 0089, 0094. Place commas in the print line areas.

0099. Select the input tape unit.

0104. Read the tape record into memory.

0109. Reset and add quantity into accumulator 00.

0114. Store quantity in the detail print line.

INSTR. LOCATION	INSTRUCTION		STOR. CODE	ACCUMULATOR 00	SIGN	AUXILIARY STORAGE 01-15	SIGN
	OPER.	ADDRESS					
Housekeeping							
0004	SET	0001	01			ax	
0009	LOD	3050	01			a#	
0014	UNL	7066	01				
0019	UNL	8066	01				
0024	LOD	6048	01			a.	+
0029	UNL	7048	01				
0034	UNL	7062	01				
0039	UNL	8062	01				
0044	SET	0003	02			axxx	
0049	SET	0006	03			axxxxxx	
0054	SET	0030	04			axx...x	
0059	LOD	3049	01			a.	+
0064	RAD	3051	06			a0	+
0069	SET	0009	06			a00000000	+
0074	ST	3061	06				
0079	UNL	8054	01				
0084	UNL	8058	01				
0089	UNL	7054	01				
0094	UNL	7058	01				
Read, Calculate, and Assemble Detail Print Line							
0099	SEL	0209					
0104	RD	3002					
0109	RAD	3042	00	a01640	+		
0114	SPR	7045	00				
0119	MPY	3047	00	a001715604	+		
0124	RND	0001	00	a001715604	+		
0129	SPR	7065	00				
0134	ADM	3061	00				
0139	RAD	3047	00				
0144	SPR	7052	00				
0149	RCV	7002					
0154	TMT	3002	03				
0159	RCV	7009					
0164	TMT	3008	04				
Print Detail Line							
0169	SEL	0400					
0174	WR	7002	00				
Test for Total Line							
0179	LOD	7004	02			a493	+
0184	CMP	3064	02				
0189	TRE	0089					
0194	TRH	0204					
0199	HLT	0001					
Print Total Line							
0204	UNL	3064	02				
0209	RAD	3061	00	a001741254	+		
0214	SPR	8065	00				
0219	SEL	0400					
0224	WR	8002	00				
0229	TR	0074					

FIGURE 83. PROGRAM, STORE FOR PRINT

0119. Multiply: quantity \times unit cost = total value.

0124. Adjust total value to the nearest cent.

0129. Store total value in the detail print line.

0134. Add the total value to the accumulated total at memory location 16061.

0139. Reset and add unit cost in accumulator 00.

0144. Store unit cost in the detail print line.

0149, 0154. Place item code in the detail print line.

0159, 0164. Place description in the detail print line.

PRINT DETAIL LINE

0169. Select the printer.

0174. Write the detail line.

TEST FOR TOTAL LINE

0179. Load the first three digits of item code in ASU 02.

0184. Compare the item code against the previous item code.

0189. Test for equal item code. Transfer to restore commas in the detail print line and repeat the program.

0194. Test for high item code. Transfer to print the total line.

0199. Low item code. Error stop.

PRINT TOTAL LINE

0204. Unload the item code for comparison with the next record.

0209. Reset and add the accumulated total value in accumulator 00.

0214. Store the total value in the total print line.

0219. Select the printer.

0224. Write the total line.

0229. Transfer to reset the accumulated total area and restore commas in both the detail and total lines. Repeat the program.

TAPE-CONTROLLED CARRIAGE

THE TAPE-controlled carriage controls the feeding and spacing of forms at high speed while documents or reports are being prepared on the printer (Figure 84). The carriage is controlled by punched holes in a narrow paper tape which is exactly the length of one or more forms. Holes punched in the tape stop the form when it reaches any predetermined position. One of the punched holes in the tape can be used to control the printer to start overflow skipping to the next form.

The carriage accommodates continuous forms measured in sixths of an inch up to a maximum sheet

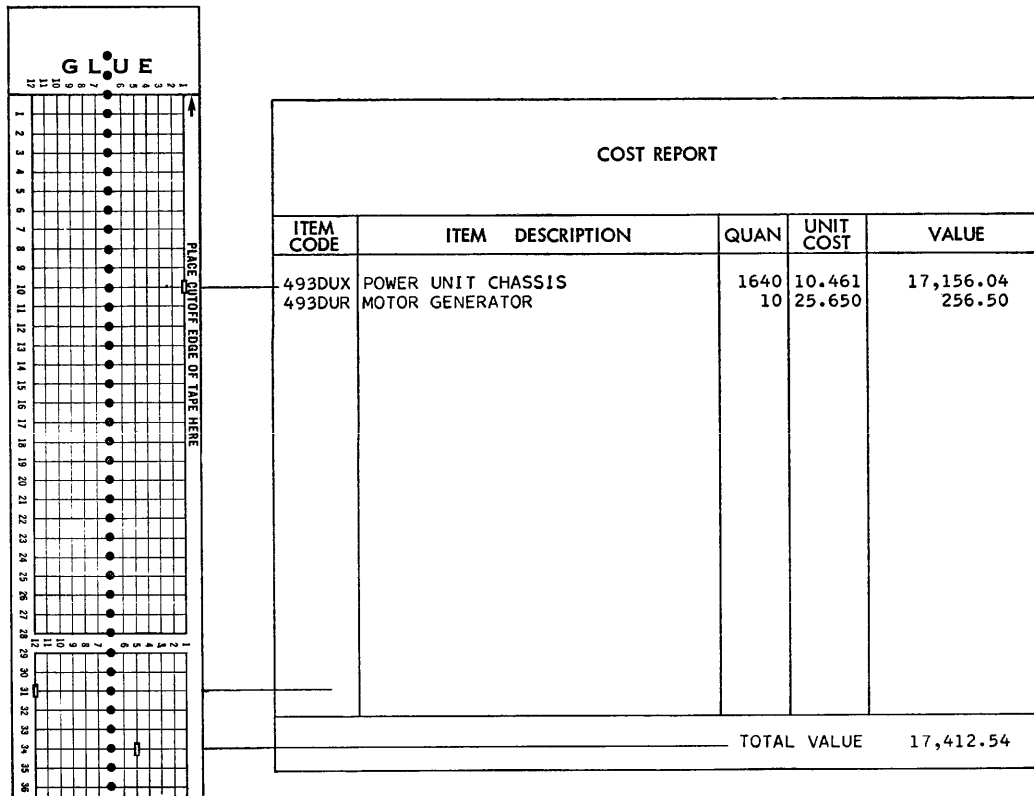

FIGURE 84. FORM AND CARRIAGE TAPE

length of 22 inches and $16\frac{3}{4}$ inches in width, including punched margins. While forms of any size within these limits can be handled by the carriage, forms of standard sizes available from the forms manufacturers can be obtained more quickly and economically.

Forms can be designed to permit printing in practically any desired arrangement. Skipping can be controlled to eight different sections of the form.

Variable Line Spacing and Uniform Skipping

Single or double spacing can vary between lines as controlled by the program. For example, the heading section of a form may be single-spaced and the body double-spaced.

Any other spacing that is required must be controlled by the tape and program instructions. Spaces up to two inches between lines can be skipped at the same rate of speed as normal spacing. This skipping is a smooth, high-speed advance of the form allowing successive lines to be printed up to two inches apart at the rate of 150 lines per minute, the normal printing speed of the machine.

Overflow Skipping

When one form is completely filled, it can be ejected and the next form can advance to the first printing line or to the first body line. This "overflow skipping" is caused by sensing a punch in a specific position of the tape, which starts advancing the paper to the required line on the next form. If a group total occurs immediately after a record prints on the last available detail printing line, the total may be programmed to print before skipping to the next form. Overflow is slower than other skipping; therefore, it is desirable to reduce overflow skipping to a minimum.

Printing all totals on the last overflow form can be accomplished without reducing the printing space on each of the preceding forms.

Page Totals

The overflow punch in the tape can also be used to start other operations, if desired, before ejecting the completely filled form. For example, a total may

be printed at the bottom of each page before advancing to the next form.

Overflow Sheet Identification

Several lines of numerical or alphabetic identifying information may be printed on an overflow sheet. Invoice and page numbering may also be printed on the overflow sheets under instruction of the program.

Predetermined Total Line

Totals can be printed on a predetermined total line, whether the form is completely filled or not. For example, although only two or three items have been printed on a form, the total of these items may be printed on a designated line of the form, instead of directly beneath the last item printed.

Control Tape

The control tape (Figure 84) has 12 columnar positions indicated by vertical lines. These positions are called channels. A maximum of 22 inches (132 lines) can be used for control of a form, although for convenience the tape blanks are slightly longer. Horizontal lines are spaced six to the inch for the entire length of the tape. Round holes in the center of the tape are prepunched for a pin feed drive in a tape sensing mechanism which controls the carriage. The tape advance through the mechanism is synchronized with the movement of the printed form through the carriage. The effect is exactly the same as though the control holes were punched along the edge of each form.

Twelve brushes, one for each channel, are positioned over the tape for sensing the holes that are punched. As viewed from the front of the machine, they are numbered 1 through 12 from left to right. Brush 1 rests on channel 1, brush 2 on channel 2, and so on. A hole in the channel allows the brush to make contact with a metal roll and set up the necessary circuits that are normally used to stop skipping or to initiate an overflow. Channels 10 and 11 are not used in the Type 717 printer.

TAPE CHANNELS

Tape channels are punched to control the following functions:

First Printing Line Stop. Channel 1 must be

punched for the first printing line of a form. This is the starting or home position.

Normal Skip Stops. Channels 2 through 9 are used to stop a form at one of eight positions including the first body line. They may be used in any sequence.

Overflow Control. The 12th channel of the tape must be punched in a position corresponding to the next to the last printing line of a form. This punch is normally used to cause immediate overflow skipping but may also be used to initiate overflow programs which in turn can be used to print sheet identification information from memory.

TAPE PUNCHING

A small compact punch (Figure 85) is provided for punching the tape. The tape is first marked in the channels in which the holes are to be punched. This can be done easily by laying the tape beside the left edge of the form which it is to control with the top line (immediately under the glue portion) even with the top edge of the form. A mark is then made in the first channel on the line which corresponds to the first printing line of the form. Additional marks are made in the appropriate channels for each of the other skip stops and the overflow signal required for the form.

The marking for one form should be repeated as many times as the usable length of the tape (22 inches) will allow. With the tape thus serving to control several forms in one revolution through the sensing mechanism, the life of the tape is increased. Finally, the line corresponding to the bottom edge of the last form should be marked for cutting after the tape is punched.

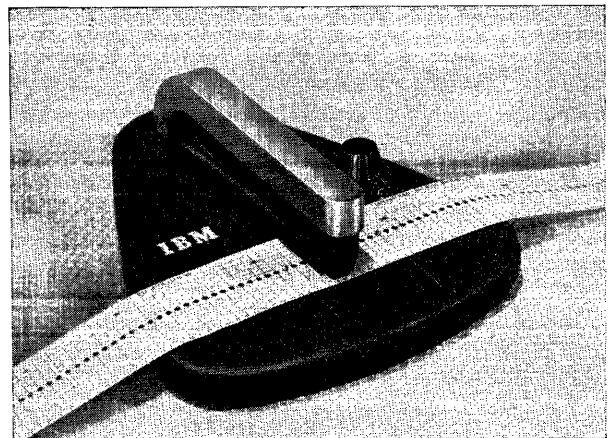

FIGURE 85. CARRIAGE TAPE PUNCH

The tape is inserted in the punch by placing the line to be punched over a guide line on the base of the punch and placing the center feed holes of the tape over the pins projecting from the base. The dial is then turned until the arrow points to the number of the channel to be punched. Pressing on the top of the punch, toward the back, cuts a rectangular hole at the intersection of a vertical and horizontal line in the required channel of the tape.

The tape may be punched with holes in more than one channel on the same line. This is advantageous in many cases, when several skip impulses are directed to the same skip stop. Punching two holes in one channel is necessary in some instances.

After the tape is punched, it is cut and looped into a belt. The bottom line is glued to the top line by the use of the section marked **GLUE**, after the glaze has been removed by an ink eraser. If the glaze is not removed, the tape ends may come apart. The center feed holes should coincide when the two ends of the tape are glued together.

The last hole punched in the tape should not be less than four lines from the cut edge, as about the last half inch of the tape overlaps the glue section when the two ends are spliced. If it is necessary to punch a hole lower than four lines from the bottom of the form, the tape should be placed with the top line (immediately under the glue portion) four lines lower than the top edge of the form before marking the channels. To compensate for the loss, the tape should then be cut four lines lower than the bottom edge of the form.

INSERTING TAPE IN CARRIAGE

Tilt back the cover of the carriage to gain access to the tape reading mechanism. Turn the platen clutch to a disengaged position, and raise the brushes, by moving to the left the latch located on the side of the brush holder. With the tape held so that the printed captions can be read, place one end of the loop over the pin feed drive wheel so that the pins engage the center drive holes. Place the opposite end of the loop over the nearest half-circle guide piece. Remove the excess slack from the tape by lifting the lever away from the notched bar and by moving the guide piece unit to the right. The tape should be just tight enough to give slightly when the top and bottom portions of the loop are pressed together as shown in

Figure 86. If it fits too tightly, the pin feed holes will be damaged.

After the tape is in position, press down the brushes and close the cover. Depress the restore key to bring the tape to its home position and turn the platen clutch back to its engaged position. The carriage is then ready to operate.

Tapes can be changed readily and used repeatedly over a considerable period of time.

CARRIAGE CONTROL SWITCH

The carriage control switch on the tape-controlled carriage may be set to single space, double space, or program.

When set to single space, form spacing is six lines to the inch. When set to double space, spacing is three lines to the inch. Under either setting, print wheel one prints the character in memory addressed by the write instruction, while each successive character in memory is printed by wheel two, three, and so on. The carriage tape controls the ejection and spacing of the form. Channel 1 is the restore or home position of the form and channel 12 is the overflow or eject position. When channel 12 is sensed while printing a line, the form is automatically ejected to channel 1. Controlled skipping to other positions of the form is not possible unless the carriage switch is set to program.

With the switch set to program, the skipping of the form is under the control of program instructions and ejection is not automatic. The character in memory addressed by the write instruction is the carriage control character and is not printed. The

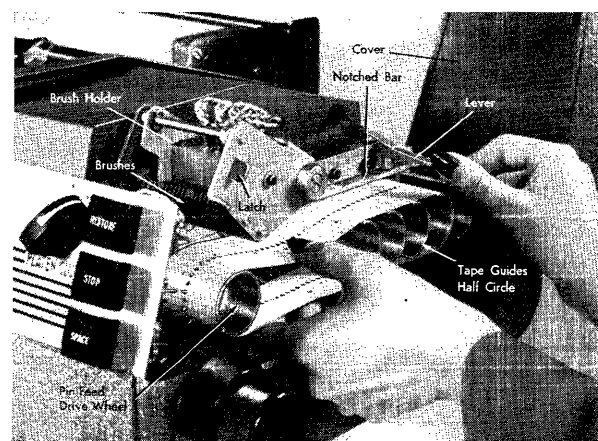

FIGURE 86. INSERTING TAPE IN CARRIAGE

following characters may be used to control skipping:

- Suppress space & (ampersand)
- Single space b (blank)
- Double space 0
- Skip to channels 1-9 1-9
- Short skip to J-R
- channels 1-9

To control skipping, the control character is placed in the memory record before the write instruction is given.

With the carriage under program control, the sensing of channel 12 turns on the printer input-output indicator which can be interrogated by the transfer-on-signal instruction. The resulting transfer is normally made to a subroutine where the input-output indicator is turned off. (Refer to "End-of-File Procedures.") A control character is next inserted in the memory record to cause the following line to be printed at channel 1 position. Other channels may be used for this purpose if desired.

When preparing a tape for auxiliary tape-to-printer operation with the carriage control switch set to PROGRAM, the printing lines must be counted to simulate carriage overflow. The proper control character is inserted as the first character of the tape record.

Carriage Control Problem

The report illustrated in Figure 84 is the same as shown in Figure 82 except that, in this example, the form skipping is under program control. Given the same records shown in Figure 82, the program is written to cause a skip to the predetermined total line position punched in channel 5 whenever a high item code is sensed. A skip to channel 1 is made either when a total has been printed or when the punch in channel 12 is sensed.

Program, Carriage Control

Figure 87 repeats the program in Figure 83 with additional instructions necessary to cause proper form skipping.

HOUSEKEEPING

0004, 0009, 0014, 0019. Place group marks at the end of the detail and total print lines.

0024, 0029, 0034, 0039. Place decimal points in the detail and total print lines.

INSTR. LOCATION	INSTRUCTION		STOR. CODE	ACCUMULATOR 00	Z 05	AUXILIARY STORAGE 01-15	Z 09
	OPER.	ADDRESS					
Housekeeping							
0004	SET	0001	01			ax	
0009	LOD	6050	01			a#	+
0014	UNL	7066	01				
0019	UNL	8066	01				
0024	LOD	6048	01			a.	+
0029	UNL	7048	01				
0034	UNL	7062	01				
0039	UNL	8062	01				
0044	RAD	6065	01			a5	+
0049	UNL	8001	01				
0054	SET	0003	02			axxx	
0059	SET	0006	03			axxxxxx	
0064	SET	0030	04			ax....x	
0069	LOD	6049	01			a,	+
0074	RAD	6051	06			a0	+
0079	SET	0009	06			a000000000	+
0084	ST	6061	06				
0089	UNL	8054	01				
0094	UNL	8058	01				
0099	UNL	7054	01				
0104	UNL	7058	01				
Read, Calculate and Assemble Detail Print Line							
0109	SEL	0209					
0174	TMT	6008	04				
Print Detail Line							
0179	SEL	0400					
0184	TRS	0249					
0189	WR	7001	00				
Test for Total Line							
0194	LOD	7004	02			a493	+
0199	CMP	6064	02				
0204	TRE	0099					
0209	TRH	0219					
0214	HLT	0001					
Print Total Line							
0219	UNL	6064	02				
0224	RAD	6061	00	a001741254			+
0229	SPR	8065	00				
0234	SEL	0400					
0239	WR	8001	00				
0244	TR	0089					
End of Page - Detail Line							
0249	RAD	6052	07			a1	+
0254	UNL	7001	07				
0259	WR	7001	00				
0264	LOD	7008	07			ab	
0269	UNL	7001	07				
0274	TR	0194					

FIGURE 87. PROGRAM, CARRIAGE CONTROL

0044, 0049. Place a 5 in the first character of the total line to cause skipping to channel 5.

0054, 0059, 0064. Adjust ASU's.

0069. Get a comma.

0074, 0079, 0084. Reset the total accumulation area.

0089, 0094, 0099, 0104. Place commas in print lines.

READ, CALCULATE AND ASSEMBLE PRINT LINE

0109-0174. Refer to Figure 83, instructions 0099-0164.

PRINT DETAIL LINE

0179. Select the printer.

0184. Test for the end of the page. Transfer to change the carriage control character.

0189. Write the detail line.

TEST FOR TOTAL LINE

0194. Get item number from the print line.

0199. Compare item number against the previous item number.

0204. Transfer equal to restore detail line commas, and read another record.

0209. Transfer high to print the total.

0214. Stop. Sequence error.

PRINT TOTAL LINE

0219. Store item number for comparison against the next record.

0224. Reset and add accumulated total value.

0229. Put total value in the total print line.

0234. Select the printer.

0239. Write the total line at the channel 5 position.

0244. Transfer to restore commas in both detail and total print lines.

END OF PAGE, DETAIL LINE

0249, 0254. Place 1 in the carriage control position of the detail line.

0259. Write a detail line in the channel 1 position.

0264, 0269. Replace a blank in the carriage control position of the detail line to restore to single spacing.

0274. Transfer to test for total line printing.

WRITE AND ERASE MEMORY

It is often desirable, when writing a record on tape or when printing reports, to write certain indicative information only once. This information may be common to a group of records. Usually the common

information, such as name, part number, invoice number, or customer number, is written with the first record of the group. In accounting machine practice this operation is referred to as "group indication." The 705 can perform the same operation by using the write-and-erase operation.

Write and Erase 00 (Z—WRE)

1. The write-and-erase instruction is used to transfer a record stored in memory to an output unit or a drum. A select instruction is first given to specify the address of the tape unit, card punch, printer, or drum section to be used. The address part of the write-and-erase instruction locates the first left-hand character of the record in memory.

2. A record is written from memory from left to right until a group mark is sensed, the same as for the write instruction. The write and erase instruction, however, replaces each character in memory by a blank. The entire record, including the group mark, is therefore erased from memory when the instruction is executed.

3. The instruction is normally used for printing successive lines of different field arrangement or for group indication when detail printing. Fields may also be arranged on the tape for future printing and repetitive information can be eliminated in successive records.

Write and Erase 01 (Z—WRE)

The rules for WRE 00 also apply to WRE 01 with the following differences.

1. Writing and erasing starts with the memory position specified by the address part of the instruction and continues until memory position 19999 is reached. This position of memory is not written but it causes the proper end of record device (drum mark, inter-record gap) to be recorded.

2. Record marks or group marks have no effect upon the execution of the instruction. They are written out on the selected unit with all other characters.

Write and Erase Problem

The record shown in Figure 88 is to be printed from input records which are read into memory beginning at location 4001. The record is arranged for

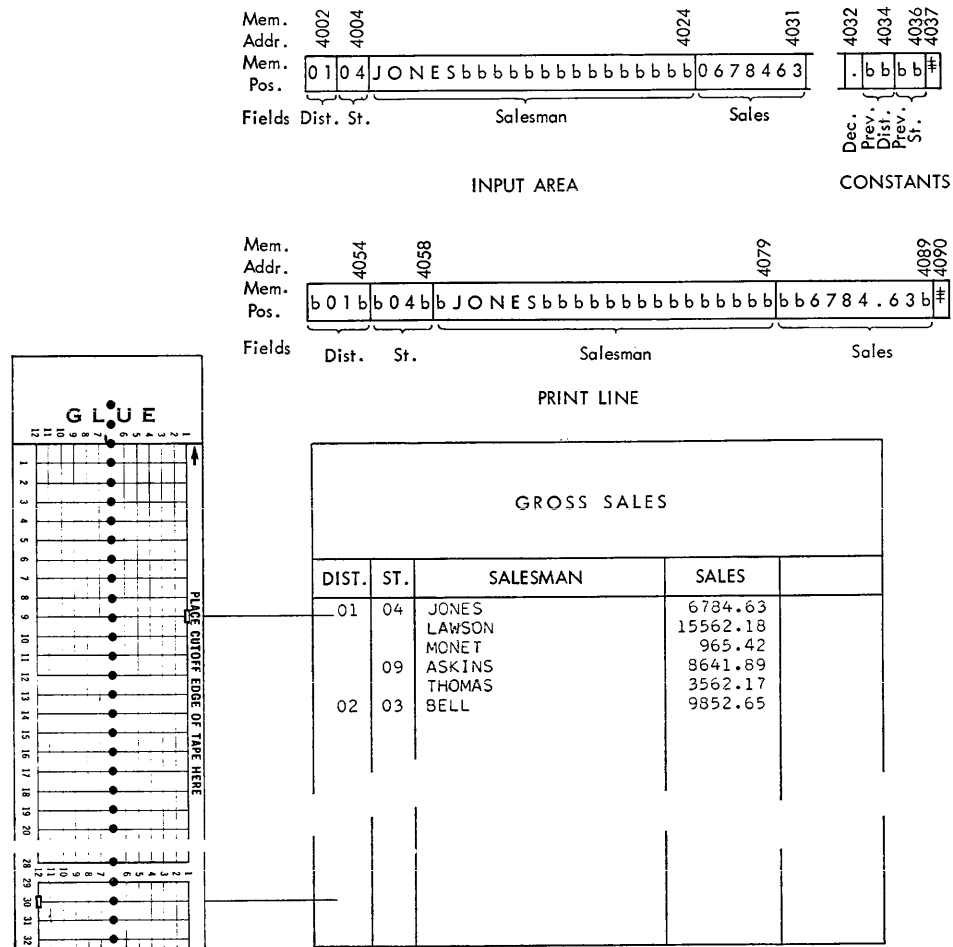

FIGURE 88. CONTROL TAPE AND FORM, WRITE AND ERASE

printing in a print line area beginning at memory location 4051.

The program is arranged to recognize a change in district and state number so that these indicative fields are printed only once. A constant group mark and decimal point are given, and an area is reserved to store previous record state and district numbers for sequence checking.

Program, Write and Erase

Figure 89 is the program illustrating write and erase.

- 0004, 0009. Get a group mark in ASU 01.
- 0014, 0019, 0024. Adjust ASU's 02, 03, and 04.
- 0029, 0034, 0039. Place a decimal point in the print line record.
- 0044. Place the group mark in the print line record.

- 0049. Get sales amount.
- 0054. Store sales amount in the print line.
- 0059, 0064. Place salesman name in the print line by single-character transmission monitored by ASU 04.
- 0069. Load state and district number as one control number in ASU 03.
- 0074. Compare against state and district number from the previous record.
- 0079. If state and district number are equal to the previous record, transfer to write and erase the line without indicating either district or state number.
- 0084. If state and district number are higher than the previous record, transfer to place state in the print line and in the previous record area.
- 0089. Stop 0001. Error in sequence.
- 0094, 0099, 0104. Place state in the print line and in the previous record area.

INSTR. LOCATION	INSTRUCTION		STOR. CODE	ACCUMULATOR 00	Z	AUXILIARY STORAGE 01-15	SIGZ
	OPER.	ADDRESS					
	Housekeeping						
0004	SET	0001	01			ax	
0009	LOD	4037	01			a ⁺	+
0014	SET	0002	02				
0019	SET	0004	03				
0024	SET	0020	04				
0029	SET	0001	05			ax	
0034	LOD	4032	05			a.	+
0039	UNL	4086	05				
0044	UNL	4090	01				
0049	RAD	4031	00	a0678463	+		
0054	SPR	4089	00				
0059	RCV	4060					
0064	TMT	4005	04				
0069	LOD	4004	03			a0104	+
0074	CMP	4036	03				
0079	TRE	0134					
0084	TRH	0094					
0089	HLT	0001					
0094	LOD	4004	02			a04	+
0099	UNL	4036	02				
0104	UNL	4057	02				
0109	LOD	4002	02			a01	
0114	CMP	4034	02				
0119	TRE	0134					
0124	UNL	4034	02				
0129	UNL	4053	02				
0134	SEL	0400					
0139	WRE	4051	00				
0144	TR	0039					

FIGURE 89. PROGRAM, WRITE AND ERASE

- 0109. Load district number.
- 0114. Compare district number against district number from the previous record.
- 0119. If district number is equal to the previous record, transfer to print the record without the district number.
- 0124, 0129. If district number is not equal to the previous record, place district number in the print line and in the previous record area.
- 0134. Select the printer.
- 0139. Print the record and erase memory.
- 0144. Transfer to restore the decimal point and the group mark in the input record.

NORMALIZING ACCUMULATOR AND AUXILIARY STORAGE

THE NORMALIZE-and-transfer instruction is useful in removing zeros, one at a time, from the left end of a factor in accumulator and auxiliary storage. A program routine may then be inserted to count the number of zeros removed, a necessary function in floating decimal or floating dollar sign operations.

Normalize and Transfer (X—NTR)

1. The normalize-and-transfer instruction removes the left-hand character of the storage field if the numerical part of that character is a zero.
2. A transfer is made to the location specified by the address part of the instruction when a character is deleted.
3. If the numerical part of the left-hand character is not a zero, the storage field is not changed, a transfer is not made, and the machine proceeds to the next instruction.
4. When the storage field consists of a single zero, the zero is not deleted and a transfer is not made.

Normalize and Transfer Problem

Figure 90 illustrates the problem of printing asterisks in place of insignificant zeros in an amount field. Assume the following:

A six-position amount field in ASU 01 is to be stored for printing at memory address 5040. The dollar sign and decimal point are to be placed in memory for proper printing of the amount. Insignificant zeros to the left of the decimal point are to be replaced with asterisks.

Constant factors include a dollar sign, asterisk, decimal point, and the memory address where the dollar sign is to be placed. A control address is given to prevent the insertion of asterisks in the decimal point location in memory, should ASU 01 contain an amount with five insignificant zeros or all zeros. Space is provided in the constant area to store an address for positioning the asterisks in the memory field.

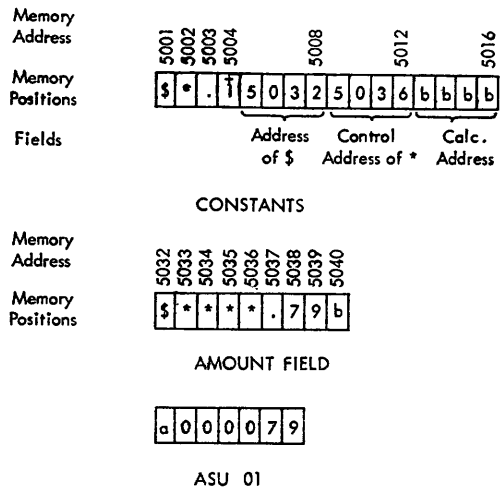

FIGURE 90. NORMALIZE AND TRANSFER

Program, Normalize and Transfer

Figure 91 is the program for normalize and transfer.

HOUSEKEEPING

0004, 0009, 0014. Place a dollar sign in the memory amount field at address 5032.

0019, 0024. Place a decimal point in the memory amount field at address 5037.

0029. Load an asterisk into ASU 02.

0034. Adjust ASU 03 to four places.

0039. Reset and add 1 in ASU 04.

MAIN PROGRAM

0044-0104. Read in records and calculate.

RESET CALCULATED ADDRESS

0109, 0114. Reset the address of the dollar sign into the calculated address space in memory.

0119. Test the amount in ASU 01 for insignificant zeros. Delete one zero and transfer to adjust the calculated address and place asterisks in the first position of the memory amount field.

0124. No zero in amount in ASU 01. Store the amount for printing.

0129. Transfer to continue the main program.

INSERT ASTERISKS

0134. Increase the calculated address by one.

0139, 0144. Get the calculated address and unload it into the address of the instruction which places an asterisk in the memory amount field.

0149. Place an asterisk in the memory amount field. The address of this instruction increases by one as each insignificant zero is removed from the amount field in ASU 01.

0154. Compare the calculated address against the control address at 5012.

0159. When an equal comparison occurs, four asterisks have been placed in the memory field. Transfer to store the amount in ASU 01 for printing.

0164. Transfer to normalize zeros.

Note that the normalize-and-transfer instruction may be used to remove zeros from a storage field without a transfer. The address part may specify the location in memory of the instruction itself. For example: 0964 NTR 0964. The address part transfers the program back to the location of the instruction

INSTR. LOCATION	INSTRUCTION		STOR. CODE	ACCUMULATOR 00	Z 01	AUXILIARY STORAGE 01-15*	Z 01
	OPER	ADDRESS					
Housekeeping							
0004	SET	0001	02			a\$	
0009	LOD	5001	02			a\$	+
0014	UNL	5032	02				
0019	LOD	5003	02			a.	+
0024	UNL	5037	02				
0029	LOD	5002	02			a*	+
0034	SET	0004	03			axxxx	
0039	RAD	5004	04			a1	+
Main Program							
0044	SEL						
	RD						
0104							
Reset Control Address							
0109	LOD	5008	03			a5032	+
0114	UNL	5016	03				
Test Amt. for Zeros and Spr.							
0119	NTR	0134	01				
0124	SPR	5040	01				
0129	TR						
Insert Asterisks							
0134	ADM	5016	04				
0139	LOD	5016	03			a5033	+
0144	UNL	0149	03				
0149	UNL	(5033)	02				
0154	CMP	5012	03				
0159	TRE	0124					
0164	TR	0119					

FIGURE 91. PROGRAM, NORMALIZE AND TRANSFER

at 0964 and repeats the normalizing of the field until all zeros are deleted. The machine then proceeds to the next instruction in memory in the normal manner. NTR is time-consuming when used with long fields in the storage units. It should be used with discretion.

PROGRAM SWITCH

A DATA-processing procedure often involves reading several related input records into memory. These records are normally compared, using a common control field, and the results of the comparison can direct the machine to one of several alternate program routines. The branch or subroutine is made up of a series of instructions to properly direct the machine to calculate, rearrange the record, select specific output devices, check results, and so on. The choice of the proper routine is made by a transfer-equal or transfer-high instruction. The use of transfer-plus and transfer-zero instructions also enables the ma-

chine to pick the proper program path depending upon whether a certain result in storage is positive, zero, or negative. Only the specified routine is followed; the transfer, in effect, "switches" the program around unused instructions which are ignored.

Similarly, end-of-file conditions and error indications can set switches in the program by the use of the transfer-on-signal instruction. In all cases, the setting of the switch is either ON or OFF. A program transfer is made when the switch is on; no transfer is made when the switch is off.

Several other types of switches can be built into the program. For example, an instruction can be cancelled entirely to become "no operation" by substituting the no-operation code in the operation part of the instruction. Or, by inserting different operation codes into instructions located in memory, the machine can change a no-operation to some other specific instruction.

No Operation (A—NOP)

1. The no-operation instruction causes the machine to proceed to the next instruction in the program.
2. The address part has no effect.

NOP—TR Switch Problem

A flow diagram for a portion of a balance-forward procedure is illustrated in Figure 92. A master inventory record is read as one input record. Detail transactions affecting the master record are read as a second input record.

The detail is compared to the master record by product number. The results of the comparison lead to one of three possible program paths:

1. *Equal.* The master and the matching detail are written out on tape. Assume that there may be more than one detail to match one master. Therefore, after a detail is written, a new detail must be read into memory and compared against the same master. If a second equality results, only the detail is printed without reprinting the master record. To accomplish this, a switch is inserted before the write instruction to direct the program around the writing of the master record.

The switch is a no-operation instruction with the location in memory of the detail write instruction for its address part. The operation code of the no-operation instruction is A (Figure 121). To change

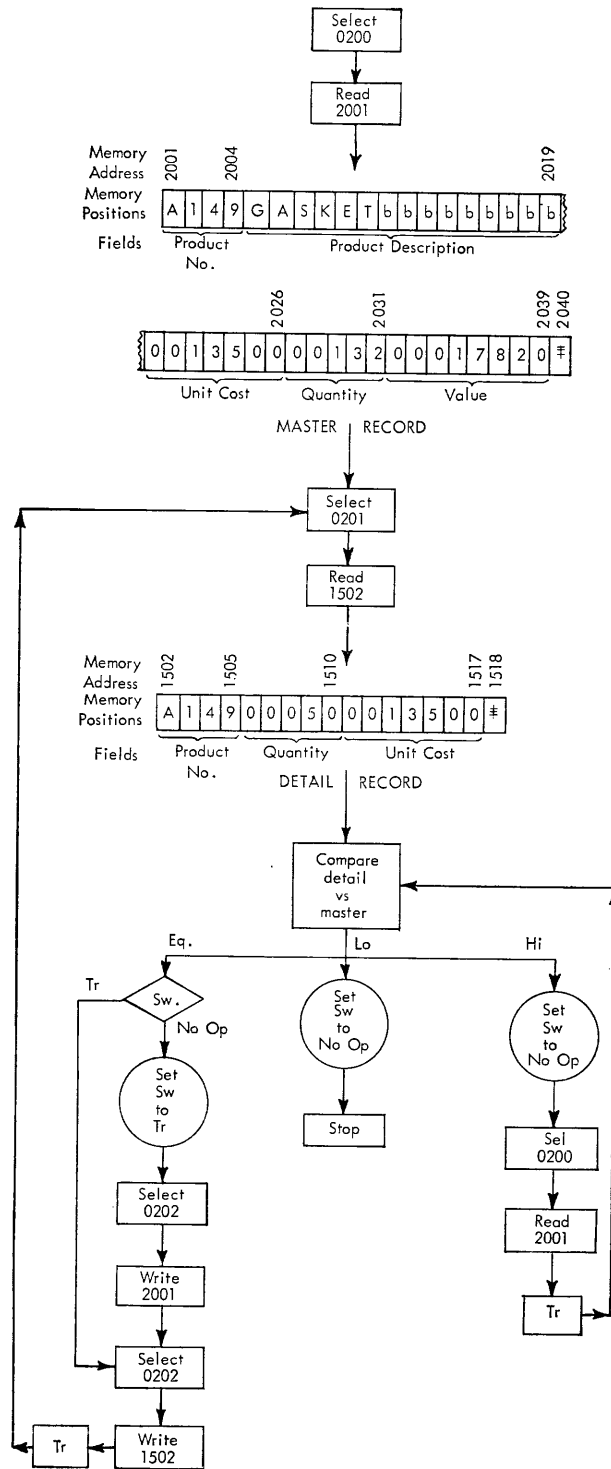

FIGURE 92. BALANCE FORWARD

the no-operation instruction to transfer, the 11 (one, one) zoning is removed from the A by a sign instruction. The resulting character is 1, the operation code of the transfer instruction. The switch instruction

now becomes a transfer whose address part specifies the location of the detail write instruction. Once the switch has been set to TR, the instructions for writing the master record are by-passed.

2. *Low*. A low detail is unmatched. The switch is set to NOP to permit writing the next master. A stop is indicated because an unmatched detail is assumed to be an error condition. Further instructions could be inserted here to type or punch out an error record and continue automatically. These instructions have been omitted to simplify the problem.

3. *High*. A high condition means that the master record is unmatched. This record is ignored and a new master is read into memory to be compared with the detail record previously read. The switch is set to NOP to permit the printing of the next master record.

Program, NOP-TR Switch

Figure 93 is the program for the switch shown in Figure 92. Assume that a group mark has been properly placed in the writing areas. Housekeeping or other preliminary routines are not illustrated.

- 0004. Select the input master record.
- 0009. Read the master record.
- 0014. Select the input detail record.
- 0019. Read the detail record.
- 0024. Adjust ASU 01 to four positions.
- 0029. Load product number into ASU 01 from the detail record.
- 0034. Compare the detail with the master product number.
- 0039. Transfer to the equal routine when the detail matches the master.
- 0044. Transfer to the high routine when the master is unmatched.

LOW DETAIL

0049. Sign the operation part of the switch instruction to change the character A (NOP) to 1 (TR). The sign instruction places a 11 (one, one) zone in ASU 02 when the addressed operation part is either NOP or TR (A or 1). The sign instruction may be placed in a housekeeping routine, provided ASU 02 is not used for any other operation in the program. In this case, ADM 02 will always change the switch to NOP.

0054. Add the 11 zone to the operation part of

INSTR LOCATION	INSTRUCTION		STOR CODE	ACCUMULATOR 00	Z SIZ	AUXILIARY STORAGE 01 15	SIZ
	OPER	ADDRESS					
Read Records and Compare							
0004	SEL	0200					
0009	RD	2001					
0014	SEL	0201					
0019	RD	1502					
0024	SET	0004 01					
0029	LOD	1505 01					
0034	CMP	2004 01					
0039	TRE	0064					
0044	TRH	0099					
Lo Detail							
0049	SGN	0060 02				a&	+
0054	ADM	0060 02					
0059	HLT	0001					
Eq Detail							
0064	(NOP)	0084					
0069	SGN	0060 02				a&	+
0074	SEL	0202					
0079	WR	2001 00					
0084	SEL	0202					
0089	WR	1502 00					
0094	TR	0014					
Hi Detail							
0099	SGN	0060 02				a&	+
0104	ADM	0060 02					
0109	SEL	0200					
0114	RD	2001					
0119	TR	0034					

FIGURE 93. PROGRAM, BALANCE FORWARD

the switch instruction. If the character is A, it will remain A. If the character is 1 it will be changed to A. The sign and add-to-memory instructions, therefore, always set the switch to NOP regardless of its previous setting.

0059. Stop. Unmatched detail.

EQUAL DETAIL

0064. Switch instruction. When the operation part is the character A, the switch is set to NOP. The machine ignores this instruction and the address part is not effective. When the operation part is the character 1, the switch is set to TR. A transfer is made to the instruction specified by the address of the switch.

0069. Set the switch to TR by removing the 11 (one, one) zone from the operation part of the switch instruction. The sign instruction always sets the switch to TR regardless of its previous setting.

0074. Select the output tape unit.

0079. Write the master record.

0084. Select the output tape record.

0089. Write the detail record.

0094. Transfer to read another detail record.

HIGH DETAIL

- 0099, 0104. Set the switch to NOP.
- 0109. Select the input master tape.
- 0114. Read the next master record.
- 0119. Transfer to compare the detail against the master.

DIGIT SELECTION AND DECODING

WHEN a single type of record is used for recording amounts or other quantitative data for different classes of transactions, each transaction must be distinguished from the others by some identifying code. A single digit, an alphabetic character or a multiple character code may be used. The choice of codes, single or multiple character, normally depends upon the number of different types of transactions which must be identified.

In Figure 94, the quantity, identification and descriptive data, unit cost, and other information concerning detail inventory transactions have been transcribed to a tape record. Each type of transaction

is identified by a single digit code. Code 1 indicates a receipt, code 2 a withdrawal, code 3 a plus adjustment, and so on. The transaction records are read into memory from tape unit 0202 beginning at address 6001.

The master inventory balance record is also on tape and is read into memory from tape unit 0200 beginning at address 7001. The master record balances are to be brought up to current status by processing against the detail transactions. Before the proper balances are adjusted, the type of transaction must be identified by its digit code. The program instructions cause the digit code to transfer the machine to the proper routine which will adjust the particular balances affected by that code. Calculations for other codes are ignored.

For example, the instructions for handling receipts add the quantity received to the receipts and on-hand fields of the master record. Instructions for processing withdrawals add the quantity withdrawn to the withdrawal field and subtract it from the quantity on hand.

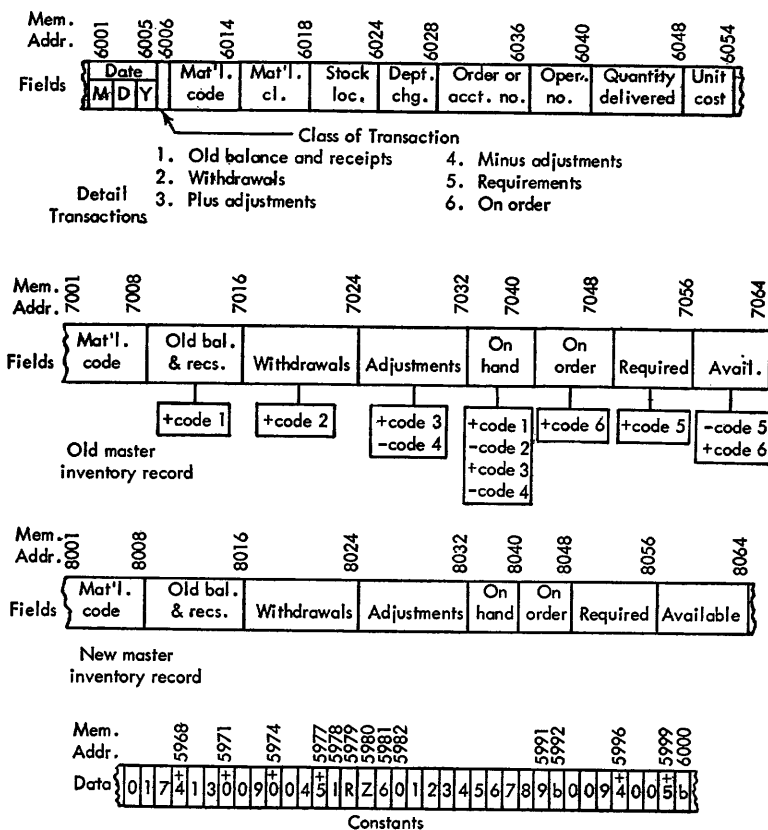

FIGURE 94. BALANCE FORWARD WITH DIGIT SELECTION

The flow chart in Figure 95 outlines the main steps to be programmed to adjust the master inventory record balances. The output area indicated is shown in Figure 94 with assigned memory addresses.

Program, Selection of Single-Digit Code

Figure 96 is the program illustrating the method of digit selection by using address modification of a transfer instruction.

0004, 0009. Select and read the first old master inventory record.

0014. Adjust ASU 01 to eight positions.

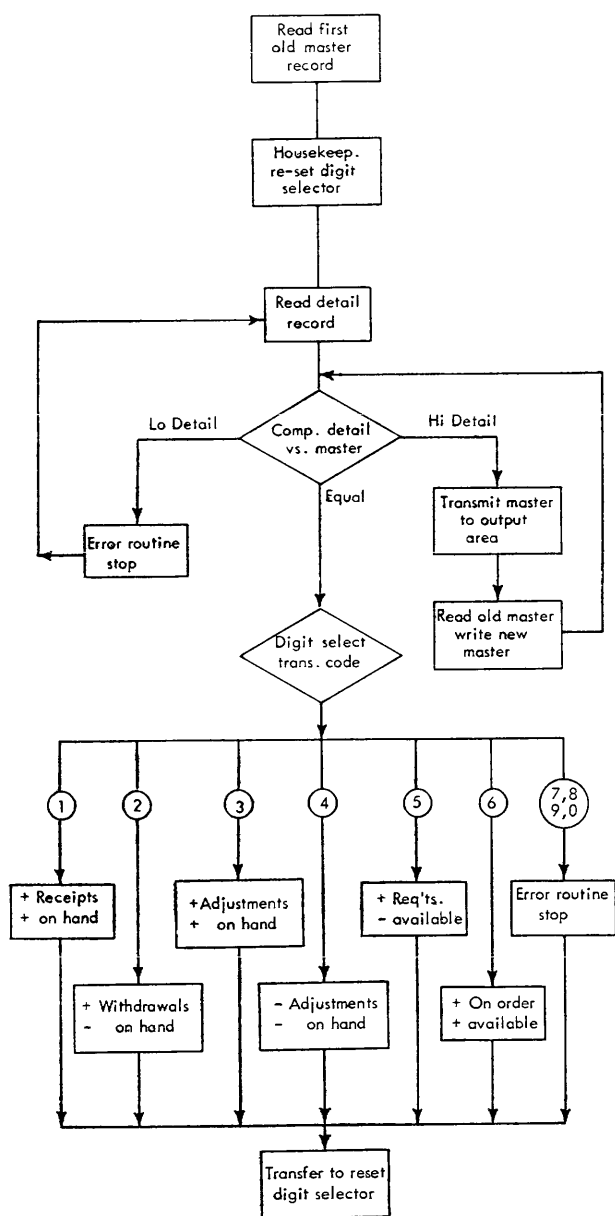

FIGURE 95. SCHEMATIC, BALANCE FORWARD WITH DIGIT SELECTION

0019. Get the initial address of the digit selector transfer instruction.

0024. Reset the digit selector transfer instruction.

0029, 0034. Select input tape unit and read a record.

0039, 0044. Load the material code from the detail and compare against the master record. It is assumed that the two records are in ascending sequence by material code.

0049. The detail material record matches the master record. Transfer to identify the class of transaction.

0054. High detail record. Transfer to transmit the master record to the output area.

0059, 0064. Unmatched detail record. Stop the machine and transfer to the error routine (not shown in program).

0069. Reset and add the quantity field from the detail record into ASU 03. When the type of transaction is identified, the quantity can be added to the inventory record in memory. If the quantity is subtracted from the master record, a reset and subtract instruction is given in the sub-routine.

0074. Reset and add the digit code from the detail record.

0079. Multiply the digit code by 005.

0084. Add the result to the initial digit selector transfer address at location 0089. For example, when the transaction code is 1: a) the result obtained by instruction 0079 is 0005; b) 0005 plus the initial address 0094 equals 0099. The address of the transfer instruction at 0089 is therefore 0099. A transfer will be effected to the instruction located at 0099, which is a transfer to the program for the code 1 transaction.

0089. After each detail record is processed, the digit selector address is reset to 0094 by the instruction 0024. The instruction 0084 always modifies this address to transfer to another transfer instruction which selects the proper transaction routine.

0094. Transfer to code 0. No code 0 is given; therefore, all codes except 1, 2, 3, 4, 5 and 6 are errors.

0099. Transfer to the code 1 routine.

0104. Transfer to the code 2 routine.

0109. Transfer to the code 3 routine.

0114. Transfer to the code 4 routine.

0119. Transfer to the code 5 routine.

0124. Transfer to the code 6 routine.

INSTR LOCATION	INSTRUCTION		STOR. CODE	ACCUMULATOR 00	Z 0 1 2 3	AUXILIARY STORAGE 01-15	Z 0 1 2 3
	OPER.	ADDRESS					
0004	SEL	0200					
0009	RD	7001					
0014	SET	0008	01			axxxxxxxxx	
0019	RAD	5996	02			a0094	+
0024	UNL	0089	02				
0029	SEL	0202					
0034	RD	6001					
0039	LOD	6014	01				
0044	CMP	7008	01				
0049	TRE	0069					
0054	TRH	1249					
0059	HLT	0001					
0064	TR	to error routine					
0069	RAD	6048	03				
0074	RAD	6006	00				
0079	MPY	5999	00				
0084	ADM	0089	00				
0089	TR	()					
0094	TR	to error routine					
0099	TR	1144					
0104	TR	1159					
0109	TR	1179					
0114	TR	1194					
0119	TR	1214					
0124	TR	1234					
0129	TR	to error routine					
0134	TR	to error routine					
0139	TR	to error routine					
		Code 1					
1144	ADM	7016	03				
1149	ADM	7040	03				
1154	TR	0024					
		Code 2					
1159	ADM	7024	03				
1164	RSU	6048	03				
1169	ADM	7040	03				
1174	TR	0024					
		Code 3					
1179	ADM	7032	03				
1184	ADM	7040	03				
1189	TR	0024					
		Code 4					
1194	RSU	6048	03				
1199	ADM	7032	03				
1204	ADM	7040	03				
1209	TR	0024					
		Code 5					
1214	ADM	7056	03				
1219	RSU	6048	03				
1224	ADM	7064	03				
1229	TR	0024					
		Code 6					
1234	ADM	7048	03				
1239	ADM	7064	03				
1244	TR	0024					
		Read & write master records					
1249	RCV	8004					
1254	TMT	7004	00				
1259	SEL	0200					
1264	RWW	7001					
1269	SEL	0201					
1274	WR	8001					
1279	TR	0044					

FIGURE 96. PROGRAM, BALANCE FORWARD WITH DIGIT SELECTION

0129, 0134, 0139. Codes 7, 8 and 9 are errors.

CODE 1, OLD BALANCE AND RECEIPTS

1144, 1149. Add the detail quantity to receipts and on-hand.

1154. Transfer to reset the digit selector.

CODE 2, WITHDRAWALS

1159. Add the detail quantity to withdrawals.

1164, 1169. Subtract the detail quantity from on-hand quantity.

1174. Transfer to reset the digit selector.

CODE 3, PLUS ADJUSTMENTS

1179, 1184. Add the detail quantity to adjustments and on-hand quantity.

1189. Transfer to reset the digit selector.

CODE 4, MINUS ADJUSTMENTS

1194, 1199, 1204. Subtract the detail quantity from adjustments and on-hand quantity.

1209. Transfer to reset the digit selector.

CODE 5, REQUIREMENTS

1214. Add the detail quantity to requirements.

1219, 1224. Subtract the detail quantity from available.

1229. Transfer to reset the digit selector.

CODE 6, ON ORDER

1234, 1239. Add the detail quantity to on-order and available amounts.

1244. Transfer to reset the digit selector.

READ AND WRITE MASTER RECORDS

1249, 1254. Transmit the master record to the output area.

1259, 1264, 1269, 1274. Select and read the old master record; select and write the new master record.

1279. Transfer to compare the detail against the master record.

Digit Selection by Comparison

Digit or code selection can also be accomplished by comparing a transaction code against a series of constants in memory. One constant is normally established for each of the possible codes as shown in Figure 94, memory addresses 5982 through 5991. In

this case a transfer on equal instruction selects the proper program routine.

This method is particularly useful with multiple character codes when the calculation method is impractical. The instructions required to convert Figure 96 to selection by comparison are shown in Figure 97.

Program, Digit Selection by Comparison

- 0074. Get the transaction code.
- 0079. Compare against 0.
- 0084. Code is equal to 0; transfer to the error routine.
- 0089. Compare against 1.
- 0094. Code is equal to 1. Transfer to code 1 routine.
- 0099. Compare against 2.
- 0104. Code is equal to 2. Transfer to code 2 routine.
- 0109, 0114, 0119, 0124, 0129, 0134, 0139, 0144. Compare code against 3, 4, 5 and 6. Transfer to proper routine when equal.
- 0149. Code is higher than 6. Transfer to the error routine.

Decoding, Single-Character Code

A transfer switch can be set up in the program when the single-character code is either alphabetic or numerical. In this case the switch can select any of 36 possible subroutines corresponding to the 26 letters

INSTR. LOCATION	INSTRUCTION		STOR. CODE	ACCUMULATOR 00	SIGN	AUXILIARY STORAGE 01-15	SIGN
	OPER.	ADDRESS					
0074	RAD	6006	00				
0079	CMP	5982	00				
0084	TRE	to error routine					
0089	CMP	5983	00				
0094	TRE	1144					
0099	CMP	5984	00				
0104	TRE	1159					
0109	CMP	5985	00				
0114	TRE	1179					
0119	CMP	5986	00				
0124	TRE	1194					
0129	CMP	5987	00				
0134	TRE	1214					
0139	CMP	5988	00				
0144	TRE	1234					
0149	TRH	to error routine					

FIGURE 97. PROGRAM, DIGIT SELECTION BY COMPARE METHOD

of the alphabet and the 10 numerical digits. Figure 98 is a flow diagram showing the program arrangement of the switch.

The calculation of the switch address is basically the same as illustrated for numerical digit selection. However, a comparison of the code character is first made against constants Z, I, and R. This comparison places the code character either in a section of the alphabet (A-I, J-R, or S-Z) or determines that the code is numerical. A constant is added to the initial address of the switch when the character is alphabetic; 45 for A-I, 90 for J-R, and 130 for S-Z. The alphabetic character is then addressed by a sign instruction which converts it to a digit. The digit is next multiplied by five and the result is also added to the transfer switch address. The final modification of the switch selects the proper transfer instruction.

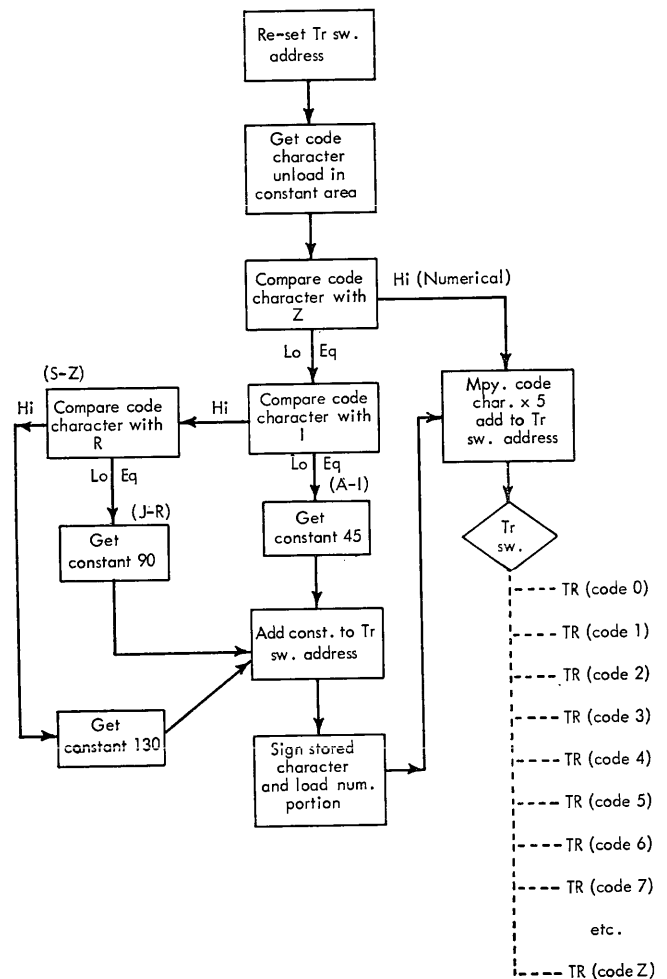

FIGURE 98. SCHEMATIC, DECODING ALPHABETIC AND NUMERICAL

Program, Decoding Single-Character Code

Figure 99 is the program for decoding single-character codes.

0019, 0024. Reset the transfer switch at 0139 to address 0174.

0074, 0079. Get the code character from the detail transaction record.

0084. Unload the code into memory at address 5981.

0089. Compare the code against the constant Z.

0094. The code is numerical. Transfer to multiply by 005.

0099. Compare code against the constant I.

0104. The code is between letters J and Z. Transfer to compare against R.

0109. The code is equal to or lower than I. Get the constant 045.

0114. Add the constant 045 to the address of the transfer switch.

0119. Remove the zone from the transaction code which was stored at 5981. The numerical position remains in memory.

0124. Load the numerical position of the transaction code character.

0129. Multiply by 005.

0134. Add the result to the transfer switch.

0144. Compare the transaction code against the letter R.

0149. The code is between S and Z. Transfer to get the constant 130.

0154. Get the constant 090.

0159. Transfer to add the constant to the transfer switch.

0164. Get the constant 130.

INSTR. LOCATION	INSTRUCTION		STOR. CODE	ACCUMULATOR 00	Z	AUXILIARY STORAGE 01-15	SIGN
	OPER.	ADDRESS					
0019	RAD	5968	02			a0174	+
0024	UNL	0139	02				
0074	SET	0001	00				
0079	LOD	6006	00				
0084	UNL	5981	00				
0089	CMP	5980	00				
0094	TRH	0129					
0099	CMP	5978	00				
0104	TRH	0144					
0109	RAD	5977	00				
0114	ADM	0139	00				
0119	SGN	5981	00				
0124	LOD	5981	00				
0129	MPY	5999	00				
0134	ADM	0139	00				
0139	TR	()					
0144	CMP	5979	00				
0149	TRH	0164					
0154	RAD	5974	00				
0159	TR	0114					
0164	RAD	5971	00				
0169	TR	0114					
0174	TR	to code 0					
0179	TR	to code 1					
0184	TR	to code 2					
0224	TR	to code A					
0269	TR	to code J					
0314	TR	to code S					
0349	TR	to code Z					

FIGURE 99. PROGRAM, DECODING ALPHABETIC AND NUMERICAL

0169. Transfer to add the constant to the transfer switch.

0174-0349. Transfer to the routine for transaction codes.

GROUPING RECORDS

IN ORDER to take full advantage of the high internal speed of the 705 and to conserve reading and writing time, it is frequently desirable to process a block of records at a time. Records can be grouped in any desired number. Figure 100 illustrates the time saving that can be realized by grouping records in blocks of one to ten records. The figure shows that for 10,000 records of various sizes, an appreciable saving per record is realized by grouping at least four records per block. Although larger blocks continue to show savings, the increase in total savings for the job becomes negligible. It is doubtful that grouping records in blocks greater than ten per block for this number of records would be particularly advantageous. The time that is saved by grouping records is the 10.0 milliseconds of tape unit

start time. As the number of records to be processed becomes larger, more advantage is obtained by grouping records in larger blocks.

The grouped records are usually separated by a record mark. If the record size including the record mark is divisible by five, the high-speed RCV and TMT instructions can be used to move the individual records within memory for processing. On the 705, the primary use of the record mark is to separate one record from another when records are blocked.

A sample file maintenance routine is illustrated in Figure 101. In this sample application, the records are grouped in blocks of four records per block as shown in Figure 102. Each record, including a record mark, is 100 characters in length. Each block of master records is separated on tape by an inter-record gap and is read into memory each time a read instruction is executed.

Detail records, representing activity against the master file, are read into memory singly. In order to process the detail against the master records, each master record is moved into a temporary work area so that the same instructions can be used regardless of where the master record was originally read into memory.

The adjusted master records will be assembled into two blocks of four records each for writing. The purpose of the two blocks is to make as much use as possible of the simultaneous RWW instruction. Because it is possible for a detail record to delete a master record or to be used to create a new master record, the number of records in the input block and the output block can get out of step. By using two output blocks, usually at least one of the output blocks will be full and ready to write when the records in the input block have been processed.

This situation is controlled by placing a 5 into auxiliary storage unit 01 at the beginning of the program (Figure 103). Whenever the input area is exhausted, 3 is subtracted from auxiliary storage 01. Whenever a new block is read into the input area, 3 is added to storage unit 01. Whenever one of the

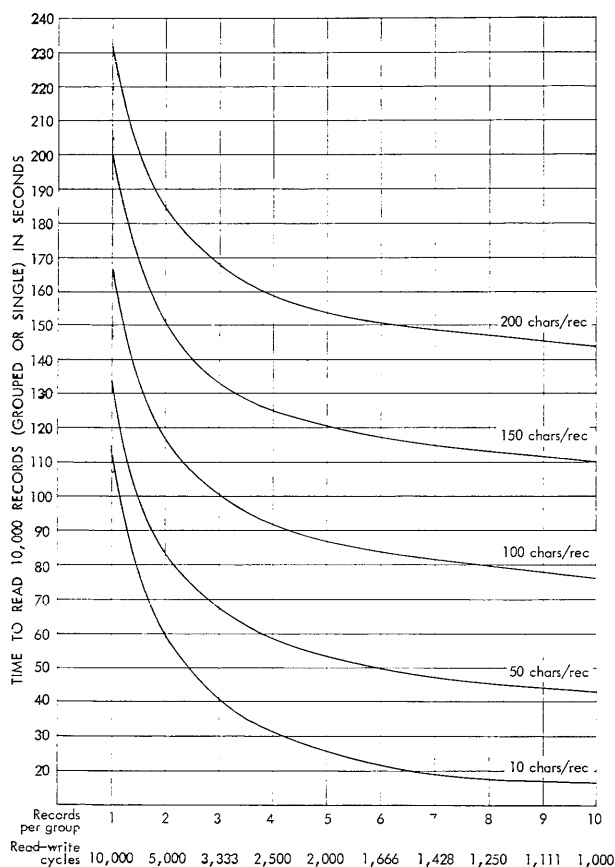

FIGURE 100. TIMING CHART, GROUPED RECORDS

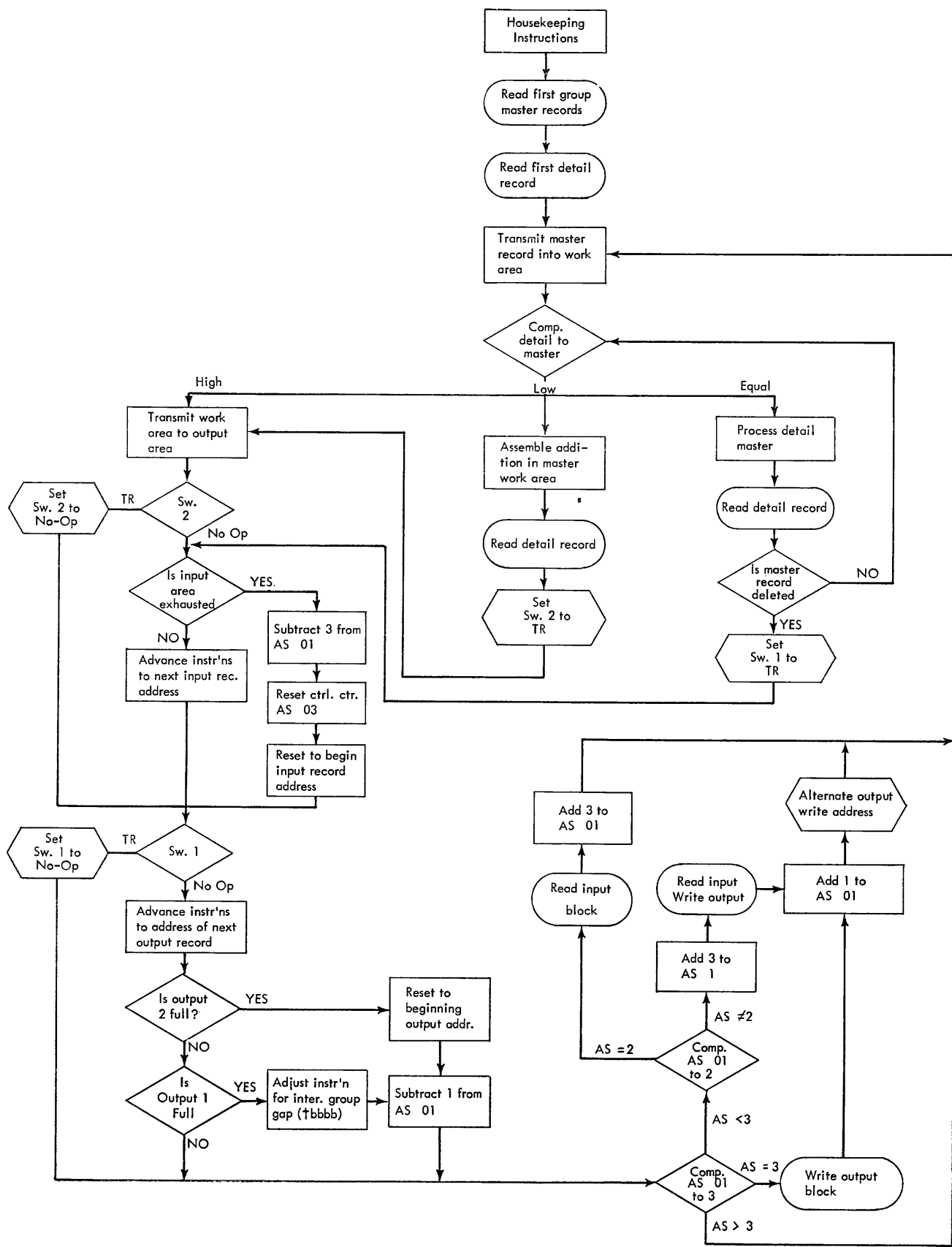

FIGURE 101. FLOW CHART, FILE MAINTENANCE

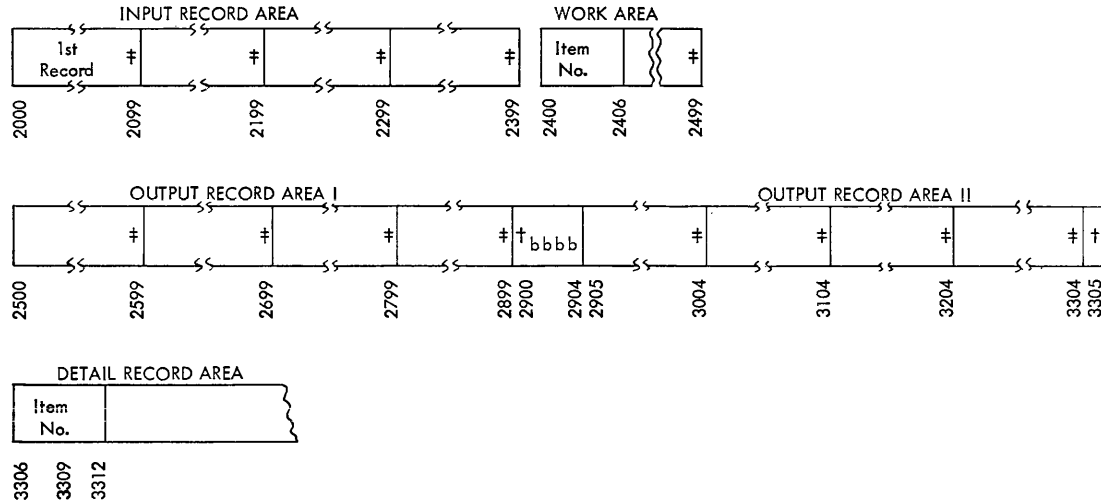

FIGURE 102. RECORD GROUPING, FILE MAINTENANCE

output blocks is full, a 1 is subtracted from auxiliary storage 01, and when an output block is written a 1 is added to auxiliary storage 01.

Each time a master record is moved into one of the output blocks, auxiliary storage 01 is checked and a decision is made as shown in Figure 103.

The two output areas are always filled in sequence starting with output area I, proceeding through II, and then back to I and so on. An alternator switch is set up to govern which output area is to be written next. It causes output area I to be written, then II, and then back to I, and so on regardless of whether the operation is write only, or simultaneous read while writing. Figure 104 is the program for file maintenance with grouped records.

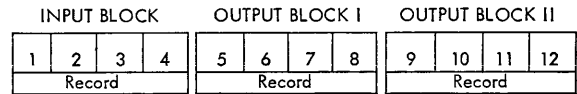

FIGURE 103. INPUT AND OUTPUT DECISIONS

NO. IN ASU 01	SITUATION	DECISION
5	Record 4 not processed. Records 8 and 12 not loaded.	Continue processing
4	Record 4 not processed. Record 8 or 12 loaded.	Continue processing
3	Record 4 not processed. Records 8 and 12 loaded.	Write one output block
2	Record 4 processed. Records 8 and 12 not loaded.	Read input block
1	Record 4 processed. Record 8 or 12 loaded.	Read and write
0	Record 4 processed. Records 8 and 12 loaded.	Read and write

Note: When record 4 is processed, all input records on the input block have been processed.
 When record 8 is loaded, output block I is full.
 When record 12 is loaded, output block II is full.

b	b	b	b	0	5	2	5	0	4	2	0	0	4	1	1	3	5	0	1	0	0	3	3	0	9	2	9	0	4	2	5	0	0	2	9	0	5	#
1960				1966				1970				1974	1975	1976	1977	1978		1982				1986				1990				1994					1998	1999		
(Constants)																																						

a5	a0100	a0000	a3309	a2904	Store Sign	a#	axxxxxxx
01	02	03	04	05	06	07	08
a2004	a2504	a2500	a2905				
09	10	11	12	13	14	15	

INSTR. LOCATION	INSTRUCTION OPER.	ADDRESS	STOR. CODE	EXPLANATION
Housekeeping Routine				
0004	RAD	1978	01	Place 5 in AS 01
0009	RAD	1982	02	Place 0100 in AS 02 (Rec. length)
0014	SET	0004	03	Place 4 zeros in AS 03
0019	RAD	1986	04	Place 3309 in AS 04
0024	RAD	1990	05	Place 2904 in AS 05
0029	SET	0001	07	
0034	LOD	1999	07	Load group mark in AS 07
0039	UNL	2900	07	Unload behind Output Area I
0044	UNL	3305	07	Unload behind Output Area II
0049	SET	0007	08	For comparing detail master
0054	RAD	1974	09	Beg. Input Address 2004 (TSMT)
0059	RAD	1970	10	Beg. Output Address 2504 (RCV)
0064	RAD	1994	11	Beg. Output Address Block I (Write)
0069	RAD	1998	12	Beg. Output Address Block II (Write)
0074	SEL	0200		
0079	RD	2000		Read first block of master records
0084	SEL	0201		
0089	RD	3306		Read first detail record
0094	TRA			
Main Routine				
0099	RCV	2404		
0104	TMT	(2004)	00	Move input record to work area
0109	LOD	3312	08	Load detail item number
0114	CMP	2406	08	Comp. to master item number
0119	TRH	0309		
0124	TRE	0229		
Addition to Master File				
Assemble detail record in work area				
0204	SEL	0201		
0209	RD	3306		Read next detail record
0214	TRA			
0219	SGN	0315	06	Set switch 2 to Tr
0224	TR	0309		
Activity against Master File				
0229				Process detail record. If transaction does not result in deletion, transfer to location 0114 for next instruction. If transaction results in deletion:
0304	SGN	0350	06	Set switch 1 to Tr
No Activity against Master File				
0309	RCV	(2504)		
0314	TMT	2404	00	Move master to output area
0319	NOP	0594		Switch 2
0324	NTR	0349	03	Does this record exhaust input area?
0329	SUB	1977	01	Yes, sub 3 from AS 01
0334	SET	0004	03	Restore input ctrl. counter
0339	UNL	0104	09	Reset TMT instr. to beg. input address
0344	TR	0354		
0349	ADM	0104	02	Advance
0354	NOP	0579		Switch 1
0359	ADM	0309	02	Advance address of next output rec.
0364	CMP	0309	04	Is output area II full?
0369	TRE	0549		Yes
0374	CMP	0309	05	Is output area I full?
0379	TRE	0559		Yes

INSTR. LOCATION	INSTRUCTION OPER.	ADDRESS	STOR. CODE	EXPLANATION
0384	CMP	1983	01	Compare AS 01 to 3
0389	TRH	0099		AS=3
0394	TRE	0449		AS=3
0399	CMP	1987	01	Compare AS 01 to 2
0404	TRE	0519		AS=2
Input Block Exhausted/Output block or Blocks Full				
0409	ADD	1977	01	Add 3 to AS 01
0414	TRA			
0419	SEL	0200		Alert input tape unit
0424	RWW	2000		Keep input tape unit alerted
0429	SEL	0202		Alert output tape
0434	WR	(2500)	00	Read input block, write output block
0439	TRA			
0444	TR	0469		
Both Output Blocks Full				
0449	TRA			
0454	SEL	0202		
0459	WR	(2500)	00	Write output block
0464	TRA			
0469	ADD	1976	01	Add 1 to AS 01
0474	RSU	1975	00	Alternator Switch for
0479	ST	1975	00	alternating write instructions
0484	TRP	0504	00	for output areas
0489	UNL	0434	12	Adjust write instructions address
0494	UNL	0459	12	for output block II
0499	TR	0099		
0504	UNL	0434	11	Adjust write instructions address
0509	UNL	0459	11	for output block I
0514	TR	0099		
Input Block Exhausted				
0519	TRA			
0524	SEL	0200		
0529	RD	2000		Read next block of master records
0534	TRA			
0539	ADD	1977	01	Add 3 into AS 01
0544	TR	0099		
Output Area II is Full				
0549	UNL	0309	10	
0554	TR	0569		
Output Area I is Full				
0559	RAD	1965	00	Place 05 in accumulator
0564	ADM	0309	00	
0569	SUB	1976	01	Subtract 1 from AS 01
0574	TR	0384		
0579	SGN	0350	06	
0584	ADM	0350	06	Set switch 1 to No Op
0589	TR	0384		
0594	SGN	0315	06	
0599	ADM	0315	06	Set switch 2 to No Op
0604	TR	0354		

FIGURE 104. PROGRAM, GROUPED RECORDS

OPERATING SPEEDS

THE BASIC character cycle of the Type 705 is 17 microseconds (.017 milliseconds). A complete instruction is examined and interpreted in .017 milliseconds. A character cycle would include the time required to obtain one character of data from the magnetic core memory, operate upon the character in the arithmetic and logical unit, and transfer it out of the arithmetic and logical unit.

The instructions are classified below into six categories. The timing for each classification is given in milliseconds (1 millisecond = 1/1000 second).

Class 1 Instructions

The instructions in this class take .034 milliseconds to read and interpret (except select). The instructions included are:

TRP	TRS
TR	HLT
TRZ	NOP
TRH	TRA
TRE	RCV
RWW	
SEL (requires .051 milliseconds)	

Class 2 Instructions

These instructions take $.034 + .017N$ milliseconds (N = number of characters). These instructions are:

RAD	ADD
RSU	SUB
CMP	ADM
LOD	SPR
UNL	SGN
ST	SET

Class 3 Instructions

This classification includes MPY and DIV. The formula for multiplication is:

$$.017 [N_p (N_c + 4) + 2] \text{ milliseconds.}$$

where

N_p = number of digits in multiplier (accumulator 00)

N_c = number of digits in multiplicand (memory)

For division the formula is:

$$.017 [11 + N_d + (N_d - N_r) (7.5 N_r + 15)] \text{ milliseconds.}$$

where

N_d = number of digits in the dividend.

N_r = number of digits in the divisor.

Class 4 Instructions

SHR, LNG, NTR: $.051 + .017N$ milliseconds.

RND: $.085 + .017N$ milliseconds.

(For shorten and round, these are minimum times, applicable if the accumulator storage has no zero in the right-hand character position.)

TMT (5-character groups): $.017 + \frac{N}{5} \times .018$ milliseconds.

(Single characters): $.034 + N \times .018$ milliseconds.

Magnetic tape read or write time is $10.0 + .067N$ milliseconds. (N = number of characters read or written).

Class 5 Instructions

IOF: .068 milliseconds. Turn off the input-output indicator.

WTM: 10.0 milliseconds. Record the tape mark.

RWD: .051 milliseconds. Rewind the tape.

ION: .051 milliseconds. Turn on the input-output indicator.

BSP: $60 + .067N$ milliseconds. Backspace the tape.

SUP: .068 milliseconds. Stop printing or punching.

Class 6 Instructions

The time for RD, WR and WRE is:

Card record: $.068 + .0335N$ milliseconds.

Magnetic tape: $10.0 + .067N$ milliseconds.

Drum: $8.0 + .040N$ milliseconds.

The control panel on the card reader makes it possible to control the number of characters read from the card into the card record storage. N in the above formulas applies to the number of digits read from the card record storage up to the record storage mark.

For both drum and tape, N is the number of characters that are being read or written.

MACHINE COMPONENTS

A DETAILED description of each of the Type 705 components will be found in this section. The use of the various operating lights and keys associated with each unit is also explained.

CARD READER, TYPE 714

THE CARD reader (Figure 105) reads IBM punched cards at a rate of 250 per minute. Through the use of a control panel, card records can be read into memory or transcribed to tape exactly as the record is to be used by the 705. The control panel controls the card reading by standard EAM machine features including digit selectors, column splits, and emitters.

A magnetic core record storage unit of 92 positions is provided. The entire 80 columns of information from the card, or any portion of the card, may be read into record storage as the card passes a set of reading brushes (Figure 13). When a read instruction is given, the record is read into memory at high

speed. Record storage then refills with information from the next card, so that this record will also be available at high speed when required. The 705 is free to execute subsequent instructions while record storage is being refilled.

A record storage mark may be emitted from the control panel to control the number of characters read out of record storage. The storage unit is emptied into memory or onto tape up to the record storage mark. During a card-to-tape operation, the sensing of the record storage mark will cause an inter-record gap on tape. During card-to-memory operation, the sensing of the mark stops reading into memory. When no storage mark is wired, all 92 positions are read out of storage; unused positions are read as blank characters.

Operating Keys and Lights

Start Key. This key has two distinct functions:
1. When the hopper is first filled, depressing the

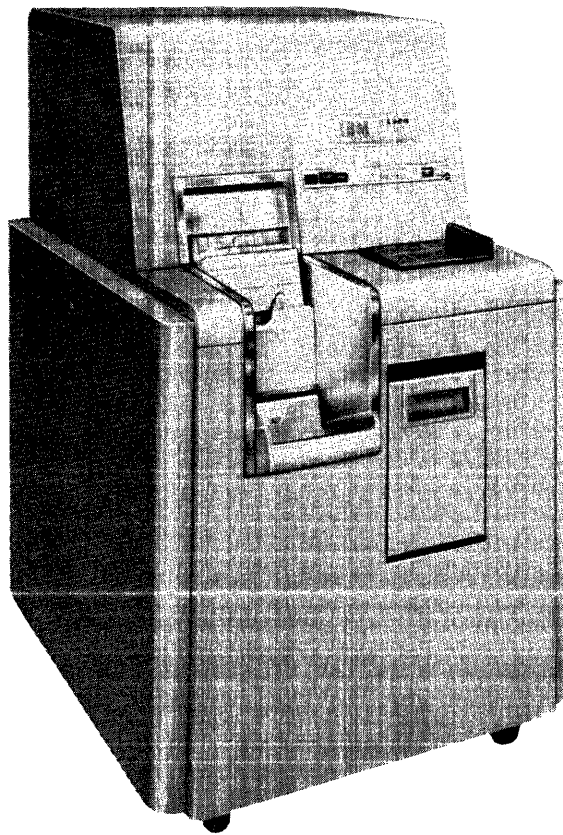

FIGURE 105. CARD READER

start key feeds the first three cards. The first card is read into record storage. Depressing the start key a second time turns on the calculator interlock, making the card reader available for operation under 705 control. Depressing this key has no effect if the calculator interlock is already turned on. When the card reader is first prepared for operation, it is necessary to depress the start key twice, once to feed three cards and once to turn on the calculator interlock.

2. When the last card has been fed from the hopper (before its contents are stored in record storage) the machine stops. The calculator interlock is turned off, and it is necessary for the operator to depress the start key before operation can proceed under 705 control. If the card file is not at an end, the operator will replenish the supply of cards in the hopper before depressing the start key. If the card file is at an end, depressing the start key will allow the 705 to resume operation and the two remaining cards will be read as called for by program instructions. The input-output indicator for the card reader is turned on when the 705 executes the read instruction following the one which read the last card in the file from record storage to the 705. The input-output indicator is turned off by the instruction IOF or by running in the cards when starting an operation.

Stop Key. Depressing this key turns off the calculator interlock and causes the card reader to stop operating. After a feed error it can be used to turn off the feed check light after all the cards have been removed from the feed and hopper.

Feed Key. This key provides a manual feed without reading the cards in the machine. It is operative only when the calculator interlock is not turned on.

Ready Light. The ready light is on whenever the calculator interlock is turned on. It indicates that the card reader is ready for operation under control of the 705.

Select Light. This light goes on when the card reader is selected by the 705 and remains on until another input-output unit, check indicator, or alteration switch is selected.

Feed Check Light. A card jam or failure to feed will turn on this light and turn off the calculator interlock. The light is reset by removing the cards from the hopper, and depressing the feed key to clear the machine.

Card Reader Control Panel

The selection or arrangement of information to be read into memory from IBM cards is made by the control panel (Figure 106).

Cards are read by sensing the punched holes electrically. The resulting impulses travel by internal connections to the control panel. The impulses are then directed to transfer the information in the card to the card reader record storage unit through external wires which can be manually inserted into the hubs on the panel.

There are two kinds of hubs on the control panel, exits and entries. An exit is one which emits an impulse. Some exits emit impulses under the control

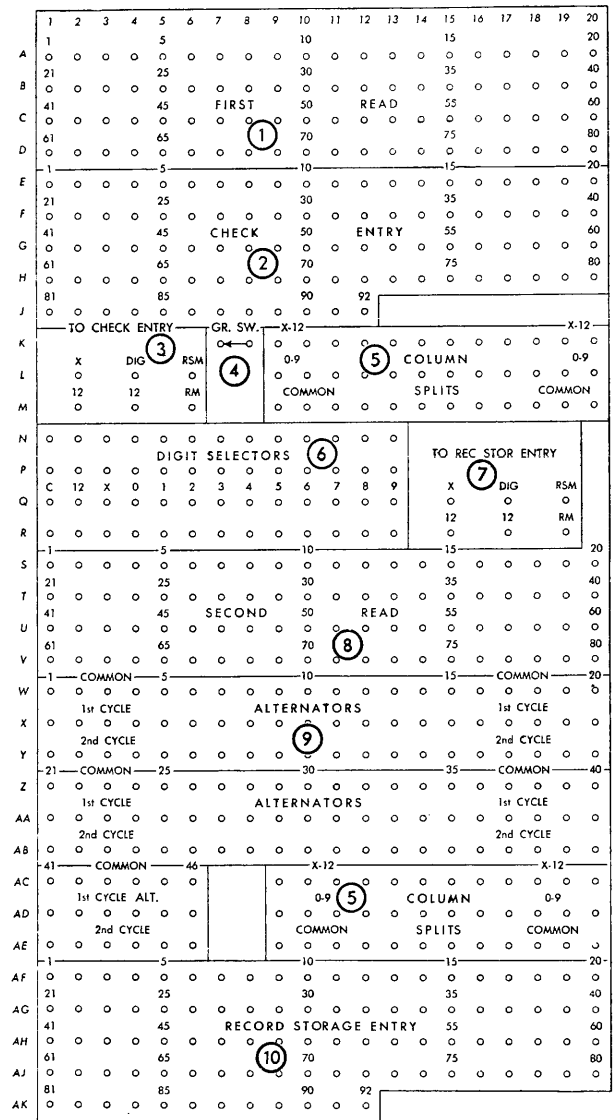

FIGURE 106. CARD READER CONTROL PANEL

of the hole in the card, some emit automatically during each card reading cycle.

An entry hub is one which can accept an impulse wired to it. A connection must always be made from an exit to an entry by inserting one end of a wire into an exit hub and the other end into an entry hub. Which exit and entry hubs are used depends upon the card columns being read, the record storage positions being filled, or upon what other functions of the card reader are being used for a particular job. These additional functions may include, for example, the alternator, column splits, or character emitters. The control panel may be readily changed for each different procedure. Or a separate panel may be prepared for each different job. The panel is then inserted in the machine when required.

To facilitate reference to specific hubs on the control panel, the rows are numbered from 1 through 20 horizontally and lettered A through AK vertically. Each group of hubs is described in the following sections.

1. *First Read (A-D, 1-20)*. The 80 first read hubs represent the 80 columns on IBM cards. These hubs emit impulses corresponding to the card punching sensed at the first read station in the card reader. They are normally wired to the check entry hubs.

2. *Check Entry (E-H, 1-20; J, 1-12)*. The 92 check entry hubs represent the 92 positions of the card reader record storage unit. The check entry may receive impulses emitted from the first read hubs, the check entry character emitter, column splits, alternators or the digit selectors. Information is fed to 12 binary triggers where an odd-even row count is made and held for checking against information read from the card at the second read station (Figure 67).

3. *Check Entry Emitters (L-M, 2, 4, 6)*. The check entry emitters permit the reading of impulses directly into the check entry. The impulses are generated within the machine during each card cycle and are not punched in the card. The X hub emits an impulse which corresponds to the X punch in the IBM card. The 12 hub impulse corresponds to the 12 punch in the card. Two 12 hubs are provided. The digit hub emits a series of impulses 12-9 for each card cycle. The impulses may be selected by wiring into the common hub of a digit selector and from any of the digit hubs to check entry.

The RSM hub emits a record storage mark.

The RM hub emits a record mark.

4. *Group Switch (K, 7-8)*. To use the grouping feature of the card reader, the two hubs of the group switch are wired together.

5. *Column Splits (K-M, AC-AE, 9-20)*. Twenty-four column splits are provided. Each column split has three hubs: C (common), 0-9, and 11-12. They separate 11 and 12 impulses from 0-9 impulses obtained either from punching in the card or emitted impulses on the control panel.

6. *Digit Selectors (N-R, 1-13)*. Four digit selectors are provided. Each digit selector consists of a common hub and 12 hubs labelled for the 12 punching positions of the card. On every machine cycle, the C hub is internally connected successively to the 9, 8, 7 12 hubs. When a first or second read hub representing a card column is connected to the C hub, a specific punching position can be read from the corresponding hub of the digit selector.

When the digit emitter hub of either the check entry or record storage entry emitters are connected to the C hub, the digit selector becomes a digit emitter and may be used to generate numbers, letters or special characters. These special characters may be entered in both check entry and storage entry hubs, depending upon which entry emitter originates the digit impulse.

7. *Record Storage Entry Emitters (Q, R, 15, 17, 19)*. These hubs emit the same impulses as the check entry emitters except that they are wired to the record storage entry.

8. *Second Read (S-V, 1-20)*. There are 80 second read hubs, one for each of the 80 columns of the IBM card. These hubs emit impulses corresponding to the card punching sensed at the second read station in the card reader. They are normally wired to the record storage entry hubs.

9. *Alternator (W-AB, 1-20; AC-AE, 1-6)*. The alternator serves as a selection device which reads the first card of the group into one section of record storage, and the second card into a second designated section of storage. Three rows of hubs are provided: common, first cycle and second cycle. The card columns to be read are wired from second reading to common. During the first card reading cycle, the common and first cycle hubs are internally connected. Therefore, card impulses wired into the common hubs are emitted from the corresponding first cycle hubs

and from there may be wired to the position of record storage where the first card record is to be stored.

During the second card reading cycle, the common and second cycle hubs are connected internally. Card impulses wired into the common hubs are emitted from the corresponding second cycle hubs and from there are wired to the position of record storage where the second record is to be stored.

10. *Record Storage Entry (AF-AJ, 1-20; AK, 1-12)*. There are 92 record storage entry hubs corresponding to the 92 positions in the record storage unit. The record storage entry receives impulses emitted from the second read hubs, the record storage entry character emitter, column splits, alternators, or the digit selectors. Information is fed internally to the record storage unit for transmission to core memory. During transmission an odd-even row count is stored in 12 binary triggers (Figure 67) for checking against the row count obtained from the first read station. For this reason, all check entry hubs must receive the same impulses as the record storage entry hubs. Otherwise, the comparison between the first and second read stations will not be equal and the read-write check indicator in the central processing unit will be turned on.

Wiring, Card Reading

Card columns 1 through 20 are to be read into record storage. A group mark is emitted as a special character and the record storage mark is placed in the 22nd position of record storage. Each of the following numbered paragraphs describes the corresponding wires on the diagram in Figure 107.

1. Columns 1 through 20 are wired from first read to hubs 1 through 20 of check entry.
2. Columns 1 through 20 are wired from second read to hubs 1 through 20 of record storage entry.
3. The digit hub of the check entry emitter is wired to the C hub of the digit selector.
4. The 12, 8 and 5 hubs of the digit selector are wired to the 21st position of check entry using a split wire (wire with more than two ends). This emits the group mark as a special character into the check entry.
5. The RSM hub from the check entry emitter is wired to the 22nd position of check entry.

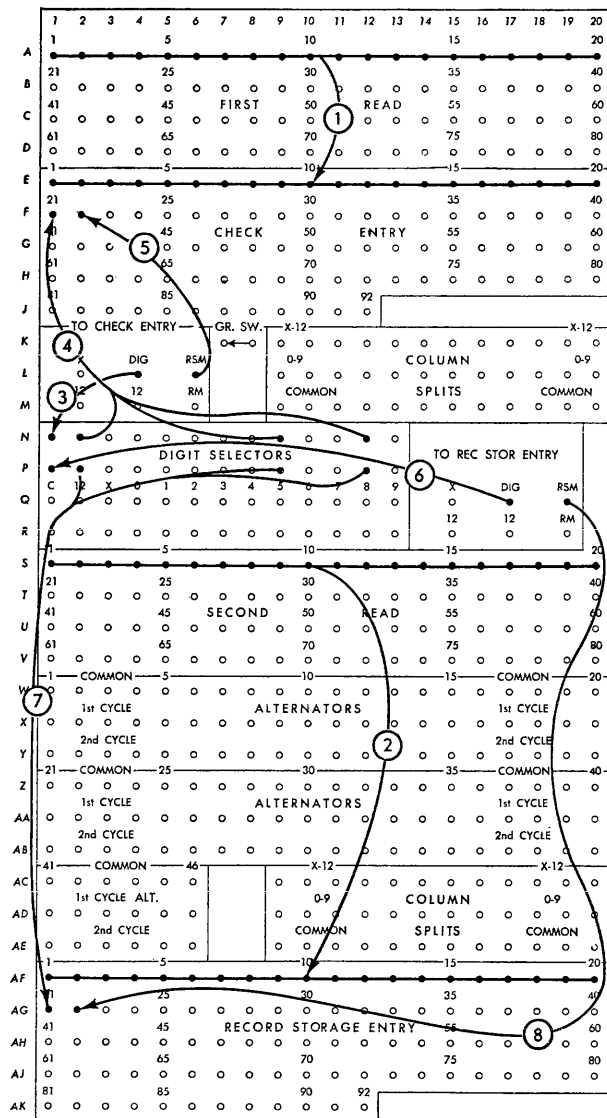

FIGURE 107. WIRING, CARD READING

6. The digit hub of the record storage entry emitter is wired to the C hub of a digit selector.
7. The 12, 8 and 5 hubs of the digit selector are wired to the 21st position of the record storage entry.
8. The record storage mark from the record storage entry emitter is wired to the 22nd position of record storage entry.

Control Panel Wiring, Card Reading, Signing Fields

Field A is read from card columns 71-75. The field is to be signed plus when read into memory. Field B is read from card columns 76-80 and is to be signed minus when read into memory. Only the wiring for signing fields is shown in Figure 108.

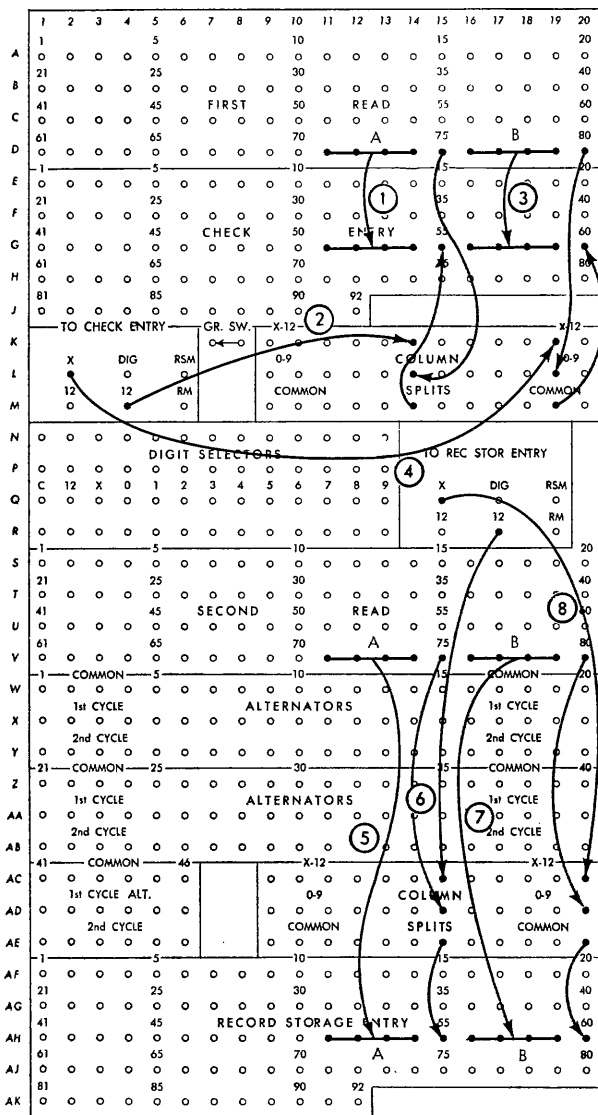

FIGURE 108. WIRING, CARD READING, SIGNED FIELDS

1. Field A is wired from first read to positions 51-55 of the check entry. Column 75 from first read is wired to the 0-9 hub of a column split. The common hub of the column split is wired to the 55th position of check entry.

2. A 12 impulse (plus) is wired to the 11-12 hub of the same column split. The character read into position 55 of the check entry is the numerical punching from the card with the 12 zone included to sign the field plus in the check entry.

3. Field B is wired from first read to positions 56-60 of the check entry. Column 80 from first read is wired to the 0-9 hub of a column split. The common hub is wired to the 60th position of check entry.

4. An X impulse (minus) is wired to the 11-12 hub of the same column split. The character read into position 60 of the check entry is the numerical punching from the card with the X zone included to sign the field minus in the check entry.

5. Field A is wired from second read to positions 51-55 in the record storage entry. Column 75 from second read is wired to the 0-9 hub of a column split. The common hub of the column split is wired to the 55th position of the record storage entry.

6. A 12 impulse (plus) is wired to the 11-12 hub of the same column split. The character read into position 55 of the record storage entry is the numerical punching from the card with the 12 zone included to sign the field plus in memory.

7. Field B is read from second read to positions 56-60 in the record storage entry. Column 80 from second read is wired to the 0-9 hub of a column split. The common hub is wired to the 60th position of record storage entry.

8. An X impulse (minus) is wired to the 11-12 hub of the same column split. The character read into position 60 of the record storage entry is a combination of the numerical punching from the card and the X zone emitted from the character emitter. The field is therefore always signed minus.

Control Panel Wiring, Grouped Records

Two card records may be read into record storage and transferred to memory by a single read instruction. A record mark may be emitted from the card reader control panel to define the two records in memory or to control a receive and transmit operation. The total number of characters read from the two cards plus the record marks may not exceed the total record storage capacity of 92 positions. Identical columns are read from each card of the group up to a maximum of 46 columns per card if no record mark is emitted.

Columns 1-10 and 15-20 are to be grouped from two card records into memory, by the wiring shown in Figure 109.

1. Columns 1-10 and 15-20 are wired from first read to check entry. Any positions of check entry may be used. The comparison between the first and second reading stations is an odd-even row count and does not involve individual card columns. Therefore, it is only necessary to wire the same number of im-

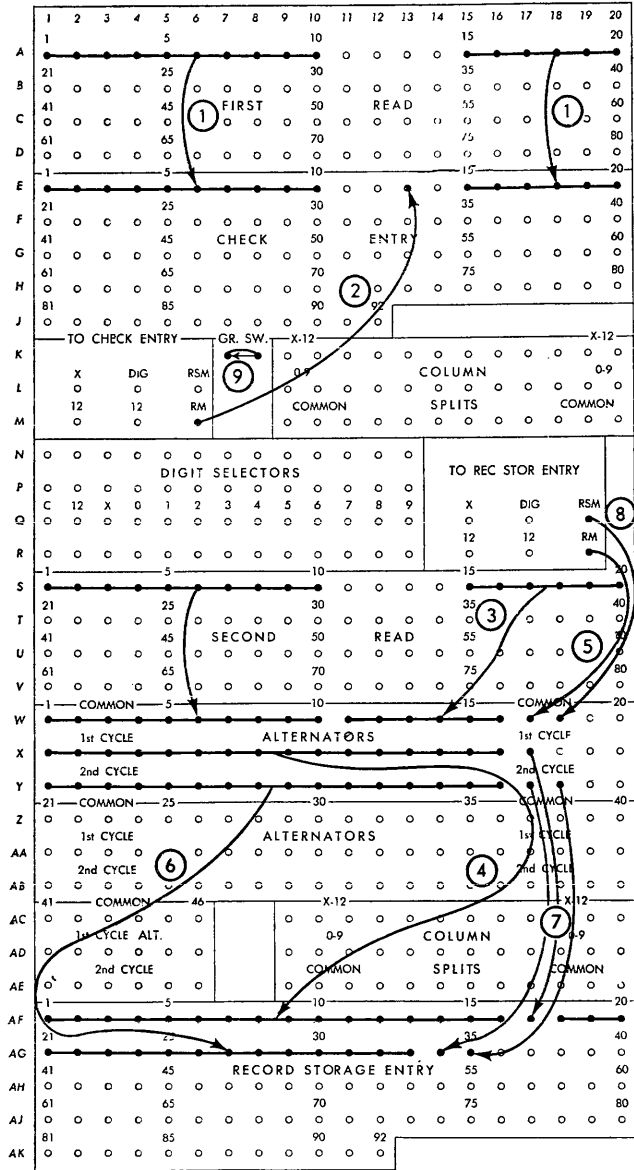

FIGURE 109. WIRING, GROUPING RECORDS

pulses to check entry that are wired to record storage entry.

2. A record mark is wired to a position of the check entry.

3. Columns 1-10 and 15-20 are wired from second read to the common hubs of the alternator. Any sixteen common hubs may be used.

4. The sixteen hubs of first cycle, corresponding to the sixteen common hubs wired from second read, are wired to positions 1-16 of record storage entry.

5. A record mark is wired from the record storage emitter to a common hub of the alternator.

6. The sixteen hubs of second cycle, also corresponding to the sixteen common hubs wired from second read, are wired to positions 18-33 of record storage entry.

7. A record mark is wired to positions 17 and 34 of record storage entry from the alternator first and second cycle hubs.

8. The record storage mark is wired to a common hub of the alternator. From first cycle of the corresponding alternator hub, the RSM is wired to check entry. From second cycle, it is wired to the 35th position of record storage entry. The RSM is placed only once in both check and record storage entries.

9. The two hubs of the group switch are wired together.

CARD PUNCH, TYPE 722

THE CARD Punch (Figure 110) punches cards at a rate of 100 cards per minute.

When a write or write and erase instruction is given, the record from memory is sent to the record storage unit of the card punch at the high internal speed of the 705. The machine then continues with its program while the card is being punched. Information is punched in the same order in which it is sent from memory.

The maximum record length that can be punched on a single card is 80 characters. Records that are longer than 80 characters will be punched in successive cards with a single write or write and erase instruction. The write status will be maintained and subsequent operations will be delayed until the last block of characters in the record has been entered into record storage, as indicated by the sensing of a group mark in memory.

Checking is suppressed on all portions of a multiple-card record, except that portion which is punched in the last card. For a complete check, the record can be divided into successive 80-column records by proper placing of a group mark in memory. Each section of the record may then be written and checked as separate unit records of 80 characters each.

The card punch has no signal device corresponding to the input-output indicator of other input-output units. If the punch runs out of cards, it will not respond to the next write instruction.

Operating Keys and Lights

Start Key. This key is provided for the run-in of cards. When the hopper is first filled, depressing the start key once causes one card to be fed to the punching station. A second depression turns on the calculator interlock, making the card punch available for operation under 705 control. If the hopper becomes empty during the program, the calculator interlock is turned off and the card punch will not operate under 705 control until the hopper has been refilled and the start key has been depressed.

Stop Key. Depressing this key causes the calculator interlock to be turned off and the card punch to stop operating. After a feed error, it can also be used to turn off the feed check light after all the cards have been removed from the feed and hopper.

Feed Key. This key provides a manual feed without punching the cards in the machine and is operative only when the calculator interlock is turned off.

Ready Light. The ready light is on whenever the calculator interlock is turned on. It indicates that the card punch is ready for operation under control of the 705.

Select Light. This light is on whenever the card punch is selected and remains on until another input-output unit, check indicator, or alteration switch is selected.

Feed Check Light. A card jam or failure to feed will turn on this light and turn off the calculator interlock. The light will go off after all the cards have been removed from the feed and hopper and the stop key has been depressed.

PRINTER, TYPE 717

THE 705 can be equipped with any practical number of printers (Figure 111) for report printing. Each printer, a modified IBM Type 407, has 120 print wheels with 47 characters each. The maximum printing speed is 150 lines per minute. When a printer is selected and a write or write and erase instruction is given, a record is sent from memory to record storage at the high internal speed of the 705. The program is continued as soon as record storage is filled, without delay while the record is being printed.

Information within each line is printed in exactly the same arrangement in which it is stored from memory. Therefore, all the necessary arranging of data must be done in memory.

Records longer than 120 characters are printed on successive lines by a single write or write and erase instruction. The machine sends 120 characters at a time to the printer record storage unit to be printed. The write status is maintained and subsequent operations are delayed until the last block of characters in the record has been entered into record storage as indicated by the sensing of a group mark in memory.

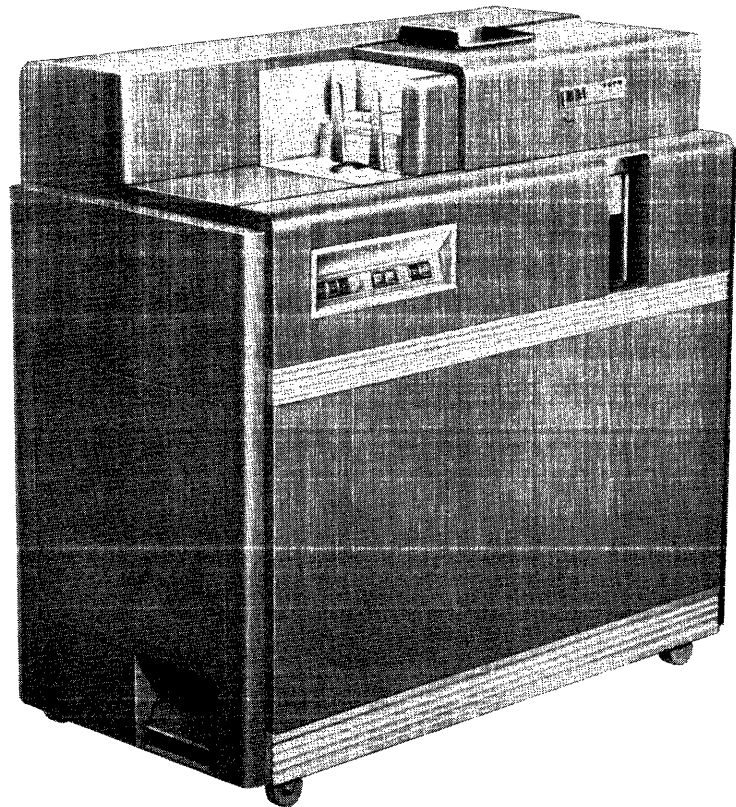

FIGURE 110. CARD PUNCH

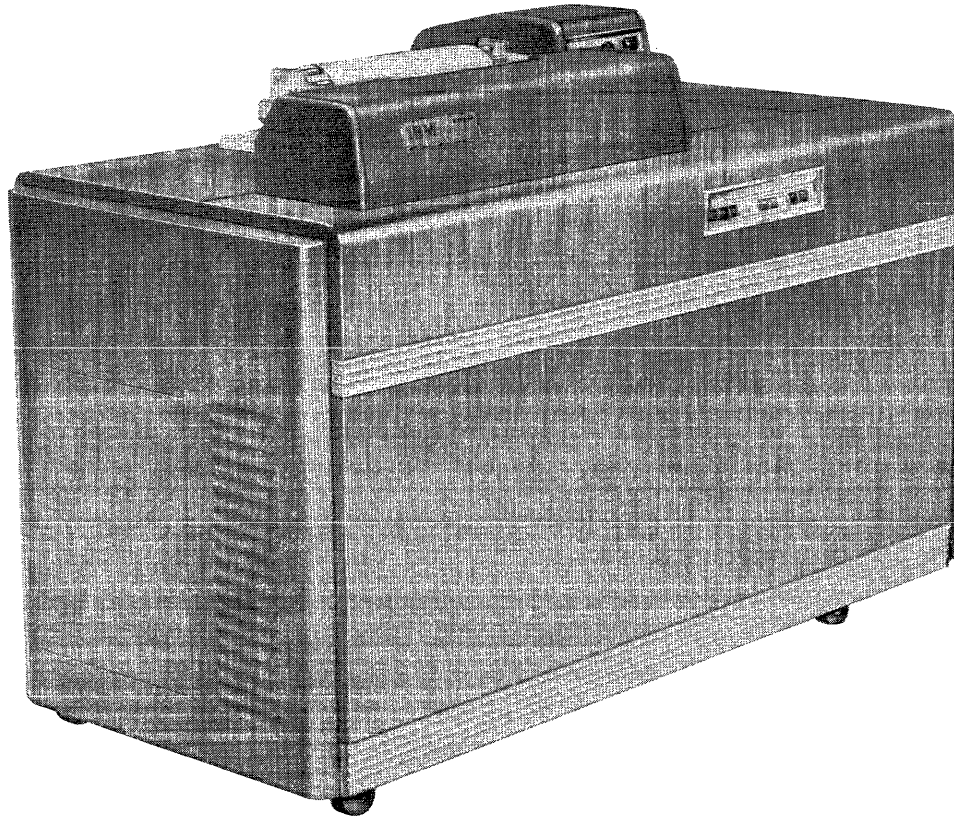

FIGURE 111. PRINTER

Figure 112 shows the sequence of operations for the printer.

Carriage Control

Spacing and skipping for form control in the printer may be performed either under complete control of the program or under control of the carriage control switch. (Refer to section "Tape-Controlled Carriage.")

Form Control Key and Stop Light

Reaching the end of paper in the printer closes the form stop and provides one of two modes of operation depending on whether or not a tape is used in the carriage.

When a tape is not used in the carriage, the printer stops when the form stop contact is closed and the form stop light goes on. Depressing the form control key once allows the printer to operate for one print

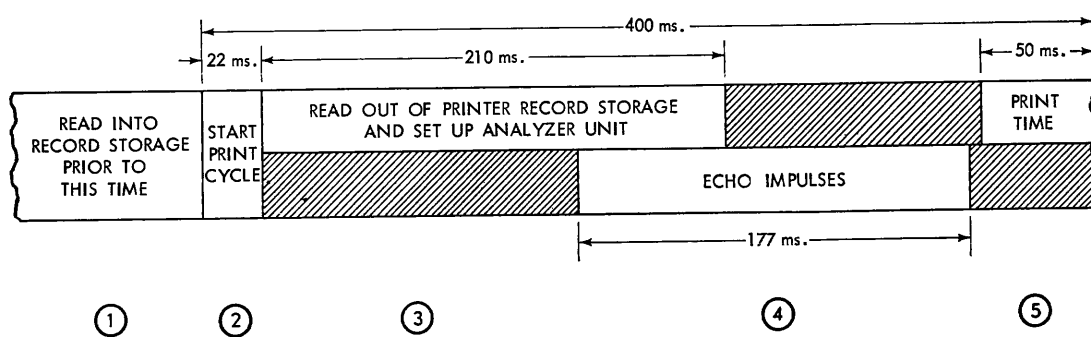

FIGURE 112. PRINTER SEQUENCE OF OPERATIONS

cycle. As long as the form control key is held down, the printer remains available and continues to print.

When a tape is used in the carriage, channel 1 must be punched as the first printing line. The printer does not stop when the form stop contact closes. After the form stop has closed and channel 1 is sensed, the printer stops before printing on the next form and the form stop light goes on. This indicates that the carriage has moved from one form to another. The operator now has two options:

1. Manually feed new forms of paper into the carriage, thereby opening the form stop contact. Depress the form control key to turn off the form stop light and allow the printer to continue.
2. Depress the form control key and thereby turn off the form stop light and allow the printer to continue until the closed form stop contact and channel 1 condition again stops the printer.

This arrangement provides for the printing of one or several forms before finally stopping the printer and inserting additional paper.

Operating Keys and Lights

Start Key. Depressing the start key once causes the printer to go through a clearing cycle. The input-output indicator is turned off during the clearing cycle. Depressing this key again turns on the calculator interlock which makes the printer available for operation under control of the 705. When the calculator interlock is turned on, the start key is no longer operative.

Stop Key. This key causes the calculator interlock to be turned off and the printer to stop operating.

Form Control Key. This key controls the operation of the printer when the form stop closes.

Select Light. This light goes on when the printer is selected by the select instruction and remains on until another input-output unit, check indicator, or alteration switch is selected.

Ready Light. The ready light indicates that the calculator interlock is turned on and the printer is ready for operation under control of the 705.

Form Stop Light. This light indicates that the printer is running out of paper.

Platen Clutch. When the arrow on the knob is pointing upward, the platen clutch is engaged and the platen can be turned only by the vernier knob.

When the clutch knob is turned to the right, the platen clutch is disengaged and the platen then can be turned manually by the platen knob.

Restore Key. When this key is depressed, the carriage is restored to channel 1 or home position. On the first print cycle thereafter, skipping may take place only to channels 2 through 9 of the carriage tape. Any attempt to skip to channel 1 or to single or double space will be ignored on this printing line. If the platen is engaged, the platen itself moves with the carriage. If the platen is disengaged, it will not be restored with the carriage.

Stop Key. Depression of this key stops the carriage operation instantly and the printer at the end of the cycle.

Space Key. When the printer is stopped, a form can be advanced one space at a time by depressing this key.

Carriage Control Switch. The carriage control switch has three positions: single space, double space, and program. In the single or double position, the spacing of the form is automatic and will be single or double depending on the setting of the switch. Either of these two positions causes the first character of a record to be printed. In program position the spacing of the form will be under the control of the first character of the record which in this case will not be printed. For automatic overflow, channels 1 and 12 of the carriage tape must be punched so that sensing of the channel 12 punch will initiate the overflow to the channel 1 punch.

TYPEWRITER

A TYPEWRITER (Figure 113) is supplied for the 705 console. It can be used to print a portion of memory one character at a time. The speed of typing is approximately 600 characters per minute. The typewriter has no record storage unit and prints directly from memory. All other operations of the machine are held up during the use of the typewriter.

Special instructions to the operator, control totals, exception records, and so on, may be programmed to be written by the typewriter, or the contents of any portion of memory may be examined by manually selecting the typewriter and using the write instruction in the usual way.

Sensing the right-hand margin or the end of record causes a carriage return and automatic spacing accord-

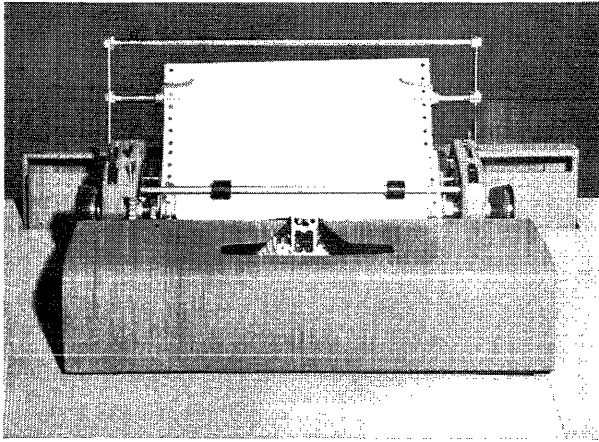

FIGURE 113. TYPEWRITER

ing to the setting of the space control on the carriage. The group mark prints as a \square when the write 01 instruction is used.

Any character not on the code chart will print as a question mark on the typewriter. A plus zero and a minus zero will print as a plus sign and dash, respectively. A record may be arranged in memory, before printing, to fit a report form.

MAGNETIC DRUM STORAGE UNIT, TYPE 734

DRUM storage on the 705 consists of one or more 60,000-character drums (Figure 114), each divided into 300 addressable sections. Each section can store 200 characters. The addresses 1000 and over have been reserved for drum section selection. The present four-digit addressing system of the 705 can accommodate thirty drums with a total of 9000 sections or a total drum capacity of 1,800,000 characters. The average time required to locate the first character position of a drum section for subsequent reading or writing is 8.0 milliseconds. This is termed access time. Thereafter, characters can be read from or written consecutively on the drum at a rate of one character in .040 milliseconds.

Drum operation is initiated by a select instruction. The address part of the instruction specifies the drum section desired. Assuming a 705 had several drums, the following system would exist: addresses 1000-1299 would pertain to the sections on the first drum; addresses 1300-1599 would pertain to the sections on the second drum; addresses 1600-1899 would pertain to the sections on the third drum; and so on.

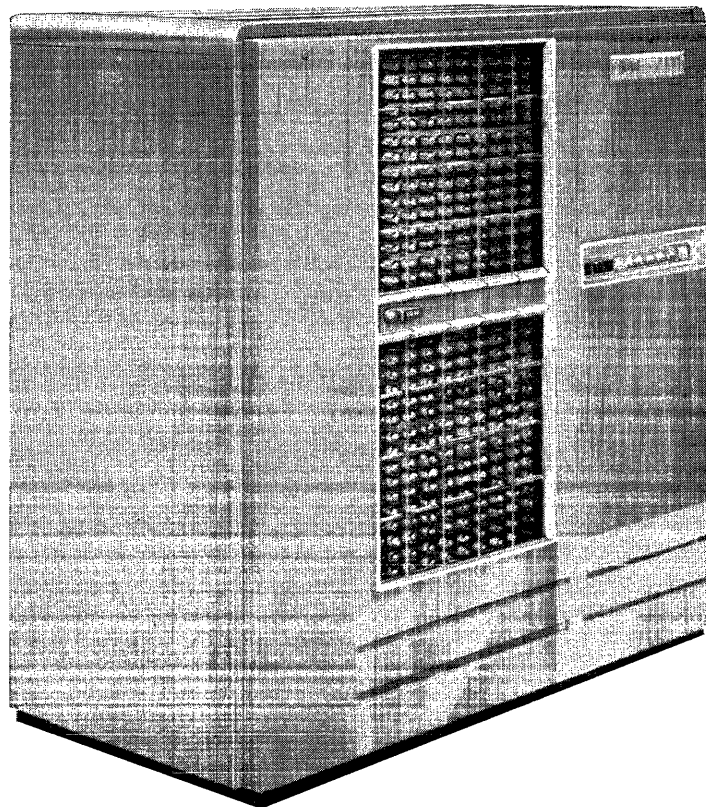

FIGURE 114. MAGNETIC DRUM STORAGE UNIT

After a select instruction has been given, specifying the drum section desired, a read, write, or write and erase operation may then be called for.

Reading from the Drum

During a read operation, information read from the drum starts with the first character of the section previously selected. This character is read into the memory location specified by the address part of the read instruction. Reading continues from successively higher drum locations into successively higher memory addresses until the drum mark is sensed.

Writing on the Drum

During a write or write and erase operation, information is written from memory starting at the address specified by the instruction and continues to higher memory addresses until a group mark is sensed. Sensing the group mark terminates the operation and causes a drum mark to be emitted on to the drum after the last written character.

Transferring Drum Operations

Operation will not proceed automatically from one drum to the next, and any attempt either to read or write off the end of a drum will cause the read-write check indicator and the input-output indicator to be turned on. The input-output indicator may be turned off by the IOF instruction.

Both reading and writing operations with drum storage are terminated by a drum or group mark. Operations can therefore pass from one drum section to the next on the same drum until a drum or group mark is sensed.

MAGNETIC TAPE UNIT, TYPE 727

THE 705 can be equipped with any practical number of tape units (Figure 115). Information is recorded on the oxide coated plastic tape in the form of magnetized spots. A character is represented transversely across the width of the tape by seven bit positions, including the check bit. Information is recorded at a longitudinal density of 200 characters to the inch.

The end of the record is indicated by a $\frac{3}{4}$ -inch inter-record gap. Records of any length may be stored on magnetic tape, limited only by the memory facilities of the 705.

The end of recorded information on tape is indicated by a tape mark which appears after the inter-record gap that follows the last record.

Records are recorded on reels of tape $10\frac{1}{2}$ inches in diameter and 2400 feet long. Tape may be read in a forward direction or backspaced at a rate of 75 inches per second. Tape can be rewound at an average rate of 500 inches per second. It takes an estimated 1.2 minutes to rewind a complete reel, allowing for acceleration and deceleration time.

Changing tape reels on the unit takes approximately 1.5 minutes for loading and unloading. Reflective spots are photoelectrically sensed to indicate the physical end of a tape and the load point.

Tape unit instruction circuits are contained in a tape control unit, which can handle up to ten tape units; the 11th to 20th tape units require a second control unit; and so on.

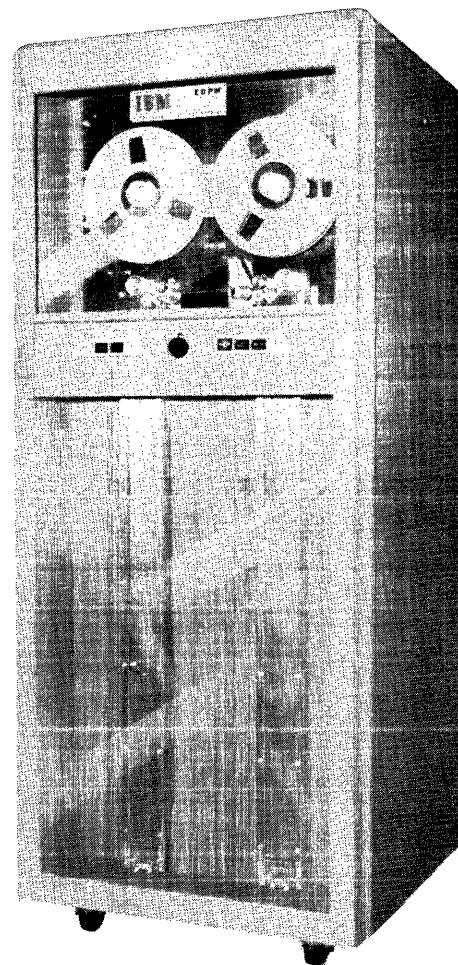

FIGURE 115. MAGNETIC TAPE UNIT

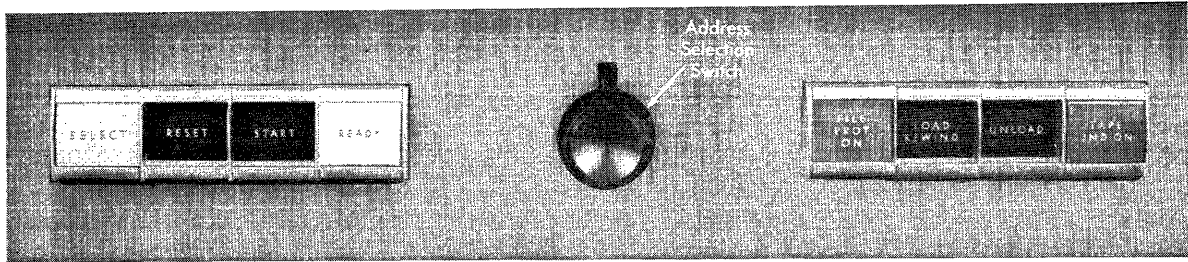

FIGURE 116. KEYS AND LIGHTS, MAGNETIC TAPE UNIT

Operating Keys and Lights (Figure 116)

Select Light. This light is on when a select instruction specifies the address of the corresponding tape unit. It remains until another input-output unit, check indicator, or alteration switch is selected.

Reset Key. Depressing this key resets the tape unit to manual control (except the input-output indicator). It changes a high-speed rewind to a low-speed rewind, stops a low-speed rewind, and in general stops any tape operation which has been initiated previously.

Start Key. Depressing the start key places the tape unit under the control of the 705 and causes the ready light to be turned on provided (1) tape has been loaded into the columns or the load-rewind key has been depressed, and (2) the reel door interlock is closed.

Ready Light. Control of a tape unit by the 705 is indicated when this light is on after the start key is depressed. The light is on provided the tape has been loaded into the vacuum columns, the reel door

interlock is closed, and the tape unit is not in the process of finding the load point (rewind or load operation). Manual control is indicated when the ready light is off, provided the tape unit is not rewinding or loading and the reel door is shut.

Address Selection Switch. A rotary switch is provided to permit the operator to set a tape unit to any of the ten addresses associated with a control unit.

File Protection Light. This light automatically turns on if the unit is loaded with a reel lacking the file protection plastic ring (Figure 117). Without the protective device on the reel, flat side facing out, the file can be read only. With the device in place, reading or writing can occur.

Load-Rewind Key. If the reel door is closed, depression of this key causes loading of the tape into the columns and searching for the load point in a reverse direction. If the tape has been manually unloaded in the fast rewind section of the tape, depressing this key executes a high-speed rewind before the load operation takes place. (See "Unload" below.)

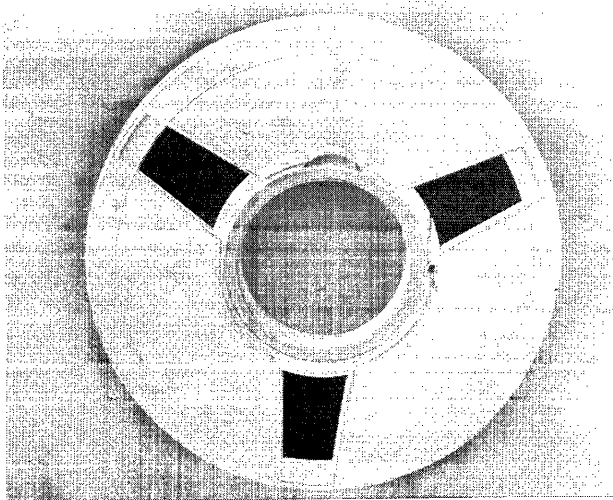

FIGURE 117a. FILE PROTECTION DEVICE ON REEL, POSITIONED FOR READING OR WRITING

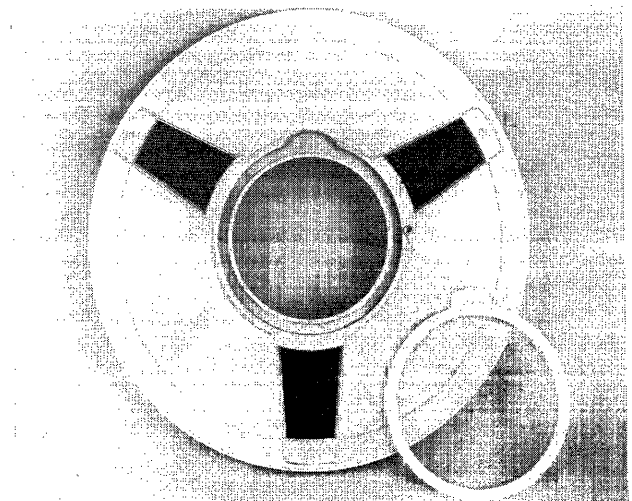

FIGURE 117b. FILE PROTECTION DEVICE REMOVED FOR READING ONLY

Operation of the start key after the load-rewind key has been depressed will set up the conditions necessary for automatic reversion to 705 control as soon as the load point is reached. The load-rewind key is inoperative unless the tape unit is under manual control.

Unload Key. Operation of this key will remove the tape from the columns and raise the head cover regardless of the distribution of tape on the two reels. If the tape is not at load point when the operator wishes to change it, a load point search should be first initiated by depression of the load-rewind key. Depression of the unload key will also reset the input-output indicator. This key is inoperative unless the tape unit is under manual control and tape is in the vacuum columns.

Tape Indicator On. The input-output indicator light is turned on by an ION instruction on the selected tape unit, by reaching a tape mark while reading, or by reaching the reflective spot while writing. It will be turned off by an IOF instruction on the tape unit last selected or by depression of the unload key.

Reel Door Interlock. When the door is open, this interlock contact will prevent any normal operation of the tape unit.

Reel Release Switch. Two switches are provided, one for each reel. The left switch releases the left reel clutch, the right switch releases the right reel

clutch. When switches are depressed, reels may be turned manually.

Operation

The 705 operation of a tape unit is initiated by a select instruction specifying the address of the particular tape unit desired. A subsequent read, write, write and erase, or control instruction causes that tape unit to perform the required operation. The sensing of a tape mark while reading the tape turns on the input-output indicator which will remain turned on until turned off by an IOF instruction, or until the unload key is depressed. A tape mark can be recorded on a selected tape unit only by a WTM instruction. A rewind operation can be called for with a RWD instruction after a select instruction. In writing on a tape, sensing the end of tape by the reflective spot turns on the input-output indicator.

The tape can be backspaced one unit record by a select instruction followed by a BSP instruction. Do not, however, insert a record within a file.

OPERATOR'S CONSOLE

THE OPERATOR'S console, a separate unit of the 705 (Figure 118), may be placed conveniently in the installation within input-output cable length restrictions. The console is used to:

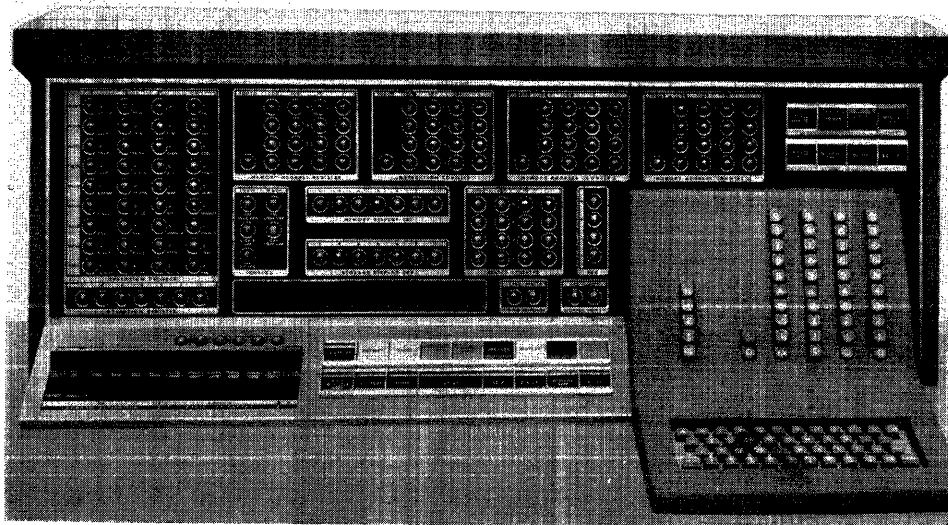

FIGURE 118. OPERATOR'S CONSOLE

1. Control the machine manually.
2. Correct errors.
3. Determine the status of machine circuits, registers and counters.
4. Determine the contents of memory and accumulator storage.
5. Revise the contents of memory.

The lights and keys on the console are explained under the numbers indicated on the console panel diagram, Figure 119.

1. Operation Decoder

There are 36 neon lights in this section. Thirty-five of the lights represent the 35 machine instructions and are turned on as each instruction is executed. Both the instruction abbreviation and the operation part are printed beside each light. The binary code decimal notation on the left side represents the digits 1 through 9. The binary code across the top represent the zones. For example: The operation part for NOP is A. The binary code for A is zone 11 and numerical 0001.

2. Operation Register

The operation part of an instruction being executed is displayed in the 705 character code by neon lights in the operation register.

3. Memory Address Register (MAR)

The address part of the instruction is displayed by the memory address register neon lights. Sixteen neon lights are used to display the units, tens, hundreds, and thousands positions of the address part of the instruction being executed. One neon light is used to display the ten-thousands order position of the address.

4. Instruction Counter (IC)

The seventeen neons in this section show the memory address contained in the instruction counter.

5. Memory Address Counter I (MAC I)

The seventeen memory address counter neons display the address of the next character position to be operated upon in memory. The operation of the machine, while executing an instruction, is divided into two parts:

The reading and interpreting of the instruction, called instruction time.

The actual execution of the instruction, called execution time.

The instruction counter and memory address counter I are both involved in the reading of an instruction. At the beginning of instruction time, the instruction counter is already set to the memory address of the right-hand digit of the instruction. At the end of the execution of the preceding instruction, memory address counter I is set to the same address. During instruction time the address part of the instruction is read into the memory address register. The operation part of the instruction is read into the operation register.

At the end of instruction time, the instruction counter is stepped five addresses higher to the address of the right-hand digit of the next instruction in the program. It remains in this position during execution time.

During the normal preparation for executing an entire program, the reset key is depressed setting the instruction counter to memory address 0004. When the start key is depressed, the sequence of operations just described occurs in reading the instruction.

The instruction counter may be manually transferred to the address of any instruction in memory. When this is done, the reading operations are the same except that they begin at the address of the right-hand digit of the instruction transferred to.

The machine automatically executes the instruction during execution time, performing different series of actions for different instructions. During execution time, memory address counter I is changed to the different addresses in memory as necessary to control the information which is read out of or stored in memory.

When a simultaneous reading and writing operation is performed, memory address counter I controls the information being written out of memory. When a receive and transmit operation is performed, memory address counter I controls the information being transmitted.

At the end of execution time, memory address counter I resets to the address position of the instruction counter, which has been positioned at the next instruction. The same operations described for instruction time are repeated for that instruction. The

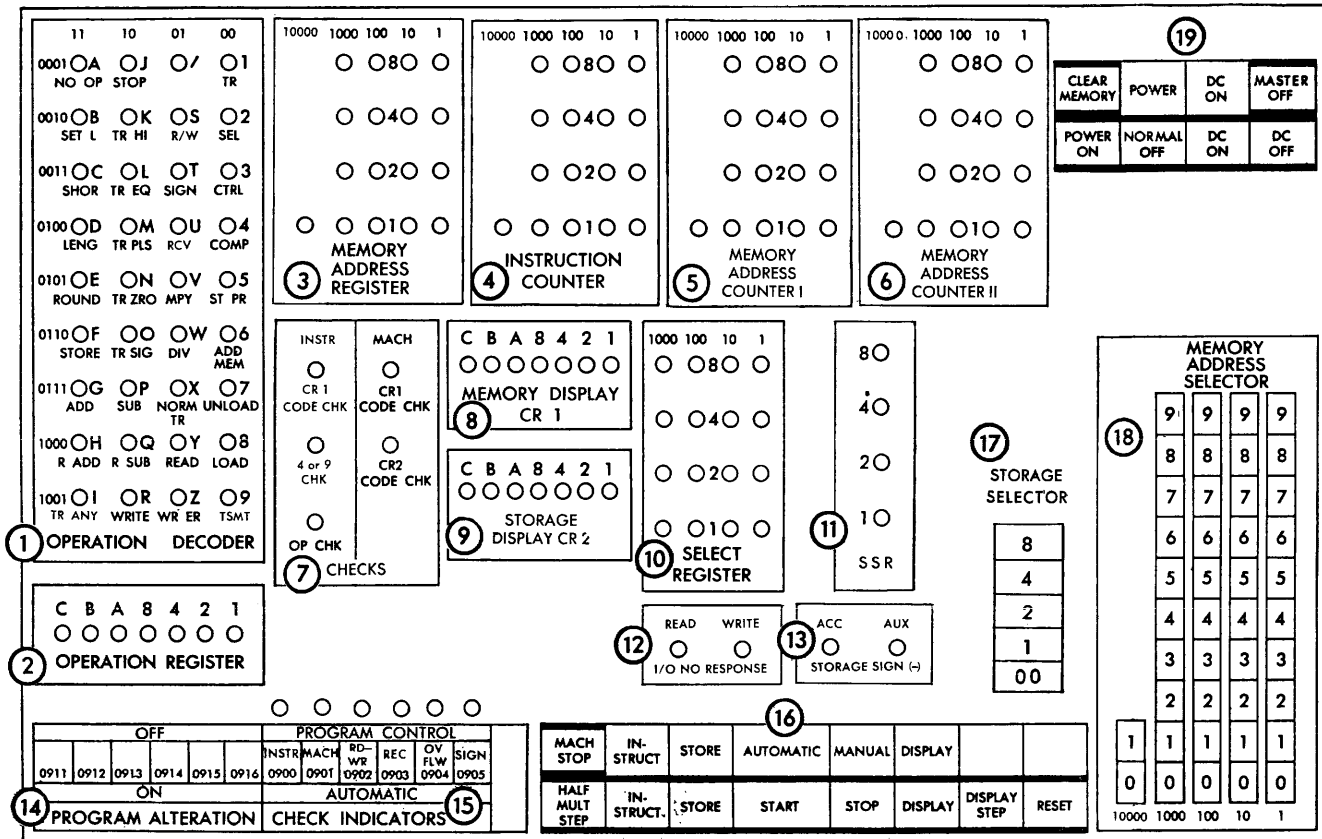

FIGURE 119. SCHEMATIC, OPERATOR'S CONSOLE

counter continues to count, instruction by instruction, to successively higher memory addresses until it reaches the end of the program or a transfer to a different series of instructions.

6. Memory Address Counter II (MAC II)

Seventeen neon lights display the contents of memory address counter II. This counter operates in conjunction with MAC I to control information read into memory during a read-while-writing operation or to control information being received during a receive-and-transmit operation.

7. Checks

The check stop neon lights display the cause of a stop which occurs because of an instruction check or a machine check.

INSTRUCTION CHECK LIGHTS

CR1 Code Check. This light turns on when there is a character code error in the units position of the address part of the instruction or in any of the five characters in the memory buffer register.

Not 4 or 9. This neon light turns on when the units position of the address part of any transfer instruction, or the transmit instruction specifying accumulator 00, is not 4 or 9.

Operation Check. This neon light turns on when the operation part of an instruction is any character which is not a valid code construction, or when the operation decoder does not function properly.

MACHINE CHECK LIGHTS

CR1 Code Check. This light turns on when there is a character code error in the character last used in memory or in any one of the characters affected by a five-character transmit instruction.

CR2 Code Check. This light turns on when there is a character code error in the character last read from storage.

8. Memory Display CR 1 (Character Register)

The seven lights in this unit indicate in 705 code form the character most recently read from memory. The address of the next character to be read is displayed in MAC I.

9. Storage Display CR 2 (Character Register)

The seven neon lights in this unit indicate in 705 code form the character most recently read out of storage. Any one of the sixteen storage units may be selected by the storage selector switches.

10. Select Register (SR)

The sixteen neon lights on the select register display in 705 code form the number of the device last selected. The number is shown for that device until another device is selected.

11. Storage Select Register (SSR)

Four neon lights display the contents of the storage select register and indicate, in straight binary form, which one of the storage units has been selected for use while executing the current instruction.

12. I/O (Input-Output) No Response

Two neon lights, one for read and one for write, will indicate that a no-response signal has been received from an input or output unit after it has been selected and has been told to read or write. The proper light will go on when the selected unit does not exist, when an addressed unit is not in "ready" status, or for conflicting instructions such as select 0100 and write, or select 0400 and read.

The machine stops in automatic status when any of these conditions exists. Depressing the machine stop key causes the machine to go from automatic to manual status.

13. Storage Sign (—)

Aux. The auxiliary storage sign neon lights when the sign of the field stored in the *last-used auxiliary storage unit is minus*. The use of other storage units may subsequently change the auxiliary storage sign to plus. In this case, the minus field in one or more auxiliary storage units is not indicated by the neon when the sign of the field in the last-used unit is plus.

Acc. The accumulator storage sign neon lights when the sign of the field stored in the accumulator is minus.

14. Alteration Switches

Each alteration switch has a specific address. If a switch is on when interrogated by the program, a

transfer is made. If the switch is off, no action takes place. Six alteration switches are provided.

15. Check Indicators (Neons and Switches)

Six switches are provided, one for each of the check indicators. When a switch is turned to AUTOMATIC, the machine will stop when the corresponding error occurs. When the switch is turned to PROGRAM, the error condition will be indicated, but the course of action is determined by the program. (See "Check Indicator.") Each switch is associated with a light above it to indicate when the indicator is on:

0900—*Instruction Check*. If the switch is turned to AUTOMATIC and an error occurs, the machine will stop with MAC I indicating the address of the instruction in error.

0901—*Machine Check*. If the switch is turned to AUTOMATIC and an error occurs, the machine will stop with MAC I indicating the address of the character in error.

{ 0902—*Read-Write Check*.

{ 0903—*Record Check*. If the switch is turned to AUTOMATIC and an error occurs, the machine will stop after a complete record has been read or written.

{ 0904—*Overflow Check*.

{ 0905—*Sign Check*. If the switch is turned to AUTOMATIC and an error occurs, the machine will stop with MAC I indicating the address of the character one position from that which was in error.

16. Operation Controls

Machine Stop. When an internal operation is being performed, depressing the machine stop key stops the machine immediately. The stop can occur during the execution of an instruction such as an arithmetic or writing operation. The operator must manually transfer to the desired instruction before depressing the start key. In this case, the instruction transferred from is not completed.

The machine stop key should be used only to interrupt input or output operations or to stop the machine when the manual stop key is not effective.

Instruction (Key and Yellow Light). To instruct the machine manually, the procedure is:

1. Depress the instruction key. If the machine is in automatic operation, it will stop after the current instruction is executed exactly as if the manual stop key had been depressed.
2. Key the address part of the instruction in the memory address selector (either before or after depressing the instruction key).
3. Key the desired storage unit in the storage selector.
4. Key the operation part of the instruction in the keyboard.

The instruction and manual lights go on as soon as the instruction key is depressed. The instruction status continues until superseded by another mode of operation. Subsequent instructions may be keyed in without re-depressing the instruction key.

Depressing the start key causes the machine to continue from the point in the program at which it was interrupted, unless one or more of the transfer instructions are executed under manual control.

Store (Key and Yellow Light). To store information in memory manually, the procedure is:

1. Depress the store key. If the machine is in automatic operation, it will stop after the current instruction is executed, exactly as if the manual stop key had been depressed.
2. Key the memory address where the first character of information is to be stored in the memory address selector.
3. Key the characters to be stored in the keyboard. The first character is entered into the memory position specified by the memory address selector. Subsequent characters are entered into successively higher memory positions.

The store and manual lights go on when the store key is depressed. After one or more characters have been stored, the operator may select another memory address on the memory address selector. Depressing the store key a second time causes the next character to be stored to go into the memory location specified by the second setting of the address selector.

The store status will continue until superseded by another mode of operation.

Depressing the start key will cause the machine to continue in automatic operation from the point in the program at which it was interrupted.

Display (Key and Yellow Lights). Depressing the display key when the machine is running causes the machine to stop as though the manual stop key had been depressed. In addition, it prepares the machine for reading a character from memory and from storage, upon subsequent depression of the display step key.

The character read from memory is displayed on the memory display (CR1) neons. If the character code check indicates an error in the memory character being displayed, the CR1 code check neon will light but will not turn on the machine check indicator.

The character read from storage will be displayed in the storage display (CR2) neons. If the character code check indicates an error in the storage character being displayed, the CR2 code check neon will light but will not turn on the machine check indicator.

The first memory character displayed will be the one located at the address specified by the memory address selector. Subsequent characters will be displayed from successively lower memory positions.

The first storage character displayed will be the one located at the right-hand position of the storage unit selected by the storage selector switches. Successive depressions of the display step key will display successive storage characters to the left.

The position of the next memory character to be displayed in the CR1 neons is indicated by the MAC I neons.

Depressing the display key after the display step key has been depressed will cause the next characters to be displayed from the addresses specified by the memory address and storage selector switches.

When the display key is depressed, the display light and the manual light will go on. Depressing the start key will cause the machine to resume operation as though it had not been interrupted.

Manual-Stop (Key and Red Light). Depressing the stop key will cause the machine to stop after executing the current instruction. The manual light goes on when the machine is stopped. This is the normal way to stop operation. After the stop key is depressed, the machine is left in manual status and is prepared to respond to any manual function or to start automatic operation if the start key is depressed.

Certain other keys will also cause the machine to stop before their special functions begin. These are:

Store key	Display key
Instruction key	Half-multiple step key

Depressing the start key causes the machine to resume operation as if it had not been interrupted.

Half-Multiple Step. Depressing this key causes the machine to operate in half-steps. One depression causes the machine to read an instruction. A second depression causes the machine to execute the instruction. If the key is held depressed for more than one second, the machine will alternately read and execute instructions at the rate of about ten per second, as long as the key is held. If the machine is running when the key is depressed, it will stop after executing the current instruction. Depressing the start key will cause the machine to run at its normal speed, starting at the point at which it stopped after the half-multiple step key was last depressed.

Automatic-Start (Key and Green Light). Depressing the start key, if the machine is stopped, causes it to run at its normal high-speed rate, starting with the instruction at the address indicated by the instruction counter neons. Operation will continue as indicated by the automatic light until a programmed stop or an automatic check stop occurs, or until the machine is made to stop by depressing one of the control keys provided for this purpose.

Depressing the start key resets all of the check indicators off. If an instruction error has occurred (0900) and the switch associated with the indicator is set to AUTOMATIC, depressing the start key causes the machine to continue execution of the improper instruction. The instruction check light is then turned on again immediately. The operator should manually correct the instruction or transfer to another instruction before restarting the machine.

If a machine error has occurred (0901) with the machine check switch set to AUTOMATIC, the machine may stop before completely executing the instruction involving the error. Depressing the start key turns off the check indicator, but an attempt to complete the instruction turns it on again at once. A correction should be made before operation can continue.

If check indicator 0902, 0903, 0904 or 0905 is on with its associated switch set to AUTOMATIC, depressing the start key causes the machine to execute the next instruction. The indicator is reset off.

Depressing the start key when the machine is in automatic operation has no effect.

Reset. The reset key restores all checking circuits to normal and sets the instruction counter to 0004. These functions are also performed automatically whenever the power is turned on and the machine voltages have reached their required level. The reset key is operative only when the machine is stopped. It has no effect if depressed when the machine is in automatic operation.

Clear Memory. Depressing the clear memory key, if the machine is stopped, causes memory to be filled with blanks (1 01 0000) and storage to be filled with storage marks (0 00 0000). All check indicators are turned off and the instruction counter is set to 0004. Depressing this key while the machine is in automatic status has no effect. These functions are also performed automatically whenever the power is turned on and the machine voltages have reached their required level.

17. Storage Selector

The storage selector keys are used to select the storage unit to be used while executing a manual instruction, or when displaying it. It consists of one group of five keys. Four of the keys represent four binary ones valued 1, 2, 4 and 8, and are so labeled. These four keys are used to select the auxiliary storage unit to be used. The selection is done in straight binary coding and a depressed key indicates a binary one in that position. Each of the four keys will remain down when depressed. The fifth key (labeled "00") is depressed to select the accumulator storage unit. Depressing this key causes the other four to release. Depressing any of the five keys while the machine is in automatic operation will have no effect.

18. Memory Address Selector

The memory address selector consists of four groups of ten keys each numbered from 0 through 9, and one group of two keys numbered 0 and 1. The first four groups are used to select the units, tens, hundreds and thousands positions of the address and the last group is used to select the ten-thousands position. The memory address selector is used to set up the address in memory when performing the manual operations instruct, store, or display.

During manual instruct the memory address selector is set up to the address portion of the instruction to be executed. During manual store the address

selector is set up to the address of the first character to be stored in memory. During manual display the address selector is set up to the address of the first character in memory to be displayed.

Depressing the address selector keys while the machine is running in automatic operation has no effect.

19. Power Controls

Power-on (Key and Red Light). Depressing the power-on key turns on the AC and DC voltages sequentially in the machine and turns on the red power-on light. When the voltages are properly stabilized, the machine is automatically reset. The instruction counter is set to address 0004, all positions of storage units are reset to storage marks, all memory positions are reset to blanks, and all check indicators are turned off. The manual light is then turned on, indicating that the machine is ready for operation.

DC on-off (Keys and Light). Depressing the DC-on key supplies DC power to the machine and lights the DC-on light. It also accomplishes a reset in

the same manner as the power-on key. Depressing the DC-off key cuts off DC power to the machine. These keys are normally used for maintenance purposes only.

Master off. Depressing this key immediately cuts off all power to the entire machine, including the cooling system.

Normal off. Depressing this key turns off the AC-DC voltages sequentially in the machine. The machine cooling system continues to operate several minutes.

A modified card punch keyboard (Figure 118) is used to enter data or instructions into memory while the machine is in store status. The operation part of an instruction is keyed on the keyboard while the machine is in instruction status. (Refer to instruction and store keys.)

Alphabetic characters on the keyboard are arranged in sequence from left to right in the top three rows of keys. The bottom row has numerical digits in the lower case position; special characters in the upper case position. Upper case key and a test key are also provided.

Instruction	Mnemonic Code	Oper. Part	From	To	Remarks	Limiting Factor	Time in Milliseconds	Page
Add	ADD	G	Mem.	Acc./AS	Result in accumulator or aux. stor.	Non-num. char. in mem.	.034 + .017N	25
Add Mem	ADM	6	Acc./AS	Mem.	Signed memory field — algebraic addition	Non-num. char. in mem.	.034 + .017N	49
					Unsigned mem. field — non-algebraic and zone addition	Acc./Aux. Stor. mark	.034 + .017N	
Compare	CMP	4			Accumulator or aux. stor. with memory	Acc./Aux. Stor. mark	.034 + .017N	41b
Ctrl 0000	IOF	3			Turn off input-output indicator		.068	47
Ctrl 0001	WTM	3			Record tape mark		10.0	47
Ctrl 0002	RWD	3			Rewind tape unit		.051 + rewind time	47
Ctrl 0003	ION	3			Turn on input-output indicator		.051	48
Ctrl 0004	BSP	3			Back space tape one record		60.00 + .067N	48
Ctrl 0005	SUP	3			Prevent printing or punching one cycle		.068	48
Divide	DIV	W			Dividend in acc. 00; divisor in mem.; Quotient in acc. 00	Non-num. char. in mem.	Refer to formula	33
Lengthen	LNG	D			Add zeros to right (accum. 00)		.051 + .017N	32
Load	LOD	8	Mem.	Acc./AS	Loads zones as well as numbers	Acc./Aux. Stor. mark	.034 + .017N	41b
Multiply	MPY	V			Multiplier acc. 00; multiplicand mem.; product acc. 00	Non-num. char. in mem.	Refer to formula	23
No Oper	NOP	A			No operation		.034	84
Norm Tr	NTR	X			Left-hand zero in accum. or aux. stor. causes transfer. Zero deleted except last zero		.051 + .017N	82
Read	RD	Y	Input	Mem.	From tape to memory	3/4" inter-record gap	10.0 + .067N	21
					From card reader to memory	Record storage mark	.068 + .0335N	
					From drum to memory	Drum mark	8.0 + .040N	
Read-Write	RWW	S			Alert reading tape unit to operate simultaneously with next write instruction	Tape use only	.034	40
Receive	RCV	U		Mem.	Use with TMT for mem. to mem. transfer (See TMT)		.034	36
R Add	RAD	H	Mem.	Acc./AS	Resets accum. or aux. stor.; adds from memory	Non-num. char. in mem.	.034 + .017N	25
R Sub	RSU	Q	Mem.	Acc./AS	Resets accum. or aux. stor.; subtracts from memory	Non-num. char. in mem.	.034 + .017N	27
Round	RND	E			Drop positions from right and 1/2 adjust (accum. 00). Zero balance is plus		.085 + .017N	30
Select	SEL	2			Select input, output, alter sw. or check indicator		.051	20
Set Left	SET	B			Place storage mark to left of indicated address (00-15)		.034 + .017N	31
Shorten	SHR	C			Drop positions from right (accum. 00). Zero balance is plus		.051 + .017N	32
Sign	SGN	T	Mem.	Acc./AS	Remove zone 11, 10, or 01 from memory, place & or— in accumulator or aux. stor.		.068	51
Stop	HLT	J			Stop machine		.034	48
Store	ST	F	Acc./AS	Mem.	Store numerical field in memory	Acc./Aux. Stor. mark	.034 + .017N	26
St Print	SPR	5	Acc./AS	Mem.	Store field for printing. Skips decimals, commas. Removes left-hand zeros and commas.	Acc./Aux. Stor. mark	.034 + .017N	73
Subtract	SUB	P	Mem.	Acc./AS	Result in accumulator or aux. storage	Non-num. char. in mem.	.034 + .017N	28
Transfer	TR	1			Unconditional transfer		.034	22
Tr Any	TRA	I			Transfer if any I/O or check indicator is on		.034	55
Tr Equal	TRE	L			Transfer if acc. or aux. stor. is equal to memory		.034	42
Tr High	TRH	K			Transfer if acc. or aux. stor. is higher than memory		.034	42
Tr Plus	TRP	M			Transfer if acc. or aux. stor. sign is plus		.034	51
Tr Signal	TRS	O			Transfer if indicator is on		.034	48
Tr Zero	TRZ	N			Transfer if factor in acc. or aux. stor. is zero		.034	51
Transmit	TMT	9	Mem.		Use with RCV for transmitting data from memory to memory			37
					Code 00: 5 character group transmission	R/M in mem. pos. ending in 4 or 9	.017 + (N/5 x .018)	
					Code 01-15: single character transmission	Aux. stor. mark	.034 + (N x .018)	
Unload	UNL	7	Acc./AS	Mem.	Unload zones and numbers	Acc./Aux. Stor. mark	.034 + .017N	41b
Write 00	WR	R	Mem.	Output	From memory to tape	Group mark	10.0 + .067N	21
					From memory to card punch or printer	Group mark	.068 + .0335N	
					From memory to drum	Group mark	8.0 + .040N	
Write 01	WR	R	Mem.	Output	From memory to card, printer, tape, drum	20,000th mem. pos.	See Write	22
Wr Erase	WRE	Z	Mem.	Output	Replace each char. in mem. with blank	Group mark	10.0 + .067N	
					To tape	Group mark	.068 + .0335N	
					To card punch or printer	Group mark	8.0 + .040N	
					To drum	Group mark	8.0 + .040N	

ADDRESS DATA	
Memory	0000 - 9999
Card Readers	0100 - 0199
Tape Units	0200 - 0299
Card Punches	0300 - 0399
Printers	0400 - 0499
Typewriter	0500
Drum Sections	1000 - 9999
Alteration Switches	0911 - 0919
Instruction Check Indicator	0900
Machine Check Indicator	0901
Read-Write Check Indicator	0902
Printer-Punch Check Indicator	0903
Overflow Check Indicator	0904
Sign Check Indicator	0905

CARRIAGE CONTROL CHARACTERS	
Suppress Space	&
Single Space	Blank
Double Space	0
Skip to Channels 1-9	1-9
Short Skip to Channels 1-9	J-R

SYMBOLIC CLASS CODES	
b.	Instruction with symbolic memory address
1.	Instruction with actual memory address
2.	Constant entry using actual data
3.	Constant entry using symbolic memory location as constant
5.	Entry to set up records of entry, working areas, etc.
6.	To assign starting location of various instruction program blocks in memory
7.	Description of entries

FIGURE 120. OPERATION CHART

CHAR.	C	BA	8421	CHAR.	C	BA	8421	CHAR.	C	BA	8421	Acc. and Drum Mark
&	0	11	0000	-	1	10	0000	Blank	1	01	0000	0 0 00 0000
A	1	11	0001	J	0	10	0001	/	0	01	0001	CH. C BA 8421 1 1 00 0001
B	1	11	0010	K	0	10	0010	S	0	01	0010	2 1 00 0010
C	0	11	0011	L	1	10	0011	T	1	01	0011	3 0 00 0011
D	1	11	0100	M	0	10	0100	U	0	01	0100	4 1 00 0100
E	0	11	0101	N	1	10	0101	V	1	01	0101	5 0 00 0101
F	0	11	0110	O	1	10	0110	W	1	01	0110	6 0 00 0110
G	1	11	0111	P	0	10	0111	X	0	01	0111	7 1 00 0111
H	1	11	1000	Q	0	10	1000	Y	0	01	1000	8 1 00 1000
I	0	11	1001	R	1	10	1001	Z	1	01	1001	9 0 00 1001
Plus Zero	0	0	11 1010	Minus Zero	0	1	10 1010	Record Mark	1	01	1010	Numerical Zero
	0	0	11 1010		0	1	10 1010		1	01	1010	0 0 00 1010
SPECIAL CHAR .	1	11	1011	\$	0	10	1011		0	01	1011	# 1 00 1011
□	0	11	1100	*	1	10	1100	%	1	01	1100	@ 0 00 1100
Group Mark	0	11	1111									Tape Mark
												0 00 1111

FIGURE 121. CHARACTER CODE CHART

INDEX

	Page		Page
Accumulator Storage	5, 6, 8	Control 0003 Instruction	48
Accumulator Storage Sign	111	Control 0004 Instruction	48
Add Instruction	25	Control 0005 Instruction	48
Add to Memory, Signed Fields	49	Control Total	64
Add to Memory, Unsigned Fields	50	Control Unit	
Add to Memory Instruction	49	Card Punch	14
Addition: $A \pm B = T$	24	Card Reader	12
Address, Memory	18	Tape Unit	13
Address of Components	18	Core Memory	5
Address Part, Instruction	17	Coupling, Auxiliary Storage Units	8
Address Selection Switch, Tape Unit	13, 107	CR 1 Code Check, Console	110
Address System	17	CR 2 Code Check, Console	110
Alteration Switches, Console	16, 53, 111	Crossfooting: $A - B - C = T$	27
Alternator, Card Reader Control Panel	98	Crossfooting Balance Checks	64
Arithmetic and Logical Unit	6, 8		
Arithmetic Field, Location in Memory	24	Data Transmission, Organization of	6
Arithmetic Instructions	24	Data Transmission Operations	36
Automatic Start Key, Console	113	Data-Conversion Operations	19
Auxiliary Storage	5, 6, 8	DC on-off Key, Console	114
Auxiliary Storage Coding	24	Decoding, Single-Character Code	89
Auxiliary Storage Sign	111	Digit Selection and Decoding	86
		Digit Selection by Comparison	88
Balance Forward	49	Digit Selectors, Card Reader Control Panel	98
Binary Search	70	Display, Manual	112
Binary Triggers	58, 59, 60	Display Key, Console	112
		Divide Instruction	33
Card Columns	10	Division: $A \div B = Q$	32
Card Punch	14, 101	Drum Operation Transfer	106
Card Punch, Operating Keys and Lights	101	Drum Reading and Writing	9, 67, 106
Card Punch Record Storage	14	Drum Search Problem	68
Card Reader	12, 96	Drum Section Addresses	9, 67
Card Reader Control Panel	12, 97	Drum Speed	9
Card Reader, Operating Keys and Lights	96	Drum Storage	67, 105, 106
Card Reader Record Storage	12		
Card-to-Tape Conversion through Memory	19	End-of-File Procedures	45
Carriage Control	103	End of File, Read while Writing	53
Carriage Control Characters	79	End of File, Transfer Any	55
Carriage Control Problem	79	Examples	
Carriage Control Switch	21, 78, 104	Add	26
Carriage Control Tape	77	Add to Memory	50
Carriage Control Tape, Insertion of	78	Compare	43
Carriage Control Tape Channels	77	Division	34
Carriage Control Tape Punching	77	Lengthen	32
Carriage Spacing	78	Load	41b
Central Processing Unit	16	Multiply	29
Character Code Chart	120	Reset and Add	25
Character Code System	10	Reset and Subtract	28
Character Coding, 705	6, 11, 116	Round	30
Character Coding, IBM Card	10	Set Left	32
Check Channel, Magnetic Tape	11	Shorten	32
Check Entry, Card Reader Control Panel	98	Sign	51
Check Entry Emitters, Reader Control Panel	98	Store	26
Check Indicators	56, 111	Unload	41b
Checking		Feed Check Light	
Card Punch	14, 58	Card Punch	102
Card Reader	12, 57	Card Reader	97
Printer	15, 60	Feed Key	
Tape Unit	13, 58, 61	Card Punch	102
Checking Procedures	56	Card Reader	97
Checks, Console	16, 110	Field Length, in Storage Unit	8
Clear Memory Key, Console	113	File Protection Light, Tape Unit	107
Collating Sequence	41b, 116	First Read, Card Reader Control Panel	98
Column Splits, Card Reader Control Panel	98	Form Control Key, Printer	104
Compare Instruction	41b	Form Control Key and Stop Light, Printer	103, 104
Comparison Indicators	7, 42	Form Feeding Carriage	14
Comparison of Fields	42		
Console	108	Gross Pay Calculation	34
Control Instructions	47	Group Mark	20, 41a
Control 0000 Instruction	47	Group Switch, Card Reader Control Panel	98
Control 0001 Instruction	47		
Control 0002 Instruction	47		

	Page
Grouping, Card Records	12
Grouping, Tape Records	91
Grouping, Tape Records, Flow Chart	92
Half Multiple Step Key, Console	113
Halt Instruction	48
Hash Total	63
Independent Operation	12
Indicators, Comparison	7
Indicators, Sign	8
Input Data Checks	57
Input-Output Devices	11
Input-Output Indicators	45
Card Reader	47
Drum	47
Printer	47
Tape Unit	47
I/O No Response, Console	111
Instruction	16, 17
Instruction, Execution of	109
Instruction, Manual	111
Instruction, Time to Read and Interpret	6
Instruction Check Indicator	56
Instruction Check Lights, Console	110
Instruction Check Switch, Console	111
Instruction Counter, Console	109
Instruction Key, Console	111
Instruction Location in Memory	20
Instruction Time	17
Inter-record Gap	10
Keyboard	16
Lengthen Instruction	32
Limit Check	64
Load Instruction	41b
Load Point	46
Load-Rewind Key, Tape Unit	107
Logical Ability	17
MAC I	37, 39
MAC II	37, 39
Machine Check Indicator	57
Machine Check Lights, Console	110
Machine Check Switch, Console	111
Machine Components	96
Machine Stop Key, Console	111
Magnetic Core Plane	6
Magnetic Cores	5
Magnetic Tape, Characteristics of	9
Magnetic Tape, Speed	9
Magnetic Tape Unit	106
Magnetic Tape Unit, Operating Keys and Lights	107
Manual Stop Key, Console	111
Master Off Key, Console	114
Memory Address Counter I, Console	109
Memory Address Counter II, Console	110
Memory Address Register, Console	109
Memory Address Selector, Console	113
Memory Display CR 1, Console	110
Multiplication	28
Multiplication with Half Adjustment	30
Multiply Instruction	28
Neon Lights and Indicators, Console	15
No Operation Instruction	84
NOP-TR Switch Problem	84
Normalize and Transfer Instruction	82
Normalize and Transfer Problem	82
Normalizing Accumulator and Auxiliary Storage	82
Normal Off Key, Console	114
Not 4 or 9, Console	110

	Page
Operating Keys, Console	15
Operating Speeds	95
Operation, Tape Unit	108
Operation Chart	115
Operation Check, Console	110
Operation Controls, Console	111
Operation Decoder, Console	109
Operation Part	17
Operation Register, Console	109
Operator's Console	15, 108
Other Instructions	73
Output Data Checks	58
Overflow Check Indicator	57
Overflow Check Switch, Console	111
Overflow Sheet Identification	77
Overflow Skipping	76
Page Totals	76
Payroll, Gross to Net	65
Photo-Sensing Marker	45
Platen Clutch, Printer	104
Power Controls, Console	114
Power on Key, Console	114
Power on Light, Card Reader	97
Predetermined Total Line	77
Preventive Maintenance	64
Printer	14, 102
Printer, Operating Keys and Lights	104
Printer Record Storage	14
Printing Line, First Stop	77
Printing	
Normal Skip Stop	77
Overflow Control	77
Program	
A + B - C = T	28
Add to Memory and Sign	51
Addition	26
Binary Search	70
Card to Tape	19
Carriage Control	79
Decoding Single-Character Code	90
Division	34
Drum Search	68
End-of-File	48, 54, 55
Error Correction	61
Error Correction with End-of-File	62
Gross Pay Calculation	34
Grouping Records	94
Multiplication	29
Multiplication with Half Adjustment	30
NOP-TR Switch	85
Normalize and Transfer	83
Payroll, Gross to Net	65
Preparation for	16
Read while Writing	41
Selection of Single-Digit Code	74
Sequence Checking	43
Single-Character Transmission	38
Store for Print	74
Tape to Card	22
Tape to Card and Printer	23
Transmitting Five Characters	38
Write and Erase	81
Program Switch	83
Proof Figures	64
Read Instruction	21
Read while Writing	13
Read while Writing Instruction	40
Read while Writing Time	13, 40
Read-Write Check Indicator	57
Read-Write Check Switch, Console	111
Ready Light	
Card Punch	102
Card Reader	97
Printer	104
Tape Unit	107

	Page		Page
Receive and Transit Time	36, 37	Storage Selector Console	113
Receive Instruction	36	Storage Sign (—), Console	111
Record Arrangement for Printing	73	Storage Units	
Record Check Indicator	57	Capacity of	8
Record Check Switch, Console	111	Code for	8
Record Count	63	Store for Print Instruction	73
Record Length	10, 18	Store for Print Problem	73
Record Mark	36	Store Instruction	26
Record Storage Entry		Stored Program	16
Card Reader Control Panel	99	Store Key, Console	112
Emitters, Control Panel	98	Store, Manual	112
Record Storage Mark	19	Subtract Instruction	28
Recording on Magnetic Tape	106	Symbolic Programming	18
Reel Change Time	106	Systems Checks	63
Reel Door Interlock	108		
Reel Release Switch	108	Table Look-Up	67
Reflective Spot	10, 45	Tape-Controlled Carriage	75
Remainder in Division, to Recover	33	Tape Indicator On	108
Reset and Add Instruction	25	Tape Mark	46, 106
Reset and Subtract Instruction	27	Tape Unit	13
Reset Key		Tape-to-Card Conversion through Memory	22
Console	113	Tracks, Magnetic Tape	11
Tape Unit	107	Transfer	
Restore Key, Printer	104	Any Instruction	55
Rewinding Tape	10, 106	Instruction	22
Round Instruction	30	on Equal Instruction	42
		on High Instruction	42
		on Plus Instruction	51
		on Signal Instruction	48
		on Zero Instruction	51
		Transmission	
Second Read, Card Reader Control Panel	98	Five Character	36
Select Instruction	20	Read while Writing	40
Select Light		Single Character	38
Card Punch	102	via Storage Units	41a
Card Reader	97	Transmit Instruction	37
Printer	104	Typewriter	15, 104
Tape Unit	107		
Select Register, Console	111	Unload Instruction	41b
Sequence Checking	41	Unload Key, Tape Unit	108
Set Left Instruction	31	Unsigned Fields	24
Shift Instructions	30		
Shorten Instruction	32	Vacuum Columns	13
Sign Check Indicator	57	Variable Line Spacing and Uniform Skipping	76
Sign Check Switch, Console	111		
Sign Indication, Storage Units	8	Wiring	
Sign Instruction	51	Card Reading	99
Sign Storage, Auxiliary Storage Units	52	Grouped Records	101
Signed Fields	24	Signing Card Fields	99
Space Key, Printer	104	Write	
Start Key		00 Instruction	21
Card Punch	101	01 Instruction	22
Card Reader	96	Write and Erase	
Printer	104	00 Instruction	80
Tape Unit	107	01 Instruction	80
Starting Point Counter	8	Memory	80
Stop Instruction	48	Problem	80
Stop Key			
Card Punch	102	Zones, IBM Card	10
Card Reader	97	Zones, 705 Character	11
Printer	104		
Storage Capacity	5		
Storage Display CR 2, Console	111		
Storage Mark	8		
Storage Select Register, Console	111		

