

# IBM System/3 Disk System Operator's Guide

## Preface

This manual provides the information needed to operate the IBM System/3 Disk System, Program Number 5702SC1. Operation of Program Products 5702AS1, 5702RG1, 5702SM1, and 5702UT1 is also included in this manual. Chapter 1 provides an introduction. Chapters 2 through 6 describe the operating equipment and the function and use of the equipment. Chapters 7 through 10 describe system operation, program operation on the system, system generation and system maintenance. Familiarity with Chapters 1 through 6 is necessary before proceeding to the remaining chapters.

The following manuals contain additional information about the IBM System/3 Disk System:

*IBM System/3 Disk System Introduction*, GC21-7510.

*IBM System/3 Disk System Operation Control Language and Disk Utilities Reference Manual*, GC21-7512.

*IBM System/3 Disk System Card Utilities Reference Manual*, SC21-7529.

*IBM System/3 Card and Disk System Components Reference Manual*, GA21-9103.

*IBM System/3 Disk System Halt Procedure Guide*, GC21-7540.

*IBM System/3 Disk System RPG II Reference Manual*, SC21-7504.

*IBM System/3 Disk System Disk Sort Reference Manual*, SC21-7522.

*IBM System/3 Disk System Basic Assembler Reference Manual*, SC21-7509.

## Second Edition (November 1970)

A change to the text or a small change to an illustration is indicated by a vertical line to the left of the change; a changed or added illustration is denoted by the symbol ● to the left of the caption.

Changes are continually made to the specifications herein; any such changes will be reflected in subsequent revisions or Technical Newsletters.

Requests for copies of IBM publications should be made to your IBM representative or to the IBM branch office serving your locality.

A form for reader's comments is provided at the back of this publication. If the form has been removed, comments may be addressed to IBM Corporation, Programming Publications, Department 425, Rochester, Minnesota 55901.



CHAPTER 1. YOU AND SYSTEM/3 . . . . .	1	CHAPTER 7. SYSTEM OPERATION . . . . .	83
Introduction . . . . .	2	Preparing System for Program Operation . . . . .	84
Program Run Sheet . . . . .	4	Clear Cards from the MFCU . . . . .	84
CHAPTER 2. IBM 5410 PROCESSING UNIT		Place Forms in the Printer . . . . .	84
CONTROLS AND INDICATORS . . . . .	7	Perform IPL (Initial Program Load) . . . . .	84
System Controls and Indicators . . . . .	8	Clearing I/O ATTENTION . . . . .	88
Binary Synchronous Communications		Using the Console Error Log Sheet . . . . .	89
Adapter Panel . . . . .	15	Stopping a Job Before it is Completed . . . . .	89
Switches . . . . .	16	Using the Machine Covers for Safety . . . . .	89
CHAPTER 3. IBM 5424 MULTI-FUNCTION		Turning System Power Off . . . . .	89
CARD UNIT . . . . .	17	Restoring System Power . . . . .	91
MFCU Controls and Indicators . . . . .	18	PWR CHK Light Only . . . . .	91
Clearing a Card Jam . . . . .	19	PWR CHK and TH CHK Lights . . . . .	91
Changing the MFCU Print Ribbon	24	No Lights . . . . .	91
Removal . . . . .	24	Core Storage Dump . . . . .	92
Installation . . . . .	27	Considerations Before Taking a Core Storage Dump . . . . .	92
Emptying the MFCU Chip Box . . . . .	30	Dual Programming Operation . . . . .	93
CHAPTER 4. THE IBM 5203 PRINTER . . . . .	31	Procedures . . . . .	93
Printer Controls and Indicators . . . . .	32	Procedures for Canceling Jobs . . . . .	94
Loading Forms in the Printer . . . . .	34	CHAPTER 8. PROGRAM OPERATION . . . . .	95
Changing the Printer Ribbon . . . . .	44	Operation Control Language (OCL) Considerations . . . . .	96
Removal . . . . .	44	//DATE Statement . . . . .	96
Installation . . . . .	48	//READER Statement . . . . .	96
Changing the Print Chain Cartridge . . . . .	50	//LOG Statement . . . . .	96
Removal . . . . .	50	//LOAD Statement . . . . .	96
Installation of 48-Character LC Print Arrangement		//RUN Statement . . . . .	97
Chain . . . . .	54	//SWITCH Statement . . . . .	97
Installation of 60-Character PN Print Arrangement		//NOHALT Statement . . . . .	97
Chain . . . . .	56	//HALT Statement . . . . .	97
CHAPTER 5. IBM 5440 DISK CARTRIDGE AND IBM		//PAUSE Statement . . . . .	97
5444 DISK STORAGE DRIVE . . . . .	61	//CALL Statement . . . . .	97
Disk Cartridge . . . . .	62	//FILE Statement . . . . .	97
Carrying Handle . . . . .	62	//PARTITION Statement . . . . .	97
Release Button . . . . .	62	//COMPILE Statement . . . . .	97
Bottom Cover . . . . .	62	//FORMS Statement . . . . .	97
Disk Storage Drawer . . . . .	63	//IMAGE Statement . . . . .	97
Clamp Arms . . . . .	63	RPG II Program . . . . .	98
Drawer Stop . . . . .	63	Compilation . . . . .	98
Disk Drive . . . . .	64	Object Program Execution . . . . .	100
Mounting a Cartridge . . . . .	64	Executing an RPG II I-Type Program . . . . .	102
Removing a Cartridge . . . . .	68	Interrupting an RPG II Object Program . . . . .	102
CHAPTER 6. IBM 5471 PRINTER-KEYBOARD . . . . .	73	BSC Programs . . . . .	104
Use of the Printer-Keyboard . . . . .	74	Compilation . . . . .	104
Removing the Typeball . . . . .	76	Execution . . . . .	104
Adjusting the Impression Selector . . . . .	77	Card Utilities . . . . .	106
Removing the Fabric Ribbon Cartridge . . . . .	78	96-List Program . . . . .	107
Installing a Fabric Ribbon Cartridge . . . . .	79	96-96 Reproduce and Interpret Program . . . . .	108
Placing Forms in the Printer-Keyboard . . . . .	81	Restart Procedure . . . . .	108
CHAPTER 7. SYSTEM OPERATION . . . . .	83	Reformat Data Card . . . . .	110
Preparing System for Program Operation . . . . .	84	MFCU Sort/Collate Program . . . . .	112
Clear Cards from the MFCU . . . . .	84	Sort Operating Procedure . . . . .	114
Place Forms in the Printer . . . . .	84	Data Recording Program . . . . .	118
Perform IPL (Initial Program Load) . . . . .	84	Program Load Procedure . . . . .	118
Clearing I/O ATTENTION . . . . .	88	Data Verifying Program . . . . .	119
Using the Console Error Log Sheet . . . . .	89	Program Load Procedure . . . . .	119
Stopping a Job Before it is Completed . . . . .	89	Disk Sort Program . . . . .	120
Using the Machine Covers for Safety . . . . .	89	Basic Assembler Program . . . . .	122
Turning System Power Off . . . . .	89	Execution of a Basic Assembler Object Program . . . . .	123
Restoring System Power . . . . .	91		
PWR CHK Light Only . . . . .	91		
PWR CHK and TH CHK Lights . . . . .	91		
No Lights . . . . .	91		
Core Storage Dump . . . . .	92		
Considerations Before Taking a Core Storage Dump . . . . .	92		
Dual Programming Operation . . . . .	93		
Procedures . . . . .	93		
Procedures for Canceling Jobs . . . . .	94		
CHAPTER 8. PROGRAM OPERATION . . . . .	95		
Operation Control Language (OCL) Considerations . . . . .	96		
//DATE Statement . . . . .	96		
//READER Statement . . . . .	96		
//LOG Statement . . . . .	96		
//LOAD Statement . . . . .	96		
//RUN Statement . . . . .	97		
//SWITCH Statement . . . . .	97		
//NOHALT Statement . . . . .	97		
//HALT Statement . . . . .	97		
//PAUSE Statement . . . . .	97		
//CALL Statement . . . . .	97		
//FILE Statement . . . . .	97		
//PARTITION Statement . . . . .	97		
//COMPILE Statement . . . . .	97		
//FORMS Statement . . . . .	97		
//IMAGE Statement . . . . .	97		
RPG II Program . . . . .	98		
Compilation . . . . .	98		
Object Program Execution . . . . .	100		
Executing an RPG II I-Type Program . . . . .	102		
Interrupting an RPG II Object Program . . . . .	102		
BSC Programs . . . . .	104		
Compilation . . . . .	104		
Execution . . . . .	104		
Card Utilities . . . . .	106		
96-List Program . . . . .	107		
96-96 Reproduce and Interpret Program . . . . .	108		
Restart Procedure . . . . .	108		
Reformat Data Card . . . . .	110		
MFCU Sort/Collate Program . . . . .	112		
Sort Operating Procedure . . . . .	114		
Data Recording Program . . . . .	118		
Program Load Procedure . . . . .	118		
Data Verifying Program . . . . .	119		
Program Load Procedure . . . . .	119		
Disk Sort Program . . . . .	120		
Basic Assembler Program . . . . .	122		
Execution of a Basic Assembler Object Program . . . . .	123		

Disk Utility Programs . . . . .	124	Procedures for Maintenance Releases on Disk . . . . .	169
Operating Procedures . . . . .	124	Performing Disk Maintenance on Distribution Disk Cartridge . . . . .	169
Operating Procedures for Library Maintenance Utility Program . . . . .	126	Performing Disk Maintenance on Your Tailored System Disk Cartridge . . . . .	171
CHAPTER 9. SYSTEM GENERATION . . . . .	129	Building a Minimal Resident System on F1 . . . . .	174
System Generation Procedures . . . . .	130	Procedures for Applying Program Temporary Fixes . . . . .	174
Preparing for System Generation . . . . .	130	Considerations Before Applying PTFs . . . . .	174
Backing Up Your Resident System . . . . .	131	Applying the PTF . . . . .	174
System Control Program (SCP) Generation . . . . .	132	APPENDIX A. IMAGE STATEMENT . . . . .	175
Program Product Generation . . . . .	149	Description of the IMAGE Statement. . . . .	175
Completing System Generation and Installation Verification . . . . .	154	//IMAGE Parameter. . . . .	175
Building a Program Pack . . . . .	160	Using the IMAGE Statement to Change the Chain IMAGE when Performing System Generation . . . . .	176
CHAPTER 10. SYSTEM MAINTENANCE . . . . .	161	APPENDIX B. SORT/COLLATE MESSAGES . . . . .	181
System Maintenance Procedures . . . . .	162	APPENDIX C. RPG II SAMPLE PROGRAM . . . . .	189
Common Procedures for Maintenance Releases on Cards or Disk . . . . .	162	Compiling the SAMPL1 Program . . . . .	190
Preparing for Card or Disk Maintenance . . . . .	162	Compiling the SAMPL2 Program . . . . .	190
Backing Up Your Resident System . . . . .	162	Executing the SAMPL1 Program . . . . .	190
Procedures for Maintenance Releases on Cards . . . . .	165	Executing the SAMPL2 Program . . . . .	190
Performing Card Maintenance on Distribution Disk Cartridge . . . . .	165	INDEX . . . . .	197
Performing Card Maintenance On Your Tailored System Disk Cartridge . . . . .	167		
Building a Minimal Resident System on F1 . . . . .	168		

- Introduction
- Program Run Sheet

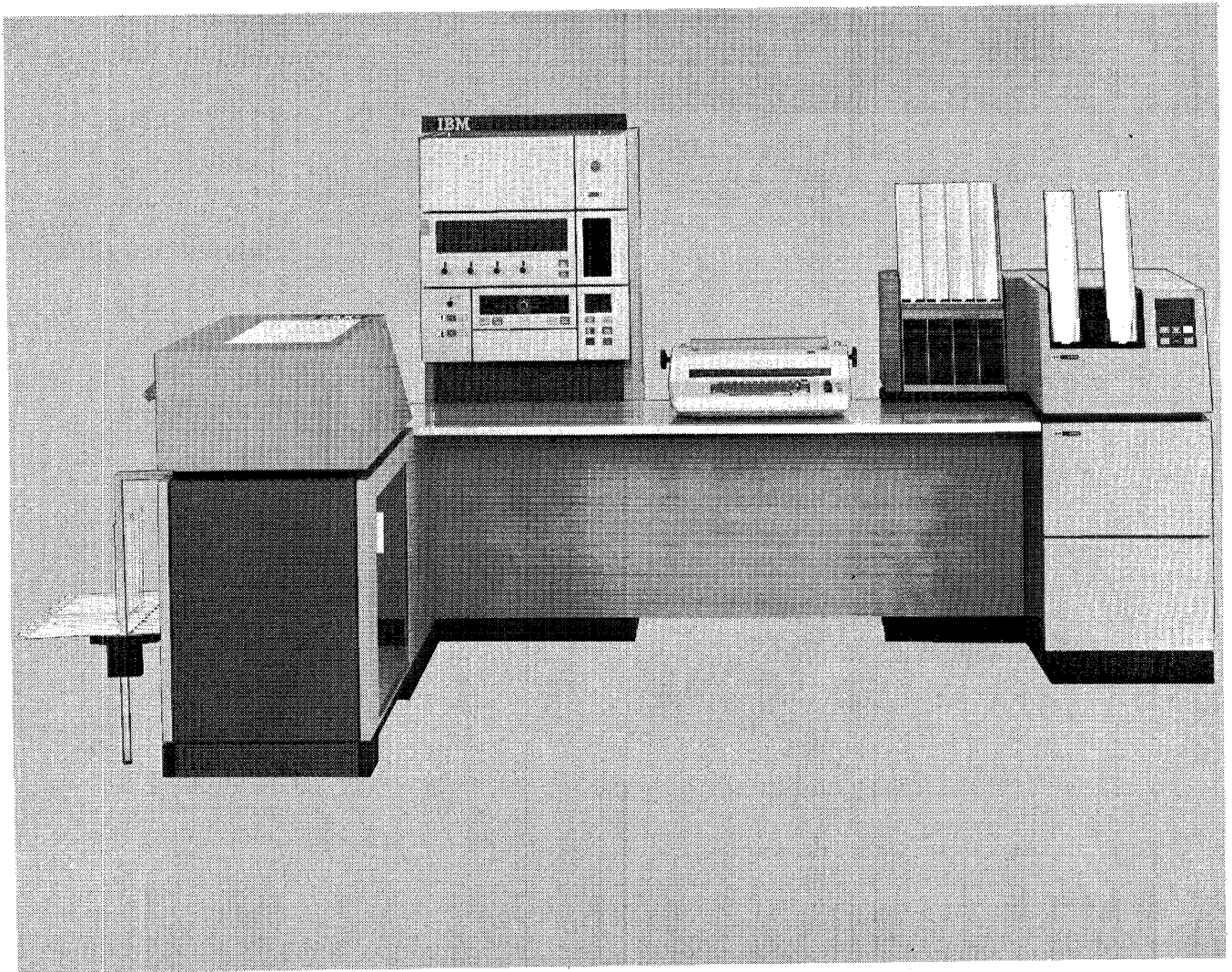

55239A

## INTRODUCTION

This manual tells you how to operate the IBM System/3 Disk System and provides instructions for running the system programs. Some of the things you must be able to do are:

- Load paper forms in the printer.
- Clear cards from the multi-function card unit (MFCU).
- Mount and remove disk cartridges.
- Operate the system.
- Perform error recovery procedures for halts.

Figure 1 summarizes typical responsibilities of a system operator. This figure also shows the source of the items you need to do the job.

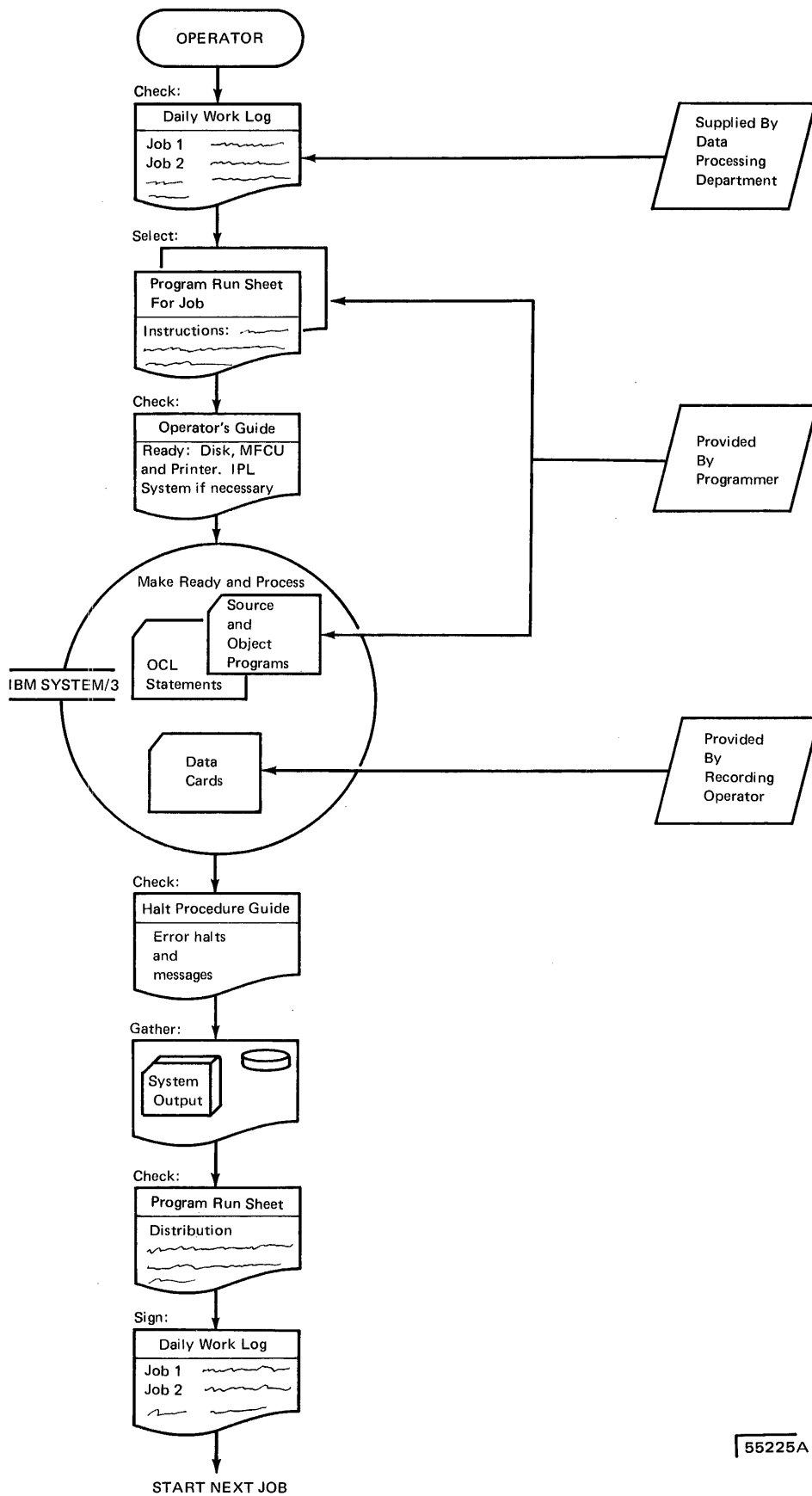

● Figure 1. System/3 Operator Responsibilities

## **PROGRAM RUN SHEET**

Information concerning the nature of each program and what is required of you as the operator to run that program can be supplied on the program run sheet. Figure 2 shows a program run sheet. This sheet is provided to you by the programmer.

The program run sheet indicates:

- The disk cartridge to mount.
- The forms to use in the printer.
- The input device to use.
- The Operation Control Language (OCL) statements used.
- Any special procedures that are not normally performed but necessary with this program.
- RPG II programmed halts to be used.

**IBM SYSTEM/3 DISK SYSTEM  
PROGRAM RUN SHEET**

Application \_\_\_\_\_ Date \_\_\_\_\_

Program Name \_\_\_\_\_ Number \_\_\_\_\_ Programmer \_\_\_\_\_

**JOB PREPARATION**

MFCU: Primary Hopper Secondary Hopper	Description and Source of Card Files
DISK: Removable 1 Removable 2	Description of Disk Cartridges and/or Files
PRINTER: Form Number Form Name	Description of Form

**JOB COMPLETION**

MFCU: Stacker 1 Stacker 2 Stacker 3 Stacker 4	Destination of Card Files
DISK: Removable 1 Removable 2	Disposition of Cartridges
PRINTER: Burst? ____ Decollate? ____	Distribution of Forms

**RPG PROGRAMMED HALTS**

Halt Code	Halt Meaning	Action Required
H1		
H2		
H3		
H4		
H5		
H6		
H7		
H8		
H9		

**SPECIAL INSTRUCTIONS**

---



---



---

Figure 2. Program Run Sheet (part 1 of 2)

Form No. GX21-9122-0  
Printed In USA

Application	Date
Program Name	Programmer
Number	

OCL STATEMENTS																								
1	4	8	12	16	20	24	28	32	36	40	44	48	52	56	60	64	68	72	76	80	84	88	92	96
<div style="font-family: monospace; font-size: 10px; margin-bottom: 5px;">/E</div> Empty grid cells for OCL statements																								

Figure 2. Program Run Sheet (part 2 of 2)



## Chapter 2. IBM 5410 Processing Unit Controls and Indicators

- System Controls and Indicators
- System Control Panel
- Emergency Power Off and Meter Panel
- Processing Unit Display Panel
- Customer Engineer Control Panel
- Disk Panel
- Dual Program Control Panel
- Binary Synchronous Communications Adapter Panel

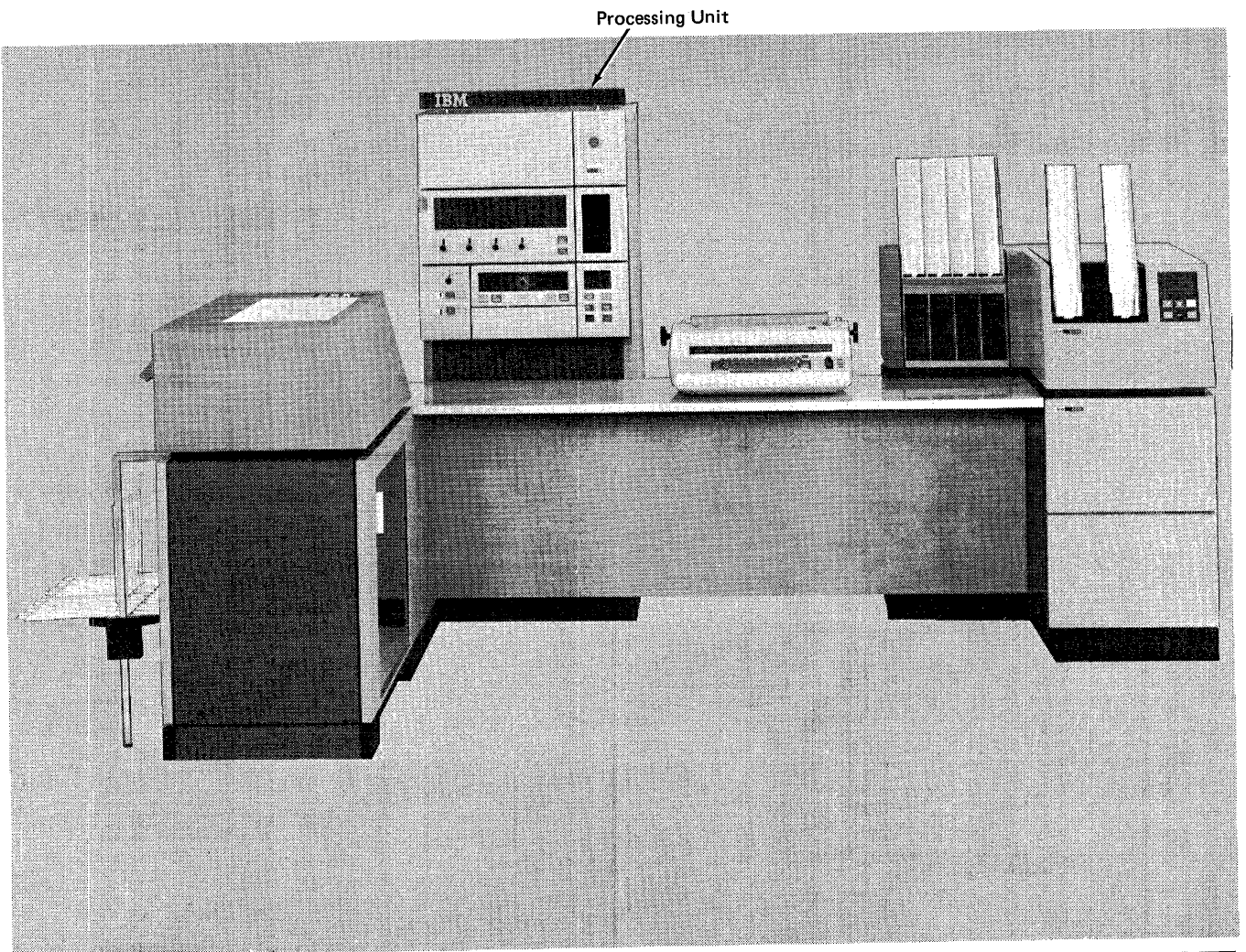

55239A

## SYSTEM CONTROLS AND INDICATORS

Each System/3 processing unit has lights, keys, and switches that are used for communication between you and the system. Lights indicate conditions existing in a device or in the system. Keys and switches are used to control operation of the system. Functions of the lights, keys, and switches on the processing unit are discussed in this chapter.

Controls and indicators for the processing unit are located on a large panel called the console (Figure 3). Although this panel is divided into several smaller panels, you will be concerned primarily with the system control panel, disk panel, and the dual program control panel if you have this feature. The processing unit displays and Customer Engineer controls are used primarily by the Customer Engineer when he services the system.

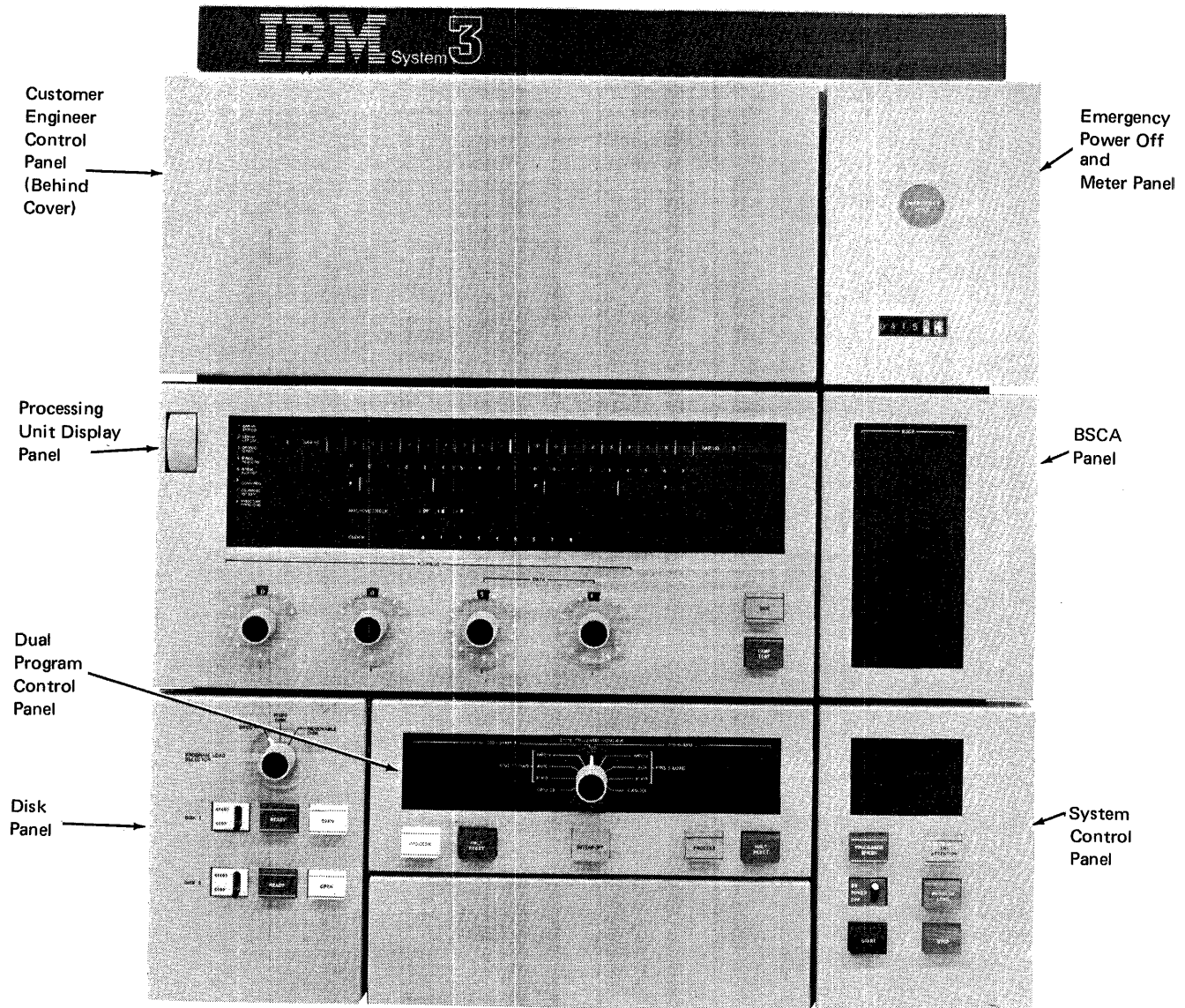

● Figure 3. System Console Controls

53298A

### System Control Panel

The controls and indicators on the system control panel (Figure 4), along with those on the MFCU and the printer panels, are the means by which you operate the system.

**Message Display Unit:** This two-position display unit, at the top of the system control panel, displays characters whenever a programmed halt occurs. Characters that can be displayed are: A, C, E, F, H, J, L, P, U, Y, quote ('), dash (-), blank, and 0 through 9.

The display unit is not used if you have the Dual Programming Feature (DPF). The message display units on the DPF panel have the same function.

The *IBM System/3 Disk System Halt Procedure Guide*, GC21-7540, lists all System/3 Disk System program halts.

**PROCESSOR CHECK Light:** This light comes on when an error occurs in the processing unit. The error is displayed on the processing unit display panel. All processor checks are reset and PROCESSOR CHECK turns off when you perform the initial program load (IPL) process.

**I/O ATTENTION Light:** This light comes on when the program requests any input/output device to do something and that device is not ready to do it. Some causes are:

1. Printer is out of forms.
2. MFCU hopper is empty; stacker or chip box is full.
3. Disk is not up to speed.

Additional indicators on the device guide you to the exact cause of a not-ready condition. I/O ATTENTION goes off when the condition is corrected. Instructions for clearing I/O ATTENTION are included in *Chapter 7. System Operation*.

**POWER ON/OFF Switch:** This switch controls power to all units on the system. It is effective when (1) the emergency pull switch is in its normal position, (2) the TH CHK (thermal check) indicator is not lit, and (3) the PWR CHK (power check) indicator is not lit. The thermal and power check indicators are located on the processing unit display panel.

**PROGRAM LOAD Key:** This key is used when you perform the initial program load process. This key is pressed after you have selected the device from which you will perform IPL (either the fixed or removable disk on drive 1, or the MFCU). When you press this key, the IPL program begins and the programs necessary to run your jobs are loaded into storage.

**START Key:** When you press START, it allows the system to continue normal operation. Use START only after (1) a programmed halt (non-DPF system) or (2) after you have pressed console STOP. Do not press START at any other time. If your system has DPF, use the appropriate HALT/RESET key rather than START to restart a program following a programmed halt.

**STOP Key/Light:** When you press STOP, it causes the system to stop after completing the current operation. The STOP light is lit as soon as processing stops. You restart the system by pressing START.

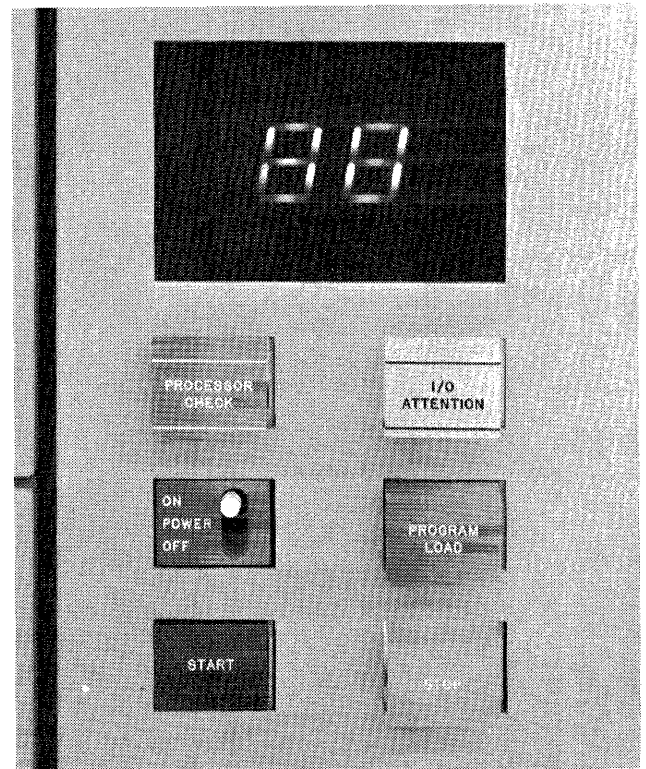

Figure 4. System Control Panel

55023

### *Emergency Power Off and Meter Panel*

**EMERGENCY PULL Switch:** This switch, as its name implies, should be used only under unusual circumstances. Once the emergency pull switch is pulled, system power cannot be turned on until the Customer Engineer has reset the switch. Information in storage may be destroyed when the emergency pull is used. Data on disks can also be destroyed by this operation.

**Usage Meter:** This meter records the time used to process programs and data. The meter records all the time that the processing unit is in operation from the time the console START (HALT/RESET if you have DPF), or PROGRAM LOAD is pressed, until the job is complete.

The emergency power off and meter panel is illustrated in Figure 5.

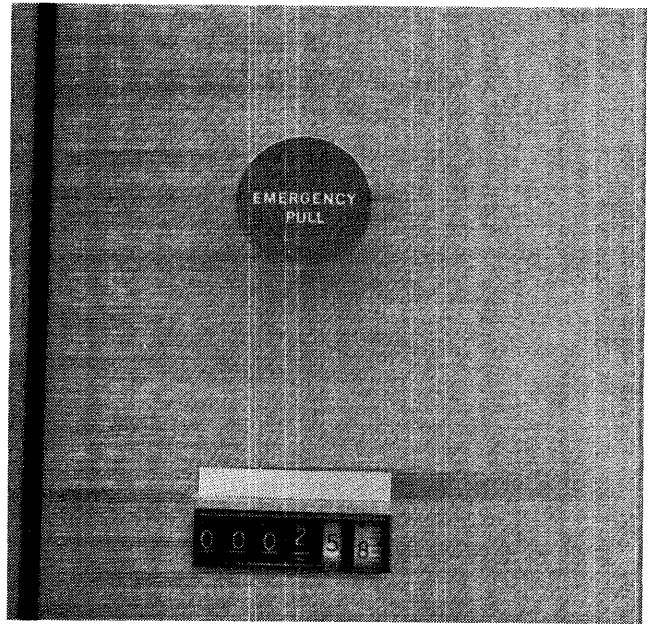

Figure 5. Emergency Power Off and Meter Panel

55024

### Processing Unit Display Panel

The lights on this panel (Figure 6) indicate system status and are mainly for Customer Engineer (CE) use.

**ADDRESS/DATA Switches:** These switches are used to indicate an address or data. Switch settings can be tested by the program in operation, can be entered into storage, or can cause a storage location to be displayed by the register display unit.

**LAMP TEST Key:** When you press this key, all indicator lights on all units on the system are lit.

**Register Display Unit:** This display unit consists of a row of 20 lights and an eight-position rotary switch. The lights display processing unit status and contents of main registers (intermediate storage areas). Any of eight different areas can be selected for display.

**Cycle Control Display:** The 12 indicator lights labeled MACHINE CYCLE and the 10 indicator lights labeled CLOCK identify the processing cycle just completed.

**INT LEV Light:** This lamp is lit when an interrupt level is being serviced. Some system devices, such as the printer-keyboard, operate on interrupt levels.

**TH CHK Light:** The thermal check light is lit whenever the temperature of the processing unit or printer electronics exceed the limit set for normal operation. The thermal check light is also lit by a loss of external power to the system. In both cases, power in the system shuts off and the TH CHK and PWR CHK (power check) lights are lit. For recovery procedures, see *Restoring System Power* in chapter 7.

**PWR CHK Light:** The power check light is lit by:

1. Loss of voltage or overvoltage condition in the processing unit. (The TH CHK light is not lit.)
2. Thermal condition in the processing unit or printer electronics. (The TH CHK light is lit.)
3. Loss of external power to the system. (The TH CHK light is lit.)

In all three cases power in the system shuts off. For recovery procedures, see *Restoring System Power* in chapter 7.

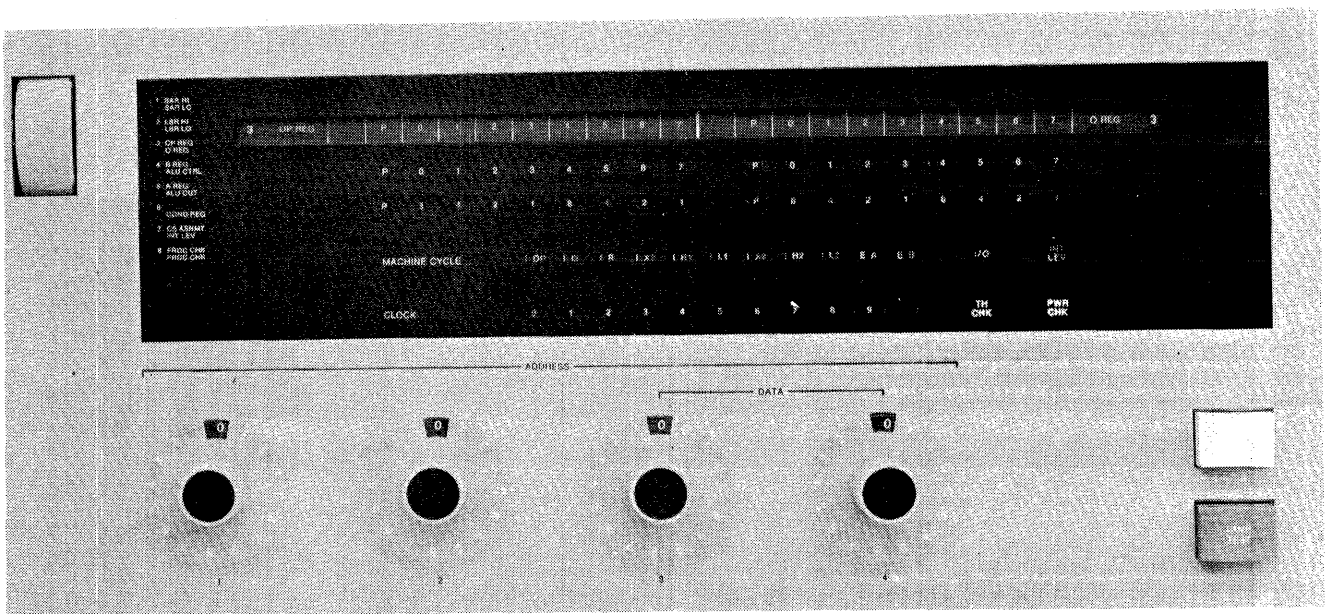

Figure 6. Processing Unit Display Panel

55025

### *Customer Engineer Control Panel*

The switches, lights, and dials on this panel (Figure 7) are used primarily by the Customer Engineer to service the system.

***I/O CHECK Switch:*** When this switch is set at STOP, the processing unit comes to an immediate stop if an input or output error occurs. The system displays show the status of the system at the time the error occurred. The I/O check, however, is normally set at RUN. This means the system will not stop if an input or output error occurs unless instructed to do so by the program in operation. In this case, the system displays do not reflect conditions at the time the error occurred.

***PARITY CHECK Switch:*** This switch is normally set at STOP. It causes the processing unit to stop when a parity error is detected and the error is displayed. When the switch is set at RUN, parity errors are detected and displayed in the register display unit (8 PROC CHK), but the system is not stopped.

***STORAGE TEST Switch:*** This switch allows the CE to alter or display storage.

***ADDR INCREM Switch:*** This switch is used by the CE to control a counter that increments the storage address register. This switch is effective only when the system is in the CE test modes of alter or display storage.

***ADDR COMPARE Switch:*** This switch enables the CE to stop the program when the contents of the storage address register (SAR) matches the setting of the address/data switches. The ADDRESS COMPARE light also turns on when these addresses match. The CE mode selector switch must be set at PROCESS and the register display unit must be set at 1 SAR HI for the ADDR COMPARE switch to be effective.

***P1 and P2 Switches:*** These two switches enable the CE to control selection of program 1 or program 2 for use in the dedicated mode (only one program can run in the system). These two switches are on for normal operation of the DPF system. These switches should never be changed unless the system is stopped. A processor check will occur if these switches are changed while the system is running.

***I/O OVERLAP Switch:*** This switch enables the CE to control system input/output operations. When in the normal ON position, input and output operations are executed at the same time the processing unit is doing other operations. When this switch is at OFF, each input/output operation must be completed before any other processing occurs.

***ADDRESS COMPARE Light:*** This light turns on when an address compare occurs (see *Addr Compare Switch*).

***I/O CHECK Light:*** This light turns on when certain errors occur in an input or output device. It is turned off when the SYSTEM RESET key or CHECK RESET key is pressed, or the input/output device error condition is corrected.

***CE KEY Switch:*** This switch is operated by the customer engineer to prevent recording time on the customer usage meter. It allows the CE meter to run when the system is being serviced.

***SYSTEM RESET Key:*** When the SYSTEM RESET key is pressed, the system enters an idle state. All input/output and machine registers, controls, and indicators are reset. A program must be reloaded after a system reset. The CE mode selector switch must be set at PROCESS for the SYSTEM RESET key to be effective.

***CHECK RESET Key:*** When this key is pressed, all current error conditions in the processing unit and input/output devices are cleared. The system resumes normal operation when console START (HALT/RESET if you have DPF) is pressed. The CHECK RESET key is also used to reset a power check.

***BSCA STEP Key:*** This key is used for BSCA testing. The key is effective only when BSCA is in the test mode and step mode.

***FILE WRITE Switch:*** When this switch is at OFF, write operations cannot be performed on the disk.

***BSCA LOCAL TEST Switch:*** This switch is used for testing BSCA on systems that have high speed data sets. For normal operation, the switch is in the off position. The switch is present only if you have high speed data sets.

***FILE WRITE Switch:*** When this switch is at OFF, write operations cannot be performed on the disk.



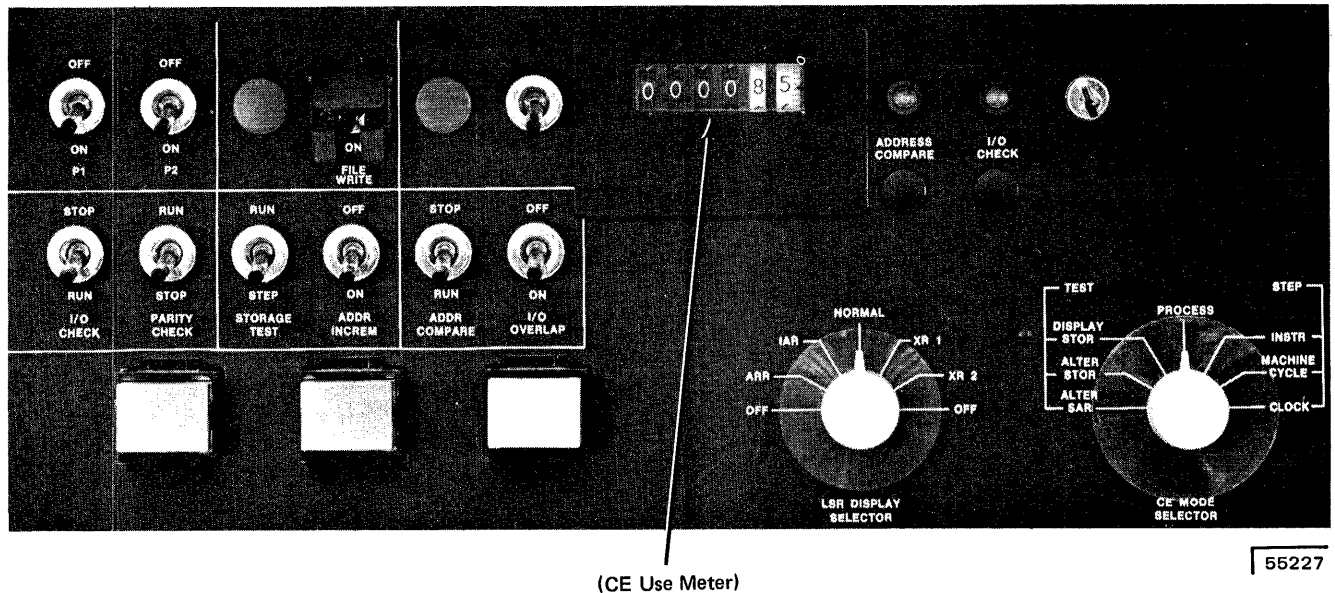

Figure 7. Customer Engineer Control Panel

**LSR DISPLAY SELECTOR:** This rotary switch selects the area of internal storage to be displayed by the register display unit.

**CE MODE SELECTOR:** This rotary switch selects one of the three processing modes: process, step, or test. Process is the mode for normal system operation. In step mode, one of three settings can be used to control the way in which the program is executed. The test mode settings are used by the CE to display or alter storage.

*Disk Panel*

The disk panel (Figure 8) consists of a rotary switch (to indicate the initial program load device) and controls and indicators that control the disk and indicate the status of the disk.

**PROGRAM LOAD SELECTOR Switch:** This rotary switch is used to select the unit from which you initiate IPL. The FIXED DISK and REMOVABLE DISK positions refer to drive 1 only (top drawer).

**START/STOP Switches:** These switches (one for each drive) turn the disk drive power on or off when system power is on. With the switch at OFF and the OPEN light on, the drawer can be opened and the removable disk can be replaced.

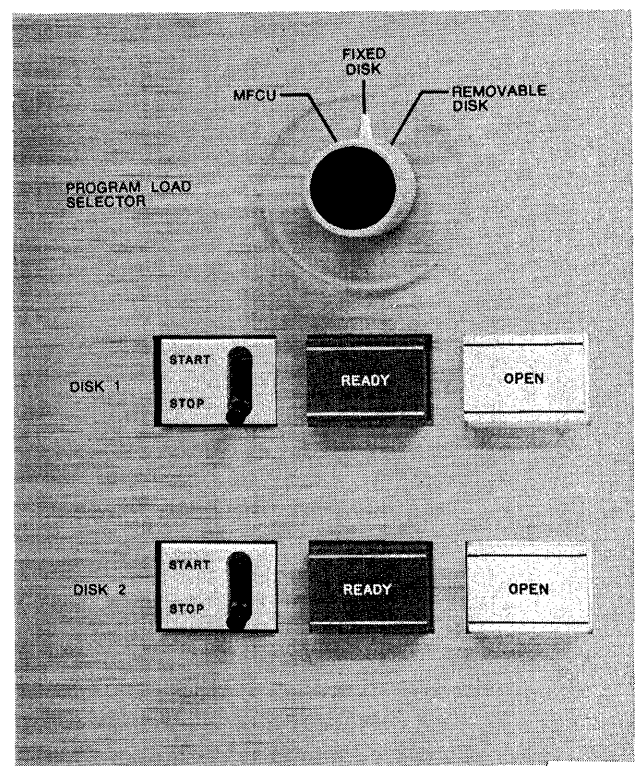

Figure 8. Disk Panel

**READY Lights:** These lights (one for each drive) are on when the disk drive is ready for use. If you try to use the drive before this light is on, I/O ATTENTION on the console turns on.

**OPEN Lights:** These lights (one for each disk drive) indicate that the associated disk drive drawer can be opened for changing the removable disk. This light is on when the start/stop switch is placed at STOP and the disk has come to a stop.

### Dual Program Control Panel

Your system can have the Dual Programming Feature (DPF). This feature enables the system to have two programs in storage at the same time. The dual program control panel (Figure 9) contains switches, lights, and keys used to initiate and control the running of two completely different programs.

**Message Display Unit (Program 1 and 2):** Whenever a programmed halt occurs, a combination of the letters in the appropriate DPF message display unit is displayed: A, C, E, F, H, J, L, P, U, or Y, quote ('), dash (-), blank and 0 through 9. The displayed characters are used to identify the halt. In the dual programming mode, both display units can be lit at the same time. The PROCESS light determines which program is in control. The HALT/RESET key is used to take a program out of its programmed halt.

**PROCESS Lights (Program 1 and 2):** These lights indicate which program level (program 1 or 2) is currently being used. When the PROCESS light for program 1 is off, program level 1 is being used. When the PROCESS light for program 2 is off, program level 2 is being used.

**HALT/RESET Keys (Program 1 and 2):** HALT/RESET is used to take a program (1 or 2) out of its programmed halt. When the correct HALT/RESET key is pressed, (PROCESS light is lit) the message display unit for that program is cleared and the program continues normal operation.

**DUAL PROGRAM CONTROL Switch:** This switch is only used in conjunction with the INTERRUPT key. When you press the INTERRUPT key, the system expects the input for the job to be supplied from one of three possible devices selected by you: MFCU, auxiliary device (AUX), or printer-keyboard (P-KB). The MFCU position on the panel refers to the primary hopper of the MFCU as the input device. The input device related to the AUX and P-KB positions on the panel are selected when system generation is performed. For information on which devices can be selected for the AUX and P-KB positions, see *Chapter 9. System Generation*. The CANCEL position allows you to cancel the job for the program (1 or 2) selected. See *Chapter 7. System Operation* for information on cancelling jobs.

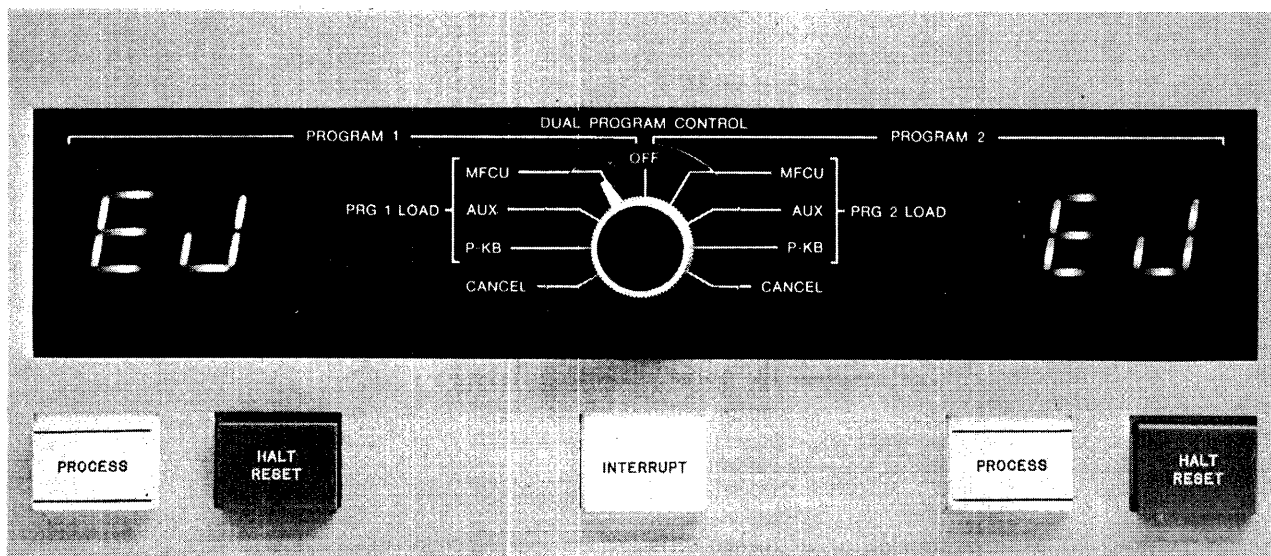

Figure 9. Dual Program Control Panel

55228



**INTERRUPT Key/Light:** INTERRUPT is pressed when you want to initiate or cancel a job. The key is effective only when the INTERRUPT light is lit. This key is used in conjunction with the DUAL PROGRAM CONTROL switch. INTERRUPT is lit when you are operating in the DPF mode.

### Binary Synchronous Communications Adapter Panel

The binary synchronous communications adapter (BSCA) panel (Figure 10) contains the lights and a switch to indicate and control the status of telecommunication processing.

#### Lights

The following text describes the lights you are concerned with when running BSCA programs:

**BSCA ATTN:** This light turns on when BSCA is addressed and one of the following conditions is present:

- A data set is not ready.
- Auto call unit power is off.
- Data line is being used.
- BSCA is disabled.
- External test switch is in the TEST position and BSCA is not in the test mode.

The I/O ATTENTION light on the console is also on whenever the BSCA ATTN light is on.

**DT TERM READY:** This light turns on when BSCA is enabled and the data terminal is ready for use.

**DT SET READY:** This light turns on when the data set ready line from the data set is on and the data set is ready for use.

**TEST MODE:** This light turns on when a program places BSCA in the test mode of operation. The light is used only when diagnostic programs are run.

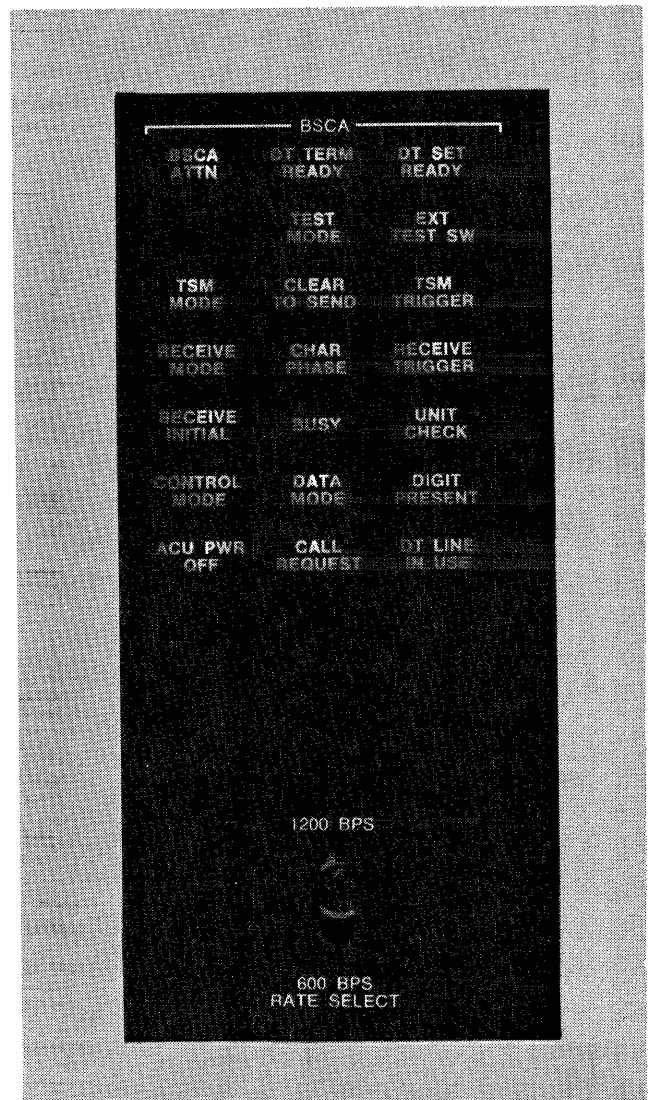

● Figure 10. BSCA Panel

55027A

**EXT TEST SW:** For medium speed data sets, this light turns on when the switch on the cable is in the TEST position. For high-speed data sets, this light is on when the local test switch on the CE panel is in the on position. This light is used only when diagnostic programs are run.

**TSM MODE:** This light turns on whenever data is being transmitted.

**CLEAR TO SEND:** This light turns on to indicate that the BSCA hardware may now transmit.

**TSM TRIGGER:** This light indicates the instantaneous value of the data being transmitted.

**RECEIVE MODE:** This light turns on when a receive operation is taking place.

**CHAR PHASE:** This light turns on when BSCA has established character synchronism with the transmitting station and is receiving data. The light is turned off when character synchronism is lost or when receive operations have ended.

**RECEIVE TRIGGER:** This light indicates the instantaneous value of the data being received.

**RECEIVE INITIAL:** This light turns on at the initiation of a receive operation and turns off at the end of the initiation operation.

**BUSY:** This light turns on when BSCA is executing a receive initial, transmit and receive, autocall, or receive only operation.

**UNIT CHECK:** This light turns on when the BSCA program should enter an error recovery procedure.

**CONTROL MODE:** This light is used only on systems that have multipoint nonswitched network feature installed. The light is turned on when the control station finishes data transfer with a remote terminal. It is turned off when the control station initiates data transfer with a different remote terminal.

**DATA MODE:** This light turns on during a transmit or receive operation when data is being checked for errors. It is turned off at the end of the transmit or receive operation.

**DIGIT PRESENT:** This light is used only on systems that have the autocall feature installed. This light is turned on when a digit is being dialed by the autocall unit.

**ACUPWR OFF:** This light turns on when the power for the autocall unit is off.

**CALL REQUEST:** This light turns on when an autocall operation is being performed.

**DT LINE IN USE:** This light turns on when autocall is being performed, or TALK has been pressed on the data phone while the phone is off the receiver.

#### **Switches**

**RATE SELECT:** This switch is present only on systems that have the rate select feature installed. The switch controls the rate at which data is transmitted and received. The switch must be set so the transmission rate of both terminals is identical.

## Chapter 3. IBM 5424 Multi-Function Card Unit

- MFCU Controls and Indicators
- Clearing a Card Jam
- Changing the MFCU Print Ribbon
- Emptying the MFCU Chip Box

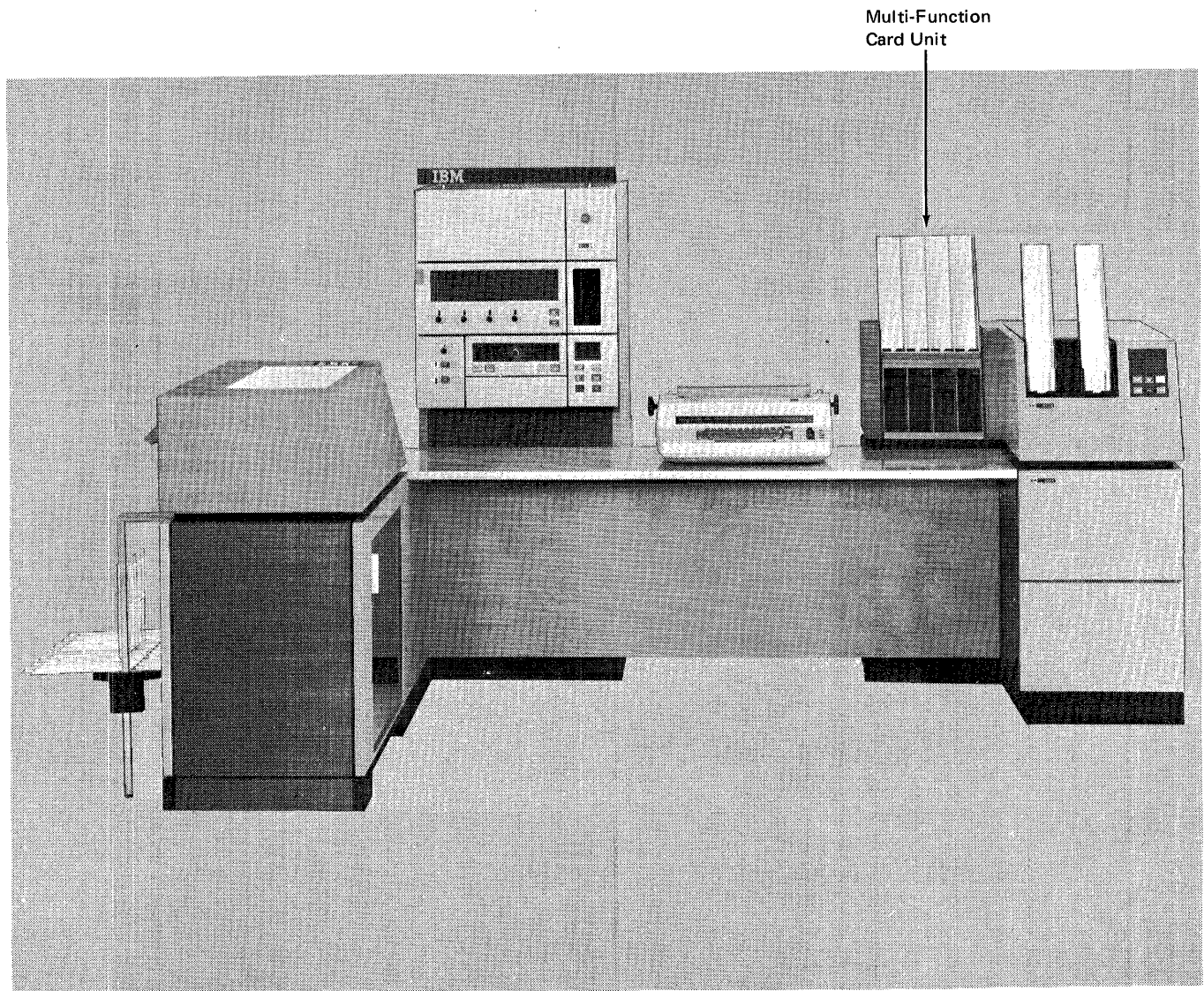

55239A

## MFCU CONTROLS AND INDICATORS

The lights and keys that you use to communicate with the MFCU are on the front of the MFCU.

### Lights

There are thirty lights on the top part of the MFCU operator panel. Twenty of these are numbered and identify the position of cards within the MFCU when a feed check occurs (see *Clearing a Card Jam*). A description of the other lights on the MFCU panel are as follows:

**SEC:** The last card was fed from the secondary hopper.

**PRI:** The last card was fed from the primary hopper.

**RD:** There was a read check on the last card read. The SEC or PRI light indicates which hopper the card came from.

**HPR:** A card did not feed from the selected hopper. The SEC or PRI light indicates which hopper failed to feed a card.

**NPRO:** The card paths are not clear. This light also comes on when the system is turned on. To turn the light off, press the NPRO key twice after turning on the system. The hoppers must be empty for the NPRO key to be effective.

**STKR:** One of the four stackers is full. You can turn this light off by removing the cards from the stacker and pressing START or NPRO.

**CHIP:** The chip box is either full or out of the machine. To turn the light off, correct the condition and press START or NPRO.

**CVR:** The top covers are open or not securely latched. To turn the light off, close the covers and press START or NPRO.

**SECONDARY READY:** The secondary feed path is ready for operation.

**PRIMARY READY:** The primary feed path is ready for operation.

### Keys

**NPRO (Nonprocess Run Out):** Press this key to clear cards from the MFCU. Make sure the card hoppers are empty. Press the key twice to clear both the primary and secondary card paths. The primary feed path is cleared first. Both feed paths empty into stacker 1.

**START:** Press this key to place the MFCU in a ready condition. One or both card feeds are readied, depending on whether cards are in the hoppers and the card paths are clear. Use of the START key does not cause cards to feed from the hoppers.

**STOP:** Press this key to indicate to the system that the MFCU should stop after it completes the current operation. The ready lights turn off.

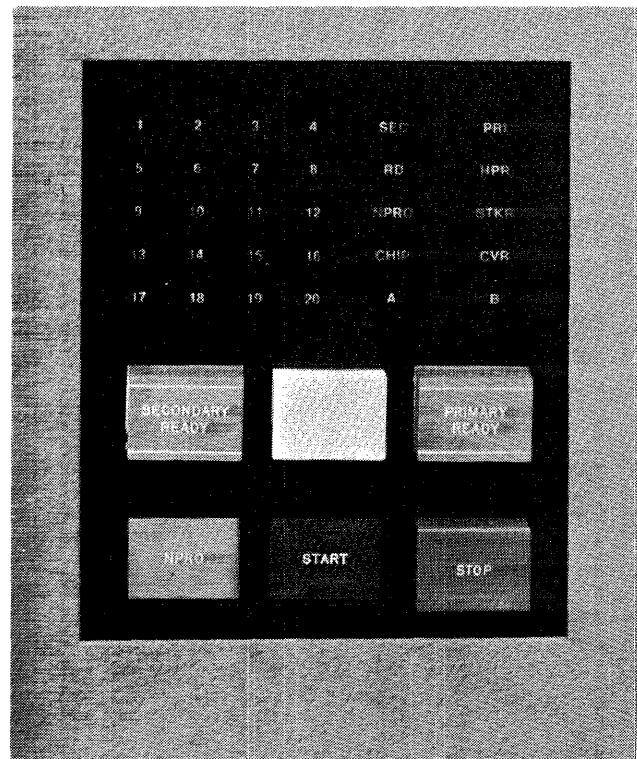

55027

### Customer Engineering Aids

If you press the LAMP TEST key on the processing unit console, you will see two additional indicators on the MFCU panel. They are labeled A and B. These lamps are CE diagnostic aids and are not lit during normal system operations.

## CLEARING A CARD JAM

The following procedure tells you how to remove cards from the MFCU card paths.

The program recovery procedure—what to do with the cards to continue program operations—are listed under the F0 and F1 halts in the *IBM System/3 Disk System Halt Procedure Guide*, GC21-7540.

### Indications

A misfeed or card jam in the MFCU is indicated by any or all of the following:

- F0 or F1 halt in the console message display unit.
- MFCU ready lights are off.

- A number (1 to 20) is lit on the MFCU operator's panel.
- NPRO light is on.

The numbers on the MFCU operator's panel indicate where in the card paths the trouble occurred. When a misfeed or jam occurs, write the number down in your console log book. If the same number occurs repeatedly, the MFCU needs service.

When the card paths are cleared, press NPRO twice to turn off the error indicator on the MFCU operator's panel.

### Removing Cards From the Card Feed Paths

The MFCU card paths are shown in Figure 11. The numbers refer to the photographs that show how to remove a card from a particular place in the card path.

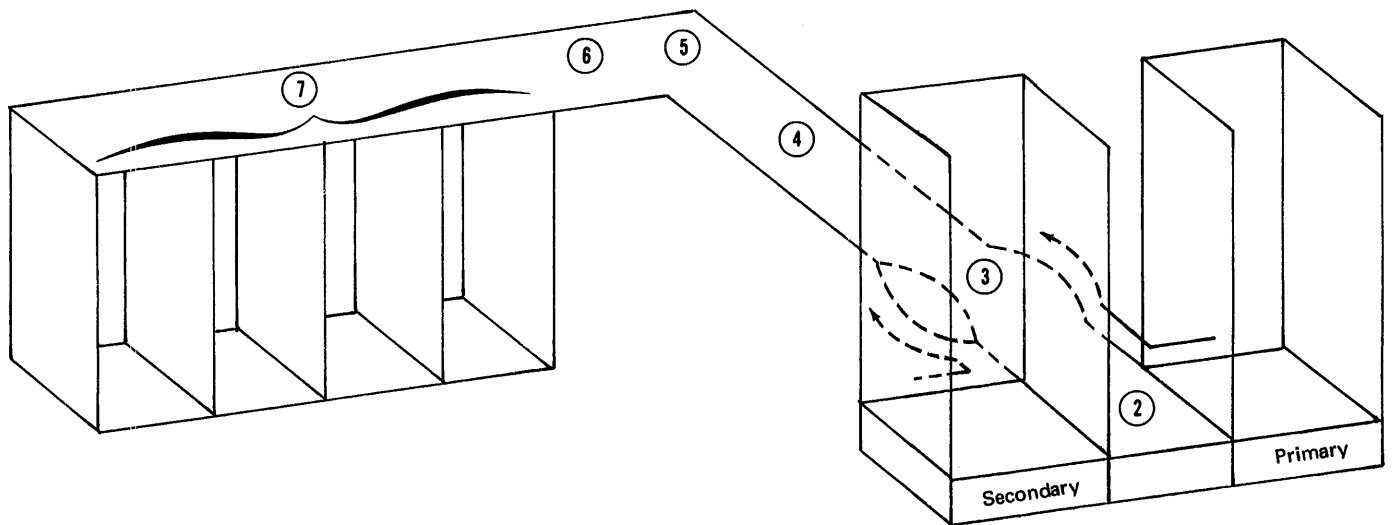
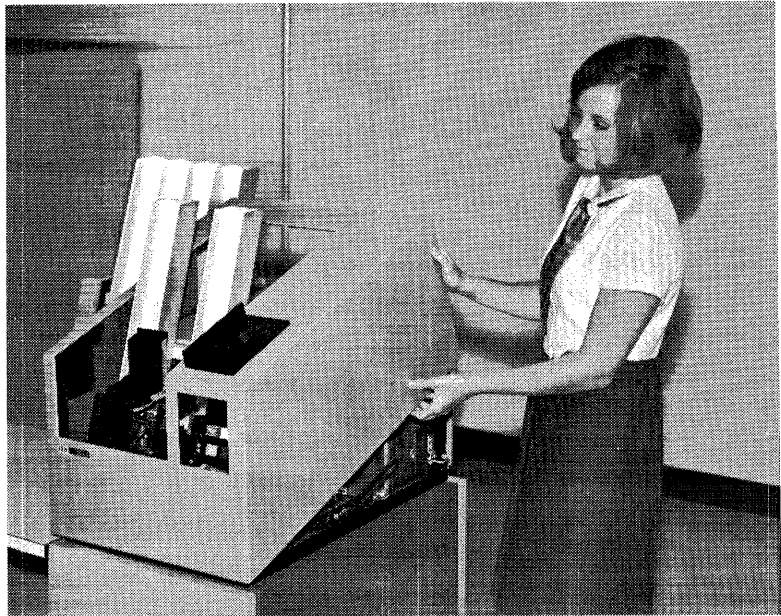

Figure 10. MFCU Card Paths

- ① To open the MFCU top covers, lift latch to release cover. Pivot outer and inner top covers towards front of machine.



ART: 55028

- ② To remove a card from the hopper station, press down on latch and raise cover. Close cover when station is cleared.

If a card will not come out, free it by turning the feed drive wheel (see item ④).

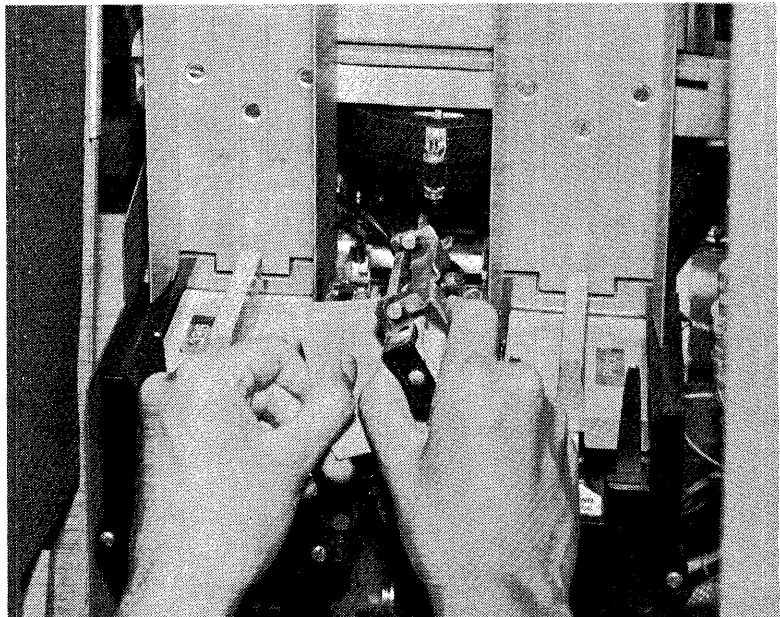

ART: 55029



3

To remove a card from a wait station, open spring-loaded cover and remove card.

Primary Wait

Secondary Wait

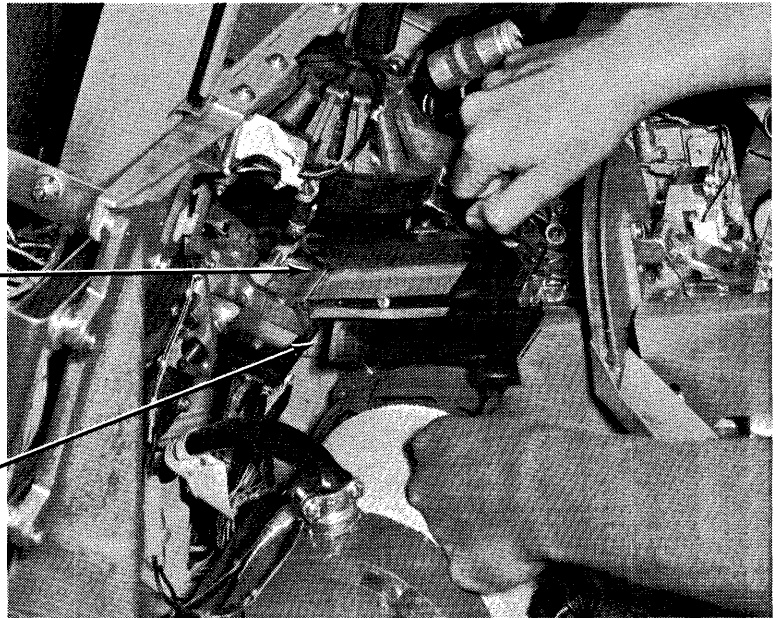

ART: 55030

4

To remove a card from the punch unit, turn feed drive wheel clockwise to advance card.

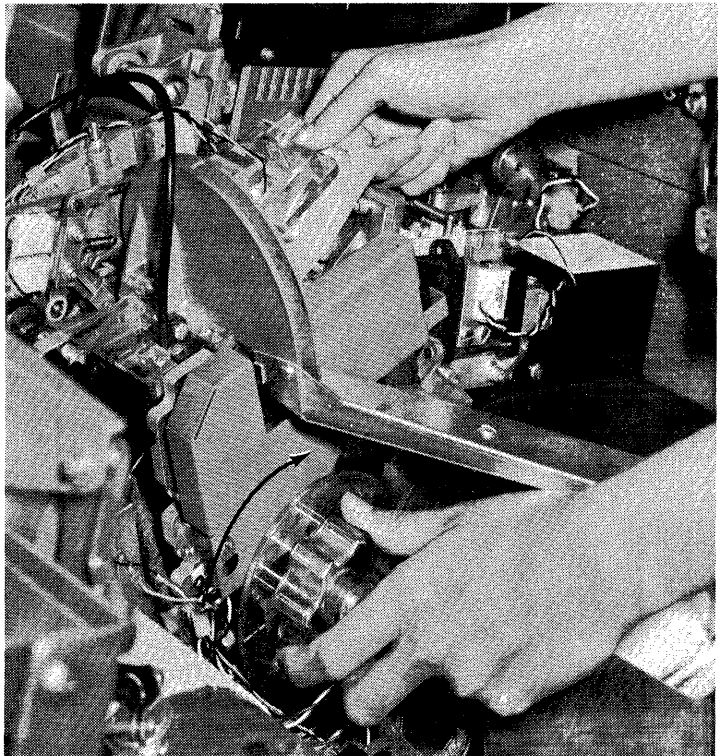

ART: 55031

**5**

To remove a card from the corner station, pull back on latch to open cover. Close cover when station is cleared.

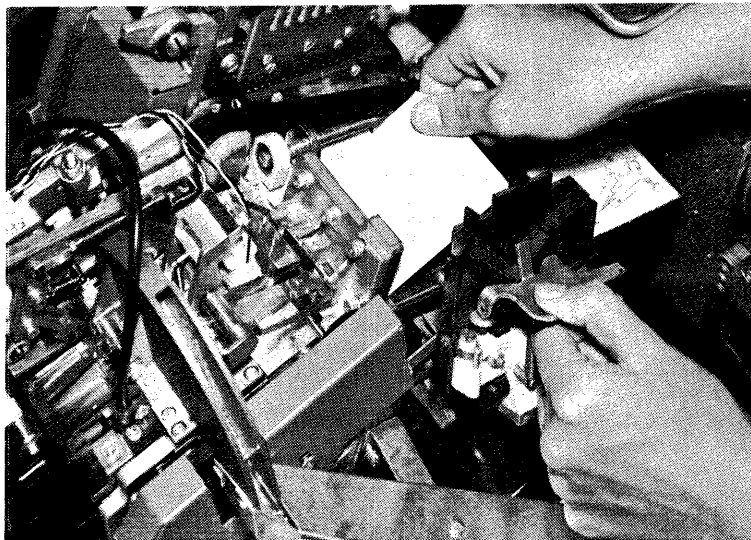

ART: 55032

**6**

To remove a card from the print unit, turn shaft counter-clockwise to unlock print unit. Tip unit towards front of MFCU. Lock print unit when station is cleared.

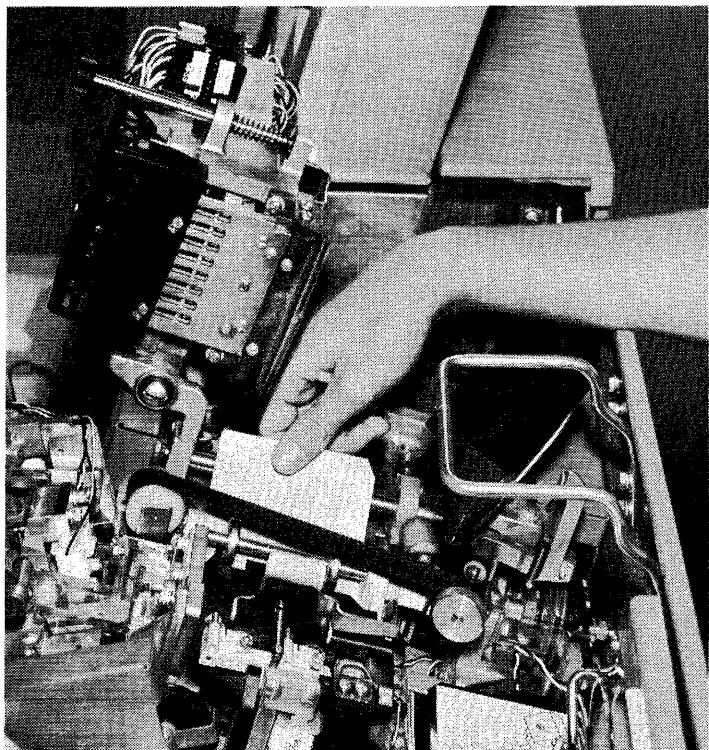

ART: 55033



7

To clear a stacker jam, raise spring-loaded cover over stackers and remove jammed cards.

If card will not come out, open top covers and free it by turning the feed wheel drive (see preceding item 4).

Never remove cards from the stackers while the MFCU is running.

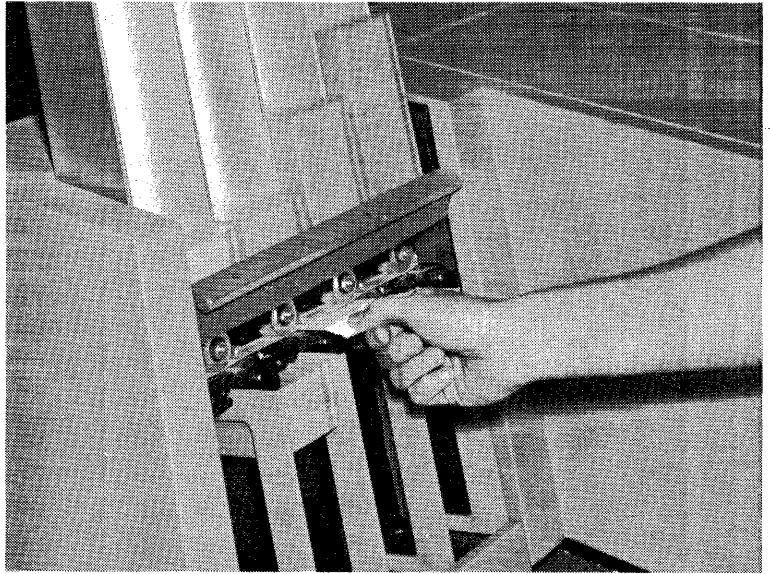

ART: 65034

## CHANGING THE MFCU PRINT RIBBON

### Removal

- 1 Open MFCU top covers. Lift latch to release cover. Pivot outer and inner top covers towards front of machine.

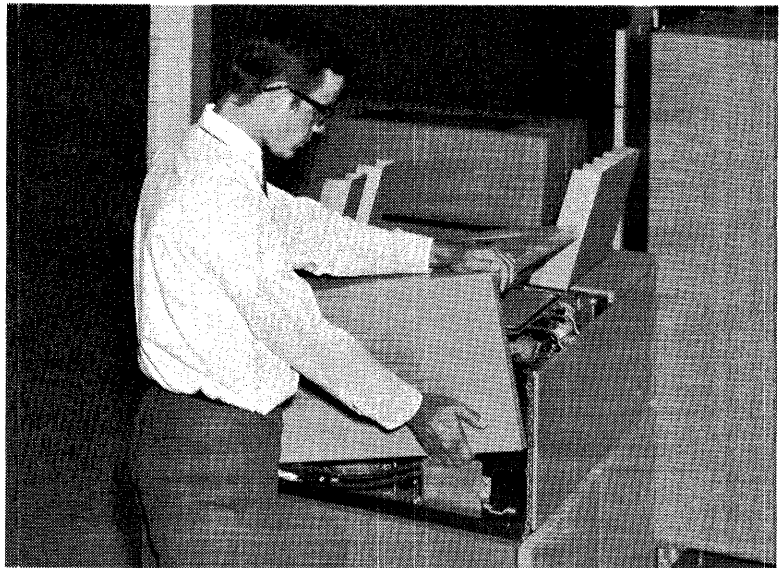

ART: 55042

- 2 Raise print unit. Turn shaft counterclockwise to unlock. Tip unit towards front of MFCU.

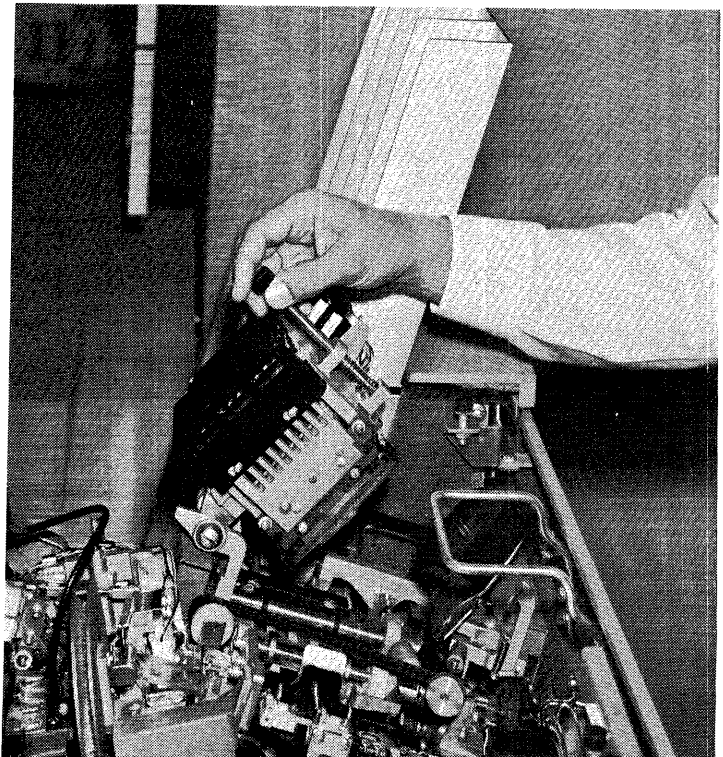

ART: 55035

3

Slide ribbon out of ribbon drive. Pull ribbon back towards ribbon drive to get slack.

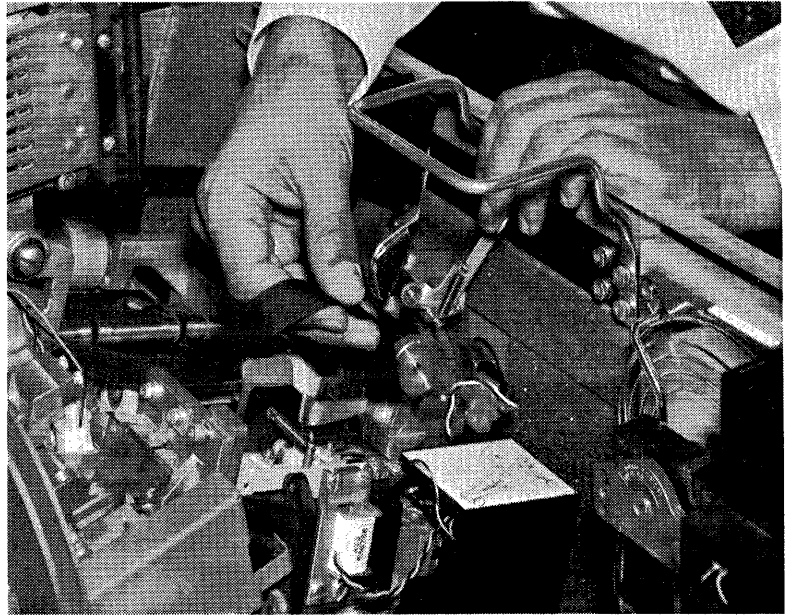

ART: 55036

4

Squeeze split shaft holding ribbon cartridge and pull cartridge off shaft.

Split Shaft

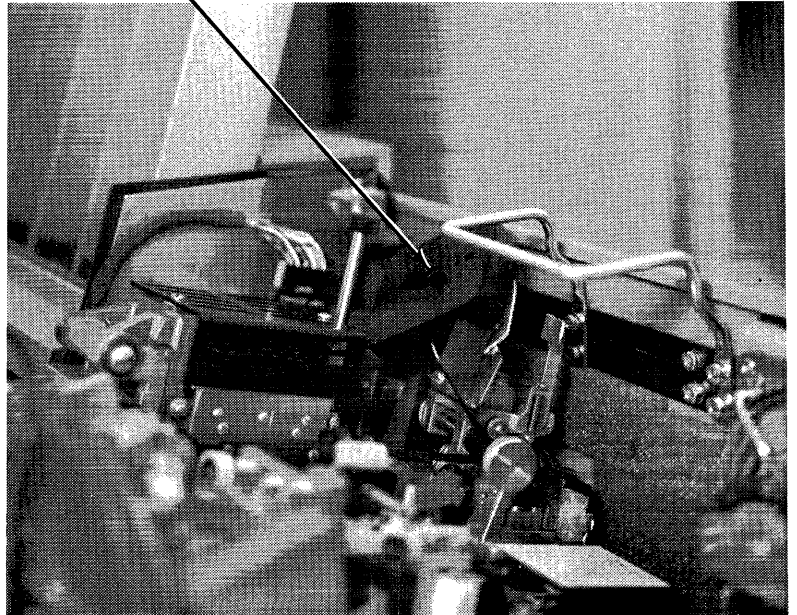

ART: 55037

**5**

Slip ribbon out from under guide plate and front and rear rollers and remove ribbon cartridge from machine.

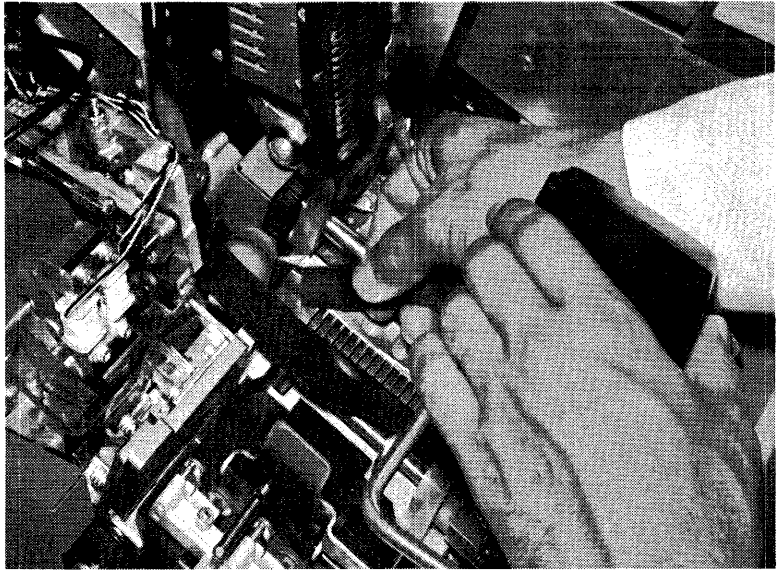

ART: 55038

## Installation

- 1 Snap new ribbon cartridge in place. The ribbon feeds down from the back of the cartridge.

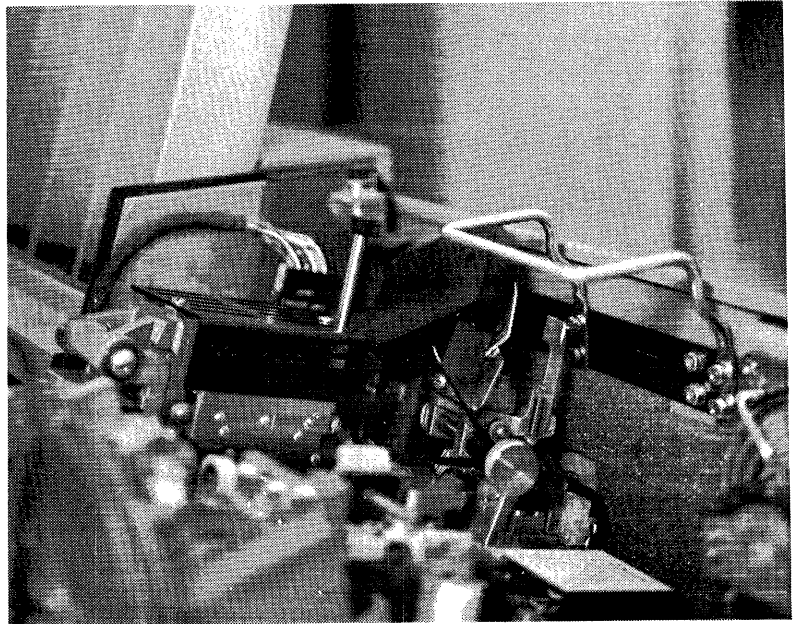

ART: 55037

- 2 Slip ribbon into ribbon drive.

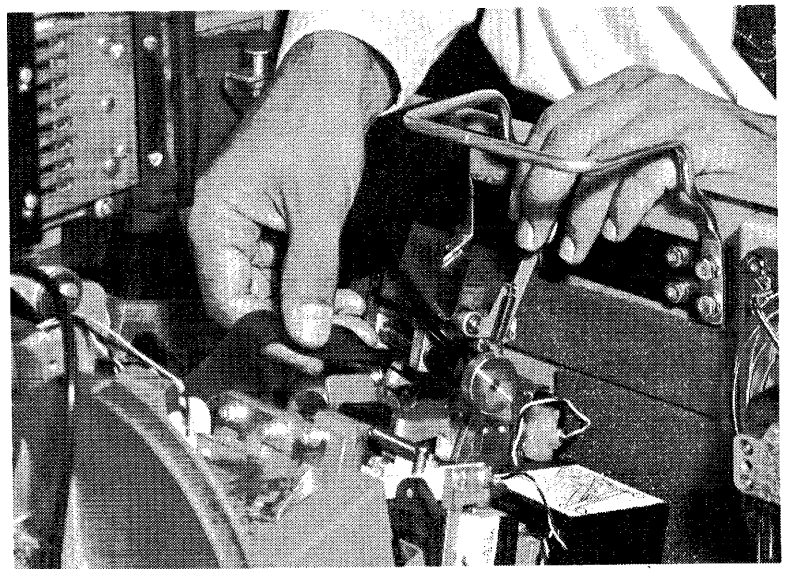

ART: 55036

- 3** Position ribbon under guide plate and under front and back guide.

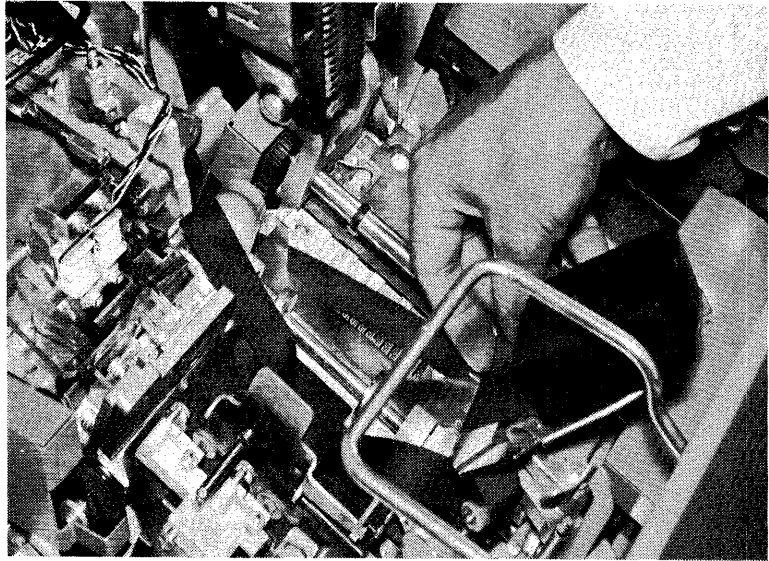

ART: 55039

- 4** Turn knob on ribbon drive counterclockwise to take up slack in ribbon.

**Note:** Apply light pressure with one finger under the ribbon during the take-up operation. No folds should be allowed to feed into the ribbon cartridge. When the take-up operation is complete, check the ribbon path to ensure there are no folds in the ribbon and the ribbon is not wrapped around any of the guides or rolls.

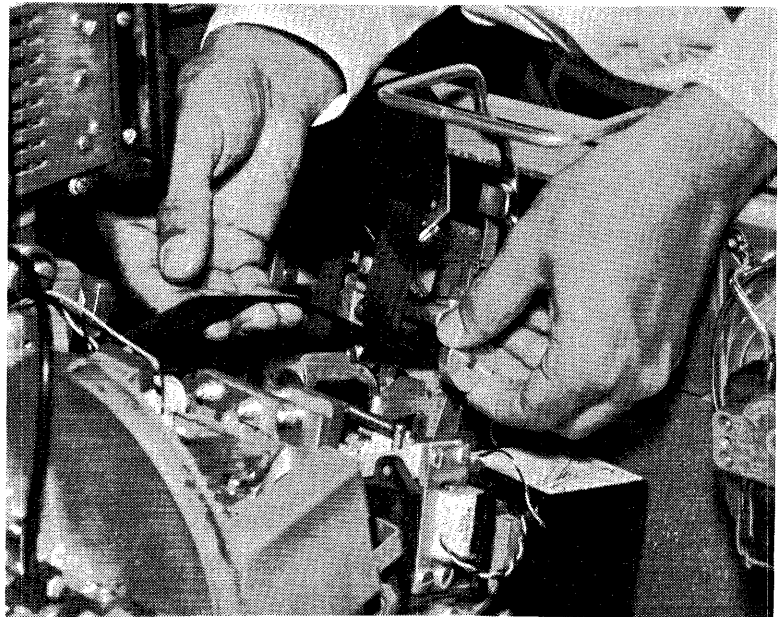

ART: 55040

- 5 Close and lock print unit.
- 6 Close MFCU top covers.
- 7 Press and hold NPRO key to feed ribbon. Release NPRO key.

Raise top cover to see if ribbon is feeding properly. If ribbon is feeding properly, close top cover and resume program operations.



## EMPTYING THE MFCU CHIP BOX

- 1 Open MFCU top cover. Lift latch to release cover. Pivot outer top cover towards front of machine.

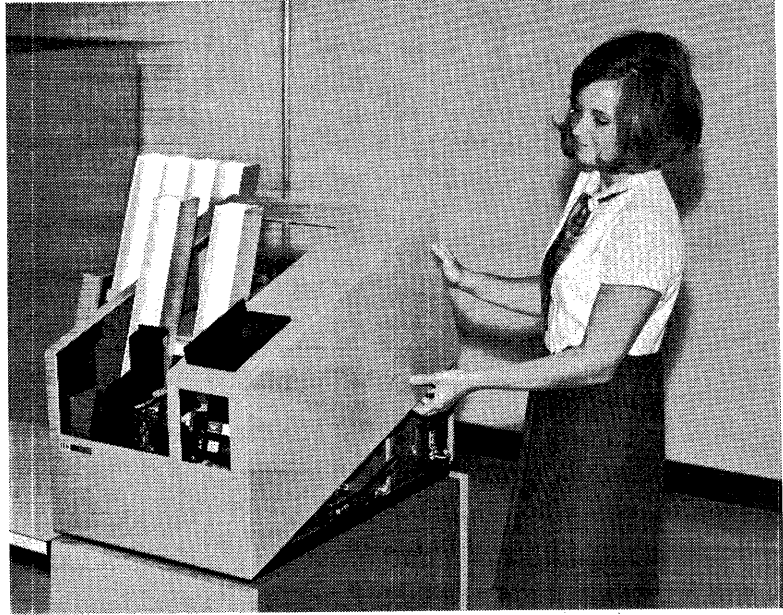

ART: 55028

- 2 Lift chip box up and out towards front of machine.

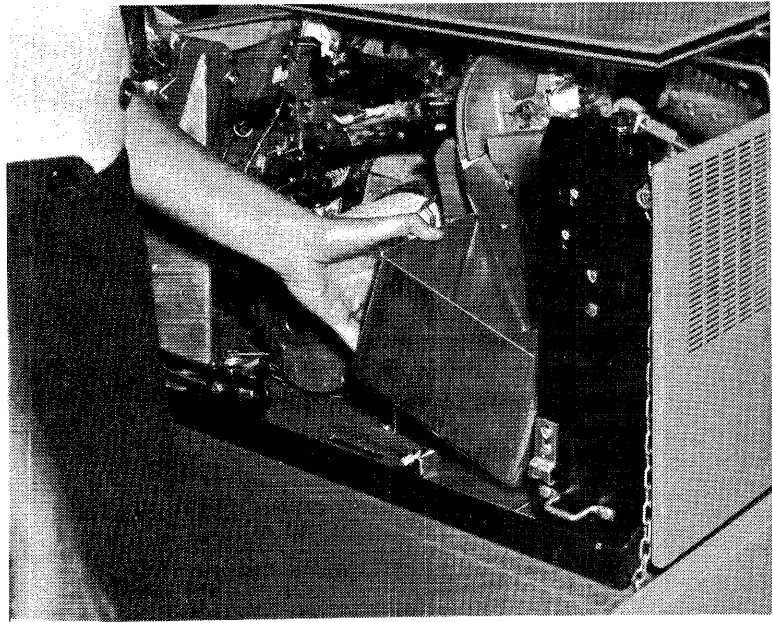

ART: 55041

- 3 Empty chip box.
- 4 Replace chip box.
- 5 Close MFCU top cover.
- 6 Press MFCU START to turn off CVR and CHIP lights on MFCU operator's panel.



- Printer Controls and Indicators
- Loading Forms in the Printer
- Changing the Printer Ribbon
- Changing the Print Chain Cartridge

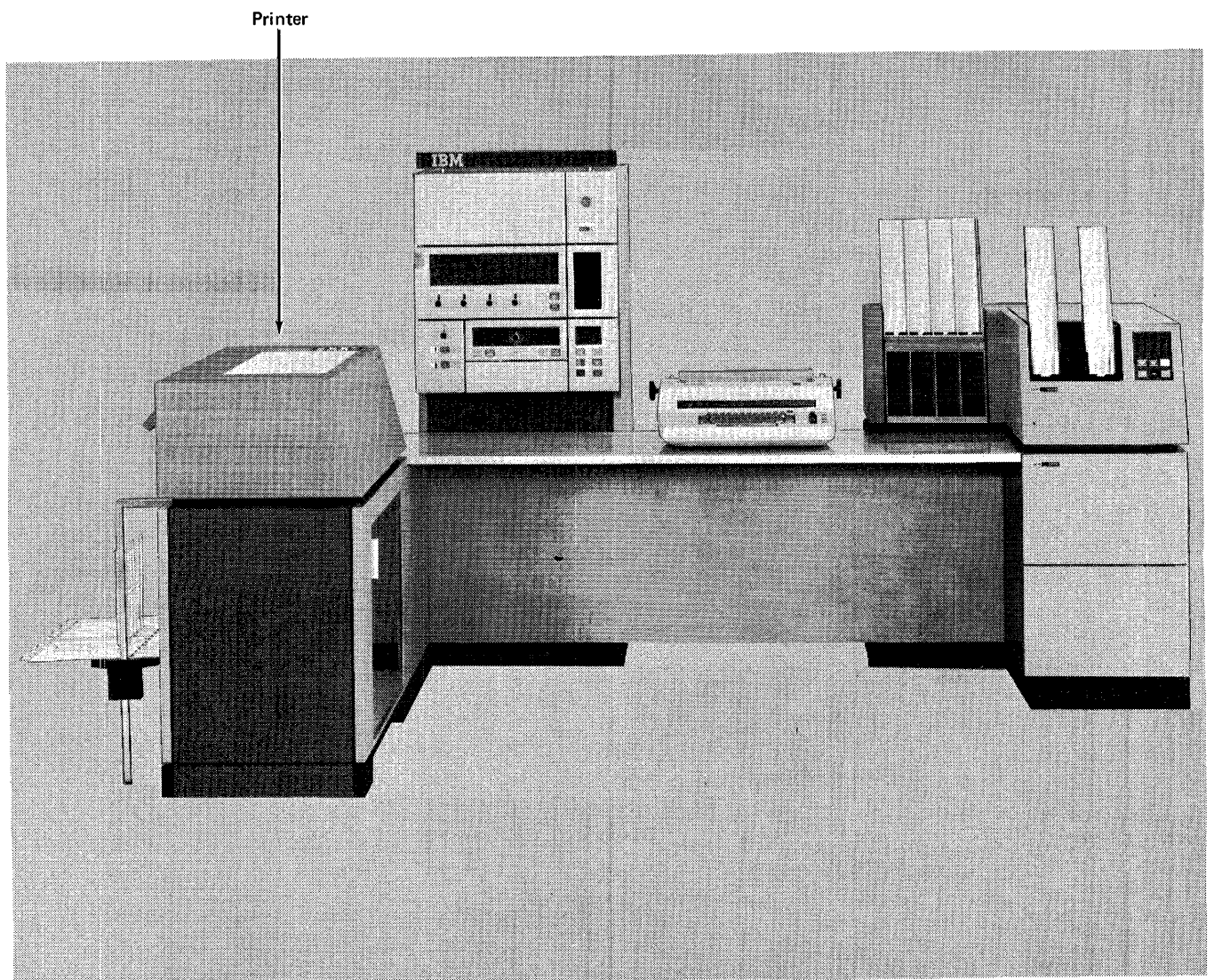

55239A

## PRINTER CONTROLS AND INDICATORS

The lights and keys you use for communication with the printer are located on a panel on the printer. This panel contains four keys and four lights (six keys when the dual-feed carriage is installed).

### Lights

**READY Light:** The READY light indicates that the printer is ready to print. When the light is on, the system has control of the printer. At this time, you cannot use CARRIAGE SPACE and CARRIAGE RESTORE keys.

The READY light turns on when you press START if no interlock and check conditions exist and there are forms in the printer. The READY light turns off if you press the STOP key, or if an interlock, check, or end-of-forms condition occurs.

**CHECK Light:** The CHECK light turns on when the system detects a condition that prevents or impairs print operations. The CHECK light turns off if you correct the error condition and press the START key.

**INTERLOCK Light:** The INTERLOCK light turns on when either of the following conditions exist:

1. Chain interlock. This condition occurs when the rear unit is open. The chain motor starts only when the rear unit is properly closed.
2. Chute interlock. This condition occurs when the forms chute is not pivoted back to the feed position.

The INTERLOCK light turns off when you correct the condition causing the interlock and press the START key.

**FORMS Light:** The FORMS light is turned on when about 14 inches (356 mm) of paper remains below the print line. When this light comes on, the printer finishes printing the current form and skips to the next form. As line 1 of the new form is detected, the READY light turns off. The

paper stops at the first print line of the new form. No more printing can be done until new forms are loaded in the printer.

To restart, load new forms, using the forms loading procedure. It is not necessary to use the CARRIAGE RESTORE or CARRIAGE SPACE. Position the new form at the same line where the old form stopped. Press START to continue.

### Keys

**START Key:** When you press this key, it indicates to the system that the printer has been prepared for operation. If the printer is ready, READY turns on.

**STOP Key:** When you press the STOP key, it indicates to the system that the printer should stop after it completes the current print operation. The READY light turns off. If you press the STOP key during a manual restore operation, the forms stop immediately.

**CARRIAGE RESTORE Keys:** When you press the CARRIAGE RESTORE key, the forms advance to the first print line of a new form. If your printer has the dual-feed carriage, LEFT CAR. RESTORE restores the left carriage and RIGHT CAR. RESTORE restores the right carriage.

The restore keys are operational only when the printer is not ready. If READY is on, you must press the STOP key before the forms can be restored. The carriage restore keys can be used when the rear unit is open.

**CARRIAGE SPACE Keys:** When you press the CARRIAGE SPACE key, the forms advance one space. If your printer has a dual-feed carriage, LEFT CAR. SPACE moves the left carriage and RIGHT CAR. SPACE moves the right carriage.

The space keys are operational only when the printer is not ready. If READY is on, you must press the printer STOP key before the forms can be spaced. The carriage space keys can be used when the rear unit is open.

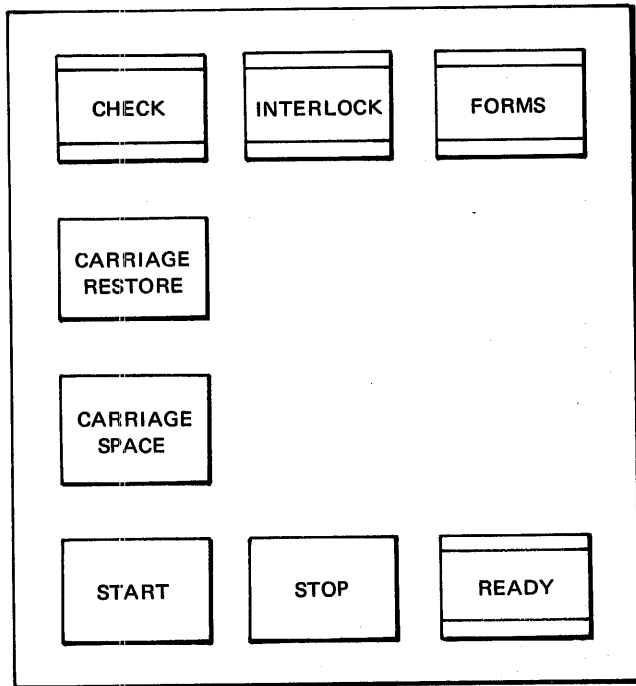

Printer Operator's Panel (Single-Feed Carriage)

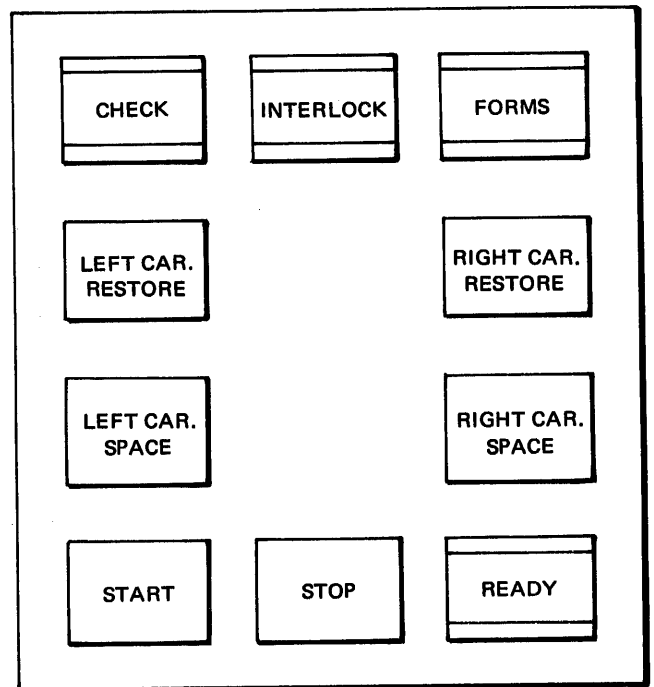

Printer Operator's Panel (Dual-Feed Carriage)

## LOADING FORMS IN THE PRINTER

- 1 Open printer top cover.



ART: 55047

- 2 Tip rear unit back.

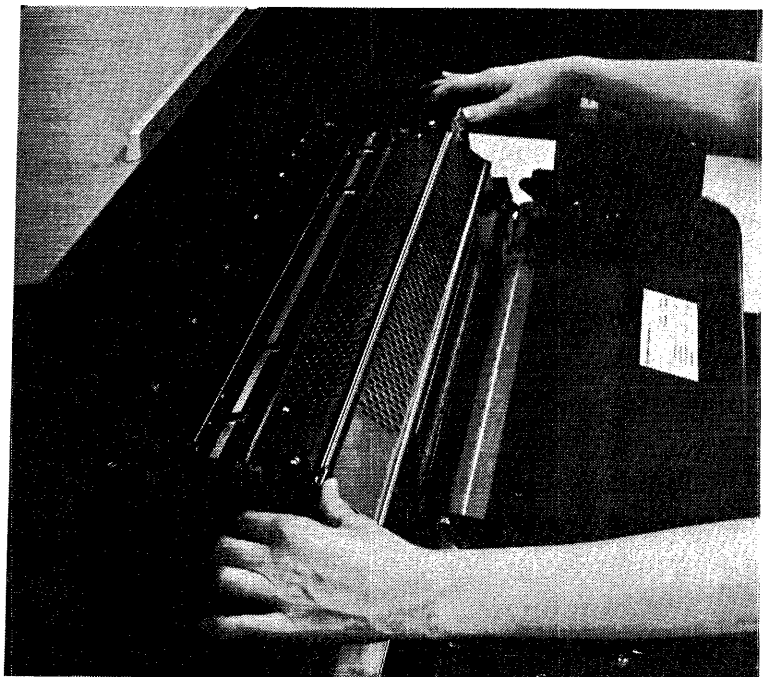

ART: 55048

3

Open forms tractors and position them for forms you are using. The tractors move easily when they are open.

Note: When full width forms, card stock, or envelopes are used, dummy tractors (clip-ons) must be installed between the tractors used to move the form. Dummy tractors ensure proper forms feeding. Up to three dummy tractors may be used.

Dummy Tractors (Clip-ons)

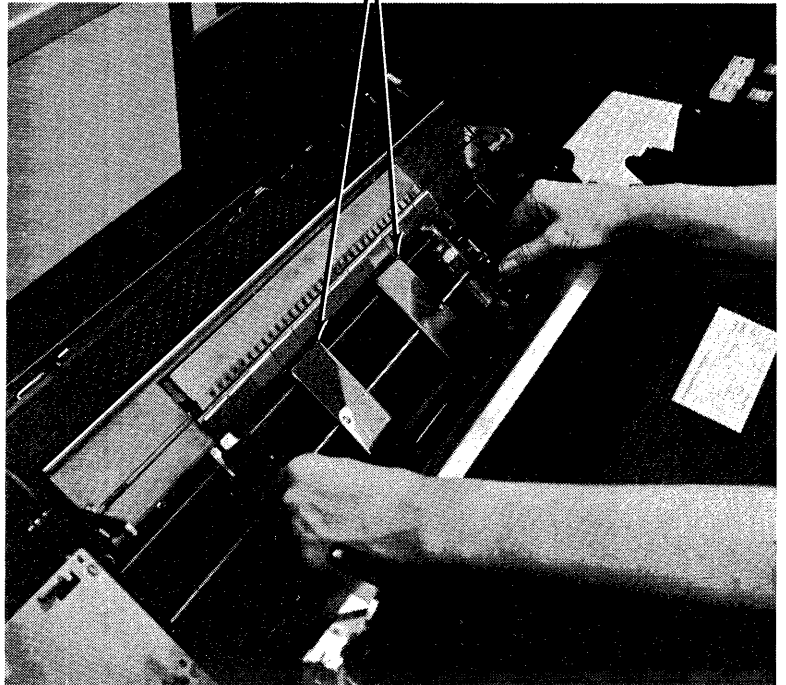

ART: 55049

4

Open sliding door and pull forms chute forward to forms loading position.



ART: 55060

- 5** Position forms and feed first form up forms chute. On multiple-copy forms, the dull side of the carbon should be towards you.



ART: 55051

- 6** Pull forms up and lay them back across tractor assembly. Place forms in form tractors, making certain that tractors keep tension across forms.

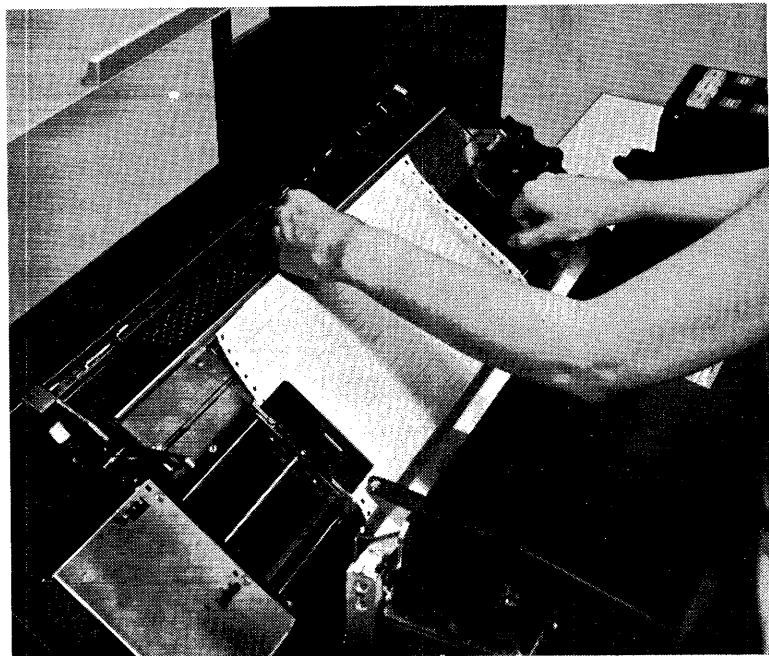

ART: 55052

(System power must be on to perform the following steps.)

- 7 Feed forms back under pressure rollers using carriage restore key.

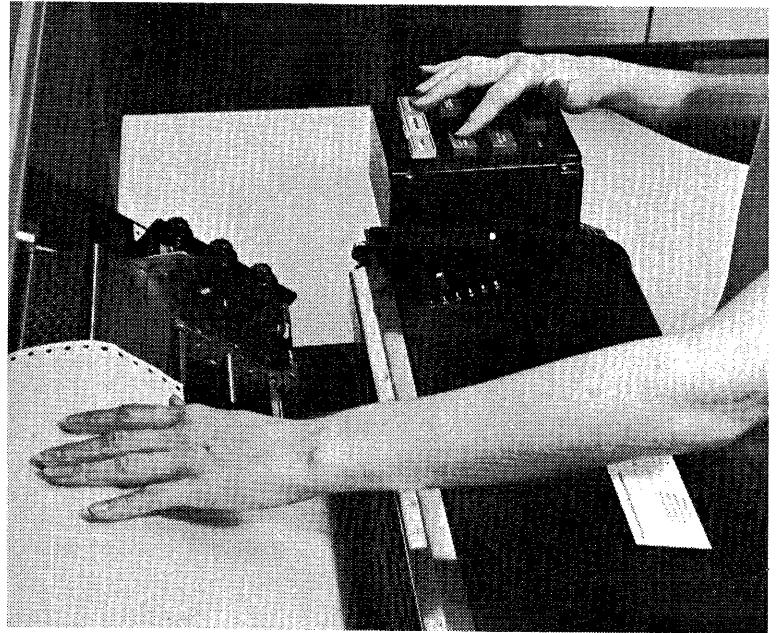

ART: 55053

- 8 Position the pressure rollers on the forms so the outside edges of the rollers are aligned approximately with the center of the pin feed holes. Use only two rollers on a form (one on each side). To prevent ink smudging, the rollers must be outside the print area. To prevent the rollers from possibly pulling the tear strip off the forms, the rollers should overlap the perforation of the tear strip.

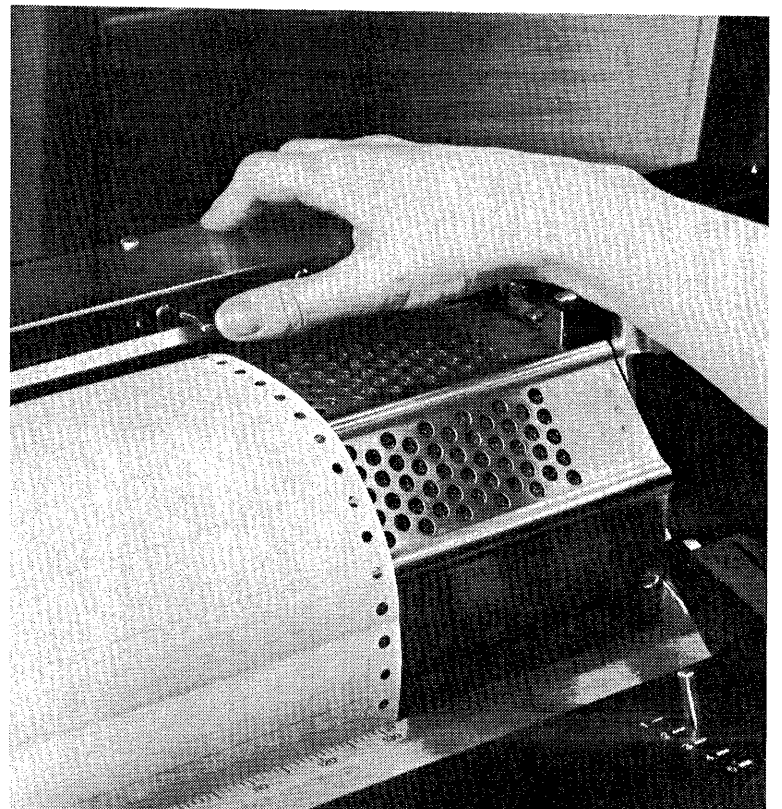

ART: 55054



- 9 Set pressure roller tension for forms you are using. See recommendation label on ribbon cover.

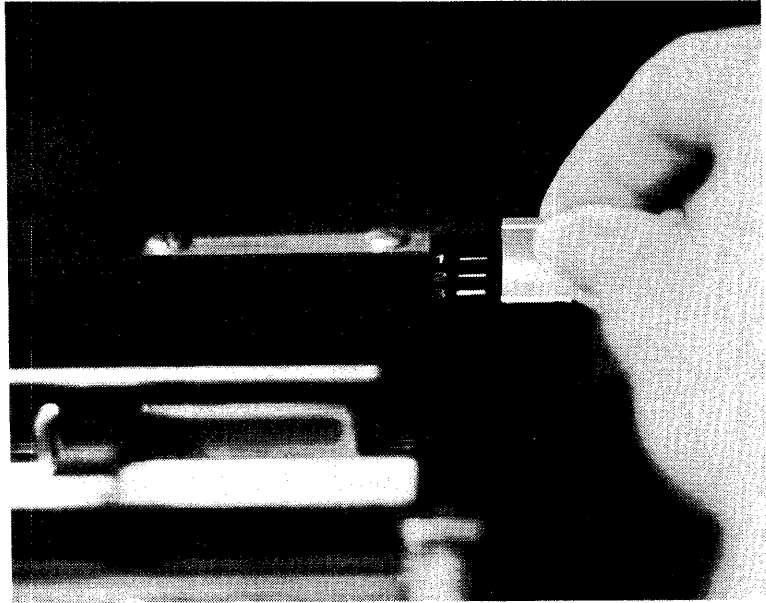

ART: 55055

- 10 Activate pressure rollers to check if forms are pulled back evenly. The rollers should not turn when they are set against paper. If a roller continues to turn, move it right or left until it drops against paper.

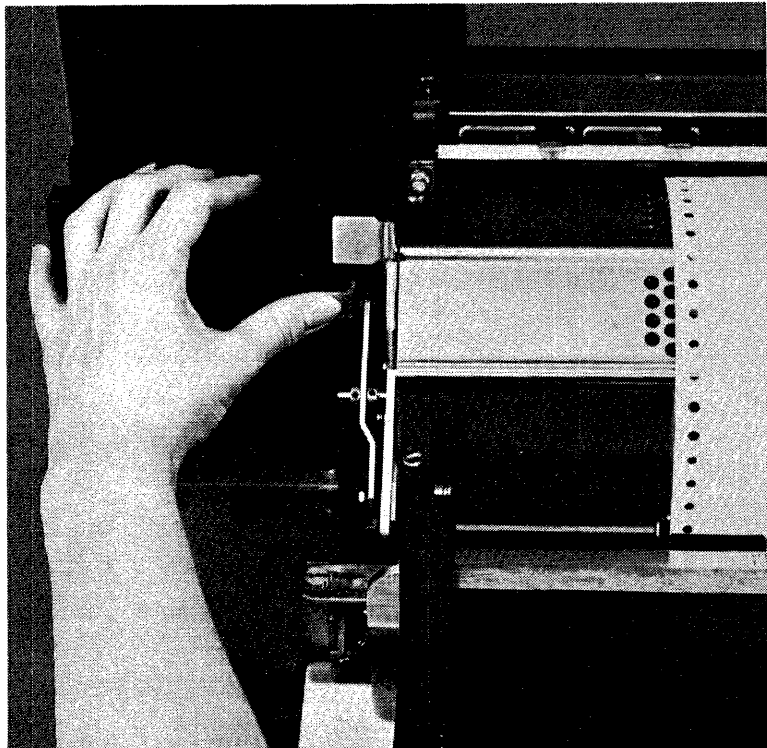

ART: 55056



- 11 Disengage carriage clutch of carriage you are using. (Set the space select lever to the center position.)

Left carriage clutch

Right carriage clutch  
(dual feed carriage only)

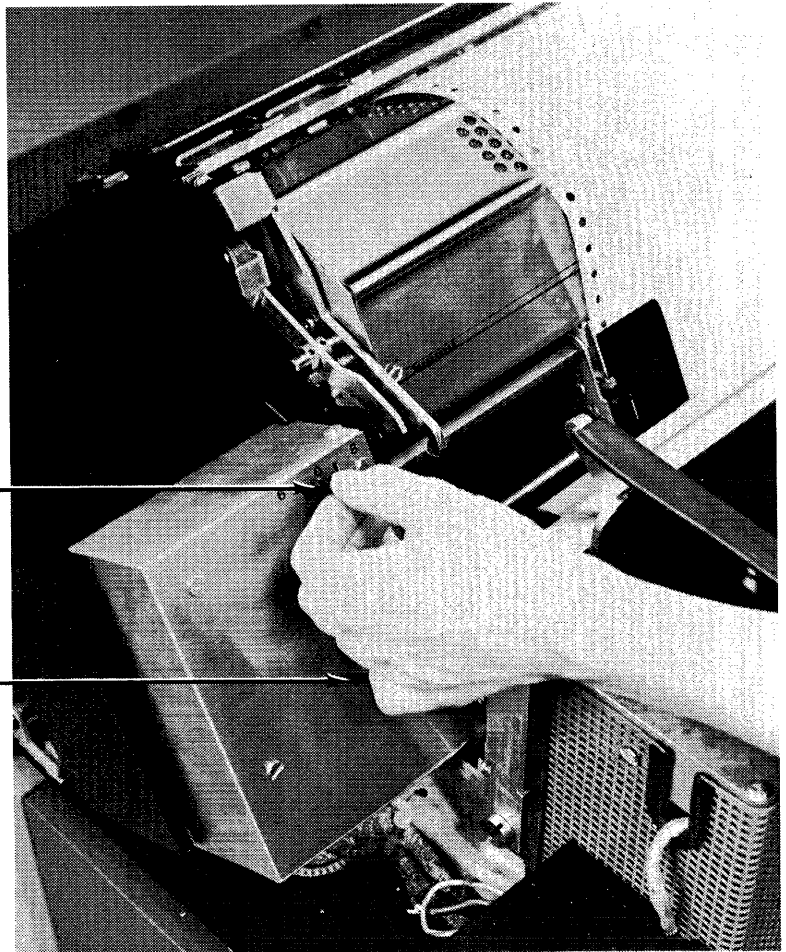

ART: 55057

- 12 Advance forms using vertical adjustment knob ( $\frac{1}{4}$ ) until crease between forms is aligned with upper scribe line on forms guide.

This procedure aligns forms for printing first line.

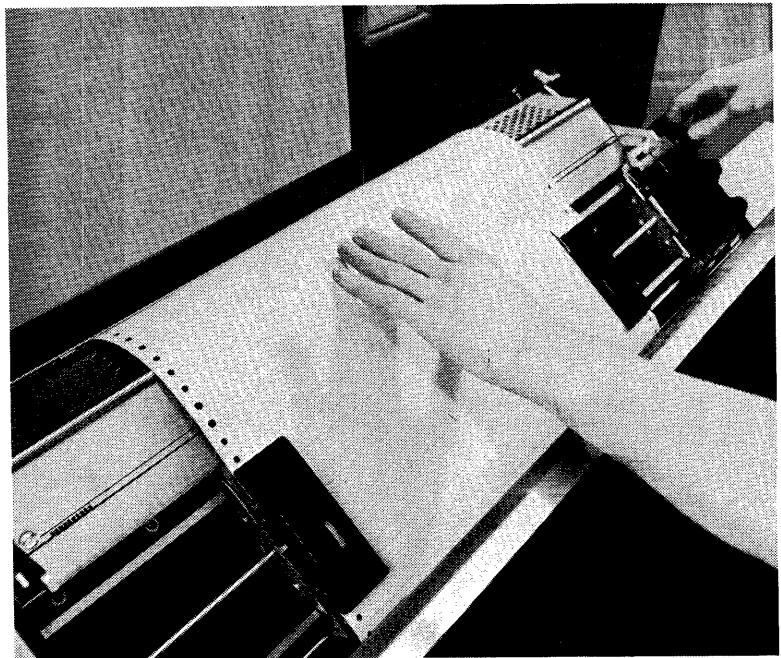

ART: 55058

- 13 Press appropriate carriage restore key.
- 14 Engage carriage clutch. (Set space select lever to 6 or 8 lines per inch.)
- 15 Tip ribbon shield back against forms. Use tractor lateral adjustment knob (←) to align forms with print positions. Close ribbon shield.

Note: Printers with dual feed carriage. The tractor lateral adjustment knob moves both sets of tractors at the same time. One form can be adjusted as described above. However, the other form must be laterally adjusted by physically moving the tractors to align the form with the print position.

Do not leave unused tractors against edge of carriage. A tractor can be damaged if it is forced against the edge of the carriage by the lateral adjustment knob.

- 16 Close rear unit.

- 17 If you have the 300-line-per-minute printer, set impression control dial on the printer to proper setting for forms you are using. See recommendation label on ribbon cover. Change setting as required to obtain best print quality.

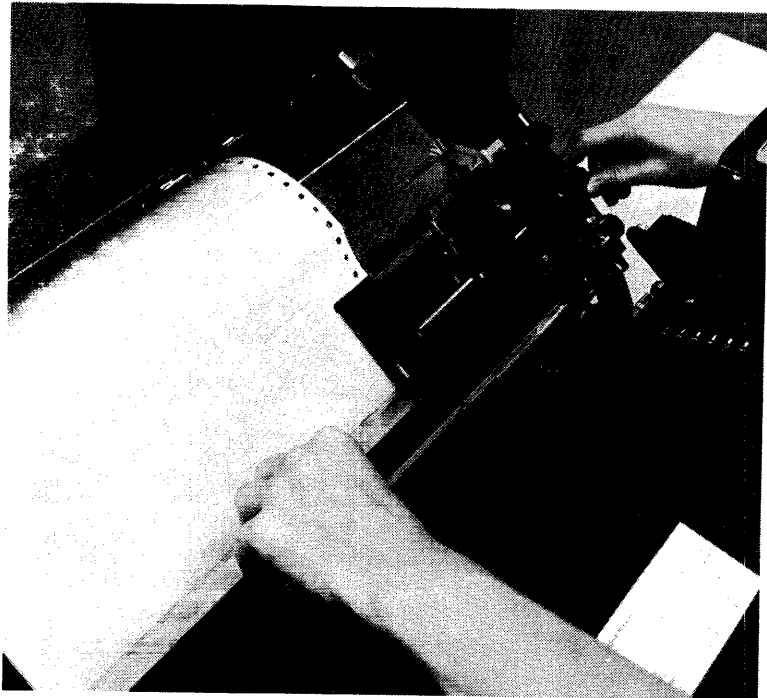

ART: 55059

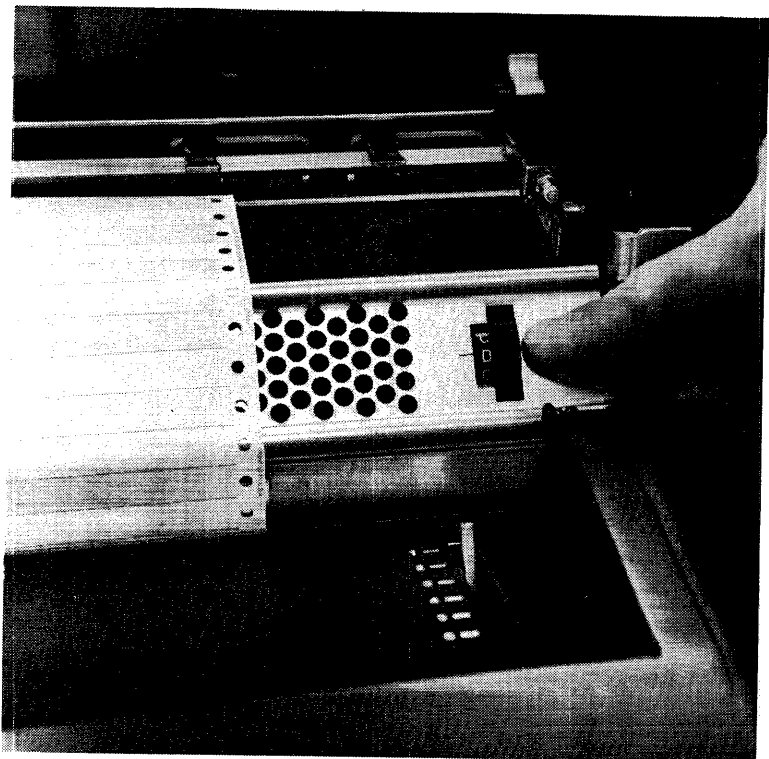

ART: 55095

18

Set forms adjusting lever to proper setting for forms you are using. See recommendation label on ribbon cover. Change setting as required to obtain best print quality.

Note: Printers with dual feed carriage. To obtain best quality printing when using two forms, the forms should be the same thickness.

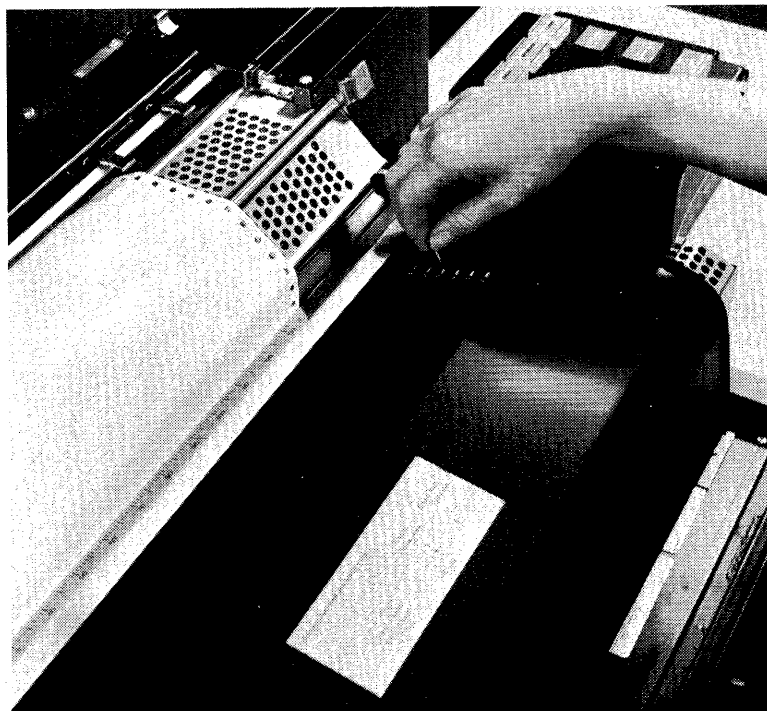

ART: 55060

19

Push forms loading chute back to operating position.



ART: 55081

## CHANGING THE PRINTER RIBBON

### Removal

Wear disposable gloves when handling the ribbon.

- 1 Open printer top cover.

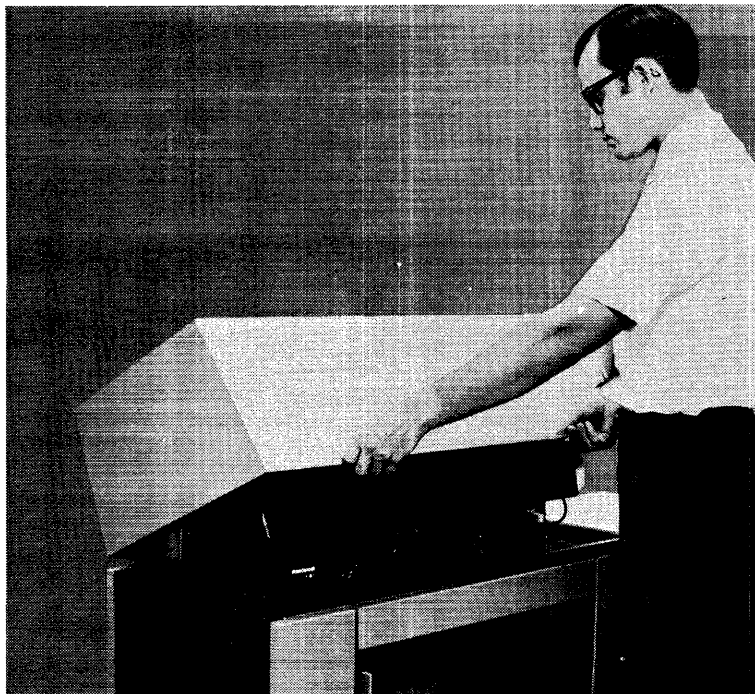

ART: 55064

- 2 Tip rear unit back.

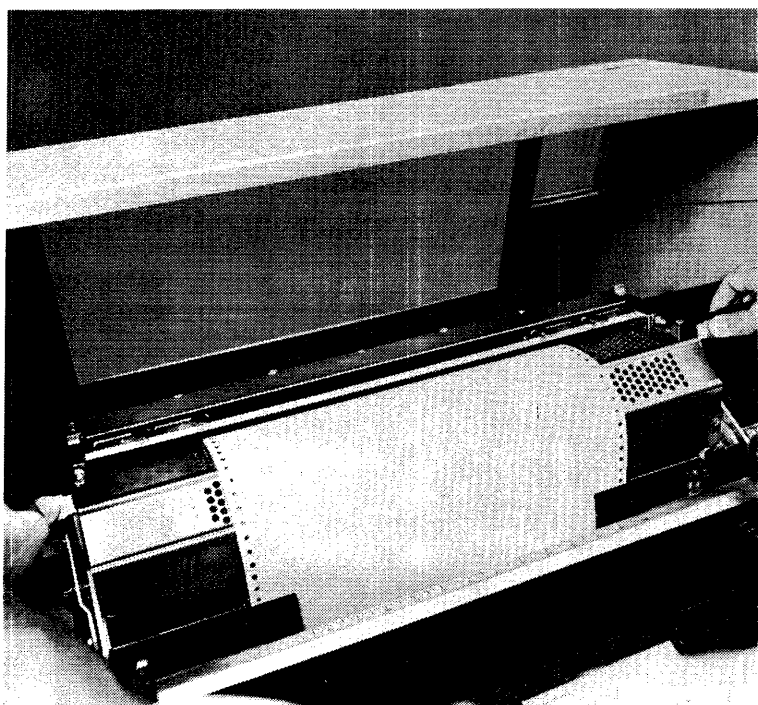

ART: 55065

- 3 Tip ribbon shield back.

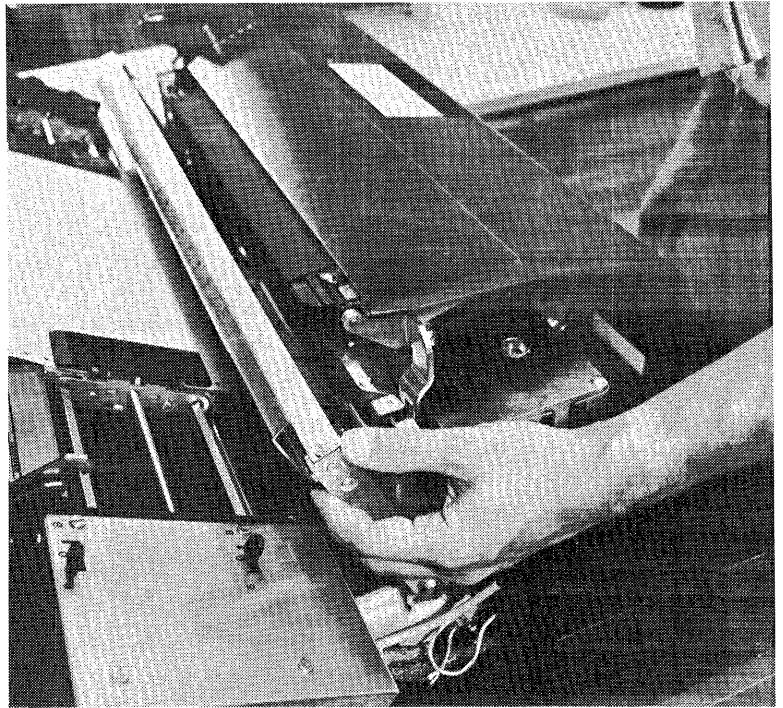

ART: 55066

- 4 Lift ribbon cover and swing it back onto rear unit.

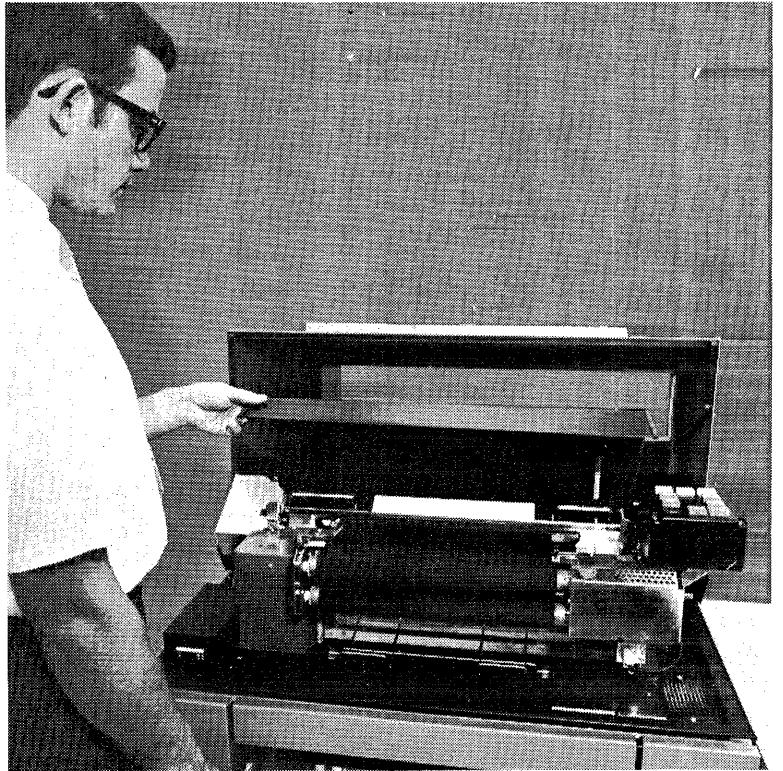

ART: 55067



- 7 Disengage ribbon spool from other ribbon drive. Discard ribbon.



ART: 55069







- 3 Attach ribbon spool to lower ribbon drive. Make sure ribbon is under ribbon guide.

Note: Check that reversing bar is still on ribbon spool circumference, or is at least between ribbon spool body and reversing lever (see illustration in step 2).

Ribbon Guide



ART: 65071

- 4 Ensure that notches in ribbon spools are properly seated on drive keys.
- 5 Close ribbon cover.
- 6 Close ribbon shield.
- 7 Close rear unit.
- 8 Close printer top cover.

Note: It is recommended that excessive ribbon lint be removed from the ribbon shield and from around the cartridge area on a regular basis. Excessive accumulation of ribbon lint may cause smudging or light printing on the forms. Contact your Customer Engineer for cleaning instructions.

*"For 5203 Model 3, with 132 print positions only"* – If a ribbon is being removed for re-use at a later time, spools should be attached in the same positions (i.e., top spools must remain on top). If the spools are reversed, characters printed in the first print position may be illegible.

Spool properly seated

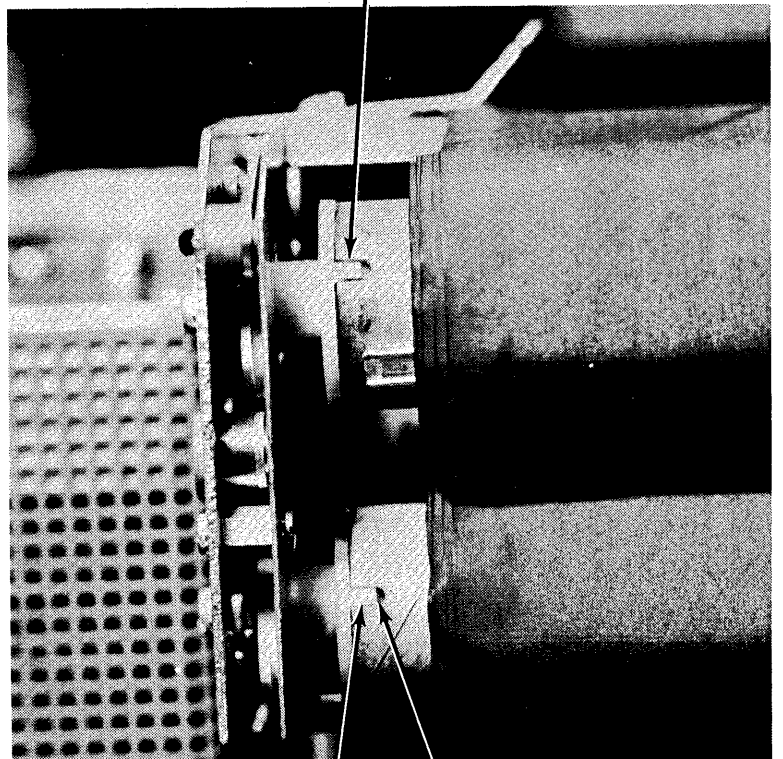

Key

Notch

ART: 65072

## CHANGING THE PRINT CHAIN CARTRIDGE

### Removal

Wear disposable gloves when handling the ribbon or chain cartridge.

- 1 Open printer top cover.

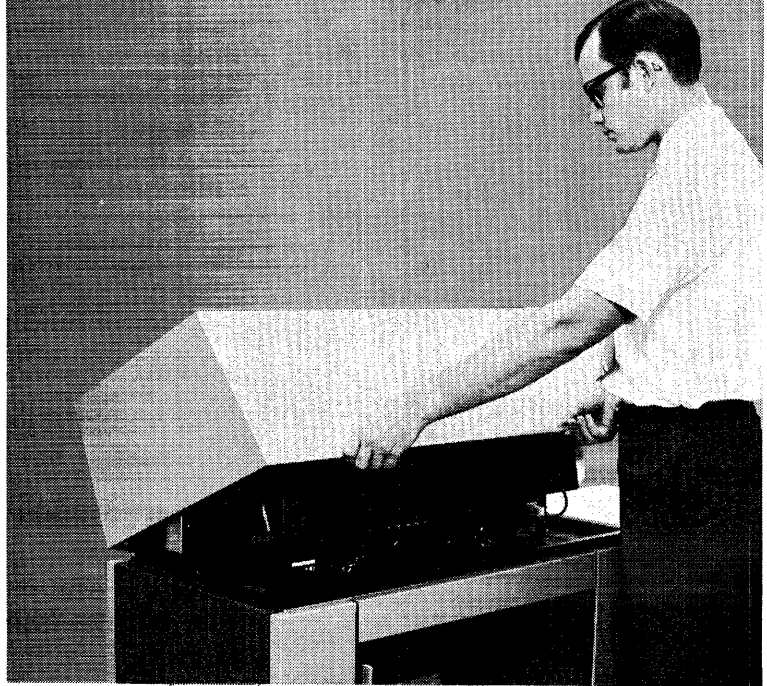

ART: 65064

- 2 Tip rear unit back.

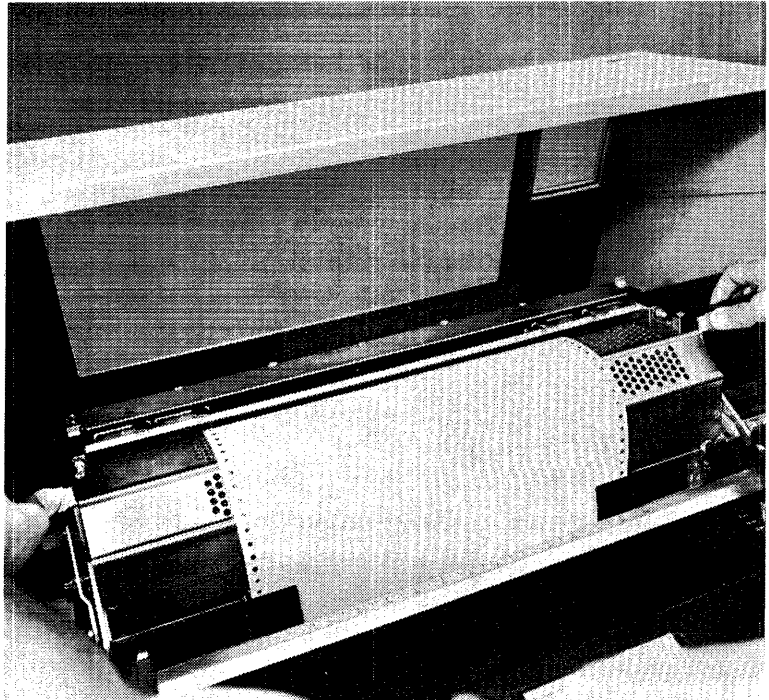

ART: 65065

3 Tip ribbon shield back.

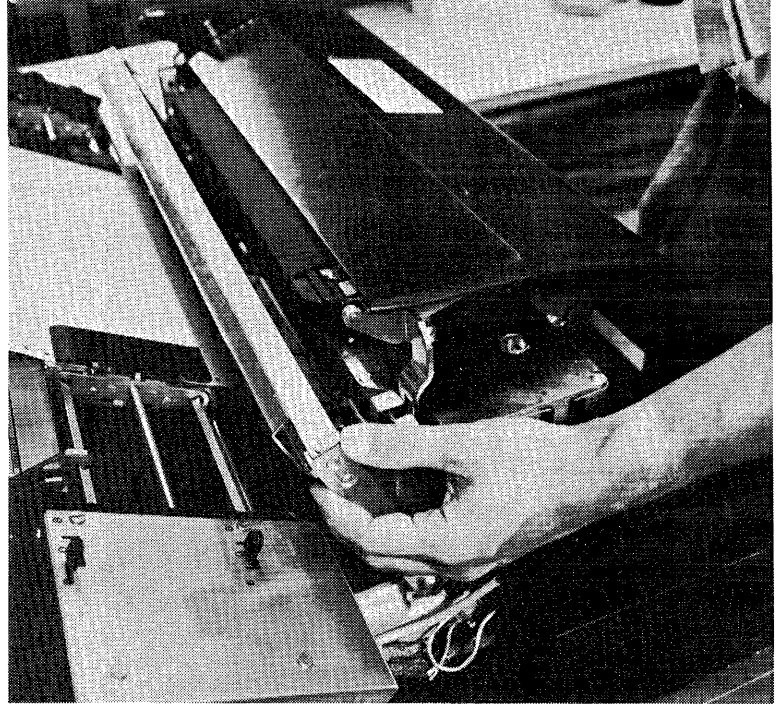

ART: 55066

4 Lift ribbon cover and swing it back onto rear unit.



ART: 55067

- 5 Disengage ribbon spool from upper ribbon drive.

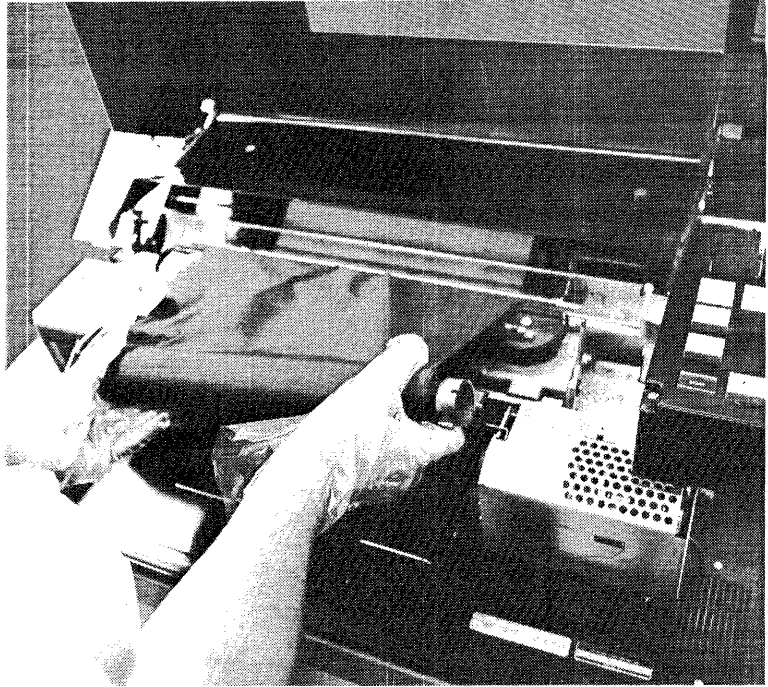

ART: 55068

- 6 Lay ribbon on ribbon cover.

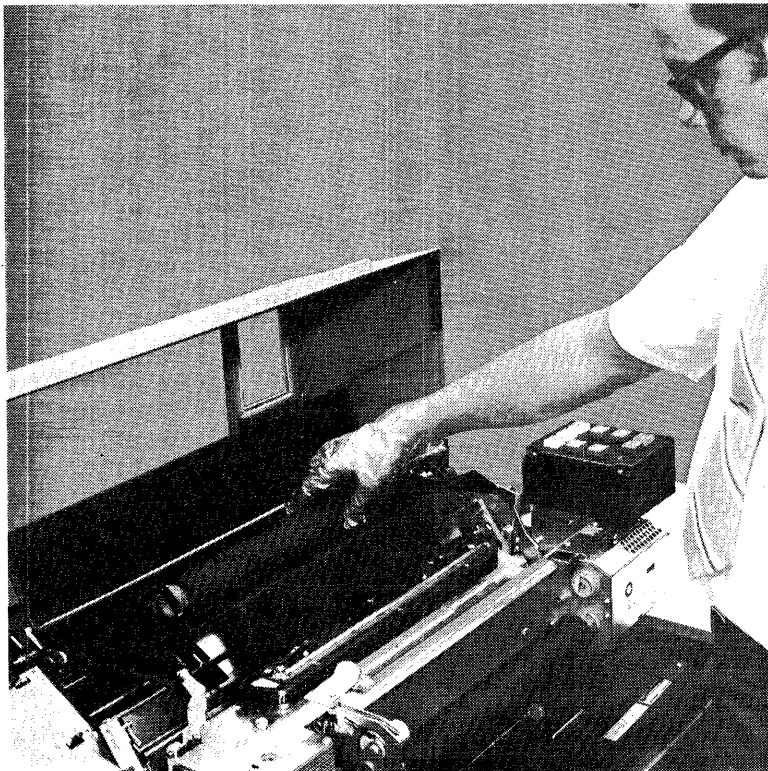

ART: 55073

- ⑦ Raise chain cartridge handles and lift cartridge up and out of machine.

*Note:* Some cartridges \* are secured by thumb screws rather than locking handles. Loosen the thumb screws until they are disengaged from the guide pins and lift the cartridge using the rings on the thumb screws.

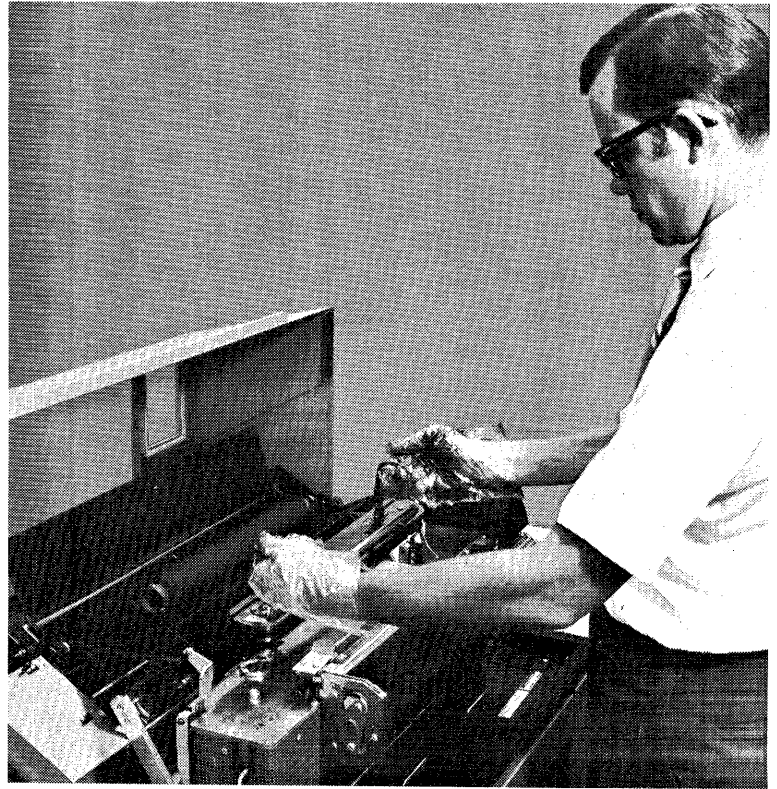

ART: 55089

---

\* These cartridges will be used only on printers delivered in the United States that do not have the Universal Character Set feature.



## Installation of 48-Character LC Print Arrangement Chain

- 1 Lower new cartridge onto guide pins.  
*Caution:* Do not close cartridge handles. If the cartridge has thumb screws rather than locking handles, do not tighten the thumb screws.

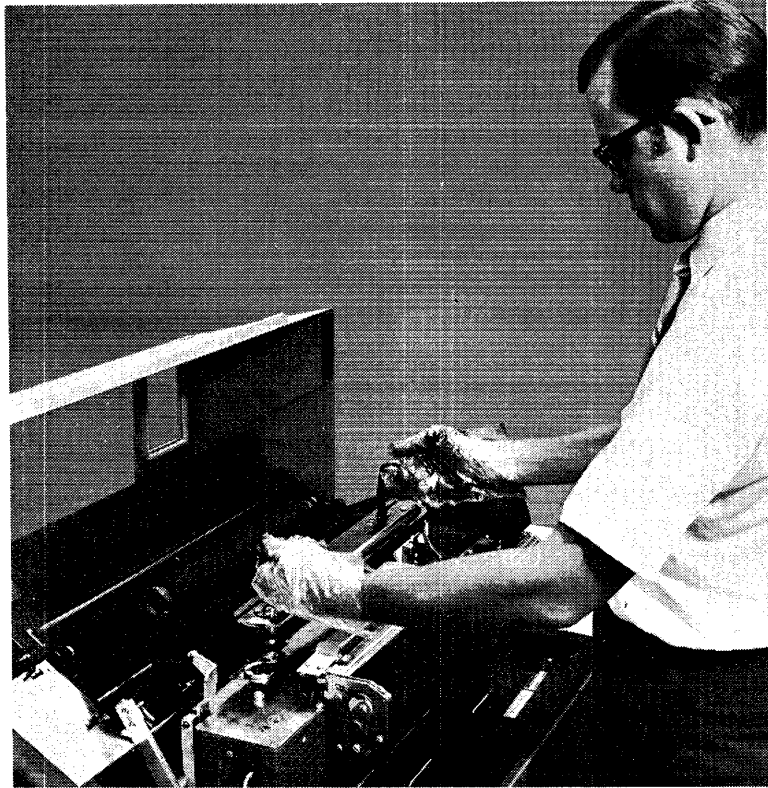

ART: 55089

- 2 Hold print chain and turn chain drive motor until left end of cartridge seats on casting. There is an audible click when the cartridge drops into place.

Access to turn the motor is through the cut-a-way portion of the casting between the ribbon shield and the chain drive motor.

- 3 Close cartridge handles. They lay down flat against cartridge.

If the cartridge has thumb screws, thread the thumb screws into the guide pins until the screws are thumb tight.

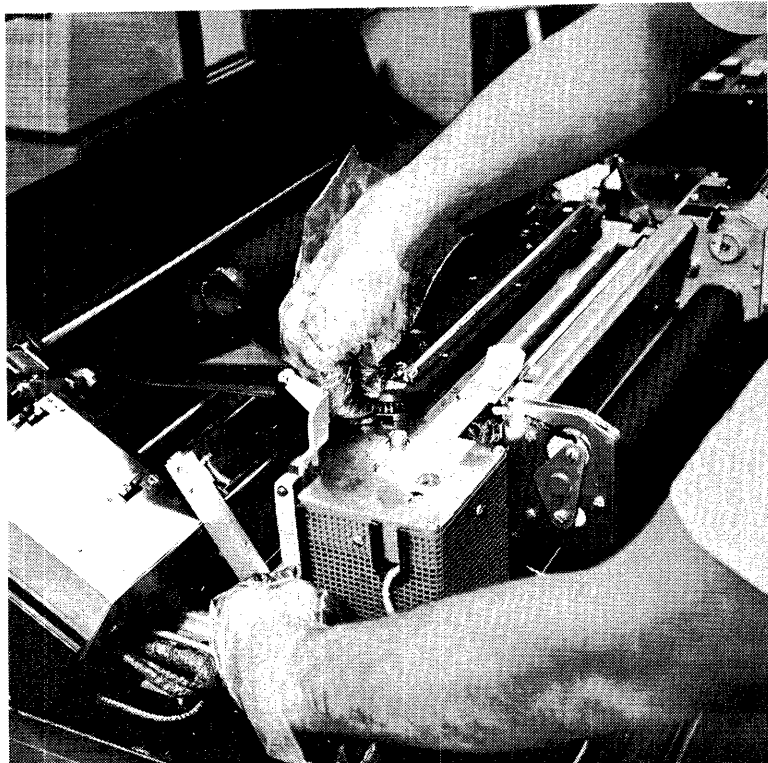

ART: 55090

- 4 Attach ribbon spool to upper ribbon drive. Make sure ribbon is under ribbon guide.

Ribbon Guide

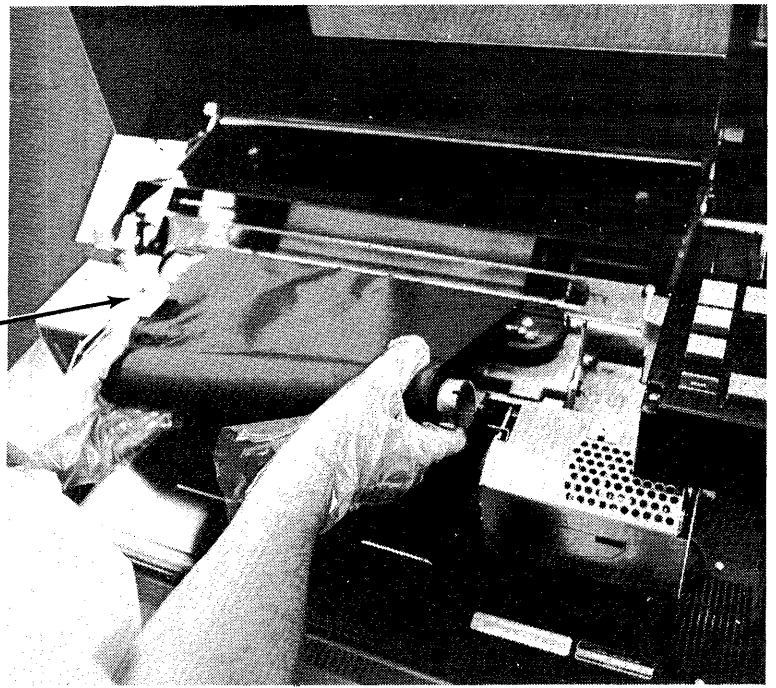

ART: 55068

- 5 Close ribbon cover.
- 6 Close ribbon shield.
- 7 Close rear unit.
- 8 Close printer top cover.
- 9 After you have changed the printer chain, a // IMAGE statement must be supplied to the system before any more jobs are run. Be sure the // IMAGE statement is in front of the OCL for the first job to be run after changing the chain. For more information on the IMAGE statement, see Appendix A.

### Installation of UCS Cartridge

- 1 Turn drive motor counterclockwise until mark in view window (A) and slot in drive shaft (B) line up as shown. The mark in the view window can appear up to five times before the proper relationship between A and B is achieved.

Access to turn the motor is through the cutaway portion of the casting between the ribbon shield and the drive motor (or a special tool may be attached to the printer to turn the cartridge drive).

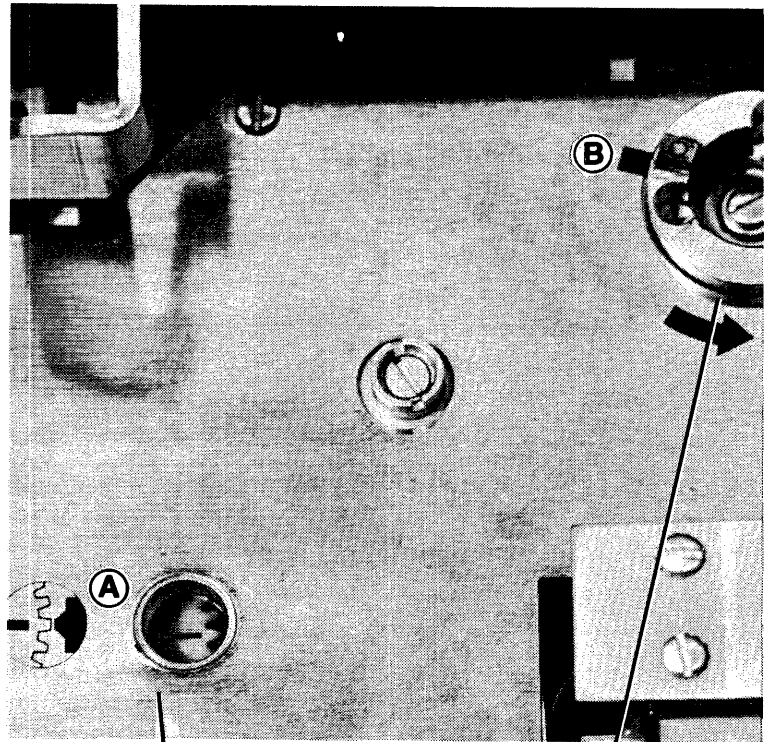

ART: 55091

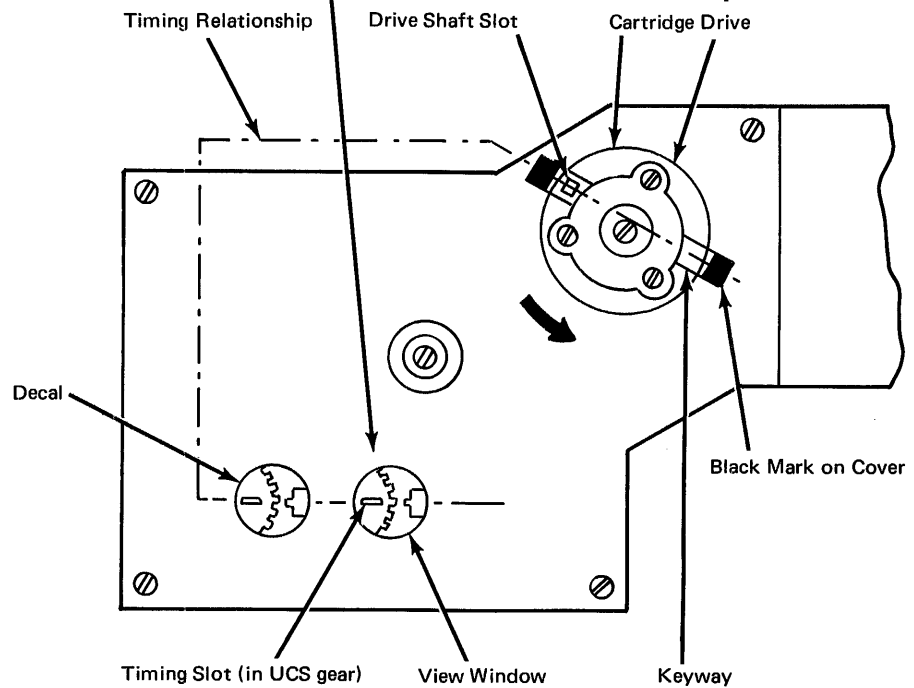



2

Swing the cartridge up and out (away from you) and turn it upside down.

*Chain Cartridges for 100 and 200 Line-Per-Minute Printers:* Turn the chain until the key character, the key slot, and the arrow on the decal are aligned as shown in the diagram. (A special tool may be attached to the printer to turn the chain.) Check the characters on the chain to either side of the arrow on the decal. If the chain is properly aligned, the characters on the decal will match the characters on the chain. If the characters do not match, turn the chain until the key character, the key slot, and the arrow on the decal are aligned as shown. Check the chain and decal characters again. You may have to turn the chain up to four times before the proper match is found.

*Train Cartridges for 300 Line-Per-Minute Printers:* Turn the train until the copper colored slug with the characters + .) is opposite the arrow on the cartridge base. (A special tool may be attached to the printer to turn the train.) Other slugs might have the characters + .) but only one slug is copper colored. Align the character ) on this slug with the arrow.

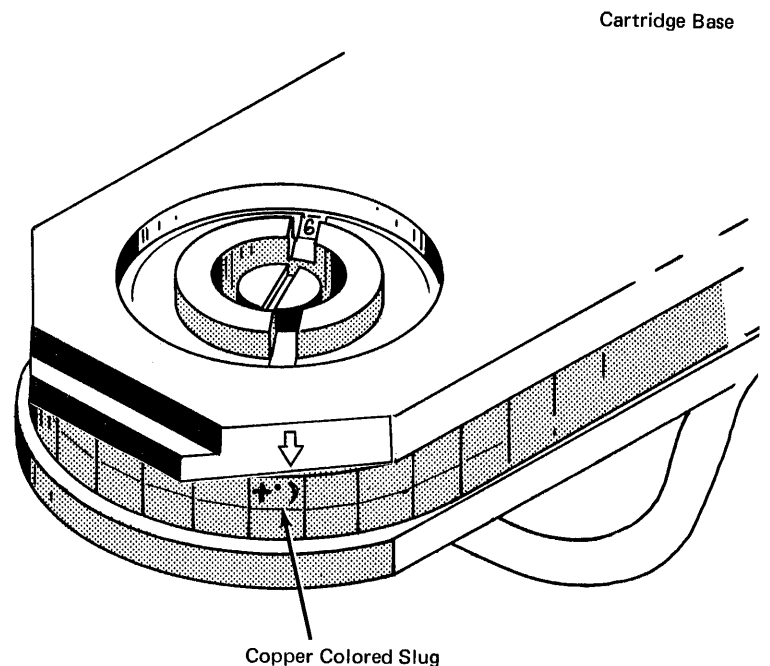
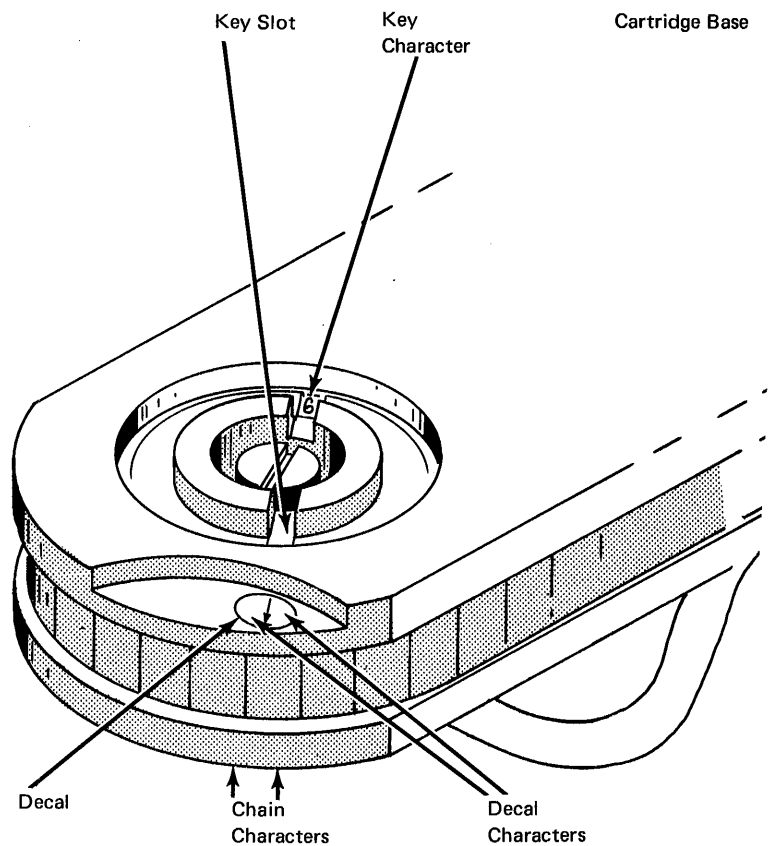

3

Lower cartridge onto guide pins, hold print chain, and rock motor until cartridge seats on casting.

*Caution:* Do not close cartridge handles before cartridge is seated.

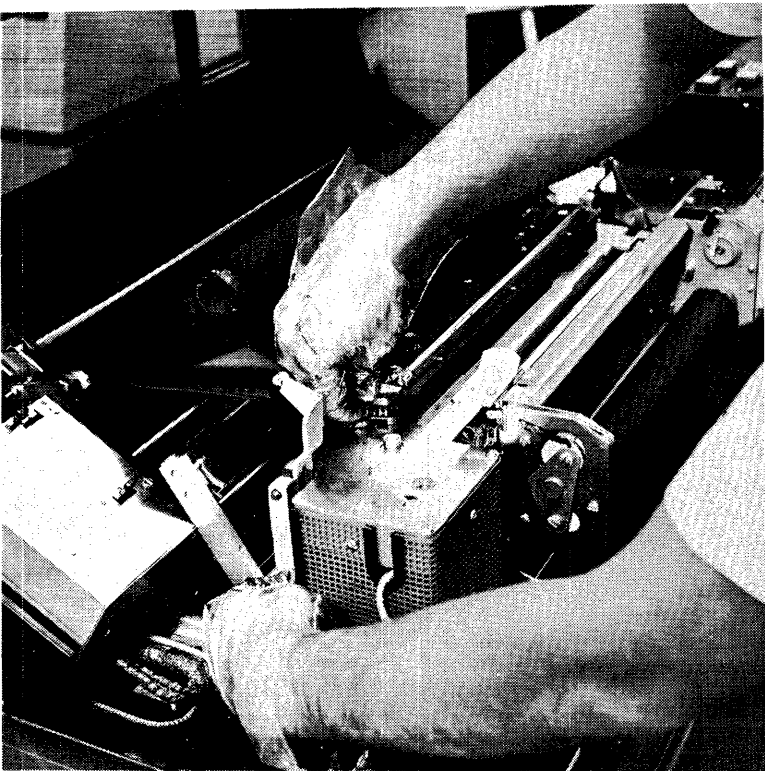

ART: 55090

4

Attach ribbon spool to upper ribbon drive. Make sure ribbon is under ribbon guide.

Ribbon Guide

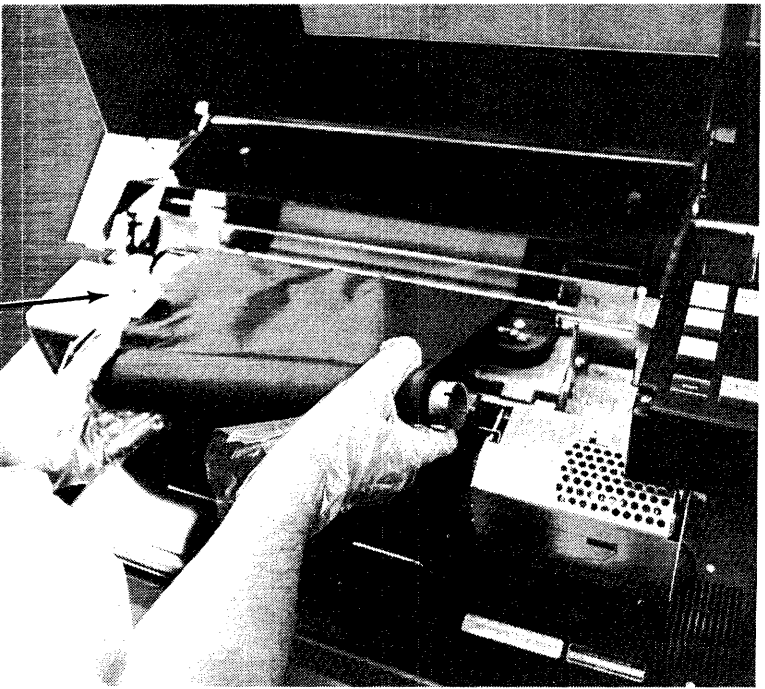

ART: 55068

- 5 Close ribbon cover.
- 6 Close ribbon shield.
- 7 Close rear unit.
- 8 Close printer top cover.
- 9 After you have changed the printer chain, a // IMAGE statement must be supplied to the system before any more jobs are run. Be sure the // IMAGE statement is in front of the OCL for the first job to be run after changing the chain. For more information on the IMAGE statement, see Appendix A.



## Chapter 5. IBM 5440 Disk Cartridge and IBM 5444 Disk Storage Drive

- Description of the Disk Cartridge
- Description of the Disk Storage Drawer
- Mounting a Disk Cartridge
- Removing a Disk Cartridge

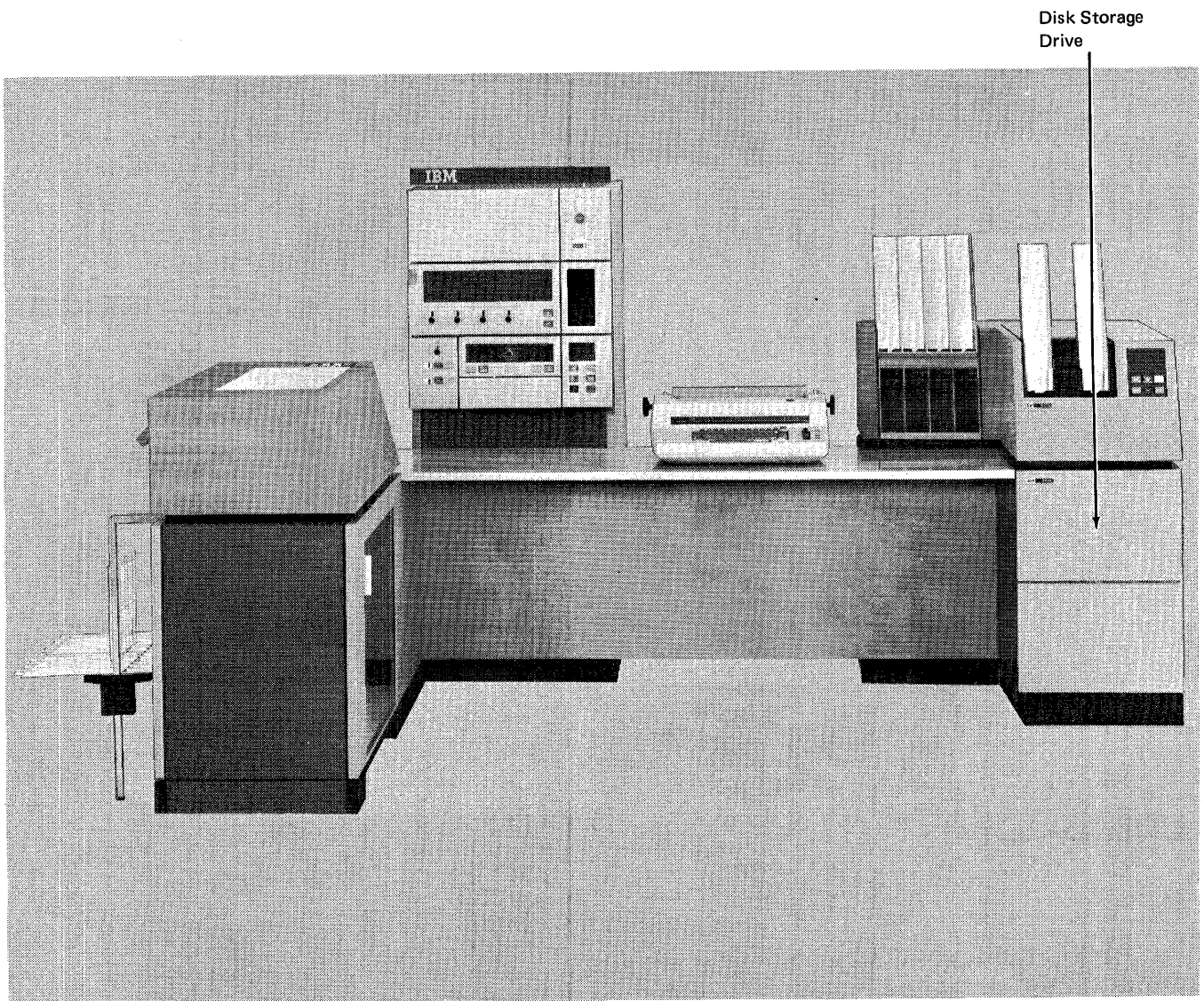

55239A

## DISK CARTRIDGE

The disk cartridge (Figure 12) contains a magnetic-coated disk. The system places data on or reads data from this disk. The cartridge consists of a carrying handle, a release button, and the bottom cover. You place the cartridge on the disk drive in the disk storage drawer. The program run sheet, provided by the programmer, tells you which cartridge to mount. It is a recommended practice to identify the kind of data or programs on each cartridge so you can readily identify the cartridge needed for a job.

Note: The disk cartridge should be in the environment in which it is to be used for at least three hours. This ensures that the disk cartridge can be used properly by System/3.

### Carrying Handle

The carrying handle on the cartridge raises into an upright position, allowing you to easily carry and handle the cartridge.

### Release Button

You push this button to release the bottom cover of the cartridge so you can mount the cartridge on the disk drive. This button also releases the cartridge from the disk drive when you want to remove a cartridge. Remove the bottom cover, push the release button, then raise the carrying handle to remove a cartridge.

### Bottom Cover

The bottom cover keeps dust from getting into the cartridge when it is stored. You remove it before mounting the cartridge on the disk drive. After you have mounted the cartridge, invert the bottom cover and place it on top of the cartridge.

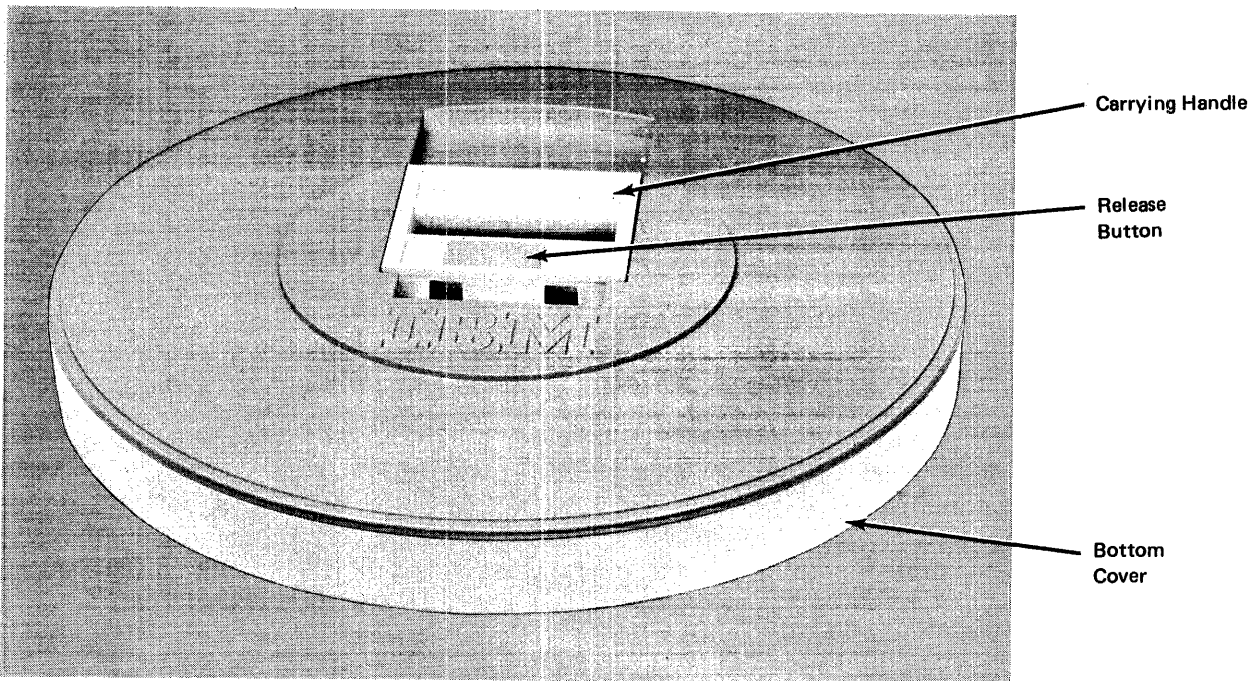

Figure 12. Disk Cartridge.

55229

## DISK STORAGE DRAWER

The disk storage drawer (Figure 13) slides to facilitate mounting and removing the disk cartridge. A cartridge should always be on the disk drive when the system is not in use. This keeps dust from entering the drive.

### Clamp Arms

The clamp arms hold the cartridge in place once it has been mounted on the disk drive. They must be pulled out-

ward to remove or mount a cartridge. Once the cartridge is mounted, the arms are pushed back into place to hold the cartridge down.

### Drawer Stop

The drawer stops are extended outward when the clamp arms are extended outward. This prevents the disk storage drawer from being closed when the clamp arms are extended.

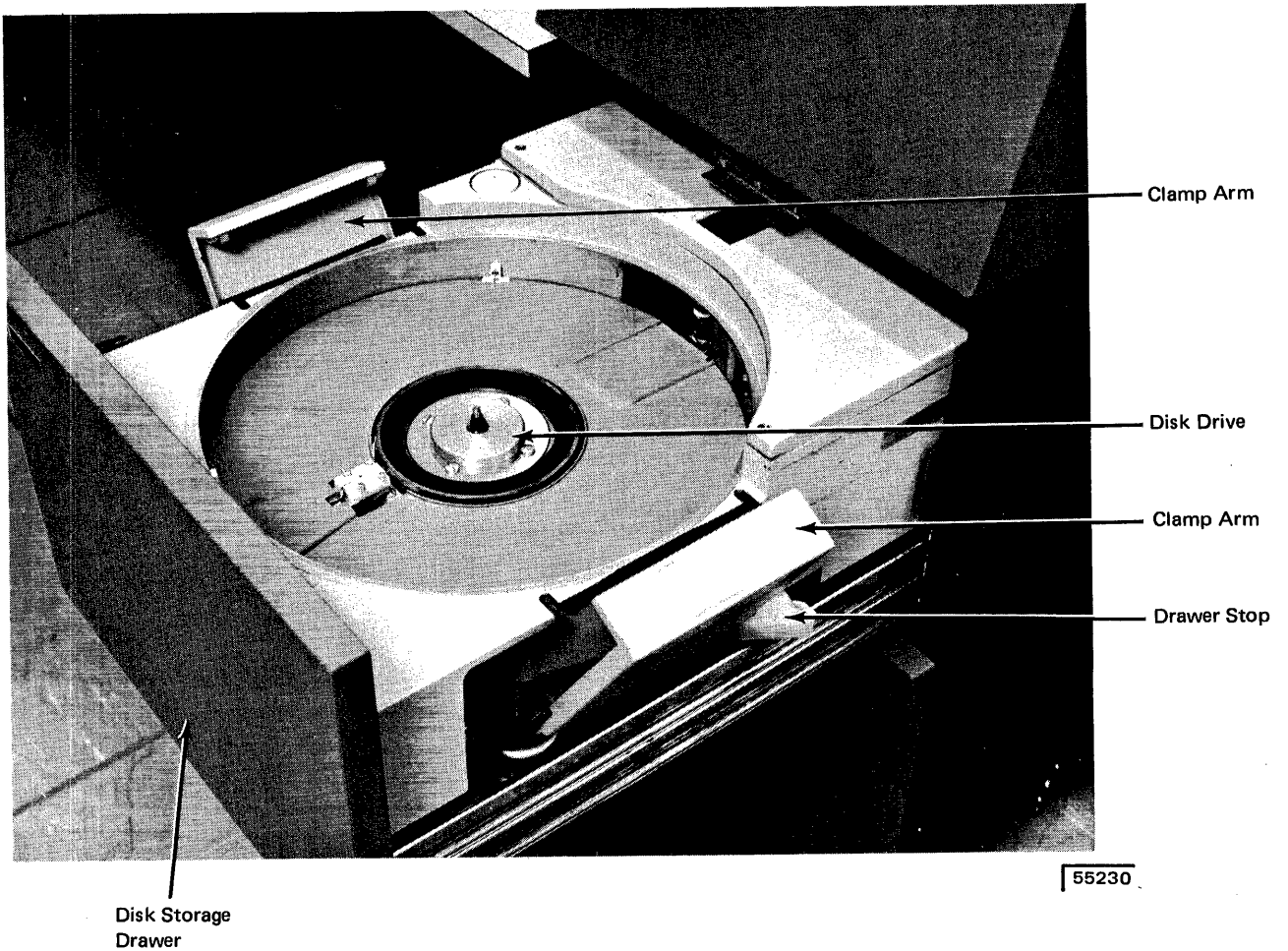

Figure 13. Disk Storage Drawer.

## Disk Drive

The disk drive is where you mount the cartridge. It also drives the disk within the cartridge. Once you have mounted the cartridge on the disk drive and placed the bottom cover over the cartridge, bring the clamp arms over the cartridge to hold it in place.

Figure 14 shows the position of the disks in the disk storage drawer. The basic disk system has a removable disk (R1) and a fixed disk (F1) in the top drawer. In addition to the disks in the top drawer, your system may also have disks (R2, F2) in the bottom storage drawer. The removable disks (R1 and R2) can be replaced. They are enclosed within cartridges. The fixed disks (F1 and F2) cannot be removed.

The disk 1 START/STOP switch, READY light, and OPEN light on the disk panel control and indicate the status of R1

and F1. The disk 2 START/STOP switch, READY light, and OPEN light on the disk panel control and indicate the status of R2 and F2.

It is not a recommended practice to shut off system power when the start/stop switch on the disk panel is at START. The data on the disk could be destroyed if this is done.

## MOUNTING A CARTRIDGE

The following procedures are for mounting a cartridge. If a cartridge is on the disk drive, remove it before placing a new cartridge on the disk drive. Follow the procedures later in this chapter for removing a cartridge.

The cartridge to be used by the system should be in the environment in which it is to be used for at least three hours. This ensures the disk cartridge can be used properly by System/3.

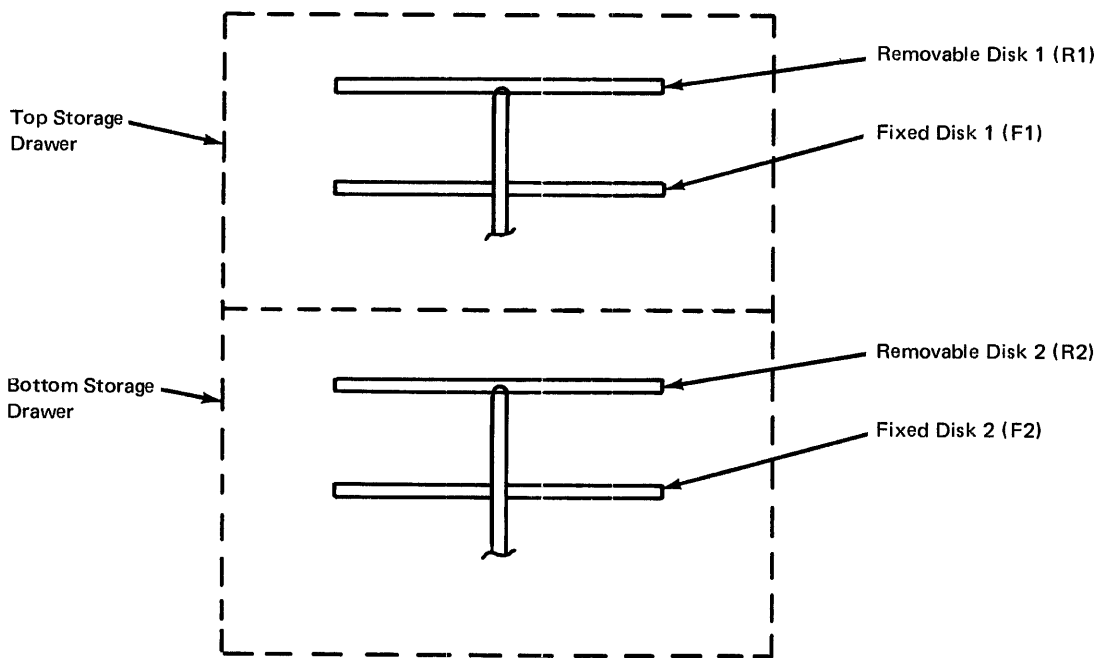

Figure 14. Position of Removable and Fixed Disks.



① Check for the following conditions before mounting a cartridge:

- Disk panel start/stop switch for the drive you are loading (R1 or R2) in the STOP position.
- Disk panel OPEN light lit.
- Disk storage drawer slid out.
- Clamp arms extended out.

② Select the cartridge to be mounted as indicated on the program run sheet.

③ Slide the release button to the left.

④ With one hand under the bottom cover of the cartridge to catch the cover, raise the carrying handle to the upright position.

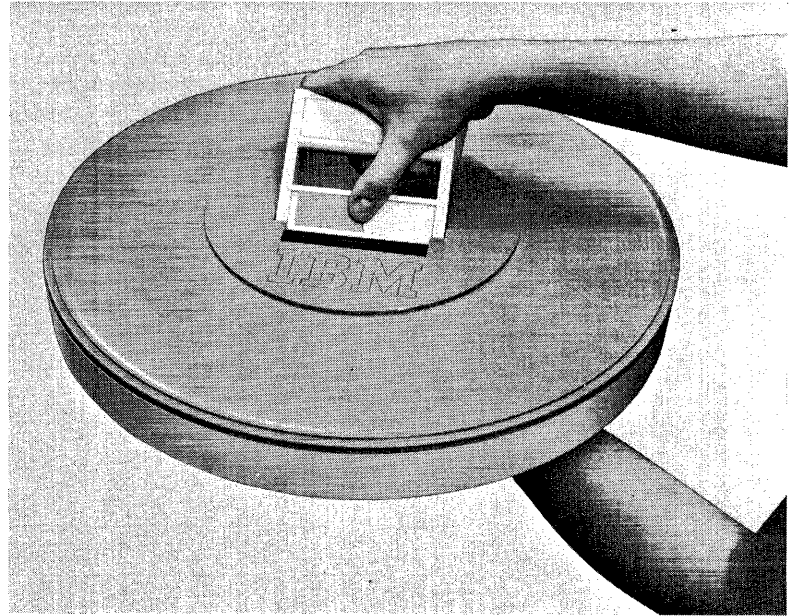

55231

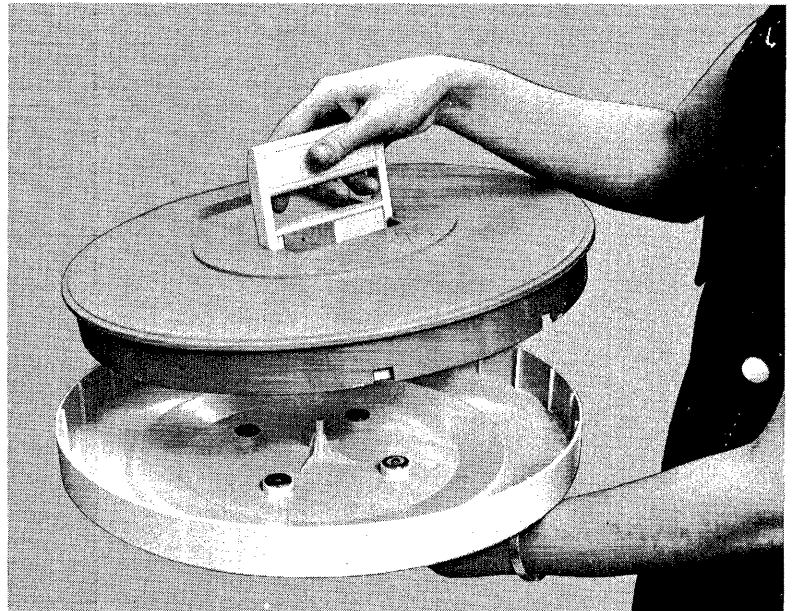

55232

5 With the IBM label pointed toward the front of the disk storage drawer, mount the cartridge by lowering it on the disk drive.

6 Release the carrying handle. It should be flush with the cartridge.



55233

7 Invert the bottom cover and place it on top of the cartridge.



55234

8 Bring in the clamp arms over the cartridge.

9 Slide the disk storage drawer all the way in. The cartridge is now mounted and can be made ready for use by performing the following step.



55235

10 Set the disk panel start/stop switch, for the drive you are using, at **START**. The **OPEN** light turns off. The **READY** light is lit when the disk is up to speed. There is approximately a two-minute delay from the time you set the start/stop switch at **START** until the **READY** light is lit. When the **READY** light is lit, the system can use the disks on the drive.

## REMOVING A CARTRIDGE

- 1 Set disk panel start/stop switch at STOP for the cartridge to be dismantled (R1 or R2).

*Note:* The disk storage drawer cannot be opened until the OPEN light for the selected disk (1 or 2) is lit.

- 2 When disk panel OPEN light is lit (READY light is off), squeeze drawer release lever and slide disk storage drawer out until it stops.

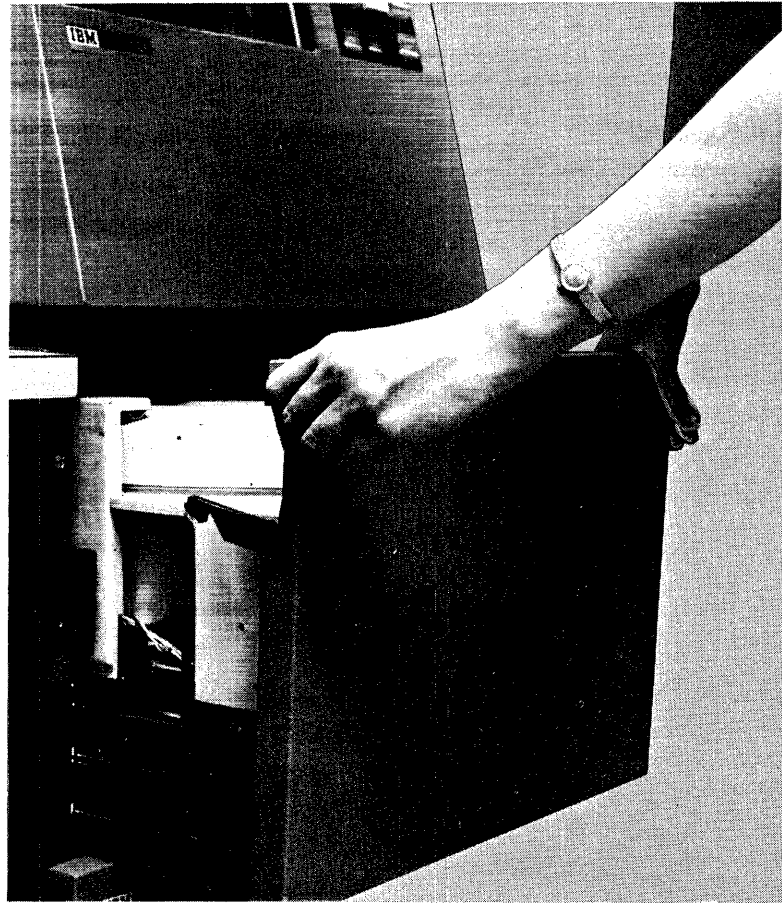

55236

3

Pull both clamp arms outward.



55237

- 4 Lift bottom cover off of cartridge.



55234

- 5 Push release button to left and raise carrying handle to release cartridge from disk drive.

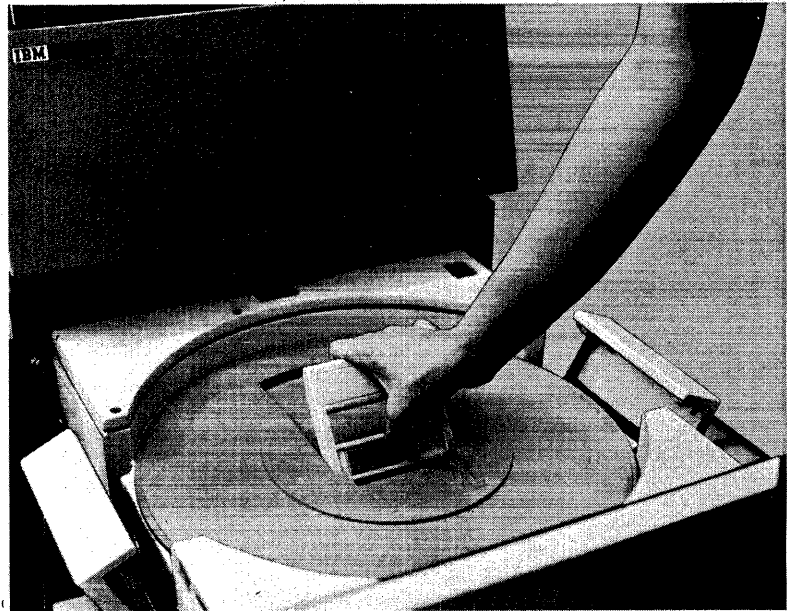

55238

- 6 Lift cartridge from disk drive.



55233

- 7 Invert bottom cover of cartridge and place it back on cartridge. Lower carrying handle until it is flush with cartridge. This locks bottom cover on cartridge.

- 8 Store cartridge.

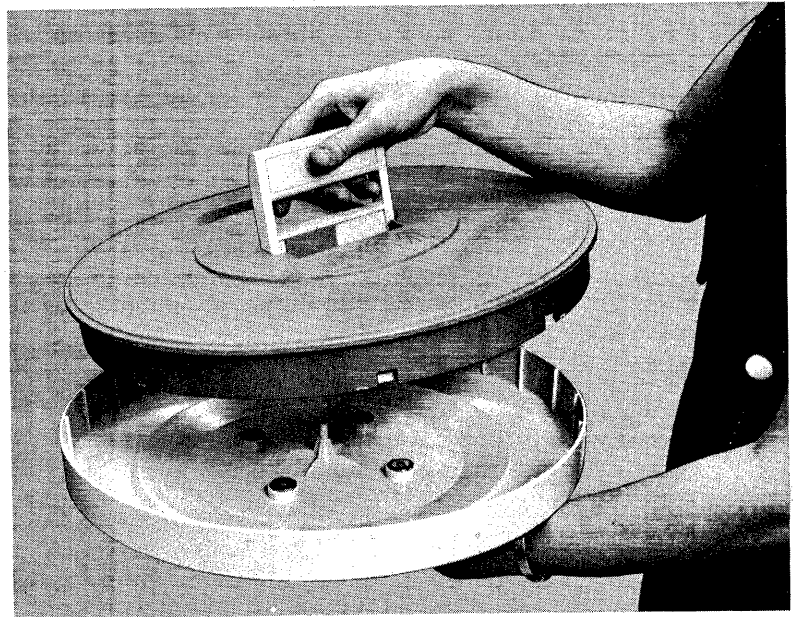

55232





- Use of the Printer-Keyboard
- Removing the Typeball
- Replacing the Typeball
- Adjusting the Impression Selector
- Removing the Fabric Ribbon Cartridge
- Installing a Fabric Ribbon Cartridge
- Placing Forms in the Printer-Keyboard

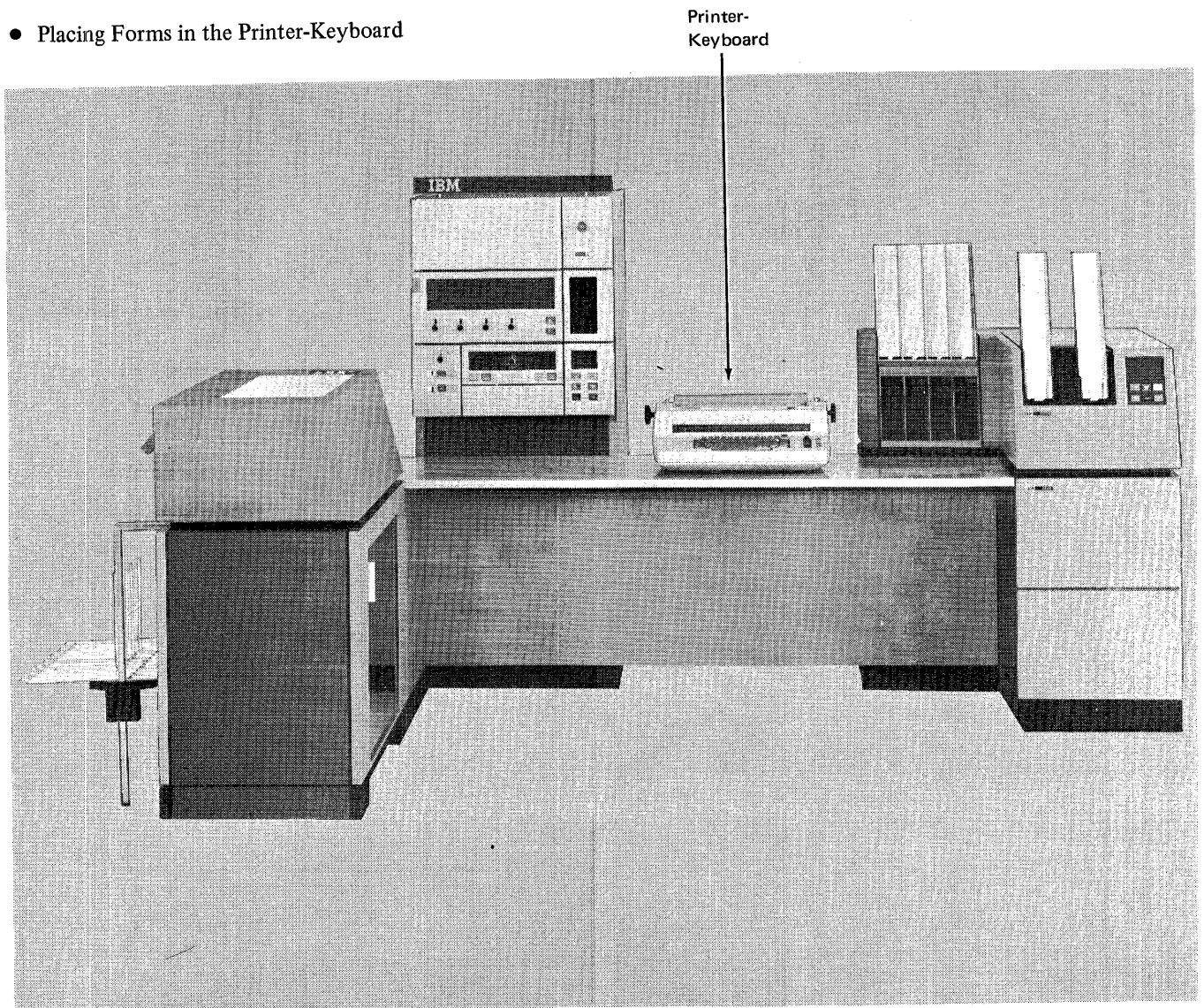

55239A

## USE OF THE PRINTER-KEYBOARD

The printer-keyboard (Figure 15) is an optional device for System/3 and consists of the printer and keyboard connected to the system processing unit. With the printer-keyboard, you can:

1. Request information from a disk file.
2. Print out requested information.
3. Enter data directly into the system.
4. Print out OCL statements and error codes for a program by using the printer-keyboard as a logging device.
5. Interrupt an RPG program (if inquiry has been specified) by pressing the REQ key. You will be told when to do this on the program run sheet.

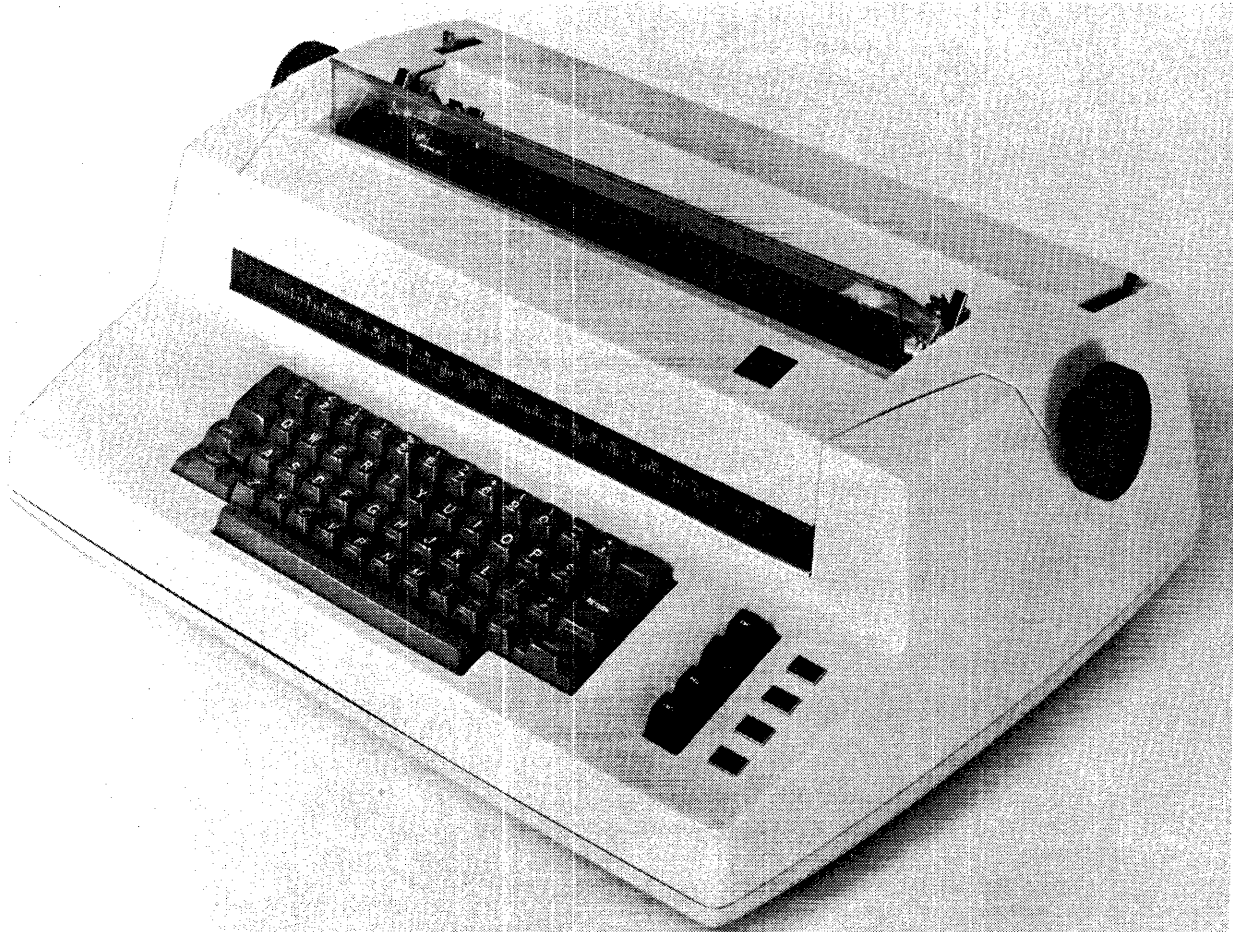

Figure 15. Printer - Keyboard.

53297

**Keys**

Figure 16 shows the keyboard. The shaded keys are function keys; the other keys are data keys.

**LOCK:** This key locks the shift in the uppercase mode.

**SHIFT (one on each side of the keyboard):** This key allows you to key uppercase characters.

**SPACE:** This bar allows you to enter blanks.

**RETURN:** This key causes the carrier to return.

**END:** This key is pressed when you have keyed in the OCL statement or data. It tells the system that you are through with the line (OCL statement or data).

**REQ (Request):** This key allows you to interrupt a program if the program can be interrupted. If the request to interrupt the program is not allowed, the request is ignored.

**CANCEL:** This key is used to cancel the current line you keyed. (Used when you hit a wrong key.)

**Lights**

**REQUEST PENDING:** This light comes on when you press the REQ key. It means that the program you are trying to interrupt will not allow it at this time. The light is off when the request to interrupt the program is allowed.

**PROCEED:** When this light comes on, you can key OCL statements or data.

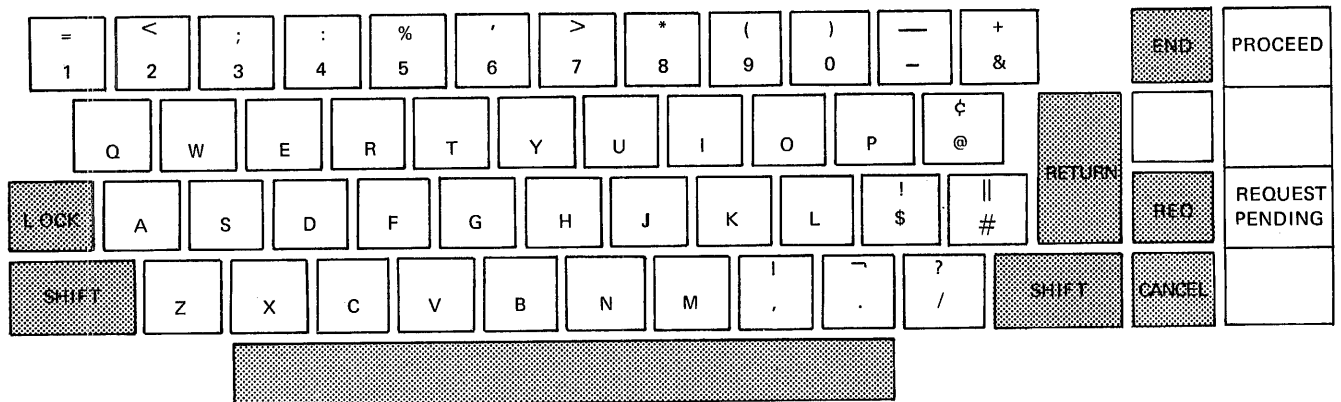

● Figure 16. Keyboard.

## REMOVING THE TYPEBALL

- 1 Lift the typeball release lever until the lever clicks into position.
- 2 Remove the typeball by lifting it off of the typeball post.

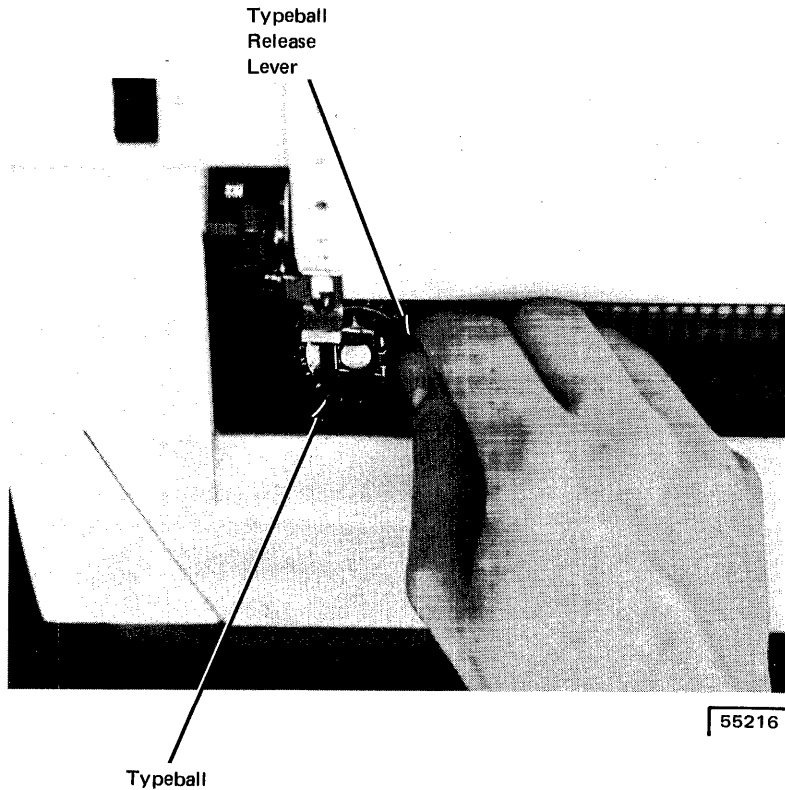

## REPLACING THE TYPEBALL

- 1 Lift the typeball release lever until it clicks into position.
- 2 Place the typeball on the typeball post with the triangle facing directly away from you.
- 3 Close the lever. Avoid using force.

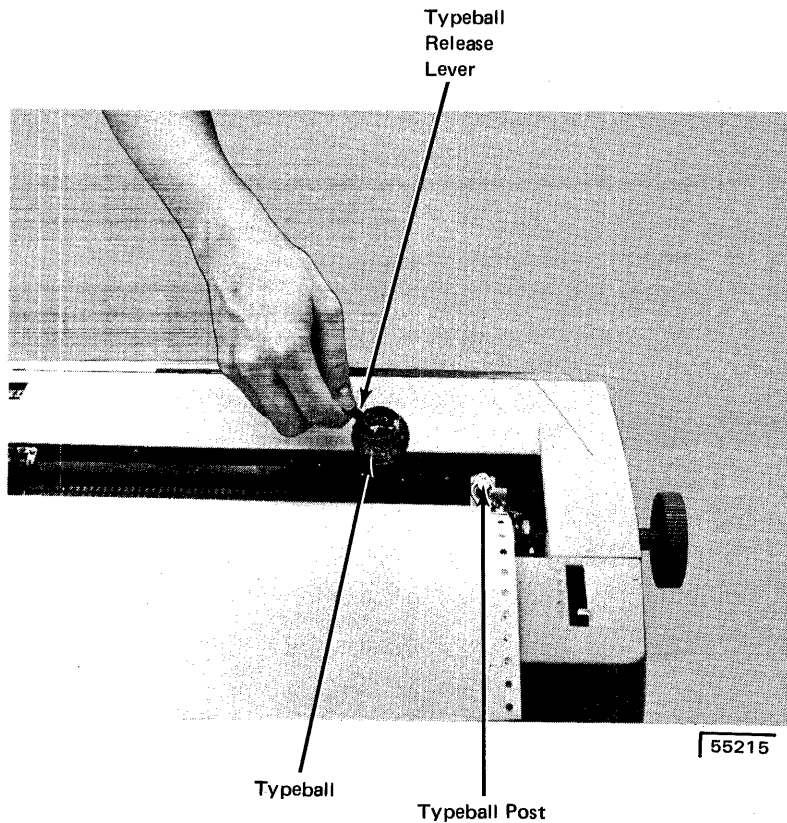

## ADJUSTING THE IMPRESSION SELECTOR

The impression selector on the right side of the typeball enables you to adjust the striking force of the typeball. Numbers on the impression selector range from one to five. Position 1 has the lightest striking force and position 5 has the hardest.

- 1 To change the setting, push the lever to the right and slide it either forward or backward to the desired number.

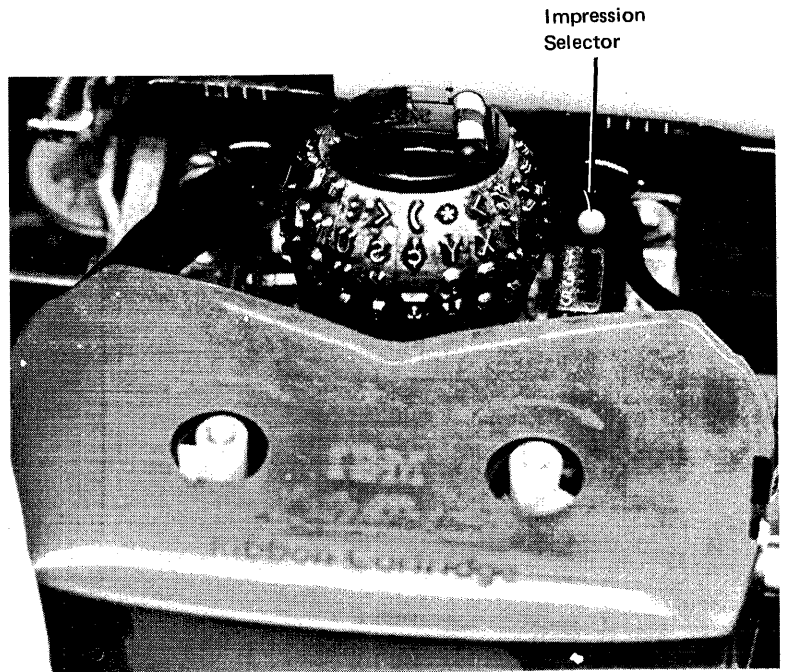

55214

- 2 When the impression selector is adjusted to increase the striking force of the typeball, the multiple copy control must also be moved the same number of positions away from you. When the impression selector is adjusted to decrease the striking force of the typeball, the multiple copy control must also be moved the same number of positions towards you.

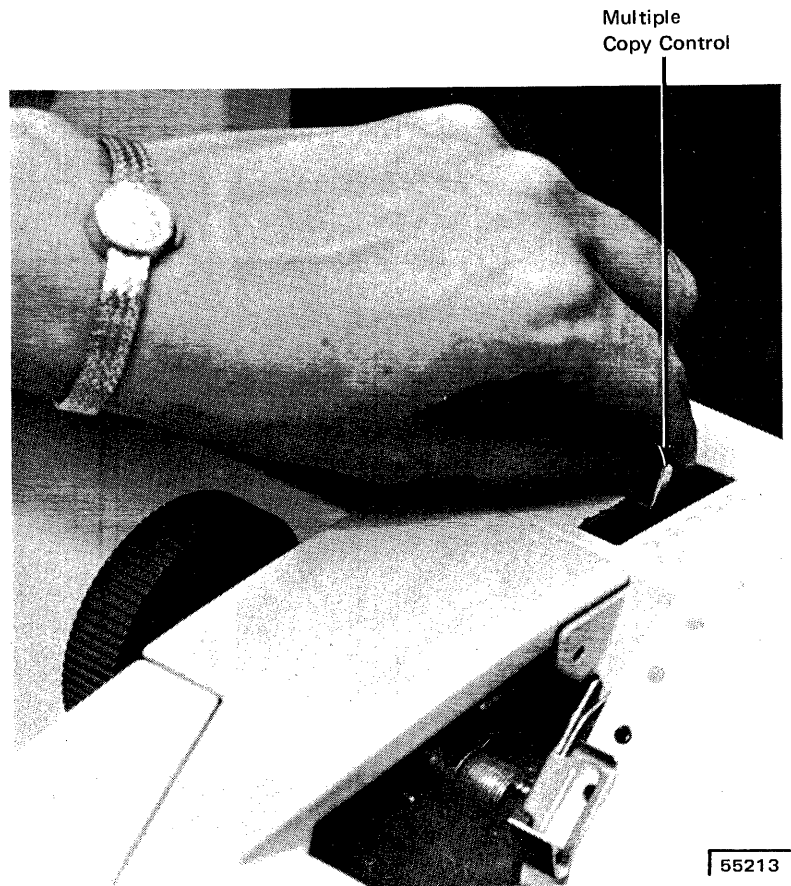

55213

## REMOVING THE FABRIC RIBBON CARTRIDGE

- 1 Lift the front cover.
- 2 Move the ribbon change lever to the right. This will raise the ribbon lifts for easier removal of the ribbon.

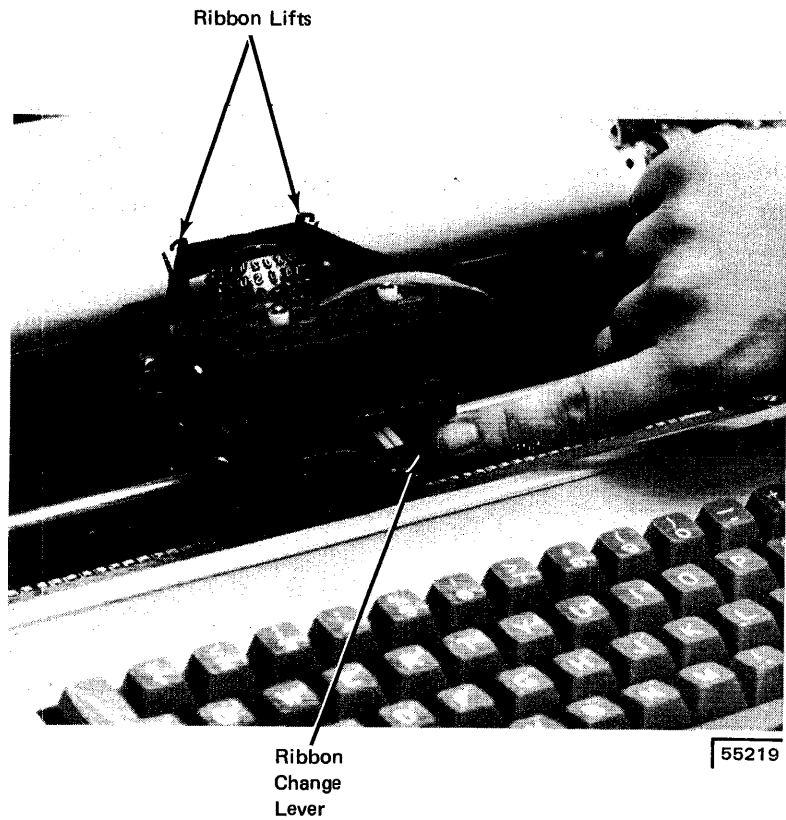

- 3 Lift the cartridge upward and off the ribbon cartridge spindles.
- 4 Ease the ribbon out of the slots in the ribbon lifts.
- 5 To rewind excess ribbon, insert a pencil in either of the holes in the cartridge and turn in the direction of the arrow.

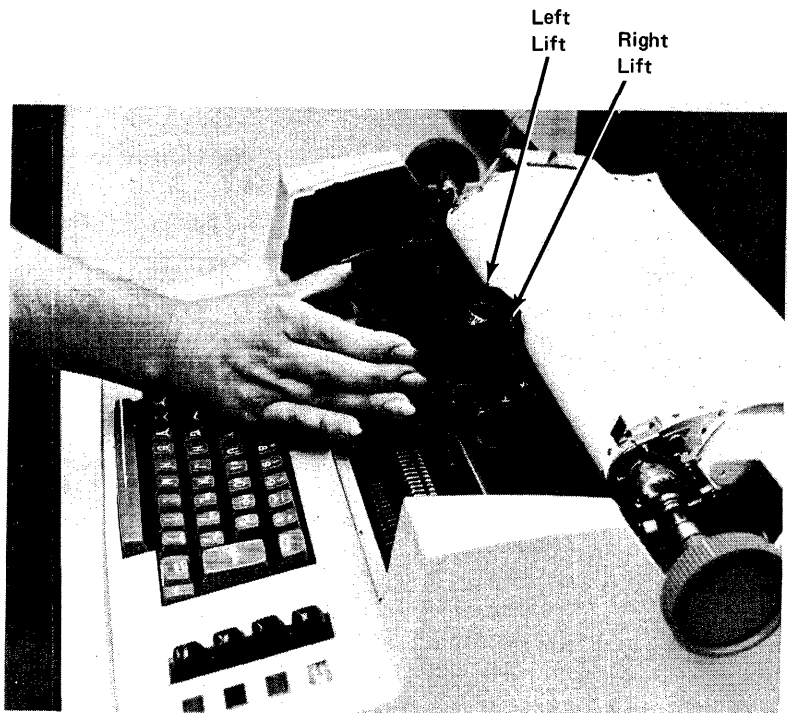



## INSTALLING A FABRIC RIBBON CARTRIDGE

- 1 Lift the front cover.
- 2 Make sure the ribbon change lever is all the way to the right.

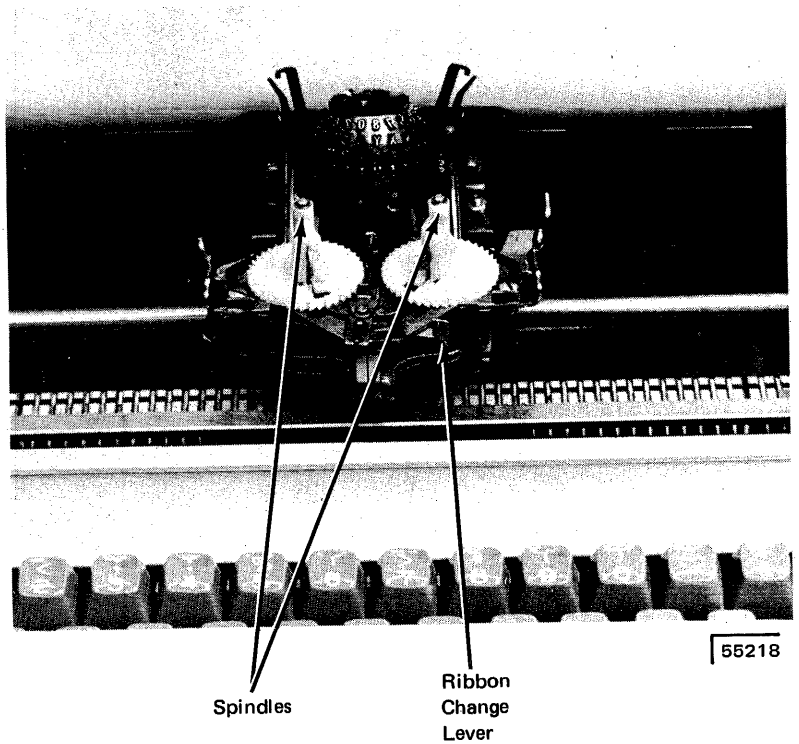

- 3 Position the cartridge in front of the ribbon lifts.
- 4 Slide the ribbon through the right ribbon lift.
- 5 Slide the ribbon down behind the typeball and through the left ribbon lift.
- 6 Place the cartridge on the ribbon spindles and press down evenly and firmly.

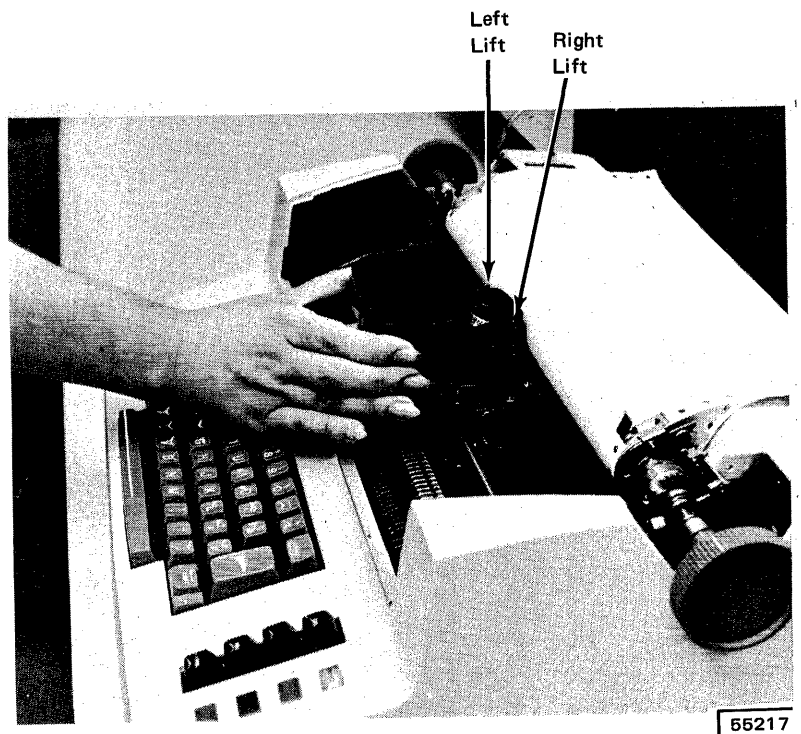

8 Move the ribbon change lever back to the left. This will lower the ribbon into typing position.

9 To rewind excess ribbon, turn either spindle in the direction of the arrow.

10 Close the cover.

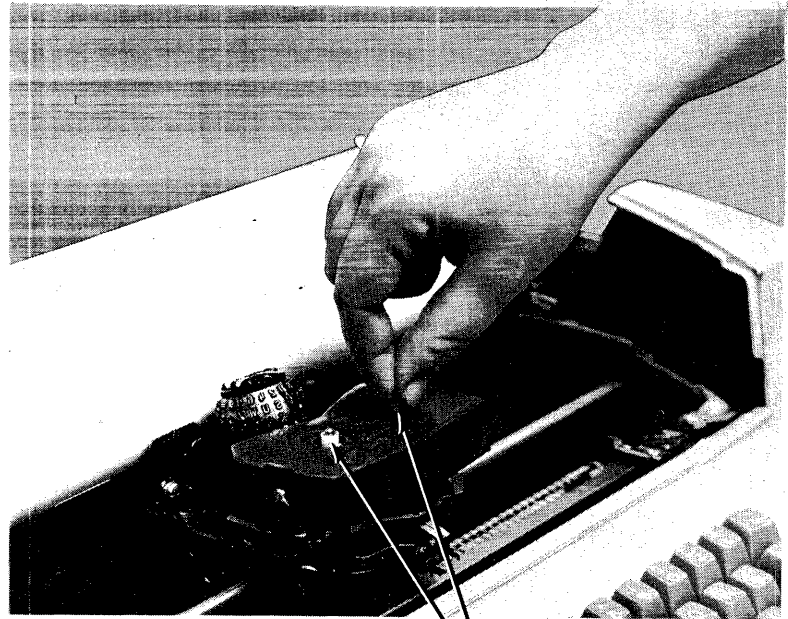

55222

Spindles

This is the way the fabric ribbon cartridge will look when it is correctly inserted and ready for use. The arrows indicate the direction in which the ribbon can move.

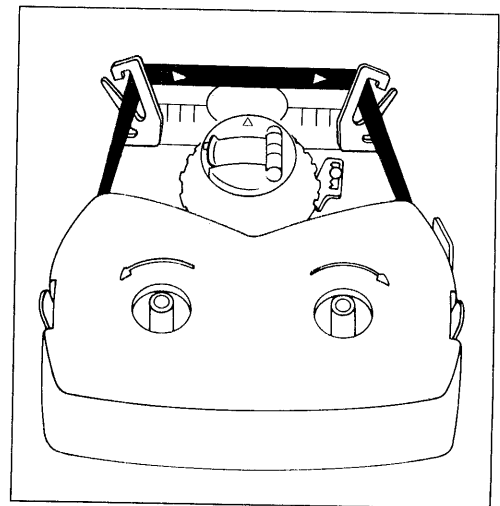

## PLACING FORMS IN THE PRINTER-KEYBOARD

- ① Move forms release lever forward.
- ② Raise bail.
- ③ Lift paper clamps on both sides of the platen.
- ④ Insert forms behind platen and push through until the forms appear on the side of the platen nearest you.

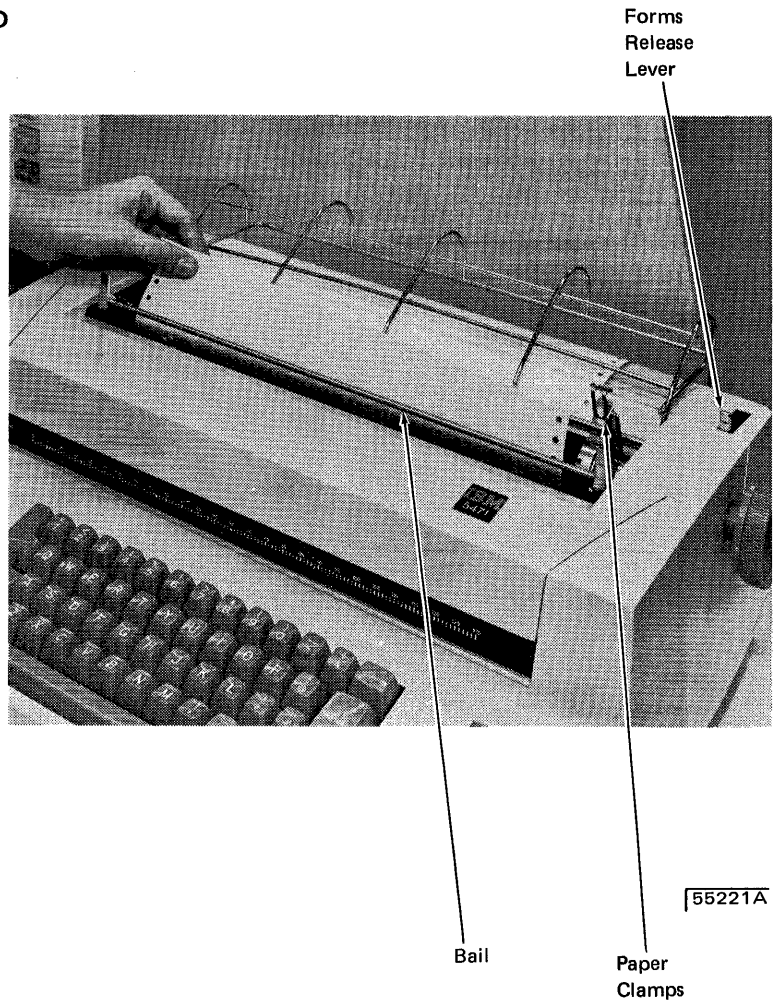

- ⑤ Align forms and place holes in forms onto the pin wheels.
- ⑥ Lower paper clamps.
- ⑦ Lower bail
- ⑧ Push forms release lever back.

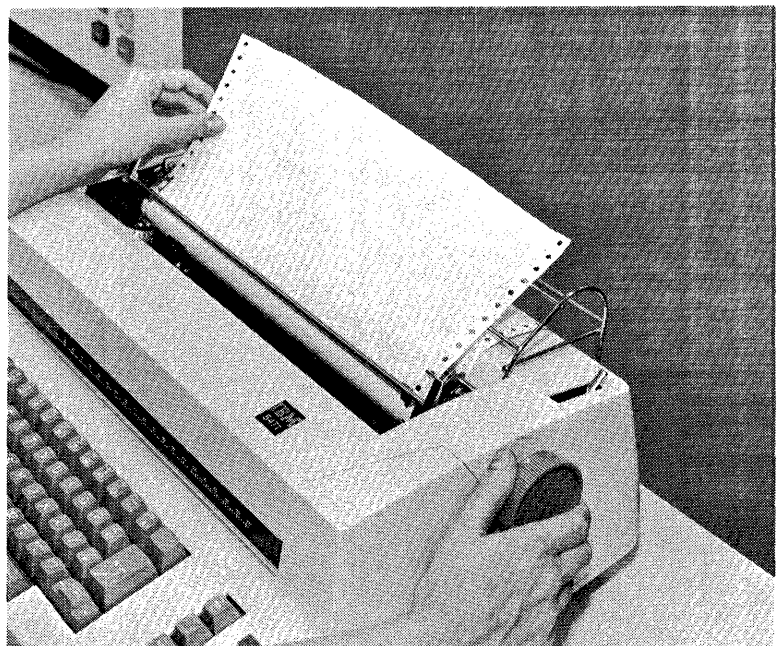



- Preparing for System Operation
- Clearing I/O Attention
- Using the Console Log Sheet
- Stopping a Job Before It Is Completed
- Using the Machine Covers for Safety
- Restoring System Power
- Turning System Power Off
- Dual Program Operation

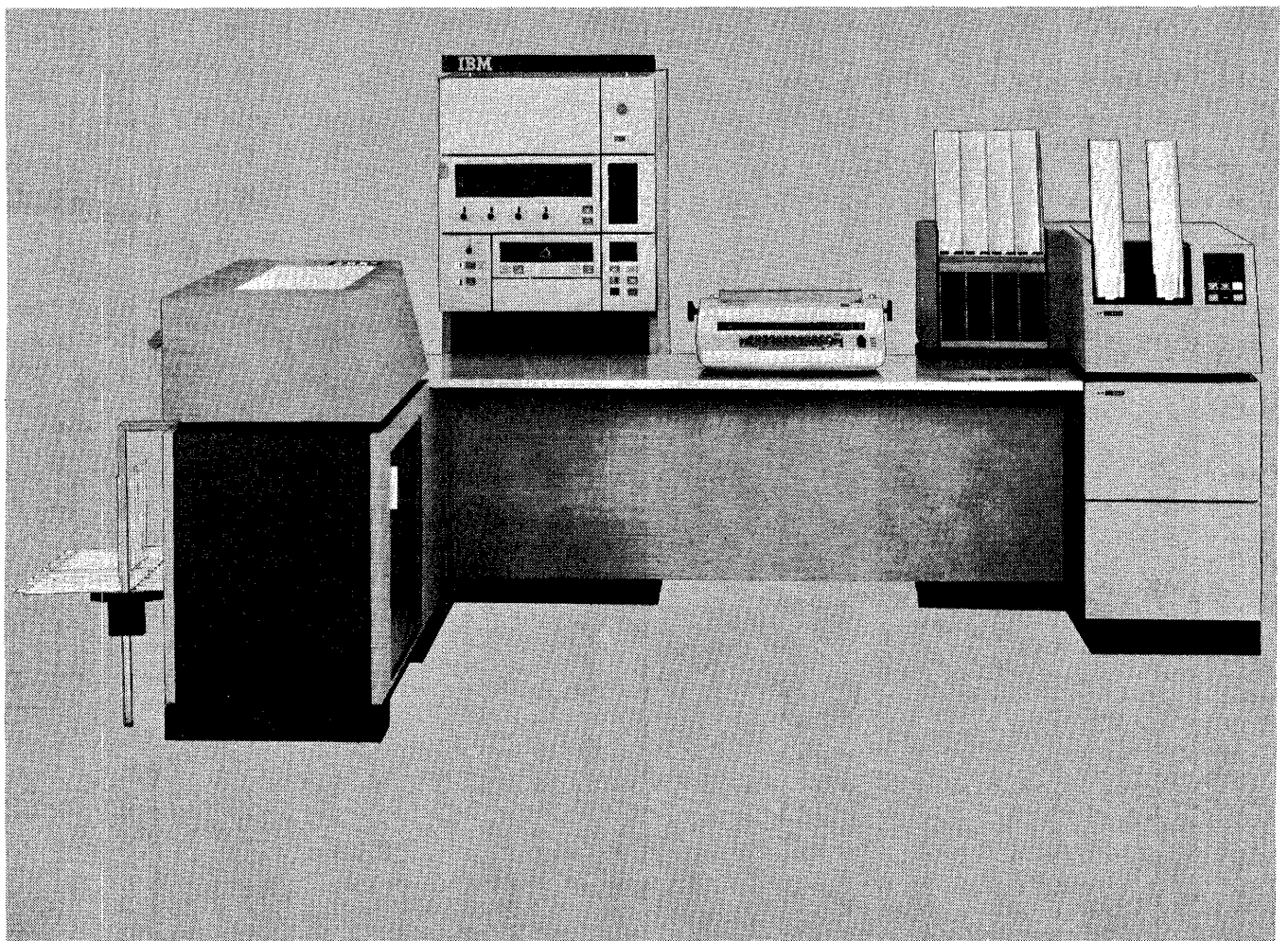

55239A

## PREPARING SYSTEM FOR PROGRAM OPERATION

To ready the system for operation, turn on system power. The power switch is on the system control panel on the processing unit console (Figures 17 and 18).

### Clear Cards from the MFCU

When power is on, the NPRO light is lit on the MFCU. To turn this light off:

1. Remove any cards from card hoppers.
2. Press NPRO key twice.
3. Remove any cards from stackers.

This procedure ensures that both card paths are free of cards.

### Place Forms in the Printer

To have the system ready for program operation, you should have forms in the printer. If you have not aligned the forms in the printer, you can do that now. See *Chapter 4. The IBM 5203 Printer* for procedures on loading and aligning forms.

### Perform IPL (Initial Program Load)

Next, you must initiate the IPL process. The IPL process that you initiate consists of a program that clears storage and loads into storage the control programs necessary to run your jobs. This must be done each time you turn the system power on and when indicated by recovery from halts.

OCL: OPERATION CONTROL LANGUAGE

You initiate the IPL process from one of three sources: MFCU, fixed disk (F1), or removable disk (R1). Normally the IPL process is initiated from the fixed disk or the removable disk depending on where the resident system is located. The IPL process cannot be initiated from R2 or F2.

You may have to initiate the IPL process from the MFCU for some jobs. The program run sheet supplied to you by the programmer indicates when you have to do this. See the procedures later in this section on how to perform IPL from the MFCU.

If you have a dedicated (non-DPF) system, the system will not halt after IPL is performed. This is because the system is ready to begin reading OCL for the first job after IPL is complete. If the first job is ready to be run, ready the proper devices needed by the job. See *Chapter 8. Program Operation* for the procedures for running jobs.

If no jobs are to be run, you can still initiate the IPL process. When IPL is complete, the I/O ATTENTION light comes on and remains on until the appropriate input devices for the first job are ready. When the I/O devices are readied, the system immediately begins to execute the job.

If you have a DPF system, the system will halt with an EJ in both message display units after the IPL process is complete. When EJ appears in the message display units, the system is ready to accept jobs in both program levels.

The first statement supplied to the system after the IPL process is complete is a DATE statement. This statement is supplied to the system via the system input device (normally the primary hopper of the MFCU). The DATE statement has two different formats. The one you choose was defined at system generation time. See *Chapter 9. System Generation* for more information on the DATE statement.

● Figure 17. Summary of Program Operating Procedures for a Dedicated System.

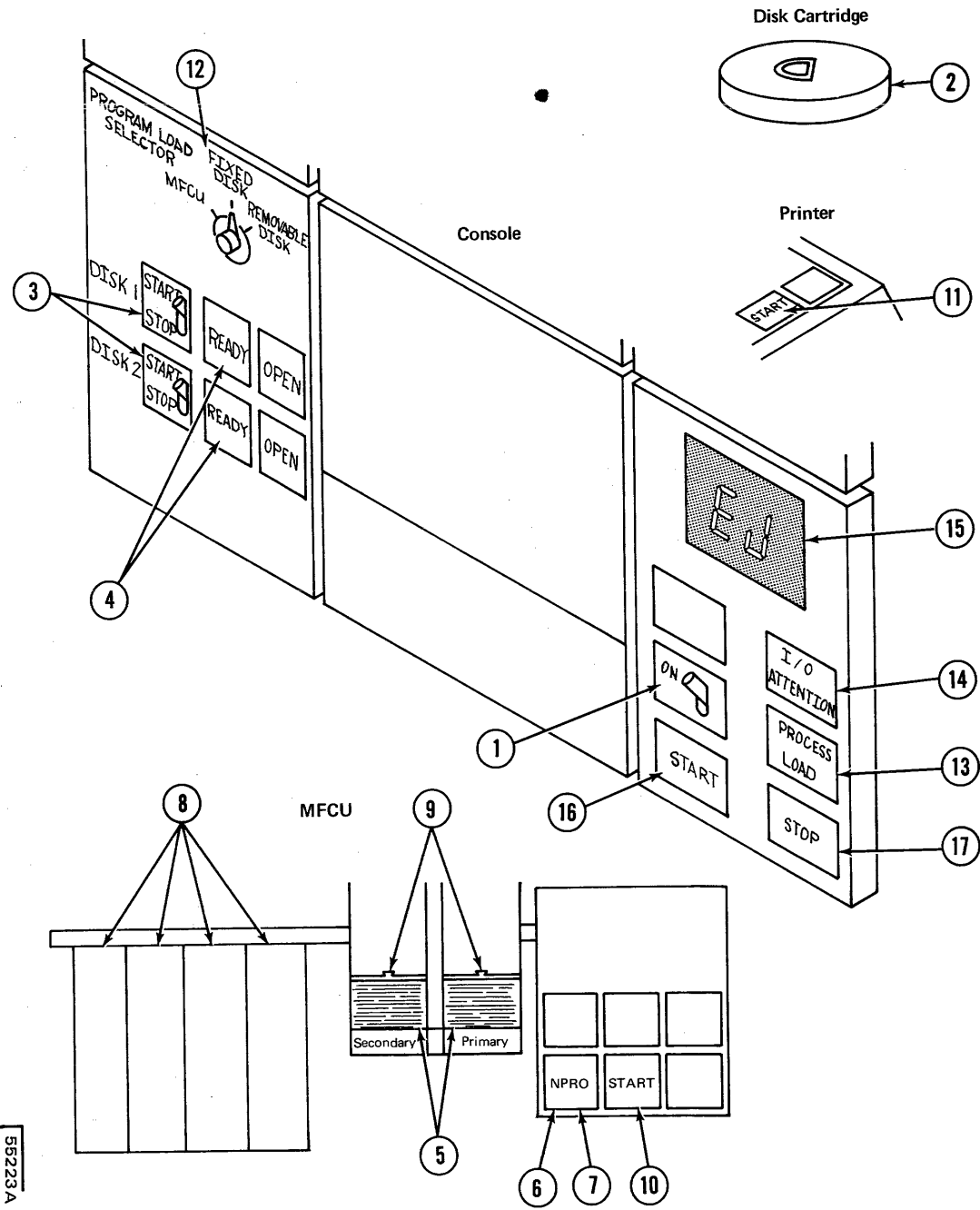

1. System power on.
2. Mount disk cartridge as specified on the program run sheet. Be sure the start/stop switch is set at STOP and the OPEN light is on before mounting a cartridge.
3. Set start/stop switch at START.
4. READY light comes on when disk is up to speed.
5. Remove cards from MFCU hoppers.
6. Press NPRO to clear primary feed path.
7. Press NPRO to clear secondary feed path.
8. Clear all cards from stacker.
9. Place OCL statements, data cards, and blank cards in hoppers, as required by program. Load cards face down, top edge to the left. Check program operating procedures in this manual, and run sheet provided by the programmer for specific instructions.
10. Press MFCU START.
11. Ready printer if it is used by the program.
12. Set program load selector at position from which you will IPL.
13. Press PROGRAM LOAD.
14. I/O device not ready conditions are indicated by I/O ATTENTION light. Ready I/O devices to continue.
15. Programmed halts are displayed in message display unit. See *IBM System/3 Disk System Halt Procedure Guide*, GC21-7540 for explanation of halts.
16. Press console START to continue.
17. Press console STOP when the system is not being used. Press console STOP before turning off system power.

56223A



The formats of a DATE statement are:

1	4	8	12	16	20	24	28	32	36	40	44
//	DATE	mm	dd	yy							
		O	R								
//	DATE	dd	mm	yy							

Delimiters (/ , - , or any desired character except commas, quotes, numbers, and blanks) may be placed between the month (mm), day (dd), and year (yy). For example:

1	4	8	12	16	20	24	28	32	36	40	44
//	DATE	mm	/	dd	/	yy					
		O	R								
//	DATE	dd	-	mm	-	yy					

Place the DATE statement in front of the first job to be run after the IPL process is complete.

The following procedures must be performed each time you initiate the IPL process from the fixed or removable disk:

1. Perform step 1a if the resident system disk cartridge has to be mounted. Perform step 1b if the disk cartridge is mounted or the resident system is on F1.
  - a. If your resident system is on a removable disk cartridge and it is not mounted, mount the cartridge on R1. (See the procedures in *Chapter 5, IBM 5440 Disk Cartridge and IBM 5444 Disk Storage Drive*, if you do not know how to mount or remove cartridges.)
  - b. If the proper cartridge is already mounted or if the resident system is on the fixed disk (F1), set the disk 1 start/stop switch on the disk panel at START.

*Note:* For you to initiate the IPL process, a cartridge must be on R1. When your resident system is on F1, mount the cartridge for the first job on R1 if one is used by the first job. Otherwise, mount any cartridge so you can initiate the IPL process.

2. Set program load selector at FIXED DISK (F1) or REMOVABLE DISK (R1).
3. When the READY light for disk 1 is on, press PROGRAM LOAD. Initial program loading is performed.

### Initiating the IPL Process from the MFCU

Some programs require that you initiate the IPL process from the MFCU. These are known as stand-alone programs because they do not require system control programs to execute. The program run sheet supplied to you by the programmer will indicate when to initiate the IPL process from the MFCU. Perform the following procedures to initiate the IPL process from the MFCU:

1. Place cards for stand-alone job in primary hopper of MFCU.
2. Press MFCU START.
3. Set program load selector at MFCU.
4. Press PROGRAM LOAD.

Cards in the primary hopper of the MFCU are read into storage and the program is executed.

Initiate the IPL process from the fixed or removable disk after completion of the programs that required you to initiate the IPL process from the MFCU.

Figures 17 and 18 show the steps required to load and run a program on System/3. The necessary information you require to run the program can come from two sources, System/3 or the programmer:

1. Information from System/3. The system informs you of error conditions or special operating instructions by a displayed or printed message or both:
  - I/O ATTENTION means an I/O (input/output) device is not ready. See *Clearing I/O ATTENTION* in this chapter.
  - Programmed halts are displayed in the Message Display Unit and described in the *IBM System/3 Disk System Halt Procedure Guide*, GC21-7540.
  - Unidentifiable halts should be recorded on the error log sheet described in this chapter.
2. Information from the programmer. The programmer can give you special instructions on the program run sheet.

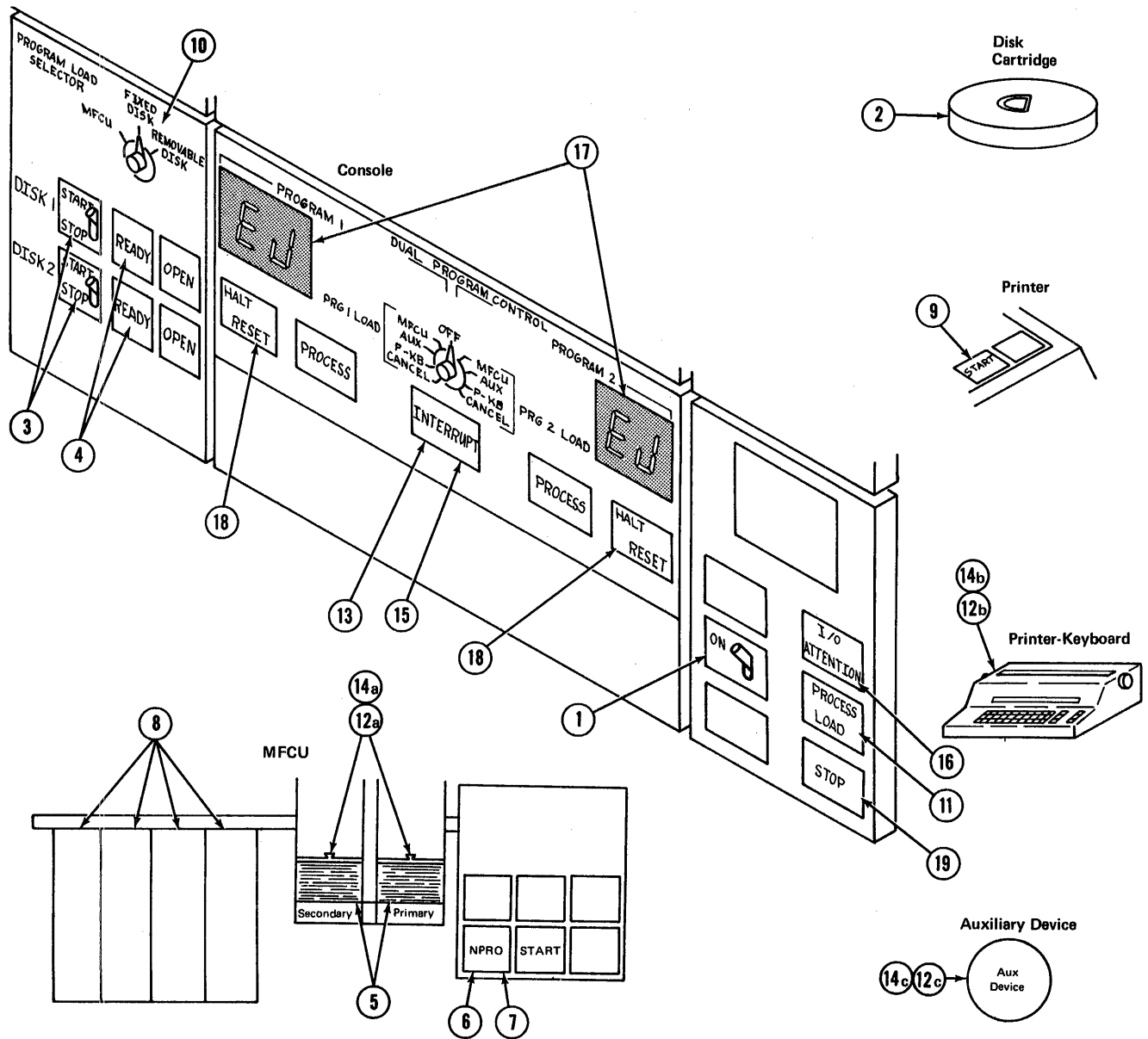

1. System power on.
2. Mount indicated disk cartridge as specified on program run sheet. Be sure the start/stop switch is set at STOP and the OPEN light is on before mounting cartridge.
3. Set appropriate start/stop switch to START.
4. READY light turns on when disk is up to speed.
5. Remove cards from MFCU hoppers.
6. Press NPRO to clear primary feed path.
7. Press NPRO to clear secondary feed path.
8. Clear all cards from stacker.
9. Ready printer if it is used by the program.
10. Set program load selector at position from which you will perform the IPL process.
11. Press PROGRAM LOAD.
12. Set dual program control switch to input device for program 1.
- 12a. If MFCU, place OCL statements, data cards, and blank cards in hoppers as required by program. Load cards face down, top edge to the left. Check program run sheet and operating procedures in this manual. Press MFCU START.
- 12b. If printer-keyboard, be ready to key information.
- 12c. If auxiliary device, ready it.
13. Press INTERRUPT key.
14. Set dual program control switch to input device for program 2.
- 14a. If MFCU, place OCL statements, data cards, and blank cards, as required by the program in the hoppers. Load cards face down, top edge to the left. Press MFCU START.
- 14b. In printer-keyboard, be ready to key information.
- 14c. If auxiliary device, ready it.
15. Press INTERRUPT key.
16. I/O devices not ready will be indicated by the I/O ATTENTION light. Ready the devices to continue.
17. Programmed halts are displayed on the DPF message display units. See *IBM System/3 Disk System Halt Procedure Guide*, GC21-7640, for an explanation of halts.
18. Press HALT/RESET to continue.
19. Press console STOP when the system is not being used. Press console STOP before turning system power off.

● Figure 18. Summary of Program Operating Procedures for a DPF System.

55224A

## CLEARING I/O ATTENTION

The I/O ATTENTION light on the processing unit console turns on when any input/output device is selected by a program and the device is not ready. The device itself has addi-

tional indicators to guide you to the cause of the not-ready condition. I/O ATTENTION turns off when the device that required service is ready for operation. Conditions that cause I/O ATTENTION, along with recovery procedures, are listed in Figure 19.

Device	Device Indicator On	Cause	How to Clear
Printer	none	Printer not ready.	Press printer START.
Printer	FORMS	Forms end.	Load forms in printer and press printer START.
Printer	CHECK	Forms jam.	Clear forms jam and reload forms. Forms position for restart depends on program in operation. Press printer START.
Printer	INTERLOCK	<p>INTERLOCK light is turned on by either of the following conditions:</p> <ol style="list-style-type: none"> <li>1. Chute interlock.</li> <li>2. Chain interlock.</li> </ol>	<p>Open forms compartment door. Push forms chute back to feed position. Close forms compartment door and press printer START.</p> <p>This condition occurs when rear unit is open. Chain motor starts only when rear unit is closed. Close rear unit and press printer START.</p>
MFCU	none*	MFCU not ready.	Ensure proper cards are in hoppers. Press MFCU START.
MFCU	STKR	A stacker is full.	Place cards in bin above stacker and press MFCU START.
MFCU	CHIP	Chip box is full or not in machine.	Open MFCU top cover. Empty and put back chip box. Close top cover and press MFCU START.
MFCU	CVR	MFCU top cover is open or not securely latched.	Close MFCU covers and press MFCU START.
Disk	None	Disk not up to speed.	Wait for ready light to turn on.
BSCA	BSCA ATTN	<p>BSCA ATTN light is turned on by any of the following conditions:</p> <ol style="list-style-type: none"> <li>1. Data set is not ready.</li> <li>2. Autocall unit power is off.</li> <li>3. BSCA is disabled.</li> <li>4. External test switch is on test and BSCA is not in the test mode.</li> <li>5. Data line in use</li> </ol>	<p>Place call.</p> <p>Turn autocall unit power on.</p> <p>Place call.</p> <p>Set external test switch to OPER.</p> <p>Wait for BSCA ATTN light to turn off, then place call.</p>

\*PRI or SEC light is on for all MFCU stops.

Figure 19. Clearing I/O ATTENTION.

## USING THE CONSOLE ERROR LOG SHEET

During system operation, a processor check or unidentifiable halt may occur. To determine the cause of the error, be sure to record the conditions that exist on the system at that moment. You can record these conditions on the System/3 Error Log Sheet (Figure 20). After you have filled out the error log sheet, rerun the program in which the error occurred and proceed according to the appropriate condition:

1. The same error occurs at the same point in the program. Note the condition under which the error occurs on the program run sheet and continue other program operations. Return the program decks, run sheet, and error log sheet to the programmer.
2. The same error occurs at a different point in the program. Contact the shift supervisor to determine if a service call is necessary.
3. The error does not recur. Set the error log sheet aside for review by the CE on his next service call. Continue program operations.

## STOPPING A JOB BEFORE IT IS COMPLETED

If you want to stop a job before reaching the normal end-of-job (EJ halt in message display unit), use the stop key on the processing unit. Do not use MFCU STOP or printer STOP.

When you press MFCU or printer STOP, the current program continues to run until it requires the device that is not ready. Then I/O ATTENTION will be on. In this case, if you clear the MFCU, place punched cards for a new program in either hopper, then press MFCU START (or printer START followed by MFCU START). The program that was waiting for the printer or MFCU will resume operations. If the program waiting for the MFCU starts a punch operation, the new program deck or data cards may be ruined.

It is necessary to perform the IPL process on the system to start a new job after using the console STOP key to stop a job. If you have DPF, you can cancel the job.

## USING THE MACHINE COVERS FOR SAFETY

Besides improving appearance, covers of IBM machines have been designed to protect you against possible injury during operation. While some hazards, such as moving mechanical parts, are obvious, others are not. Electrical potential and acoustical noise are in the latter category.

IBM maintains vigorous attention to safety on all its machines. However, the effectiveness of this effort is lessened when you fail to keep the covers closed while the system is running.

Covers have been designed to reduce noise levels to a more comfortable range. Operation with the covers open causes needless exposure to unseen hazards. Because of this, IBM strongly recommends that all people working with the equipment follow the simple safety-first procedure of keeping all covers closed while the system is operating.

The frames of all IBM equipment have been made electrically safe by recommended grounding practices.

In addition to the safety aspects of this procedure, the system runs quieter and looks better.

## TURNING SYSTEM POWER OFF

When turning system power off, an EJ halt should be displayed in the message display unit. Perform the following procedures to turn system power off:

1. Press console STOP.
2. Set start/stop switches on the disk panel at STOP.
3. Clear cards from MFCU.
4. When the OPEN lights on the disk panel are lit, set the console power switch at OFF.

If system power is turned off before the disk panel start/stop switches are set at STOP, perform the following procedures:

1. Set the power switch at ON and wait for the READY lights to turn on.
2. Set start/stop switches at STOP and wait for the OPEN lights to turn on.
3. Clear cards from MFCU.
4. Set power switch at OFF.

Figure 20. System/3 Error Log Sheet.

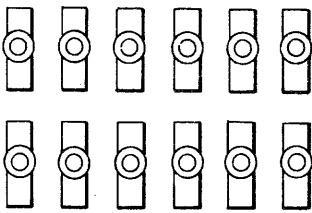

ADDRESS COMPARE    I/O CHECK

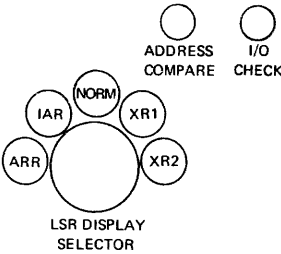

LSR DISPLAY SELECTOR

All of the above switches are normally in the down position. X any switch that is in the up position.

Processing Unit Serial Number

Enter Meter Reading:

--	--	--	--	--	--	--	--	--	--

CONSOLE DISPLAY SELECTOR Note: X block if corresponding indicator is on.

1 SAR HI	P	0	1	2	3	4	5	6	7		P	0	1	2	3	4	5	6	7	SAR LO	1
2 LSR HI	P	0	1	2	3	4	5	6	7		P	0	1	2	3	4	5	6	7	LSR LO	2
3 OP REG	P	0	1	2	3	4	5	6	7		P	0	1	2	3	4	5	6	7	Q REG	3
4 B REG	P	0	1	2	3	4	5	6	7		DIG CAR	DEC	RE COMP	ADD	SUB	TEMP CAR	AND	OR		ALU CTRL	4
5 A REG	P	0	1	2	3	4	5	6	7		P	0	1	2	3	4	5	6	7	ALU OUT	5
6											P			BIN OVF	TF	DEC OVF	HI	LO	EO	COND REG	6
7 CS ASNMT	P	0	1	2	3	4	5	6	7		0	1	2	3	4	5	6	7		INT LEV	7
8 PROC CHK	I/O LSR	LSR F1	LSR F2	LSR HI	LSR LO	SAR HI	SAR LO	INV ADDR	SDR	CAR	DBI	A/B REG	ALU	CPU DBO	OP/Q REG	INV OP	CHAN DBO	INV Q		PROC CHK	8

Set LSR DISPLAY SELECTOR to ARR

2 LSR HI	P	0	1	2	3	4	5	6	7		P	0	1	2	3	4	5	6	7	LSR LO	2
----------	---	---	---	---	---	---	---	---	---	--	---	---	---	---	---	---	---	---	---	--------	---

Set LSR DISPLAY SELECTOR to IAR

2 LSR HI	P	0	1	2	3	4	5	6	7		P	0	1	2	3	4	5	6	7	LSR LO	2
----------	---	---	---	---	---	---	---	---	---	--	---	---	---	---	---	---	---	---	---	--------	---

MACHINE CYCLE: IOP, IO, IR, IX1, IH1, IL1, IX2, IH2, IL2, EA, EB, I/O, INT LEV

CLOCK: 0, 1, 2, 3, 4, 5, 6, 7, 8, 9

Enter ADDRESS/DATA switch setting in circle

SIOC

PROGRAM LOAD SELECTOR

DISK 1: READY, OPEN

DISK 2: READY, OPEN

DUAL PGM CTRL

OFF: MFCU, AUX, P-KB, CANCEL

PRG 1 LOAD: PROCESS, INTERRUPT

PRG 2 LOAD: PROCESS

PROCESSOR CHECK

I/O ATTENTION

STOP

### SYSTEM/3 5410 ERROR LOG SHEET

Date: \_\_\_\_\_ Time: \_\_\_\_\_

Operator: \_\_\_\_\_

Job Name: \_\_\_\_\_

Use this sheet to record console display at any unrecognizable halt.

At the halt:

1. X all console lights that are on.
2. X all console switch settings requested.
3. X any MFCU or printer lights that are on.
4. Set LSR display selector to NORM. Set console display selector to "1 SAR HI." X all insert blocks with corresponding indicators (P8421) on. Repeat for positions 2 through 8.
5. Set LSR display selector to ARR. Set console display selector to "2 LSR HI". X any indicators that are on.
6. Set LSR display selector to IAR. Set console display selector to "2 LSR HI." X any indicators that are on.

Comments: \_\_\_\_\_

\_\_\_\_\_

\_\_\_\_\_

\_\_\_\_\_

(Continue on back)

#### MFCU Indicator Panel

1	2	3	4	SEC	PRI
5	6	7	8	RD	HPR
9	10	11	12	NPRD	STKR
13	14	15	16	CHIP	CVR
17	18	19	20	A	B

SECONDARY READY      PRIMARY READY

#### Printer Indicator Panel

CHECK	INTERLOCK	FORMS
-------	-----------	-------

PROCESSOR CHECK    I/O ATTENTION

STOP

READY

## RESTORING SYSTEM POWER

System/3 can turn off as a result of internal or external power loss, or an overtemperature condition in the processing unit or printer electronics. The recovery procedure depends on the status of the TH CHK (thermal check) and PWR CHK (power check) lights on the processing unit display panel:

### PWR CHK Light Only

Power off was caused by voltage loss or overvoltage in the system. To restore power:

1. Turn the power on switch to OFF.
2. Press the CHECK RESET on the CE control panel.
3. Turn the power on switch to ON.

If power cannot be restored, call IBM for service.

### PWR CHK and TH CHK Lights

Power off was caused by a thermal condition or an external power loss. To restore power:

1. Turn the power on switch to OFF.
2. The PWR CHK and TH CHK lights will turn off. If the thermal check light remains on, you must wait until the temperature lowers and the light turns off.
3. Turn the power on switch to ON.

Thermal checks may indicate that the machine room is too warm or the flow of air to the system has been restricted. If thermal checks continue to occur, contact IBM for service.

### No Lights

Check that line voltage is available to the system. Check that the emergency pull switch is in the normal (in) position. If the emergency pull switch is pulled, call IBM for service.

## CORE STORAGE DUMP

A core storage dump is a process by which the contents of core storage are printed on the printer. The printout is in hexadecimal format and shows the contents at each address in storage.

You may have to take core storage dumps for the following reasons:

- A program is not executing properly. Taking a core storage dump at this time will provide valuable information to the programmer in determining what is wrong with his program. The programmer should indicate to you on the program run sheet when and under what conditions he wants you to take a core storage dump.
- Several halts described in the *IBM System/3 Disk System Halts Procedure Guide*, GC21-7540, require you to take core storage dumps.
- If you ever get processor checks (the PROCESSOR CHECK light on the console is on), you should take a core storage dump. Processor checks indicate that an error occurred in the processing unit while it was attempting to execute a program.

## Considerations Before Taking a Core Storage Dump

- For DPF systems, take a core storage dump *only* when the other program level does not have any programs running. You should wait until the other level is at end-of-job. If it is not possible to wait until the other level is completed and an option is listed for the halt, select the option.
- When a core storage dump is taken and options are listed, the options are no longer valid. This is because you have to perform the IPL process after a core storage dump is taken.

A core storage dump is performed as follows:

1. Press console STOP.
2. Set each address/data switch at 0.
3. Raise CE panel cover and press SYSTEM RESET.
4. Press console START. The entire System/3 core storage will be printed on the printer. When the printing of core storage is complete, EJ will be displayed in the message display unit.
5. Save the dump and return it to the programmer.
6. Perform IPL process before starting next job.



## DUAL PROGRAMMING OPERATION

The Dual Programming Feature (DPF) allows two jobs to execute at the same time within the system. These two jobs are referred to as program 1 and program 2 levels. Jobs can be initiated in either level first. In other words, a job can be loaded into the program 2 level before a job is loaded into the program 1 level. Running jobs under DPF is basically the same as running jobs on System/3 without DPF. The following differences should be noted:

- You select the system input device to be used for each level by using the dual program control switch.
- Press INTERRUPT to initiate the first job for the level, after selecting the input device.
- Press HALT/RESET to recover from programmed halts or to initiate the next job if the same input device for the level is being used.
- If you select a different input device for the level, you must again press INTERRUPT to initiate the job.
- You can use the same input device for both levels only when the first level loaded no longer requires the input device. Halt JP displayed in the DPF message display unit means you are trying to use an input device that is required by the other level.
- Halt JL displayed in the DPF message display unit means that there is not enough room in storage for the job you are trying to load. The PARTITION statement controls the amount of storage available for program 2.

The *IBM System/3 Disk System Halt Procedure Guide*, GC21-7540, lists the halts and the procedures you must take to recover from the halts.

### Procedures

The following general procedures tell you how to run programs if you have DPF:

1. Follow the steps under *Preparing the System for Program Operation* in this chapter to perform IPL. After performing IPL, the EJ halt appears on both DPF message display units.

2. Set dual program control switch on DPF panel to appropriate input device for level you are going to load first (program 1 or program 2). Be sure you supply a DATE statement in front of the first job to be loaded after performing IPL. The system expects the input from the device you selected. If the MFCU is the device, have the cards in the specified hoppers. If the printer-keyboard is the device, be ready to key-in the information.
3. Press INTERRUPT on DPF panel. The job is loaded and execution begins. If the printer-keyboard is the input device, you must key the job.
4. Set dual program control switch on DPF panel to the input device to be used for other program level. Remember, if one level is using an input device, the other level cannot use that device until the first level no longer requires it.
5. Press INTERRUPT on the DPF panel. The job is loaded and execution begins.
6. When a job in one of the levels (program 1 or program 2) is complete, an EJ halt is displayed on the DPF message display unit for that level. If the next job for that level uses the same input device as the preceding job, press HALT/RESET on the DPF panel to load the next job. If you are going to use a different device, repeat steps 2 and 3.
7. Repeat step 6 for the other level when EJ halt occurs.
8. Repeat steps 6 and 7 until there are no more jobs to be run.

While jobs are running, program halts can occur for both levels. See *IBM System/3 Disk System Halt Procedure Guide*, GC21-7540, for recovery procedures when program halts occur. If program halts occur for both levels at the same time, handle them one at a time according to the procedures in *IBM System/3 Disk System Halt Procedure Guide*, GC21-7540. See *Chapter 8. Program Operation* for information on running individual programs.

## Procedures for Canceling Jobs

The CANCEL position on the dual program control panel allows you to cancel programs. Programs cannot be cancelled if:

- The I/O ATTENTION light is on.
- An RPG II object program has been interrupted.
- The RECEIVE INITIAL light on the BSCA panel is on.
- The system is performing the end-of-job function (INTERRUPT light is off).

To cancel a job in either level, perform the following steps.

1. Set dual program control switch on DPF panel at CANCEL for the level (program 1 or program 2) you want to cancel.
2. Press INTERRUPT on DPF panel.
3. Set rightmost address/data switch on processing unit display panel at 2 or 3 when halt JU is displayed on the DPF message display unit.
4. Press HALT/RESET on DPF panel. An EJ halt is displayed on DPF message display unit when the job is canceled.

- Operation Control Language (OCL) Consideration
- RPG II Program
- BSCA Program
- 96-List Program
- 96-96 Reproduce and Interpret Program
- MFCU Sort/Collate Program
- Data Verifying Program
- Data Recording Program
- Disk Sort Program
- Basic Assembler Program
- Disk Utility Programs

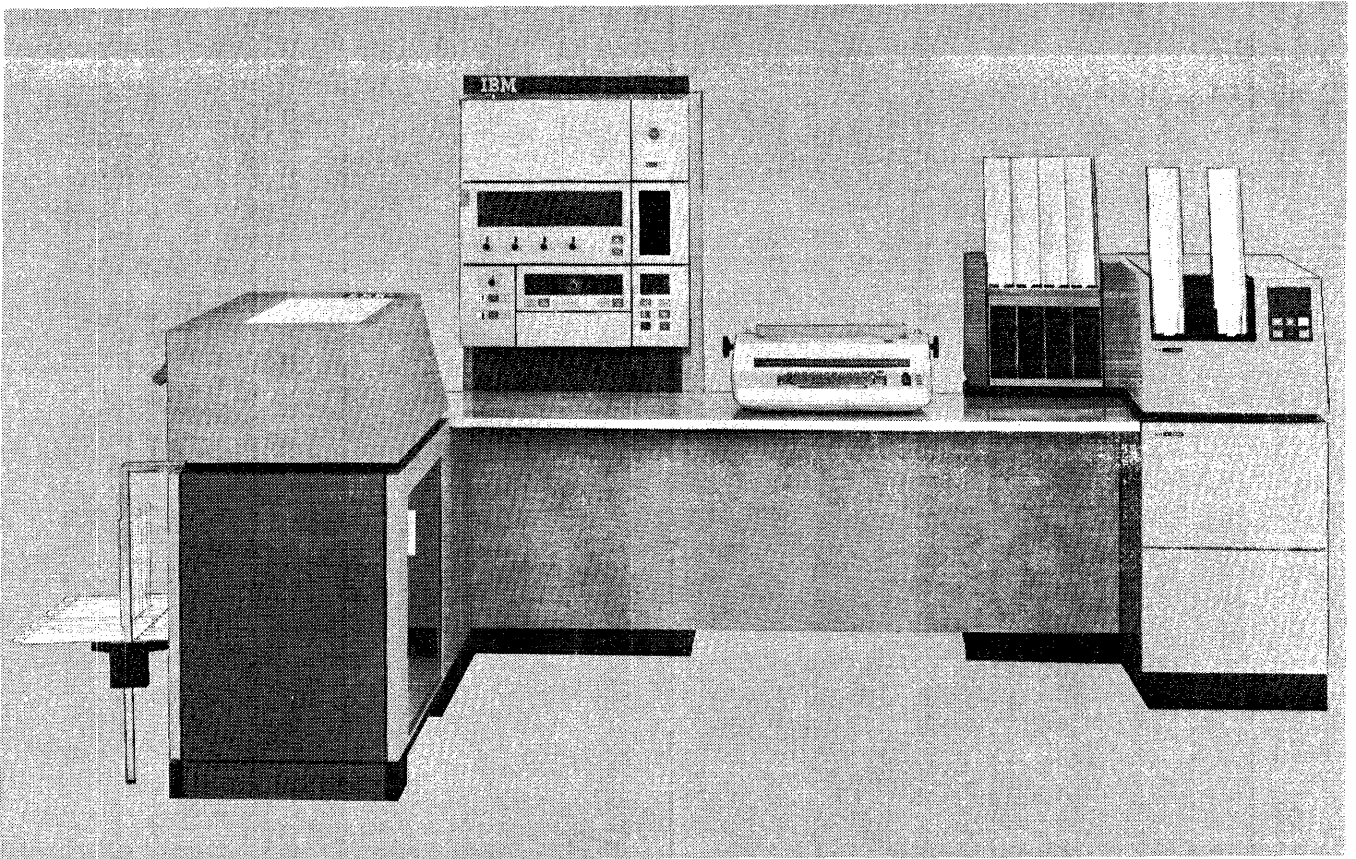

55239A

## OPERATION CONTROL LANGUAGE (OCL) CONSIDERATIONS

Every program that you run has certain statements in front of the deck called OCL (operation control language) statements. OCL provides the system the information about the job to be run (what program to use, what files to use, what input/output devices to use, etc.). It is a good idea to examine these statements because some of them require action from you. OCL statements used by a program should be listed on the program run sheet. Never change the order of the OCL statements. For more information on OCL, see *IBM System/3 Disk System Operation Control Language and Disk Utilities Reference Manual*, GC21-7512.

### // DATE Statement

This card must always be the first statement supplied to the system after IPL. Each time the IPL process is performed, the system expects a DATE statement. The date supplied is used as the system date. Place it in the system input device (normally the primary hopper of the MFCU) ahead of the set of statements of the first job. If you have DPF, the DATE statement must be supplied with the program you load first. Do not provide a DATE statement for the other program.

### // READER Statement

The primary system input device is the primary hopper of the MFCU. The READER statement tells the system to use a different device (printer-keyboard, or secondary hopper of the MFCU). When the READER statement is present, place it and any OCL statement preceding it into the primary hopper of the MFCU. The remaining OCL statements and jobs must be supplied from the device named on the READER statement. To change the system input device back to the primary hopper of the MFCU, perform IPL or supply another READER statement naming the primary hopper of the MFCU as the system input device. The READER statement should be preceded with a /& statement.

### // LOG Statement

If your system has a printer-keyboard, OCL statements and error codes are printed by the printer-keyboard; otherwise, the statements and error codes are printed on the printer. The LOG statement can tell the system to do one of the following:

- Use the printer as the logging device.
- Use the printer-keyboard as the logging device.
- Stop printing OCL statements and error codes.
- Start printing OCL statements and error codes.

The logging device is turned on when you perform IPL. If your system has DPF, the following should be noted:

- The logging device will be off if LOG statements for *either* level (program 1 or program 2) specify that it be off.
- LOG statements for both program 1 and program 2 must state that the logging device be on before it can be used for logging.
- Only LOG statements for program 1 can tell the system to use a different logging device.
- When the printer is the logging device, OCL statements and error codes are not printed if *either* program 1 or program 2 are using the printer for other output.

### // LOAD Statement

This statement identifies the program to be run and indicates whether the program will be loaded from cards or disk.

#### **// RUN Statement**

This statement indicates the end of OCL statements for a job and tells the system to begin execution.

#### **// SWITCH Statement**

This statement is used to set one or more RPG II external indicators on or off. Once these indicators are on, they remain on until they are turned off by another SWITCH statement or until you perform the IPL process. The indicators are all off after the IPL process is performed.

#### **// NOHALT Statement**

This statement tells the system to continue, without stopping, when a program ends. The system continues until it reads a HALT statement. You can stop the system by pressing the console stop key. The NOHALT statement is invalid for program 2 (DPF system). Program 2 will always stop after each job is completed.

#### **// HALT Statement**

This statement is used only if you want to cancel the effect of a NOHALT statement. It tells the system to halt when a job is completed. You can tell the system to continue to the next job by pressing console START (or by pressing the HALT/RESET key if you have DPF). The HALT statement is ignored by program if you have DPF.

#### **// PAUSE Statement**

This statement causes the system to halt with a display of 90 in the message display unit. It is usually preceded by comments on the printer, informing you of some action to take. You may have to mount a different cartridge or insert special forms in the printer. When you have taken the necessary action, press console START (or the HALT/RESET key if you have DPF) to continue operation.

#### **// CALL Statement**

This statement is used only when OCL needed for the job is on disk as a procedure. Procedures are groups of OCL statements that have been placed in the source library on disk.

#### **// FILE Statement**

This statement is used to supply to the system information about groups of related records called files. The system uses this information to read records from and write records on disk.

#### **// PARTITION Statement**

This statement is used only if you have DPF. It tells the system the amount of storage you want for program 2.

#### **// COMPILE Statement**

This statement tells the system where the source program is located (on disk or on cards) and where the object program is to be placed.

#### **// FORMS Statement**

This statement is used to change the number of lines to be printed per page on the printer. The number of lines is normally 66 but could have been changed at system generation.

#### **// IMAGE Statement**

This statement must be supplied whenever the printer chain is changed. The printer requires characters matching those on the printer chain to be in a special area of storage called the chain-image area. When you replace the printer chain with one having different characters, the contents of the chain-image area must also be changed. See Appendix A for more information on the IMAGE statement.

## RPG II PROGRAM

This section lists the steps required to compile and execute an RPG II program. *IBM System/3 Disk System Halt Procedure Guide*, GC21-7540, lists compilation halts and object program execution halts.

### Compilation

The procedures for compiling an RPG II source program are:

1. Mount any disk cartridges specified on program run sheet, and ready disks.
2. Clear all cards from the MFCU by pressing NPRO twice.
3. Place OCL statements and source program deck in the primary hopper (see Figure 21 and 22). Load cards face down, top edge to the left. A source program deck may not be given to you if a // COMPILE statement is supplied in the OCL for the program. The COMPILE statement tells the system where the

source program is located (on disk or cards) and where to place the object program. When the source program is on disk, you will not be given a source program deck. This is all that is needed for diagnostics-only run.

4. If an object deck is to be punched, place blank cards in the secondary hopper. Load cards face down, top edge to the left.
5. Press MFCU START. PRIMARY READY and SECONDARY READY lights turn on.
6. Ready printer.
7. Press console START (or appropriate HALT/RESET key if you have DPF).

During compilation, a number of halts can occur. Check the list of program halts in *IBM System/3 Disk System Halts Procedure Guide*, GC21-7540, for recovery procedures.

EJ in the Message Display Unit indicates the end of compilation, or the end of a diagnostics only run. Clear the MFCU according to the type of run just completed (see following methods). Always clear the primary hopper first.

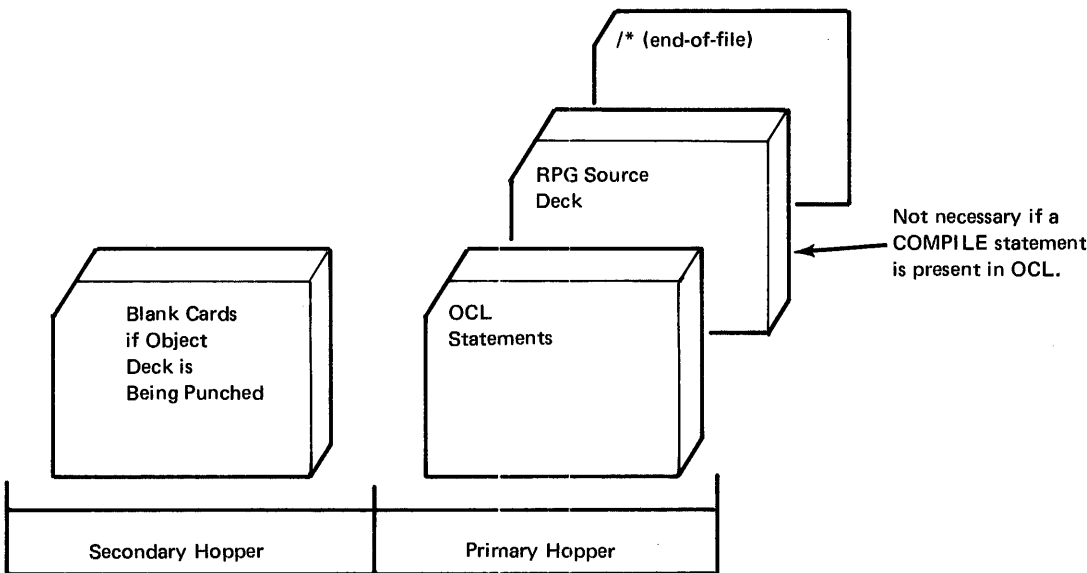

● Figure 21. RPG II Input.

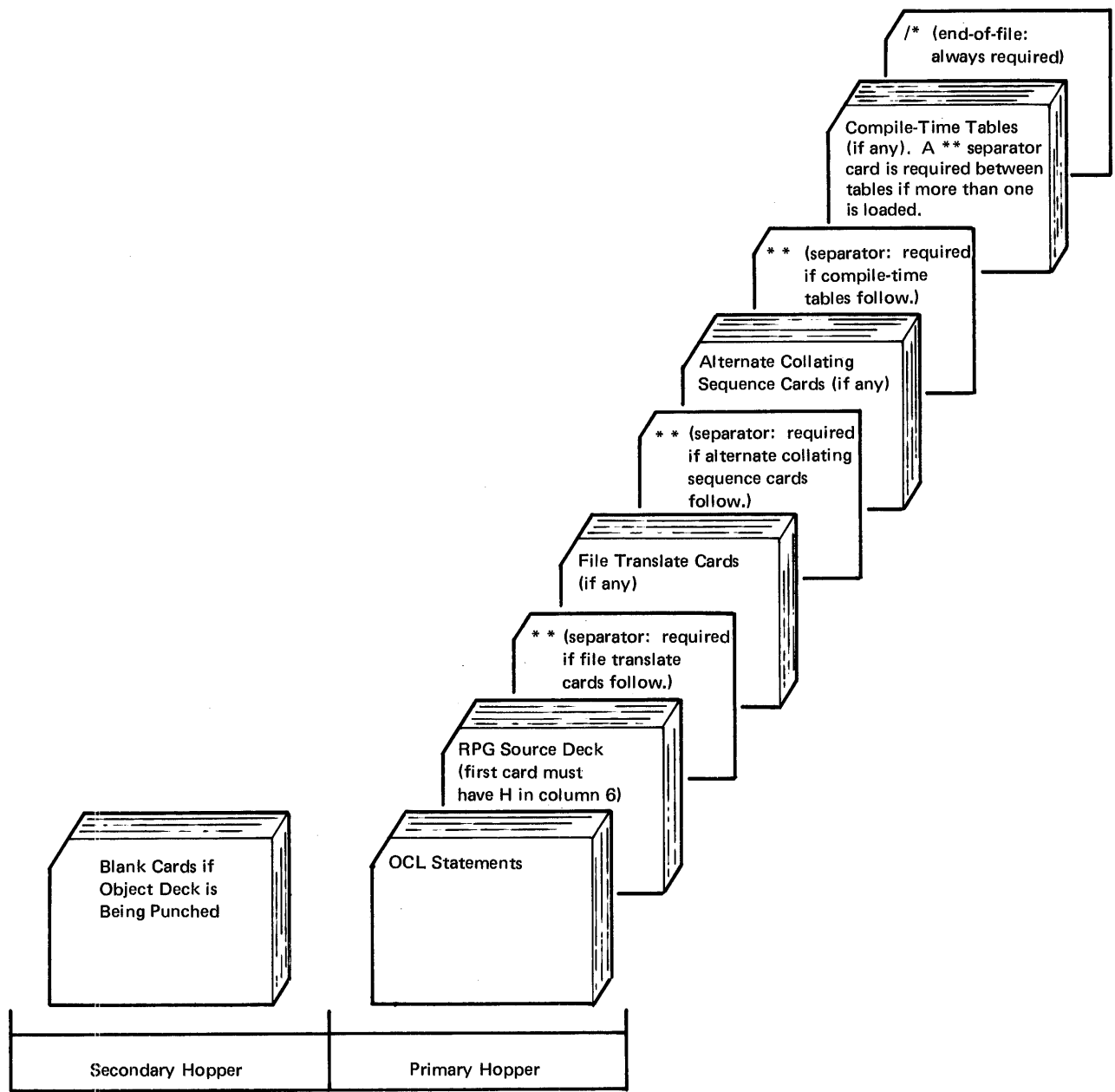

Figure 22. RPG II Input with Optional Source Material.

### *Clearing the MFCU After a Successful Compilation*

1. Press MFCU STOP.
2. Press NPRO to feed source deck end-of-file card into stacker 1.
3. Remove source deck from stacker 1.
4. If an object deck was punched, it will be in stacker 3. Use these cards for the execution portion of the RPG II program.
5. Remove blank cards from secondary hopper.
6. Press NPRO.
7. Remove blank card from stacker 1.

### *Clearing the MFCU After a Diagnostic-Only Run*

1. Press MFCU STOP.
2. Press NPRO to feed source deck end-of-file card into stacker 1.
3. Remove source deck from stacker 1.

### **Object Program Execution**

1. Mount disk cartridge specified on program run sheet, and ready disks.
2. Clear cards from MFCU.
3. Place OCL statement in primary hopper. Load cards face down, top edge to the left. If an object deck was punched, place it in the primary hopper of the MFCU.
4. If required, place object tables and data cards (Figure 23) in the hopper designated on program run sheet.
5. Press MFCU START. The PRIMARY READY light will come on. If any cards are in the secondary hopper, SECONDARY READY will come on.
6. Ready printer. If special forms are required, load them in the printer.
7. Press console START (or appropriate HALT/RESET key if you have DPF).

During object program execution, a number of halts can occur. H1-H9 halts indicate that instructions for running this program are provided on the program run sheet or printer listing. A 1P halt means the forms in the printer need positioning. H1-H9 and 1P halts can occur only if the programmer specified them in the source program. All object program halts are included in the list of program halts in *IBM System/3 Disk System Halt Procedure Guide*, GC21-7540.

EJ in the message display unit indicates a successful program execution.



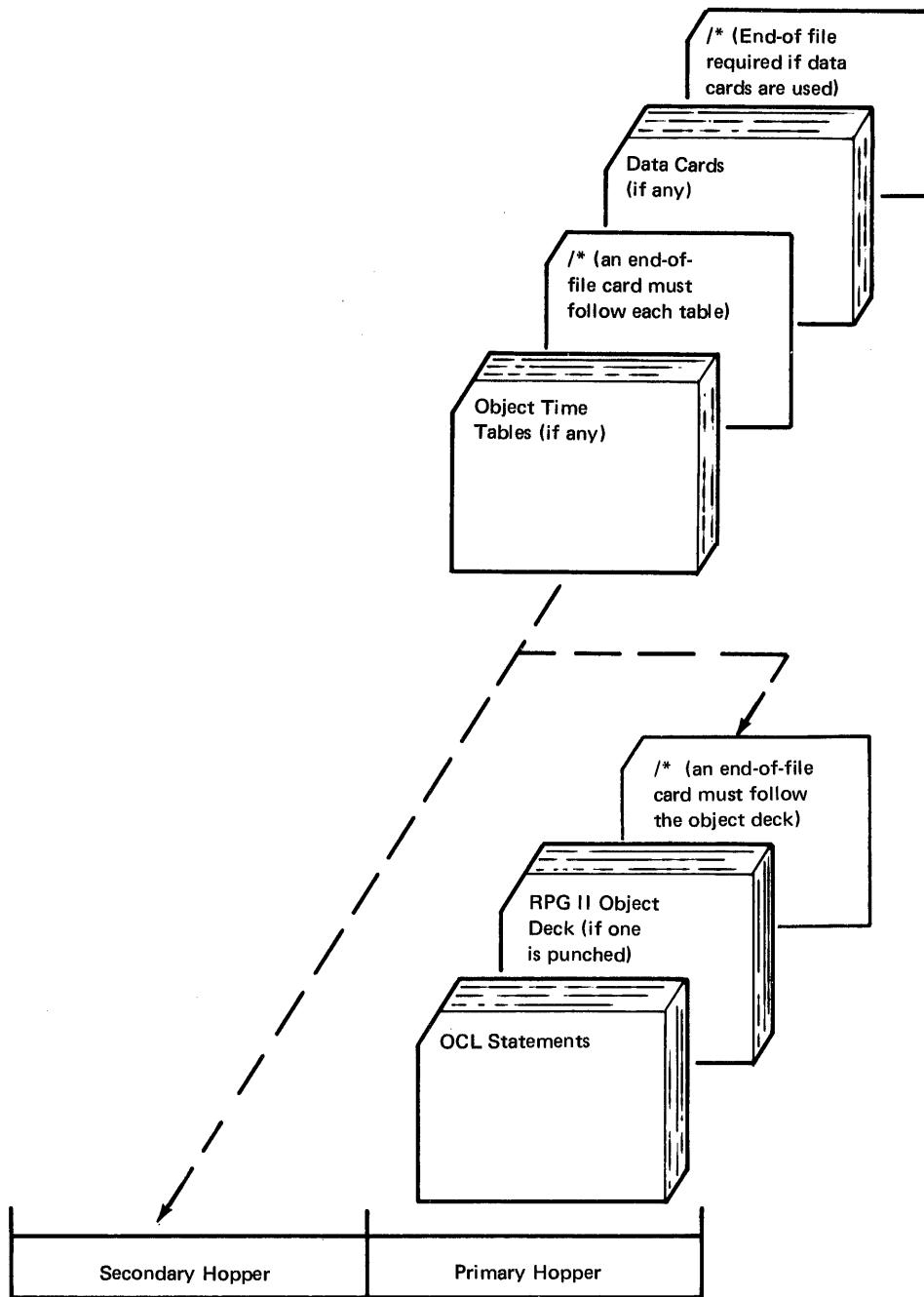

Figure 23. Input for RPG II Object Program Execution.

## Executing an RPG II I-Type Program

RPG II I-Type programs are loaded into storage and remain there to be used as needed. I-Type programs can only be executed by an inquiry request (pressing REQ on the printer-keyboard). An I-Type program cannot be interrupted and placed on disk. I-Type programs can be used most efficiently with a DPF system, however, they can also be used on a dedicated (non-DPF) system. I-Type programs can also be loaded into storage after interrupting an RPG II object program. For information on executing I-Type programs after interrupting RPG II object programs, see *Interrupting an RPG II Object Program*.

The execution of an I-Type program depends on the input device (MFCU or printer-keyboard) being used.

### *Execution of an I-Type Program Using the MFCU*

1. Mount disk cartridge specified on program run sheet and ready disks.
2. Clear cards from MFCU.
3. Place OCL statements and data cards in primary hopper of MFCU.

*Note:* The OCL statements may be keyed using the printer-keyboard. This will be indicated on the program run sheet when you have to do this. The data cards will still be placed in the primary hopper.

4. Press MFCU START.
5. Press console START, or appropriate HALT/RESET key if you have DPF. The OCL statements are read and the I-Type program is loaded into storage.
6. Press REQ on printer-keyboard. The data cards are read and the I-Type program is executed. EJ is displayed in the message display unit when the job is complete. If any other halts occur, see *IBM System/3 Disk System Halt Procedure Guide*, GC21-7540 for recovery procedures.

### *Execution of an I-Type Program Using the Printer-Keyboards*

1. Mount disk cartridge specified on the program run sheet and ready disks.
2. Key OCL statements using the printer-keyboard.

*Note:* The OCL statements can be on cards. The program run sheet will indicate to you when the OCL statements are on cards. Place the OCL statements in the primary hopper, press MFCU START, and console START, or appropriate HALT/RESET key if you have DPF.

3. Press REQ on printer-keyboard. PROCEED light turns on.
4. Key data record using printer-keyboard. The data record is processed and then the I-Type program goes into a wait state. It is waiting for the next data record to be processed.
5. Press REQ on printer-keyboard. PROCEED light turns on.
6. Key next data record when desired. The data record is processed and, again, the I-Type program goes into a wait state.
7. Repeat steps 5 and 6 for each data record to be processed.
8. When no more data records are to be processed, press REQ on printer-keyboard and key /\*. EJ is then displayed in the message display unit. If other halts occur, see *IBM System/3 Disk System Halt Procedure Guide*, GC21-7540.

### **Interrupting an RPG II Object Program**

RPG II object programs can be interrupted provided the job being executed allows interrupts and you have a printer-keyboard to initiate the interrupt. When the interrupt is initiated, the job in storage is placed on disk. A new job can then be loaded into storage and executed. The program run sheet will indicate when you have to interrupt an RPG II object program.

Perform the following procedures to interrupt an RPG II object program.

1. Press REQ on printer-keyboard. The REQUEST PENDING light is on. When the REQUEST PENDING light is off, the interrupt has been allowed. The RPG II job in storage is now placed out on disk by the system.
2. When halt JY is displayed in the message display unit, check the program run sheet to determine if the interrupted program is using the MFCU. Then perform the following steps as required. If the MFCU is not being used, proceed to step 9.
3. Remove cards from primary hopper. Indicate that these cards came from the primary hopper. You will have to use these cards later.
4. Press MFCU NPRO. One card is fed into stacker 1. Place this card in front of cards removed from primary hopper.
5. Remove cards from stacker 1 and set them aside. They will not be used again by this job.
6. Remove any cards from the secondary hopper. Indicate that these cards came from the secondary hopper.
7. Press MFCU NPRO. One card is fed into stacker 1 if the secondary hopper is being used. Place this card in front of any cards removed from secondary hopper.
8. Remove any cards from stackers.
9. Place cards, if necessary, for new job in specified hoppers of MFCU as indicated on the program run sheet.
10. Press MFCU START, if necessary.
11. Mount disk cartridge as specified on the program run sheet for the new program, if any, and ready disks.
12. Ready printer.
13. Set rightmost address/data switch at 0.
14. Press console START (or appropriate HALT/RESET key if you have DPF).
15. When the PROCEED light comes on, key OCL for new job via the printer-keyboard. You may only have to key a READER statement if the OCL for the new job is on cards. In this case, key-in the READER statement and place the OCL for the job in front of any cards in the primary hopper. If an I-Type program is being loaded (determine this by checking the program run sheet) and the printer-keyboard is being used as the input device, the following must be done after keying the OCL statements and the first data record:
  - a. Press REQ on the printer-keyboard. The PROCEED light turns on.
  - b. Key next data record.
  - c. Repeat steps a and b for each data record, including the end-of-file (/\*) statement.

The new job is loaded and halt '5 occurs. This halt allows you to continue with or cancel the job.
16. Set rightmost address/data switch at 0 to allow the job to execute or set rightmost address/data switch at 3 to cancel the job.
17. Press console START (or appropriate HALT/RESET key if you have DPF). If you cancelled the job, go to step 20.

The job begins execution. When the job is complete, halt J' is displayed in the message display unit. You must now restore the conditions that existed before the RPG II job was interrupted.
18. Clear cards from MFCU.
19. Remove cards from stacker 1.
20. Place remaining cards (if any) for the interrupted program back in the appropriate hoppers of the MFCU.
21. Press MFCU START.
22. Remount disk cartridge used by the interrupted job and ready disks.
23. Ready printer.
24. Set rightmost address/data switch at 0.

25. Press console START (or appropriate HALT/RESET key if you have DPF) to continue operation of the interrupted job. If the J' halt occurs again, you may have mounted the wrong cartridge. After you have checked that the correct cartridge is mounted, set the rightmost address/data switch at 0 and press console START (or appropriate HALT/RESET key if you have DPF).

If any other halts occur during this operation, refer to the *IBM System/3 Disk System Halt Procedure Guide*, GC21-7540, for recovery procedures.

## BSC PROGRAMS

This section lists the steps required to compile and execute a BSC program. Any halts that occur are listed in the *IBM System/3 Disk System Halt Procedure Guide*, GC21-7540.

### Compilation

1. Mount disk cartridges specified on the program run sheet and ready disks.
2. Clear cards from MFCU.
3. Remove cards from stackers.
4. Place OCL statements and source deck in primary hopper. Load cards face down, top edge to the left. This is all that is needed for a diagnostics-only run.
5. If an object deck is to be punched, place blank cards in the secondary hopper. Load cards face down, top edge to the left. (The object program is placed on disk when cards are not punched.)
6. Press MFCU START. PRIMARY READY and SECONDARY READY lights turn on.
7. Ready printer.
8. Press console START, or appropriate HALT/RESET key if you have DPF. During compilation, a number of halts can occur. Check the list of program halts in *IBM System/3 Disk System Halt Procedure Guide*, GC21-7540, for recovery procedures.

EJ in the message display unit indicates the end of compilation or the end of a diagnostics-only run. Clear the MFCU according to the type of job just completed (see following methods). Always clear the primary hopper first.

### Clearing the MFCU After a Successful Compilation

1. Press MFCU STOP.
2. Press NPRO to feed source deck end-of-file card into stacker 1.
3. Remove source deck from stacker 1.
4. If an object deck was punched, it will be in stacker 3. Use these cards for the execution portion of the BSCA program.
5. Remove blank cards from secondary hopper.
6. Press NPRO.
7. Remove blank card from stacker 1.

### Clearing the MFCU After a Diagnostic-Only Run

1. Press MFCU STOP.
2. Press NPRO to feed source deck end-of-file card into stacker 1.
3. Remove source deck from stacker 1.

### Execution

There are two types of BSCA networks: nonswitched and switched. For nonswitched networks, there is always a direct communication line between the stations. The data phone is never used. Nonswitched networks can be further broken down into point-to-point and multipoint, nonswitched networks. For point-to-point, nonswitched networks, the communication lines are continuously established between two stations. A multipoint, nonswitched network has a central station and several tributary stations. The communication lines are continuously established, but the central station selects the tributary station that can send and receive data at a certain point in time.

For switched networks, a direct communication line is not always established. The data phone is used to establish the necessary communication lines. A switched network is point-to-point only, but communication is possible with many different stations. The procedures for executing BSCA object programs over switched and nonswitched networks follow.

A schedule must be established to ensure that each BSCA station loads its program at the correct time. On a leased network, the receiving station must start first. On a multi-point network, the System/3 terminal must start first. These programs will wait; a transmit program will not wait for the receiving program to be started. On a switched network, the answering terminal must be ready first.

#### *Nonswitched Networks*

1. Mount disk cartridges specified on program run sheet and ready disks.
2. Clear cards from MFCU.
3. Remove cards from stackers.
4. Place OCL statements, object deck (if any), and data cards (if any) in hoppers as specified on program run sheet.
5. Press MFCU START. PRIMARY READY LIGHT turns on. If there are any cards in the secondary hopper, the SECONDARY READY light turns on.
6. Ready printer.
7. Press console START, or appropriate HALT/RESET key if you have DPF. The programs are loaded and transfer of data occurs. Transmission is complete when EJ is displayed in the message display unit.

#### *Switched Networks*

The procedures you perform when your system is on a switched network depends on whether you are initiating the call and whether the initiation of the call is being made manually or automatically.

#### *Initiating a Call Manually*

1. Mount disk cartridges specified on program run sheet and ready disks.
2. Clear cards from MFCU.
3. Remove cards from stacker.

4. Place OCL statements, object deck (if any), and data cards (if any) in hoppers as specified on program run sheet.
5. Press MFCU START. PRIMARY READY light turns on. If there are any cards in the secondary hopper, the SECONDARY READY light turns on.
6. Ready printer.
7. Press console START, or appropriate HALT/RESET key if you have DPF. The program is loaded and execution begins.
8. When halt Y7 occurs, do the following:
  - a. Press TALK on data phone.
  - b. Set rightmost address/data switch at 0.
  - c. Press console START, or appropriate HALT/RESET key if you have DPF.
  - d. Wait for I/O ATTENTION and BSCA ATTN lights to turn on.
  - e. Pick up receiver and dial digits in proper sequence.
  - f. Verbally communicate with the operator on the other system, or if AUTO is pressed on the data phone of the other system, wait for a high-pitch tone.
  - g. Press DATA on your phone.
  - h. Place receiver back on phone.

#### *Initiating a Call Automatically*

1. Mount disk cartridges specified on program run sheet and ready disks.
2. Press AUTO on data phone.
3. Clear cards from MFCU.
4. Remove cards from stackers.
5. Place OCL statements, object deck (if any), and data cards (if any) in hoppers as specified on program run sheet.
6. Press MFCU START. PRIMARY READY light turns on. If there are any cards in the secondary hopper, the SECONDARY READY light turns on.

6. **ABORTS** — Number of times a remote terminal has terminated transmission abnormally while receiving data.
7. **ADAPTER CHECKS ON TRANSMIT** — Number of times the following errors occurred while the terminal was transmitting data:
  1. Parity check within the adapter.
  2. Cycle steal overrun.
  3. Local storage register or control register check.
8. **ADAPTER CHECKS ON RECEIVE** — Number of times the following errors occurred while the terminal was receiving data:
  1. Parity check within the adapter.
  2. Cycle steal overrun.
  3. Local storage register or control register check.
9. **INVALID REPLIES** — Number of abnormal responses (including no responses) from the remote terminal.
10. **ENQ'S RECEIVED** — Number of requests for retransmission of this terminal's last acknowledgement after the acknowledgement has already been sent.
11. **LOST DATA COUNT** — Number of text blocks received which do not fit into the receive area.
12. **DISCONNECT TIMEOUTS** — Number of times the data set has dropped ready status after that status was set on.
13. **TIMEOUTS DURING RECEIVE DATA** — Number of times this terminal expected to receive text but did not receive anything for 3.25 seconds.

## CARD UTILITIES

The procedures in this section are for the following card utilities:

1. 96-List
2. 96-96 Reproduce and Interpret
3. MFCU Sort/Collate
4. Data Recording
5. Data Verifying

## 96-LIST PROGRAM

1. Mount disk cartridge specified on the program run sheet, if any, and ready disks.
2. Clear cards from MFCU.
3. Place OCL statements and cards to be listed in primary hopper of MFCU (Figure 24). Load cards face down, top edge to the left. Be sure two end-of-file (*/\**) cards are at the end of the deck to be listed.

More than one deck can be placed in the MFCU and listed. Each deck, however, must be followed by two end-of-file cards.

4. Press MFCU START. The PRIMARY READY light will turn on.
5. Ready printer.
6. Press console START (or appropriate HALT/RESET key if you have DPF). After the program is loaded, the system halts with CU displayed in the message display unit. If CU is not displayed, check the list of program halts in the *IBM System/3 Disk System Halt Procedure Guide*, GC21-7540.

7. Set rightmost address/data switch on console to select the program option you want to run, as indicated on the program run sheet:

- Card count only; no listing      0
- Single space with card count      1
- Double space with card count      2
- Triple space with card count      3

Any switch setting other than 0 through 3 selects the double-space-with-card-count option (same as 2).

8. Press console START (or appropriate HALT/RESET key if you have DPF). The selected program option is performed and all cards are placed in stacker 1.

When the end-of-file cards (*/\**) are read, the system halts with 52 in the message display unit. If there are no more list jobs to run, proceed to step 9. If more list jobs are to be run, follow the steps under *Restart Procedure*.

9. Set rightmost address/data switch at 2.

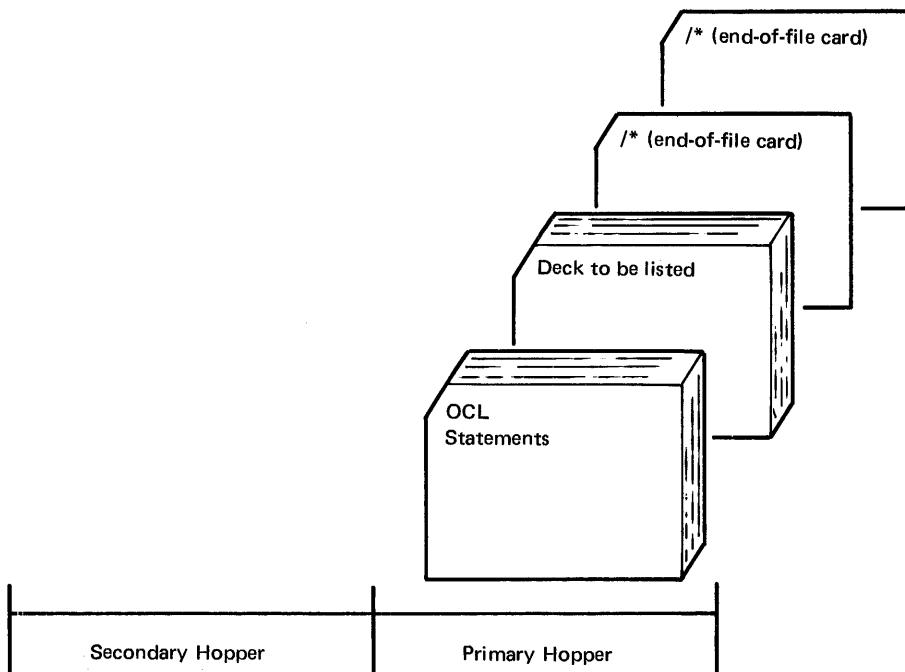

Figure 24. Input Deck for List Program.

10. Press console START (or appropriate HALT/RESET key if you have DPF).
11. System halts with EJ in the message display unit. Clear cards from MFCU.

#### *Restart Procedure*

1. Set rightmost address/data switch at 1.
2. Press console START (or appropriate HALT/RESET key if you have DPF). The message display unit changes to CU.
3. Place cards needed for this run in primary hopper of MFCU—if they are not already there—and ready MFCU.
4. Repeat operating procedure starting at step 7.

### **96-96 REPRODUCE AND INTERPRET PROGRAM**

1. Mount proper disk cartridge if specified on program run sheet and ready disks.
2. Clear cards from MFCU.
3. Place OCL statements, followed by cards required for the job, in primary hopper of MFCU. Load cards face down, top edge to the left. Be sure two end-of-file (/\*) cards are at the end of the deck. Several reproduce and interpret jobs can be placed in the MFCU at the same time. Place the cards in the order shown in Figures 25 and 26. Each deck, however, must be followed by two end-of-file cards.
4. Place blank cards in secondary hopper if any deck in primary hopper is being reproduced. You will be able to tell this by looking at the program run sheet.
5. Press MFCU START. The PRIMARY READY light will turn on. If there are blank cards in the secondary hopper, the SECONDARY READY light will turn on.
6. Press console START (or appropriate HALT/RESET key if you have DPF). After the program is loaded, the system halts with CU displayed in the message display unit. If CU is not displayed, check the list of program halts in the *IBM System/3 System Halt Procedure Guide*, GC21-7540.

7. Set rightmost address/data switch on console to select program option you want to run, as indicated on the program run sheet:

- Read and interpret (print as punched) 0
- Reproduce (punch a new card deck) 1
- Reproduce and interpret (punch and print on cards) 2
- Reproduce with reformatting 3
- Reproduce and interpret with reformatting 4

Any switch setting other than 0 through 4 selects the reproduce and interpret option (same as 2).

8. Press console START (or appropriate HALT/RESET key if you have DPF). The selected program option is performed. Cards from the primary hopper go to stacker 1 (nearest the hoppers). Cards from the secondary hopper go to stacker 4. If any reformat data cards are present, they go to stacker 2. When two consecutive end-of-file (/\*) cards are read, the system halts with 52 in the message display unit.
9. If there are no more reproduce and interpret jobs to run, set the rightmost address/data switch at 2. If more reproduce and interpret jobs are to be run, follow the steps under *Restart Procedure*.
10. Press console START (or appropriate HALT/RESET key if you have DPF).
11. When system halts with EJ in the message display unit, clear cards from MFCU.

#### **Restart Procedure**

1. Set rightmost address/data switch at 1.
2. Press console START (or appropriate HALT/RESET key if you have DPF). The message display unit changes to CU.
3. Place cards needed for this run in proper hoppers of MFCU—if they are not already there—and ready MFCU.
4. Repeat operating procedure starting at step 7.



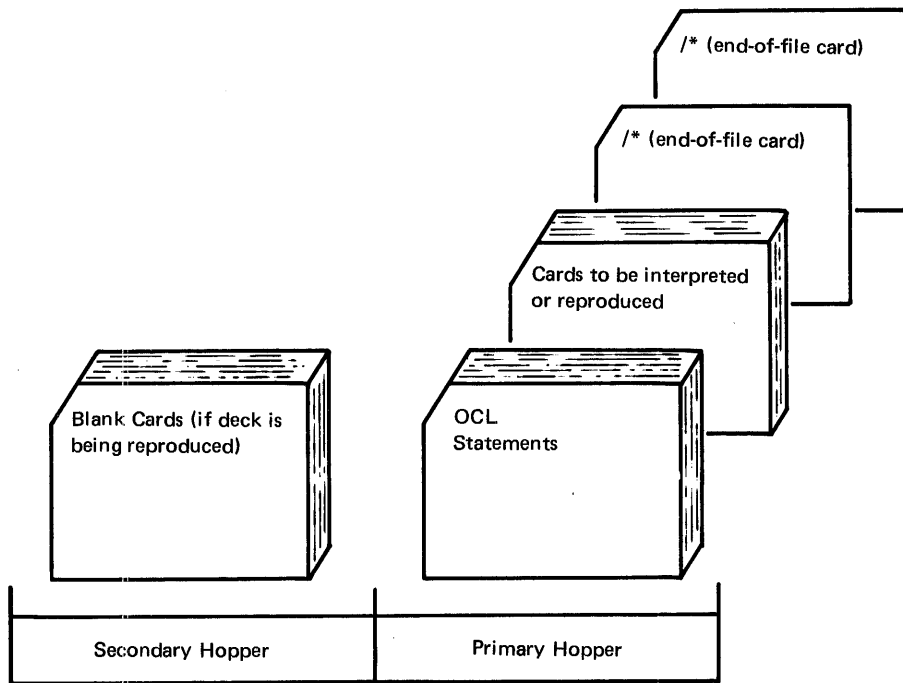

Figure 25. Input Deck for Reproduce or Interpret Without Reformatting

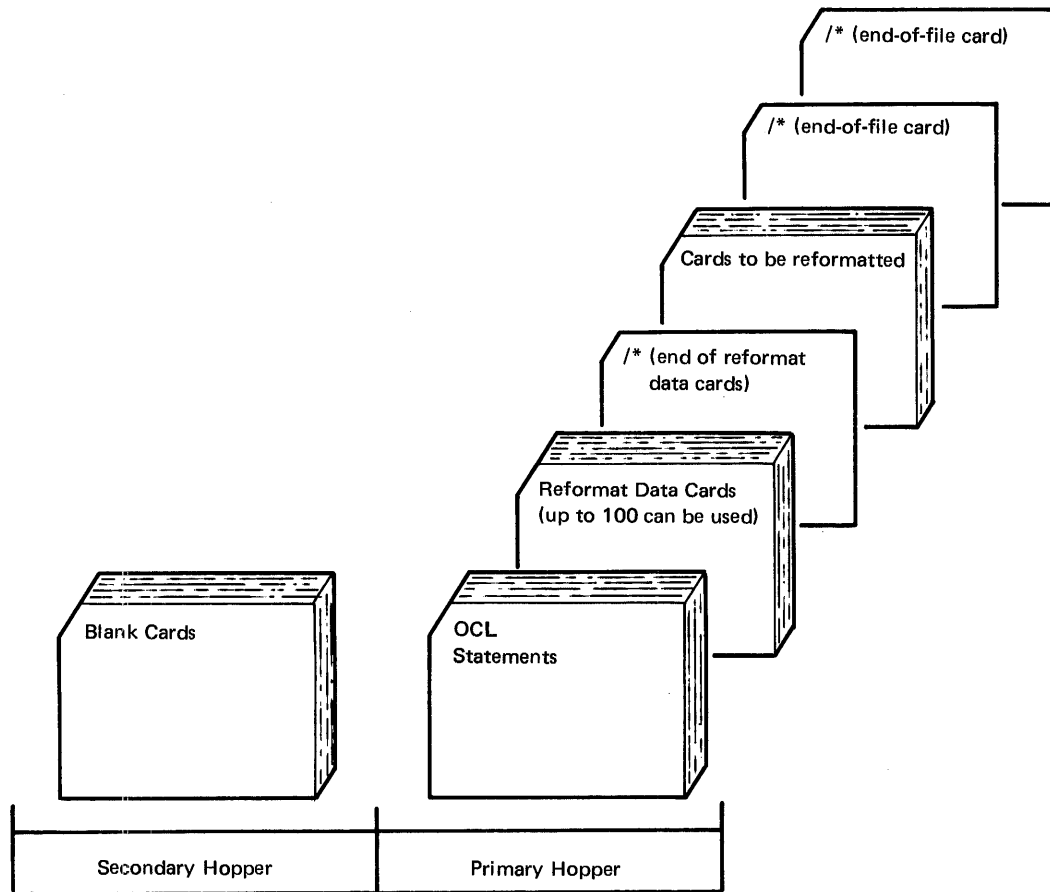

Figure 26. Input Deck for Reformatting.

## Reformat Data Card

If reformatting is needed, reformat data cards must be punched to indicate the format of the new deck.

A reformat unit of six card columns is required to reformat a field. Up to 100 reformat units can be used. (A field is one or more columns on a card that contains the same or related information.) Several reformat units may be placed on one card or each unit can be placed on a separate card.

Figure 27 shows the format of a reformat data card. When reformatting is specified, all cards are reformatted except those with a /\* in columns 1 and 2; these cards are reproduced in their original format.

1	2	3	4	5	6	7	8	9	10
0	1	0	4	0	8				
a	a	b	b	c	c				
These six columns make one reformat unit									
A field beginning in column 01 (aa)		and ending in column 04 (bb) is being reproduced.				It will be reformatted so that in the new deck it will end in column 08 (cc). Therefore, the reformatted field will begin in column 05 in the new deck.			

Figure 27. Reformat Data Card Format.

## Examples

**Moving Fields:** In this example, we want to switch fields 1 and 2. The deck to be reformatted is:

```
Card Column  1 2 3 4 5 6 7 8 9 10 11 12
              F I E L D 2 F I E L D 1
```

The reformat data card that will cause Fields 1 and 2 to be switched in the new deck is shown in Figure 28. The format of the new deck is:

```
Card Column  1 2 3 4 5 6 7 8 9 10 11 12
              F I E L D 1 F I E L D 2
```

**Deleting a Field:** In this example, we want to delete Field 6. The deck to be reformatted is:

```
Card
Column  51 52 53 54 55 56 57 58 59 60 61 62 63 64 65 66 67 68
        F I E L D 5 F I E L D 6 F I E L D 7
```

The reformat data card needed to punch a deck that does not contain Field 6 is shown in Figure 29. Columns 57-62 (Field 6) are not punched on the new cards because these columns are not included in the reformat data card. The format of the new deck is:

```
Card
Column  51 52 53 54 55 56 57 58 59 60 61 62 63 64 65 66 67 68
        F I E L D 5                               F I E L D 7
```

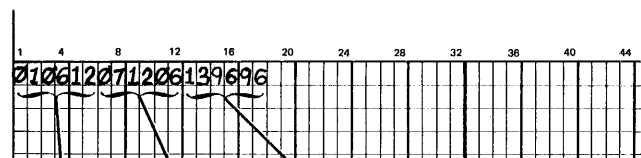

The field from columns 1-6 is punched in columns 7-12 in the new cards.

The field from columns 7-12 is punched in columns 1-6 in the new cards.

The remainder of the data fields are punched in their original position in the new cards.

Figure 28. Reformat Data Card: Moving Fields.

0	1	5	6	5	6	6	3	9	6	9	6								
a	a	b	b	c	c	a	a	b	b	c	c								
All fields from columns 1-56 are punched in the same position in the new cards.						All fields from columns 63-96 are punched in the same position in the new cards.													

Figure 29. Reformat Data Card: Deleting a Field.

For more information on Reproduce and Interpret, see the *IBM System/3 Disk System Card Utilities Reference Manual*, SC21-7529.

## MFCU SORT/COLLATE PROGRAM

The following steps are required for all sort/collate jobs.

1. Mount disk cartridge if specified on program run sheet, and ready disks.
2. Clear cards from MFCU.
3. Place OCL cards in primary hopper of MFCU. Load cards face down, top edge to the left.
4. Place sort specification cards in secondary hopper of MFCU. Figure 30 shows the input for sort/collate without alternate collating. Figure 31 shows the input for sort/collate with alternate collating.
5. Press MFCU START. PRIMARY READY and SECONDARY READY lights will turn on.
6. Ready printer.
7. Press console START (or appropriate HALT/RESET key if you have DPF) to load the program. When the program is loaded, it reads specifications cards and lists them on the logging device.

The system halts with one of the following values displayed in the message display unit:

- EE (ready to go halt). This halt signifies that the program is successfully loaded. Read the operating procedure for the job you are doing for further instructions.
- EL (conditional halt). Check message on logging device to determine cause (all sort/collate messages are described in Appendix B). Set rightmost address/data switch at 0 and press console START (or appropriate HALT/RESET key if you have DPF) to continue. The message display unit changes to EE. Read the operating procedure for the job you are doing for further instructions.
- EA (terminal halt). This halt indicates that something is wrong with the specification deck. Check printout to determine cause of error. Set rightmost address/data switch at 3 and press console START (or appropriate HALT/RESET key if you have DPF) to cancel job. The sort/collate program must be reloaded after the error is corrected. If the message display unit contains a display other than EE, EL, or EA, check the list of program halts in the *IBM System/3 Disk System Halt Procedure Guide*, GC21-7540.

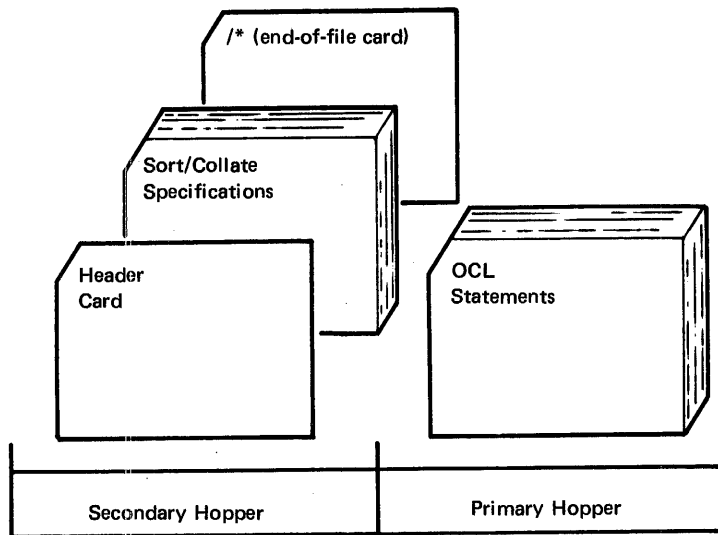

Figure 30. Input for Sort/Collate Without Alternate Collate Cards.

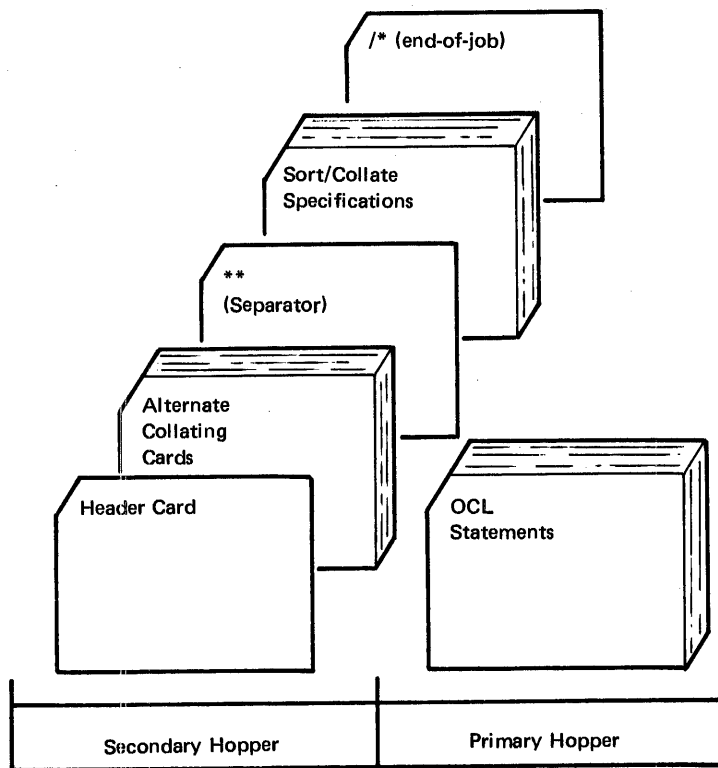

Figure 31. Input for Sort/Collate with Alternate Collate Cards.

## Sort Operating Procedure

A complete file can be sorted or a file can be sorted after selected card types are removed. The first method is a simple sort; the second is a sort with omits.

### Sort (No Omits):

1. Clear cards from MFCU.
2. Divide card deck to be sorted. Place approximately one half of the card deck in the primary hopper of the MFCU and place the remaining cards in the secondary hopper.
3. Ensure that an end-of-file (/\*) card (if one is not there) is placed behind cards in each hopper. (Have two extra end-of-file cards available. These cards will save you time in the next pass of the program.)
4. Press MFCU START. The PRIMARY READY and SECONDARY READY lights turn on.
5. Set rightmost address/data switch at 0.
6. Press console START (or appropriate HALT/RESET key if you have DPF).
7. Cards are read in from both hoppers and selected into all four stackers. If a stacker fills before the hoppers empty, take cards from stacker and place them in bin above stacker. Press MFCU START to continue.
8. When the pass is completed, the system halts with EP in the message display unit. A message indicating the number of passes remaining to complete the sort is printed on the logging device.
9. Place cards from stacker 1 and stacker 2 (in that order) in the primary hopper (Figure 32). Place cards (if any) from the stacker-1 bin in the primary hopper before the cards in stacker 1. The same procedure applies for stacker 2.
10. Place cards from stacker 3 and stacker 4 (in that order) in the secondary hopper (Figure 32). Before you place cards from stacker 3 in the secondary hopper, place the cards in the stacker-3 bin, if any, in the secondary hopper. The same procedure applies for stacker 4.
11. Place end-of-file cards behind decks in both hoppers.
12. Press MFCU START.
13. Set rightmost address/data switch at 0.
14. Press console START (or appropriate HALT/RESET key if you have DPF).
15. The second pass of the sort is run and the system again halts with EP in the message display unit. Remove end-of-file cards from under the cards in stacker 1 and 3. You will use these cards in the next pass.
16. Repeat steps 9-15 until all cards are routed into stacker 1 (the end-of-file card from the secondary hopper will be in stacker 3). At this time, the system halts with EJ in the message display unit. Press MECU NPRO key twice to run end-of-file cards out of unit. The sort is completed.

*Note:* If a halt other than EP or EJ occurs during the sort run, check list of program halts in the *IBM System/3 Disk System Halt Procedure Guide*, GC21-7540.

*Note:* If you forget to remove one of the end-of-file cards (\*) from under the cards in one of the stackers (step 15), you can save yourself an extra pass by performing the following:

1. Remove end-of-file cards from behind cards in both hoppers and let the pass continue.
2. Wait for I/O ATTENTION. One hopper is empty and the other hopper has cards in it. The cards remaining in the hopper are there because the system has read the misplaced end-of-file card and does not expect any more cards from that hopper, but is looking for more cards from the empty hopper.
3. Remove remaining cards from hopper and place them in empty hopper.
4. Place end-of-file card after cards in hopper.
5. Press MFCU START. The pass continues.

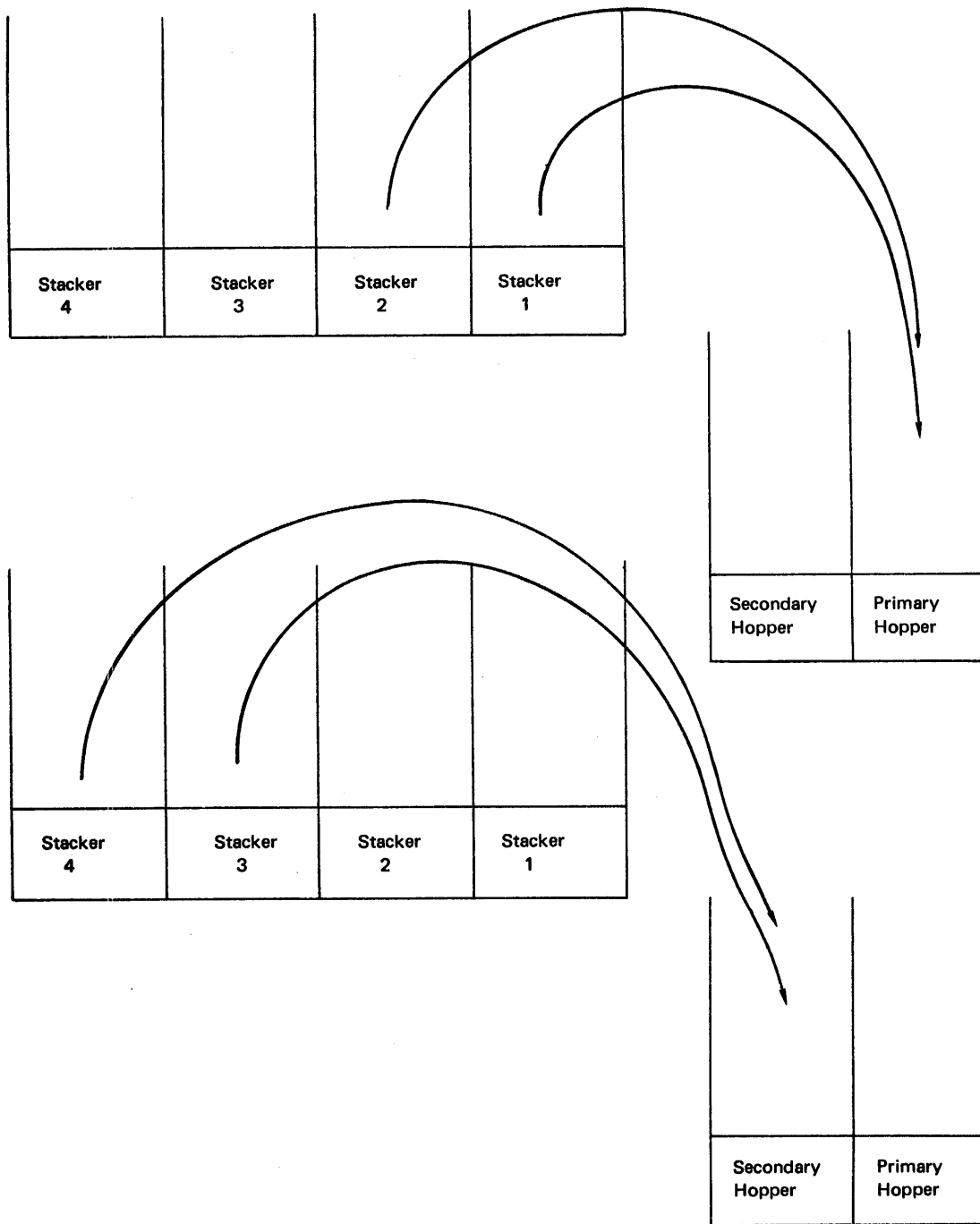

Figure 32. Stacker to Hopper Sequence During Sort. Don't forget any cards in bins. When the cards are sorted such that only stacker 1 and stacker 3 are used, place the cards in stacker 1 in the primary hopper; the cards in stacker 3 in the secondary hopper. When all cards being sorted are in stacker 1, the run is finished.

*Sort (With Omits):*

1. Clear cards from MFCU.
2. Divide card deck to be sorted. Place approximately one half of the card deck in the primary hopper of the MFCU and place the remaining cards in the secondary hopper.
3. Place an end-of-file (/\*) card (if one is not there) behind cards in each hopper. (Have two extra end-of-file cards available. These cards will save you time in the next pass of the program.)
4. Press MFCU START (or appropriate HALT/RESET key if you have DPF).

5. Set rightmost address/data switch at 0.

6. Press console START

7. Cards are read from both hoppers and selected into all four stackers.

If a stacker fills before hoppers empty, take cards from the stacker and place them in bin above stacker. Press MFCU START to continue.

8. When the pass is completed, the system halts with EO in the message display unit. A message indicating the number of passes remaining to complete the sort is printed on the logging device.

9. Take cards from stackers 2 and 4 and set them aside. These are the omitted cards.

10. Place any cards in bin above stacker 1 in primary hopper, then place cards from stacker 1 in primary hopper.

11. Place cards from stacker 3 in secondary hopper.
12. Place end-of-file cards behind decks in both hoppers.
13. Press MFCU START.
14. Set rightmost address/data switch at 0.
15. Press console START (or appropriate HALT/RESET key if you have DPF).
16. The second pass of the sort is run and the system halts with EP in the message display unit. Remove end-of-file cards from under the cards in stackers 1 and 3. You will use these cards in the next pass.
17. Do steps 8-16 of the Sort (No Omits) procedure.

*Note:* If you forget to remove one of the end-of-file cards (/\*) from under the cards in one of the stackers (step 16), you can save yourself an extra pass by doing the following:

1. Remove end-of-file cards from behind cards in both hoppers and let the pass continue.
2. Wait for I/O ATTENTION. One hopper is empty and the other hopper has cards in it. The cards remaining in the hopper are there because the system has read the misplaced end-of-file card and does not expect any more cards from that hopper, but is looking for more cards from the empty hopper.
3. Remove remaining cards from hopper and place them in empty hopper.
4. Place end-of-file card after cards in hopper.
5. Press MFCU START. The pass continues.



### *Merge*

Merge is a one-pass operation.

1. Clear cards from MFCU.
2. Place primary file in primary hopper.
3. Place secondary file in secondary hopper.
4. Press MFCU START. PRIMARY READY and SECONDARY READY lights turn on.
5. Set rightmost address/data switch at 0.
6. Press console START (or appropriate HALT/RESET key if you have DPF).
7. Cards are read in from both hoppers, merged, and routed to stacker 1.

A sequence error causes the system to halt with E1 (primary hopper) or E2 (secondary hopper) in the message display unit. The recovery procedures for these errors are included in the list of program halts in the *IBM System/3 Disk System Halt Procedure Guide*, GC21-7540. Any omit cards from the primary hopper go to stacker 2. Any omit cards from the secondary hopper go to stacker 4.

When the pass is complete, the system halts with EJ in the message display unit. If the message display unit contains a display other than EJ, check the list of program halts in the *IBM System/3 Disk System Halt Procedure Guide*, GC21-7540.

### *Match*

The program run sheet should indicate which type of output appears in which stacker.

1. Clear cards from MFCU.
2. Place primary file in primary hopper. The last card must be an end-of-file card.
3. Place secondary file in secondary hopper. The last card must be an end-of-file card.
4. Press MFCU START. PRIMARY READY and SECONDARY READY lights turn on.

5. Set rightmost address/data switch at 0.
6. Press console START (or appropriate HALT/RESET key if you have DPF).
7. Cards are routed to any or all stackers.

A sequence error causes the system to halt with E1 (primary hopper) or E2 (secondary hopper) in the message display unit. The recovery procedures for these errors are included in the list of program halts in the *IBM System/3 Disk System Halt Procedure Guide*, GC21-7540.

When the pass is completed, the system halts with EJ in the message display unit. If the message display unit contains a display other than EJ, check the list of program halts in the *IBM System/3 Disk System Halt Procedure Guide*, GC21-7540.

### *Select*

1. Clear cards from MFCU.
2. Place file in primary hopper. The last card must be an end-of-file card.
3. Press MFCU START. PRIMARY READY turns on.
4. Set rightmost address/data switch at 0.
5. Press console START (or appropriate HALT/RESET key if you have DPF).
6. Cards are routed to the stackers as follows:
  - Non-selected cards to stacker 4.
  - Selected cards to any or all of the remaining stackers (1, 2, and 3).

A sequence error in a sequenced file causes the system to halt with E1 in the message display unit. The recovery procedure for this error is in the list of program halts in the *IBM System/3 Disk System Halt Procedure Guide*, GC21-7540.

When the pass is completed, the system halts with EJ in the message display unit. If the message display unit contains a display other than EJ, check the list of program halts in the *IBM System/3 Disk System Halt Procedure Guide*, GC21-7540.

## DATA RECORDING PROGRAM

The data recording program enables you to use System/3 for recording data in punched cards, using the IBM 5475 Data Entry Keyboard. The following procedure is used for loading the data recording program into storage, allowing the data entry keyboard to be used for data recording. For more information on the data recording program and the data entry keyboard, see the *IBM System/3 Disk System Card Utilities Reference Manual*, SC21-7529.

### Program Load Procedure

1. Mount disk cartridge as specified on Program Run Sheet, if any, and ready disks.
2. Remove cards from both hoppers of MFCU.
3. Clear cards from MFCU.
4. Remove any cards from stackers.
5. Place OCL statements in primary hopper of MFCU. Load cards face down, top edge to the left.
6. Place cards to be punched in secondary hopper of MFCU. Load cards face down, top edge to the left.
7. Press MFCU START. PRIMARY READY and SECONDARY READY lights turn on.
8. Press console START (or appropriate HALT/RESET key if you have DPF).
9. When the column indicator on the keyboard panel comes on, showing 01, the program has been loaded. (If 01 does not light, check to make sure there are cards in the secondary hopper.)
10. When the column indicator shows 01, press MFCU STOP.
11. Press NPRO on the MFCU control panel once. (This removes the last card fed and stacks it in stacker 1.)
12. Press MFCU START. Data recording can now begin, unless program control cards are to be used.

A program control card causes specified functions to be performed automatically and must be loaded into storage before data recording can begin. For more information on the program control card and how to load it, see the *IBM System/3 Disk System Card Utilities Reference Manual*, SC21-7529.

## DATA VERIFYING PROGRAM

The Data Verifying program enables you to verify previously punched cards, using the IBM 5475 Data Entry Keyboard. The following procedure is used for loading the data verifying program into storage, allowing the data entry keyboard to be used for data verifying. For more information on the data verifying program and the data entry keyboard, see the *IBM System/3 Disk System Card Utilities Reference Manual*, SC21-7529.

### Program Load Procedure

1. Mount indicated disk cartridge as specified on Program Run Sheet, if any, and ready disks.
2. Remove cards from both hoppers of MFCU.
3. Clear cards from MFCU.
4. Remove any cards from stackers.
5. Place OCL statements in primary hopper of MFCU. Load cards face down, top edge to the left.
6. Place punched cards to be verified, followed by a blank card, in the secondary hopper. Load cards face down, top edge to the left.
7. Press MFCU START. PRIMARY READY and SECONDARY READY lights turn on.
8. Press console START (or appropriate HALT/RESET key if you have DPF).
9. When the column indicator on the keyboard panel comes on, showing 01, the system is ready for data verifying.
10. When the column indicator shows 01, press MFCU STOP.
11. Press MFCU NPRO and remove cards from stacker 1.
12. Press MFCU START. Data verifying can now begin, unless program control cards are to be used.

A program control card causes specified functions to be performed automatically and must be loaded into storage before data recording can begin. For more information on the program control card and how to load it, see the *IBM System/3 Disk System Card Utilities Reference Manual*, SC21-7529.

## DISK SORT PROGRAM

1. Mount disk cartridge as specified on program run sheet and ready disks.
2. Clear cards from MFCU.
3. Place OCL statement and sort specification deck (Figure 33) in the primary hopper of the MFCU. Place cards face down, top edge to the left. (For some disk sort programs only OCL statements are necessary to run the job.)
4. Press MFCU START. The PRIMARY READY light turns on.
5. Ready printer.
6. Press console START (or appropriate HALT/RESET key if you have DPF). Various program halts can occur while the disk sort program is running. See the *IBM System/3 Disk System Halt Procedure Guide*, GC21-7540, for the action you are to take. When the job is complete, EJ is displayed on the message display unit.

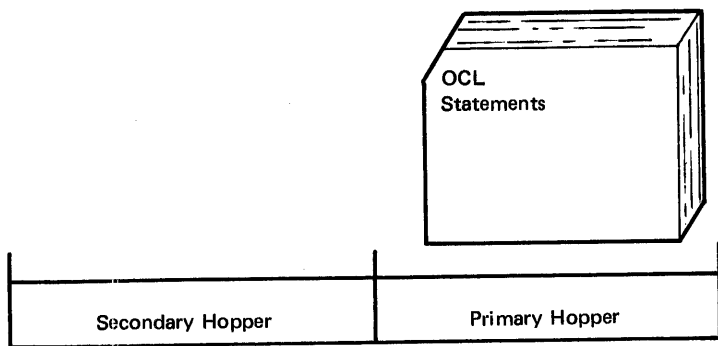

All sort specifications are in a procedure on disk. Only OCL statements are required to run the job.

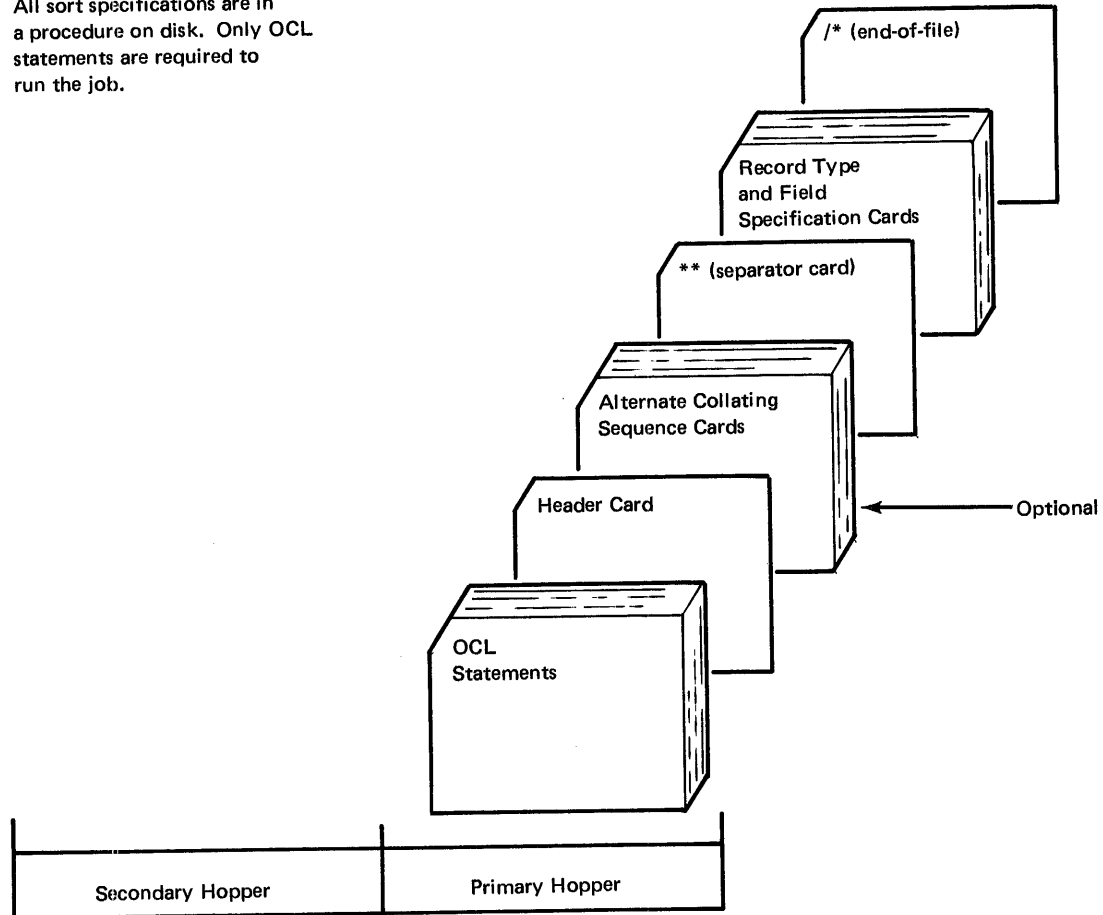

The sort specifications are on cards and follow the OCL statements.

● Figure 33. Possible Input for Disk Sort.

## BASIC ASSEMBLER PROGRAM

1. Mount disk cartridge as specified on program run sheet, and ready disks.
  2. Clear cards from MFCU.
  3. Place OCL statements and assembler source deck (Figure 34) in the primary hopper of the MFCU.
  4. The assembler program can punch an object deck if requested. This should be indicated to you on the program run sheet. If an object deck will be punched, place blank cards in the secondary hopper of the MFCU.
  5. Press MFCU START. PRIMARY READY turns on. SECONDARY READY turns on if blank cards are in the secondary hopper.
  6. Ready printer.
  7. Press console START (or appropriate HALT/RESET if you have DPF)
- See the *IBM System/3 Disk System Halt Procedure Guide*, GC21-7540 for recovery procedures if program halts are displayed on the message display unit.
8. When the job is complete, EJ is displayed on the message display unit.
  9. Punched cards, if any, will be in stacker 3 of the MFCU. The OCL statements and assembler source deck will be in stacker 1.

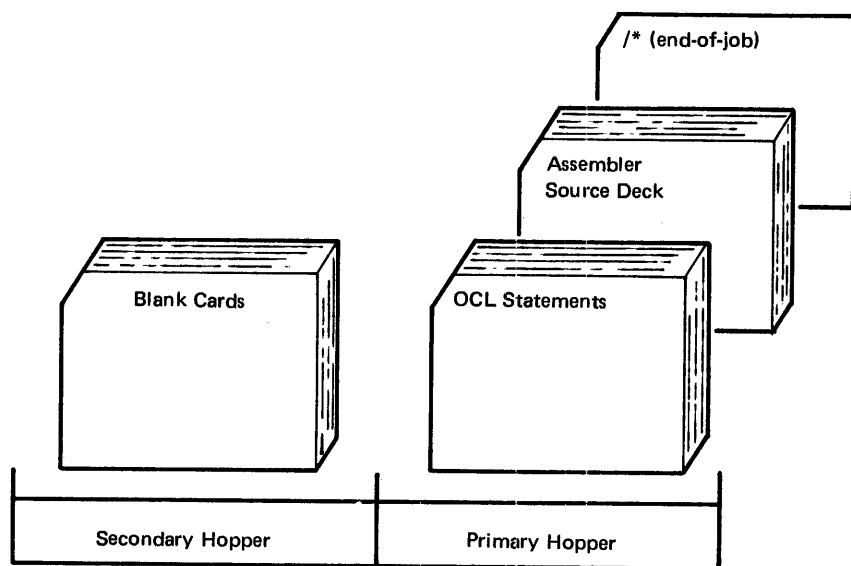
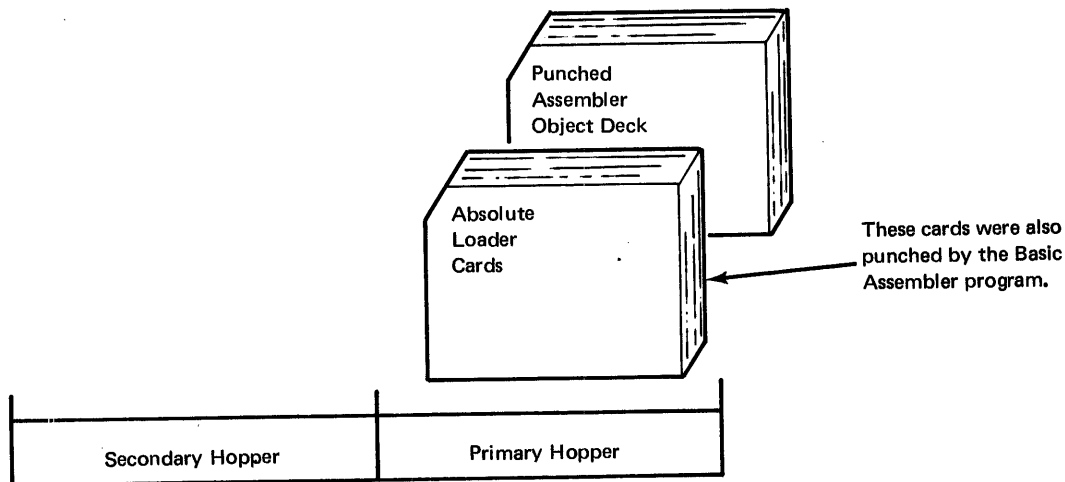

Figure 34. Input for Basic Assembler Program.

### Execution of a Basic Assembler Object Program

1. Clear cards from MFCU.
2. Place punched absolute loader cards and object deck (Figure 35) in primary hopper of MFCU. Load cards face down, top edge to the left.
3. Press MFCU START. PRIMARY READY light turns on. If cards are in the secondary hopper, the SECONDARY READY turns on.
4. Ready printer.
5. Set program load selector at MFCU.
6. Press console PROGRAM LOAD. The object program is loaded and execution begins.
7. Perform the IPL process after execution of the Basic Assembly object program is complete.

During the execution of the object program, halts can occur. These halts are not necessarily related to the halts described in the *IBM System/3 Disk System Halt Procedure Guide*, GC21-7540, because the programmer can use any halts desired. Also, the halt indicating that the object program is complete does not have to be EJ. The program run sheet, supplied to you by the programmer, indicates the halts that will occur and the action you should take.



● Figure 35. Input for Basic Assembler Object Program Execution.

## DISK UTILITY PROGRAMS

Your resident system includes a group of disk utility programs. These programs do a variety of jobs, from preparing disks for use to adding new or changed programs to the system. The utility programs are:

- **Disk Initialization**—prepares a disk for use. This program must be run for each new disk that is used for the first time or when the contents of a disk can be erased.
- **Alternate Track Assignment**—assigns alternate tracks to disk tracks that become defective after they are initialized. The data on the defective track is transferred to the alternate track.
- **Alternate Track Rebuild**—corrects data that could not be transferred to an alternate track or was transferred in error.
- **File and Volume Label**—prints the contents of an area on disk called the volume table of contents (VTOC). This area contains information on all data files (groups of related records) on disk.
- **File Delete**—deletes files on disk by modifying the VTOC indicating the files no longer needed.
- **Disk Copy/Dump**—copies the contents of one disk to another, copies a data file from one disk to another, copies a data file from one location to another on the same disk, and prints the contents of a data file.
- **Library Maintenance**—builds, maintains, and services disk resident source and object libraries.

The source library is an area on disk used to store procedures and source statements. Procedures are groups of OCL statements that are used to run a particular program. The object library is an area on disk used to store executable programs and subroutines. The system programs are stored in an object library.

Each utility program to be run has OCL statements followed by control statements. The OCL statements consist of a LOAD statement, in some cases one or more FILE statements, and a RUN statement. The LOAD statement has the name of the utility program to be run. The FILE statement provides the system with information about groups of related records called files. The RUN statement tells the utility program to begin.

Control statements follow the OCL statements. These control statements are read by the utility program. They tell the utility program what to do. The last statement of the control statements is a // END card. This statement tells the utility that there are no more control statements.

For more information on the utility programs and their OCL and control statements, see the *IBM System/3 Disk System Operation Control Language and Disk Utilities Reference Manual*, GC21-7512.

### Operating Procedures

Operating procedures for the utility programs are the same, except for the disk copy/dump and library maintenance programs. Procedures for Disk Copy/Dump and Library Maintenance are discussed later in this section.

#### *Operating Procedures for all Utility Programs but Disk Copy/Dump and Library Maintenance*

1. Mount disk cartridge if specified on program run sheet, and ready disks.
2. Clear cards from MFCU.
3. Place OCL statements and control statements in primary hopper of MFCU (Figure 36).
4. Press MFCU START. The PRIMARY READY light comes on.
5. Ready the printer.
6. Press console START (or appropriate HALT/RESET key if you have DPF). The utility program performs the functions indicated on the control statements. An EJ halt appears on the message display unit when the utility program is completed.

See the *IBM System/3 Disk System Halt Procedure Guide*, GC21-7540, for other programmed halts and how to recover from them.



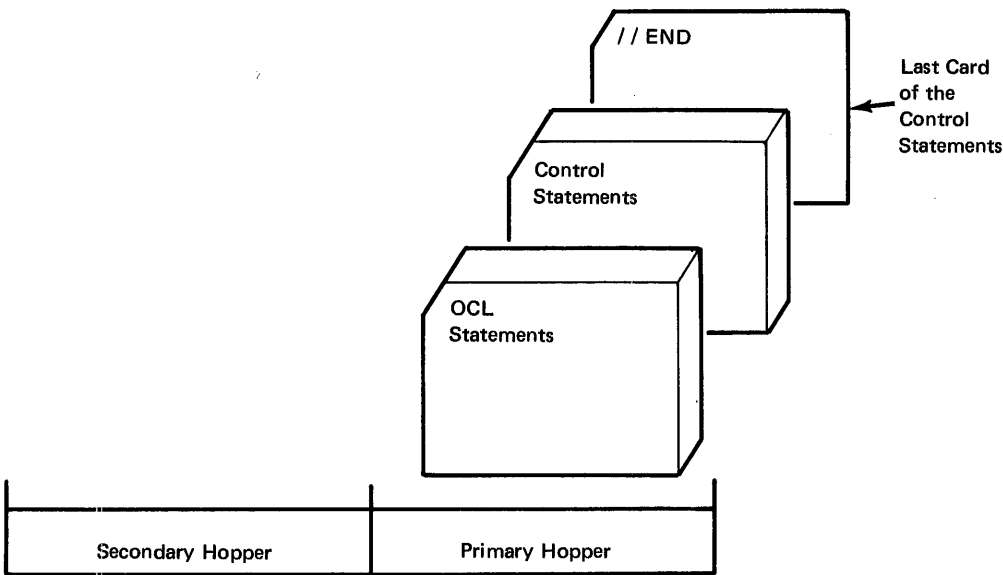

● Figure 36. Input for All Disk Utility Programs.

*Operating Procedures for Disk Copy/Dump Utility Program*

Operating procedures for disk copy/dump are the same as for the other utility programs except when you have to mount several different cartridges on the same drive during the running of the program. The program run sheet indicates when this type of disk copy/dump program will be run.

1. Mount disk cartridge if specified on program run sheet, and ready disks.
2. Clear cards from MFCU.
3. Place OCL statements and control statements in the primary hopper of the MFCU.
4. Press MFCU START. PRIMARY READY comes on.
5. Ready the printer.
6. Press console START (or appropriate HALT/RESET key if you have DPF).

For a particular type of disk copy/dump program you will have to mount several different cartridges. Program halts indicate when it is time to do this. This particular form of program works as follows:

The program is going to copy data from one removable disk on R1 to another removable disk on R1. This kind of operation requires that you mount different cartridges at different times:

1. The preceding steps 1 through 6 have been performed. You have mounted the proper cartridge on R1.
2. After the program has copied data to the fixed disk, a program halt of 37 will occur. At that time you must mount the cartridge the program is going to copy the data onto. Keep the cartridge you removed handy, you will have to mount it again in step 5.
3. Set rightmost address/data switch at 0.
4. Press console START (or appropriate HALT/RESET key if you have DPF). If you mounted the wrong cartridge, a halt of 38 will occur. To correct this, mount the correct cartridge, set rightmost address/data switch at 0, and press console START (or appropriate HALT/RESET key if you have DPF).
5. When the data has been copied, another program halt of 37 will occur. At this time you must remount the cartridge you previously removed.
6. Set rightmost address/data switch at 0.
7. Press console START (or appropriate HALT/RESET key if you have DPF).
8. Perform steps 2 through 5 as many times as necessary to get all the data copied onto the removable cartridge.
9. When the utility program is completed, EJ is displayed in the message display unit.

### Operating Procedures for Library Maintenance Utility Program

The library maintenance utility program can create, delete, reorganize or change the size of a library, copy data, read from cards to a library (Figure 37), punch data on cards (Figure 38), and print data on the printer from data in a library. The type of library maintenance utility program being run will be indicated on the program run sheet.

The following operating procedures cover all of these possibilities:

1. Mount disk cartridge as specified on program run sheet and ready disks.
2. Clear cards from MFCU.
3. Place OCL statements, control statements, and data cards (if any) in the primary hopper of the MFCU. Place cards face down, top edge to the left.

4. Place blank cards in secondary hopper of MFCU, if specified on the program run sheet.
5. Press MFCU START. PRIMARY READY turns on. SECONDARY READY turns on if cards are in the secondary hopper.
6. Ready the printer.
7. Press console START (or appropriate HALT/RESET key if you have DPF).
8. Halt EJ is displayed when the job is completed.
9. Any cards punched by this particular library maintenance utility program are deposited in stacker 4. Remove them from the stacker.

If any program halts occur while the utility program is running, see the *IBM System/3 Disk System Halt Procedure Guide*, GC21-7540, for recovery procedures.

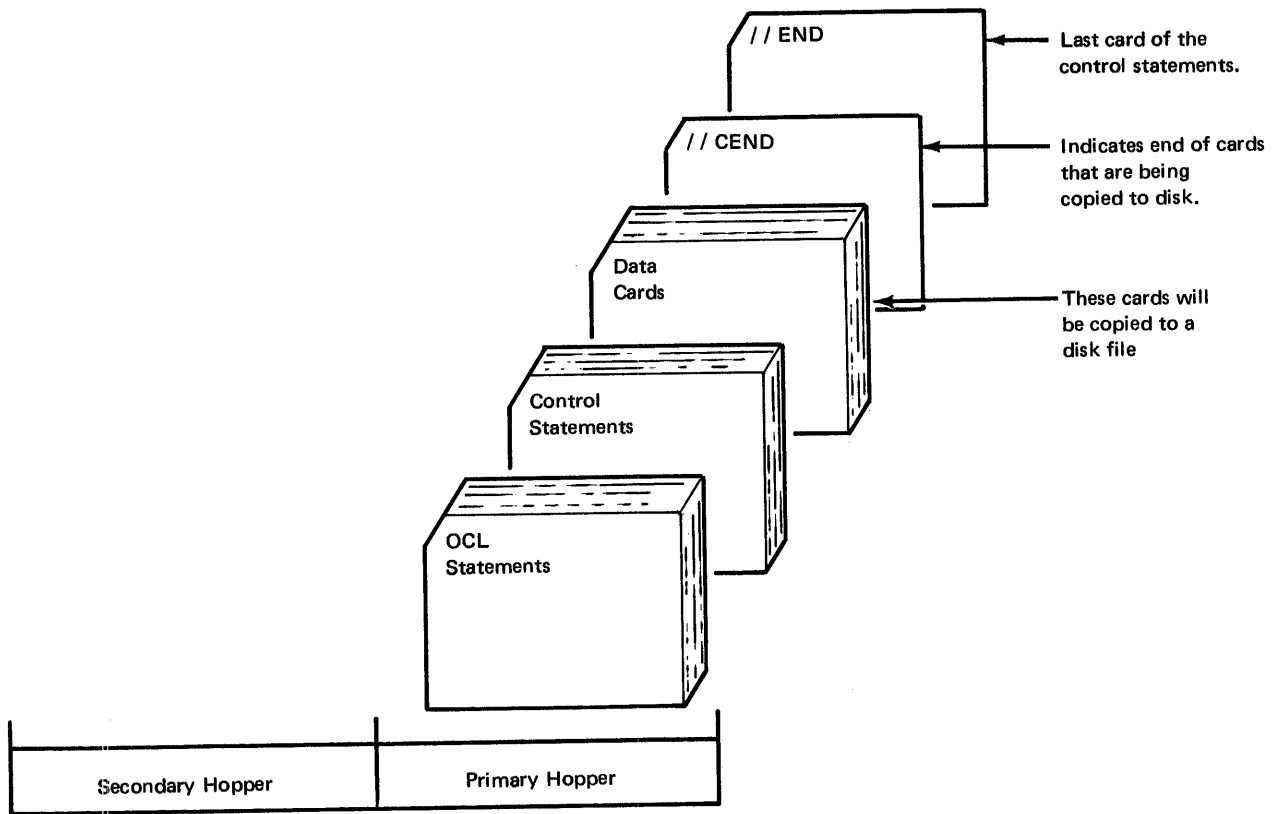
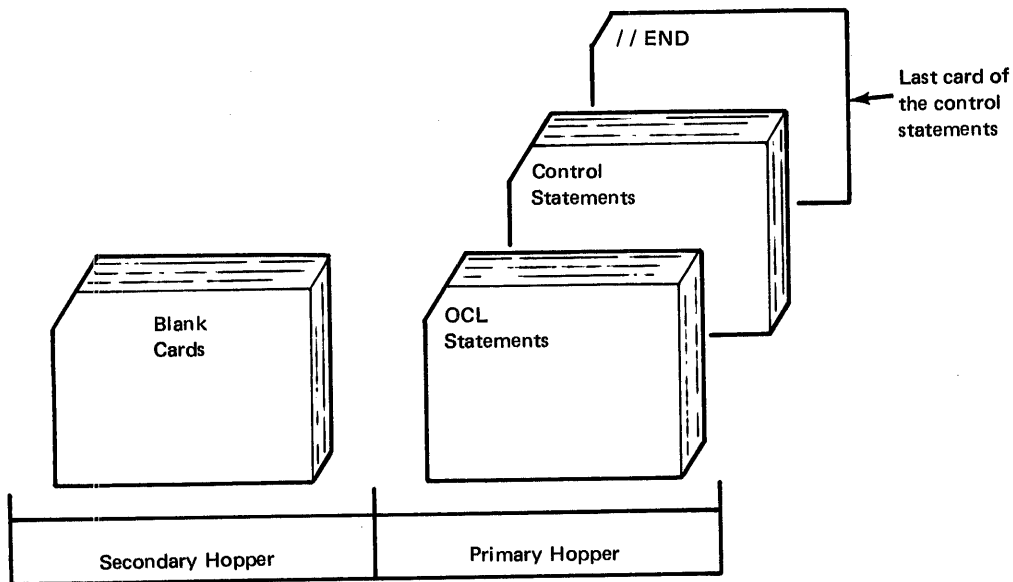

Figure 37. Input for Library Maintenance Utility Program That Copies Data from Cards to a Disk File.



● Figure 38. Input for Library Maintenance Utility Program That will Punch Cards.



- System Generation Procedures

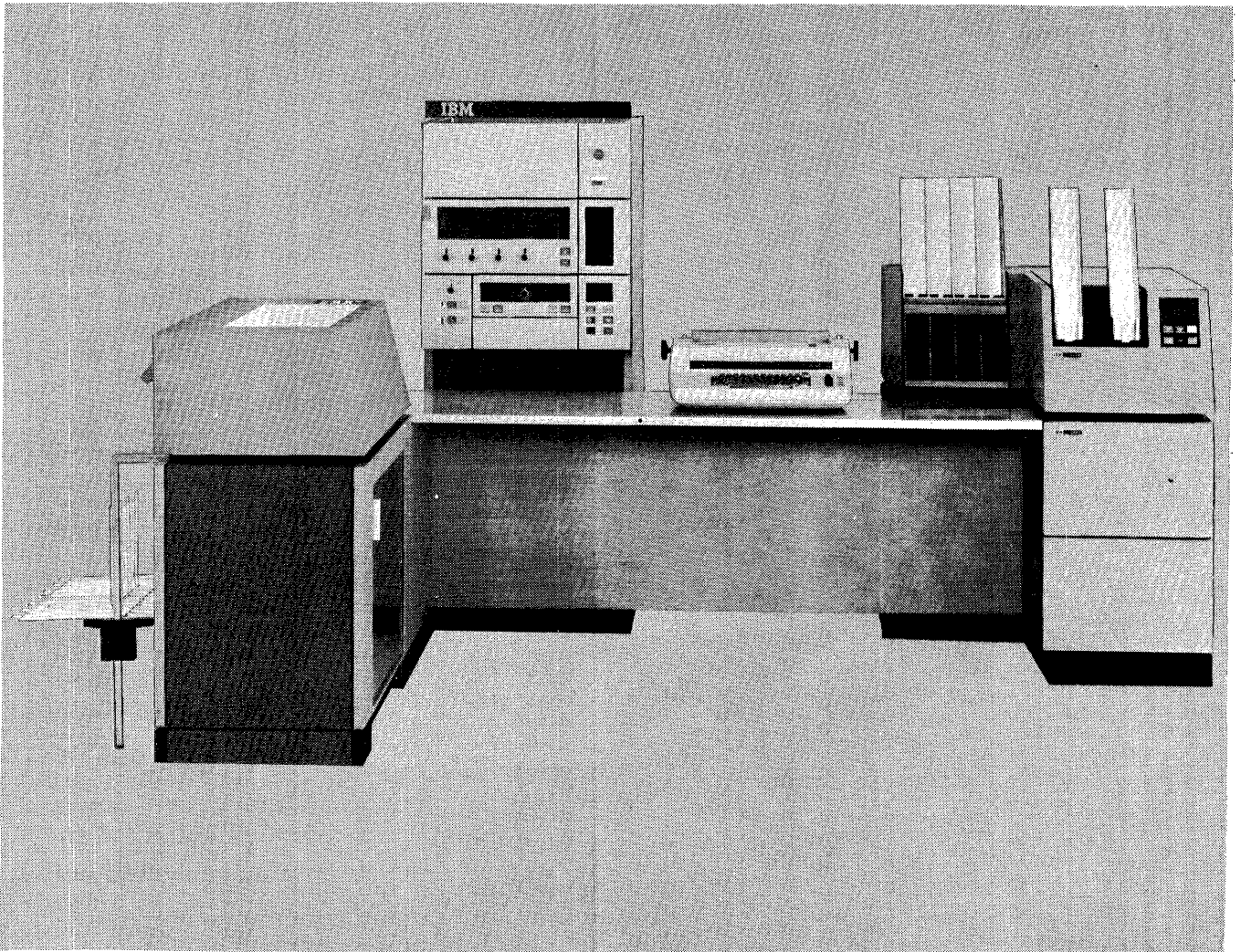

55239A

## SYSTEM GENERATION PROCEDURES

System/3 must have all the programs on disk needed to perform your everyday jobs. These disk programs are called a resident system. System generation is the process by which your resident system is built and placed on disk.

System generation must be performed when:

- You first receive System/3.
- You add new devices to System/3.
- Changes to existing programs are extensive enough to merit performing system generation.

Your installation has a distribution disk cartridge that contains a system generation program, system control programs (SCP), and program products (PP). Program products may also be on separate disk cartridges. The system generation program is used to define your system configuration and build your system. System control programs control operation of System/3. They are generated by the system generation program according to your system configuration. Program products (such as RPG II, Disk Sort, Card Utilities, and Basic Assembler) are special programs you may use in your installation. These programs will be included in the system generation procedure when generating your system.

A program pack contains one or more program products and, if you desire, a minimal system.

Program packs may be built anytime after the completion of system generation. There are several reasons for building program packs. One, if you have 100 cylinder disks there may not be enough room on one pack for a system and all of your program products. Another, you may prefer to have more file space on the system pack.

System generation is divided into six functions:

1. Preparing for system generation.
2. Backing up your resident system (when performing system generation after the first time).
3. System control program generation.
4. Program product generation.
5. Completing system generation.
6. Building a program pack.

## Preparing for System Generation

1. Punch the following cards:

1	4	8	12	16	20	24	28	32	36	40	44
//	DATE	00/00/00									
//	CALL	BSGPCH,R1									
//	RUN										

2. If the printer has the standard 48-character chain, go to step 4.
3. If a printer chain other than the standard 48-character chain is used, an IMAGE statement and data cards reflecting the characters on the chain must be prepared. See Appendix A for information on how to do this. This has to be done because the system generation program assumes a standard 48-character chain is mounted.  
  
Place the IMAGE statement and data cards between the DATE and CALL statements you punched in step 1. The IMAGE statement causes the characters on the data cards representing the characters on the printer chain to be stored in the chain-image area. This chain-image will become part of your generated system.
4. Set console power switch at ON.
5. Remove any cards from MFCU hoppers.
6. Press MFCU NPRO twice. This ensures that the card paths are clear.
7. Remove any cards from MFCU stackers.
8. Place forms in printer and press printer START.

The cards needed to initiate system generation are prepared and the system is ready to perform system generation. During system generation, halts can occur. For information on how to recover from the halts, see the *IBM System/3 Disk System Halt Procedure Guide*, GC21-7540.

## Backing Up Your Resident System

*Note:* If you are performing system generation for the first time, proceed to *System Control Program (SCP) Generation*.

### *Initializing a Scratch Disk Cartridge to Which Your Resident System is Copied*

1. Mount a scratch disk cartridge (a cartridge that has not been used or a cartridge that can be reused) on R1.
2. Ready disks.
3. Prepare a current DATE statement.
4. If the scratch disk cartridge is not initialized (made ready for use by the system) it must be initialized. Prepare the OCL and control statements needed to initialize the scratch disk cartridge. For information on how to prepare the statements, see the *IBM System/3 Disk System Operation Control Language and Disk Utilities Reference Manual*, GC21-7512.
5. Place OCL and control statements in primary hopper of MFCU. The DATE statement must be first.
6. Press MFCU START.
7. Set program load selector at FIXED DISK.

8. Press PROGRAM LOAD. Initial program loading is performed and, when complete, the system begins reading cards from the MFCU.

If your system has DPF, EJ is displayed in both message display units when initial program loading is complete. Press appropriate HALT/RESET key to continue.

Scratch disk cartridge on R1 is initialized when EJ is displayed in the message display unit. You can now copy your resident system from F1 to R1.

### *Copying Your Resident System from F1 to R1:*

1. Punch these statements:

1	4	8	12	16	20	24	28	32	36	40	44
/	/	/	LOAD	8	COPY,	F1					
/	/	/	RUN								
/	/	/	COPYPACK		FROM-F1,	TO-R1					
/	/	/	END								

2. Place OCL and control statements in primary hopper of MFCU.
3. Press MFCU START.
4. Press console START (program 1 HALT/RESET key if you have DPF).

When EJ is displayed in the message display unit, your resident system on F1 is copied on R1. This is your backup disk cartridge. You can now perform system control program generation.

## System Control Program (SCP) Generation

### *Punching the System Generation Instruction Cards from the Distribution Disk Cartridge*

1. Mount distribution disk cartridge for system generation on R1 and ready disks.
2. Place cards punched in *Preparing for System Generation* in primary hopper of MFCU. Load cards face down, top edge to the left.
3. Place blank cards in secondary hopper of MFCU.
4. Press MFCU START. PRIMARY READY and SECONDARY READY lights turn on.
5. Ready printer.
6. Set program load selector at REMOVABLE DISK.
7. Press PROGRAM LOAD. Initial program loading is performed and, when complete, the system begins reading cards from the MFCU.

*Note:* If you are using a printer chain other than the standard 48-character chain set, the DATE, IMAGE, and data cards are not printable. A halt of 7P is displayed in the message display unit. This halt occurs to ensure that you have the correct printer chain mounted. If the correct printer chain is not mounted, mount it at this time. After ensuring the correct printer chain is mounted, press console START (program 1 HALT/RESET key if you have DPF) to continue with system generation.

8. A halt of 91 is displayed in the message display unit. This halt is provided to give you time to read the instructions printed on the printer.
9. After reading the instructions, set rightmost address/data switch on console at 0.
10. Press console START (program 1 HALT/RESET key if you have DPF). System generation continues.

When the EJ halt is displayed on the message display unit, a deck of punched cards (Figure 39) will be in stacker 4 of the MFCU, and a listing of the punched cards will be printed on the printer. The deck of punched cards is used to continue with system generation. You can now initialize F1.



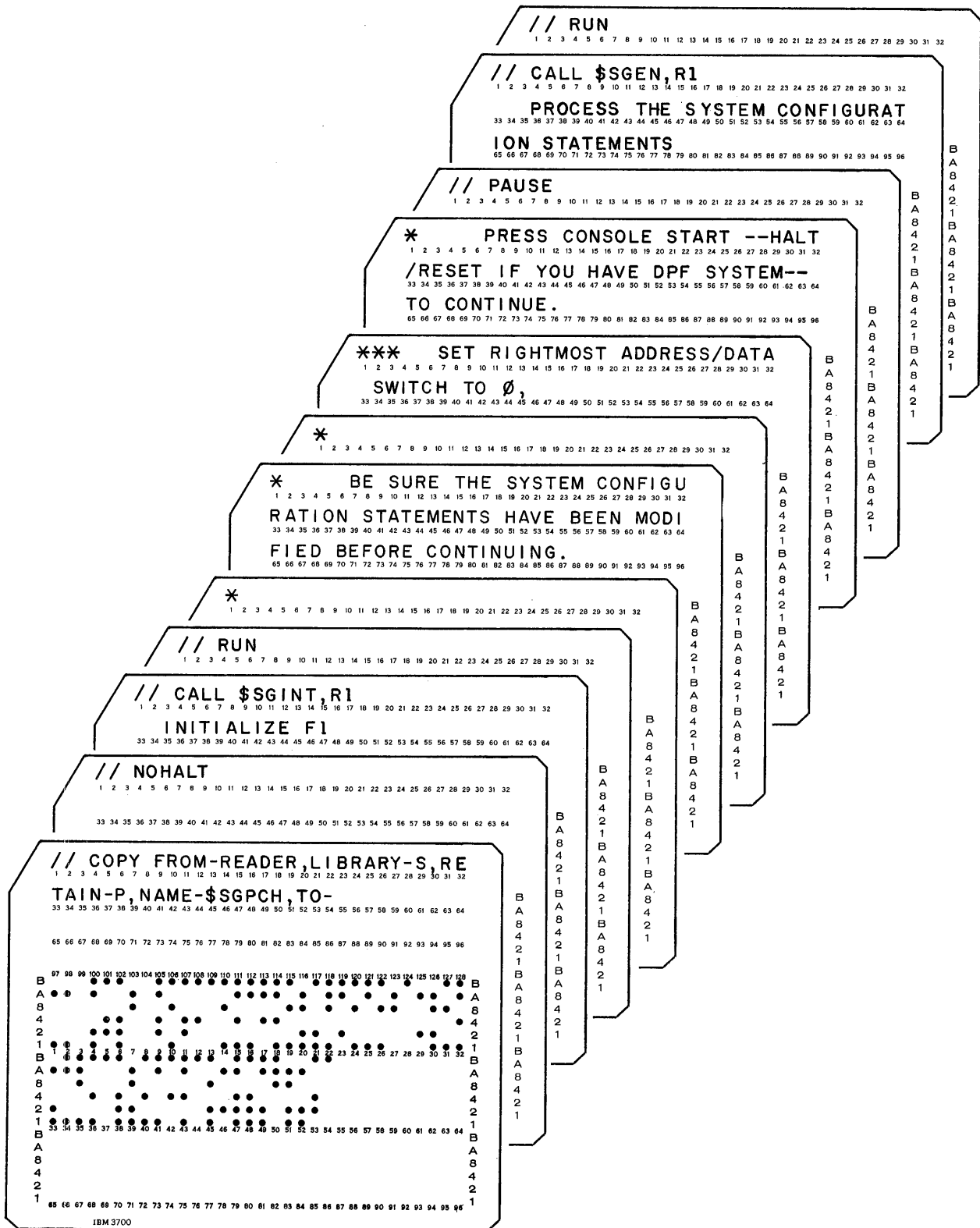

Figure 39. Punched Cards for SCP Generation (Part 1 of 6)

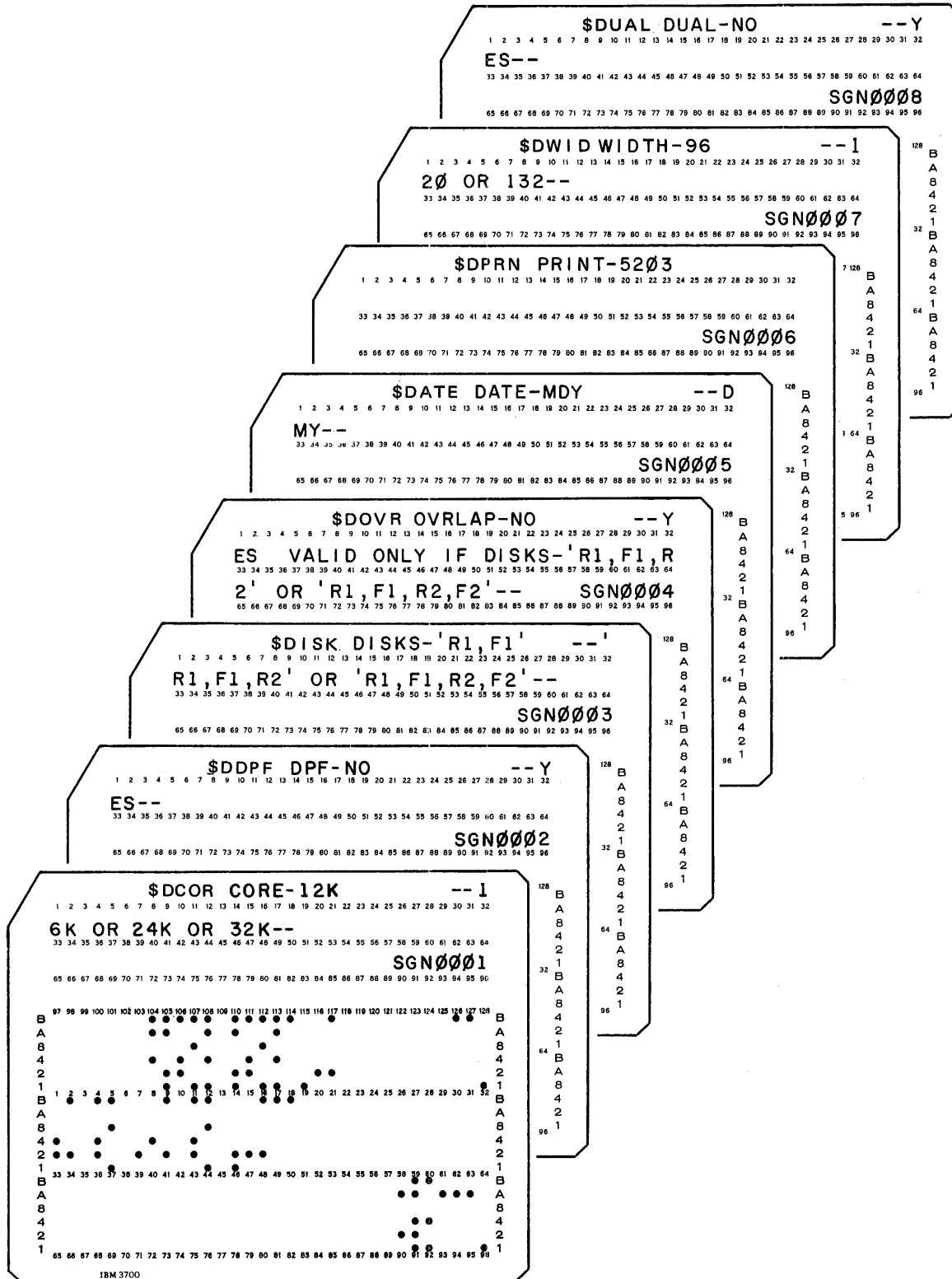

Figure 39. Punched Cards for SCP Generation (Part 2 of 6)

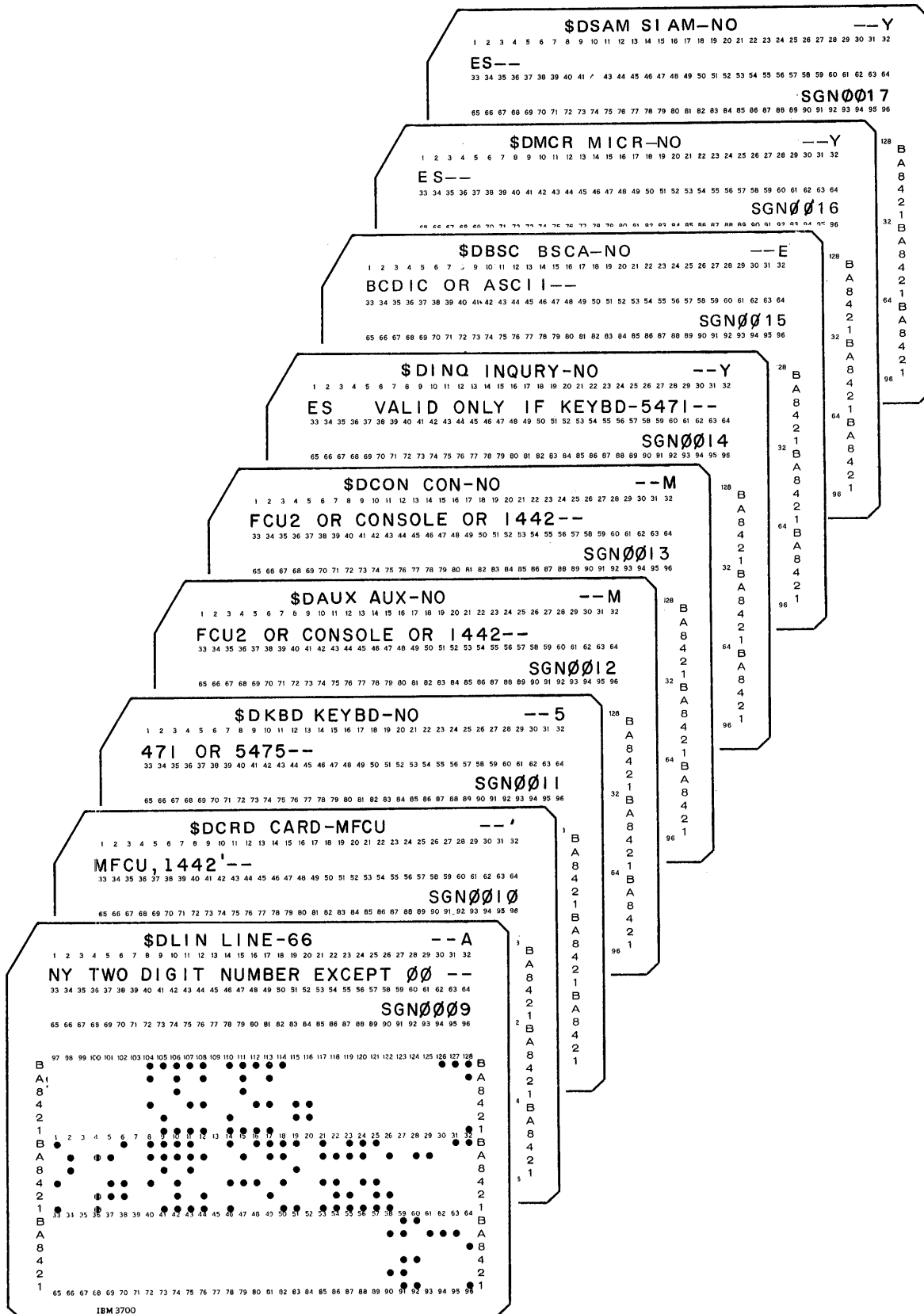

Figure 39. Punched Cards for SCP Generation (Part 3 of 6)

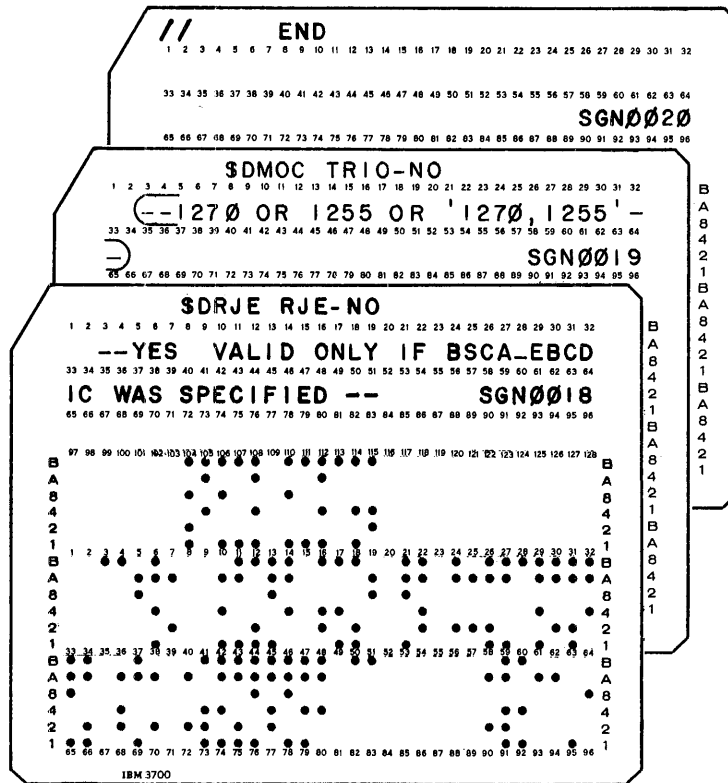

Figure 39. Punched Cards for SCP Generation (Part 4 of 6)

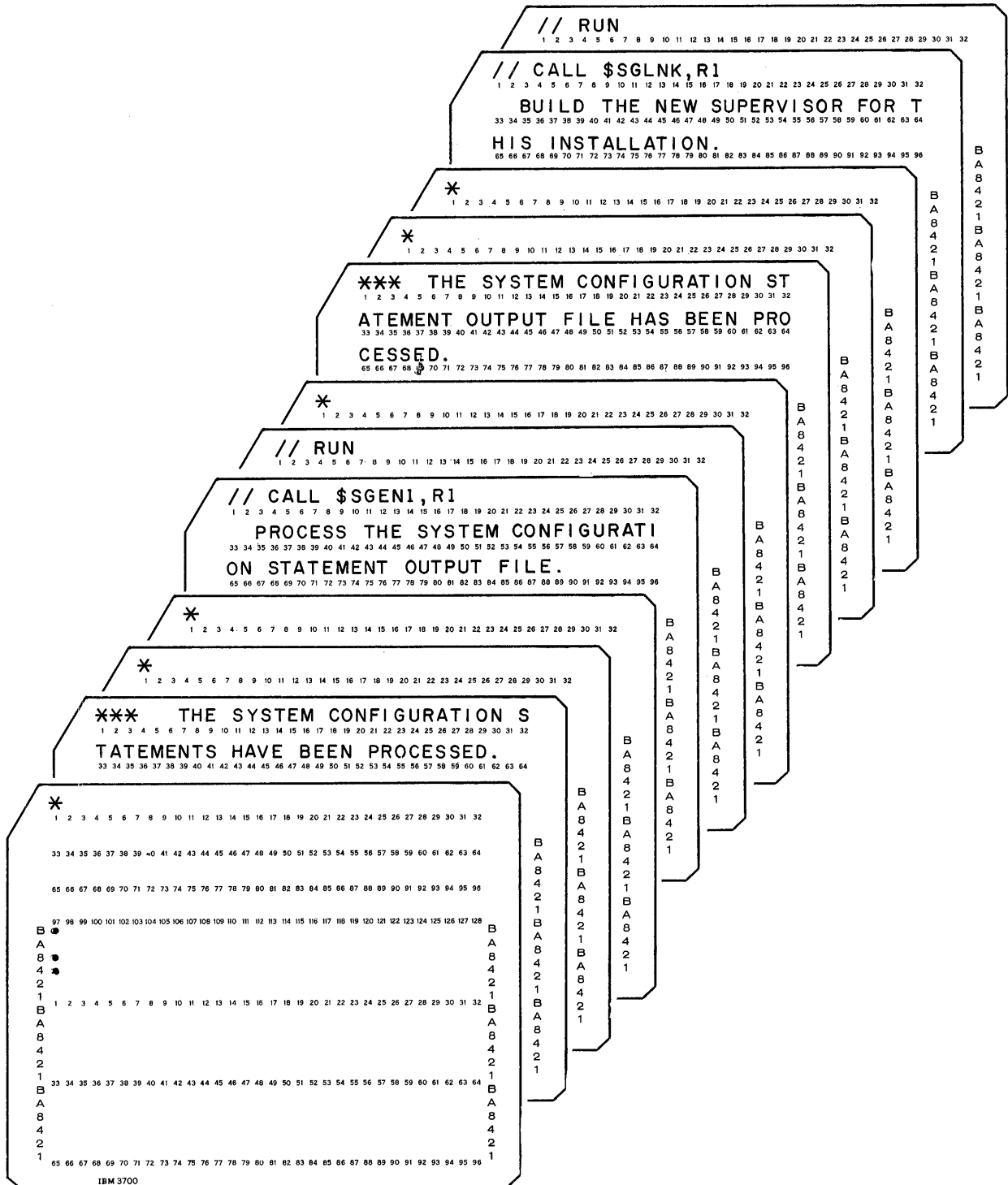

Figure 39. Punched Cards for SCP Generation (Part 5 of 6)

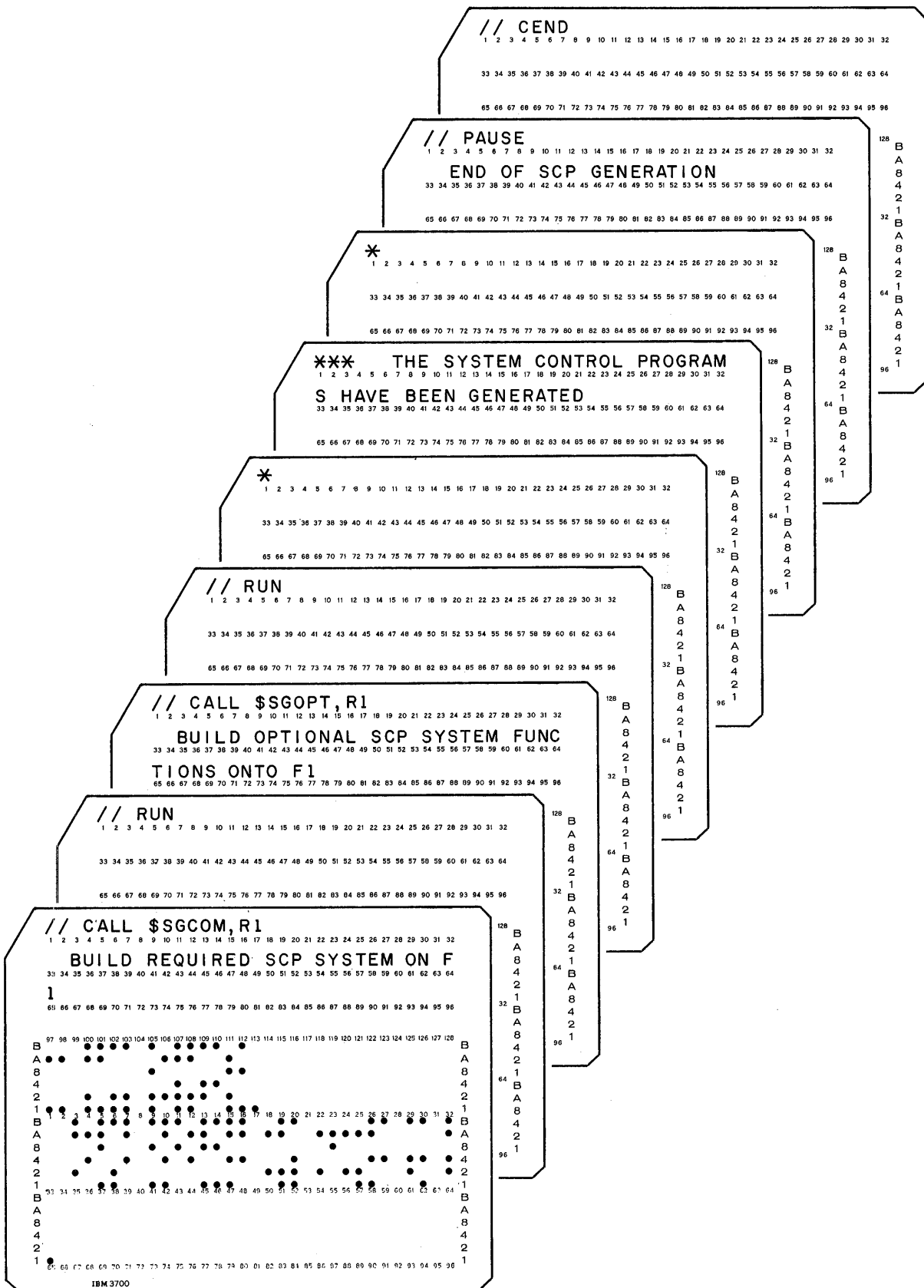
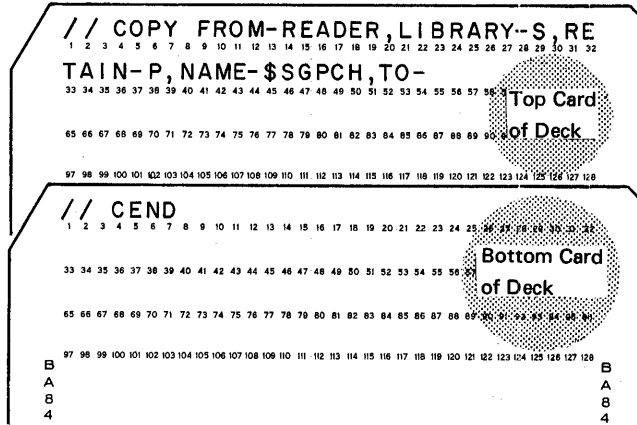

Figure 39. Punched Cards for SCP Generation (Part 6 of 6)

**Initializing F1**

1. Remove the punched cards from stacker 4.
2. Remove the following two cards from the deck and discard them:



3. Clear cards from MFCU.
4. Remove cards shown in Figure 40 from deck of punched cards and place them in primary hopper of MFCU.
5. Press MFCU START. PRIMARY READY turns on. SECONDARY READY turns on if there are blank cards in the secondary hopper.
6. Press console START (program 1 HALT/RESET key if you have DPF). The system begins reading the cards in the primary hopper and initialization of F1 begins.

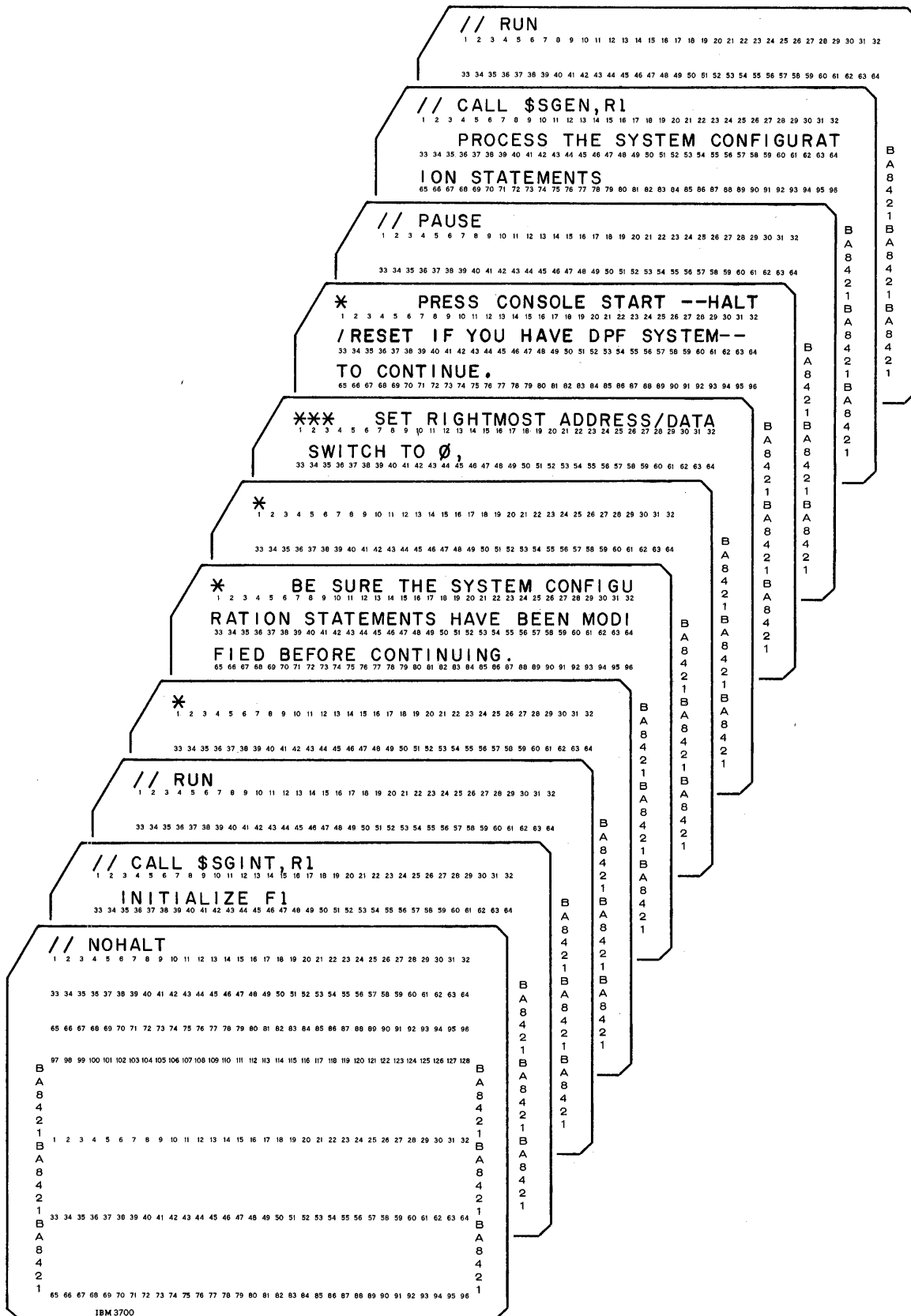

Figure 40. First Cards for System Generation



Halt 90 (caused by a // PAUSE statement) is displayed in the message display unit when the fixed disk (F1) has been initialized. There are still two cards in the primary hopper of the MFCU. Leave them there because they are part of the next procedure.

You can now modify the system configuration statements shown in Figure 41, depending on your system configuration. Figure 42 discusses each of the system configuration statements and the options available for each. If you do not have to change any of these statements, leave them in the remaining deck of punched cards and proceed to step 2 in *Modifying the System Configuration Statements*.

*Note:* The size of the supervisor generated for your system depends on the options you select for \$DDPF, \$DISK, and \$DKBD. To build the smallest supervisor (3K, see chart), you must use the following options:

\$DDPF	DPF-NO
\$DISK	DISKS-'R1,F1'
\$DKBD	KEYBD-NO

Using these options gives you a dedicated supervisor, input/output support for disk drive one, and no program support for a keyboard device. When you select an alternate for any of these options you increase the size of the supervisor. The size of the supervisor generated will be printed for you during system generation.

You may build a minimal supervisor even if your System/3 has DPF, both disk drives, and a 5471 console keyboard device. If you have an application which will not fit into core storage with a large supervisor, you might want to generate an additional supervisor especially for this application. From the three options mentioned earlier, you would select alternates only for those required by the application. This would give you the smallest supervisor capable of supporting this application. However, do not select options to support devices that you do not have.

*Note:* If you select DPF-NO when you have a DPF system and also select INQUIRY-YES, the P2 switch located on the CE panel must be set at OFF when system generation is complete.

*Note:* If you select options that are not valid for your system configuration, you will not be able to successfully perform the IPL process from your generated system.

*Planning Information:* An additional .5K bytes must be added to the supervisor for 5445 Disk Support.

Supervisor Type	Disk Spindles	5471 Console	Supervisor Main Storage Requirements*
Dedicated	Single Spindle 5444	No	3K bytes**
		Yes	
	Dual Spindle 5444	No	3.25K bytes**
		Yes	
DPF	Single Spindle 5444	No	3.75K bytes**
		Yes	4K bytes**
	Dual Spindle 5444	No	
		Yes	

\* Planning Information: An additional .5K bytes must be added to the supervisor for 5445 Disk Support.  
 \*\* K = 1024 decimal

This punched deck of system configuration statements already contains an assumed option for your system configuration to the right of the dash sign. The circled options are the ones you may choose from if your system configuration does not agree with the assumed option. The circled option could contain more than one value to choose from, therefore, the options are separated by the word OR. If the options are within quotes, the quotes must also be punched in the new card. The dashes which are circled with the options are not to be punched.

\$DUAL DUAL-NO --Y

1 2 3 4 5 6 7 8 9 10 11 12 13 14 15 16 17 18 19 20 21 22 23 24 25 26 27 28 29 30 31 32

ES--

SGN00008

65 66 67 68 69 70 71 72 73 74 75 76 77 78 79 80 81 82 83 84 85 86 87 88 89 90 91 92 93 94 95 96

\$DWID WIDTH-96 --1

1 2 3 4 5 6 7 8 9 10 11 12 13 14 15 16 17 18 19 20 21 22 23 24 25 26 27 28 29 30 31 32

20 OR 132--

SGN00007

65 66 67 68 69 70 71 72 73 74 75 76 77 78 79 80 81 82 83 84 85 86 87 88 89 90 91 92 93 94 95 96

\$DPRN PRINT-5203

1 2 3 4 5 6 7 8 9 10 11 12 13 14 15 16 17 18 19 20 21 22 23 24 25 26 27 28 29 30 31 32

33 34 35 36 37 38 39 40 41 42 43 44 45 46 47 48 49 50 51 52 53 54 55 56 57 58 59 60 61 62 63 64

SGN00006

65 66 67 68 69 70 71 72 73 74 75 76 77 78 79 80 81 82 83 84 85 86 87 88 89 90 91 92 93 94 95 96

\$DATE DATE-MDY --D

1 2 3 4 5 6 7 8 9 10 11 12 13 14 15 16 17 18 19 20 21 22 23 24 25 26 27 28 29 30 31 32

MY--

SGN00005

65 66 67 68 69 70 71 72 73 74 75 76 77 78 79 80 81 82 83 84 85 86 87 88 89 90 91 92 93 94 95 96

\$DOVR OVRLAP-NO --Y

1 2 3 4 5 6 7 8 9 10 11 12 13 14 15 16 17 18 19 20 21 22 23 24 25 26 27 28 29 30 31 32

ES VALID ONLY IF DISKS-'R1,F1,R

2' OR 'R1,F1,R2,F2'--

SGN00004

65 66 67 68 69 70 71 72 73 74 75 76 77 78 79 80 81 82 83 84 85 86 87 88 89 90 91 92 93 94 95 96

\$DISK DISKS-'R1,F1' --1

1 2 3 4 5 6 7 8 9 10 11 12 13 14 15 16 17 18 19 20 21 22 23 24 25 26 27 28 29 30 31 32

R1,F1,R2' OR 'R1,F1,R2,F2'--

SGN00003

65 66 67 68 69 70 71 72 73 74 75 76 77 78 79 80 81 82 83 84 85 86 87 88 89 90 91 92 93 94 95 96

\$DDPF DPF-NO --Y

1 2 3 4 5 6 7 8 9 10 11 12 13 14 15 16 17 18 19 20 21 22 23 24 25 26 27 28 29 30 31 32

ES--

SGN00002

65 66 67 68 69 70 71 72 73 74 75 76 77 78 79 80 81 82 83 84 85 86 87 88 89 90 91 92 93 94 95 96

\$DCOR CORE-12K --1

1 2 3 4 5 6 7 8 9 10 11 12 13 14 15 16 17 18 19 20 21 22 23 24 25 26 27 28 29 30 31 32

6K OR 24K OR 32K--

SGN00001

65 66 67 68 69 70 71 72 73 74 75 76 77 78 79 80 81 82 83 84 85 86 87 88 89 90 91 92 93 94 95 96

97 98 99 100 101 102 103 104 105 106 107 108 109 110 111 112 113 114 115 116 117 118 119 120 121 122 123 124 125 126 127 128

B			B
A	•	•	A
8	•	•	8
4	•	•	4
2	•	•	2
1	•	•	1
B	•	•	B
A	•	•	A
8	•	•	8
4	•	•	4
2	•	•	2
1	•	•	1
B	•	•	B
A	•	•	A
8	•	•	8
4	•	•	4
2	•	•	2
1	•	•	1

Figure 41. System Configuration Statements (Part 1 of 3)

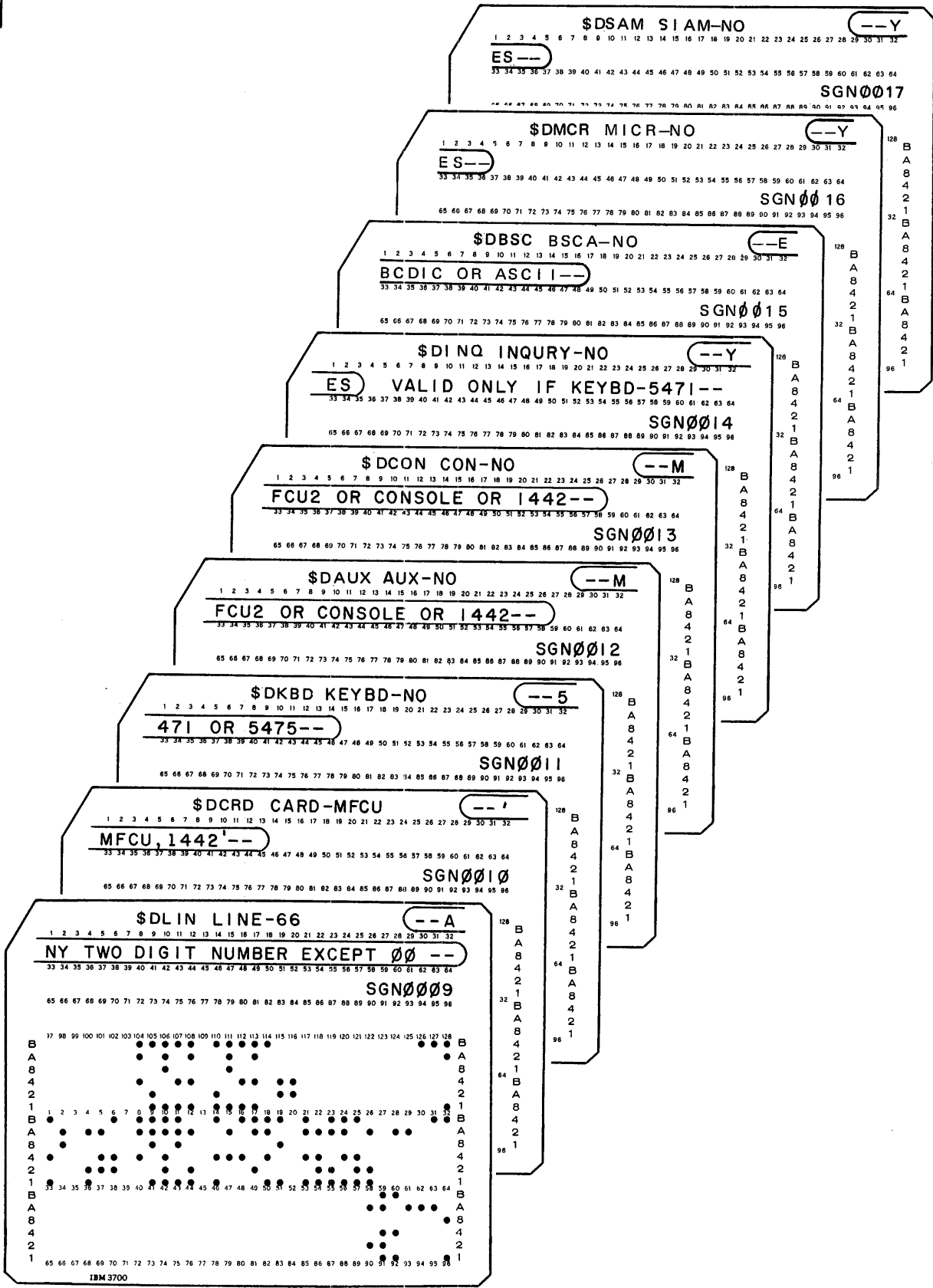

Figure 41. System Configuration Statements (Part 2 of 3)

```

// END
1 2 3 4 5 6 7 8 9 10 11 12 13 14 15 16 17 18 19 20 21 22 23 24 25 26 27 28 29 30 31 32
33 34 35 36 37 38 39 40 41 42 43 44 45 46 47 48 49 50 51 52 53 54 55 56 57 58 59 60 61 62 63 64
SGN0020
65 66 67 68 69 70 71 72 73 74 75 76 77 78 79 80 81 82 83 84 85 86 87 88 89 90 91 92 93 94 95 96

$DMOC TRIO-NO
1 2 3 4 5 6 7 8 9 10 11 12 13 14 15 16 17 18 19 20 21 22 23 24 25 26 27 28 29 30 31 32
--1270 OR 1255 OR '1270,1255' -
33 34 35 36 37 38 39 40 41 42 43 44 45 46 47 48 49 50 51 52 53 54 55 56 57 58 59 60 61 62 63 64
SGN0019
65 66 67 68 69 70 71 72 73 74 75 76 77 78 79 80 81 82 83 84 85 86 87 88 89 90 91 92 93 94 95 96

$DRJE RJE-NO
1 2 3 4 5 6 7 8 9 10 11 12 13 14 15 16 17 18 19 20 21 22 23 24 25 26 27 28 29 30 31 32
--YES VALID ONLY IF BSCA-EBCD
33 34 35 36 37 38 39 40 41 42 43 44 45 46 47 48 49 50 51 52 53 54 55 56 57 58 59 60 61 62 63 64
IC WAS SPECIFIED -- SGN0018
65 66 67 68 69 70 71 72 73 74 75 76 77 78 79 80 81 82 83 84 85 86 87 88 89 90 91 92 93 94 95 96

97 98 99 100 101 102 103 104 105 106 107 108 109 110 111 112 113 114 115 116 117 118 119 120 121 122 123 124 125 126 127 128
B A 8 4 2 1 B A 8 4 2 1
1 2 3 4 5 6 7 8 9 10 11 12 13 14 15 16 17 18 19 20 21 22 23 24 25 26 27 28 29 30 31 32 B A 8 4 2 1
33 34 35 36 37 38 39 40 41 42 43 44 45 46 47 48 49 50 51 52 53 54 55 56 57 58 59 60 61 62 63 64 B A 8 4 2 1
65 66 67 68 69 70 71 72 73 74 75 76 77 78 79 80 81 82 83 84 85 86 87 88 89 90 91 92 93 94 95 96 1
IBM 3700
    
```

Figure 41. System Configuration Statements (Part 3 of 3)

Description Statement	Assumed Value	Optional Values	Description
\$DCOR CORE—	12K	16K or 24K or 32K	Indicates the storage size of your processing unit. (K = 1024 bytes)
\$DDPF DPF—	NO	YES	Indicates whether you have the Dual Programming Feature (DPF). (See notes 1 and 2.)
\$DISK DISKS—	'R1,F1'	'R1,F1,R2' or 'R1,F1,R2,F2'	Indicates the number of disk units your system has. (See note 1.)
\$DOVR OVRLAP—	NO	YES	Indicates that you want the seek overlap capability if you chose YES and you have 'R1,F1,R2' or 'R1,F1,R2,F2'.
\$DATE DATE—	mdy	dmy	<p>Indicates the order for specifying month (m), day (d), and year (y) on the DATE OCL statement. Depending on the order you selected, the format of the DATE statement is either:</p> <p style="padding-left: 40px;">// DATE mmddy or // DATE ddmmyy</p> <p>Delimiters (/ , - , or any other characters except commas, quotes, numbers, and blanks) may be placed between the month, day, and year.</p> <p>Examples:</p> <p style="padding-left: 40px;">// DATE mm/dd/yy  // DATE dd-mm-yy</p> <p>You supply the system a DATE statement in front of the cards for the first job run after you perform the IPL process for the system.</p>
\$DPRN PRINT—	5203	None	Indicates the system printer being used.
\$DWID WIDTH—	96	120 or 132	Indicates the number of print positions on the printer.
\$DUAL DUAL—	NO	YES	Indicates whether your system has the dual feed carriage.
\$DLIN LINE—	66	Any two digit number except 00	Indicates the number of lines to be printed per page.
\$DCRD CARD—	MFCU	'MFCU,1442'	Indicates the card devices you have.
\$DKBD KEYBD—	NO	5471 or 5475	Indicates the type of keyboard (5471 Printer-Keyboard or 5475 Data Entry Keyboard) you have, if any. (See note 1.)
\$DAUX AUX—	NO	*MFCU2 or CONSOLE or 1442	Indicates the device you want assigned to the AUX position on the DPF panel. Console refers to 5471 Printer-Keyboard.
\$DCON CON—	NO	*MFCU or CONSOLE or 1442	Indicates the device you want assigned to the P-KB position of the DPF panel. Console refers to 5471 Printer-Keyboard.
\$DINQ INQUIRY—	NO	YES	Indicates whether you want inquiry. You can have inquiry only if you have the 5471 Printer-Keyboard. Inquiry gives your system the capability of interrupting an RPG II program, placing the interrupted program on disk, loading and executing a new program, then loading the interrupted program back into storage. (See note 2.)

Figure 42. Description of System Configuration Statements (Part 1 of 2)

Description Statement	Assumed Value	Optional Values	Description
\$DBSC BSCA—	NO	EBCDIC or ASCII	Indicates whether you have the Binary Synchronous Communications Adapter (BSCA). If you have BSCA, select the optional value your adapter supports.
\$DMCR MICR—	NO	YES	Indicates whether you have the 1255 (Models 1, 2, or 3) Magnetic Ink Character Reader.
\$DSAM SIAM—	NO	YES	Indicates whether you have shared I/O access methods.
\$DRJE RJE—	NO	YES	Indicates whether you have the Remote Job Entry (RJE) capability. You can have RJE only if you have BSCA with the EBCDIC adapter.
\$DMOC TRIO—	NO	1270 or 1255 or '1270,1255'	Indicates the Terminal Reader In Optics (TRIO) devices you have (if any).  1270 Optical Reader Sorter  1255 Model 21, 22, or 23 Magnetic Ink Character Reader  You can select either or both of these devices to be supported by your system.  These devices are not available in the United States.

\* DAUX AUX—and \$DCON CON—cannot be assigned the same device.

*Note 1:* The size of the supervisor generated for your system depends upon the options you select for \$DDPF, \$DISK, and \$DKBD. To build the smallest (3K, see chart) supervisor, you must use the following options:

\$DDPF     DPF-NO  
 \$DISK     DISKS-'R1,F1'  
 \$DKBD     KEYBD-NO

Using these options gives you a dedicated supervisor, input/output support for disk drive one, and no program support for a keyboard device. When you select an alternate for any of these options, you increase the size of the supervisor. The size of the supervisor generated will be printed for you during system generation.

You may build a minimal supervisor even if your System/3 has DPF, both disk drives, and a 5471 console keyboard device. If you have an application which will not fit into core storage with a large supervisor, you might want to generate an additional supervisor especially for this application. From the three options mentioned earlier, you would select alternates only for those required by the application. This would give you the smallest supervisor capable of supporting this application. However, do not select an option that supports a device which you do not have.

*Note 2:* If you select DPF-NO when you have a DPF system and also select INQUIRY-YES, the P2 switch located on the CE panel must be set at OFF when system generation is complete.

Supervisor Type	Disk Spindles	5471 Console	Supervisor Main Storage Requirements
Dedicated	Single Spindle 5444	No	3K bytes*
		Yes	
DPF	Dual Spindle 5444	No	3.25K bytes*
		Yes	
DPF	Single Spindle 5444	No	3.75K bytes*
		Yes	
	Dual Spindle 5444	No	4K bytes*
		Yes	
* K = 1024 decimal			

Figure 42. Description of System Configuration Statements (Part 2 of 2)

### Modifying the System Configuration Statements

1. Use the following procedure to change the system configuration statements:
  - a. Remove system configuration statements from the remaining deck of punched cards that you did not place in the primary hopper.
  - b. Select appropriate option for each statement using Figures 41 and 42. If the statement does not have to be changed, place it back in the deck and proceed to the next statement.
  - c. Punch the card to be changed in exactly the same format, up to and including the dash sign, then punch the option you choose.

Example:

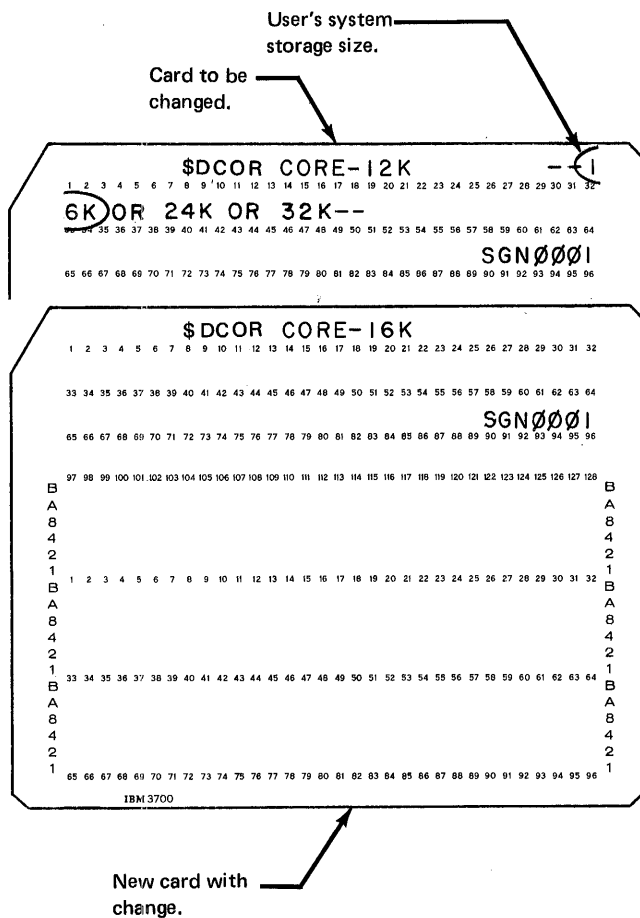

- d. Place each new card back in the deck. Discard the old card. Be sure to keep the cards in the same order shown in Figure 41.
  - e. When the changes are complete, place the system configuration statements back in front of the remaining deck of punched cards.
2. Place the system configuration statements after the two remaining cards from the preceding procedure in the primary hopper of the MFCU followed by the remaining deck of punched cards.
  3. Press MFCU START.
  4. Set rightmost address/data switch on console at 0.
  5. Press console START (program 1 HALT/RESET key if you have DPF).

When a halt of 90 is displayed in the message display unit, SCP generation is complete and the following has been accomplished:

- System configuration statements have been processed.
- Required SCP system has been built on F1.

Figure 43 is a sample printout of SCP generation. You can now perform program product generation, if desired. However, if you do not want to perform program generation at this time, perform the following:

1. Set rightmost address/data switch at 0.
2. Press console START (program 1 HALT/RESET key if you have DPF). I/O ATTENTION will then occur.
3. Proceed to *Completing System Generation and Installation Verification* to copy your SCP system on F1 to R1 to create a backup and build a minimal system on F1, if desired.

```
// DATE 04/06/71
// CALL %SGPCH,R1
XX LOAD %MAINT,R1
*
*
***** INSTRUCTIONS FOR SCP SYSTEM GENERATION *****
*
*** THIS CONTROL DECK PUNCHES OUT THE SCP SYSTEM GENERATION INSTRUCTION CARDS
AND PRINTS A LISTING OF THE PUNCHED CARDS ON THE PRINTER
*
*** THE FIRST CARD --A COPY CARD-- AND THE LAST CARD -- A CEND CARD-- THAT ARE PUNCHED OUT
MUST BE DISCARDED.
*
*** SEPARATE THE DECK INTO TWO PARTS BY TAKING THE CARDS UP TO AND INCLUDING
THE // RUN CARD THAT FOLLOWS THE // CALL %SGEN,R1 OFF THE FRONT OF THE DECK.
PLACE THESE CARDS INTO THE PRIMARY HOPPER OF THE MFCU AND PRESS MFCU START.
*
*** THEN PRESS CONSOLE START --HALT/RESET IF YOU HAVE DPF SYSTEM--
*
*** WHEN A HALT 90 IS DISPLAYED IN THE MESSAGE DISPLAY UNIT, THE SYSTEM
CONFIGURATION STATEMENTS SHOULD BE MODIFIED AS REQUIRED TO REFLECT YOUR
SYSTEM HARDWARE CONFIGURATION.
BE SURE TO KEEP THESE CARDS IN THE SAME ORDER. WHEN CHANGES ARE COMPLETE,
PLACE THE SYSTEM CONFIGURATION STATEMENTS IN THE PRIMARY HOPPER OF THE
MFCU FOLLOWED BY THE REMAINING DECK OF PUNCHED CARDS AND PRESS MFCU START.
*
*** SET RIGHTMOST ADDRESS/DATA SWITCH TO 0.
*** THEN PRESS CONSOLE START --HALT/RESET IF YOU HAVE DPF SYSTEM-- TO CONTINUE.
*
*** WHEN A HALT 90 IS AGAIN DISPLAYED IN THE MESSAGE DISPLAY UNIT,
SCP GENERATION IS COMPLETE.
*
***** END OF INSTRUCTIONS FOR SCP SYSTEM GENERATION *****

READ THE INSTRUCTIONS GIVEN ABOVE.

*** AFTER READING THE INSTRUCTIONS, SET RIGHTMOST ADDRESS/DATA SWITCH TO 0.
PRESS CONSOLE START --HALT/RESET IF YOU HAVE DPF SYSTEM--
TO CONTINUE WITH SCP SYSTEM GENERATION.
XX PAUSE
XX RUN
// RUN
// CCOPY NAME=%SGPCH,LIBRARY=S,FROM=R1,TO=PRTPCH
```

You prepared these cards.

Instructions telling you what to do for the SCP portion of system generation.

This portion of SCP generation causes the instruction cards to be punched by the MFCU and printed on the printer.

This statement causes the system to halt with 91 in the message display unit.

You prepared this card.

The following is a printout of the punched cards.

```
%SGPCH
// NCFALT
// CALL %SGINT,R1 INITIALIZE F1
// RUN
* BE SURE THE SYSTEM CONFIGURATION STATEMENTS HAVE BEEN MODIFIED BEFORE CONTINUING.
*
*** SET RIGHTMOST ADDRESS/DATA SWITCH TO 0,
PRESS CONSOLE START --HALT/RESET IF YOU HAVE DPF SYSTEM-- TO CONTINUE.
// PAUSE
// CALL %SGEN,R1 PROCESS THE SYSTEM CONFIGURATION STATEMENTS
// RUN
%BCOR CORE=12K --16K OR 24K OR 32K-- SGN0001
%CCPF DPF=NO --YES-- SGN0002
%DISK DISKS='R1,F1' --'R1,F1,R2' OR 'R1,F1,R2,F2'-- SGN0003
%COVR OVLAP=NO --YES,VALID ONLY IF DISKS='R1,F1,R2' OR 'R1,F1,R2,F2'-- SGN0004
%DATE DATE=MDY --DMY-- SGN0005
%SLPHN PRINT=5203 SGN0006
%EWIC WIDTH=96 --120 OR 132-- SGN0007
%DUAL DUAL=NO --YES-- SGN0008
%CLIN LINE=66 --ANY TWO DIGIT NUMBER EXCEPT 00 -- SGN0009
%LCRD CARC=MFCU --'MFCU,1442'-- SGN0010
%LKBD KEYBD=NO --5471 OR 5475-- SGN0011
%LAUX AUX=NO --MFCU2 OR CONSOLE LR 1442-- SGN0012
%LCON CON=NO --MFCU2 OR CONSOLE OR 1442-- SGN0013
%ICIN INCR=NO --YES VALID ONLY IF KEYBD=5471-- SGN0014
%BESC BSCA=NO --EBCDIC OR ASCII-- SGN0015
%EMCR MICR=NO --YES-- SGN0016
%LSAM SIAM=NO --YES-- SGN0017
%ERJE RJE=NO --YES VALID ONLY IF BSCA=EBCDIC WAS SPECIFIED -- SGN0018
%EMOC TRIO=NO --1270 OR 1255 OR '1270,1255'-- SGN0019
// ENL SGN0020
```

Place these cards in the primary hopper of the MFCU and continue with SCP generation.

These are the system configuration statements. You may have to modify some of these statements. After modifying these statements, you will place them in the primary hopper of the MFCU.

Note 1

Note 1: Sequence numbers on system configuration statements are not program checked but should be kept in this sequence by the operator.

Figure 43. Example of System Control Program Generation (part 1 of 3)



```

*
*** THE SYSTEM CONFIGURATION STATEMENTS HAVE BEEN PROCESSED.
*
// CALL $SGEN1,R1          PROCESS THE SYSTEM CONFIGURATION STATEMENT OUTPUT FILE.
// RUN
*
*** THE SYSTEM CONFIGURATION STATEMENT OUTPUT FILE HAS BEEN PROCESSED.
*
// CALL $SGLNK,R1         BUILD THE NEW SUPERVISOR FOR THIS INSTALLATION.
// RUN
// CALL $SCCOM,R1         BUILD REQUIRED SCP SYSTEM ON F1
// RUN
// CALL $SCOPT,R1         BUILD OPTIONAL SCP SYSTEM FUNCTIONS ONTO F1
// RUN
*
*** THE SYSTEM CONTROL PROGRAMS HAVE BEEN GENERATED
*
// PAUSE                   END OF SCP GENERATION
    
```

After placing the system configuration statements in the primary hopper, place these cards in the hopper.

This statement causes the system to halt with 90 in the message display unit.

End of the printout of the punched cards.

Beginning of the printout of the cards you placed in the primary hopper of the MFCU. The system is executing these instructions.

```

// NGFALT
// CALL $SGINT,R1          INITIALIZE F1
XX LOAD $INIT,R1
XX RUN
// RUN
// UIN UNIT-F1,TYPE-CLEAR
// VUL PACK-F1F1F1
// ENC
INITIALIZATION ON F1 COMPLETE
    
```

BE SURE THE SYSTEM CONFIGURATION STATEMENTS HAVE BEEN MODIFIED BEFORE CONTINUING.

```

*** SET RIGHTMOST ADDRESS/DATA SWITCH TO 0.
* PRESS CONSOLE START --HALT/RESET IF YOU HAVE DPF SYSTEM-- TO CONTINUE.
// PAUSE
    
```

This statement causes the system to halt with 90 in the message display unit. The system configuration statements must be modified at this time before continuing.

```

// CALL $SGEN,R1          PROCESS THE SYSTEM CONFIGURATION STATEMENTS
XX LCAD $SGEN,R1
*
*** THE FOLLOWING CARDS AFTER THE // RUN AND BEFORE THE // END CARD ARE THE
*** SYSTEM CONFIGURATION STATEMENTS
*
XX FILE NAME=MACOUT,UNIT-F1,PACK-F1F1F1,RETAIN-T,TRACKS=20
XX RUN
// RUN
    
```

```

$CCOR CORE=12K           --16K OR 24K OR 32K--           SGN0001
$CCPF DPF=NO             --YES--                         SGN0002
$DISK DISKS='R1,F1'     --'R1,F1,R2' OR 'R1,F1,R2,F2'-- SGN0003
$LOVR OVLAP=NO          --YES,VALID ONLY IF DISKS='R1,F1,R2' OR 'R1,F1,R2,F2'--SGN0004
$DATE DATE=MDY          --DMY--                         SGN0005
$CPRN PRINT=520J       --120 OR 132--                     SGN0006
$LWID WIDTH=96         --YES--                         SGN0007
$DUAL DUAL=NO           --ANY TWO DIGIT NUMBER EXCEPT 00 -- SGN0008
$LLIN LINE=66          --'MFCU,1442'--                   SGN0009
$LCRD CARD=MFCU        --5471 OR 5475--                 SGN0010
$CKEC KEYBD=NO         --MFCU2 OR CONSOLE OR 1442--      SGN0011
$CAUX AUX=NO           --MFCU2 OR CONSOLE OR 1442--      SGN0012
$CCON CON=NO           --YES VALID ONLY IF KEYBD=5471--   SGN0013
$DING INQURY=NO        --EBCDIC OR ASCII--                SGN0014
$DESC BSCA=NO          --YES--                          SGN0015
$CMCH MICR=NO          --YES--                          SGN0016
$CSAM SIAM=NO          --YES--                          SGN0017
$CRJE RJE=NO           --YES VALID ONLY IF BSCA=EBCDIC WAS SPECIFIED -- SGN0018
$CMOC TRIO=NO          --1270 OR 1255 OR '1270,1255'--    SGN0019
// ENC                                                           SGN0020
    
```

```

*
*** THE SYSTEM CONFIGURATION STATEMENTS HAVE BEEN PROCESSED.
*
// CALL $SGEN1,R1          PROCESS THE SYSTEM CONFIGURATION STATEMENT OUTPUT FILE.
XX LOAD $SGEN1,R1
*
*** BUILD THE NEW CONFIGURATION RECORD.
*
XX FILE NAME=MACOUT,UNIT-F1,PACK-F1F1F1,RETAIN-S,TRACKS=20
XX FILE NAME=$WORK,UNIT-F1,PACK-F1F1F1,RETAIN-T,TRACKS=10
XX RUN
// RUN
    
```

\*\*\* THE SYSTEM CONFIGURATION STATEMENT OUTPUT FILE HAS BEEN PROCESSED.

```

// CALL $SGLNK,R1         BUILD THE NEW SUPERVISOR FOR THIS INSTALLATION.
XX LOAD $LINK,R1
XX FILE NAME=$WORK,UNIT-F1,PACK-F1F1F1,RETAIN-S,TRACKS=10
XX RUN
// RUN
SUPERVISOR SIZE - 2616 BYTES
TOTAL # OF LIBRARY SECTORS USED - 012
    
```

55247 B

Figure 43. Example of System Control Program Generation (part 2 of 3)

```

// CALL $SGCOM,R1          BUILD REQUIRED SCP SYSTEM ON F1
XX LOAD $MAINT,R1
XX RUN
// KUN
// ALLOCATE TO-F1, SOURCE-S, OBJECT-170, SYSTEM-YES
// COPY FROM-R1, LIBRARY-U, NAME-SYSTEM, TO-F1
// COPY FROM-R1, TO-F1, LIBRARY-O, NAME-$GNSUP, RETAIN-R, NEWNAME-$SPVR
// DELETE FROM-R1, RETAIN-P, LIBRARY-O, NAME-$GNSUP
// COPY FROM-R1, TO-F1, RETAIN-P, LIBRARY-U, NAME-$AL, ALL
// COPY FROM-R1, TO-F1, RETAIN-P, LIBRARY-O, NAME-$BU, ALL
// COPY FROM-R1, TO-F1, RETAIN-P, LIBRARY-O, NAME-$CC, ALL
// COPY FROM-R1, TO-F1, RETAIN-P, LIBRARY-O, NAME-$DE, ALL
// COPY FROM-R1, TO-F1, RETAIN-P, LIBRARY-U, NAME-$IN, ALL
// COPY FROM-R1, TO-F1, RETAIN-P, LIBRARY-U, NAME-$LA, ALL
// COPY FROM-R1, TO-F1, RETAIN-P, LIBRARY-O, NAME-$LI, ALL
// COPY FROM-R1, TO-F1, RETAIN-P, LIBRARY-U, NAME-$MA, ALL
// COPY FROM-R1, TO-F1, LIBRARY-P, RETAIN-R, NAME-$GCPY
// COPY FROM-R1, TO-F1, LIBRARY-P, RETAIN-P, NAME-$GINR
// COPY FROM-R1, TO-F1, LIBRARY-O, RETAIN-P, NAME-$GIVP
// COPY FROM-R1, TO-F1, LIBRARY-P, RETAIN-P, NAME-$GIVP
// COPY FROM-R1, TO-F1, LIBRARY-O, RETAIN-P, NAME-$GMNT
// COPY FROM-R1, TO-F1, RETAIN-P, LIBRARY-R, NAME-$, ALL
// END

// CALL $SGUPT,R1          BUILD OPTIONAL SCP SYSTEM FUNCTIONS ONTO F1
XX LOAD $MAINT,R1
XX RUN
// RUN
// COPY FROM-F1, TO-PRINT, LIBRARY-SYSTEM, NAME-ALL

```

SYSTEM DIRECTORY FROM F1 VOL. ID F1F1F1

SOURCE LIBRARY SECTION

SOURCE DIR POINTER	008-00
NEXT AVAIL LIB SECTOR	008-05
END OF LIB	012-23
NO OF DIR SECTORS	2
NO OF PERM LIB SECTORS	3
NO OF ACTIVE LIB SECTORS	3
NO OF AVAIL LIB SECTORS	115

DEJECT LIB SECTION

OBJECT DIR POINTER	015-00
END OF DIR	017-23
START OF LIB	018-00
ALLOCATED END OF LIB	174-23
EXTENDED END OF LIB	174-23
NO AVAIL PERM DIR ENTRIES	585
NO AVAIL TEMP DIR ENTRIES	585
FIRST TEMP DIR ENTRY	000-00-000
NEXT AVAIL TEMP DIR ENTRY	015-23-042
NEXT AVAIL LIB SECTOR FOR PERMS	064-18
NEXT AVAIL LIB SECTOR FOR TEMPS	064-18
NO AVAIL LIB SECTORS FOR PERMS	2646
NO AVAIL LIB SECTORS FOR TEMPS	2646
NO ACTIVE LIB SECTORS	1122
NO ACTIVE U. PERM LIB SECTORS	961
NO ACTIVE R. PERM LIB SECTORS	161
ROLL-IN/ROLL-OUT POINTER	000-00
ROLL-IN/ROLL-OUT SIZE	0
SWA POINTER	013-00
SWA SIZE	2
START OF LIBS	008-00
END OF LIBS	174-23

```

*
*** THE SYSTEM CONTROL PROGRAMS HAVE BEEN GENERATED
*
// PAUSE                      END OF SCP GENERATION

```

This statement causes the system to halt with 90 in the message display unit.

55248 B

Figure 43. Example of System Control Program Generation (part 3 of 3)

## Program Product Generation

### Consideration 1

Program product generation can be performed:

1. When SCP generation has just been completed. In this case, proceed to *Consideration 2*.
2. At any later time. For example, you did not want to perform program product generation immediately after SCP generation, or you ordered a new program product at a later time which does not require you to perform system control program generation again. In either case, perform the following to prepare F1 as if system control program generation has just been completed before going to *Consideration 2*.

### Backing up F1

1. Mount an initialized scratch disk cartridge on R1.
2. Ready disks.
3. Punch these statements:

```

1 4 8 12 16 20 24 28 32 36 40 44
// DATE 00/00/00
// LOAD COPY,F1
// RUN
// COPYPACK FROM-F1,TO-R1
// END
    
```

4. Place statements you just punched in primary hopper of MFCU.
5. Press MFCU START.
6. Ready printer.
7. Set program load selector at FIXED DISK.
8. Press PROGRAM LOAD. If your system has DPF, EJ is displayed in both message display units when initial program loading is complete. Press appropriate HALT/RESET key to continue.

When EJ is displayed in the message display unit, your system on F1 has been copied to R1. This is your backup disk cartridge. You now delete all files on F1.

### Deleting All Libraries and Files on F1

1. Clear cards from MFCU.
2. Remove cards from stacker 1.
3. Remove backup disk cartridge on R1.
4. Mount your tailored system disk cartridge on R1, and ready disks.
5. Punch these statements:

```

1 4 8 12 16 20 24 28 32 36 40 44
// DATE 00/00/00
// NOHALT
// LOAD SMAINT,R1
// RUN
// ALLOCATE TO-F1,SOURCE-0,OBJECT-0
// END
// HALT
// LOAD $DELET,R1
// RUN
// REMOVE UNIT-F1,LABEL-VTCC,PACK$nnnnnn
// END
    
```

Note: nnnnnn is the name of the pack.  
 You must fill in this parameter.

6. Place punched statements in primary hopper of MFCU.
7. Set program load selector at REMOVABLE DISK.
8. Press PROGRAM LOAD. If your system has DPF, EJ is displayed in both message display units. Press appropriate HALT/RESET key to continue.

All libraries and files on F1 are deleted when EJ is displayed in the message display unit. You can now copy your tailored system on R1 to F1.

#### Copying R1 to F1

1. Clear cards from MFCU.
2. Remove cards from stacker 1.
3. Punch these statements:

1	4	8	12	16	20	24	28	32	36	40	44
///	LOAD	BCOPY,	R1								
///	RUN										
///	COPYPACK	FROM-R1,	TO-F1								
///	END										

4. Place punched statements in primary hopper of MFCU.
5. Press MFCU START.
6. Press console START (or appropriate HALT/RESET key if you have DPF).

Your tailored system on R1 is copied to F1 and, when complete, EJ is displayed in the message display unit. You can now proceed to *Consideration 2*.

#### Consideration 2

A program product can be distributed to you on:

1. The same cartridge as the distribution disk cartridge that contains the system generation programs and the system control programs. In this case, perform *Procedure 1*.
2. A separate disk cartridge. In this case, perform *Procedure 2*.

*Note:* If you have program products on the distribution disk cartridge and also on separate disk cartridges, perform *Procedure 1* first for the program products on the distribution disk cartridge, then perform *Procedure 2* for the program products on separate disk cartridges.

*Procedure 1*

1. Figure 44 shows the OCL needed for each program product. Punch the two cards indicated for each program product ordered.
2. Clear cards from MFCU.
3. Place punched cards in primary hopper of MFCU.
4. Press MFCU START.
5. Ready printer.
6. Set rightmost address/data switch on console at 0.
7. Press console START (program 1 HALT/RESET key if you have DPF). The program products are copied to F1.

If the program products are only on the distribution disk cartridge, program product generation is complete. At this point you have a tailored system on F1, because it has been generated according to your system configuration and the programs you wanted. I/O ATTENTION occurs when program product generation is complete, because the system is expecting more cards. Proceed to *Completing System Generation* and punch the indicated cards.

If you also have program products on a separate cartridge, perform Procedure 2 before going to *Completing System Generation*.

1	4	8	12	16	20	24	28	32	36	40	44	48	52	56	60	64	68	72	76	80	
//	CALL	BSGRPG	,R1																		RPG II Program*
//	RUN																				
//	CALL	BSGBSC	,R1																		BSCA/RPG II Support Programs*
//	RUN																				
//	CALL	BSGSRT	,R1																		Disk Sort Program
//	RUN																				
//	CALL	BSGUTL	,R1																		Card Utility Programs
//	RUN																				
//	CALL	BSGASM	,R1																		Basic Assembler Program
//	RUN																				
//	CALL	BSGMCR	,R1																		1255 (Models 1, 2, or 3) Magnetic Character Reader Utility Program
//	RUN																				
//	CALL	BSGDMC	,R1																		Terminal Reader in Optics Program
//	RUN																				

\* If you have RPG II and BSCA, RPG II programs must be copied before copying the BSCA/RPG II support programs. Place the two cards for RPG II in the primary hopper before placing the two cards for BSCA in the primary hopper.

Figure 44. OCL for Program Products

*Procedure 2*

1. Mount disk cartridge containing the program product on R1.
2. Clear cards from MFCU.
3. Punch a DATE statement and place it in the primary hopper of the MFCU.
4. Figure 44 shows the OCL needed for each program product. Punch the two cards indicated for each program product ordered.
5. Place punched cards in primary hopper of MFCU.
6. Ready printer.
7. Set program load selector at FIXED DISK.
8. Press PROGRAM LOAD.
9. Press MFCU START. The program products are copied to F1 and, when complete, EJ is displayed in the message display unit.

*Note:* Repeat steps 1-9 for each program products that is on a separate disk cartridge, then perform steps 10-14.

10. Remove disk cartridge containing the program products from R1.
11. Mount distribution disk cartridge (the one you used to perform SCP system generation) on R1.
12. Punch a DATE statement and place it in the primary hopper of the MFCU.
13. Set program load selector at REMOVABLE DISK.
14. Press PROGRAM LOAD. The DATE statement is read and I/O ATTENTION occurs.

At this point you have a tailored system on F1, because it has been generated according to your system configuration and the programs you wanted. I/O ATTENTION occurs when program product generation is complete, because the system is expecting more cards. Proceed to *Completing System Generation* and punch the indicated cards.

Figure 45 is a sample printout of program product generation.

```
// CALL $SGRPG,R1
XX LOAD $MAINT,F1
*
***          RPG II COMPILER PROGRAM
*
XX RUN
// RUN
// COPY FROM-R1,TO-F1,RETAIN-P,LIBRARY-P,NAME-$@RPG,NEWNAME-RPG
// COPY FROM-R1,TO-F1,RETAIN-P,LIBRARY-O,NAME-$RP.ALL
// COPY FROM-R1,TO-F1,RETAIN-P,LIBRARY-R,NAME-$@PG.ALL,NEWNAME-$$PG
// COPY FROM-R1,TO-F1,RETAIN-P,LIBRARY-R,NAME-$@R.ALL,NEWNAME-SUBR
// END
// CALL $SGSRT,R1
XX LOAD $MAINT,F1
*
***          DISK SORT PROGRAM
*
XX RUN
// RUN
// COPY FROM-R1,TO-F1,LIBRARY-O,RETAIN-P,NAME-$DS.ALL
// END
```

Figure 45 (Part 1 of 2). Example of Program Product Generation

```
// CALL $SGMCR,R1
XX LOAD $MAINT,F1
*
***          1255 MAGNETIC INK CHARACTER READER UTILITY PROGRAM
*
XX RUN
// RUN
// COPY FROM-R1,TO-F1,LIBRARY-O,RETAIN-P,NAME-$MI.ALL
// END
// CALL $SGASM,R1
XX LOAD $MAINT,F1
*
***          BASIC ASSEMBLER PROGRAM
*
XX RUN
// RUN
// COPY FROM-R1,TO-F1,LIBRARY-O,RETAIN-P,NAME-$AS.ALL
// END
// CALL $SGCTL,R1
XX LOAD $MAINT,F1
*
***          CARD UTILITY PROGRAMS
*
XX RUN
// RUN
// COPY FROM-R1,TO-F1,RETAIN-P,LIBRARY-O,NAME-$CS.ALL
// COPY FROM-R1,TO-F1,RETAIN-P,LIBRARY-O,NAME-$REPRO
// COPY FROM-R1,TO-F1,RETAIN-P,LIBRARY-O,NAME-$CLIST
// COPY FROM-R1,TO-F1,RETAIN-P,LIBRARY-O,NAME-$DREC
// COPY FROM-R1,TO-F1,RETAIN-P,LIBRARY-O,NAME-$DVER
// COPY FROM-R1,TO-F1,RETAIN-P,LIBRARY-O,NAME-$CNVRT
// END
// CALL $SGBSC,R1
XX LOAD $MAINT,F1
*
***          RPG II SUPPORT FOR BINARY SYNCHRONOUS COMMUNICATIONS
*
XX RUN
// RUN
// COPY FROM-R1,TO-F1,RETAIN-R,LIBRARY-R,NAME-$@PB.ALL,NEWNAME-$$PG
// COPY FROM-R1,TO-F1,RETAIN-R,LIBRARY-O,NAME-$RB.ALL,NEWNAME-$RP
// END
// CALL $SGDMO,R1
XX LOAD $MAINT,F1
*
***          TERMINAL READER IN OPTICS UTILITY PROGRAM
*
XX RUN
// RUN
// COPY FROM-R1,TO-F1,RETAIN-P,LIBRARY-O,NAME-$MO.ALL
// END
```

Note: The printout you have for program product generation depends on the program products you ordered.

Figure 45 (Part 2 of 2). Example of Program Product Generation

## Completing System Generation and Installation Verification

1. Punch the following cards:

1	4	8	12	16	20	24	28	32	36	40	44
//	H	A	L	T							
//	C	A	L	L							
//	R	U	N								

2. Clear cards from MFCU.
3. Place the three punched cards in primary hopper of MFCU.
4. Place blank cards in secondary hopper of MFCU.
5. Press MFCU START. PRIMARY READY and SECONDARY READY lights turn on. System generation continues.

A deck of punched cards (Figure 46), needed to continue with system generation, is in stacker 4. Halt EJ is displayed in the message display unit. You can now copy the system from F1 to R1.

### Preparing for the Copy of Your Tailored System on F1 to R1

1. Clear cards from MFCU and remove cards from stacker 1.
2. Remove deck of punched cards from stacker 4.

3. Remove these two cards from the deck and discard them:

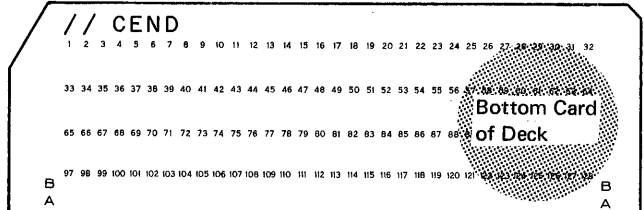
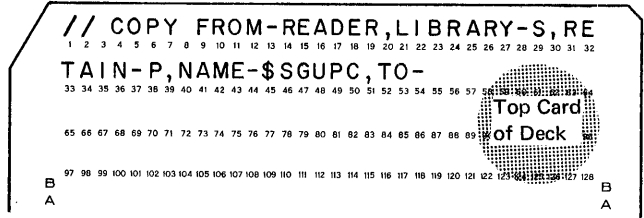

4. Place punched cards in primary hopper of MFCU.
5. Press MFCU START.
6. Remove distribution disk cartridge from R1 and store it.
7. Mount a scratch cartridge on R1 and ready disks.
8. Set program load selector at FIXED DISK.
9. Press PROGRAM LOAD. Initial program loading is performed and, when complete, the system begins reading cards from the MFCU.

If your system has DPF, EJ will be displayed in both message display units when initial program loading is complete. Press program 1 HALT/RESET key to continue.

A halt of 90 is displayed in the message display unit. This halt is provided to ensure that you have a scratch cartridge on R1. The cartridge on R1 will now be initialized. The volume label will be SYSTEM.





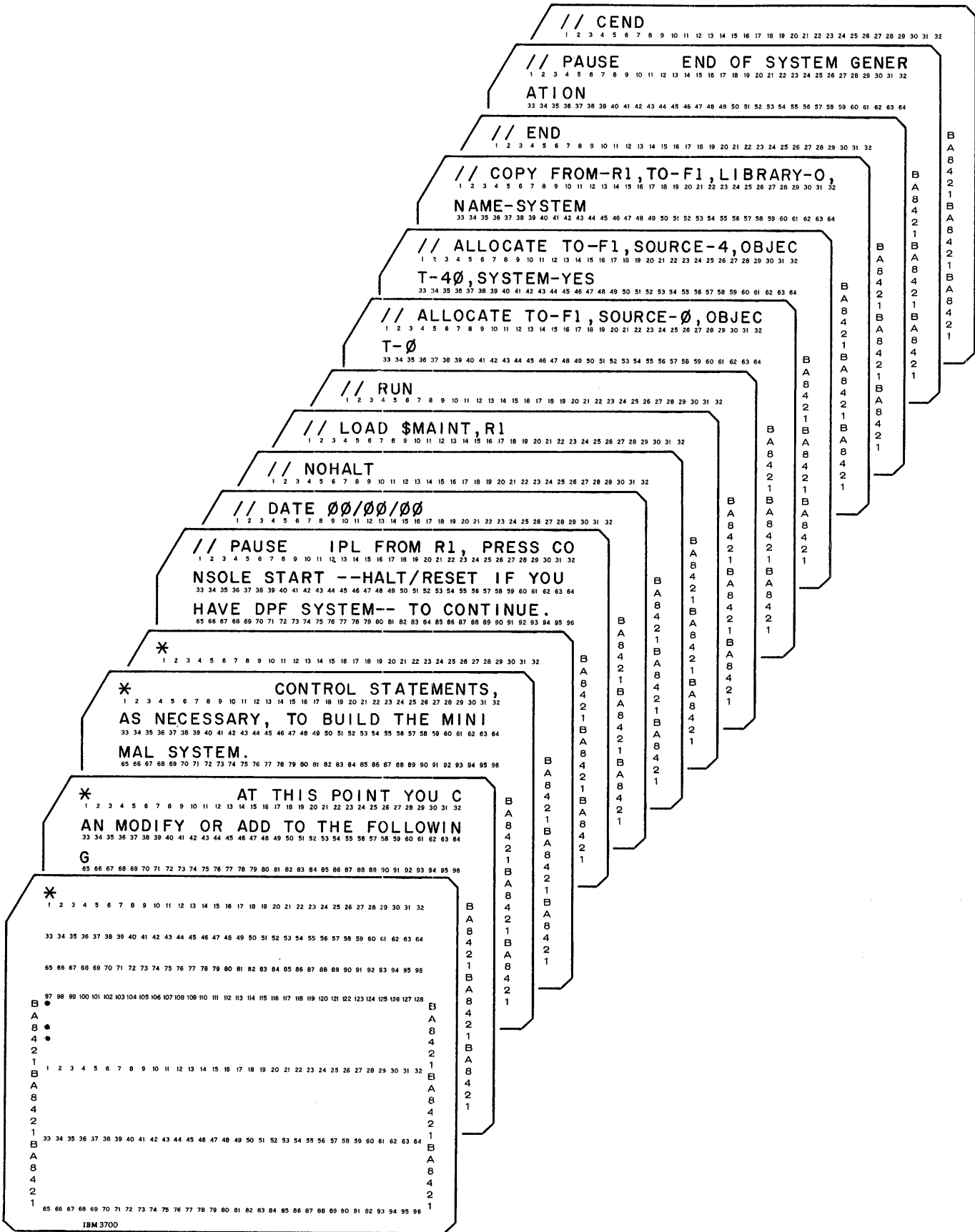

Figure 46. Punched Cards for Completing System Generation (part 2 of 2)

*Copying Your Tailored System on F1 to R1*

1. Set rightmost address/data switch on console at 0.
2. Press console START (program 1 HALT/RESET key if you have DPF).

The disk on R1 is initialized and your system is copied to R1. You now have two identical tailored systems on R1 and F1 containing all the programs generated. The system halts with 90 displayed in the message display unit.

You do not have to perform the following procedures if you want to leave the entire tailored system on F1. The following procedures will delete the tailored system on F1 and replace it with a minimal resident system. The minimal resident system will consist of the system control programs needed to sustain the IPL process and read OCL statements. If any disk utility programs or program products are desired on F1, COPY statements have to be prepared to include them (Figure 47). The second ALLOCATE statement can also be modified to increase or decrease the size of your libraries.

To determine the number of tracks required for the source and object libraries, use the Library Maintenance program (\$MAINT) to list the directories of these libraries on F1. Then, determine the number of sectors each program that you are going to copy requires. Now divide the total number of sectors required for a library by 24 to get the number of tracks needed for the programs. Be sure to add one track for any remainder from the division. In addition, an object library with a system needs three tracks for a directory. When a system is not included in an object library, the directory only needs one track.

If you expect to add any programs to these libraries later, leave space for them now.

If you decide to leave the entire generated system on F1, system generation is complete. Be sure to identify the cartridge on R1 as your tailored system disk cartridge. The disk name is SYSTEM.

After identifying the cartridge on R1 as your tailored system disk cartridge, sample programs should be run to ensure that your system has been generated properly. Information on how to run the RPG II sample program is provided in Appendix C.

*Building a Minimal Resident System on F1*

1. Modify or add more of the following statements:

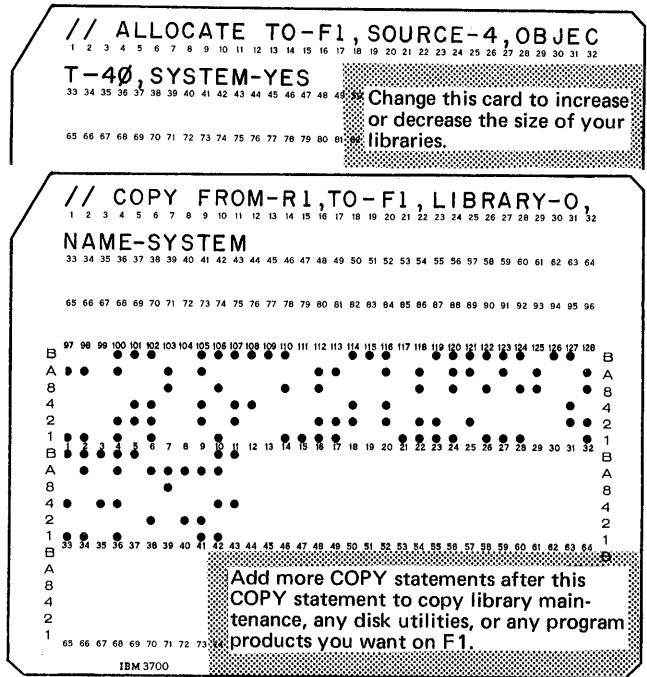

2. Press MFCU STOP and remove the cards from the primary hopper. If you have modified the ALLOCATE statement, replace the second ALLOCATE statement in the deck with the modified statement. Figure 47 shows the COPY statements needed to copy additional programs to F1. Place any additional COPY statements in from of the END statement.
3. Press MFCU START.
4. Set program load selector at REMOVABLE DISK.
5. Press PROGRAM LOAD. Initial program loading is performed and, when complete, the system begins reading cards from the MFCU.

If your system has DPF, EJ will be displayed in both message display units when initial program loading is complete. Press program 1 HALT/RESET key to continue.

System generation is complete when a halt of 90 is displayed in the message display unit. A minimal resident system is on F1. Figure 48 is a sample printout of completing System Generation.

// COPY FROM-R1,TO-F1,LIBRARY-P,RETAIN-R,NAME-RPG	} RPG II Program (You must also include Data Management modules to support your system configuration. You can also select the IBM - supplied RPG II user subroutines to be copied at this time.)
// COPY FROM-R1,TO-F1,LIBRARY-R,RETAIN-R,NAME-\$\$\$PG.ALL	
// COPY FROM-R1,TO-F1,LIBRARY-O,RETAIN-R,NAME-\$\$\$P.ALL	
// COPY FROM-R1,TO-F1,LIBRARY-O,RETAIN-R,NAME-\$\$\$LI.ALL	
// COPY FROM-R1,TO-F1,LIBRARY-R,RETAIN-R,NAME-\$\$\$CS.ALL	} Disk data management
// COPY FROM-R1,TO-F1,LIBRARY-R,RETAIN-R,NAME-\$\$\$DA.ALL	
// COPY FROM-R1,TO-F1,LIBRARY-R,RETAIN-R,NAME-\$\$\$I.ALL	
// COPY FROM-R1,TO-F1,LIBRARY-R,RETAIN-R,NAME-\$\$\$SR.ALL	
// COPY FROM-R1,TO-F1,LIBRARY-R,RETAIN-R,NAME-\$\$\$CODM	} 5471 Console I/O data management
// COPY FROM-R1,TO-F1,LIBRARY-R,RETAIN-R,NAME-\$\$\$SC.ALL	} Shared I/O SIAM data management
// COPY FROM-R1,TO-F1,LIBRARY-R,RETAIN-R,NAME-\$\$\$ARFF	} 1442 data management
// COPY FROM-R1,TO-F1,LIBRARY-R,RETAIN-R,NAME-\$\$\$LPRT	} Printer data management
// COPY FROM-R1,TO-F1,LIBRARY-R,RETAIN-R,NAME-\$\$\$BS.ALL	} BSCA data management
// COPY FROM-R1,TO-F1,LIBRARY-R,RETAIN-R,NAME-\$\$\$M.ALL	} MFCU data management
// COPY FROM-R1,TO-F1,LIBRARY-O,RETAIN-R,NAME-\$\$\$AS.ALL	} Basic Assembler Program
// COPY FROM-R1,TO-F1,LIBRARY-O,RETAIN-R,NAME-\$\$\$DS.ALL	} Disk Sort Program
// COPY FROM-R1,TO-F1,LIBRARY-O,RETAIN-R,NAME-\$\$\$CS.ALL	} MFCU Sort/Collate Program
// COPY FROM-R1,TO-F1,LIBRARY-O,RETAIN-R,NAME-\$\$\$REPRO	} 96-96 Reproduce and Interpret Program
// COPY FROM-R1,TO-F1,LIBRARY-O,RETAIN-R,NAME-\$\$\$CLIST	} 96 List Program
// COPY FROM-R1,TO-F1,LIBRARY-O,RETAIN-R,NAME-\$\$\$DREC	} Data Record Program
// COPY FROM-R1,TO-F1,LIBRARY-O,RETAIN-R,NAME-\$\$\$DYER	} Data Verify Program
// COPY FROM-R1,TO-F1,LIBRARY-O,RETAIN-R,NAME-\$\$\$CNVRT	} 80-96 Conversion Program
// COPY FROM-R1,TO-F1,LIBRARY-O,RETAIN-R,NAME-\$\$\$AL.ALL	} Alternate Track Assignment Program
// COPY FROM-R1,TO-F1,LIBRARY-O,RETAIN-R,NAME-\$\$\$BU.ALL	} Alternate Track Rebuild Program
// COPY FROM-R1,TO-F1,LIBRARY-O,RETAIN-R,NAME-\$\$\$CO.ALL	} Disk Copy/Dump Program
// COPY FROM-R1,TO-F1,LIBRARY-O,RETAIN-R,NAME-\$\$\$DE.ALL	} File Delete Program
// COPY FROM-R1,TO-F1,LIBRARY-O,RETAIN-R,NAME-\$\$\$IM.ALL	} Disk Initialization Program
// COPY FROM-R1,TO-F1,LIBRARY-O,RETAIN-R,NAME-\$\$\$LA.ALL	} File and Volume Label Display Program
// COPY FROM-R1,TO-F1,LIBRARY-O,RETAIN-R,NAME-\$\$\$MA.ALL	} Library Maintenance Program
// COPY FROM-R1,TO-F1,LIBRARY-O,RETAIN-R,NAME-\$\$\$MI.ALL	} 1255 Magnetic Character Reader Utility Program
// COPY FROM-R1,TO-F1,LIBRARY-O,RETAIN-R,NAME-\$\$\$MO.ALL	} Terminal Reader In Optics Program
// COPY FROM-R1,TO-F1,LIBRARY-R,RETAIN-R,NAME-SUBR.ALL	} IBM-supplied RPG II user subroutine

Figure 47. COPY Statements Needed to Copy Additional Programs to F1 When Building a Minimal System

```

// HALT
// CALL $SGUPC+R1
// CALL $MAINT+R1
*
*** THIS CONTROL DECK PUNCHES OUT THE FOLLOW-UP SYSTEM GENERATION INSTRUCTION CARDS.
*
*** THE FIRST CARD -- A COPY CARD -- AND THE LAST CARD -- A END CARD -- THAT ARE PUNCHED OUT
*** SHOULD BE DISCARDED BEFORE PLACING THE INSTRUCTION CARDS INTO THE MFCU.
*
XX RUN
// RUN
// COPY FROM=R1,TO=PRINTCH,LIBRARY=S,NAME=$SGUPC

$SGUPC
// DATE 06/00/00
*
*** AT THIS TIME A SCRATCH PACK SHOULD BE MOUNTED ON DRIVE-R1
*
*** SET RIGHTMOST ADDRESS/DATA SWITCH TO 0.
* PRESS CONSOLE START --HALT/RESET IF YOU HAVE DPF SYSTEM-- TO CONTINUE.
// PAUSE
// NCFALT
// CALL $SGINR+R1 INITIALIZE R1
// RUN
// CALL $SGCPY+R1 COPY TAILORED SYSTEM TO R1
// RUN
// CALL $SGIVP+R1
// RUN
*
* R1 NOW HAS THE TAILORED SYSTEM PACK.
*
* AT THIS POINT YOU CAN MODIFY OR ADD TO THE FOLLOWING
* CONTROL STATEMENTS, AS NECESSARY, TO BUILD THE MINIMAL SYSTEM.
*
// PAUSE IPL FROM R1, PRESS CONSOLE START --HALT/RESET IF YOU HAVE DPF SYSTEM-- TO CONTINUE.
// DATE 00/00/00
// NCFALT
// LOAD $MAINT+R1
// RUN
// ALLOCATE TO=F1,SOURCE=0,OBJECT=0
// ALLOCATE TO=F1,SOURCE=4,OBJECT=40,SYSTEM=YES
// COPY FROM=R1,TO=F1,LIBRARY=0,NAME=SYSTEM
// END
// PAUSE END OF SYSTEM GENERATION

// DATE 00/00/00
*
*** AT THIS TIME A SCRATCH PACK SHOULD BE MOUNTED ON DRIVE-R1
*
*** SET RIGHTMOST ADDRESS/DATA SWITCH TO 0.
* PRESS CONSOLE START --HALT/RESET IF YOU HAVE DPF SYSTEM-- TO CONTINUE.
// PAUSE
// NCFALT
// CALL $SGINR+R1 INITIALIZE R1
XX LOAD $INIT+R1
XX RUN
// RUN
// U IN UNIT=R1,TYPE=CLEAR
// VOL PACK=SYSTEM
// END
INITIALIZATION ON R1 COMPLETE
**ALTERNATE TRACKS ASSIGNED**
PRIMARY TRACK 224 ALTERNATE TRACK 002

// CALL $SGCPY+R1 COPY TAILORED SYSTEM TO R1
XX LOAD $COPY+R1
*
*** START UP SYSTEM VERIFICATION
*
XX RUN
// RUN
// COPYPACK FROM=F1,TO=R1
// END
COPYPACK IS COMPLETE

// CALL $SGIVP+R1
XX LOAD $SGIVP+R1
XX RUN
// RUN
END OF SYSTEM VERIFICATION

*
* R1 NOW HAS THE TAILORED SYSTEM PACK.
*
* AT THIS POINT YOU CAN MODIFY OR ADD TO THE FOLLOWING
* CONTROL STATEMENTS, AS NECESSARY, TO BUILD THE MINIMAL SYSTEM.
*
// PAUSE IPL FROM R1, PRESS CONSOLE START --HALT/RESET IF YOU HAVE DPF SYSTEM-- TO CONTINUE.
// DATE 00/00/00
// NCFALT
// LOAD $MAINT+R1
// RUN
// ALLOCATE TO=F1,SOURCE=0,OBJECT=0
// ALLOCATE TO=F1,SOURCE=4,OBJECT=40,SYSTEM=YES
// COPY FROM=R1,TO=F1,LIBRARY=0,NAME=SYSTEM
// END
// PAUSE END OF SYSTEM GENERATION

```

Printout of the punched cards. Place these cards in the primary hopper and continue.

This statement causes the system to halt with 00 in the message display unit. Ensure a scratch cartridge is mounted on R1.

The halt of 00 allows you to:  
 1. Change this statement.  
 2. Add COPY statements here to copy additional programs to F1.

This statement causes the system to halt with 00 in the message display unit.

55249A

Figure 48. Example of Completing System Generation

*Note:* Be sure to identify the cartridge on R1 as your tailored system disk cartridge.

After identifying the cartridge on R1 as your tailored system disk cartridge, sample programs should be run to ensure that your system has been generated properly. Information on how to run the RPG II sample program is provided in Appendix C.

*Note:* At the end of system generation, your tailored system (on R1 or F1) contains some system generation procedures not needed in your day-to-day operation. If you wish to have this space available for some other use, you can simply delete these procedures using the following load sequence. However, you must not attempt to remove these procedures from the distribution disk cartridge.

```
// LOAD $MAINT, { R1 }
//              { OR }
//              { F1 }
// RUN
// DELETE FROM- { R1 }
//              { OR }, RETAIN-P, LIBRARY-P, NAME-$SG.ALL
//              { F1 }
// END
```

### Building a Program Pack

A program pack may be built anytime after system generation. If you have a 100 cylinder disk, there may not be enough room on one pack for the system and all of your program products; or if you want to have more file space on the system pack, separate your program products by putting them on different packs.

The following procedures tell you how to build a program pack. First, be sure you have a back up copy of the system on F1. Next, determine the number of tracks required for the source and object libraries, use the Library Maintenance program (\$MAINT) to list the directories of these libraries on F1. Then, determine the number of sectors each program that you are going to copy to R1 requires. Now divide the total number of sectors required for a library by 24 to get the number of tracks needed for the programs. Be sure to add one track for any remainder from the division. In addition, an object library with a system needs three tracks for a directory. When a system is not included in an object library, the directory only needs one track.

If you expect to add any programs to these libraries later, leave space for them now.

### Deleting All Libraries and Files on F1

1. Clear cards from MFCU.
2. Mount tailored system disk cartridge on R1, and ready disks.
3. Punch the following statements (or you can use the same cards you punched when *Performing Disk Maintenance on Distribution Disk Cartridge*):

```
// DATE 00/00/00
// NOHALT
// LOAD $MAINT, R1
// RUN
// ALLOCATE TO-F1, SOURCE-0, OBJECT-0
// END
// HALT
// LOAD $DELET, R1
// RUN
// REMOVE UNIT-F1, LABEL-VITOC, PACK- nnnnnn
// END
```

*Note:* nnnnnn is the name of the pack. You must fill in this parameter.

4. Place the punched statements in primary hopper of MFCU.
5. Press MFCU START.
6. Set program load selector at REMOVABLE DISK.
7. Press PROGRAM LOAD. Initial program loading is performed and, when complete, the system begins reading cards from the MFCU.

If you have DPF, EJ is displayed in both message display units when initial program loading is complete. Press appropriate HALT/RESET key to continue.

All files on F1 are deleted when EJ is displayed in the message display unit. You can now copy from R1 to F1.

#### Copying from R1 to F1

1. Clear cards from MFCU.
2. Punch the following statements. Place the cards in the MFCU primary hopper.

```
// DATE 00/00/00
// LOAD MAINT,R1
// RUN
// ALLOCATE TO-F1, SOURCE-F, OBJECT-160, SYSTEM-YES
// COPY FROM-R1, LIBRARY-O, NAME-SYSTEM, TO-F1
// COPY FROM-R1, TO-F1, LIBRARY-O, RETAIN-R, NAME-AMA.ALL
// COPY FROM-R1, TO-F1, LIBRARY-O, RETAIN-R, NAME-SCO.ALL
// COPY FROM-R1, TO-F1, LIBRARY-O, RETAIN-R, NAME-BDE.ALL
// COPY FROM-R1, TO-F1, LIBRARY-O, RETAIN-R, NAME-BIN.ALL
// END
```

Note: If the program products that you want to copy to your program pack are currently on R1, place additional copy statements, for them, in front of the // END card. (See *Completing System Generation* for detailed description of copy statement preparation.)

3. Press MFCU START.
4. Set program load selector at REMOVABLE DISK.
5. Press PROGRAM LOAD. Initial program loading is performed and, when complete, the system begins reading cards from the MFCU.

If your system has DPF, EJ is displayed in both message display units when initial program loading is complete. Press appropriate HALT/RESET key to continue. EJ will be displayed when the copy is complete.

If the program products to be copied are on another pack or packs, you must perform the following six steps for each pack. If the program products are on the pack currently mounted, go to *Copy F1 to Program Pack*.

1. Remove the tailored system pack from R1.
2. Mount the pack containing program products on R1.
3. Punch the following statements and place in the primary hopper of MFCU.

```
// DATE 00/00/00
// LOAD MAINT,F1
// RUN
// END
```

Note: Place a copy statement before the // END statement for each program that you want to copy. (See *Completing System Generation* for the detailed description of copy statement preparation.)

4. Press MFCU START.

5. Set program load selector at FIXED DISK.
6. Press PROGRAM LOAD. Initial program loading is performed and, when complete, the system begins reading cards from the MFCU.

If your system has DPF, EJ is displayed in both message display units when initial program loading is complete. Press appropriate HALT/RESET key to continue. EJ will be displayed when copy is complete.

Now you are ready to copy the program products to the program pack.

*Copying F1 to Program Pack*

1. Mount an initialized scratch disk cartridge on R1 and ready disks. This will be your program pack.
2. Clear cards from MFCU.
3. Punch one of the following sets of cards.

Note: Replace nnn on the allocate statements with the number of tracks that you have determined are required for your source and object libraries.

*Statements to Copy All of F1 to R1:*

```
// DATE 00/00/00
// LOAD MAINT,F1
// RUN
// ALLOCATE TO-R1, SOURCE-nnn, OBJECT-nnn, SYSTEM-YES
// COPY FROM-F1, TO-R1, RETAIN-R, LIBRARY-ALL, NAME-ALL
// END
```

*Statements to Copy the System and Selected Programs:*

```
// DATE 00/00/00
// LOAD MAINT,F1
// RUN
// ALLOCATE TO-R1, SOURCE-nnn, OBJECT-nnn, SYSTEM-YES
// COPY FROM-F1, TO-R1, LIBRARY-0, NAME-SYSTEM
// END
```

Note: Place a copy statement for each program you want to copy in front of the // END statement. (See *Completing System Generation* for detailed description of copy statement preparation.)

*Statements to Copy Selected Programs:*

```
// DATE 00/00/00
// LOAD MAINT,F1
// RUN
// ALLOCATE TO-R1, SOURCE-nnn, OBJECT-nnn
// END
```

Note: Place a copy statement for each program you want to copy in front of the // END statement. (See *Completing System Generation* for detailed description of copy statement preparation.)

4. Place the cards in the primary hopper of the MFCU.
5. Press MFCU START.
6. Set program load selector at FIXED DISK.
7. Press PROGRAM LOAD. Initial program loading is performed and, when complete, the system begins reading cards from the MFCU.

If you have DPF, EJ is displayed in both message display units when initial program loading is complete. Press the appropriate HALT/RESET key to continue. EJ will be displayed when copying is complete.



- System Maintenance Procedures
- Common Procedures for Maintenance Releases on Cards or Disk
- Procedures for Maintenance Releases on Cards
- Procedures for Maintenance Releases on Disk

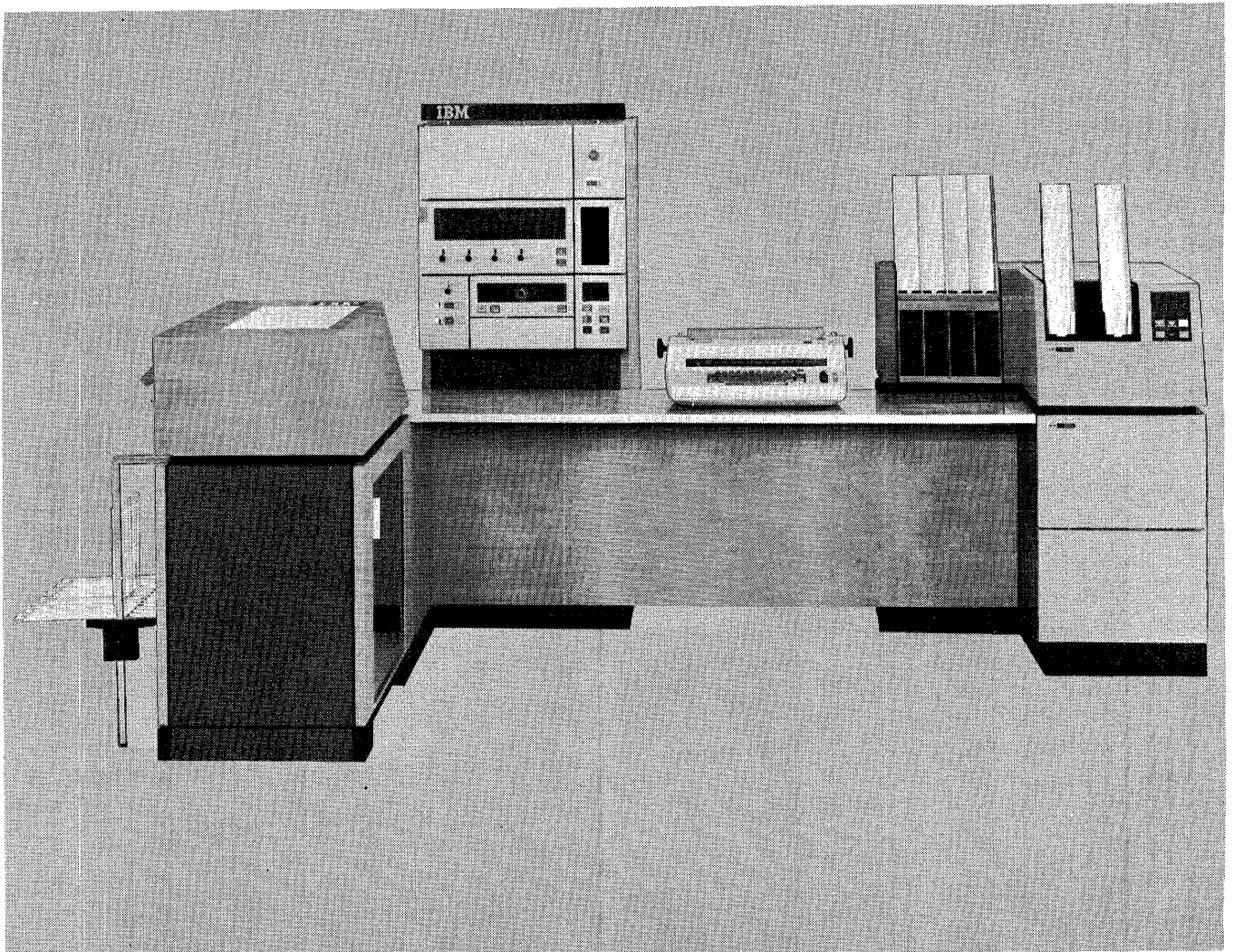

55239A

## SYSTEM MAINTENANCE PROCEDURES

IBM periodically sends you maintenance releases containing changes to the programs you use at your installation. These releases are on cards or disks. When you receive maintenance releases, you must perform system maintenance on your system to incorporate the changes.

System maintenance is divided into five functions:

1. Preparing for maintenance.
2. Backing up your resident system. This is done in case something goes wrong while performing maintenance. This is also done to save any data files you may have on F1.
3. Performing maintenance on the distribution disk cartridge.
4. Performing maintenance on the tailored system disk cartridge.
5. Building a minimal resident system on F1.

The first two functions are common to both card and disk maintenance; the remaining functions are different.

Figure 49 summarizes these five functions.

### COMMON PROCEDURES FOR MAINTENANCE RELEASES ON CARDS OR DISK

#### Preparing for Card or Disk Maintenance

1. Turn system power on.
2. Clear cards from MFCU.
3. Ready printer.
4. Perform IPL process.

The system is ready. You can now backup your resident system.

#### Backing Up Your Resident System

1. Mount an initialized scratch disk cartridge (a cartridge that has not been used or a cartridge that can be reused) on R1.
2. Ready disks.
3. Punch these statements:

1	4	8	12	16	20	24	28	32	36	40	44
//	DATE	00	00	00							
//	LOAD	COPY, F1									
//	RUN										
//	COPY/PACK FROM F1, TO R1										
//	END										

4. Place the statements you just punched in primary hopper of MFCU.
5. Press MFCU START.
6. Set program load selector at FIXED DISK.
7. Press PROGRAM LOAD. If your system has DPF, EJ is displayed in both message display units when initial program loading is complete. Press appropriate HALT/RESET key to continue.

When EJ is displayed in the message display unit, your resident system on F1 has been copied to R1. R1 is your backup disk cartridge.

From this point on the procedures for card and disk maintenance are different. Procedures for card maintenance follow. Procedures for disk maintenance are described later in this chapter.

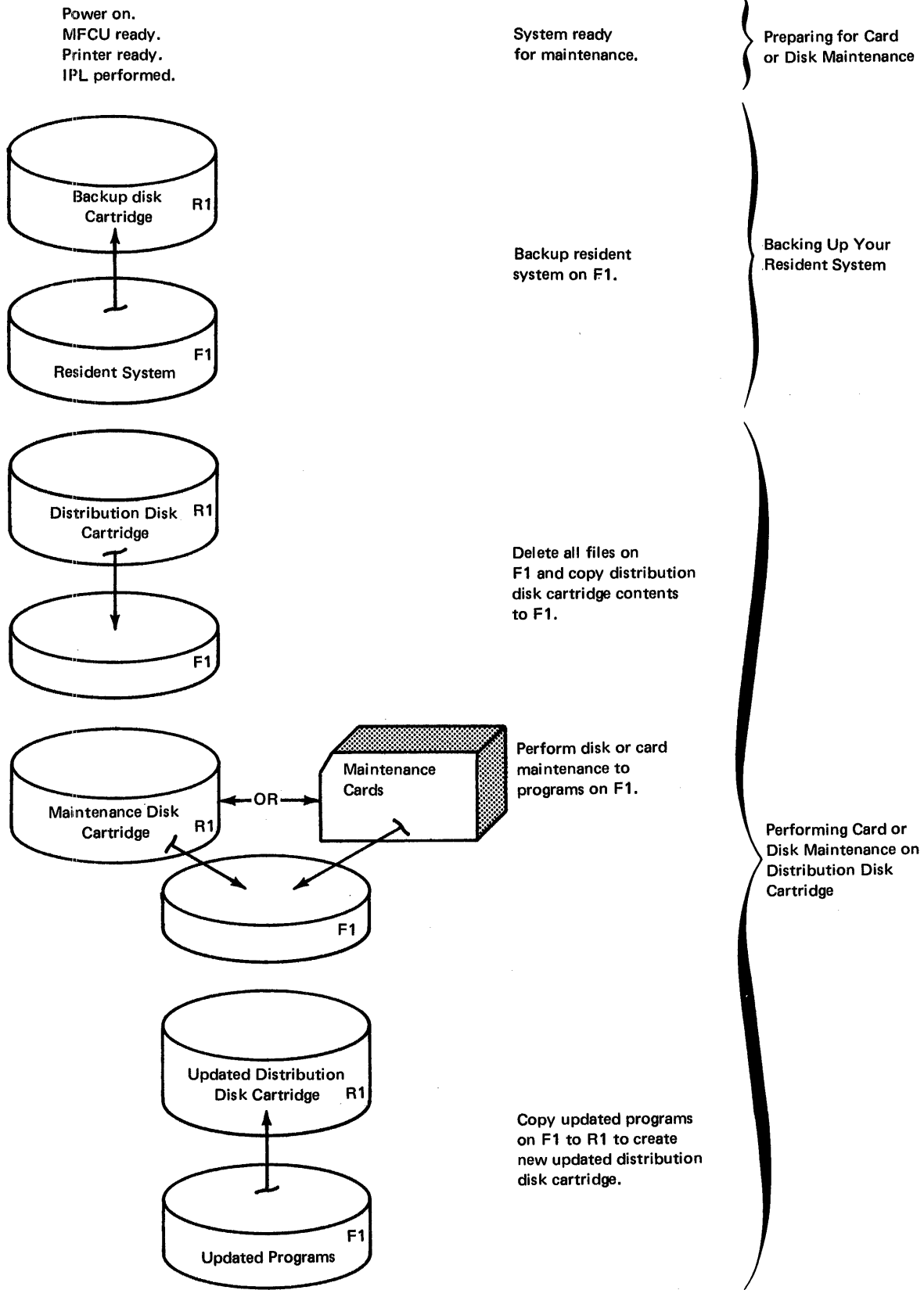

Figure 49. Summary of the Five Functions of Card and Disk Maintenance (part 1 of 2)

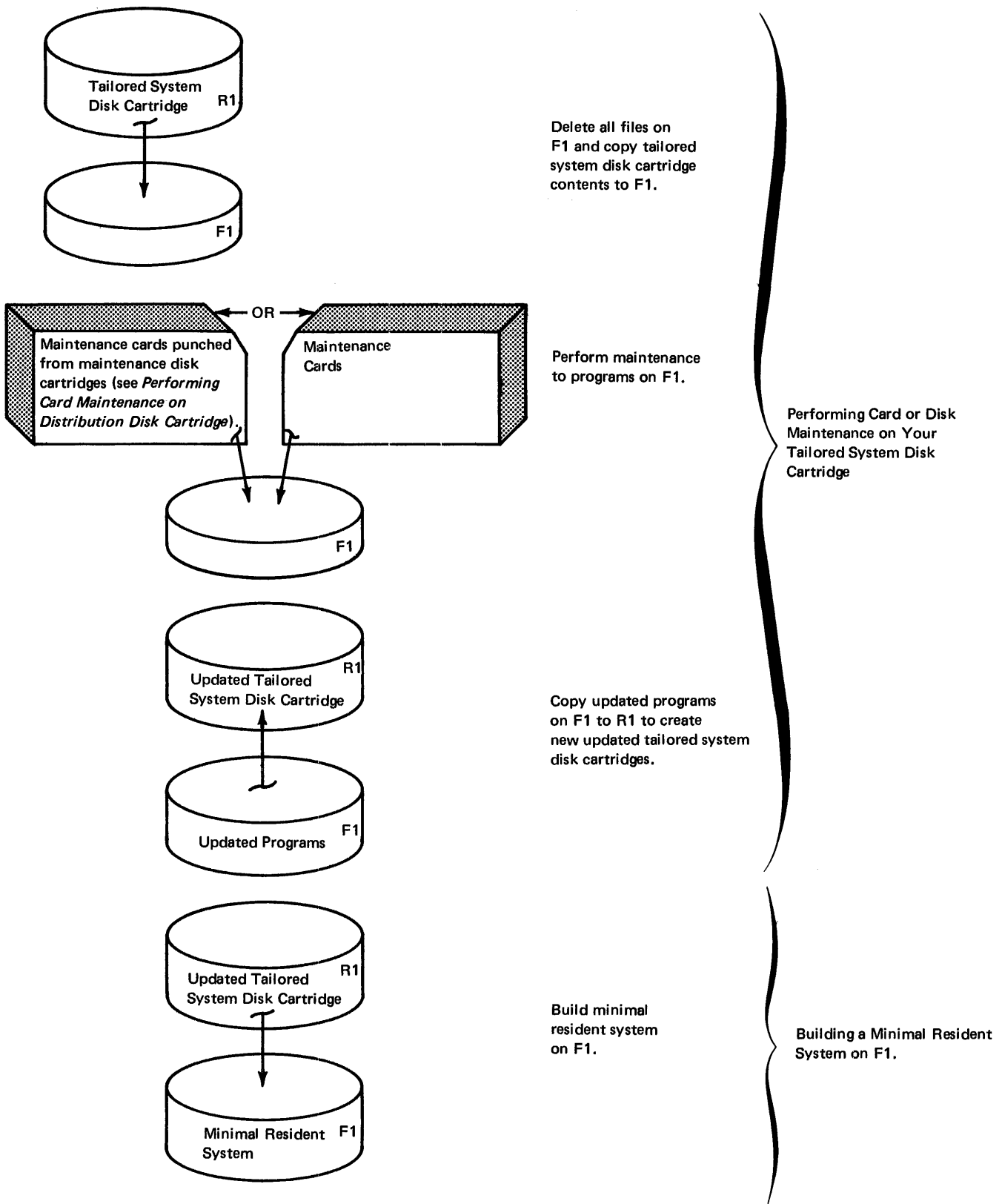

Figure 49. Summary of the Five Functions of Card and Disk Maintenance (part 2 of 2)

## PROCEDURES FOR MAINTENANCE RELEASES ON CARDS

### Performing Card Maintenance on Distribution Disk Cartridge

#### Deleting All Libraries and Files on F1

1. Clear cards from MFCU.
2. Remove cards from stacker 1.
3. Remove the backup disk cartridge.
4. Mount distribution disk cartridge to be updated on R1, and ready disks.
5. Punch these statements:

```

1 4 8 12 16 20 24 28 32 36 40 44
// DATE 00/00/00
// MOHALT
// LOAD $MAINT,R1
// RUN
// ALLOCATE TO-F1,SOURCE-0,OBJECT-0
// END
// HALT
// LOAD $DELET,R1
// RUN
// REMOVE UNIT-F1,LABEL-VTOC,PACK:nnnnnn
// END
    
```

Note: nnnnnn is the name of the pack.  
 You must fill in this parameter.

6. Place punched statements in primary hopper of MFCU.
7. Press MFCU START.
8. Set program load selector at REMOVABLE DISK.

9. Press PROGRAM LOAD. Initial program loading is performed and, when complete, the system begins reading cards from the MFCU.

If your system has DPF, EJ is displayed in both message display units when initial program loading is complete. Press appropriate HALT/RESET key to continue.

All libraries and files on F1 are deleted when EJ is displayed in the message display unit. You can now copy R1 to F1.

#### Copying R1 to F1

1. Clear cards from MFCU.
2. Remove cards from stacker 1 and set them aside. (You can use these cards when performing maintenance on the tailored system disk cartridge.)
3. Punch these statements:

```

1 4 8 12 16 20 24 28 32 36 40 44
// LOAD $COPY,R1
// RUN
// COPYPACK FROM-R1,TO-F1
// END
    
```

4. Place punched cards in primary hopper of MFCU.
5. Press MFCU START.
6. Press console START (or appropriate HALT/RESET key if you have DPF).

The distribution disk cartridge on R1 is copied to F1 and, when complete, EJ is displayed in the message display unit. You can now perform maintenance on the programs on F1.

### Performing Maintenance

1. Clear cards from MFCU.
2. Remove cards from stacker 1 and set them aside. (You can use these cards when performing maintenance on the tailored system disk cartridge.)
3. Remove distribution disk cartridge.
4. Mount tailored system disk cartridge on R1, and ready disks.
5. Place a DATE statement and maintenance release cards in primary hopper of MFCU.
6. Press MFCU START.
7. Set program load selector at REMOVABLE DISK.
8. Press PROGRAM LOAD. Initial program loading is performed and, when complete, the system begins reading cards from the MFCU.

If your system has DPF, EJ is displayed in both message display units when initial program loading is complete. Press appropriate HALT/RESET key to continue.

Maintenance is performed on the programs on F1 and is complete when EJ is displayed in the message display unit. You can now copy maintained programs from F1 to R1.

### Copying Maintained Programs From F1 to R1

1. Clear cards from MFCU. One card is fed into stacker 1.
2. Remove maintenance release cards from stacker 1 and set them aside. (You will use them again when performing maintenance on the tailored system disk cartridge.)

3. Remove tailored system disk cartridge.
4. Mount an initialized scratch disk cartridge on R1, and ready disks.
5. Punch these statements:

1	4	8	12	16	20	24	28	32	36	40	44
///	DATE	00/00/00									
///	LOAD	BCOPY, F1									
///	RUN										
///	COPYPACK	FROM-F1, TO-R1									
///	END										

6. Place punched statements in primary hopper of MFCU.
7. Press MFCU START.
8. Set program load selector at FIXED DISK.
9. Press PROGRAM LOAD. Initial program loading is performed and, when complete, the system begins reading cards from the MFCU.

If your system has DPF, EJ is displayed in both message display units when initial program loading is complete. Press appropriate HALT/RESET key to continue.

The updated programs are copied to the disk cartridge on R1. Identify this cartridge as the updated distribution disk cartridge. EJ is displayed in the message display unit.

*Note:* System maintenance may require that you perform system generation. You will be informed of this in a letter you receive with the release. If you have to perform system generation, follow the procedures in *Chapter 9. System Generation*; otherwise proceed with the following steps to update your tailored system disk cartridge.

## Performing Card Maintenance On Your Tailored System Disk Cartridge

### Deleting All Libraries and Files on F1

1. Clear cards from MFCU.
2. Remove cards from stacker 1 and set them aside. (You can use these cards later in this function.)
3. Remove updated distribution disk cartridge on R1.
4. Mount tailored system disk cartridge to be updated on R1, and ready disks.
5. Punch the following statements (or you can use the same cards you punched when *Performing Card Maintenance on the Distribution Disk Cartridge*):

1	4	8	12	16	20	24	28	32	36	40	44
//	DATE	00/00/00									
//	WOHALT										
//	LOAD	\$MAINT, R1									
//	RUN										
//	ALLOCATE	TO-F1, SOURCE-0, OBJECT-0									
//	END										
//	HALT										
//	LOAD	\$DELET, R1									
//	RUN										
//	REMOVE	UNIT-F1, LABEL-VTOC, PACK-nnnnnn									
//	END										

Note: nnnnnn is the name of the pack.  
 You must fill in this parameter.

6. Place the statements in primary hopper of MFCU.
7. Press MFCU START.
8. Set program load selector at REMOVABLE DISK.
9. Press PROGRAM LOAD. Initial program loading is performed and, when complete, the system begins reading cards from the MFCU.

If your system has DPF, EJ is displayed in both message display units when initial program loading is complete. Press appropriate HALT/RESET key to continue.

All files on F1 are deleted when EJ is displayed in the message display unit. You can now copy R1 to F1.

### Copying R1 to F1

1. Clear cards from MFCU.
2. Remove cards from stacker 1 and set them aside.
3. Punch the following statements (or you can use the same cards you punched when *Performing Card Maintenance on Distribution Disk Cartridge*):

1	4	8	12	16	20	24	28	32	36	40	44
//	LOAD	\$COPY, R1									
//	RUN										
//	COPYPACK	FROM-R1, TO-F1									
//	END										

4. Place the punched statements in primary hopper of MFCU.
5. Press MFCU START.
6. Press console START (or appropriate HALT/RESET key if you have DPF).

The tailored system disk cartridge on R1 is copied to F1 and is complete when EJ is displayed in the message display unit. You can now perform maintenance on F1.

### Performing Maintenance

1. Clear cards from MFCU.
2. Remove cards from stacker 1 and set them aside.
3. Place maintenance release cards in primary hopper of MFCU.
4. Press MFCU START.
5. Press console START (or appropriate HALT/RESET key if you have DPF).

Maintenance is performed on programs on F1 and is complete when EJ is displayed in the message display unit. You can now copy maintained programs on F1 to R1.

*Copying Maintained Programs From F1 to R1*

1. Clear cards from MFCU.
2. Remove cards from stacker 1 and set them aside.
3. Remove tailored system disk cartridge.
4. Mount an initialized scratch disk cartridge on R1, and ready disks.
5. Punch the following statements (or you can use the same cards you punched when *Performing Card Maintenance on the Distribution Disk Cartridge*):

```

1 4 8 12 16 20 24 28 32 36 40 44
// DATE 00/00/00
// LOAD COPY, F1
// RUN
// COPYPACK FROM-F1, TO-R1
// END
    
```

6. Place the statements in primary hopper of MFCU.
7. Press MFCU START.
8. Set program load selector at FIXED DISK.
9. Press PROGRAM LOAD. Initial program loading is performed and, when complete, the system begins reading cards from the MFCU.

If your system has DPF, EJ is displayed in both message display units when initial program loading is complete. Press appropriate HALT/RESET key to continue.

The updated programs are copied to the disk cartridge on R1. Copying is complete when EJ is displayed in the message display unit. Identify the cartridge on R1 as your updated tailored system disk cartridge. You now have identical updated tailored systems on R1 and F1.

Before continuing with maintenance, consider the following:

1. If you have other tailored system disk cartridges to be maintained, perform the steps under *Performing Card Maintenance on the Tailored System Disk Cartridge* for each cartridge.
2. If you want to leave the identical updated tailored systems on F1 and R1 and you do not have any more tailored system disk cartridges to be maintained, system maintenance is complete.

3. If you want a minimal resident system on F1, perform the steps under *Building a Minimal Resident System on F1*. The minimal resident system on F1 will consist of the system control programs needed to sustain the IPL process and read OCL statements.

**Building a Minimal Resident System on F1**

1. Clear cards from MFCU.
2. Remove cards from stacker 1 and set them aside.
3. Punch the statements shown in Figure 50
4. Place the statements in primary hopper of MFCU.
5. Press MFCU START.
6. Set program load selector at REMOVABLE DISK.
7. Press PROGRAM LOAD. Initial program loading is performed and, when complete, the system begins reading cards from the MFCU.

If your system has DPF, EJ is displayed in both message display units when initial program loading is complete. Press appropriate HALT/RESET key to continue.

An updated minimal resident system is built on F1 and is complete when EJ is displayed in the message display unit. System maintenance is complete.

*Note:* You can remove the updated tailored system disk cartridge on R1 at this time. Be sure to identify the disk cartridge as your updated tailored system disk cartridge. Be sure to copy the active files (if any) back to F1.

```

1 4 8 12 16 20 24 28 32 36 40 44 48
// DATE 00/00/00
// LOAD MAINT, R1
// RUN
// ALLOCATE TO-F1, SOURCE-0, OBJECT-0
// ALLOCATE TO-F1, SOURCE-4, OBJECT-40, SYSTEM-YES
// COPY FROM-R1, LIBRARY-0, NAME-SYSTEM, TO-F1
// END
    
```

*Note:* You can modify the second ALLOCATE statement in Figure 50 to increase or decrease the size of your libraries. You can also add more COPY statements after the COPY statement in Figure 50 if you want the Library Maintenance program, any disk utilities or any program products to be on F1.

Figure 50. Statements for Building a Resident System when Performing Card Maintenance



## PROCEDURES FOR MAINTENANCE RELEASES ON DISK

### Performing Disk Maintenance on Distribution Disk Cartridge

#### Deleting All Libraries and Files on F1

1. Clear cards from MFCU.
2. Remove cards from stacker 1 and set them aside.
3. Remove backup disk cartridge on R1.
4. Mount distribution disk cartridge to be updated on R1, and ready disks.
5. Punch the following statements:

```

1   4   8   12  16  20  24  28  32  36  40  44
// DATE 00/00/00
// NOHALT
// LOAD MAINT, R1
// RUN
// ALLOCATE TO-F1, SOURCE-0, OBJECT-0
// END
// HALT
// LOAD DELET, R1
// RUN
// REMOVE UNIT-F1, LABEL-VTOC, PACK-nnnnnn
// END
    
```

Note: nnnnnn is the name of the pack.  
 You must fill in this parameter.

6. Place the statements in the primary hopper of MFCU.
7. Press MFCU START.
8. Set program load selector at REMOVABLE DISK.

9. Press PROGRAM LOAD. Initial program loading is performed and, when complete, the system begins reading cards from the MFCU.

If your system has DPF, EJ is displayed in both message display units when initial program loading is complete. Press appropriate HALT/RESET key to continue.

All libraries and files on F1 are deleted when EJ is displayed in the message display unit. You can now copy R1 to F1.

#### Copying R1 to F1

1. Clear cards from MFCU.
2. Remove cards from stacker 1 and set them aside. (You can use these cards again when *Performing Disk Maintenance On The Tailored System Disk Cartridge.*)
3. Punch the following statements:

```

1   4   8   12  16  20  24  28  32  36  40  44
// LOAD COPY, R1
// RUN
// COPYPACK FROM-R1, TO-F1
// END
    
```

4. Place the statements in primary hopper of MFCU.
5. Press MFCU START.
6. Press console START (or appropriate HALT/RESET key if you have DPF).

The distribution disk cartridge on R1 is copied to F1 and is complete when EJ is displayed in the message display unit. You can now perform maintenance for the programs on F1.

**Obtaining Maintenance Release Deck**

1. Clear cards from MFCU.
2. Remove cards from stacker 1 and set them aside. (You can use these cards again when *Performing Disk Maintenance on the Tailored System Disk Cartridge.*)
3. Remove distribution disk cartridge from R1.
4. Mount maintenance disk cartridge on R1, and ready disks.
5. Punch the following statements:

1	4	8	12	16	20	24	28	32	36	40	44
//	D	A	T	E	00	/	00	/	00		
//	C	A	L	L	\$	S	G	M	N	T	,R1
//	R	U	N								

6. Place punched statements in primary hopper of MFCU.
7. Place blank cards in secondary hopper of MFCU.
8. Press MFCU START.
9. Set program load selector at **REMOVABLE DISK.**
10. Press **PROGRAM LOAD.** Initial program loading is performed and, when complete, the system begins reading cards from the MFCU.

If your system has DPF, EJ will be displayed in both message display units when initial program loading is complete. Press appropriate HALT/RESET key to continue.

Cards for continuing with maintenance are punched and routed to stacker 4. When the punching is complete, EJ is displayed in the message display unit. You can now perform maintenance on F1.

**Performing Maintenance on F1**

1. Clear cards from MFCU.
2. Remove cards from stacker 1 and discard them.
3. Remove punched cards from stacker 4.
4. Remove these two cards from the cards removed from stacker 4 and discard them:

```
// COPY FROM-READER, LIBRARY-S, RE
1 2 3 4 5 6 7 8 9 10 11 12 13 14 15 16 17 18 19 20 21 22 23 24 25 26 27 28 29 30 31 32
TAIN-P, NAME-$SGMNT, TO-
33 34 35 36 37 38 39 40 41 42 43 44 45 46 47 48 49 50 51 52 53 54 55 56 57 58 59 60 61 62 63 64

65 66 67 68 69 70 71 72 73 74 75 76 77 78 79 80 81 82 83 84 85 86 87 88 89 90 91 92 93 94 95 96

97 98 99 100 101 102 103 104 105 106 107 108 109 110 111 112 113 114 115 116 117 118 119 120 121 122
```

Top Card of Deck

```
// CEND
1 2 3 4 5 6 7 8 9 10 11 12 13 14 15 16 17 18 19 20 21 22 23 24 25 26 27 28 29 30 31 32

33 34 35 36 37 38 39 40 41 42 43 44 45 46 47 48 49 50 51 52 53 54 55 56 57 58 59 60 61 62 63 64

65 66 67 68 69 70 71 72 73 74 75 76 77 78 79 80 81 82 83 84 85 86 87 88 89 90 91 92 93 94 95 96

97 98 99 100 101 102 103 104 105 106 107 108 109 110 111 112 113 114 115 116 117 118 119 120 121 122 123 124 125 126 127 128
```

Bottom Card of Deck

5. Place cards in primary hopper of MFCU.
6. Press MFCU START.
7. Press console START (or appropriate HALT/RESET key if you have DPF).

Maintenance is performed on the programs on F1 and is complete when EJ is displayed in the message display unit. You can now copy maintained programs on F1 to R1.

### Copying Maintained Programs From F1 to R1

1. Clear cards from MFCU. One card is fed into stacker 1.
2. Remove maintenance release cards from stacker 1 and set them aside. (You will use them again when *Performing Disk Maintenance on the Tailored System Disk Cartridge*.)
3. Remove maintenance disk cartridge on R1.
4. Mount an initialized scratch disk cartridge on R1, and ready disks.
5. Punch the following statements:

```

1      4      8      12     16     20     24     28     32     36     40     44
// DATE 00/00/00
// LOAD #COPY, F1
// RUN
// COPYPACK FROM-F1, TO-R1
// END
    
```

6. Place punched statements in primary hopper of MFCU.
7. Press MFCU START.
8. Set program load selector at FIXED DISK.
9. Press PROGRAM LOAD. Initial program loading is performed and, when complete, the system begins reading cards from the MFCU.

If your system has DPF, EJ is displayed in both message display units when initial program loading is complete. Press appropriate HALT/RESET key to continue.

The updated programs are copied to the disk cartridge on R1. Identify this cartridge as the updated distribution disk cartridge. EJ is displayed in the message display unit.

*Note:* System maintenance may require that you perform system generation. You will be informed of this in a letter you receive with the release. If you have to perform system generation, follow the procedures in *Chapter 9. System Generation*; otherwise proceed with the following steps to update your tailored system disk cartridge.

### Performing Disk Maintenance on Your Tailored System Disk Cartridge

#### Deleting All Libraries and Files on F1

1. Clear cards from MFCU.
2. Remove cards from stacker 1 and set them aside. (You will use these cards later in this function.)
3. Remove updated distribution disk cartridge on R1.
4. Mount tailored system disk cartridge to be updated on R1, and ready disks.
5. Punch the following statements (or you can use the same cards you punched when *Performing Disk Maintenance on the Distribution Disk Cartridge*):

```

1      4      8      12     16     20     24     28     32     36     40     44
// DATE 00/00/00
// NOHALT
// LOAD #MAINT, R1
// RUN
// ALLOCATE TO-F1, SOURCE-0, OBJECT-0
// END
// HALT
// LOAD #DELET, R1
// RUN
// REMOVE UNIT-F1, LABEL-VTOC, PACK:nnnnnn
// END
    
```

*Note:* nnnnnn is the name of the pack. You must fill in this parameter.

6. Place the punched statements in primary hopper of MFCU.
7. Press MFCU START.
8. Set program load selector at REMOVABLE DISK.
9. Press PROGRAM LOAD. Initial program loading is performed and, when complete, the system begins reading cards from the MFCU.

If you have DPF, EJ is displayed in both message display units when initial program loading is complete. Press appropriate HALT/RESET key to continue.

All files on F1 are deleted when EJ is displayed in the message display unit. You can now copy R1 to F1.

### Copying R1 to F1

1. Clear cards from MFCU.
2. Remove cards from stacker 1 and set them aside.
3. Punch the following statements (or you can use the same cards you punched when *Performing Disk Maintenance on the Distribution Disk Cartridge*):

1	4	8	12	16	20	24	28	32	36	40	44
///	LOAD	#COPY,	R1								
///	RUN										
///	COPYPACK	FROM-R1,	TO-F1								
///	END										

4. Place the punched statements in primary hopper of MFCU.
5. Press MFCU START.
6. Press console START (or appropriate HALT/RESET key if you have DPF).

The tailored system disk cartridge on R1 is copied to F1 and is complete when EJ is displayed in the message display unit. You can now perform maintenance for the programs on F1.

### Performing Maintenance On F1

1. Clear cards from MFCU.
2. Remove cards from stacker 1 and set them aside.
3. Remove tailored system disk cartridge from R1.
4. Mount maintenance release cartridge on R1 and ready disks.
5. Place maintenance release cards punched from the maintenance release cartridge (see *Performing Disk Maintenance on the Distribution Disk Cartridge*) in primary hopper of MFCU.
6. Press MFCU START.
7. Set program load selector at REMOVABLE DISK.
8. Press PROGRAM LOAD. Initial program loading is performed and, when complete, the system begins reading cards from the MFCU.

If your system has DPF, EJ is displayed in both message display units when initial program loading is complete. Press appropriate HALT/RESET key to continue.

Maintenance is performed on the programs on F1 and is complete when EJ is displayed in the message display unit. You can now copy maintained programs from F1 to R1.

**Copying Maintained Programs on F1 to R1**

1. Clear cards from MFCU. One card is fed into stacker 1.
2. Remove maintenance release cards from stacker 1 and set them aside.
3. Remove maintenance release disk cartridge.
4. Mount an initialized scratch disk cartridge on R1, and ready disks.
5. Punch the following statements (or you can use the same cards you punched when *Performing Disk Maintenance on the Distribution Disk Cartridge*):

1	4	8	12	16	20	24	28	32	36	40	44
///	DATE	00	00	00							
///	LOAD	COPY, F1									
///	RUN										
///	COPYPACK	FROM F1, TO R1									
///	END										

6. Place punched statements in primary hopper of MFCU.
7. Press MFCU START.
8. Set program load selector at FIXED DISK.

9. Press PROGRAM LOAD. Initial program loading is performed and, when complete, the system begins reading cards from the MFCU.

If your system has DPF, EJ is displayed in both message display units when initial program loading is complete. Press appropriate HALT/RESET key to continue.

The updated programs are copied to the disk cartridge on R1. Copying is complete when EJ is displayed in the message display unit. Identify the cartridge on R1 as your updated tailored system disk cartridge. You now have identical updated tailored systems on R1 and F1.

Before continuing with maintenance, consider the following:

1. If you have other tailored system disk cartridges to be maintained, perform the procedures given under *Performing Disk Maintenance on the Tailored System Disk Cartridge* for each cartridge.
2. If you want to leave the identical updated tailored systems on F1 and R1 and you do not have any more tailored system disk cartridges to be maintained, system maintenance is complete.
3. If you want a minimal resident system on F1, perform the steps given under *Building a Minimal Resident System on F1*. The minimal resident system on F1 will consist of the system control programs needed to sustain the IPL process and read OCL statements.

### Building a Minimal Resident System on F1

1. Clear cards from MFCU.
2. Remove cards from stacker 1 and set them aside.
3. Punch the statements shown in Figure 51.
4. Place the statements in primary hopper of MFCU.
5. Press MFCU START.
6. Set program load selector at REMOVABLE DISK.
7. Press PROGRAM LOAD. Initial program loading is performed and, when complete, the system begins reading cards from the MFCU.

If your system has DPF, EJ is displayed in both message display units when initial program loading is complete. Press appropriate HALT/RESET key to continue.

An updated minimal resident system is built on F1 and is complete when EJ is displayed in the message display unit. System maintenance is complete.

*Note:* You can remove the updated tailored system disk cartridge on R1 at this time. Be sure to identify the disk cartridge as your updated tailored system disk cartridge. Be sure to copy data files (if any) back to F1.

```

1   4   8  12  16  20  24  28  32  36  40  44  48
// DATE 00/00/00
// LOAD $MAINT, R1
// RUN
// ALLOCATE TO-F1, SOURCE-0, OBJECT-0
// ALLOCATE TO-F1, SOURCE-4, OBJECT-40, SYSTEM-YES
// COPY FROM-R1, LIBRARY-0, NAME-SYSTEM, TO-F1
// END
    
```

*Note:* You can modify the second ALLOCATE statement in Figure 51 to increase or decrease the size of your libraries. You can also add more COPY statements after the COPY statement in Figure 51 if you want the Library Maintenance program, any disk utilities or any program products to be on F1.

Figure 51. Statements for Building a Resident System when Performing Disk Maintenance

### PROCEDURES FOR APPLYING PROGRAM TEMPORARY FIXES

#### Considerations Before Applying PTFs

Sometimes it is necessary to modify programs between normal maintenance releases of the system. Such program modifications are made available in the form of PTFs (Program Temporary Fixes). PTFs are applied to programs residing in the object library (on F1) by using the Field Engineering Maintenance program (\$SGPTF).

Perform the following before applying the PTFs.

1. Ensure that the system containing the Library Maintenance program (\$MAINT) and the programs or modules to which PTFs are to be applied resides on F1.
2. Examine the comment cards in each PTF deck to make certain that this is the required PTF.

#### Applying the PTF

1. Mount the user distribution disk cartridge (PID pack) on R1. This pack contains the Field Engineering Maintenance program (\$SGPTF).
2. Perform the IPL procedure from disk F1. Include the DATE statement at IPL time.
3. Clear the MFCU primary of cards and place the PTF deck into the MFCU primary hopper. The PTF deck contains the information to be inserted into a module or the replacement for a module. The PTF deck also includes the // LOAD and // RUN cards necessary to apply the information to the module(s) on F1.
4. Press MFCU START.
5. Press console START (or appropriate HALT/RESET key if you have DPF).

The PTFs are applied to the programs on F1; the procedure is complete when EJ is displayed in the message display unit. You can now copy the maintained programs on F1 to R1.

The first part of this appendix describes the IMAGE statement and how it is used. The second part of this appendix provides the possible IMAGE statement and data cards you need when you want to change the chain image during system generation.

**Description of the IMAGE Statement**

The printer requires characters matching those on the printer chain to be in a special area of storage called the chain-image area. When you replace the printer chain with one having different characters, you must also change the contents of the chain-image area.

The IMAGE statement instructs the system to replace the contents of the chain-image area with the characters indicated by the statement. The characters can be in cards, or in the source library on disk. The statement can appear anywhere among the OCL statements. The IMAGE statement format is:

**// IMAGE Parameter**

The IMAGE statement tells the system that either the new chain characters are to be read from cards or they are to be read from the source library.

The IMAGE parameters are:

- NAME - name
- UNIT - code
- FORMAT - HEXADECIMAL, CHARACTER, or MEMBER
- NUMBER - value

(Coding only HEX, CHAR, or MEM is preferable for FORMAT.)

**Characters on Cards**

If you want to indicate that the new chain characters are to be read from cards, use the following parameters:

**FORMAT:** Use CHAR to indicate that the characters are in EBCDIC form. The number of columns in the cards following the IMAGE statement that contain the new characters must not exceed 120. Use HEX to indicate that the characters are in hexadecimal form.

**NUMBER:** The number parameter must be used with HEX and CHAR. It must be a value equal to the number of columns in the cards following the IMAGE statement that contain the new characters. This number must not exceed 240 when the characters are hexadecimal; 120 when characters are EBCDIC. The name and UNIT parameters must not be coded.

Figure 52 shows an IMAGE statement. The statement tells the system that the new characters are on cards. The FORMAT parameter indicates that the new characters are in hexadecimal form. The NUMBER parameter indicates that there are 150 columns containing the new characters.

The following rules apply to punching the new characters into cards:

1. Characters must begin in column 1.
2. Consecutive card columns must be used; however, only the first 80 columns of the card can be used. Column 80, or the first blank, terminates the card. Hexadecimal requires an even number of characters for a card.
3. To continue characters in another card, begin the characters in column 1.

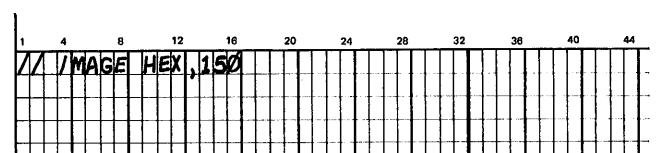

Figure 52. Sample IMAGE Statement: hexadecimal codes on cards.

### Characters From Source Library on Disk

To indicate that new chain characters are to be read from the source library on disk, the **FORMAT** parameter must be **MEM**. The following parameters must also be included:

**NAME:** The **NAME** parameter identifies the characters in the library. The only way you can place the cards containing the characters in the source library is by using the library maintenance program. The name you supply in library maintenance control statements is used to identify the characters in the source library.

**UNIT:** The **UNIT** parameter must be used with the **NAME** parameter. It tells the system where the disk containing the library is located on the disk unit. The codes are:

Code	Meaning
R1	Removable disk, drive one.
F1	Fixed disk, drive one.
R2	Removable disk, drive two.
F2	Fixed disk, drive two.

Figure 53 shows an **IMAGE** statement, which tells the system that the new characters are to be read from the source library on disk. The **FORMAT** parameter indicates that the new chain characters are in the source library. The **NAME** parameter indicates that the characters were named **CHAIN1** in the source library. The **UNIT** parameter indicates that the source library containing them is on the removable disk on drive one (**R1**).

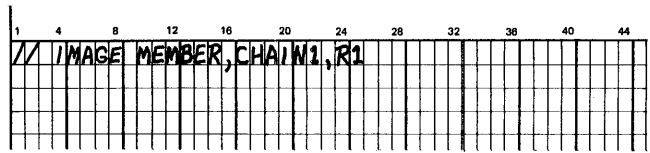

Figure 53. Sample **IMAGE** Statement: characters on disk.

### USING THE IMAGE STATEMENT TO CHANGE THE CHAIN IMAGE WHEN PERFORMING SYSTEM GENERATION

If you use a chain other than the standard 48-character chain, the **IMAGE** statement with proper data cards containing the characters of the chain must be prepared. The characters on the data cards can be in either hexadecimal code or **EBCDIC** form.

The **IMAGE** statement, together with data cards, places the image of the print chain in the communication area. The **IMAGE** statement must be followed by data cards that contain the hexadecimal codes (two columns per character) or the **EBCDIC** code for the characters in the printer chain. These data cards must contain an exact image of your print chain, character for character.

The **IMAGE** statement and data cards needed for the standard 48-character **LC** print arrangement chain, when you use hexadecimal codes, are shown in Figure 54. The ones needed when you use **EBCDIC** codes are shown in Figure 55.



IMAGE Statement:

1	4	8	12	16	20	24	28	32												
// IMAGE HEX, 06																				

Data Card 1:

1	4	8	12	16	20	24	28	32	36	40	44	48													
F1	F2	F3	F4	F5	F6	F7	F8	F9	F0	7B	7C	61	E2	E3	E4	E5	E6	E7	E8	E9	50	6B	6C		
Representing Characters																									
1	2	3	4	5	6	7	8	9	0	#	@	/	S	T	U	V	W	X	Y	Z	&	,	%		

Data Card 2:

1	4	8	12	16	20	24	28	32	36	40	44	48													
D1	D2	D3	D4	D5	D6	D7	D8	D9	60	5B	5C	1C	2C	3C	4C	5C	6C	7C	8C	94	E4	B7	D		
Representing Characters:																									
J	K	L	M	N	O	P	Q	R	-	\$	*	A	B	C	D	E	F	G	H	I	+	.	'		

Figure 54. IMAGE Statement and Data Cards for the Standard 48-Character LC Print Arrangement Chain When Using Hexadecimal Code

IMAGE Statement:

1	4	8	12	16	20	24	28	32	36	40	44	48												
// IMAGE CHAR, 4B																								

Data Card

1	4	8	12	16	20	24	28	32	36	40	44	48												
1234567890#@/STUVWXYZ&PJKL MNOPQR-\$ABCDEFGHI+.'"																								

Figure 55. IMAGE Statement and Data Card for the Standard 48-Character LC Print Arrangement Chain When Using EBCDIC Code



IMAGE Statement:

1	4	8	12	16	20	24	28	32	36	40	44	48
// IMAGE CHAR,60												

Data Card 1

1	4	8	12	16	20	24	28	32	36	40	44	48
1234567890XY/STUVW/:_!"#,=JKLMNOPQR-Z(ABCDEFGHIJ+.)												

Data Card 2

1	4	8	12	16	20	24	28	32	36	40	44	48
%&*#0@<.;'P>												

Figure 57. IMAGE Statement and Data Cards for the 60-Character PN Print Arrangement Chain When Using EBCDIC Code

### Procedures for Selecting IMAGE Statement and Data Cards at System Generation Time

1. Select the appropriate IMAGE statement and data cards.
2. Punch the IMAGE statement and data cards.
3. Place the IMAGE statement in front of the data cards.
4. Place the IMAGE statement and data cards between the // DATE mmddy and // CALL \$SGPCH,R1 statement punched when *Preparing for System Generation* in Chapter 9. *System Generation*.



During loading and execution the sort/collate program prints a job history on the printer. This printout includes a card image of the specifications cards, error messages, and informational messages that tell you what to do to continue the job. Some of these messages are accompanied by programmed halts. The halts are discussed in *IBM System/3 Disk System Halt Procedure Guide*, GC21-7540.

Sort/collate messages are printed in the following format:

SC xxx X (message)

- SC indicates the sort/collate program
- xxx is the message serial number
- X is the significance code:
  - A—Operator action required.
  - I—Information only.
  - W—Warning message. An abnormal, though possibly deliberate, condition exists. Check the program run sheet.
  - T—Terminal errors in the specification cards. These errors must be corrected before the job can be run.

Generation Phase Messages

SYSTEM/3 MODEL D SORT/COLLATE VERSION xx,  
MODIFICATION LEVEL xx xx/xx/xx

This heading is printed before the listing of the specification cards. The date is the date entered on the // DATE statement read after you performed the IPL process.

SC 011 W INVALID PRINT OPTION, COL. 27

Header card. Valid entries are blank, 0, 1, 2, or 3. All print (blank or 0) is assumed.

SC 009 W INVALID ALT. COLLATING SEQ. ENTRY,  
COL. 26

Header card. Column 26 must be blank or S. S alters the normal collating sequence. S is assumed.

SC 011 LARGEST TOTAL OF CONTROL FIELDS  
INVALID

Header card. Columns 7-12 must contain SORT, MERGE, MATCH, or SELECT. Job is terminated.

SC 011 T SUM OF LENGTHS OF CONTROL FIELDS  
INVALID

Header card. Columns 15-17 must contain a number from 1-100. Job is terminated.

SC 012 T SEQUENCE, COL. 18, NOT VALID

Header card. Sequence entry is not A or D or, in the case of a select run, is not A, D, or S. Job is terminated.

SC 013 T INVALID STACKER SELECT, COL. 19-24

Header card. Columns 19-24 must contain a number from 1-4 or be blank. Job is terminated.

SC 014 T INVALID NUMBER SPECIFICATION,  
COL. 25

Header card. For a MATCH job, entry in column 25 must be 1 or N. Job is terminated.

SC 015 A INVALID ALTERNATE COLLATING  
SEQUENCE CARD

An alternate collating sequence card is missing or unidentifiable (columns 1-8 not ALTSEQ blank blank), or a separator card (\*\*\*) is missing. The recovery procedure for this message is listed under the E5 halt in *IBM System/3 Disk System Halt Procedure Guide*, GC21-7540.

SC 016 T ALTERNATE COLLATING SEQUENCE  
DATA INVALID

Entries on ALTSEQ cards must consist of 4-column sets of hexadecimal characters (A-F and 0-9). Asterisks are printed under invalid or missing entries. Job is terminated.

SC 017 T INVALID SPECIFICATION TYPE, COL. 6

Column 6 is not I, O, or F (or H for first card). Card is bypassed.

SC 018 W FIRST SPEC. IN SET NEEDS BLANK  
CONTINUATION

Column 7 in the first record type specification of a set must be blank. Record type specifications have an I or O in column 6. Blank is assumed.

SC 019 T INVALID CONTINUATION, COL. 7

Column 7 of a record type specification (I or O in column 6) is not A, O, or blank. Card is bypassed.

SC 020 W INVALID C/Z/D/U SPECIFICATION, COL. 8	Entry in column 8 must be C, Z, D, or U except for forced fields, where only C, Z, and D are valid. <i>C is assumed.</i>
SC 021 T ILLEGAL ORDER OF SPECIFICATIONS	Specifications are out of order. This error is caused by: 1. Field specification (F in column 6) following an omit specification (O in column 6). 2. Omit specification (O in column 6) following an include specification (I in column 6). 3. Include-all following another include. Card is bypassed.
SC 022 T INCLUDE OR OMIT AFTER INCLUDE ALL	The include-all card must be the last record type card. Job is terminated.
SC 023 T NO CONTROL FIELD CARDS FOR RECORD TYPE	Control field cards must be used for all jobs except SELECT job with SELECT sequence. Job is terminated.
SC 024 T TOO MANY SOURCE CARDS OR ERRORS	The source cards and diagnostic messages, if any, require more core storage than is available. Reduce the number of source cards or correct the errors. Job is terminated.
SC 025 T ZONE SPECIFIED, FIELD LENGTH MORE THAN 1	When column 8 contains a Z, field length (columns 9-16) must be 1. Job is terminated.
SC 026 T COL. 9-16 OR 20-27 ARE INVALID	Entry in Factor 1, Factor 2, or location fields must be a number from 1 to 96. The number must be right-justified. Job is terminated.
SC 027 T DIGIT OR UNPACKED FIELD LENGTH EXCEEDS 16	When column 8 contains a D or U, field length (columns 9-16 or 20-27) cannot be greater than 16. Job is terminated.
SC 028 T FACTOR 1 LENGTH EXCEEDS 20 FOR CONSTANT	When columns 8 and 19 contain C, the length specified in Factor 1 (columns 9-16) cannot exceed 20. Job is terminated.
SC 029 W SAME SPEC TYPE AS PREVIOUS ASSUMED, COL. 6	Column 6 is blank. If column 7 contains A or O and the preceding spec had an I or O in column 6, I or O from preceding record spec is assumed.
SC 030 W OR CONTINUATION ASSUMED, COL. 7	Column 7 is blank; therefore, an OR condition is assumed. O is assumed.
SC 031 T ZONE SPECIFIED, FACTOR 2 NOT A CONSTANT	When column 8 contains a Z, Factor 2 must be a constant. Job is terminated.
SC 032 T ZONE SPECIFIED, RELATIONSHIP NOT EQ OR NE	When column 8 contains a Z, EQ or NE must be entered in columns 17-18. Job is terminated.

SC 033 T INVALID RELATIONSHIP, COL. 17-18	Columns 17-18 must contain EQ, NE, LT, GT, LE, or GE. Job is terminated.
SC 034 T INVALID FACTOR 2 TYPE, COL. 19	Column 19 must contain C or F. Job is terminated.
SC 035 W DEFAULT STACKER, NO. 1 ASSUMED, COL. 9	Column 9 must contain 1, 2, or 3. 1 is assumed.
SC 036 W UNPACKED FACTOR 1 USED WITH ALTSEQ	Factor 1 and Factor 2 are changed as indicated by ALTSEQ statements. This change may affect the units position (and sign) of an unpacked decimal number. If it does, you may not include or omit the desired records. Do not use U (unpacked) record type entries when you specify alternate collating sequence.
SC 040 W INVALID CONTROL FIELD TYPE, COL. 7	Column 7 must contain N, O, or F. N is assumed.
SC 041 W OPPOSITE SPECIFIED, COL. 7. ONLY D AND U ARE VALID	When column 7 contains an O, column 8 must contain a D or U. D is assumed.
SC 042 TOTAL LENGTH OF CONTROL FIELDS EXCEEDED	Sum of control field lengths is greater than length specified on header card. Job is terminated.
SC 040 W INVALID CONTROL FIELD TYPE, COL. 7	Column 7 must contain N, O, or F. N is assumed.
SC 041 W OPPOSITE SPECIFIED, COL. 7. ONLY D IS VALID	When column 7 contains an O, column 8 must contain a D. D is assumed.
SC 042 T CONTROL FIELD GREATER THAN SUM OF LENGTHS	Sum of control field lengths is greater than length specified on header card. Job is terminated.
SC 043 T ILLEGAL FORCE SEQUENCE CONTINUATION	Force-all line with continuation entry in column 19 can only follow a force spec. Job is terminated.
SC 090 I END OF GENERATION PHASE	All specification cards have been read and processed. The Sort/Collate program now prints one of the next three messages.
SC 091 I NO ERRORS IN SOURCE DECK	The specification cards were processed successfully. The Sort/Collate program is ready to do the job. The recovery procedures for this message are listed under the EE halt in <i>IBM System/3 Disk System Halt Procedure Guide</i> , GC21-7540.
SC 092 A REVIEW WARNING MESSAGE	There are no known errors in source deck; however, abnormal conditions as defined by warning messages exist. The recovery procedures for this message are listed under the EL halt in <i>IBM System/3 Disk System Halt Procedure Guide</i> , GC21-7540.
SC 093 A ERRORS IN SOURCE DECK, JOB TERMINATED	The job cannot be completed because of errors in the source deck. The recovery procedure for this message is listed under the EA halt in <i>IBM System/3 Disk System Halt Procedure Guide</i> , GC21-7540.



Execution Phase Messages

*Sort Job*

SC 101 I SORT/COLLATE – SORT JOB – PASS nnnnn

Heading for each pass of a sort job. nnnnn is the number of the pass just completed.

SC 105 I NUMBER OF OMIT CARDS nnnnn

On a sort with omits, nnnnn is the number of omitted cards selected to stackers 2 and 4.

SC 107 I NUMBER OF DATA CARDS nnnnn

nnnnn is the number of cards being sorted. This number does not include a count of omitted cards. Any time the number of cards read does not agree with the number of cards read on the preceding pass, the card count is followed by \*\*\*.

SC 109 I REMAINING STRINGS nnnnn

Strings are groups of sequenced cards.

SC 111 I MAXIMUM PASSES LEFT nnnnn

nnnnn is the maximum number of passes remaining to complete the sort. It is possible that the job will be completed in less passes.

SC 121 A STACKS 1, 2 TO PRI – STACKS 3, 4 TO SEC

Instructions for intermediate passes of a sort job where cards have been selected to all four stackers. Reposition cards as follows:

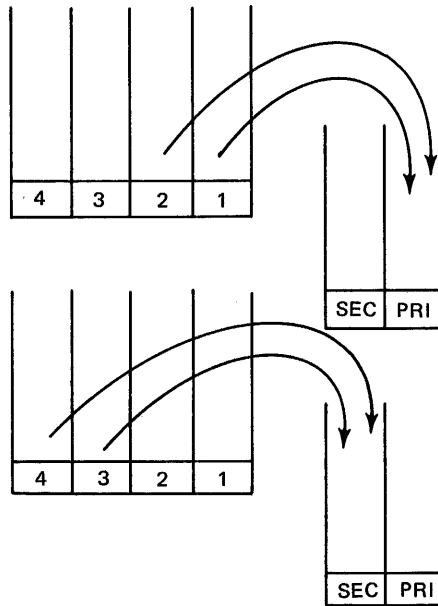

SC 123 A SHORT STRINGS TO PRI AND SEC – CLEAR STACK 1

Instructions for intermediate pass of sort job where cards have been selected to three of the four stackers. Take the smallest group of cards from a stacker and place it in a hopper. It doesn't matter which hopper. Take the next smallest group and place it in the other hopper. This leaves the largest group of cards in a stacker. If these cards are in stacker 2, 3, or 4, they can remain where they are. If they are in stacker 1, remove them from the stacker and set them aside for the next pass.

SC 125 A FEED STACK 1 TO PRI – STACK 3 TO SEC

Printed on omit pass to indicate positioning of data cards for start of sort. Also printed on sort job where cards have been selected to two of four stackers. Reposition cards as follows:

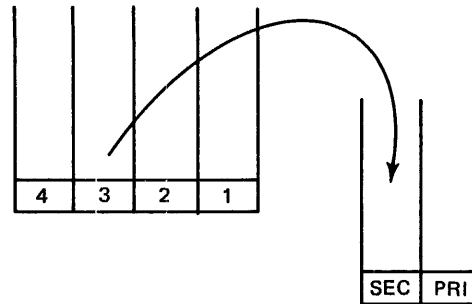
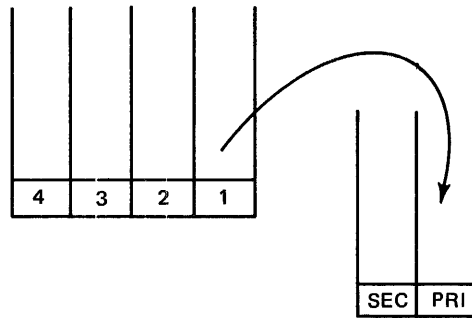

SC 127 A SET ASIDE CARDS FROM STACKS 2 AND 4

On an omit pass, the cards in stackers 2 and 4 are the omitted cards. Set these cards aside before continuing.

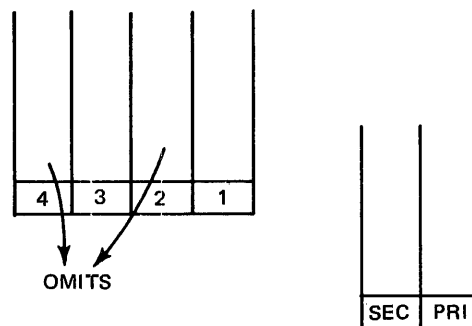

SC 129 A OUTPUT IN STACK 1 – OMITTS IN STACKS 2 AND 4

This message indicates that all sorting was completed during the omit pass.

SC 131 A ONE STRING TO PRI AND OTHER TO SEC

Instructions for final pass following a three stack pass. Place the cards from stacker 1 in a hopper. It doesn't matter which one. Place the other group of cards in the other hopper. These cards are in stacker 2, 3, or 4, or were set aside for the last pass.

SC 197 A PRESS MFCU START AND CONSOLE START

Instructions for starting next pass.

SC 199 A SORTING COMPLETED

The job is finished. The sorted cards are in stacker 1.

*Merge Job*

SC 201 I SORT/COLLATE—MERGE JOB

Heading for merge job.

SC 211 I MERGED CARDS nnnnn

Total of cards merged and selected to stacker 1. This number does not include any cards omitted to stackers 2 and 4.

SC 221 I PRIMARY OMIT CARDS nnnnn

nnnnn is the number of cards omitted from the primary hopper and selected into stacker 2.

SC 231 I SECONDARY OMIT CARDS nnnnn

nnnnn is the number of cards omitted from the secondary hopper and selected into stacker 4.

SC 241 A SEQUENCE ERROR —XXX

Cards are out of sequence in XXX, where XXX is PRI or SEC. The recovery procedures for this message are listed under the E1 (primary) or E2 (secondary) halts in *IBM System/3 Disk System Halt Procedure Guide*, GC21-7540.

SC 251 I MERGING COMPLETED

The job is finished. The merged cards are in stacker 1.

*Match Job*

SC 301 I SORT/COLLATE—MATCH JOB

Heading for match job.

SC 311 I PRIMARY MATCHED CARDS nnnnn

nnnnn is the number of matched cards from the primary hopper.

SC 321 I SECONDARY MATCHED CARDS nnnnn

nnnnn is the number of matched cards from the secondary hopper.

SC 331 I PRIMARY UNMATCHED CARDS nnnnn

nnnnn is the number of unmatched cards from the primary hopper.

SC 341 I SECONDARY UNMATCHED CARDS nnnnn

nnnnn is the number of unmatched cards from the secondary hopper.

SC 351 I PRIMARY OMIT CARDS nnnnn

nnnnn is the number of omitted cards from the primary hopper.

SC 161 I SECONDARY OMIT CARDS nnnnn

nnnnn is the number of omitted cards from the secondary hopper.

SC 371 A SEQUENCE ERROR — XXX

Cards are out of sequence in XXX, where XXX is PRI or SEC. The recovery procedures for this message are listed under the E1 (primary) or E2 (secondary) halts in *IBM System/3 Disk System Halt Procedure Guide*, GC21-7540.

SC 381 A MATCHING COMPLETED

The job is finished. The matched and unmatched cards are in the stackers designated by the programmer on the program run sheet.

*Select Job*

SC 401 I SORT/COLLATE – SELECT JOB

Heading for select job.

SC 411 I INCLUDED CARDS – STACK 1 nnnnn

nnnnn is the number of cards in stacker 1.

SC 421 I INCLUDED CARDS – STACK 2 nnnnn

nnnnn is the number of cards in stacker 2.

SC 431 I INCLUDED CARDS – STACK 3 nnnnn

nnnnn is the number of cards in stacker 3.

SC 441 I OMITTED CARDS nnnnn

nnnnn is the number of non-selected cards routed to stacker 4.

SC 451 A SEQUENCE ERROR–PRI

Cards are out of sequence in the primary hopper. The recovery procedure for this message is included under the E1 halt in *IBM System/3 Disk System Halt Procedure Guide*, GC21-7540.

SC 461 A SELECTING COMPLETED

The job is finished. The selected cards can appear in all stackers except stacker 4.

A sample RPG II program is in a procedure on the distribution disk cartridge and must be punched out. The RPG II sample program actually consists of two individual programs (SAMPL1 and SAMPL2). The SAMPL2 program must be run after the SAMPL1 program since SAMPL2 program uses the output of the SAMPL1 program. The sample programs must be run after system generation is complete. The successful execution of the sample programs indicates that your system has been generated properly. Instructions on how to obtain punched cards and the operating instructions, source listings, and object program printouts are shown in the following paragraphs. For a description of what this program is doing and how it is doing it, see *IBM System/3 Disk System RPG II Reference Manual, GC21-7504*.

**Obtaining the Sample Programs**

1. Mount distribution disk cartridge on R1 and ready disks.
2. Set program load selector to FIXED DISK.
3. Punch the following statements:

```

1  4  8 12 16 20 24 28 32 36 40 44 48
// DATE 02/02/00
// LOAD MAINT,R1
// RUN
// COPY FROM-R1,TO-PRTPCH,LIBRARY-S,NAME-SRPSPL
// END
  
```

4. Remove any cards from the stackers.
5. Press MFCU NPRO. Any cards in the wait station are fed into stacker 1.
6. Place punched statements in primary hopper of MFCU.
7. Place blank cards in secondary hopper of MFCU.
8. Press MFCU START.

9. Ready printer.
10. Press PROGRAM LOAD. Initial program loading is performed and, when complete, the system begins reading cards from the MFCU.

The system punches the RPG II sample program cards and routes them to stacker 4. When the punching is complete, EJ is displayed in the message display unit.

11. Press MFCU NPRO. One card is fed into stacker 1.
12. Raise any cards in secondary hopper and press MFCU NPRO. One card is fed into stacker 1.
13. Remove cards from stacker 1 and discard them.
14. Remove punched cards from stacker 4.
15. Remove top and bottom cards from the deck and discard them. The punched deck of cards consists of four parts:

- OCL and source statements needed to compile SAMPL1 program.
- OCL and source statements needed to compile SAMPL2 program.
- OCL and data statements needed to execute SAMPL1 program.
- OCL statements needed to execute SAMPL2 program.

16. You must place three end-of-file (/\* in columns 1 and 2) cards in the deck as follows:
  - a. Insert one /\* card at the end of the SAMPL1 source statements. SAMPL1 source statements are identified by SAMPL1 in columns 75 through 80.
  - b. Insert one /\* card at the end of the SAMPL2 source statements. SAMPL2 source statements are identified by SAMPL2 in columns 75 through 80.
  - c. Insert one /\* card after the SAMPL1 DATA card.

### Compiling the SAMPL1 Program

1. Remove distribution disk cartridge.
2. Mount tailored system disk cartridge and ready disks.
3. Punch a current DATE statement and place it in primary hopper.
4. Place the sample program deck in primary hopper of MFCU. Load cards face down, top edge to the left.
5. Press MFCU START. PRIMARY READY light turns on. SECONDARY READY light turns on if there are any cards in the secondary hopper.
6. Ready printer.
7. Set program load selector at REMOVABLE DISK.
8. Press PROGRAM LOAD. Initial program loading is performed and, when complete, the system begins reading cards from the MFCU.

If your system has DPF, EJ is displayed in the message display unit when initial program loading is complete. Set dual program control switch at program 1 MFCU and press INTERRUPT.

The SAMPL1 program is compiled. During the compilation of the SAMPL1 program, halt 19 will occur. This halt occurs because an error was found in the SAMPL1 program. The error is expected and the compilation can continue.

9. When halt 19 occurs, set rightmost address/data switch at 0 and press console START or program 1 HALT/RESET key if you have DPF to continue.

EJ is displayed in the message display unit when the SAMPL1 program is compiled. The SAMPL1 object program is on disk.

### Compiling the SAMPL2 Program

Press console START or program 1 HALT/RESET key if you have DPF. EJ is displayed in the message display unit when the SAMPL2 program is compiled. The SAMPL2 object program is on disk.

### Executing the SAMPL1 Program

Press console START or program 1 HALT/RESET key if you have DPF. The SAMPL1 object program is executed, the output printed, and is complete when EJ is displayed in the message display unit.

### Executing the SAMPL2 Program

Press console START or program 1 HALT/RESET key if you have DPF. The SAMPL2 object program is executed and the output is printed. The program is complete when EJ is displayed in the message display unit.

SAMPL 1 Source Program Printout

```
// LOG PRINTER
// DATE 07/17/70
// CALL RPG,R1
XX LOAD $RPG,R1
XX FILE NAME=$SOURCE,UNIT-R1,PACK-SYSTEM,RETAIN-S,TRACKS-10
XX FILE NAME=$WORK,UNIT-R1,PACK-SYSTEM,RETAIN-S,TRACKS-10
XX RUN
// RUN
```

SYSTEM/3 MODEL D

RPGII VERSION 00, MODIFICATION LEVEL 00

07/17/70

```
0-101 H      008                                     SAMPL1

0102 F*****
0103 F*
0104 F* THIS PROGRAM -
0105 F*
0106 F* 1. LOADS 100 RECORDS TO AN INDEXED FILE.
0107 F*
0108 F* 2. READS ONLY A BLANK CARD AND A /* CARD AS
0108 F* INPUT DATA.
0109 F*
0110 F* 3. CREATES THE OUTPUT DATA USING A
0111 F* LOOP IN THE CALCULATION SPECIFICATIONS.
0112 F*
0113 F* 4. USES KEYS FROM 000005 THROUGH 000500
0114 F* IN INCREMENTS OF 5.
0115 F*
0116 F* 5. SHOULD BE FOLLOWED BY SAMPLE PROGRAM 2
0117 F* TO VERIFY THAT THE FILE WAS PROPERLY
0118 F* LOADED.
0119 F*
0120 F*****
0001 0121 FCARDIN IPE F 96 96 MFCU1
0002 0122 FDISKOUT D F 256 128 06A1 1 DISK 01
0003 0123 FPRINTER D F 96 96 PRINTER SAMPL1

0004 0201 ICARDIN NS 01 1 C SAMPL1
0005 0202 I 1 1 NODATA SAMPL1

0006 0301 C 01 Z-ADD0 COUNT 60 SAMPL1
0007 0302 C 01 Z-ADD0 RECNR 30 SAMPL1
0008 0303 C REPEAT TAG SAMPL1
0009 0304 C 01 COUNT ADD 5 COUNT SAMPL1
0010 0305 C 01 RECNR ADD 1 RECNR SAMPL1
0011 0306 C 01 COUNT COMP 505 02 SAMPL1
0012 0307 C 01N02 EXCPT SAMPL1
0013 0308 C 01N02 GOTO REPEAT SAMPL1
0014 0309 CLR RECNR SUB 1 RECNR SAMPL1

0015 0401 OPRINTER T 204 LR SAMPL1
0016 0402 D 20 *SAMPLE PROGRAM 1 HAS* SAMPL1
0017 0403 D 27 *LOADED* SAMPL1
0018 0404 D RECNRZ 31 SAMPL1
0019 0405 D 39 *RECORDS* SAMPL1
0020 0406 D 61 *INTO AN INDEXED FILE.* SAMPL1
0021 0408 D T 2 LR SAMPL1
0022 0409 D 21 *KEYS ARE IN ASCENDING* SAMPL1
0023 0410 D 42 *SEQUENCE STARTING AT* SAMPL1
0024 0411 D 64 *000005 AND INCREASING* SAMPL1
```

0025	0412	0			84	'IN INCREMENTS OF 5.'	SAMPL1
0026	0413	0	T	01 LR			SAMPL1
0027	0414	0			21	'SAMPLE PROGRAM 2 WILL'	SAMPL1
0028	0415	0			44	'PRINT FROM THE INDEXED'	SAMPL1
0029	0416	0			65	'FILE TO SHOW THAT IT'	SAMPL1
0030	0417	0			86	'WAS PROPERLY LOADED.'	SAMPL1
0031	0501	0	ODISKOUT E	01N02			SAMPL1
0032	0502	0			COUNT	6	SAMPL1
0033	0503	0				94	'RECORD NUMBER'
0034	0504	0			RECNR	128	SAMPL1

INDICATORS USED  
LR 01 02

RG 314 UNREFERENCED FIELD NAMES

STMT#	NAME	DEC	LGTH	DISP
0005	NODATA		001	0100

FIELD NAMES USED

STMT#	NAME	DEC	LGTH	DISP
0005	NODATA		001	0100
0006	COUNT	0	006	0106
0007	RECNR	0	003	0109

ERROR SEVERITY

RG 314 W FIELD, TABLE OR ARRAY NAME DEFINED BUT NEVER USED.

TEXT

START ADDR	NAME IF OVERLAY	CODE LENGTH	NAME	TITLE	CORE USAGE OF RPGII CODE
0000		052C	RGROOT	ROOT	
12E2		000E	RGSUBS	CONSTANTS	
1238		00AA	RGSUBS	OUTPUT CTRL RTN	
122C		000C	RGSUBS	SUBSEG	
		0160	\$\$LPRT	S203 PRINT	
1350		0082	RGMAIN	INPUT MAINLINE	
12F8		0058	RGSUBS	INPUT CTRL RTN	
13D2		003A	RGSUBS	RECORD ID	
140C		0026	RGSUBS	CONTROL FIELDS	
12F0		0008	RGSUBS	SUBSEG	
		0145	\$\$MFRD	MFCU READ	
1432		0008	RGMAIN	TOTAL CALCS	
143D		0022	RGMAIN	INPUT FIELDS	
1470		0048	RGMAIN	DETAIL CALCS	
146B		0005	RGSUBS	CONSTANTS	
		004D	\$\$PGRI	RESET RESULTING INDR	
14B8		0031	RGSUBS	EXCEPTION	
145F		000C	RGSUBS	SUBSEG	
		005E	\$\$IQUT	DISK INDEXED OUTPUT	
		0093	\$\$SRBI	SYSTEM SUBR	
		0026	\$\$SRUA	SYSTEM SUBR	
		0078	\$\$SRBR	SYSTEM SUBR	
		001C	\$\$SRDF	SYSTEM SUBR	
		001C	\$\$SRTC	SYSTEM SUBR	
		0015	\$\$SRPD	SYSTEM SUBR	
		0019	\$\$SRCR	SYSTEM SUBR	
		002F	\$\$SRBP	SYSTEM SUBR	
		0081	\$\$SRMO	SYSTEM SUBR	
		0043	\$\$SRSB	SYSTEM SUBR	
		0015	\$\$SRRD	SYSTEM SUBR	
14E9		0008	RGMAIN	TOTAL OUTPUT	
1511		0024	RGMAIN	LR & OVERFLOW PROCESSING	
14F4		001D	RGSUBS	OVERFLOW SUBSEGMENT	
1632		0025	RGMAIN	CLOSE	
1535		00E9	RGSUBS	CONSTANTS	
1657		0076	RGSUBS	LR PROCESSING	
161E		0014	RGSUBS	LR CALCS	
16CD		0072	RGMAIN	OPEN	
		04509	SAMPL1	TOTAL CORE USAGE	

55241



SAMPL 2 Source Program Printout

```
// CALL RPG,R1
XX LOAD $RPG,R1
XX FILE NAME=$SOURCE,UNIT-R1,PACK-SYSTEM,RETAIN-S,TRACKS-10
XX FILE NAME=$WORK,UNIT-R1,PACK-SYSTEM,RETAIN-S,TRACKS-10
XX RUN
// RUN
```

SYSTEM/3 MODEL D

RPGII VERSION 00, MODIFICATION LEVEL 00

07/17/70

```
0101 H      008                                     SAMPL2

0102 F*****
0103 F*
0104 F* THIS PROGRAM -
0105 F*
0106 F* 1. MUST BE PRECEDED BY SAMPLE PROGRAM 1
0107 F* WHICH LOADS AN INDEXED FILE.
0108 F*
0109 F* 2. READS AN INDEXED FILE SEQUENTIALLY.
0110 F*
0111 F* 3. USES A BLOCK LENGTH FOR DISK WHICH
0112 F* IS DIFFERENT FROM THAT USED FOR
0113 F* LOADING THE FILE IN SAMPLE PROGRAM 1.
0114 F*
0115 F* 4. COUNTS THE NUMBER OF RECORDS READ SO
0116 F* THAT THE USER CAN QUICKLY VERIFY THAT
0117 F* 100 RECURDS WERE LOADED.
0118 F*
0119 F*****
0001 0120 FDISKIN IPE F 512 128 06AI 1 DISK 01 SAMPL2
0002 0121 FPRINTER 0 F 96 96 OF PRINTER SAMPL2

0003 0201 IDISKIN NS 01 1 C0 SAMPL2
0004 0202 I 1 6 KEY SAMPL2
0005 0203 I 82 94 DESC SAMPL2
0006 0204 I 126 1280RECNR SAMPL2

0007 0301 C 01 COUNT ADD 1 COUNT 30 SAMPL2

0008 0401 OPRINTER H 204 1P SAMPL2
0009 0402 O OR OF SAMPL2
0010 0403 O 5 'KEY' SAMPL2
0011 0404 O 22 'DESCRIPTION' SAMPL2
0012 0405 O 30 'PAGE' SAMPL2
0013 0406 O PAGE Z 35 SAMPL2
0014 0407 O D 1 01 SAMPL2
0015 0408 O KEY 6 SAMPL2
0016 0409 O DESC 21 SAMPL2
0017 0410 O RECNRZ 25 SAMPL2
0018 0411 O T 3 01 LR SAMPL2
0019 0412 O COUNT Z 3 SAMPL2
0020 0413 O 26 'RECORDS WERE READ FROM' SAMPL2
0021 0414 O 44 'THE INDEXED FILE.' SAMPL2
```

INDICATORS USED  
LR OF 1P 01

FIELD NAMES USED

STMT#	NAME	DEC	LGTH	DISP
0013	PAGE	0	004	011C
0004	KEY		006	0105
0005	DESC		013	0112
0006	RECNR	0	003	0115
0007	COUNT	0	003	0118

START	NAME	IF	CODE	NAME	CORE USAGE OF RPGII CODE
ADDR	OVERLAY	LENGTH		TITLE	
0D00			06AC	RGROOT	ROOT
13AC			00AA	RGSUBS	OUTPUT CTRL RTN
1456			0017	RGSUBS	CONSTANTS
146D			0028	RGSUBS	SUBSEG
			0160	\$\$LPRT	5203 PRINT
14F5			0091	RGMAIN	INPUT MAINLINE
149D			0058	RGSUBS	INPUT CTRL RTN
1586			003A	RGSUBS	RECORD ID
15C0			0026	RGSUBS	CONTROL FIELDS
1495			0008	RGSUBS	SUBSEG
			003B	\$\$ISIP	DISK IDX SEQ INPUT
			0019	\$\$SRCR	SYSTEM SUBR
			007B	\$\$SRBR	SYSTEM SUBR
			002C	\$\$SRIF	SYSTEM SUBR
			0081	\$\$SRRC	SYSTEM SUBR
			0029	\$\$SRRI	SYSTEM SUBR
			0043	\$\$SRIC	SYSTEM SUBR
			001C	\$\$SRTC	SYSTEM SUBR
			0081	\$\$SRMO	SYSTEM SUBR
			0043	\$\$SRSB	SYSTEM SUBR
			0015	\$\$SRRD	SYSTEM SUBR
			002F	\$\$SRBP	SYSTEM SUBR
			0015	\$\$SRPD	SYSTEM SUBR
15E6			002C	RGMAIN	INPUT FIELDS
1613			0010	RGMAIN	DETAIL CALCS
1612			0001	RGSUBS	CONSTANTS
1634			0033	RGMAIN	DETAIL OUTPUT
162F			0005	RGSUBS	CONSTANTS
1623			000C	RGSUBS	SUBSEG
1667			000B	RGMAIN	TOTAL OUTPUT
1696			0024	RGMAIN	LR & OVERFLOW PROCESSING
1672			0024	RGSUBS	OVERFLOW SUBSEGMENT
16BA			008E	RGMAIN	OPEN
1774			0019	RGMAIN	CLOSE
1748			002C	RGSUBS	CONSTANTS
178D			0030	RGSUBS	LR PROCESSING
			04606	SAMPL2	TOTAL CORE USAGE

SAMPL 1 Object Program Printout

```
// LOAD SAMPL1,R1
// FILE NAME-DISKOUT,UNIT-R1,RETAIN-S,RECORDS-125,PACK-SYSTEM
// RUN
SAMPLE PROGRAM 1 HAS LOADED 100 RECORDS INTO AN INDEXED FILE.
```

KEYS ARE IN ASCENDING SEQUENCE STARTING AT 000005 AND INCREASING IN INCREMENTS OF 5.

SAMPLE PROGRAM 2 WILL PRINT FROM THE INDEXED FILE TO SHOW THAT IT WAS PROPERLY LOADED.

55243

SAMPL 2 Object Program Printout

```
// LOAD SAMPL2,R1
// FILE NAME-DISK IN,UNIT-R1,LABEL-DISKOUT,PACK-SYSTEM
// RUN
```

KEY	DESCRIPTION	PAGE	1
000005	RECORD NUMBER	1	
000010	RECORD NUMBER	2	
000015	RECORD NUMBER	3	
000020	RECORD NUMBER	4	
000025	RECORD NUMBER	5	
000030	RECORD NUMBER	6	
000035	RECORD NUMBER	7	
000040	RECORD NUMBER	8	
000045	RECORD NUMBER	9	
000050	RECORD NUMBER	10	
000055	RECORD NUMBER	11	
000060	RECORD NUMBER	12	
000065	RECORD NUMBER	13	
000070	RECORD NUMBER	14	
000075	RECORD NUMBER	15	
000080	RECORD NUMBER	16	
000085	RECORD NUMBER	17	
000090	RECORD NUMBER	18	
000095	RECORD NUMBER	19	
000100	RECORD NUMBER	20	
000105	RECORD NUMBER	21	
000110	RECORD NUMBER	22	
000115	RECORD NUMBER	23	
000120	RECORD NUMBER	24	
000125	RECORD NUMBER	25	
000130	RECORD NUMBER	26	
000135	RECORD NUMBER	27	
000140	RECORD NUMBER	28	
000145	RECORD NUMBER	29	
000150	RECORD NUMBER	30	
000155	RECORD NUMBER	31	
000160	RECORD NUMBER	32	
000165	RECORD NUMBER	33	
000170	RECORD NUMBER	34	
000175	RECORD NUMBER	35	
000180	RECORD NUMBER	36	
000185	RECORD NUMBER	37	
000190	RECORD NUMBER	38	
000195	RECORD NUMBER	39	
000200	RECORD NUMBER	40	
000205	RECORD NUMBER	41	
000210	RECORD NUMBER	42	
000215	RECORD NUMBER	43	
000220	RECORD NUMBER	44	
000225	RECORD NUMBER	45	
000230	RECORD NUMBER	46	
000235	RECORD NUMBER	47	
000240	RECORD NUMBER	48	
000245	RECORD NUMBER	49	
000250	RECORD NUMBER	50	
000255	RECORD NUMBER	51	
000260	RECORD NUMBER	52	
000265	RECORD NUMBER	53	
000270	RECORD NUMBER	54	
000275	RECORD NUMBER	55	

55244

KEY	DESCRIPTION	PAGE	2
000280	RECORD NUMBER	56	
000285	RECORD NUMBER	57	
000290	RECORD NUMBER	58	
000295	RECORD NUMBER	59	
000300	RECORD NUMBER	60	
000305	RECORD NUMBER	61	
000310	RECORD NUMBER	62	
000315	RECORD NUMBER	63	
000320	RECORD NUMBER	64	
000325	RECORD NUMBER	65	
000330	RECORD NUMBER	66	
000335	RECORD NUMBER	67	
000340	RECORD NUMBER	68	
000345	RECORD NUMBER	69	
000350	RECORD NUMBER	70	
000355	RECORD NUMBER	71	
000360	RECORD NUMBER	72	
000365	RECORD NUMBER	73	
000370	RECORD NUMBER	74	
000375	RECORD NUMBER	75	
000380	RECORD NUMBER	76	
000385	RECORD NUMBER	77	
000390	RECORD NUMBER	78	
000395	RECORD NUMBER	79	
000400	RECORD NUMBER	80	
000405	RECORD NUMBER	81	
000410	RECORD NUMBER	82	
000415	RECORD NUMBER	83	
000420	RECORD NUMBER	84	
000425	RECORD NUMBER	85	
000430	RECORD NUMBER	86	
000435	RECORD NUMBER	87	
000440	RECORD NUMBER	88	
000445	RECORD NUMBER	89	
000450	RECORD NUMBER	90	
000455	RECORD NUMBER	91	
000460	RECORD NUMBER	92	
000465	RECORD NUMBER	93	
000470	RECORD NUMBER	94	
000475	RECORD NUMBER	95	
000480	RECORD NUMBER	96	
000485	RECORD NUMBER	97	
000490	RECORD NUMBER	98	
000495	RECORD NUMBER	99	
000500	RECORD NUMBER	100	

100 RECORDS WERE READ FROM THE INDEXED FILE.

55245

## Index

- A light 18
- ACU PWR OFF light 16
- ADDR INCREM switch 12
- ADDRESS COMPARE light 12
  - switch 12
- ADDRESS/DATA switches 11
- Assembler Program 122
  
- B light 18
- Basic Assembler Program
  - source execution 122
  - object execution 123
- Binary Synchronous Communications Adapter Panel lights
  - ACU PWR OFF 16
  - BSCA ATTN 15
  - BUSY 16
  - CALL REQUEST 16
  - CHAR PHASE 16
  - CLEAR TO SEND 16
  - CONTROL MODE 16
  - DATA MODE 16
  - DIGIT PRESENT 16
  - DT LINE IN USE 16
  - DT SET READY 15
  - DT TERM READY 15
  - EXT TEST SW 15
  - RECEIVE INITIAL 16
  - RECEIVE MODE 16
  - RECEIVE TRIGGER 16
  - TEST MODE 15
  - TSM MODE 15
  - TSM TRIGGER 16
  - UNIT CHECK 16
- switch
  - RATE SELECT 16
- BSC program
  - answering a call automatically 106
  - answering a call manually 106
  - compiling 104
  - execution 104
  - initiating a call automatically 105
  - initiating a call manually 105
  - nonswitched networks 105
  - switched networks 105
- BSCA ATTN light 15
- BSCA panel 15
- building a program pack
- BUSY light 16
  
- CALL REQUEST light 16
- CALL statement 97
- CANCEL key 75
- cancelling jobs, DPF 94
- card feed path 19
- card jam
  - clearing 19
  - indicators 19
- card maintenance 165
- card utilities 106
  
- carriage clutch 39
- CARRIAGE RESTORE key 32
- CARRIAGE SPACE key 32
- carrying handle, disk cartridge 62
- cartridge 62
- CE control panel 12, 13
- CE KEY switch 12
- CE mode selector 13
- chain cartridge
  - installing 48-character 54
  - installing 60-character 56
  - removal 50
- chain image data cards 177
- chain interlock 32, 88
- CHAR PHASE light 16
- CHECK light 32
- CHECK RESET light 12
- CHIP light 18
- chip box, emptying 30
- chute interlock 32, 88
- CLEAR TO SEND light 16
- clearing
  - card jam 19
  - cards from MFCU 84
  - I/O ATTENTION 88
- CLOCK lights 11
- compilation procedures 98
- COMPILE statement 97
- completing system generation
  - building a minimal system 157
  - copying tailored system 157
  - example print out 159
- configuration statements, system generation 141-144
- Console Error Log Sheet 89, 90
- console, processing unit 8
- CONTROL MODE light 16
- controls
  - customer engineer 12, 13
  - disk 13
  - dual program control 14
  - emergency power off 10
  - MFCU 17
  - printer 31
  - printer-keyboard 73
  - processing unit 8, 11
  - system 9
- core storage dump
  - considerations 92
  - procedures 92
  - reasons for taking 92
- corner station, removing cards 22
- customer engineer control panel 12, 13
- CVR light 18
- cycle control display
  
- data cards, chain image 177
- DATA MODE light 16
- data switches
- Data Record Program 118
- Data Verify Program 119

DATE statement  
   format 86  
   use 86, 96  
 diagnostics only run, RPG II 98  
 DIGIT PRESENT light 16  
 disk cartridge  
   bottom cover 62  
   carrying handle 62  
   mounting 64  
   release button 62  
   removing 68  
   storage 62  
 disk  
   drive 64  
   maintenance 169  
   panel 13  
   storage drawer  
     clamp arm 63  
     disk drive 64  
     drawer stops 63  
 Disk Copy/Dump Program, procedures 125  
 Disk Sort Program 120  
 Disk Utility Programs  
   description 124  
   procedures 124  
 DPF 14  
 DT LINE IN USE light 16  
 DT SET READY light 15  
 DT TERM READY light 15  
 dual program control panel 14  
 dual program control switch 14  
 dual program feature 14  
 dual program operation  
   loading jobs 93  
   cancelling jobs 94  
 dummy tractors 35  
  
 emergency power off and meter panel 10  
 emergency pull switch 10  
 END key 75  
 error log sheet 89, 90  
 executing 1-type programs, RPG II 102  
 EXT TEST SW light 15  
  
 fabric ribbon cartridge  
   installing 79  
   removing 78  
 FILE statement 97  
 FILE WRITE switch 12  
 fixed disk 64  
 FORMS light 32  
 forms, printer  
   lateral adjustment 40  
   loading 34  
   print density 39  
   stacker 43  
   vertical adjustment 39  
 forms, printer-keyboard  
   loading 81  
 FORMS statement 97  
  
 halt indicator 9, 14  
 HALT/RESET key 14  
 HALT statement 97  
 hopper station, removing cards 20  
 HPR light 18

IMAGE statement 97, 175  
 impression selector, adjusting 77  
 indicators  
   MFCU 18  
   printer 32  
   printer-keyboard 75  
   processing 8  
   test 11  
 initial program load 84  
 initiating IPL from MFCU 86  
 INT LEV light 11  
 INTERLOCK light 32  
 interpret 110  
 INTERRUPT key/light 15  
 IPL 84  
 IPL process 84  
 I/O ATTENTION  
   light 9  
   not ready 9, 88  
 I/O CHECK  
   light 12  
   switch 12  
 I/O OVERLAP switch 12  
  
 key  
   CANCEL 75  
   CARRIAGE RESTORE 32  
   CARRIAGE SPACE 32  
   END 75  
   HALT/RESET 14  
   INTERRUPT 15  
   LAMP TEST 11, 18  
   LOCK 32  
   NPRO 18  
   PROGRAM LOAD 9  
   REQ 75  
   RETURN 75  
   SHIFT 32  
   SPACE 32  
   START  
     MFCU 18  
     printer 32  
     processing unit 9  
   STOP  
     MFCU 18  
     printer 32  
     processing unit 9  
   SYSTEM RESET 12  
   keyboard 75  
  
 lamps  
   MFCU 18  
   printer 32  
   printer-keyboard 75  
   processing unit 8  
   test 11  
 LAMP TEST key 11, 18  
 lateral adjustment, printer 40  
 library maintenance, procedures 126

light

ACU PWR OFF 16  
BSCA ATTN 15  
BUSY 16  
CALL REQUEST 16  
CHAR PHASE 16  
CHECK 32  
CHECK RESET 12  
CHIP 18  
CLEAR TO SEND 16  
CLOCK 11  
CONTROL MODE 16  
CVR 18  
DATA MODE 16  
DIGIT PRESENT 16  
DT LINE IN USE 16  
DT SET READY 15  
DT TERM READY 15  
EXT TEST SW 15  
FORMS 32  
HPR 18  
INT LEV 11  
INTERLOCK 32  
INTERRUPT 15  
I/O ATTENTION 9  
I/O CHECK 12  
MACHINE CYCLE 11  
NPRO 18  
OPEN 13  
PARITY CHECK 12  
PRI 18  
PRIMARY READY 18  
PROCEED 75  
PROCESS 14  
PROCESSOR CHECK 9  
PWR CHK 11  
READY  
  disk 13  
  printer 32  
RECEIVE INITIAL 16  
RECEIVE MODE 16  
RECEIVE TRIGGER 16  
REQUEST PENDING 75  
RD 18  
SEC 18  
SECONDARY READY 18  
STKR 18  
TEST MODE 15  
TH CHK 11  
TSM MODE 15  
TSM TRIGGER 16  
UNIT CHECK 16  
List Program 107  
LOAD statement 96  
LOCK key 32  
log sheet 89, 90  
LOG statement 96  
LSR display selector 13

MACHINE CYCLE lights 11

maintenance  
  card 165  
  disk 169

match operating procedures  
  general 112  
  match 117

merge operating procedures

  general 112  
  merge 117  
message display unit 9  
  message display unit (DPF) 14

meter

  customer engineer 12, 13  
  customer usage 10

MFCU

  card feed paths 19  
  controls and indicators 18  
  panel 18  
  print ribbon  
    installing 27  
    removing 24

MFCU Sort/Collate Program 112

mounting a disk cartridge 64

NOHALT statement 97

NPRO (non-process run out)

  key 18  
  light 18  
  operation 84

object program execution, RPG II 100

OPEN light 13

operation control language

  considerations 96  
  statements 96

operator's panel

  disk 13  
  dual program 14  
  MFCU 18  
  printer, dual feed 33  
  printer, single feed 33  
  system 8

PARITY CHECK light 12

PARTITION statement 97

PAUSE statement 97

position of disks 64

power off procedure 89

power on procedure 84

POWER ON/OFF switch 9

PRI light 18

PRIMARY READY light 18

print chain cartridge

  installing 48-character 54  
  installing 60-character 56  
  removal 50

print quality, printer 41

print unit (MFCU)

  changing ribbon 24  
  removing cards 22

printer

  controls and indicators 32  
  loading forms 34

printer-keyboard 73, 74

printer-keyboard

  loading forms 80  
  ribbon changing 78, 79  
  typeball changing 76  
  using 74

printer panel 33

printer, ribbon changing

  installation 48  
  removal 44

pressure rollers, forms 37

PROCEED light 75  
PROCESS light 14  
processing unit  
  controls and indicators 7  
  display panel 11  
processor check 9  
PROCESSOR CHECK light 9  
program  
  BASIC ASSEMBLER 122  
  BSC 104  
  DATA RECORD 119  
  DATA VERIFY 119  
  DISK COPY/DUMP 125  
  DISK SORT 120  
  DISK UTILITIES 124  
  SORT/COLLATE 110  
  96 List 107  
  96-96 REPRODUCE AND INTERPRET 108  
program halts 9, 14  
PROGRAM LOAD key 9  
PROGRAM LOAD SELECTOR switch 13  
program operating procedures  
  summary 85, 87  
program packs, building 160  
program product generation  
  example printout 153  
  procedures 149  
program run sheet 4-6  
PTFs  
  applying 174  
  considerations before applying 174  
punch unit, removing cards 21  
PWR CHK  
  light 11  
  restart 91  
P1 and P2 switches 12  
  
RATE SELECT switch 16  
READER statement 96  
READY light  
  disk 13  
  printer 32  
RECEIVE INITIAL light 16  
RECEIVE MODE light 16  
RECEIVE TRIGGER light 16  
reformat data card 110  
register display unit 11  
removable disk 64  
removing  
  disk cartridge 68  
  cards from card feed path 19  
reproduce 110  
Reproduce and Interpret Program 108  
REQ key 75  
REQUENT PENDING light 75  
restoring system power  
  procedures 91  
RETURN key 75  
RD light 18  
ribbon, changing  
  MFCU 24  
  printer 44  
  printer-keyboard 78  
run sheet 4-6  
RUN statement 97

RPG II  
  compiling 98  
  executing 100  
  interrupting 102  
  I-type 102  
  sample 179  
  
safety, covers 89  
sample program, RPG II 189  
SEC light 18  
SECONDARY READY light 18  
select operating procedures  
  general 112  
  select 117  
SHIFT key 32  
Sort/Collate  
  messages 181  
  Program 112  
sort operating procedures  
  general 112  
  no omits 114  
  omits 116  
SPACE key 32  
stacker jam 23  
START key  
  MFCU 18  
  printer 32  
  processing unit 9  
START/STOP switches 13  
statement  
  CALL 97  
  COMPILE 97  
  DATE  
    format 86  
    use 86, 96  
  FILE 97  
  FORMS 97  
  HALT 97  
  IMAGE 97  
  LOAD 96  
  LOG 96  
  NOHALT 97  
  PARTITION 97  
  PAUSE 97  
  READER 96  
  RUN 97  
  SWITCH 97  
STKR light 18  
STOP key  
  MFCU 18  
  printer 32  
  processing unit 9  
  restrictions 89  
stopping a job 89  
storage dump, procedures 92  
STORAGE TEST switch 12  
switches  
  ADDR INCREM 12  
  ADDRESS COMPARE 12  
  ADDRESS/DATA 11  
  dual program control 14  
  FILE WRITE 12  
  I/O CHECK 12  
  I/O OVERLAP 12  
  POWER ON/OFF 9



PROGRAM LOAD SELECTOR 13  
P1 12  
P2 12  
RATE SELECT 16  
START/STOP 13  
STORAGE TEST 12  
SWITCH statement 97  
system console, controls 8  
system control panel 9  
system control program generation 132  
system controls and indicators 8  
system generation  
    backing up resident system for 131  
    building a program pack 160  
    completing 154  
    example printout 146  
    functions 130  
    preparing for 130  
    program product 149  
    system control program 132  
system maintenance  
    card 165  
    common procedures 162  
    disk 169  
    functions 162  
    summary 163  
system power  
    restoring 91  
    turning off 89  
SYSTEM RESET key 12  
  
test mode 11, 18  
TEST MODE light 15  
TH CHK light 11  
TSM MODE light 16  
TSM TRIGGER light 16  
typeball  
    removing 76  
    replacing 76  
  
UNIT CHECK light 16  
usage meter 10  
utility programs  
    card 106  
    disk 124  
  
vertical adjustment, printer 39  
  
wait station, removing cards 21  
  
96 List Program 107  
96-96 Reproduce and Interpret Program 108  
5203 Printer 31  
5410 Central Processing Unit 7  
5424 Multi-Function Card Unit 17  
5444 Disk Storage Drive 61  
5471 Printer-Keyboards 73

System/3

Base Publication No. GC21-7508-1

This Newsletter No. GN21-7597

Date: September 15, 1971

Previous Newsletter Nos. GN21-7559, GN21-7581  
and GN21-7582

## IBM SYSTEM/3 DISK SYSTEM OPERATOR'S GUIDE

© IBM Corp. 1971

This Technical Newsletter, a part of version 05, modification 00 of IBM System/3 Model 10 Disk System, provides replacement pages for the subject publication. These replacement pages remain in effect for subsequent versions and modifications unless specifically altered. Pages to be inserted and/or removed are:

cover, preface  
49 and 50  
105 and 106  
106.1, 106.2 (added)  
135 and 136  
139 and 140  
142.1  
143 and 144  
145 through 148  
151 through 154  
157 and 158

Changes are indicated by a vertical line to the left of the change.

### Summary of Amendments

- Addition of Device Counter Logout program.
- Addition of TRIO system generation procedures.

Note: Please file this cover letter at the back of the manual to provide a record of changes.

**READER'S COMMENT FORM**

IBM System/3  
 Disk System  
 Operator's Guide

GC21-7508-1

Your answers to the questions on this sheet will help us produce better manuals for your use. If any of your answers require comments, or if you have additional information you think would be helpful, please use the space provided. All comments and suggestions become the property of IBM.

1. Is the manual easy to read?
2. Is any of the information unclear?
3. Is additional information needed?
4. Is any of the information unnecessary?
5. Did you read the Preface?
6. Did you use the Table of Contents?
7. Did you use the Index? \*
8. Did you take the tests? \*
9. How did you use the manual:

Yes	No

\* Not included in all manuals

- Instructor in a class \_\_\_\_\_
- Student in a class \_\_\_\_\_
- Reference material \_\_\_\_\_
- Self-Training \_\_\_\_\_
- Other (Explain) \_\_\_\_\_

Have you had previous computer or programming training? \_\_\_\_\_

What is your present job? \_\_\_\_\_

What business is your company engaged in? \_\_\_\_\_

**COMMENTS**

**YOUR COMMENTS, PLEASE. . .**

Your answers to the questions on the back of this form, together with your comments, will help us produce better publications for your use. Each reply will be carefully reviewed by the persons responsible for writing and publishing this material. All comments and suggestions become the property of IBM.

*Note:* Please direct any requests for copies of publications, or for assistance in using your IBM system, to your IBM representative or to the IBM branch office serving your locality.

Cut Along Line

Fold

Fold

FIRST CLASS  
PERMIT NO. 387  
ROCHESTER, MINN.

**BUSINESS REPLY MAIL**  
NO POSTAGE NECESSARY IF MAILED IN THE UNITED STATES

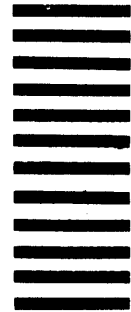

POSTAGE WILL BE PAID BY . . .

IBM Corporation  
General Systems Division  
Development Laboratory  
Rochester, Minnesota 55901

Attention: Programming Publications, Dept. 425

Fold

Fold

IBM System/3 Printed in U.S.A. GC21-7508-1



International Business Machines Corporation  
Data Processing Division  
112 East Post Road, White Plains, N.Y. 10601  
(USA Only)

IBM World Trade Corporation  
821 United Nations Plaza, New York, New York 10017  
(International)



**International Business Machines Corporation  
Data Processing Division  
112 East Post Road, White Plains, New York 10601  
(USA only)**

**IBM World Trade Corporation  
821 United Nations Plaza, New York, New York 10017  
(International)**