

IBM System/3 RPG II Telecommunications Programming Reference Manual

Program Numbers:

- 5701-RG1 (Model 10 Card System)**
- 5702-RG1 (Model 10 Disk System)**
- 5703-RG1 (Model 6)**
- 5704-RG1 (Model 15)**
- 5704-RG2 (Model 15)**
- 5705-RG1 (Model 12)**

SC21-7507-5
File No. S3-30

Program Product

Sixth Edition (December 1975)

This is a major revision of, and obsoletes, SC21-7507-4 and Technical Newsletters SN21-7738, SN21-7759, and SN21-5255. Information for the Model 12 RPG II Compiler has been added. Changes are indicated by a vertical line to the left of the change. New or extensively revised illustrations are indicated by a bullet (●) to the left of the figure title. Appendix I has been added and should be reviewed in its entirety.

This edition applies to the following IBM System/3 RPG II program products:

| Version | Modification | Program Number | System/3 Model |
|---------|--------------|----------------|----------------|
| 1 | 14 | 5701-RG1 | 10 Card |
| 15 | 0 | 5702-RG1 | 8 and 10 Disk |
| 15 | 0 | 5703-RG1 | 4 and 6 |
| 6 | 0 | 5704-RG1 | 15A, B, C |
| 2 | 0 | 5704-RG2 | 15D |
| 4 | 0 | 5705-RG1 | 12 |

This revision remains in effect for all subsequent versions and modifications unless specifically altered by a new edition or a technical newsletter. Changes are continually made to the specifications herein; before using this publication in connection with the operation of IBM systems, consult the latest *IBM System/3 Bibliography*, GC20-8080, for the editions that are applicable and current.

Use this publication only for the purposes stated in the *Preface*.

Publications are not stocked at the address below. Requests for copies of IBM publications and for technical information about the system should be made to your IBM representative or to the IBM branch office serving your locality.

This publication could contain technical inaccuracies or typographical errors. Use the Reader's Comment Form at the back of this publication to make comments about this publication. If the form has been removed, address your comments to IBM Corporation, Publications, Department 245, Rochester, Minnesota 55901. Comments become the property of IBM.

This reference manual is intended primarily for the System/3 user who has little or no experience with telecommunications programming.

This manual provides information a programmer needs to write System/3 RPG II telecommunications programs. It contains a:

- Definition of basic telecommunications terms
- Statement of the telecommunications capabilities of System/3
- Description of each of the RPG Telecommunications Specifications required to write a telecommunications program for System/3

Sample programs are included in this manual to illustrate programming techniques and possible applications for System/3 RPG II telecommunications programming.

System/3 Model 8

The System/3 Model 8 is supported by System/3 Model 10 Disk System control programming and program products. The facilities described in this publication for the Model 10 are also applicable to the Model 8, although the Model 8 is not referenced. However, the Integrated Communications Adapter (ICA) is available only on the Model 8. If you have the ICA, it is always designated as BSCA line 2. Therefore, you must enter the BSCA OCL statement (// BSCA LINE-2) at execution time. It should be noted that not all devices and features which are available on the Model 10 are available on the Model 8. Therefore, Model 8 users should be familiar with the contents of *IBM System/3 Model 8 Introduction*, GC21-5114.

IBM SYSTEM/3 5448 DISK STORAGE DRIVE

The IBM System/3 5448 Disk Storage Drive on System/3 Models 8 and 10 uses the same program product support as the IBM 5445 Disk Storage. However, a separate system control program feature is required for the 5448. In general, references to 5445 in this manual also apply to 5448. For specific information about 5448 operating characteristics and programming support, see *IBM System/3 5448 Disk Storage Drive Program Reference Manual*, GC21-5168.

Related Publications

The following chart lists the order numbers of the various related publications.

| Publication | Model 6 | Model 8 | Model 10 Card System | Model 10 Disk System | Model 12 | Model 15 |
|--|-----------|-----------|-------------------------|-------------------------|-----------|-----------|
| <i>General Information—Binary Synchronous Communications</i> | GA27-3004 | GA27-3004 | GA27-3004 | GA27-3004 | GA21-3004 | GA27-3004 |
| <i>Components Reference Manual</i> | GA34-0001 | GA21-9236 | GA21-9236 | GA21-9236 | GA21-9236 | GA21-9236 |
| <i>Operator's Guide</i> | GC21-7501 | GC21-7634 | GC21-7513 | GC21-7508 | GC21-5144 | GC21-5075 |
| <i>RPG II Reference Manual</i> | SC21-7517 | SC21-7504 | SC21-7500 | SC21-7504 | SC21-7504 | SC21-7504 |
| <i>Telecommunications Logic Manual</i> | SY21-0526 | SY21-0526 | LY21-0528 | SY21-0526 | SY21-0526 | SY21-0526 |
| <i>System Generation Reference Manual</i> | GC21-5126 | GC21-5126 | GC21-5126 | GC21-5126 | GC21-5126 | GC21-7616 |

| | | | |
|--|----|--|----|
| LIST OF ABBREVIATIONS | v | Column 17 (End of File) | 14 |
| INTRODUCTION | 1 | Column 19 (File Format) | 14 |
| BSC TELECOMMUNICATIONS CONCEPTS AND TERMINOLOGY | 3 | Columns 20-23 (Block Length) | 14 |
| Telecommunications Networks | 3 | Columns 24-27 (Record Length) | 14 |
| Nonswitched Network | 5 | Column 32 (Additional Area) | 14 |
| Switched Network | 5 | Columns 40-46 (Device) | 14 |
| Network Control | 5 | Descriptions of BSC Functions | 15 |
| Multipoint | 5 | Programming Considerations | 15 |
| Point-To-Point | 5 | Receive Only | 16 |
| Data Link Control | 6 | Receive with Transmittal of Conversational Reply | 20 |
| Data Link Control Characters | 6 | Transmit Only | 24 |
| Data Link Message Codes | 6 | Transmit with Reception of Conversational Reply | 27 |
| Data Link Message Formats | 6 | Transmit and Receive (No) Conversational Reply) | 31 |
| Standard Format | 6 | APPENDIX A. ASCII AND EBCDIC CODES | 47 |
| EBCDIC Transparency | 6 | ASCII Codes | 47 |
| Intermediate Block Checking Mode (ITB) | 6 | EBCDIC Codes | 48 |
| RPG II BSCA PROGRAMMING | 7 | APPENDIX B. DATA LINK CONTROL CHARACTERS | 49 |
| BSCA Station Types | 7 | APPENDIX C. POLLING AND ADDRESSING CHARACTERS FOR SYSTEM/3 | 51 |
| RPG II Telecommunications Specifications | 8 | EBCDIC Code | 52 |
| Columns 1-2 (Page) | 8 | ASCII Code | 52 |
| Columns 3-5 (Line) | 8 | APPENDIX D. RPG II TELEPROCESSING SPECIFICATIONS SUMMARY | 53 |
| Column 6 (Form Type) | 8 | RPG II Telecommunications Specifications | 53 |
| Column 7 (Comments) | 9 | File Description Specifications for BSCA Files | 55 |
| Columns 7-14 (File Name) | 9 | APPENDIX E. USING THE IBM 2770 AND THE IBM 2780 | 57 |
| Column 15 (Configuration) | 9 | RPG II Specifications | 57 |
| Column 16 (Type of Station) | 9 | RPG File Description Specifications | 57 |
| Column 17 (Type of Control) | 9 | RPG Line Counter Specifications | 58 |
| Column 18 (Type of Code) | 9 | RPG Telecommunications Specifications | 58 |
| Column 19 (Transparency) | 9 | RPG Output-Format Specifications | 59 |
| Column 20 (Switched) | 10 | System/3 Considerations | 59 |
| Columns 21-31 (Dial Number) | 10 | Examples | 60 |
| Column 32 (Location of Identification—This Station) | 10 | Transmitting to the IBM 2770 Data Communication System | 60 |
| Columns 33-39 (Identification—This Station) | 10 | Receiving from an IBM 2780 Data Transmission Terminal | 62 |
| Column 40 (Location of Identification-Remote Station) | 10 | APPENDIX F. COMMUNICATING WITH THE OPERATING SYSTEM TELECOMMUNICATIONS ACCESS METHOD (TCAM) | 65 |
| Columns 41-47 (Identification—Remote Station) | 10 | System/3 to TCAM | 66 |
| Columns 48-51 (Remote Terminal) | 11 | File Description Specifications | 66 |
| Column 52 (ITB) | 11 | Extension Specifications | 66 |
| Columns 53-54 (Permanent Error Indicator) | 11 | Telecommunications Specifications | 67 |
| Columns 55-57 (Wait Time) | 12 | Input Specifications | 67 |
| Columns 58-59 (Record Available Indicator) | 12 | Calculation Specifications | 68 |
| Column 60 (Last File) | 12 | Output-Format Specifications | 68 |
| Columns 61-62 (Polling Characters) | 12 | | |
| Columns 63-64 (Addressing Characters) | 13 | | |
| Columns 65-70 (Remote Device) | 13 | | |
| Columns 71-74 (Reserved) | 13 | | |
| Columns 75-80 (Program Identification) | 13 | | |
| File Description Specification Entries for BSC Files | 13 | | |
| Columns 7-14 (File Name) | 13 | | |
| Column 15 (File Type) | 13 | | |
| Column 16 (File Designation) | 14 | | |

| | |
|---|----|
| TCAM to System/3 | 70 |
| File Description Specifications | 70 |
| Extension Specifications | 70 |
| Telecommunications Specifications | 71 |
| Input Specifications | 71 |
| Calculation Specifications | 72 |
| Output-Format Specifications | 72 |
| TCAM Considerations | 74 |

| | |
|--|-----------|
| APPENDIX G. USING THE IBM 3741 AND IBM 5230 | 75 |
| RPG II Specifications | 75 |
| RPG II File Description Specifications | 75 |
| RPG II Telecommunications Specifications | 76 |
| RPG II Output Format Specifications. | 76 |
| Examples | 77 |
| Transmitting to the IBM 3741 | 77 |
| Receiving from an IBM 3741 | 79 |
| Receiving a Status Message from an IBM 3741 Data Station | 81 |
| Receiving from a 3741 Data Station with Expanded Communications Feature | 86 |
| Transmitting to a 3741 with Expanded Communications Feature | 88 |

| | |
|---|-----------|
| APPENDIX H. USING RPG II IN COMMUNICATION BETWEEN A SYSTEM/3 AND THE IBM 3750 (WORLD TRADE ONLY) | 91 |
| Programming Procedure | 91 |

| | |
|--|-----------|
| APPENDIX I. SYSTEM/3 RPG II INTERFACE TO BSC LINE PROTOCOL | 93 |
| Point-to-Point Leased Line | 93 |
| Receive | 93 |
| Transmit | 94 |
| Transmit Multiple Files | 95 |
| Transmit/Receive | 96 |
| Receive/Transmit | 97 |
| Leased Multipoint, System/3 Tributary Station | 98 |
| Receive | 98 |
| Transmit | 99 |
| Transmit, Receive | 100 |
| Receive, Transmit | 101 |
| Point-to-Point Switched Line 10 SEQ: Switched Line Station Identification Sequence Optional | 102 |
| Receive, System/3 Answer Station | 102 |
| Receive, System/3 Calling Station | 103 |
| Transmit, System/3 Answer Station | 104 |
| Transmit, System/3 Calling Station | 105 |
| Transmit/Receive, System/3 Calling Station | 106 |
| Transmit/Receive, System/3 Answer Station | 107 |
| Receive/Transmit, System/3 Answer Station | 108 |
| Receive/Transmit, System/3 Calling Station | 109 |
| Conversational Mode | 110 |
| Receive with Conversational Reply | 110 |
| Transmit with Conversational Reply | 111 |
| Line Condition—System/3 Responses | 112 |
| Data Mode, System/3 Transmitting | 112 |
| Data Mode, System/3 Receiving | 114 |

| | |
|---------------------------|------------|
| GLOSSARY | 115 |
|---------------------------|------------|

| | |
|------------------------|------------|
| INDEX | 117 |
|------------------------|------------|

List of Abbreviations

| | | | |
|--------|---|------|---|
| ACK0 | Even positive acknowledge | RVI | Reverse interrupt character |
| ACK1 | Odd positive acknowledge | SDLC | Synchronous data link control |
| ASCII | American national standard code for information interchange | SOH | Start of heading character |
| BCC | Block check count | STX | Start of text character |
| BPS | Bits per second | SYN | Line synchronization character |
| BSC | Binary synchronous communications | TCAM | Telecommunications access method (System/370) |
| BSCA | Binary synchronous communications adapter | TTD | Temporary text delay character |
| BTAM | Basic telecommunications access method (System/370) | VTAM | Virtual telecommunications access method (System/370) |
| DA | Display adapter | WACK | Wait for acknowledgement character |
| DISC | Disconnect | | |
| DLE | Data link escape character | | |
| DOS | Disk operating system | | |
| EBCDIC | Extended binary coded decimal interchange code | | |
| EHT | Error history table | | |
| ENQ | Enquiry character | | |
| EOT | End of transmission | | |
| ERC | Error retry count | | |
| ETB | End of text block character | | |
| ETX | End of text character | | |
| ICA | International Communication Association | | |
| ITB | Intermediate block check | | |
| LCA | Local communications adapter | | |
| NAK | Negative acknowledgement character | | |
| OS | Operating system (System/360 and System/370) | | |
| PEI | Permanent error indicator | | |

Introduction

IBM System/3 Telecommunications programming provides the user with the capability of sending and receiving binary synchronous data over common carrier facilities. The programming performs all functions necessary to establish line connections, exchange identification sequences, send and receive data, and execute the correct termination or disconnect procedures.

System/3 RPG II telecommunications support is provided via the RPG II language. Binary synchronous data transmission is possible between System/3 and:

- Other System/3s.
- Operating System or Disk Operating System Basic Telecommunications Access Method Binary Synchronous Communications (OS or DOS BTAM BSC).
- System/360 Model 20 Input Output Control System for the Binary Synchronous Communications Adapter.
- Operating System Telecommunications Access Method (TCAM).
- IBM 3741 Model 2 Data Station.
- IBM 5230 Model 2 Data Collection Controller.
- IBM 3750 Switching System (World Trade only).
- IBM System/7.

The System/3 Model 10 Disk System, Model 12, Model 6, Model 8, and Model 15 can also transmit data to and receive data from the IBM 2770 Data Communication System and the IBM 2780 Data Transmission Terminal (see Appendix E).

BSCA files are defined by entries on the RPG File Description Specification and the RPG Telecommunications Specification.

Note: For use of the second BSCA feature, see the *IBM System/3 Model 10 Disk System Control Programming Reference Manual*, GC21-7512, *IBM System/3 Model 12 System Control Programming Reference Manual*, GC21-5130, or *IBM System/3 Model 15 System Control Programming Reference Manual*, GC21-5077.

A System/3 RPG II telecommunications program can exist within a dual programming system (Dual Programming Feature required). Normal operator attention is required to respond to processing halts.

Note: If you are attempting to communicate between two programming levels using the RPG II telecommunications features and dual BSCA, it is suggested that you do not have overlays in either of the RPG II programs.

For IBM System/3 telecommunications operating procedures, see your system's operator's guide.

This section describes the basic characteristics and operational concepts of the BSC telecommunications system: what it is, how its parts are related, and how control is maintained. Commonly used terms are *italicized*.

TELECOMMUNICATIONS NETWORKS

A telecommunications system may use a nonswitched network or a switched network (Figure 1).

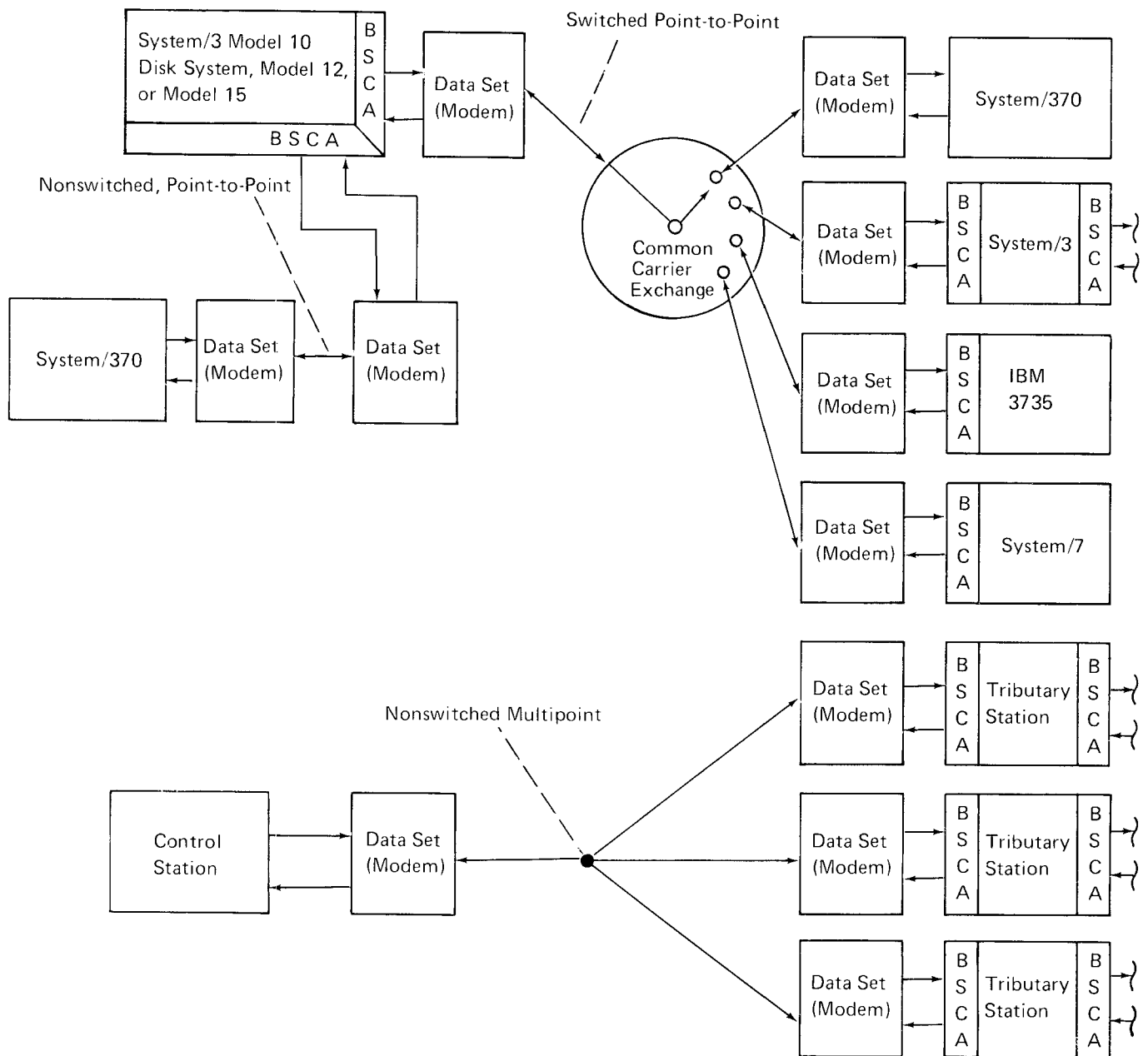
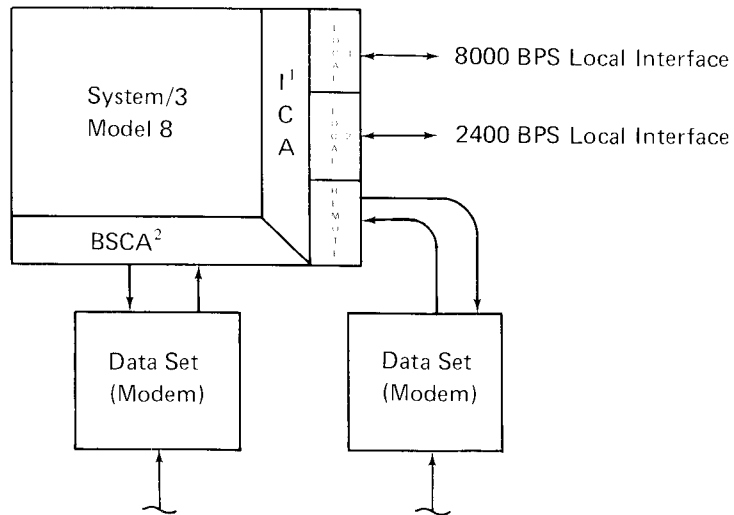

Figure 1. Telecommunications Networks (Part 1 of 2)



¹ The Integrated Communications Adapter (ICA) must be addressed as BSCA line 2. The manual ICA switch can have only one interface active at any one time.

² See Figure 1 (Part 1 of 2) for examples of BSCA line configurations.

Figure 1. Telecommunications Networks (Part 2 of 2)

Nonswitched Network

A nonswitched network consists of a number of private or leased communication lines that connect a computer to one or more *remote terminals*. Remote terminals is a general term used to represent interconnected equipment at a remote location, having either input or output capability, or both. On nonswitched networks, the computer and remote terminals are physically connected, that is, the circuits making up the communication lines are continuously established for predetermined time periods, during which data may be transmitted over the lines.

The lines that comprise a nonswitched network are variously known as *private*, *leased*, or *dedicated lines*. These lines may be furnished by a common carrier on a contract basis between specified locations for a continuous period or for regularly recurring periods at stated hours, for the exclusive use of one customer.

In this publication the term nonswitched network refers to a network in which the communication lines linking the computer and the remote terminal are continuously established, thus requiring no dialing to establish the connection.

Switched Network

A switched network allows many remote terminals to communicate with a computer without requiring dedicated communication lines. The computer and the remote terminals are connected by *access lines* to the common carrier exchange serving their respective locations. A complete and continuous data path is established between the computer and the remote terminal only for the period of time in which data transmission takes place. The connection is established by dialing the telephone number of the remote terminal.

In switched networks, line refers to a discrete data path between the telecommunications control unit, or adapter, and the common carrier exchange. The service provided by the common carrier is usually on a time-used basis.

In this publication, the term switched network refers to any network in which a direct physical connection between the computer and the remote terminal must be established by dialing in order for data transmission to occur.

NETWORK CONTROL

Initial contact between a computer and a remote terminal may occur in two ways, dependent on the type of line connection between them. The connections possible are

multipoint, on nonswitched lines, and point-to-point contention, on both switched and nonswitched lines. The BSC telecommunication system permits communication using either type of connection (Figure 1).

Multipoint

If a remote terminal is connected via a multipoint line, data is sent and received under the control of the *central* or *control station*. In order to send or receive data, the remote terminal, referred to as a *multidropped terminal* or *tributary station*, must be selected by the control station. This process of station selection is called *polling* or *addressing*.

Note: System/3 cannot be a control station.

Polling: Polling is a request to a tributary station to transmit data to the control station. Once the tributary station has accepted the invitation, thru recognition of its unique polling characters sent by the control station, the remote terminal may use the line to send data.

The tributary station notifies the control station when data transfer is complete by sending a unique *End-of-Transmission* (EOT) character to the control station. (For more information on control characters, see *Data Link Control* in this section.) Upon receipt of the EOT sequence, the control station may poll or address another tributary station.

Addressing: Data transfer from the control station to the tributary station on a multipoint network is accomplished by addressing the selected tributary station. Addressing is a request to a tributary station to receive data.

The control station notifies the tributary station when data transfer is complete by transmitting the EOT sequence. After EOT has been sent, the control station polls or addresses other tributary stations connected via the multipoint network.

Only the control station has the right to request data transfers on a multipoint network.

Point-to-Point

The other type of line connection is point-to-point contention, with the computer and the remote terminal connected via a nonswitched or switched line.

Non-Switched: On a nonswitched line, either the computer or the remote terminal may initiate the transmission of data. However, if both stations simultaneously attempt to transmit or receive data, the line is disconnected.

Switched: On a switched line, one of the stations is designated as the calling station. The other stations, or called stations, accept calls from the calling station. The calling station may perform the calling sequence by either *autocall* (automatic dialing by the computer) or *manual dial* (dialing performed by the machine operator). The called station accepts calls from the calling station by either *autoanswer* (automatic answering by the computer) or *manual answer* (machine operator makes the data set ready).

The calling station must initiate data transmission by sending the proper control sequence to ensure that a connection has been made with the desired station. The control sequence usually involves the exchange of *station identification* sequences. When station identification sequences are used, data transmission will not begin until both the called and the calling station have sent and received the correct ID sequence.

When the control sequence has been completed, the calling station may either send data to the called station, or may relinquish the right to send data by sending an End-of-Transmission character. Once the EOT has been sent, the called station may initiate sending data to the calling station. When both stations have completed sending data, the calling station starts a disconnect procedure to terminate the data link.

DATA LINK CONTROL

Data link control procedures are used to ensure the proper sending and receiving of data between the computer and the remote terminal. System/3 BSCA support assumes the responsibility for maintaining the proper data link control procedures.

The following information is presented to provide the System/3 programmer with sufficient information to properly utilize the BSCA capabilities.

Data Link Control Characters

Data link communication control between stations, that is, between the computer and the remote terminal is maintained by the use of Data Link Control Characters (Appendix B).

By using data link control characters, the computer and the remote station notify each other of their status, and the status of data sent or received by them. During normal operation, the data link characters cannot be included in the data being sent or received.

Data Link Message Codes

The BSC adapter is capable of sending or receiving data in one of two codes: EBCDIC (Extended Binary Coded Decimal Interchange Code) or ASCII (American National Standard Code for Information Interchange). The code you use is determined by the type of BSC adapter installed in your system.

EBCDIC and ASCII character code charts are provided in Appendix A of this manual.

DATA LINK MESSAGE FORMATS

Standard Format

The standard message format consists of characters of data from the code selected, excluding specially designated data link control characters.

EBCDIC Transparency

BSC adapters with the EBCDIC transparency feature installed may send and receive messages containing any or all of the possible 256 character combinations in the EBCDIC code, including data link control characters. This feature allows unique data, such as packed decimal data, to be sent unaltered from one computer to another.

Intermediate Block Checking Mode (ITB)

The intermediate block checking feature allows large buffers of data to be sent and received with parity checking performed on each logical record rather than the total buffer. The ITB character delimits logical records within the buffer.

System/3 RPG II Telecommunications Programming provides the RPG II user with the capability of transmitting and receiving binary synchronous data via a telecommunications network. BSCA support is achieved through the use of an RPG Telecommunications Specifications Sheet and the addition of BSCA as a valid device entry on the RPG File Description Specification. No other RPG specification sheets are affected by BSC.

BSCA STATION TYPES

RPG II permits System/3 to function as any of the following station types:

1. Receive only (receive input data from a remote terminal).
2. Receive with transmittal of conversational reply (receive input data from a remote terminal and, when required, transmit data as an acknowledgement).
3. Transmit only (transmit data to a remote terminal).
4. Transmit with reception of conversational reply (transmit data to a remote terminal and, when required, receive data as an acknowledgement).
5. Transmit and receive—no conversational reply. Three modes of operation are possible:
 - a. Transmit a file, then receive another file.
 - b. Receive a file, then transmit another file.
 - c. Transmit records of a file interspersed with receiving records of another file. (This function is available only when System/3 transmits data to OS or DOS. System/3 must transmit first.)

A description of these functions, including complete RPG II programs, are provided following the description of the specification sheets.

Note: Each telecommunications program implies a counterpart at the other end of the line. The two programs must be compatible. For example, a program which transmits ASCII data requires a program which will receive ASCII data.

Column 7 (Comments)

Entry Explanation

* Comments line.

You often want to write comments that will help you understand or remember what you are doing in a certain section of coding. RPG II allows you to use an entire line for these comments. The comment line is identified by placing an asterisk (*) in column 7. Comments are *not* instructions to the RPG II program. They serve only as a means of documenting your program.

Columns 7-14 (File Name)

Entry Explanation

alphanumeric This entry must be the same as the file name associated with the BSCA device on the File Description Specifications Sheet.

Column 15 (Configuration)

Entry Explanation

P or blank Point-to-point, nonswitched network (PTP).

M Multipoint network, where the control station selects the tributary station through polling or addressing. System/3 cannot be the control station.

S Switched network.

Column 16 (Type of Station)

Entry Explanation

T This station will transmit messages from this file (transmit only or transmit with reception of conversational reply). The file must be designated as an output or combined file on the File Description Specifications Sheet and must appear on the Output Format Specifications Sheet.

R This station will receive messages into this file (receive only or receive with transmittal of conversational reply). The file must be designated as an input or combined file on the File Description Specifications Sheet and must appear on the Input Specifications Sheet.

! *Note:* This entry is independent of the entry in column 20.

Column 17 (Type of Control)

Entry Explanation

T This is a tributary station on a multipoint network. System/3 cannot be the control station and transmit the polling supervisory sequence.

blank Polling is not used.

Column 17 must contain a T if column 15 contains an M (multipoint network).

Column 18 (Type of Code)

Entry Explanation

A, U ASCII (formerly referred to as USASCII) data link control characters will be used. When ASCII is used, each station must provide file translation when it is required.

E or blank EBCDIC data link control characters will be used.

The entry in this column must be the same type that your BSCA and RPG II program supports. ASCII and EBCDIC codes are listed in Appendix A.

Note: If your BSC program halts because of an invalid ASCII character in your data, check your ASCII translation table.

Column 19 (Transparency)

Entry Explanation

Y This entry is valid only for EBCDIC. The transparency feature must be installed.

The data being transferred may contain data link control characters. EBCDIC data link control characters are listed in Appendix B.

N or blank The transparency feature is not used. Unpacked numeric or alphanumeric data will be transmitted and received. The data being transferred may not contain data link control characters.

Column 20 (Switched)

| <i>Entry</i> | <i>Explanation</i> |
|--------------|---|
| M | The computer operator using this program makes the connection between stations by dialing the number (manual dial). |
| E | Autocall is to be used by this station. The dial number is listed in columns 21-31. |
| S | Autocall is to be used by this station. The entry in columns 21-31 is the symbolic location of the dial number. |
| A | Autoanswer is used by this program. |
| B | Manual answer is used by this program. |
| blank | This is not a switched network. |

Notes:

1. When calling, you should use E, M, or S. If the program is to be called, you should use A or B. That is, if two RPG II programs are communicating, one program must have an E, M, or S, and the other must have an A or B.
2. This entry is independent of the entry in column 16.

Columns 21-31 (Dial Number)

| <i>Entry</i> | <i>Explanation</i> |
|--------------|--|
| numeric | This is the number to be dialed when column 20 contains an E. |
| alphameric | Columns 21-31 must contain a symbolic name, other than an array name, referencing the location of the dial number when column 20 contains an S. If the BSCA file is an input file other than a demand or conversational receive file, this name must refer to the first (or only) element of a table. This ensures that the dial number will be in storage before the telecommunications line is opened. (This restriction does not apply when the function of the program is transmit with conversational reply.) |

Column 32 (Location of Identification—This Station)

| <i>Entry</i> | <i>Explanation</i> |
|--------------|--|
| S | Switched network. This station's identification is located at the position referenced by the symbolic name specified in columns 33-39. |
| E | Switched network. The entry in columns 33-39 is this station's identification. |
| blank | This is a nonswitched network or a switched network where no ID is desired for this station. |

Columns 33-39 (Identification—This Station)

| <i>Entry</i> | <i>Explanation</i> |
|--------------|--|
| alphameric | When column 32 contains an E, this entry is the actual identification sequence of this station (minimum two characters). When column 32 contains an S, this entry is the symbolic name of the location of this station's identification. The symbolic name must not be an array name. If the BSCA file is primary or secondary, this symbolic name must refer to the first element of a table. (The table may have only one element.) This ensures that the station identification will be in storage before the telecommunications line is opened. The station identification can be from two to fifteen characters; however, the length of this field or literal must be the same as the length of the field or literal in columns 41-47 (blanks in literals do not count as part of the length). A station identification must not contain a control character sequence (see Appendix B). The station identification will be translated if the BSCA files are being translated. |

Column 40 (Location of Identification—Remote Station)

| <i>Entry</i> | <i>Explanation</i> |
|--------------|--|
| S | Switched network. The remote station's identification is located at the position referenced by the symbolic name specified in columns 41-47. |
| E | Switched network. The entry in columns 41-47 is the remote station's identification. |
| blank | This is a nonswitched network or a switched network where no ID is desired for the remote station. |

Columns 41-47 (Identification—Remote Station)

| <i>Entry</i> | <i>Explanation</i> |
|--------------|--|
| alphanumeric | When column 40 contains an E, this entry is the actual identification sequence of the remote station (minimum two characters). When column 40 contains an S, this entry is the symbolic name of the location of the remote station's identification. The symbolic name must not be an array name. If the BSC file is primary or secondary, this symbolic name must refer to the first element of a table. (The table may have only one element.) This ensures that the station identification will be in storage before the telecommunications line is opened. The station identification can be from two to fifteen characters; however, the length of this field or literal must be the same as the length of the field or literal in columns 33-39 (blanks in literals do not count as part of the length). A station identification must not contain a control character sequence (see Appendix B). The station identification will be translated if the BSC files are being translated. |

This page intentionally left blank

tor of the record causing the error are both set on. The permanent error indicator should be used to condition appropriate programming response (for example, printing a message or performing a controlled cancel). No further transmission should be attempted while the permanent error indicator is on.

If you are using dual I/O buffers on the Card System and a permanent error occurs when the first record is received, a system halt is issued automatically.

Disk systems only: To retry an operation after a permanent error occurs, turn off the permanent error indicator. The RPG II program can then access the BSC file that caused the error. If no error occurs, processing continues; otherwise the permanent error indicator is turned on again.

Columns 48-51 (Remote Terminal)

Columns 48-51 are used only if System/3 is to communicate with the IBM 2770 Data Communication System or the IBM 2780 Data Transmission Terminal (see Appendix E). Otherwise, columns 48-51 are never used with System/3 and must be blank.

Column 52 (ITB)

| <i>Entry</i> | <i>Explanation</i> |
|--------------|--------------------|
|--------------|--------------------|

| | |
|---|---|
| I | Intermediate block check (ITB) is used. |
|---|---|

| | |
|-------|------------------|
| blank | ITB is not used. |
|-------|------------------|

Intermediate block checking can be used only if records are blocked.

Columns 53-54 (Permanent Error Indicator)

| <i>Entry</i> | <i>Explanation</i> |
|--------------|--------------------|
|--------------|--------------------|

| | |
|-------------------------|--|
| 01-99,L1-L9 LR,H1-H9 | A permanent error indicator should be used with every BSC file. If you are using more than one BSC file, each should have a permanent error indicator, not necessarily unique. |
|-------------------------|--|

When a permanent error occurs, the specified error indicator and the identification indica-

Keep the following points in mind when you retry an operation:

1. The permanent error indicator is the only indication given to the RPG II program that an error has occurred.
2. Any data in the BSC buffers at the time of an error is lost.
3. Switched lines are not disabled when an error occurs except for disconnect sequence received or hardware detected disconnect.
4. Any data passed to the user while the permanent error indicator is on is invalid. Unless your program recognizes all data, an unidentified record halt may occur.
5. A limit should be imposed by the RPG II program on the number of times an error occurs before stopping the program.

blank No permanent error indicator is specified.

If a permanent error occurs on a card or disk system when no permanent error indicator has been specified, a system halt occurs. The program cannot be restarted.

Note: Avoid using H1-H9 as permanent error indicators if you wish to condition operations on the permanent error indicator being off. Since H1-H9 are reset at the end of the detail cycle, they may be set off before the program cycle in which the error occurred is completed.

Also, when H1-H9 is used as a permanent error indicator, the H1-H9 display may preempt the system halt display. If the H1-H9 display appears before the system display, dial the 0 option on a disk system or restart the card system to prompt the system halt display.

Columns 55-57 (Wait Time)

| <i>Entry</i> | <i>Explanation</i> |
|--------------|---|
| numeric | The length of time in seconds, 1-999, that BSC will wait with no messages being sent or received before a permanent error condition occurs. |
| blank | The system convention for timeout, 180 seconds, is used. |

A permanent error results whenever the wait time elapses on an idle line. Therefore, when you determine your wait time, consider time the operator may require to respond to halts and other processing interruptions, and also time the program may require for special operations such as table searches, computing square roots, etc.

Note: The time limit specified applies *only* to delays caused by this System/3 program and does not apply to the remote device. If the remote device does not communicate with this System/3 within a 20-second period, a permanent error condition occurs. In addition, the time limit applies only during the transmission of a file, not between file transmissions. The occurrence of a permanent error indicates the end of processing of a file.

Columns 58-59 (Record Available Indicator)

| <i>Entry</i> | <i>Explanation</i> |
|----------------------------------|--|
| 01-99, L1-L9, LR, H1-H9 | A record available indicator should be assigned to every BSCA input file that is to be reopened. (If a file is used again after end-of-file has been reached, the file is "reopened.") See Figure 9 and Appendix F for examples using a record available indicator. This indicator is set on whenever a reverse interrupt (RVI) is received. |

Column 60 (Last File)

| <i>Entry</i> | <i>Explanation</i> |
|--------------|--|
| L | This BSC input file is processed only after all other primary and secondary input files have been processed. |
| blank | It isn't necessary that this BSC input file is the last input file processed. |

Columns 61-62 (Polling Characters)

| <i>Entry</i> | <i>Explanation</i> |
|--------------|---|
| Alphanumeric | The polling identification of this station is needed if this station is part of a multipoint network and the BSC file is a transmit (output) file. Polling characters are listed in Appendix C. |
| blank | This station is not transmitting on a multipoint network. |

Columns 63-64 (Addressing Characters)

| <i>Entry</i> | <i>Explanation</i> |
|--------------|---|
| Alphanumeric | The addressing identification of this station is needed if this station is part of a multipoint network and the BSC file is a receive (input) file. Addressing characters are listed in Appendix C. |
| blank | This station is not receiving on a multipoint network. |

Note: Enter polling and addressing characters in System/3 code; the compiler will convert the characters to the form required by the code specified in column 18.

Columns 65-70 (Remote Device)

Columns 65-70 are used only if System/3 is to communicate with the IBM 2770 Data Communication System or the IBM 2780 Data Transmission Terminal (See Appendix E). Otherwise columns 65-70 are never used with System/3 and must be blank.

Columns 71-74 (Reserved)

Columns 71-74 are never used with System/3 and must be blank.

Columns 75-80 (Program Identification)

Columns 75-80 may contain any characters. These columns may use the program name in the control card, or they may contain characters which identify a certain portion of the program. The entry is ignored by the compiler, but will appear in the source program listing.

FILE DESCRIPTION SPECIFICATION ENTRIES FOR BSC FILES

The entries in the columns listed below are used to define a BSCA file on the RPG File Description Specifications Sheet. The entries in columns not listed are the same as basic RPG.

No other RPG specification sheets are changed by BSC. However, since a BSC program must not be interrupted, a B must not be entered in column 37 of the RPG II Control Card Specifications when the BSC program is to be run on a disk system.

Columns 7-14 (File Name)

This is the name of a BSC file. The same file name must be used on the RPG Telecommunications Specifications Sheet.

Note: Look-ahead fields must not be specified for a BSC file.

Column 15 (File Type)

| <i>Entry</i> | <i>Explanation</i> |
|--------------|---|
| I | This is an input (receive) file. |
| O | This is an output (transmit) file. |
| C | Combined file. Use C when your receive file <i>or</i> transmit file uses conversational reply. Unlike combined card files, the acknowledgement sent as a conversational reply may or may not be added to the last record received. C is an invalid entry if an IBM 2770 or IBM 2780 is being used. |

Column 16 (File Designation)

This is the same as basic RPG except that:

1. D (demand file) is the required entry for *transmit interspersed with receive*. BSCA files also should be designated as demand files with any receiving program which does not address the BSCA files immediately. For example, if your BSCA file is defined as a secondary file, the telecommunications line will be opened as soon as the program begins. This means that your wait time may elapse before you are ready to process the BSCA file. If the BSCA file is defined as a demand file, however, the line will be opened only when the program is ready to receive from the BSCA file.
2. R (record address file) is an invalid entry. A BSCA file cannot be a record address file.

Column 17 (End of File)

Enter an E if end-of-file on the input (receive) file is to determine end-of-job. The BSCA input file can be the only file with an E in column 17. If any other input file has an E specified in column 17, then all BSCA input files should have an E in column 17. The E in column 17 is not mandatory, but without it when end-of-file is reached on the other file, the BSCA file will be closed without giving the system on the other end an indication of what has happened. By using the E in column 17 for all BSCA input files, all systems will come to a successful end-of-job.

Column 19 (File Format)

Enter an F (fixed length) for BSCA files.

Columns 20-23 (Block Length)

Enter the size of the blocks of data to be processed by BSC. If your BSCA files use conversational reply, block length must be the same as record length; otherwise, block length can be a multiple of record length. The maximum block lengths are 4096 (Model 10 Card System) and 9999 (Model 6, Model 10 Disk System, Model 12, and Model 15).

Columns 24-27 (Record Length)

Enter the length of your BSCA records, right justified, in columns 24-27. If your BSCA files use conversational reply, record length must be the same as block length. If you do not specify a record length, the record length will be defaulted to zero. The maximum record lengths are 4096 (Model 10 Card System) and 9999 (Model 6, Model 10 Disk System, Model 12, and Model 15).

Note: When the transmitted record is less than the record length specification field in the program, the data in the remainder of the buffer may cause unpredictable results.

Column 32 (Additional Area)

Assign dual I/O areas. This column is used only with *non conversational* BSCA files. Any number, 1 through 9, causes two I/O areas to be assigned. If this column is blank, only one I/O area is assigned and throughput is decreased accordingly.

Columns 40-46 (Device)

The device entry for BSCA files is BSCA.

Note: On the Model 10 Disk System, Model 12, Model 6 and Model 15, the maximum number of non-BSCA files allowed in a program using BSCA files depends upon the number of BSCA files:

| Number of BSCA files in program | Maximum number of non-BSCA files allowed |
|---------------------------------|--|
| 1 | 19 |
| 2 | 17 |
| 3 | 15 |
| 4 | 12 |
| 5 | 10 |
| 6 | 8 |
| 7 | 6 |
| 8 | 4 |
| 9 | 2 |
| 10 | 0 |

DESCRIPTIONS OF BSC FUNCTIONS

This section describes the functions that System/3 can perform as part of a telecommunications network. Complete RPG II programs are included to show how these functions may be used.

Programming Considerations

RPG II First-Time Logic

RPG II first-time logic opens all primary and secondary input files during the first-time cycle. That is, one record is read from each primary and secondary input file before any input file is processed. However, depending upon the particular application, you may want to delay first-time logic for your BSCA input files. You can achieve this by designating each BSCA input file as a demand file (D in column 16 of the File Description Specification sheet). One BSCA input file can also be designated as the last file (L in column 60 of the Telecommunications Specification sheet).

Remember that an entire BSCA input file must be received before another, or part of another, BSCA input file can be received.

Control Breaks and Overflow

Care must be taken when transmitting data at total time in any RPG II program which both transmits and receives. Due to the sequence of total and detail operations in the RPG II Program Cycle, data may not be available for output even though it has been read.

Similar care must be taken when assigning the overflow indicator in a program that both transmits and receives. A potential problem exists in that RPG II, because of the program cycle, may try to transmit an overflow record after receiving a record.

Data Restrictions

- Remember that /* in the first two positions of a record always signifies end-of-file. This applies even to data transmitted and received in a BSC program. Therefore, be sure that the use of literals, constants, or OS or DOS data records does not result in the transmission of /* in the first two positions of a record.

Note: When a table is dumped, a /* is generated to denote the end of the table. Therefore, if you dump a table to a BSCA file, expect an end-of-file condition when the table has been received.

- If you have the auto-turnaround feature and you are communicating in transparent mode to the IBM 2780, the last record received by System/3 before turning the line around will be blank. Consider this when you specify record identifiers in the RPG input specifications.

Details of transmitting data sets on the 3741 can be found in the *IBM System/3 3741 Models 3 and 4 Programmable Work Station Programming Reference Manual*, GA21-9194, or *IBM 3741 Data Station Reference Manual*, GA21-9183.

Data Formats

System/3 RPG II support uses the following data formats for transmission of data—these formats must be used when sending data to System/3 from a CPU. The BSCA support provides these for the RPG II user.

- Non-transparent, non-ITB:
STX-data-ETX (ETB)
- Non-transparent, ITB:
STX-data-ITB-data-ITB-data-ETX (ETB)
- Transparent, non-ITB:
DLE-STX-data-ETX (ETB)
- Transparent, ITB:
DLE-STX-data-ITB-DLE-STX-data-ITB-DLE-STX-data-ETX (ETB)

Note: BTAM cannot send transparent ITB data, but can receive transparent ITB data.

Data can be either fixed length and unblocked, or blocked with fixed record length. If ITB mode is used, the ITB character must precede each record except the first, and should not be counted in the record length.

Errors

If an error occurs at either station, System/3 will retry the operation a maximum of seven times.

System/3 halts with a permanent error if it receives:

- An EOT while transmitting
- The following sequence of data link control characters: TTD-NAK-EOT.

RPG II Diagnostics

Refer to the RPG II reference manual for your system for a discussion of compile time RPG II diagnostics.

Model 15 Only

Because the BSCA program is an interrupt driven program and cannot be rolled out of its partition, care must be taken when using BSCA files with SPECIAL files (where allocation of system supported disk devices is performed) or unpredictable results will occur. To prevent the program from being rolled out by allocation, the RPGTCF programmer must ensure that the BSCA data management DTFs and IOBs are located 6K bytes beyond the beginning of the partition.

Receive Only

The receive only function allows the RPG II user to receive input data from a remote terminal. The file may be either a primary or secondary file. Blocked records are permitted. Dual I/O areas can be used to achieve greater throughput.

The receive only file is defined as an input file on the RPG File Description Specification and as a receive file on the RPG Telecommunications Specification.

In the following *receive only* program (Figure 3), a branch office is transmitting a daily sales report to System/3. The information received is listed on the printer and punched and printed on cards. The salesman's name is sent on one record. This record is followed by any number of records identifying his sales for the day. The card file produced by this and other day's transmissions can be sorted and used by another RPG II program as data to calculate information such as inventory control and the salesman's commissions. The same program could then transmit this information back to the branch office.

File Description Specifications (Figure 3, Part 1)

Telecommunications Specifications (Figure 3, Part 1)

| Column | Description |
|--------|--|
| 7-14 | SALES is the file which contains the sales report received by this station. |
| 15-16 | SALES is the primary input file for this program. |
| 17 | End-of-file on SALES does not determine end-of-job time. |
| 19 | BSCA files always have a fixed length format. |
| 20-27 | Records are blocked. |
| 32 | Dual I/O areas are used. |
| 40-46 | BSCA is the device used for BSCA files. BSCA is also specified when communicating with a device attached via the Local Communications Adapter. |

| Column | Description |
|--------|---|
| 7-14 | SALES is the BSCA file for this program. |
| 15-17 | This station is part of a switched network (S), and will receive messages (R). Polling is not used, so column 17 is blank. |
| 18-20 | EBCDIC code (E) and the transparency feature (Y) are both used. Autoanswer (A) is used by the called station. |
| 32-47 | Explicit station identification sequences are given for each station. Station IDs ensure data security on the switched network. |
| 52 | Intermediate block check (I) is used. |

IBM International Business Machine Corporation Form GX21-9092-4 IBM 0501 Printed in U.S.A.

RPG CONTROL CARD AND FILE DESCRIPTION SPECIFICATIONS

Program: _____ Date: _____ Punching Instruction: _____ Graphic: _____ Card Electro Number: _____

Page 01 of 2 Program Identification: RECEIV

File Description Specification

| Line | File Type | Filename | File Type | | Mode of Processing | | Device | Symbolic Device | Name of Label Exit | Extent Exit for DAM | File Addition/Unordered | |
|------|-----------|-----------|------------------|-------------|--|---------------------|--------|-----------------|--------------------|---------------------|--|-------------------|
| | | | File Designation | End of File | Length of Key Field or of Record Address Field | Record Address Type | | | | | Number of Tracks for Cylinder Overflow | Number of Extents |
| 3-4 | 5-6 | 7-14 | 15-16 | 17-18 | 19-20 | 21-22 | 23-24 | 25-26 | 27 | 28 | 29-31 | 32-33 |
| 0 2 | F | SALES | IP | F | 90 | 30 | | | | | | |
| 0 3 | F | TOTLLISTO | | F | 120 | 120 | | | | | | |
| 0 4 | F | DEPTLISTO | | F | 96 | 96 | | | | | | |

IBM International Business Machine Corporation Form GX21-9116-1 Printed in U.S.A.

RPG TELECOMMUNICATIONS SPECIFICATIONS

Program: _____ Date: _____ Punching Instruction: _____ Graphic: _____ Card Electro Number: _____

Page 02 of 2 Program Identification: RECEIV

| Line | File Type | Filename | Switched | | Identification | | Remote Device | Wait Time | Record Available Indicator | Polling Characters | Addressing Characters | Reserved |
|------|-----------|----------|-------------|--------------|----------------|---------|---------------|-----------|----------------------------|--------------------|-----------------------|----------|
| | | | Dial Number | Ext. Station | Remote Station | | | | | | | |
| 3-4 | 5-6 | 7-14 | 15-16 | 17-18 | 19-20 | 21-22 | 23-24 | 25-26 | 27-28 | 29-30 | 31-32 | 33-34 |
| 0 1 | T | SALES | SR EYA | | EHOMOFF | EBRNCHS | | | | | | |

Figure 3. Receive Only Program (Part 1 of 3)

Column Description

Input Specifications (Figure 3, Part 2)

53-54 The permanent error indicator used is 99.

Data transmitted by the remote station is received by SALES.

55-57 The telecommunications line will be kept open for 120 seconds even though no messages are being sent or received. After 120 seconds have elapsed, a permanent error condition results if the line still is not being used.

Calculation Specifications (Figure 3, Part 2)

If a permanent error occurs, LR is set on to enter end-of-job processing.

| IBM International Business Machines Corporation | | | | | | | | | | | | | | | | | | | | | | | | | | | | | | | | | | | | | | | | | | | | | GX21-9094-2 U/M 0507 | | | |
|---|-----------|----------------------|----------|---------|-----------------------------|---------------------|---|----------------|----|------------------------|-----------------------|------------------------------------|-----------------------|------------------|-------|---------------|--|--|--|--|--|--|--|--|--|--|--|--|--|--|--|--|--|--|--|--|--|--|--|--|--|--|--|--|----------------------|--|--|--|
| Program | | Punching Instruction | | Graphic | | Card Electro Number | | Page 1 2 of 03 | | Program Identification | | 75 76 77 78 79 80 | | | | | | | | | | | | | | | | | | | | | | | | | | | | | | | | | | | | |
| Programmer | | Date | | Punch | | | | | | RECEIV | | | | | | | | | | | | | | | | | | | | | | | | | | | | | | | | | | | | | | |
| Line | Form Type | Filename | Sequence | | Record Identification Codes | | | Field Location | | Field Name | Control Level (L1-L9) | Matching Fields or Chaining Fields | Field Record Relation | Field Indicators | | | | | | | | | | | | | | | | | | | | | | | | | | | | | | | | | | |
| | | | O | R | 1 | 2 | 3 | From | To | | | | | Plus | Minus | Zero or Blank | | | | | | | | | | | | | | | | | | | | | | | | | | | | | | | | |
| 01 | I | SALES | Ø11 | 41 | 1 | CN | | | Ø2 | 11 | SASMAN | | | | | | | | | | | | | | | | | | | | | | | | | | | | | | | | | | | | | |
| 02 | I | | | | | | | | Ø2 | 11 | SLSMANLL | | | | | | | | | | | | | | | | | | | | | | | | | | | | | | | | | | | | | |
| 03 | I | | | | | | | | | | | | | | | | | | | | | | | | | | | | | | | | | | | | | | | | | | | | | | | |
| 04 | I | | Ø2N | 42 | 1 | CO | | | Ø2 | Ø4 | NUMBER | | | | | | | | | | | | | | | | | | | | | | | | | | | | | | | | | | | | | |
| 05 | I | | | | | | | | Ø9 | 13 | ITEM | | | | | | | | | | | | | | | | | | | | | | | | | | | | | | | | | | | | | |
| 06 | I | | | | | | | | Ø6 | Ø8 | DEPT | | | | | | | | | | | | | | | | | | | | | | | | | | | | | | | | | | | | | |
| 07 | I | | | | | | | | 15 | 22 | DEL DAT | | | | | | | | | | | | | | | | | | | | | | | | | | | | | | | | | | | | | |
| 08 | I | | | | | | | | 24 | 3Ø | CUSTNO | | | | | | | | | | | | | | | | | | | | | | | | | | | | | | | | | | | | | |
| 09 | I | | | | | | | | | | | | | | | | | | | | | | | | | | | | | | | | | | | | | | | | | | | | | | | |
| 10 | I | | | | | | | | | | | | | | | | | | | | | | | | | | | | | | | | | | | | | | | | | | | | | | | |

| IBM International Business Machines Corporation | | | | | | | | | | | | | | | | | | | | | | | | | | | | | | | | | | | | | | | | | | | | | Form GX21-9093-2 | | | |
|---|-----------|--|------------|---------|-----|---------------------|-----------|----------------|--------------|------------------------|----------------------|-------------------|----------|------|--|--|--|--|--|--|--|--|--|--|--|--|--|--|--|--|--|--|--|--|--|--|--|--|--|--|--|--|--|--|------------------|--|--|--|
| Program | | Punching Instruction | | Graphic | | Card Electro Number | | Page 1 2 of 04 | | Program Identification | | 75 76 77 78 79 80 | | | | | | | | | | | | | | | | | | | | | | | | | | | | | | | | | | | | |
| Programmer | | Date | | Punch | | | | | | RECEIV | | | | | | | | | | | | | | | | | | | | | | | | | | | | | | | | | | | | | | |
| Line | Form Type | Control Level (L0-L9, L1-L9, SR, AN, OR) | Indicators | | | Factor 1 | Operation | Factor 2 | Result Field | | Resulting Indicators | | Comments | | | | | | | | | | | | | | | | | | | | | | | | | | | | | | | | | | | |
| | | | And | And | Not | | | | Name | Length | Plus | Minus | | Zero | | | | | | | | | | | | | | | | | | | | | | | | | | | | | | | | | | |
| 01 | C | | | | | | SETON | | | | | LR | | | | | | | | | | | | | | | | | | | | | | | | | | | | | | | | | | | | |
| 02 | C | | | | | | | | | | | | | | | | | | | | | | | | | | | | | | | | | | | | | | | | | | | | | | | |
| 03 | C | | | | | | | | | | | | | | | | | | | | | | | | | | | | | | | | | | | | | | | | | | | | | | | |
| 04 | C | | | | | | | | | | | | | | | | | | | | | | | | | | | | | | | | | | | | | | | | | | | | | | | |
| 05 | C | | | | | | | | | | | | | | | | | | | | | | | | | | | | | | | | | | | | | | | | | | | | | | | |
| 06 | C | | | | | | | | | | | | | | | | | | | | | | | | | | | | | | | | | | | | | | | | | | | | | | | |
| 07 | C | | | | | | | | | | | | | | | | | | | | | | | | | | | | | | | | | | | | | | | | | | | | | | | |
| 08 | C | | | | | | | | | | | | | | | | | | | | | | | | | | | | | | | | | | | | | | | | | | | | | | | |
| 09 | C | | | | | | | | | | | | | | | | | | | | | | | | | | | | | | | | | | | | | | | | | | | | | | | |
| 10 | C | | | | | | | | | | | | | | | | | | | | | | | | | | | | | | | | | | | | | | | | | | | | | | | |

Figure 3. Receive Only Program (Part 2 of 3)

Output Format Specifications (Figure 3, Part 3)

A permanent error causes an error message to be printed.

| IBM | | | | | | | | | | RPG OUTPUT SPECIFICATIONS | | | Page 05 of 06 | | Program Identification RECEIV | |
|------|-----------|---------------|--------------|-------------------|------------|----------------|--------------|---------------------|------------|---------------------------|---------------|----------------|---------------|------------|-------------------------------|--------------|
| File | File Name | Record Length | Record Count | Output Indicators | Field Name | Field Position | Field Length | Field Data | Field Type | Field Format | Field Content | Field Position | Field Length | Field Data | Field Type | Field Format |
| 01 | TOTLLISTH | 205 | 1P | | UPDATE | 10 | 10 | | | | | 10 | 10 | | | |
| 02 | | | | | | 29 | 29 | 'ORDER FROM' | | | | 29 | 29 | | | |
| 03 | | | | | | 47 | 47 | 'BRANCH OFFICE # 5' | | | | 47 | 47 | | | |
| 04 | | | | | | 9 | 9 | 'SALESMAN' | | | | 9 | 9 | | | |
| 05 | | | | | | 21 | 21 | 'ITEM' | | | | 21 | 21 | | | |
| 06 | | | | | | 36 | 36 | 'CUSTOMER' | | | | 36 | 36 | | | |
| 07 | | | | | | 54 | 54 | 'DELIVERY DATE' | | | | 54 | 54 | | | |
| 08 | | | | | | 10 | 10 | | | | | 10 | 10 | | | |
| 09 | | | | | | 23 | 23 | | | | | 23 | 23 | | | |
| 10 | | | | | | 35 | 35 | | | | | 35 | 35 | | | |
| 11 | | | | | | 48 | 48 | | | | | 48 | 48 | | | |
| 12 | | | | | | 14 | 14 | 'ERROR OCCURRED' | | | | 14 | 14 | | | |

| IBM | | | | | | | | | | RPG OUTPUT SPECIFICATIONS | | | Page 06 of 06 | | Program Identification RECEIV | |
|------|-----------|---------------|--------------|-------------------|------------|----------------|--------------|------------|------------|---------------------------|---------------|----------------|---------------|------------|-------------------------------|--------------|
| File | File Name | Record Length | Record Count | Output Indicators | Field Name | Field Position | Field Length | Field Data | Field Type | Field Format | Field Content | Field Position | Field Length | Field Data | Field Type | Field Format |
| 01 | DEPTLISTD | 42N99 | | | DEPT | 5 | 5 | | | | | 5 | 5 | | | |
| 02 | | | | | ITEM | 20 | 20 | | | | | 20 | 20 | | | |
| 03 | | | | | NUMBER | 27 | 27 | | | | | 27 | 27 | | | |
| 04 | | | | | DEL DAT | 40 | 40 | | | | | 40 | 40 | | | |
| 05 | | | | | CUSTNO | 60 | 60 | | | | | 60 | 60 | | | |
| 06 | | | | | SASMAN | 01 | 01 | '2' | | | | 01 | 01 | | | |
| 07 | | | | | *PRINT | 75 | 75 | | | | | 75 | 75 | | | |

Figure 3. Receive Only Program (Part 3 of 3)

Receive with Transmittal of Conversational Reply

File Description Specifications (Figure 4, Part 1)

The receive with transmittal of conversational reply function allows the RPG II user to receive data and, when necessary, to send a record to the remote terminal. Dual I/O areas and blocking or deblocking of data are not permitted.

The receive with transmittal of conversational reply file is defined as a combined file on the RPG File Description Specifications Sheet and as a receive file on the RPG Telecommunications Specifications Sheet.

The following program (Figure 4) is similar to the receive only program; however, the receiving station can now send a response to the remote station if the information received is incomplete.

| Column | Description |
|--------|--|
| 7-14 | SALES is a BSC file. |
| 15 | SALES is a combined file since it will receive data and transmit a conversational reply. |
| 16 | SALES is the primary input file for this program. |
| 17 | End-of-file on SALES does not determine end-of-job time. |
| 19 | BSC files always have a fixed length format. |
| 20-27 | Blocking and deblocking are not permitted for conversational BSC files. |
| 40-46 | BSCA is the device used for BSC files. |

RPG CONTROL CARD AND FILE DESCRIPTION SPECIFICATIONS

GX21-9092-4 UM 0507
Printed in U.S.A.

IBM International Business Machine Corporation

Program: _____

Programmer: _____ Date: _____

Punching Instruction: _____

Graphic: _____

Punch: _____

Card Electro Number: _____

Page 01 of 02

Program Identification: **RREPLY**

Control Card Specifications

| Line | Size to Compile | Object Output Listing Options | Size to Execute | Debug | Model 20 | Model 20 | Model 20 | Refer to the specific System Reference Library manual for actual entries. | | | | | | | | | | | | | | | | | | | | | | | | | | | | | | | | | | | | | | | | | | | | | | | | | | | | | | | | | | | | | | | |
|------|-----------------|-------------------------------|-----------------|-------|----------|----------|----------|---|----|----|----|----|----|----|----|----|----|----|----|----|----|----|----|----|----|----|----|----|----|----|----|----|----|----|----|----|----|----|----|----|----|----|----|----|----|----|----|----|----|----|----|----|----|----|----|----|----|----|----|----|----|----|----|----|----|----|----|----|----|----|----|
| 01 | H | | | | | | | | | | | | | | | | | | | | | | | | | | | | | | | | | | | | | | | | | | | | | | | | | | | | | | | | | | | | | | | | | | | | | | |
| 3 | 4 | 5 | 6 | 7 | 8 | 9 | 10 | 11 | 12 | 13 | 14 | 15 | 16 | 17 | 18 | 19 | 20 | 21 | 22 | 23 | 24 | 25 | 26 | 27 | 28 | 29 | 30 | 31 | 32 | 33 | 34 | 35 | 36 | 37 | 38 | 39 | 40 | 41 | 42 | 43 | 44 | 45 | 46 | 47 | 48 | 49 | 50 | 51 | 52 | 53 | 54 | 55 | 56 | 57 | 58 | 59 | 60 | 61 | 62 | 63 | 64 | 65 | 66 | 67 | 68 | 69 | 70 | 71 | 72 | 73 | 74 |

File Description Specification

| Line | Filename | File Type | File Designation | End of File | Sequence | | Block Length | Record Length | LR | APIK | DDTAV2 | Key Field Starting Location | Device | Symbolic Device | Labels S/N/E/M | Name of Label Exit | Extent Exit for DAM | Storage Index | Continuation Lines | File Addition/Unordered | | |
|------|-----------|-----------|------------------|-------------|-------------|------------------|--------------|---------------|----|------|--------|-----------------------------|--------|-----------------|----------------|--------------------|---------------------|---------------|--------------------|--|-------------------|--|
| | | | | | File Format | File Designation | | | | | | | | | | | | | | Number of Tracks for Cylinder Overflow | Number of Extents | |
| 02 | SALES | CP | | | | | 40 | 40 | | | | BSCA | | | | | | | | | | |
| 03 | TOTLLISTO | F | | | | | 120 | 120 | | L | | PRINTER | | | | | | | | | | |
| 04 | DEPTLISTO | F | | | | | 96 | 96 | | L | | MFCUL | | | | | | | | | | |
| 05 | | | | | | | | | | | | | | | | | | | | | | |
| 06 | | | | | | | | | | | | | | | | | | | | | | |
| 07 | | | | | | | | | | | | | | | | | | | | | | |
| 08 | | | | | | | | | | | | | | | | | | | | | | |
| 09 | | | | | | | | | | | | | | | | | | | | | | |
| 10 | | | | | | | | | | | | | | | | | | | | | | |

Figure 4. Receive with Transmittal of Conversational Reply Program (Part 1 of 4)

Telecommunications Specifications (Figure 4, Part 2)

Column Description

- 7-14 SALES is the BSC file for this program.
- 15-17 This station is part of a switched network (S) and will receive with conversational reply (R). Polling is not used, so column 17 is blank.
- 18, 19, 20 EBCDIC code (E) is used, but the transparency feature is not used (N). Autoanswer (A) is used by the called station.
- 32-47 Explicit station identification sequences are given for each station. Station IDs ensure data security on the switched network.
- 53-54 The permanent error indicator used is 88.
- 55-57 The telecommunications line will be kept open for 45 seconds even though no messages are being sent or received. After 45 seconds have elapsed, a permanent error condition results if the line still is not being used.

| IBM International Business Machines Corporation | | Program | | | | Punching Instruction | | | | Card Electro Number | | | | Page 02 of 02 | | | | Program Identification RREPLY | | | | | | | | | | | | | | | | | | | |
|---|-----------|----------|-------|---|--|----------------------|----|----|-----|---------------------|--|----|---|---------------|----|---------------|---------------------------|-------------------------------|-----------------------|------------|-------------------|-----------------------|----------|----|---|----|----|--|--|--|--|--|--|--|--|--|--|
| Line | Form Type | Filename | | | | | | | | | | | | | | Remote Device | Permanent Error Indicator | Wait Time | Record Available Flag | Local File | Polling Character | Addressing Characters | Reserved | | | | | | | | | | | | | | |
| 1 | T | 3 | SALES | 5 | | 15 | SR | 17 | ENA | 21 | | 32 | E | 34 | NO | 36 | | 40 | | 42 | | 53 | 88 | 55 | Ø | 57 | 45 | | | | | | | | | | |

Figure 4. Receive with Transmittal of Conversational Reply Program (Part 2 of 4)

Input Specifications (Figure 4, Part 3)

Calculation Specifications (Figure 4, Part 3)

Line 02, columns 69-70: If SLSMAN is absent from a record having an N in position 1, indicator 99 is set on.

If a permanent error occurs, LR is set on to enter end-of-job processing.

| I | | Record Identification Codes | | Field Location | | Field Indicators | |
|------|-----------|-----------------------------|------|----------------|----|------------------|-----------|
| Line | Form Type | Position | Code | From | To | Field Name | Indicator |
| 01 | I | 1 | CN | 02 | 11 | SASMAN | |
| 02 | I | | | 02 | 11 | SLSMANLI | 99 |
| 03 | I | | | | | | |
| 04 | I | 1 | CO | | | | |
| 05 | I | | | 02 | 04 | NUMBER | |
| 06 | I | | | 09 | 13 | ITEM | |
| 07 | I | | | 06 | 08 | DEPT | |
| 08 | I | | | 15 | 22 | DELDAT | |
| 09 | I | | | 24 | 30 | CUSTNO | |

| C | | Indicators | | Result Field | | Comments | |
|------|-----------|------------|------|--------------|--------|-----------|------|
| Line | Form Type | Indicator | Code | Name | Format | Indicator | Text |
| 01 | C | 88 | | SETON | | LR | |
| 02 | C | | | | | | |
| 03 | C | | | | | | |
| 04 | C | | | | | | |
| 05 | C | | | | | | |
| 06 | C | | | | | | |
| 07 | C | | | | | | |
| 08 | C | | | | | | |
| 09 | C | | | | | | |
| 10 | C | | | | | | |

Figure 4. Receive With Transmittal of Conversational Reply Program (Part 3 of 4)

Output Format Specifications (Figure 4, Part 4)

Page 06, lines 9-11: When indicator 99 is set on, a conversational reply is sent from SALES.

Page 05, lines 15-16: A permanent error causes an error message to be printed.

| IBM | | | | | RPG OUTPUT SPECIFICATIONS | | | | | | | | | | | | | | | GX21 9990 2 UM 05P | Page 1 2 | | Program 05 of 75 76 77 78 79 80 | | | | | | | | | |
|---------|-----------|------------|-------------------|----------------------|---------------------------|---------|-------------------|---------------------|-------------------------------|--------|------------------------|---------|----|------|------------------|------------------------|------------|---------------|--|--------------------|----------|--|---------------------------------|--|--|--|--|--|--|--|--|--|
| Program | | Date | | Punching Instruction | | Graphic | | Card Electro Number | | | | | | Page | | Program Identification | | | | | | | | | | | | | | | | |
| Line | Form Type | Filename | Type (H, D, T, E) | Space | Before | After | Output Indicators | Field Name | End Position in Output Record | Commas | Zero Balances to Print | No Sign | CR | X | Header Plus Sign | Date | Field Edit | Zero Suppress | | | | | | | | | | | | | | |
| 01 | O | TOTLLIST.H | A | 205 | LP | | UPDATE | | 10 | | | | | | | | | | | | | | | | | | | | | | | |
| 02 | O | | | | | | | | 29 | | | | | | | | | | | | | | | | | | | | | | | |
| 03 | O | | | | | | | | 47 | | | | | | | | | | | | | | | | | | | | | | | |
| 04 | O | | | | | | | | 47 | | | | | | | | | | | | | | | | | | | | | | | |
| 05 | O | | H | Z | LP | | | | 9 | | | | | | | | | | | | | | | | | | | | | | | |
| 06 | O | | | | | | | | 21 | | | | | | | | | | | | | | | | | | | | | | | |
| 07 | O | | | | | | | | 36 | | | | | | | | | | | | | | | | | | | | | | | |
| 08 | O | | | | | | | | 54 | | | | | | | | | | | | | | | | | | | | | | | |
| 09 | O | | | | | | | | | | | | | | | | | | | | | | | | | | | | | | | |
| 10 | O | | D | L | 42N88 | | SLSMAN | B | 10 | | | | | | | | | | | | | | | | | | | | | | | |
| 11 | O | | | | | | ITEM | | 23 | | | | | | | | | | | | | | | | | | | | | | | |
| 12 | O | | | | | | CUSTNO | | 35 | | | | | | | | | | | | | | | | | | | | | | | |
| 13 | O | | | | | | DELDAT | | 48 | | | | | | | | | | | | | | | | | | | | | | | |
| 14 | O | | T | L | 88 | | | | | | | | | | | | | | | | | | | | | | | | | | | |
| 15 | O | | | | | | | | | | | | | | | | | | | | | | | | | | | | | | | |
| 16 | O | | | | | | | | | | | | | | | | | | | | | | | | | | | | | | | |
| 17 | O | | | | | | | | | | | | | | | | | | | | | | | | | | | | | | | |
| 18 | O | | | | | | | | | | | | | | | | | | | | | | | | | | | | | | | |

| IBM | | | | | RPG OUTPUT SPECIFICATIONS | | | | | | | | | | | | | | | GX21 9990 2 UM 05P | Page 1 2 | | Program 06 of 75 76 77 78 79 80 | | | | | | | | | |
|---------|-----------|------------|-------------------|----------------------|---------------------------|---------|-------------------|---------------------|-------------------------------|--------|------------------------|---------|----|------|------------------|------------------------|------------|---------------|--|--------------------|----------|--|---------------------------------|--|--|--|--|--|--|--|--|--|
| Program | | Date | | Punching Instruction | | Graphic | | Card Electro Number | | | | | | Page | | Program Identification | | | | | | | | | | | | | | | | |
| Line | Form Type | Filename | Type (H, D, T, E) | Space | Before | After | Output Indicators | Field Name | End Position in Output Record | Commas | Zero Balances to Print | No Sign | CR | X | Header Plus Sign | Date | Field Edit | Zero Suppress | | | | | | | | | | | | | | |
| 01 | O | DEPTLIST.D | A | 42N88 | | | DEPT | | 5 | | | | | | | | | | | | | | | | | | | | | | | |
| 02 | O | | | | | | ITEM | | 20 | | | | | | | | | | | | | | | | | | | | | | | |
| 03 | O | | | | | | NUMBER | | 27 | | | | | | | | | | | | | | | | | | | | | | | |
| 04 | O | | | | | | DELDAT | | 40 | | | | | | | | | | | | | | | | | | | | | | | |
| 05 | O | | | | | | CUSTNO | | 60 | | | | | | | | | | | | | | | | | | | | | | | |
| 06 | O | | | | | | SASMAN | | 75 | | | | | | | | | | | | | | | | | | | | | | | |
| 07 | O | | | | | | *PRINT | | | | | | | | | | | | | | | | | | | | | | | | | |
| 08 | O | | | | | | | | | | | | | | | | | | | | | | | | | | | | | | | |
| 09 | O | SALES | D | 99N88 | | | | | | | | | | | | | | | | | | | | | | | | | | | | |
| 10 | O | | | | | | | | 16 | | | | | | | | | | | | | | | | | | | | | | | |
| 11 | O | | | | | | | | 33 | | | | | | | | | | | | | | | | | | | | | | | |
| 12 | O | | | | | | | | | | | | | | | | | | | | | | | | | | | | | | | |
| 13 | O | | | | | | | | | | | | | | | | | | | | | | | | | | | | | | | |

Figure 4. Receive With Transmittal of Conversational Reply Program (Part 4 of 4)

Transmit Only

File Description Specifications (Figure 5, Part 1)

The transmit only function allows the RPG II user to transmit BSC data to a remote location. Dual I/O areas and blocking of data can be used to increase throughput.

The transmit only file is defined as an output file on the RPG File Description Specifications Sheet and as a transmit file on the RPG Telecommunications Specifications Sheet.

This *transmit only* program (Figure 5) is reading and transmitting the card files produced by the *receive only* program (Figure 3). The week's data has been sorted by salesman name. The amount of each sale has been punched into the cards and the total sales for each salesman is transmitted to the branch office. After all cards have been read, the total of all sales is transmitted.

| Column | Description |
|--------|--|
| 7-14 | WKLYSMRY is a BSCA file. |
| 15 | Since WKLYSMRY is to be transmitted, it is an output file. |
| 19 | BSCA files always have a fixed length format. |
| 20-27 | Records are blocked. |
| 32 | Dual I/O areas are used. |
| 40-46 | BSCA is the device used for BSCA files. |

RPG CONTROL CARD AND FILE DESCRIPTION SPECIFICATIONS

LO 51 0002 4 107 0501
P 5002 4 115 A

IBM International Business Machines Corporation

Program: _____
 Programmer: _____ Date: _____

Punching Instruction: _____
 Graphic: _____
 Punch: _____

Card Electro Number: _____

Page 01 of

Program Identification: **TRNSMT**

75 76 77 78 79 80

File Description Specification

| Line | File Name | File Type | File Description | | File Format | | Mode of Processing | | Device | Symbolic Device | Label S, I, E, M | Name of Label Exit | Extent Exit for DAM | Storage Index | File Address/Unordered | |
|------|------------|-----------|------------------|----------|--------------|---------------|--|---------------------|---------|-----------------|------------------|--------------------|---------------------|---------------|--|-------------------|
| | | | Length | Sequence | Block Length | Record Length | Length of Key Field or of Record Address Field | Record Address Type | | | | | | | Number of Tracks for Cylinder Overflow | Number of Extents |
| | | | AS 2 | AS 4 | AS 2 | AS 4 | AS 2 | AS 4 | | | | | | | AS 2 | AS 4 |
| 0 2 | CARDFILEIP | F | 96 | 96 | L | | | | MFCUI | | | | | | | |
| 0 3 | WKLYSMRYO | F | 90 | 30 | L | | | | BSCA | | | | | | | |
| 0 4 | STOPT | O | 120 | 120 | | | | | PRINTER | | | | | | | |
| 0 5 | F | | | | | | | | | | | | | | | |
| 0 6 | F | | | | | | | | | | | | | | | |
| 0 7 | F | | | | | | | | | | | | | | | |
| 0 8 | F | | | | | | | | | | | | | | | |
| 0 9 | F | | | | | | | | | | | | | | | |
| 1 0 | F | | | | | | | | | | | | | | | |

Figure 5. Transmit Only Program (Part 1 of 3)

Telecommunications Specifications (Figure 5, Part 2)

| Column | Description |
|--------|--|
| 7-14 | WKLYSMRY is the BSCA file for this program. |
| 15-17 | This station is part of a switched network (S), and will be transmitting (T). Polling is not used, so column 17 is blank. |
| 18-19 | EBCDIC code (E) and the transparency feature (Y) are both used. |
| 20-31 | Autocall is used (S), and columns 21-31 contain the symbolic location of the dial number. |
| 32-47 | Symbolic locations are given for each station identification sequence. Station IDs ensure data security on the switched network. |

Column Description

| | |
|-------|--|
| 52 | Intermediate block check (I) is used. |
| 53-54 | The permanent error indicator used is 25. |
| 55-57 | The telecommunications line will be kept open for 70 seconds even though no messages are being sent or received. After 70 seconds have elapsed, a permanent error condition results if the line still is not being used. |

Input Specifications (Figure 5, Part 1)

Lines 01-03: The first card read contains the dial number of the remote station and both station identification sequences.

| IBM International Business Machine Corporation | | | | | | | | | | | | | | | | | | | | | | | | | | | | | | | | | | | | | | | | | | | | | | |
|--|------|-----------|----------|-------------|--|--|----------------|--|--|-----------------|--|--|------------|--|--|-----------|-----------------------|--|---------|--|----------------|------|--|--|------------------------|--|--|--|------------------|--|--|--------------------------------|--|--|--|--|--|--|--|--|--|--|--|--|--|--|
| RPG TELECOMMUNICATIONS SPECIFICATIONS | | | | | | | | | | | | | | | | | | | | | | | | | | | | | | | | | | | | | | | | | | | | | | |
| Program: _____ | | | | | | | | | | | | | | | | | Punching Instruction: | | | | Graphic Punch: | | | | Card Electrode Number: | | | | Page 02 of _____ | | | Program Identification: TRNSMT | | | | | | | | | | | | | | |
| Programmer: _____ | | | | | | | | | | | | | | | | | Date: _____ | | | | | | | | | | | | | | | | | | | | | | | | | | | | | |
| T | File | File Name | Sequence | Switchboard | | | Identification | | | Remote Terminal | | | Line Error | | | Wait Time | | | Polling | | | Time | | | Station | | | | | | | | | | | | | | | | | | | | | |
| 01 | T | WKLYSMRY | ST | DIAL# | | | SMYID | | | SYOURID | | | 125070 | | | | | | | | | | | | | | | | | | | | | | | | | | | | | | | | | |

| IBM International Business Machine Corporation | | | | | | | | | | | | | | | | | | | | | | | | | | | | | | | | | | | | | | | | | | | | | | |
|--|------|-----------|----------|-----------------------------|---|----|--|--|--|------|----|----------|----------------|--|--|--|-----------------------|--|--|--|----------------|--|--|--|------------------------|--|--|--|------------------|--|--|--------------------------------|--|--|--|--|--|--|--|--|--|--|--|--|--|--|
| RPG INPUT SPECIFICATIONS | | | | | | | | | | | | | | | | | | | | | | | | | | | | | | | | | | | | | | | | | | | | | | |
| Program: _____ | | | | | | | | | | | | | | | | | Punching Instruction: | | | | Graphic Punch: | | | | Card Electrode Number: | | | | Page 03 of _____ | | | Program Identification: TRNSMT | | | | | | | | | | | | | | |
| Programmer: _____ | | | | | | | | | | | | | | | | | Date: _____ | | | | | | | | | | | | | | | | | | | | | | | | | | | | | |
| I | Line | File Name | Sequence | Record Identification Codes | | | | | | | | | Field Location | | | | Field Indicators | | | | | | | | | | | | | | | | | | | | | | | | | | | | | |
| 01 | I | CARDFILE | A | 1 | 1 | CL | | | | From | | To | Field Name | | | | | | | | | | | | | | | | | | | | | | | | | | | | | | | | | |
| 02 | I | | B | 1 | 1 | CL | | | | 4 | 10 | DIAL# | | | | | | | | | | | | | | | | | | | | | | | | | | | | | | | | | | |
| 03 | I | | | | | | | | | 14 | 19 | MYID | | | | | | | | | | | | | | | | | | | | | | | | | | | | | | | | | | |
| 04 | I | | | | | | | | | 23 | 28 | YOURID | | | | | | | | | | | | | | | | | | | | | | | | | | | | | | | | | | |
| 05 | I | | B | 1 | 1 | CL | | | | 6 | 75 | SLSMANLI | | | | | | | | | | | | | | | | | | | | | | | | | | | | | | | | | | |
| 06 | I | | | | | | | | | 7 | 8 | AMOUNT | | | | | | | | | | | | | | | | | | | | | | | | | | | | | | | | | | |

Figure 5. Transmit Only Program (Part 2 of 3)

Calculation Specifications (Figure 5, Part 3)

Output-Format Specifications (Figure 5, Part 3)

If a permanent error occurs, LR is set on to enter end-of-job processing.

Lines 01-04: If a permanent error occurs, a message printed at total time identifies the record being processed when the permanent error occurred. However, because of record blocking and the use of dual I/O areas, all the records preceding the record identified may not have been transmitted.

Lines 05-10: When on, the permanent error indicator prevents the program from transmitting totals.

| IBM | | | RPG CALCULATION SPECIFICATIONS | | | Form GX21 9093 7 Printed in U.S.A. | | | | |
|---------|-----------|--|--------------------------------|---------|---------------------|---------------------------------------|----------|-------------------------------|----------------------|----------|
| Program | | Date | Punching Instruction | Graphic | Card Electro Number | Page 04 of 12 | | Program Identification TRNSMT | | |
| Line | Form Type | Control Level (L0-L9) LR, SR, AN/CR | Indicators | | Factor 1 | Operation | Factor 2 | Result Field | Resulting Indicators | Comments |
| 01 | C | | 25 | | | SETON | | | LR | |
| 02 | C | | 02N25 | | AMOUNT | ADD | MANSUM | MANSUM 62 | | |
| 03 | C | | LN25 | | MANSUM | ADD | TOTSUM | TOTSUM 62 | | |
| 04 | C | | | | | | | | | |
| 05 | C | | | | | | | | | |
| 06 | C | | | | | | | | | |
| 07 | C | | | | | | | | | |
| 08 | C | | | | | | | | | |

| IBM | | | RPG OUTPUT SPECIFICATIONS | | | Form GX21 9090 2 U-M 0567 Printed in U.S.A. | | | |
|---------|-----------|-----------|---------------------------|---------|---------------------|--|------------|-------------------------------|-----------------------|
| Program | | Date | Punching Instruction | Graphic | Card Electro Number | Page 05 of 12 | | Program Identification TRNSMT | |
| Line | Form Type | Filename | Type (H, D, T, E) | Space | Skip | Output Indicators | Field Name | End Position | Constant or Edit Word |
| 01 | O | STOPT | T | | | 25 | | | |
| 02 | O | | | | | | | 19 | 'PROGRAM INTERRUPTED' |
| 03 | O | | | | | | | 36 | 'WHILE PROCESSING' |
| 04 | O | | | | | | | 47 | |
| 05 | O | MKLYSMRYT | | | | LN25 | SLSMAN | | |
| 06 | O | | | | | | | 10 | |
| 07 | O | | | | | | SLSMAN | | |
| 08 | O | | T | | | LRN25 | MANSUM B | 30 | |
| 09 | O | | | | | | | 20 | 'TOTAL = ' |
| 10 | O | | | | | | TOTSUM | 30 | |
| 11 | O | | | | | | | | |
| 12 | O | | | | | | | | |
| 13 | O | | | | | | | | |
| 14 | O | | | | | | | | |

Figure 5. Transmit Only Program (Part 3 of 3)

Transmit with Reception of Conversational Reply

The transmit with reception of conversational reply function allows the RPG II user to transmit data to a remote terminal and receive a record in return. The received record will be made available by RPG II on the next input cycle.

Text may or may not be received for each block of text transmitted. When text is received, the user cannot send another block of text prior to processing the received record. Dual I/O areas and blocking or deblocking are not permitted. Matching fields are not permitted for the BSCA file.

The transmit with reception of conversational reply file is defined as a combined file on the RPG File Description Specification and as a transmit file on the RPG Telecommunication Specifications.

Programming Considerations

1. A conversational reply is in effect forced by RPG II. That is, the reply is accepted at output time, but it is not available for processing at the receiving station until the receiving station enters the next program cycle. When you transmit with receipt of conversational reply, then, be sure to review your program for compatibility with the RPG II Program Cycle. Do not expect to process a record that will not be available for processing or output until the next program cycle.
2. RPG II allows only one conversational reply for each RPG II Program Cycle. An error halt occurs if more than one conversational reply is received during one program cycle. The program is then terminated.
3. The records must be of equal length for both input and output.

This program (Figure 6) is similar to the *transmit only* program; however, the station receiving the transmission can now send a response that is printed on the System/3 printer.

File Description Specifications (Figure 6, Part 1)

| Column | Description |
|--------|---|
| 7-14 | WKLYSMRY is a BSC file. |
| 15-16 | WKLYSMRY is a combined file since it will receive records and have records transmitted from it. WKLYSMRY is the secondary input file. |
| 17 | End-of-file on WKLYSMRY does not determine end-of-job time. |
| 19 | BSC files always have a fixed length format. |
| 20-27 | Blocking and deblocking are not permitted for conversational BSC files. |
| 40-46 | BSCA is the device used for BSC files. |

Telecommunications Specifications (Figure 6, Part 1)

| Column | Description |
|--------|--|
| 7-14 | WKLYSMRY is the BSC file for this program. |
| 15-17 | This station is part of a switched network (S) and will be transmitting with reception of conversational reply (T). Polling is not used, so column 17 is blank. |
| 18-19 | EBCDIC code (E) and the transparency feature (Y) are both used. |
| 20-31 | Autocall is used (S), and columns 21-31 contain the symbolic location of the dial number. |
| 32-47 | Symbolic locations are given for each station identification sequence. Station IDs ensure data security on the switched network. |
| 53-54 | The permanent error indicator used is 77. |
| 55-57 | The telecommunications line will be kept open for 70 seconds even though no messages are being sent or received. After 70 seconds have elapsed, a permanent error condition results if the line still is not being used. |

RPG CONTROL CARD AND FILE DESCRIPTION SPECIFICATIONS

IBM
International Business Machines Corporation

Form G21-6992-3 UM 6/67
Product 611, A

| | | | |
|-------------|-----------------------|----------|----------------------|
| Program: | Punching Instruction: | Graphic: | Card Electro Number: |
| Programmer: | Date: | Panel: | |

Page **02** of **12** Program Identification: **TREPLY**

File Description Specification

| Line | File Type | File Designation | File Type | | Mode of Processing | | Device | Symbolic Device | Name of Label Exit | Extent Exit for DAM | File Addition/Unordered | | | | | |
|------|-----------|------------------|--------------|---------------|--|---------------------|---------|-----------------|--------------------|---------------------|-----------------------------|----------------|--|-------------------|---------------|-------------|
| | | | Block Length | Record Length | Length of Key Field or of Record Address Field | Record Address Type | | | | | Key Field Starting Location | Extension Code | Number of Tracks for Cylinder Overflow | Number of Extents | | |
| | | | File Format | | Type of File Organization or Additional Attributes | | | | | | | | | | Storage Index | Tape Rewind |
| | | | Sequence | | Type of File Organization or Additional Attributes | | | | | | | | | | | |
| 012 | F | CARDFILE | F | 96 | L | | MFCUL | | | | | | | | | |
| 03 | F | WKLYSMRYCS | F | 50 | | | BSCA | | | | | | | | | |
| 04 | F | REPLY | F | 132 | | | PRINTER | | | | | | | | | |

RPG TELECOMMUNICATIONS SPECIFICATIONS

IBM
International Business Machines Corporation

Form G21-9136-1
Product 611, A

| | | | |
|-------------|-----------------------|----------|----------------------|
| Program: | Punching Instruction: | Graphic: | Card Electro Number: |
| Programmer: | Date: | Punch: | |

Page **02** of **12** Program Identification: **TREPLY**

| Line | File Type | File Name | Switched | | Identification | | Remote Device | Wait Time | Remainder Error Indicator | Retard Advance Indicator | Last File Indicator | Polarity Characters | Addressing Characters | Reserved |
|------|-----------|------------|-------------|-------|----------------|----------------|---------------|-----------|---------------------------|--------------------------|---------------------|---------------------|-----------------------|----------|
| | | | Dial Number | | This Station | Remote Station | | | | | | | | |
| | | | | | SE | SE | | | | | | | | |
| 01 | T | WKLYSMRYST | EYS | DIAL# | SMYID | SYOURID | | 77 | 07 | | | | | |

Figure 6. Transmit With Reception of Conversational Reply Program (Part 1 of 3)

Calculation Specifications (Figure 6, Part 3)

If a permanent error occurs, LR is set on to enter end-of-job processing.

Output-Format Specifications (Figure 6, Part 3)

Lines 01-02: Conversational replies received are printed to the output file REPLY.

Line 03: A permanent error causes an error message to be printed.

Lines 04-08: Data is transmitted from WKLYSMRY.

| IBM | | RPG CALCULATION SPECIFICATIONS | | Form GX21-9093-2 Printed in U.S.A. | | | | | |
|------------|-----------|--------------------------------------|------------|---------------------------------------|-----------|----------|--------------|----------------------|----------|
| Program | | Punching Instruction | | Card Electro Number | | | | | |
| Programmer | | Date | | Page 04 of 05 | | | | | |
| | | | | Program Identification TREPLY | | | | | |
| Line | Form Type | Control Level (L, O, LR, SR, AN, CR) | Indicators | Factor 1 | Operation | Factor 2 | Result Field | Resulting Indicators | Comments |
| 01 | C | | 77 | | SETON | | | LR | |
| 02 | C | | 02N77 | AMOUNT | ADD | MANSUM | MANSUM 62 | | |
| 03 | C | | LLN77 | MANSUM | ADD | TOTSUM | TOTSUM 62 | | |
| 04 | C | | | | | | | | |
| 05 | C | | | | | | | | |

| IBM | | RPG OUTPUT SPECIFICATIONS | | Form GX21-9090-2 U/M 050* Printed in U.S.A. | | | | | |
|------------|-----------|---------------------------|---------------|--|------|-------------------|------------|-------------------------------|-----------------------|
| Program | | Punching Instruction | | Card Electro Number | | | | | |
| Programmer | | Date | | Page 05 of 05 | | | | | |
| | | | | Program Identification TREPLY | | | | | |
| Line | Form Type | Filename | Type (HD, TE) | Space | Skip | Output Indicators | Field Name | End Position in Output Record | Constant or Edit Word |
| 01 | O | REPLY | D | 33 | | 03N77 | *AUTO | | |
| 02 | O | | | | | | MESSG | 50 | |
| 03 | O | | | | | 77 | | | |
| 04 | O | | | | | | | 14 | 'ERROR OCCURRED' |
| 05 | O | WKLYSMRYT | | | | LLN77 | | | |
| 06 | O | | | | | | SLSMAN | 10 | |
| 07 | O | | | | | | MANSUM | 30 | |
| 08 | O | | | | | LRN77 | | | |
| 09 | O | | | | | | | 20 | 'TOTAL =' |
| 10 | O | | | | | | TOTSUM | 30 | |
| 11 | O | | | | | | | | |
| 12 | O | | | | | | | | |
| 13 | O | | | | | | | | |
| 14 | O | | | | | | | | |
| 15 | O | | | | | | | | |

Figure 6. Transmit With Reception of Conversational Reply Program (Part 3 of 3)

Transmit and Receive (No Conversational Reply)

Two files are defined, one as an input file on the RPG File Description Specifications Sheet and as a receive file on the RPG Telecommunications Specifications Sheet. The other file is defined as an output file on the RPG File Description Specifications Sheet and as a transmit file on the RPG Telecommunications Specifications Sheet.

Transmit and receive RPG BSC programs can be written three ways:

1. Transmit a file, then receive a file.
2. Receive a file, then transmit a file.
3. Transmit interspersed with receive (System/3 to OS or DOS only).

Programming Considerations

In any BSC program which transmits and receives with no conversational reply, columns 15 and 17-47 must be identical in the two RPG Telecommunications Specifications lines.

Transmit a File, Then Receive a File

The receive file must not be defined as the primary input file on the RPG File Description Specifications Sheet. An L must be entered in the Last File Processed column of the telecommunication specification. Matching fields and the record available indicators may not be defined for the BSC files.

System/3 in this example (Figure 7) is a tributary station (polling characters RR) on a multipoint network. OS or DOS is the control station (central) and polls the stations.

System/3 reads a card file containing part numbers and number of parts required. The cards have been sorted into ascending order by part number and are sequence checked by specifying a matching field (M1) on the RPG Input Specifications Sheet. The parts information is transmitted to the central when the central polls the station to see if any data is available. OS or DOS accepts the data from System/3 and sends back a list of parts that are not available. The list is printed on the System/3 printer. The L in column 60 of the Telecommunications Specifications Sheet causes the file named ANSWER to be processed after the other input file. Normally, any file without matching fields would be processed first.

File Description Specifications (Figure 7, Part 1)

Column Description

- 7-14 ANSWER and REQUEST are BSCA files.
- 15-17 ANSWER receives messages; therefore, it is an input file. It is the secondary input file, and determines end-of-job time. Since REQUEST is transmitted, it is an output file.
- 19 BSCA files always have a fixed length format.
- 20-27 ANSWER is not blocked; REQUEST is blocked.
- 40-46 BSCA is the device used for BSCA files.

| IBM | | RPG CONTROL CARD AND FILE DESCRIPTION SPECIFICATIONS | | | | | | | | | | GX219892 11/5/86 Program SA | |
|---------------------------------------|-----------|--|------------------------------|----------------------|--------------|---------------|--------------------|---|-----------------|-------------------------------|---------------------|--------------------------------|--------------------------|
| Program | | Date | | Punching Instruction | | Punch | | Card Electric Number | | Page 1 2 of 75 76 77 78 79 80 | | Program Identification TTR0LO | |
| Control Card Specifications | | | | | | | | | | | | | |
| Line | File Type | Data Size to Compare | Output Output Control Output | Card Size to Execute | Device | Model 20 | Model 20 | Refer to the specific System Reference Library manual for actual entries. | | | | | |
| 01 | H | | | | | | | | | | | | |
| File Description Specification | | | | | | | | | | | | | |
| Line | File Name | File Type | File Deviation | Sequence | Block Length | Record Length | Mode of Processing | Device | Symbolic Device | Name of Label Exit | Extent Exit for DAM | Core Index | File Addition Unrecorded |
| 01 | PARTS | IPEAF | | | 96 | 96 | L | MFCU | | | | | |
| 02 | ANSWER | ISEF | | | 50 | 50 | | BSCA | | | | | |
| 03 | REQUEST | O | | | 40 | 10 | | BSCA | | | | | |
| 04 | LIST | O | | | 120 | 120 | | PRINTER | | | | | |

Figure 7. Transmit Then Receive Program (No Conversational Reply)(Part 1 of 4)

Telecommunications Specifications (Figure 7, Part 2)

Column Description

Column Description

| | | | |
|-------|---|-------|---|
| 7-14 | REQUEST and ANSWER are the BSCA files for this program. | 55-57 | The telecommunications line will be kept open for 100 seconds even though no messages are being sent or received. After 100 seconds have elapsed, a permanent error condition results if the line still is not being used. |
| 15 | This station is part of a multipoint network (M). | | |
| 16 | REQUEST will be transmitted (T); ANSWER will receive data (R). | 60 | ANSWER must be the last file processed (L) because the sequence of the program is transmit a file, then receive a file. Without the L in column 60, ANSWER would be processed before PARTS, because PARTS has matching records. |
| 17 | This station is a tributary station (T) in a multipoint network, and polling is used. | | |
| 18-19 | EBCDIC code (E) and the transparency feature (Y) are both used. | 61-62 | RR are the polling characters used by the control station to request data from this tributary station. |
| 20-47 | Since polling is used, these columns are blank. | | |
| 53-54 | The permanent error indicator used is 66. | 63-64 | The addressing characters used by the control station to request that this tributary station receive data are 99. |

IBM International Business Machine Corporation Form GX219116.1
Printed in U. S. A.

RPG TELECOMMUNICATIONS SPECIFICATIONS

Program: _____

Punching Instruction: _____

Graphic Punch: _____

Card Electro Number: _____

Page 02 of 02

Program Identification: TTROLO

| Line | File name | P.S.M. Configuration | T/R Type of Station | T/O Type of Control | L/E Type of Code | Y/N Transparency | M/E/S/A/B | Switched | | | | Identification | | | | Remote Device | L-ITB | Permanent Error Indicator | Wait Time | Record Available Indicator | L-Last File | Polling Characters | Addressing Characters | Reserved |
|------|-----------|----------------------|---------------------|---------------------|------------------|------------------|-----------|-------------|--|--|--|----------------|--|----------------|--|---------------|-------|---------------------------|-----------|----------------------------|-------------|--------------------|-----------------------|----------|
| | | | | | | | | Dial Number | | | | This Station | | Remote Station | | | | | | | | | | |
| 01 | REQUEST | | M | T | Y | | | | | | | | | | | | | | | | | | | |
| 02 | ANSWER | | R | O | Y | | | | | | | | | | | 66 | L | 00 | | | R | R | | |
| 03 | | | | | | | | | | | | | | | | 66 | L | 00 | | L | | 99 | | |

Figure 7. Transmit Then Receive Program (No Conversational Reply) (Part 2 of 4)

Input Specifications (Figure 7, Part 3)

Lines 04-05: ANSWER, the secondary input file, receives data from the control station after REQUEST has been transmitted.

| IBM | | RPG INPUT SPECIFICATIONS | | | | | | | | | | | | | | | GX21 9094 2 U/M 050 Printed in U.S.A. | | | |
|------------|-----------|--------------------------|----------|----|-----------------------------|----|---|----------------|----|------------|----------------------|------------------------------------|-----------------------|------------------|---------------------|---------------|--|--|-------------------------------|--|
| Program | | Punching Instruction | | | | | | | | | | Graphic Punch | | | Card Electro Number | | Page 03 of 2 | | Program Identification TTR010 | |
| Programmer | | Date | | | | | | | | | | | | | | | | | | |
| Line | Form Type | Filename | Sequence | | Record Identification Codes | | | Field Location | | Field Name | Control Level (LTL9) | Matching Fields or Changing Fields | Field Record Relation | Field Indicators | | | | | | |
| | | | O | R | 1 | 2 | 3 | From | To | | | | | Plus | Minus | Zero or Blank | | | | |
| 0:1 | I | PARTS | LL | 23 | 96 | CP | | | | | | | | | | | | | | |
| 0:2 | I | | | | | | | | 1 | 30 | AMOUNT | | | | | | | | | |
| 0:3 | I | | | | | | | | 6 | 100 | CODE | ML | | | | | | | | |
| 0:4 | I | ANSWER | MM | 24 | | | | | | | | | | | | | | | | |
| 0:5 | I | | | | | | | | 1 | 50 | ALLGON | | | | | | | | | |
| 0:6 | I | | | | | | | | | | | | | | | | | | | |
| 0:7 | I | | | | | | | | | | | | | | | | | | | |
| 0:8 | I | | | | | | | | | | | | | | | | | | | |
| 0:9 | I | | | | | | | | | | | | | | | | | | | |
| 1:0 | I | | | | | | | | | | | | | | | | | | | |

Figure 7. Transmit Then Receive Program (No Conversational Reply) (Part 3 of 4)

Calculation Specifications (Figure 7, Part 4)

If a permanent error occurs, LR is set on to enter end-of-job processing.

Output-Format Specifications (Figure 7, Part 4)

Lines 01-03: Records read from PARTS are transmitted from REQUEST until end-of-file is reached on PARTS, and no more data is available for the control station.

Lines 04-05: Records received by ANSWER are printed to LIST.

Line 06: A permanent error causes an error message to be printed.

| IBM International Business Machine Corporation | | | | | | | | | | | | | | | | | | | | | | | | | | | | | | | | | | | | | | | | | | | | | | | | | | | | | | | | | | | | | | | | | | | | | | | | | | |
|--|-----------|---|------------|---------|-----|---------------------|-----------|---------------|--------------|------------------------|----------------------|-------------------|------------|--|--|--|--|--|--|--|--|--|--|--|--|--|--|--|--|--|--|--|--|--|--|--|--|--|--|--|--|--|--|--|--|--|--|--|--|--|--|--|--|--|--|--|--|--|--|--|--|--|--|--|--|--|--|--|--|--|--|--|--|--|
| RPG CALCULATION SPECIFICATIONS | | | | | | | | | | | | | | | | | | | | | | | | | | | | | | | | | | | | | | | | | | | | | | | | | | | | | | | | | | | | | | | | | | | | | | | | | | |
| Form GX21 9093 7 Printed in U.S.A. | | | | | | | | | | | | | | | | | | | | | | | | | | | | | | | | | | | | | | | | | | | | | | | | | | | | | | | | | | | | | | | | | | | | | | | | | | |
| Program | | Punching Instruction | | Graphic | | Card Electro Number | | Page 04 of 05 | | Program Identification | | 75 76 77 78 79 80 | | | | | | | | | | | | | | | | | | | | | | | | | | | | | | | | | | | | | | | | | | | | | | | | | | | | | | | | | | | | | | |
| Programmer | | Date | | Punch | | | | | | TTR0L0 | | | | | | | | | | | | | | | | | | | | | | | | | | | | | | | | | | | | | | | | | | | | | | | | | | | | | | | | | | | | | | | | |
| Line | Form Type | Control Level (L.O.L.B., L.R., SP, AN/OR) | Indicators | | | Factor 1 | Operation | Factor 2 | Result Field | | Resulting Indicators | Comments | | | | | | | | | | | | | | | | | | | | | | | | | | | | | | | | | | | | | | | | | | | | | | | | | | | | | | | | | | | | | | |
| | | | Not | And | And | | | | Name | Length | | | Arithmetic | | | | | | | | | | | | | | | | | | | | | | | | | | | | | | | | | | | | | | | | | | | | | | | | | | | | | | | | | | | | | |
| 01 | C | | | | | | | | | Plus Minus Zero | | | | | | | | | | | | | | | | | | | | | | | | | | | | | | | | | | | | | | | | | | | | | | | | | | | | | | | | | | | | | | | | |
| 02 | C | | | | | SETON | | | | Compare | | | | | | | | | | | | | | | | | | | | | | | | | | | | | | | | | | | | | | | | | | | | | | | | | | | | | | | | | | | | | | | | |
| 03 | C | | | | | | | | | High Low Equal | | | | | | | | | | | | | | | | | | | | | | | | | | | | | | | | | | | | | | | | | | | | | | | | | | | | | | | | | | | | | | | | |
| 04 | C | | | | | | | | | | | | | | | | | | | | | | | | | | | | | | | | | | | | | | | | | | | | | | | | | | | | | | | | | | | | | | | | | | | | | | | | | |
| 05 | C | | | | | | | | | | | | | | | | | | | | | | | | | | | | | | | | | | | | | | | | | | | | | | | | | | | | | | | | | | | | | | | | | | | | | | | | | |

| IBM International Business Machine Corporation | | | | | | | | | | | | | | | | | | | | | | | | | | | | | | | | | | | | | | | | | | | | | | | | | | | | | | | | | | | | | | | | | | | | | | | | | | |
|--|-----------|----------------------|------------------|---------|------|---------------------|-------|---------------|------------|-------------------------------|---------|-----------------------|--|--|--|--|--|--|--|--|--|--|--|--|--|--|--|--|--|--|--|--|--|--|--|--|--|--|--|--|--|--|--|--|--|--|--|--|--|--|--|--|--|--|--|--|--|--|--|--|--|--|--|--|--|--|--|--|--|--|--|--|--|--|
| RPG OUTPUT SPECIFICATIONS | | | | | | | | | | | | | | | | | | | | | | | | | | | | | | | | | | | | | | | | | | | | | | | | | | | | | | | | | | | | | | | | | | | | | | | | | | |
| Form GX21 9090 2 U.M. 050* Printed in U.S.A. | | | | | | | | | | | | | | | | | | | | | | | | | | | | | | | | | | | | | | | | | | | | | | | | | | | | | | | | | | | | | | | | | | | | | | | | | | |
| Program | | Punching Instruction | | Graphic | | Card Electro Number | | Page 05 of 05 | | Program Identification | | 75 76 77 78 79 80 | | | | | | | | | | | | | | | | | | | | | | | | | | | | | | | | | | | | | | | | | | | | | | | | | | | | | | | | | | | | | | |
| Programmer | | Date | | Punch | | | | | | TTR0L0 | | | | | | | | | | | | | | | | | | | | | | | | | | | | | | | | | | | | | | | | | | | | | | | | | | | | | | | | | | | | | | | | |
| Line | Form Type | Filename | Type (M/D/T/E/L) | Space | Skip | Output Indicators | | | Field Name | End Position in Output Record | P/B/L/R | Constant or Edit Word | | | | | | | | | | | | | | | | | | | | | | | | | | | | | | | | | | | | | | | | | | | | | | | | | | | | | | | | | | | | | | |
| | | | | | | Before | After | Not | | | | | | | | | | | | | | | | | | | | | | | | | | | | | | | | | | | | | | | | | | | | | | | | | | | | | | | | | | | | | | | | | | |
| 01 | O | REQUEST | D | | | | | | 23N66 | | | | | | | | | | | | | | | | | | | | | | | | | | | | | | | | | | | | | | | | | | | | | | | | | | | | | | | | | | | | | | | | | |
| 02 | O | | | | | | | | AMOUNT | 3 | | | | | | | | | | | | | | | | | | | | | | | | | | | | | | | | | | | | | | | | | | | | | | | | | | | | | | | | | | | | | | | | |
| 03 | O | | | | | | | | CODE | 10 | | | | | | | | | | | | | | | | | | | | | | | | | | | | | | | | | | | | | | | | | | | | | | | | | | | | | | | | | | | | | | | | |
| 04 | O | LIST | D | | | | | | N66 | 50 | | | | | | | | | | | | | | | | | | | | | | | | | | | | | | | | | | | | | | | | | | | | | | | | | | | | | | | | | | | | | | | | |
| 05 | O | | | | | | | | 66 | 14 | | 'ERROR OCCURRED' | | | | | | | | | | | | | | | | | | | | | | | | | | | | | | | | | | | | | | | | | | | | | | | | | | | | | | | | | | | | | | |
| 06 | O | | | | | | | | | | | | | | | | | | | | | | | | | | | | | | | | | | | | | | | | | | | | | | | | | | | | | | | | | | | | | | | | | | | | | | | | | |
| 07 | O | | | | | | | | | | | | | | | | | | | | | | | | | | | | | | | | | | | | | | | | | | | | | | | | | | | | | | | | | | | | | | | | | | | | | | | | | |
| 08 | O | | | | | | | | | | | | | | | | | | | | | | | | | | | | | | | | | | | | | | | | | | | | | | | | | | | | | | | | | | | | | | | | | | | | | | | | | |
| 09 | O | | | | | | | | | | | | | | | | | | | | | | | | | | | | | | | | | | | | | | | | | | | | | | | | | | | | | | | | | | | | | | | | | | | | | | | | | |
| 10 | O | | | | | | | | | | | | | | | | | | | | | | | | | | | | | | | | | | | | | | | | | | | | | | | | | | | | | | | | | | | | | | | | | | | | | | | | | |

Figure 7. Transmit Then Receive Program (No Conversational Reply) (Part 4 of 4)

Receive a File, Then Transmit a File

File Description Specifications (Figure 8, Part 1)

The receive file is defined as a primary or secondary file on the RPG File Description Specifications Sheet. The record available indicator must be blank on the RPG Telecommunications Specifications Sheet.

| Column | Description |
|--------|--|
| 7-14 | GRADES and RESULTS are BSCA files. |
| 15-16 | GRADES will receive data; therefore, it is an input file. It is the primary input file. RESULTS is the output file since it will be transmitted. |
| 17 | End-of-file on GRADES causes LR to be set on. |
| 19 | BSCA files always have a fixed length format. |
| 20-27 | Both files are blocked. |
| 32 | Dual I/O areas are used. |
| 40-46 | BSCA is the device for BSCA files. |

In the following example (Figure 8) all data for a student test given at a remote location is received by System/3. The first record contains the correct answers and the number of questions on the test (maximum 50). All following records contain student answers. The correct answers and the students answers are stored in arrays and compared. For each question the number of students that missed the question is then calculated and transmitted back to the remote terminal as an element of the array named RES.

| IBM International Business Machines Corporation | | | RPG CONTROL AND FILE DESCRIPTION SPECIFICATIONS | | | | | | | | | | | | | | | | | | | | | | | | | | | | | | GX21-9092: UM/050* Printed in U.S.A. | | | | | | | | | | | | | | | | | | | | | | | | | | | | | | | | | | | | | | | | | | | | | | | | | | | | | | | | | | | | | | | | | | | | | | | | | | | | | | | | | | | | | | | | | | | | | | | | | | | | | | | | | | | | | | | | | | | | | | | | | | | | | | | | | | | | | | | | | | | | | | | | | | | | | | | | | | | | | | | | | | | | | | | | | | | | | | | | | | | | | | | | | | | | | | | | | | | | | | | | | | | | | | | | | | | | | | | | | | | | | | | | | | | | | | | | | | | | | | | | | | | | | | | | | | | | | | | | | | | | | | | | | | | | | | | | | | | | | | | | | | | | | | | | | | | | | | | | | | | | | | | | | | | | | | | | | | | | | | | | | | | | | | | | | | | | | | | | | | | | | | | | | | | | | | | | | | | | | | | | | | | | | | | | | | | | | | | | | | | | | | | | | | | | | | | | | | | | | | | | | | | | | | | | | | | | | | | | | | | | | | | | | | | | | | | | | | | | | | | | | | | | | | | | | | | | | | | | | | | | | | | | | | | | | | | | | | | | | | | | | | | | | | | | | | | | | | | | | | | | | | | | | | | | | | | | | | | | | | | | | | | | | | | | | | | | | | | | | | | | | | | | | | | | | | | | | | | | | | | | | | | | | | | | | | | | | | | | | | | | | | | | | | | | | | | | | | | | | | | | | | | | | | | | | | | | | | | | | | | | | | | | | |
|--|-----------|-----------------|---|----------------------|------------------|------------------------|-------------|---------------------|----------------|--------------------|---------------------------|------------------------------------|-----------------------------|--------------------|---------------|-----------------|--------------------|-------------|--|----------------------|---------------------|----------------------|--|-------------------|--------------------|------------------|-----------------------------|---------------------|--------------------|------------|-------------|-----------------|---|-------------------|-----------------|-------------------------------|--------------------|---------------------|------------------------|--------------------|-----------|-------------------------|--------------------|--|------------------------------|-------------------|------------|---------------|-----------------|--------------------|-------------|--|---------|---------------------|-----------------|--|-------------------|--------------------|------------------|-----------------------------|---------------------|--------------------|------------|-------------|-----------------|--------------------------|--------------------|---------------------|---------------|--------------------|--|-------------------------|--|--|--|-------------------|--|-----------|---------------|---|-----|-----------|---|---|-----|---------|-----------|-----------------------------|--------------------|---|--------|-------|-----|-------|----------------------|-------------|----------------------|-----|---|--------|----|---|-----|----|--|--|--|--|--|--|--|--|--|--|--|--|--|--|--|--|--|--|--|--|--|--|--|--|--|--|--|--|--|--|--|--|--|--|--|--|--|--|--|--|-----|---|---------|---|---|-----|----|--|--|--|--|--|--|--|--|--|--|--|--|--|--|--|--|--|--|--|--|--|--|--|--|--|--|--|--|--|--|--|--|--|--|--|--|--|--|--|--|--|--|--|-----|---|-------|---|---|-----|-----|--|--|--|--|--|--|--|--|--|--|--|--|--|--|--|--|--|--|--|--|--|--|--|--|--|--|--|--|--|--|--|--|--|--|--|--|--|--|--|--|--|--|--|-----|---|--|--|--|--|--|--|--|--|--|--|--|--|--|--|--|--|--|--|--|--|--|--|--|--|--|--|--|--|--|--|--|--|--|--|--|--|--|--|--|--|--|--|--|--|--|--|--|--|--|-----|---|--|--|--|--|--|--|--|--|--|--|--|--|--|--|--|--|--|--|--|--|--|--|--|--|--|--|--|--|--|--|--|--|--|--|--|--|--|--|--|--|--|--|--|--|--|--|--|--|--|-----|---|--|--|--|--|--|--|--|--|--|--|--|--|--|--|--|--|--|--|--|--|--|--|--|--|--|--|--|--|--|--|--|--|--|--|--|--|--|--|--|--|--|--|--|--|--|--|--|--|--|-----|---|--|--|--|--|--|--|--|--|--|--|--|--|--|--|--|--|--|--|--|--|--|--|--|--|--|--|--|--|--|--|--|--|--|--|--|--|--|--|--|--|--|--|--|--|--|--|--|--|--|--|-----|---|--|--|--|--|--|--|--|--|--|--|--|--|--|--|--|--|--|--|--|--|--|--|--|--|--|--|--|--|--|--|--|--|--|--|--|--|--|--|--|--|--|--|--|--|--|--|--|--|--|--|-----|---|--|--|--|--|--|--|--|--|--|--|--|--|--|--|--|--|--|--|--|--|--|--|--|--|--|--|--|--|--|--|--|--|--|--|--|--|--|--|--|--|--|--|--|--|--|--|--|--|--|--|--|---|--|--|--|--|--|--|--|--|--|--|--|--|--|--|--|--|--|--|--|--|--|--|--|--|--|--|--|--|--|--|--|--|--|--|--|--|--|--|--|--|--|--|--|--|--|--|--|--|--|--|--|---|--|--|--|--|--|--|--|--|--|--|--|--|--|--|--|--|--|--|--|--|--|--|--|--|--|--|--|--|--|--|--|--|--|--|--|--|--|--|--|--|--|--|--|--|--|--|--|--|--|--|--|
| Program | | Date | | Punching Instruction | | Graphic | | Card Electro Number | | Page 01 of 01 | | Program Identification R T T L 0 0 | | 75 76 77 78 79 80 | | | | | | | | | | | | | | | | | | | | | | | | | | | | | | | | | | | | | | | | | | | | | | | | | | | | | | | | | | | | | | | | | | | | | | | | | | | | | | | | | | | | | | | | | | | | | | | | | | | | | | | | | | | | | | | | | | | | | | | | | | | | | | | | | | | | | | | | | | | | | | | | | | | | | | | | | | | | | | | | | | | | | | | | | | | | | | | | | | | | | | | | | | | | | | | | | | | | | | | | | | | | | | | | | | | | | | | | | | | | | | | | | | | | | | | | | | | | | | | | | | | | | | | | | | | | | | | | | | | | | | | | | | | | | | | | | | | | | | | | | | | | | | | | | | | | | | | | | | | | | | | | | | | | | | | | | | | | | | | | | | | | | | | | | | | | | | | | | | | | | | | | | | | | | | | | | | | | | | | | | | | | | | | | | | | | | | | | | | | | | | | | | | | | | | | | | | | | | | | | | | | | | | | | | | | | | | | | | | | | | | | | | | | | | | | | | | | | | | | | | | | | | | | | | | | | | | | | | | | | | | | | | | | | | | | | | | | | | | | | | | | | | | | | | | | | | | | | | | | | | | | | | | | | | | | | | | | | | | | | | | | | | | | | | | | | | | | | | | | | | | | | | | | | | | | | | | | | | | | | | | | | | | | | | | | | | | | | | | | | | | | | | | | | | | | | | | | | | | | | | | | | | | | | | | | | | | | | | | | | | | | | | | | | | | | | | | | | | | | | | | | | |
| Control Specifications | | | | | | | | | | | | | | | | | | | | | | | | | | | | | | | | | | | | | | | | | | | | | | | | | | | | | | | | | | | | | | | | | | | | | | | | | | | | | | | | | | | | | | | | | | | | | | | | | | | | | | | | | | | | | | | | | | | | | | | | | | | | | | | | | | | | | | | | | | | | | | | | | | | | | | | | | | | | | | | | | | | | | | | | | | | | | | | | | | | | | | | | | | | | | | | | | | | | | | | | | | | | | | | | | | | | | | | | | | | | | | | | | | | | | | | | | | | | | | | | | | | | | | | | | | | | | | | | | | | | | | | | | | | | | | | | | | | | | | | | | | | | | | | | | | | | | | | | | | | | | | | | | | | | | | | | | | | | | | | | | | | | | | | | | | | | | | | | | | | | | | | | | | | | | | | | | | | | | | | | | | | | | | | | | | | | | | | | | | | | | | | | | | | | | | | | | | | | | | | | | | | | | | | | | | | | | | | | | | | | | | | | | | | | | | | | | | | | | | | | | | | | | | | | | | | | | | | | | | | | | | | | | | | | | | | | | | | | | | | | | | | | | | | | | | | | | | | | | | | | | | | | | | | | | | | | | | | | | | | | | | | | | | | | | | | | | | | | | | | | | | | | | | | | | | | | | | | | | | | | | | | | | | | | | | | | | | | | | | | | | | | | | | | | | | | | | | | | | | | | | | | | | | | | | | | | | | | | | | | | | | | | | | | | | | | | | | | | | | | | | | | | | | | | | | | | | | | | | | |
| <table border="1" style="width:100%; border-collapse: collapse;"> <thead> <tr> <th>Line</th> <th>Form Type</th> <th>Size to Compile</th> <th>Object Output Listing Options</th> <th>Size to Execute</th> <th>Debug</th> <th>MFCM Stacking Sequence</th> <th>Date Format</th> <th>Date Edit</th> <th>Inverted Print</th> <th>380/20 2501 Buffer</th> <th>Number of Print Positions</th> <th>Alternate Collating Sequence</th> <th>Address to Start</th> <th>Work Tapes</th> <th>Priority Open</th> <th>Overlap Printer</th> <th>Binary Search</th> <th>Table Error</th> <th>2152 Checking</th> <th>Inquiry</th> <th>Read/Write/Compute</th> <th>Keyboard Output</th> <th>Sign Handling</th> <th>IP Forms Position</th> <th>Indicator Setting</th> <th>File Translation</th> <th>Punch MFCU Zeros</th> <th>Nonprint Characters</th> <th>Table Load Halt</th> <th>Shared I/O</th> <th>Field Print</th> <th>Formatted Dump</th> <th>RPG to RPG II Conversion</th> <th>Number of Formats</th> </tr> </thead> <tbody> <tr> <td>0 1</td> <td>H</td> <td></td> <td></td> <td></td> <td></td> <td></td> <td></td> <td></td> <td></td> <td></td> <td></td> <td></td> <td></td> <td></td> <td></td> <td></td> <td></td> <td></td> <td></td> <td></td> <td></td> <td></td> <td></td> <td></td> <td></td> <td></td> <td></td> <td></td> <td></td> <td></td> <td></td> <td></td> <td></td> <td></td> <td></td> <td></td> </tr> </tbody> </table> | | | | | | | | | | | | | | | | | | | | | | | | | | | | | | | | | Line | Form Type | Size to Compile | Object Output Listing Options | Size to Execute | Debug | MFCM Stacking Sequence | Date Format | Date Edit | Inverted Print | 380/20 2501 Buffer | Number of Print Positions | Alternate Collating Sequence | Address to Start | Work Tapes | Priority Open | Overlap Printer | Binary Search | Table Error | 2152 Checking | Inquiry | Read/Write/Compute | Keyboard Output | Sign Handling | IP Forms Position | Indicator Setting | File Translation | Punch MFCU Zeros | Nonprint Characters | Table Load Halt | Shared I/O | Field Print | Formatted Dump | RPG to RPG II Conversion | Number of Formats | 0 1 | H | | | | | | | | | | | | | | | | | | | | | | | | | | | | | | | | | | | | | | | | | | | | | | | | | | | | | | | | | | | | | | | | | | | | | | | | | | | | | | | | | | | | | | | | | | | | | | | | | | | | | | | | | | | | | | | | | | | | | | | | | | | | | | | | | | | | | | | | | | | | | | | | | | | | | | | | | | | | | | | | | | | | | | | | | | | | | | | | | | | | | | | | | | | | | | | | | | | | | | | | | | | | | | | | | | | | | | | | | | | | | | | | | | | | | | | | | | | | | | | | | | | | | | | | | | | | | | | | | | | | | | | | | | | | | | | | | | | | | | | | | | | | | | | | | | | | | | | | | | | | | | | | | | | | | | | | | | | | | | | | | | | | | | | | | | | | | | | | | | | | | | | | | | | | | | | | | | | | | | | | | | | | | | | | | | | | | | | | | | | | | | | | | | | | | | | | | | | | | | | | | | | | | | | | | | | | | | | | | | | | | | | | | | | | | | | | | | | | | | | | | | | | | | | | | | | | | | | | | | | | | | | | | | | | | | | | | | | | | | | | | | | | | | | | | | | | | | | | | | | | | | | | | | | | | | | | | | | | | | | | | | | | | | | | | | | | | | | | | | | | | | | | | | | | | | | | | | | | | | | | | | | | | | | | | | | | | | | | | | | | | | | | | | | | | |
| Line | Form Type | Size to Compile | Object Output Listing Options | Size to Execute | Debug | MFCM Stacking Sequence | Date Format | Date Edit | Inverted Print | 380/20 2501 Buffer | Number of Print Positions | Alternate Collating Sequence | Address to Start | Work Tapes | Priority Open | Overlap Printer | Binary Search | Table Error | 2152 Checking | Inquiry | Read/Write/Compute | Keyboard Output | Sign Handling | IP Forms Position | Indicator Setting | File Translation | Punch MFCU Zeros | Nonprint Characters | Table Load Halt | Shared I/O | Field Print | Formatted Dump | RPG to RPG II Conversion | Number of Formats | | | | | | | | | | | | | | | | | | | | | | | | | | | | | | | | | | | | | | | | | | | | | | | | | | | | | | | | | | | | | | | | | | | | | | | | | | | | | | | | | | | | | | | | | | | | | | | | | | | | | | | | | | | | | | | | | | | | | | | | | | | | | | | | | | | | | | | | | | | | | | | | | | | | | | | | | | | | | | | | | | | | | | | | | | | | | | | | | | | | | | | | | | | | | | | | | | | | | | | | | | | | | | | | | | | | | | | | | | | | | | | | | | | | | | | | | | | | | | | | | | | | | | | | | | | | | | | | | | | | | | | | | | | | | | | | | | | | | | | | | | | | | | | | | | | | | | | | | | | | | | | | | | | | | | | | | | | | | | | | | | | | | | | | | | | | | | | | | | | | | | | | | | | | | | | | | | | | | | | | | | | | | | | | | | | | | | | | | | | | | | | | | | | | | | | | | | | | | | | | | | | | | | | | | | | | | | | | | | | | | | | | | | | | | | | | | | | | | | | | | | | | | | | | | | | | | | | | | | | | | | | | | | | | | | | | | | | | | | | | | | | | | | | | | | | | | | | | | | | | | | | | | | | | | | | | | | | | | | | | | | | | | | | | | | | | | | | | | | | | | | | | | | | | | | | | | | | | | | | | | | | | | | | | | | | | | | | | | | | | | | | | | | | | | | | | | | | | | | | | | | | | | | | | | | | | | | | | | | | | | | | | |
| 0 1 | H | | | | | | | | | | | | | | | | | | | | | | | | | | | | | | | | | | | | | | | | | | | | | | | | | | | | | | | | | | | | | | | | | | | | | | | | | | | | | | | | | | | | | | | | | | | | | | | | | | | | | | | | | | | | | | | | | | | | | | | | | | | | | | | | | | | | | | | | | | | | | | | | | | | | | | | | | | | | | | | | | | | | | | | | | | | | | | | | | | | | | | | | | | | | | | | | | | | | | | | | | | | | | | | | | | | | | | | | | | | | | | | | | | | | | | | | | | | | | | | | | | | | | | | | | | | | | | | | | | | | | | | | | | | | | | | | | | | | | | | | | | | | | | | | | | | | | | | | | | | | | | | | | | | | | | | | | | | | | | | | | | | | | | | | | | | | | | | | | | | | | | | | | | | | | | | | | | | | | | | | | | | | | | | | | | | | | | | | | | | | | | | | | | | | | | | | | | | | | | | | | | | | | | | | | | | | | | | | | | | | | | | | | | | | | | | | | | | | | | | | | | | | | | | | | | | | | | | | | | | | | | | | | | | | | | | | | | | | | | | | | | | | | | | | | | | | | | | | | | | | | | | | | | | | | | | | | | | | | | | | | | | | | | | | | | | | | | | | | | | | | | | | | | | | | | | | | | | | | | | | | | | | | | | | | | | | | | | | | | | | | | | | | | | | | | | | | | | | | | | | | | | | | | | | | | | | | | | | | | | | | | | | | | | | | | | | | | | | | | | | | | | | | | | | | | | | | | | | | |
| File Description Specifications | | | | | | | | | | | | | | | | | | | | | | | | | | | | | | | | | | | | | | | | | | | | | | | | | | | | | | | | | | | | | | | | | | | | | | | | | | | | | | | | | | | | | | | | | | | | | | | | | | | | | | | | | | | | | | | | | | | | | | | | | | | | | | | | | | | | | | | | | | | | | | | | | | | | | | | | | | | | | | | | | | | | | | | | | | | | | | | | | | | | | | | | | | | | | | | | | | | | | | | | | | | | | | | | | | | | | | | | | | | | | | | | | | | | | | | | | | | | | | | | | | | | | | | | | | | | | | | | | | | | | | | | | | | | | | | | | | | | | | | | | | | | | | | | | | | | | | | | | | | | | | | | | | | | | | | | | | | | | | | | | | | | | | | | | | | | | | | | | | | | | | | | | | | | | | | | | | | | | | | | | | | | | | | | | | | | | | | | | | | | | | | | | | | | | | | | | | | | | | | | | | | | | | | | | | | | | | | | | | | | | | | | | | | | | | | | | | | | | | | | | | | | | | | | | | | | | | | | | | | | | | | | | | | | | | | | | | | | | | | | | | | | | | | | | | | | | | | | | | | | | | | | | | | | | | | | | | | | | | | | | | | | | | | | | | | | | | | | | | | | | | | | | | | | | | | | | | | | | | | | | | | | | | | | | | | | | | | | | | | | | | | | | | | | | | | | | | | | | | | | | | | | | | | | | | | | | | | | | | | | | | | | | | | | | | | | | | | | | | | | | | | | | | | | | | | | | | | | | | |
| <table border="1" style="width:100%; border-collapse: collapse;"> <thead> <tr> <th rowspan="2">Line</th> <th rowspan="2">Form Type</th> <th rowspan="2">Filename</th> <th colspan="2">File Type</th> <th colspan="2">File Designation</th> <th colspan="2">End of File</th> <th colspan="2">Sequence</th> <th colspan="2">File Format</th> <th colspan="2">Block Length</th> <th colspan="2">Record Length</th> <th colspan="2">Mode of Processing</th> <th colspan="2">Length of Key Field or of Record Address Field</th> <th colspan="2">Record Address Type</th> <th colspan="2">Type of File Organization or Additional Area</th> <th colspan="2">Overflow Indicator</th> <th colspan="2">Key Field Starting Location</th> <th colspan="2">Extension Code E/L</th> <th rowspan="2">Device</th> <th rowspan="2">Symbolic Device</th> <th rowspan="2">Labels S/N/E/M</th> <th rowspan="2">Name of Label Exit</th> <th rowspan="2">Extent Exit for DAM</th> <th rowspan="2">Storage Index</th> <th colspan="2">Continuation Lines</th> <th colspan="2">File Addition/Unordered</th> <th colspan="2">Number of Tracks for Cylinder Overflow</th> <th colspan="2">Number of Extents</th> </tr> <tr> <th>I/O/U/C/D</th> <th>P/S/C/R/T/D/E</th> <th>E</th> <th>A/D</th> <th>F/N/S/M/D</th> <th>F</th> <th>R</th> <th>L/R</th> <th>A/P/I/K</th> <th>P/X/D/T/R</th> <th>Key Field Starting Location</th> <th>Extension Code E/L</th> <th>K</th> <th>Option</th> <th>Entry</th> <th>A/J</th> <th>R/U/N</th> <th>File Condition U1-U8</th> <th>Tape Rewind</th> <th>File Condition U1-U8</th> </tr> </thead> <tbody> <tr> <td>0 2</td> <td>F</td> <td>GRADES</td> <td>IP</td> <td>F</td> <td>160</td> <td>80</td> <td></td> <td></td> <td></td> <td></td> <td></td> <td></td> <td></td> <td></td> <td></td> <td></td> <td></td> <td></td> <td></td> <td></td> <td></td> <td></td> <td></td> <td></td> <td></td> <td></td> <td></td> <td></td> <td></td> <td></td> <td></td> <td></td> <td></td> <td></td> <td></td> <td></td> <td></td> <td></td> <td></td> <td></td> <td></td> <td></td> <td></td> <td></td> <td></td> <td></td> </tr> <tr> <td>0 3</td> <td>F</td> <td>RESULTS</td> <td>O</td> <td>F</td> <td>160</td> <td>80</td> <td></td> <td></td> <td></td> <td></td> <td></td> <td></td> <td></td> <td></td> <td></td> <td></td> <td></td> <td></td> <td></td> <td></td> <td></td> <td></td> <td></td> <td></td> <td></td> <td></td> <td></td> <td></td> <td></td> <td></td> <td></td> <td></td> <td></td> <td></td> <td></td> <td></td> <td></td> <td></td> <td></td> <td></td> <td></td> <td></td> <td></td> <td></td> <td></td> <td></td> <td></td> <td></td> <td></td> </tr> <tr> <td>0 4</td> <td>F</td> <td>PRINT</td> <td>O</td> <td>F</td> <td>120</td> <td>120</td> <td></td> <td></td> <td></td> <td></td> <td></td> <td></td> <td></td> <td></td> <td></td> <td></td> <td></td> <td></td> <td></td> <td></td> <td></td> <td></td> <td></td> <td></td> <td></td> <td></td> <td></td> <td></td> <td></td> <td></td> <td></td> <td></td> <td></td> <td></td> <td></td> <td></td> <td></td> <td></td> <td></td> <td></td> <td></td> <td></td> <td></td> <td></td> <td></td> <td></td> <td></td> <td></td> <td></td> </tr> <tr> <td>0 5</td> <td>F</td> <td></td> <td></td> <td></td> <td></td> <td></td> <td></td> <td></td> <td></td> <td></td> <td></td> <td></td> <td></td> <td></td> <td></td> <td></td> <td></td> <td></td> <td></td> <td></td> <td></td> <td></td> <td></td> <td></td> <td></td> <td></td> <td></td> <td></td> <td></td> <td></td> <td></td> <td></td> <td></td> <td></td> <td></td> <td></td> <td></td> <td></td> <td></td> <td></td> <td></td> <td></td> <td></td> <td></td> <td></td> <td></td> <td></td> <td></td> <td></td> <td></td> </tr> <tr> <td>0 6</td> <td>F</td> <td></td> <td></td> <td></td> <td></td> <td></td> <td></td> <td></td> <td></td> <td></td> <td></td> <td></td> <td></td> <td></td> <td></td> <td></td> <td></td> <td></td> <td></td> <td></td> <td></td> <td></td> <td></td> <td></td> <td></td> <td></td> <td></td> <td></td> <td></td> <td></td> <td></td> <td></td> <td></td> <td></td> <td></td> <td></td> <td></td> <td></td> <td></td> <td></td> <td></td> <td></td> <td></td> <td></td> <td></td> <td></td> <td></td> <td></td> <td></td> <td></td> </tr> <tr> <td>0 7</td> <td>F</td> <td></td> <td></td> <td></td> <td></td> <td></td> <td></td> <td></td> <td></td> <td></td> <td></td> <td></td> <td></td> <td></td> <td></td> <td></td> <td></td> <td></td> <td></td> <td></td> <td></td> <td></td> <td></td> <td></td> <td></td> <td></td> <td></td> <td></td> <td></td> <td></td> <td></td> <td></td> <td></td> <td></td> <td></td> <td></td> <td></td> <td></td> <td></td> <td></td> <td></td> <td></td> <td></td> <td></td> <td></td> <td></td> <td></td> <td></td> <td></td> <td></td> </tr> <tr> <td>0 8</td> <td>F</td> <td></td> <td></td> <td></td> <td></td> <td></td> <td></td> <td></td> <td></td> <td></td> <td></td> <td></td> <td></td> <td></td> <td></td> <td></td> <td></td> <td></td> <td></td> <td></td> <td></td> <td></td> <td></td> <td></td> <td></td> <td></td> <td></td> <td></td> <td></td> <td></td> <td></td> <td></td> <td></td> <td></td> <td></td> <td></td> <td></td> <td></td> <td></td> <td></td> <td></td> <td></td> <td></td> <td></td> <td></td> <td></td> <td></td> <td></td> <td></td> <td></td> <td></td> </tr> <tr> <td>0 9</td> <td>F</td> <td></td> <td></td> <td></td> <td></td> <td></td> <td></td> <td></td> <td></td> <td></td> <td></td> <td></td> <td></td> <td></td> <td></td> <td></td> <td></td> <td></td> <td></td> <td></td> <td></td> <td></td> <td></td> <td></td> <td></td> <td></td> <td></td> <td></td> <td></td> <td></td> <td></td> <td></td> <td></td> <td></td> <td></td> <td></td> <td></td> <td></td> <td></td> <td></td> <td></td> <td></td> <td></td> <td></td> <td></td> <td></td> <td></td> <td></td> <td></td> <td></td> <td></td> </tr> <tr> <td>1 0</td> <td>F</td> <td></td> <td></td> <td></td> <td></td> <td></td> <td></td> <td></td> <td></td> <td></td> <td></td> <td></td> <td></td> <td></td> <td></td> <td></td> <td></td> <td></td> <td></td> <td></td> <td></td> <td></td> <td></td> <td></td> <td></td> <td></td> <td></td> <td></td> <td></td> <td></td> <td></td> <td></td> <td></td> <td></td> <td></td> <td></td> <td></td> <td></td> <td></td> <td></td> <td></td> <td></td> <td></td> <td></td> <td></td> <td></td> <td></td> <td></td> <td></td> <td></td> <td></td> </tr> <tr> <td></td> <td>F</td> <td></td> <td></td> <td></td> <td></td> <td></td> <td></td> <td></td> <td></td> <td></td> <td></td> <td></td> <td></td> <td></td> <td></td> <td></td> <td></td> <td></td> <td></td> <td></td> <td></td> <td></td> <td></td> <td></td> <td></td> <td></td> <td></td> <td></td> <td></td> <td></td> <td></td> <td></td> <td></td> <td></td> <td></td> <td></td> <td></td> <td></td> <td></td> <td></td> <td></td> <td></td> <td></td> <td></td> <td></td> <td></td> <td></td> <td></td> <td></td> <td></td> <td></td> </tr> <tr> <td></td> <td>F</td> <td></td> <td></td> <td></td> <td></td> <td></td> <td></td> <td></td> <td></td> <td></td> <td></td> <td></td> <td></td> <td></td> <td></td> <td></td> <td></td> <td></td> <td></td> <td></td> <td></td> <td></td> <td></td> <td></td> <td></td> <td></td> <td></td> <td></td> <td></td> <td></td> <td></td> <td></td> <td></td> <td></td> <td></td> <td></td> <td></td> <td></td> <td></td> <td></td> <td></td> <td></td> <td></td> <td></td> <td></td> <td></td> <td></td> <td></td> <td></td> <td></td> <td></td> <td></td> </tr> </tbody> </table> | | | | | | | | | | | | | | | | | | | | | | | | | | | | | | | | | Line | Form Type | Filename | File Type | | File Designation | | End of File | | Sequence | | File Format | | Block Length | | Record Length | | Mode of Processing | | Length of Key Field or of Record Address Field | | Record Address Type | | Type of File Organization or Additional Area | | Overflow Indicator | | Key Field Starting Location | | Extension Code E/L | | Device | Symbolic Device | Labels S/N/E/M | Name of Label Exit | Extent Exit for DAM | Storage Index | Continuation Lines | | File Addition/Unordered | | Number of Tracks for Cylinder Overflow | | Number of Extents | | I/O/U/C/D | P/S/C/R/T/D/E | E | A/D | F/N/S/M/D | F | R | L/R | A/P/I/K | P/X/D/T/R | Key Field Starting Location | Extension Code E/L | K | Option | Entry | A/J | R/U/N | File Condition U1-U8 | Tape Rewind | File Condition U1-U8 | 0 2 | F | GRADES | IP | F | 160 | 80 | | | | | | | | | | | | | | | | | | | | | | | | | | | | | | | | | | | | | | | | | 0 3 | F | RESULTS | O | F | 160 | 80 | | | | | | | | | | | | | | | | | | | | | | | | | | | | | | | | | | | | | | | | | | | | 0 4 | F | PRINT | O | F | 120 | 120 | | | | | | | | | | | | | | | | | | | | | | | | | | | | | | | | | | | | | | | | | | | | 0 5 | F | | | | | | | | | | | | | | | | | | | | | | | | | | | | | | | | | | | | | | | | | | | | | | | | | | 0 6 | F | | | | | | | | | | | | | | | | | | | | | | | | | | | | | | | | | | | | | | | | | | | | | | | | | | 0 7 | F | | | | | | | | | | | | | | | | | | | | | | | | | | | | | | | | | | | | | | | | | | | | | | | | | | 0 8 | F | | | | | | | | | | | | | | | | | | | | | | | | | | | | | | | | | | | | | | | | | | | | | | | | | | | 0 9 | F | | | | | | | | | | | | | | | | | | | | | | | | | | | | | | | | | | | | | | | | | | | | | | | | | | | 1 0 | F | | | | | | | | | | | | | | | | | | | | | | | | | | | | | | | | | | | | | | | | | | | | | | | | | | | | F | | | | | | | | | | | | | | | | | | | | | | | | | | | | | | | | | | | | | | | | | | | | | | | | | | | | F | | | | | | | | | | | | | | | | | | | | | | | | | | | | | | | | | | | | | | | | | | | | | | | | | | | |
| Line | Form Type | Filename | File Type | | File Designation | | End of File | | Sequence | | File Format | | Block Length | | Record Length | | Mode of Processing | | Length of Key Field or of Record Address Field | | Record Address Type | | Type of File Organization or Additional Area | | Overflow Indicator | | Key Field Starting Location | | Extension Code E/L | | Device | Symbolic Device | | | | Labels S/N/E/M | Name of Label Exit | Extent Exit for DAM | Storage Index | Continuation Lines | | File Addition/Unordered | | Number of Tracks for Cylinder Overflow | | Number of Extents | | | | | | | | | | | | | | | | | | | | | | | | | | | | | | | | | | | | | | | | | | | | | | | | | | | | | | | | | | | | | | | | | | | | | | | | | | | | | | | | | | | | | | | | | | | | | | | | | | | | | | | | | | | | | | | | | | | | | | | | | | | | | | | | | | | | | | | | | | | | | | | | | | | | | | | | | | | | | | | | | | | | | | | | | | | | | | | | | | | | | | | | | | | | | | | | | | | | | | | | | | | | | | | | | | | | | | | | | | | | | | | | | | | | | | | | | | | | | | | | | | | | | | | | | | | | | | | | | | | | | | | | | | | | | | | | | | | | | | | | | | | | | | | | | | | | | | | | | | | | | | | | | | | | | | | | | | | | | | | | | | | | | | | | | | | | | | | | | | | | | | | | | | | | | | | | | | | | | | | | | | | | | | | | | | | | | | | | | | | | | | | | | | | | | | | | | | | | | | | | | | | | | | | | | | | | | | | | | | | | | | | | | | | | | | | | | | | | | | | | | | | | | | | | | | | | | | | | | | | | | | | | | | | | | | | | | | | | | | | | | | | | | | | | | | | | | | | | | | | | | | | | | | | | | | | | | | | | | | | | | | | | | | | | | | | | | | | | | | | | | | | | | | | | | | | | | | | | | | | | | | | | | | | | | | | | | | | | | | | | | | | | | | | | | | | | | | | | | | | | | | | | | | | | | | | | |
| | | | I/O/U/C/D | P/S/C/R/T/D/E | E | A/D | F/N/S/M/D | F | R | L/R | A/P/I/K | P/X/D/T/R | Key Field Starting Location | Extension Code E/L | K | Option | Entry | A/J | R/U/N | File Condition U1-U8 | Tape Rewind | File Condition U1-U8 | | | | | | | | | | | | | | | | | | | | | | | | | | | | | | | | | | | | | | | | | | | | | | | | | | | | | | | | | | | | | | | | | | | | | | | | | | | | | | | | | | | | | | | | | | | | | | | | | | | | | | | | | | | | | | | | | | | | | | | | | | | | | | | | | | | | | | | | | | | | | | | | | | | | | | | | | | | | | | | | | | | | | | | | | | | | | | | | | | | | | | | | | | | | | | | | | | | | | | | | | | | | | | | | | | | | | | | | | | | | | | | | | | | | | | | | | | | | | | | | | | | | | | | | | | | | | | | | | | | | | | | | | | | | | | | | | | | | | | | | | | | | | | | | | | | | | | | | | | | | | | | | | | | | | | | | | | | | | | | | | | | | | | | | | | | | | | | | | | | | | | | | | | | | | | | | | | | | | | | | | | | | | | | | | | | | | | | | | | | | | | | | | | | | | | | | | | | | | | | | | | | | | | | | | | | | | | | | | | | | | | | | | | | | | | | | | | | | | | | | | | | | | | | | | | | | | | | | | | | | | | | | | | | | | | | | | | | | | | | | | | | | | | | | | | | | | | | | | | | | | | | | | | | | | | | | | | | | | | | | | | | | | | | | | | | | | | | | | | | | | | | | | | | | | | | | | | | | | | | | | | | | | | | | | | | | | | | | | | | | | | | | | | | | | | | | | | | | | | | | | | | | | | | | | | | | | | | | | | | | | | | | | | | | | | | | | | | | |
| 0 2 | F | GRADES | IP | F | 160 | 80 | | | | | | | | | | | | | | | | | | | | | | | | | | | | | | | | | | | | | | | | | | | | | | | | | | | | | | | | | | | | | | | | | | | | | | | | | | | | | | | | | | | | | | | | | | | | | | | | | | | | | | | | | | | | | | | | | | | | | | | | | | | | | | | | | | | | | | | | | | | | | | | | | | | | | | | | | | | | | | | | | | | | | | | | | | | | | | | | | | | | | | | | | | | | | | | | | | | | | | | | | | | | | | | | | | | | | | | | | | | | | | | | | | | | | | | | | | | | | | | | | | | | | | | | | | | | | | | | | | | | | | | | | | | | | | | | | | | | | | | | | | | | | | | | | | | | | | | | | | | | | | | | | | | | | | | | | | | | | | | | | | | | | | | | | | | | | | | | | | | | | | | | | | | | | | | | | | | | | | | | | | | | | | | | | | | | | | | | | | | | | | | | | | | | | | | | | | | | | | | | | | | | | | | | | | | | | | | | | | | | | | | | | | | | | | | | | | | | | | | | | | | | | | | | | | | | | | | | | | | | | | | | | | | | | | | | | | | | | | | | | | | | | | | | | | | | | | | | | | | | | | | | | | | | | | | | | | | | | | | | | | | | | | | | | | | | | | | | | | | | | | | | | | | | | | | | | | | | | | | | | | | | | | | | | | | | | | | | | | | | | | | | | | | | | | | | | | | | | | | | | | | | | | | | | | | | | | | | | | | | | | | | | | | | | | | | | | | | | | | | | | | | | | | | | | | | |
| 0 3 | F | RESULTS | O | F | 160 | 80 | | | | | | | | | | | | | | | | | | | | | | | | | | | | | | | | | | | | | | | | | | | | | | | | | | | | | | | | | | | | | | | | | | | | | | | | | | | | | | | | | | | | | | | | | | | | | | | | | | | | | | | | | | | | | | | | | | | | | | | | | | | | | | | | | | | | | | | | | | | | | | | | | | | | | | | | | | | | | | | | | | | | | | | | | | | | | | | | | | | | | | | | | | | | | | | | | | | | | | | | | | | | | | | | | | | | | | | | | | | | | | | | | | | | | | | | | | | | | | | | | | | | | | | | | | | | | | | | | | | | | | | | | | | | | | | | | | | | | | | | | | | | | | | | | | | | | | | | | | | | | | | | | | | | | | | | | | | | | | | | | | | | | | | | | | | | | | | | | | | | | | | | | | | | | | | | | | | | | | | | | | | | | | | | | | | | | | | | | | | | | | | | | | | | | | | | | | | | | | | | | | | | | | | | | | | | | | | | | | | | | | | | | | | | | | | | | | | | | | | | | | | | | | | | | | | | | | | | | | | | | | | | | | | | | | | | | | | | | | | | | | | | | | | | | | | | | | | | | | | | | | | | | | | | | | | | | | | | | | | | | | | | | | | | | | | | | | | | | | | | | | | | | | | | | | | | | | | | | | | | | | | | | | | | | | | | | | | | | | | | | | | | | | | | | | | | | | | | | | | | | | | | | | | | | | | | | | | | | | | | | | | | | | | | | | | | | | | | | | | | | | | | | | | | | | | | |
| 0 4 | F | PRINT | O | F | 120 | 120 | | | | | | | | | | | | | | | | | | | | | | | | | | | | | | | | | | | | | | | | | | | | | | | | | | | | | | | | | | | | | | | | | | | | | | | | | | | | | | | | | | | | | | | | | | | | | | | | | | | | | | | | | | | | | | | | | | | | | | | | | | | | | | | | | | | | | | | | | | | | | | | | | | | | | | | | | | | | | | | | | | | | | | | | | | | | | | | | | | | | | | | | | | | | | | | | | | | | | | | | | | | | | | | | | | | | | | | | | | | | | | | | | | | | | | | | | | | | | | | | | | | | | | | | | | | | | | | | | | | | | | | | | | | | | | | | | | | | | | | | | | | | | | | | | | | | | | | | | | | | | | | | | | | | | | | | | | | | | | | | | | | | | | | | | | | | | | | | | | | | | | | | | | | | | | | | | | | | | | | | | | | | | | | | | | | | | | | | | | | | | | | | | | | | | | | | | | | | | | | | | | | | | | | | | | | | | | | | | | | | | | | | | | | | | | | | | | | | | | | | | | | | | | | | | | | | | | | | | | | | | | | | | | | | | | | | | | | | | | | | | | | | | | | | | | | | | | | | | | | | | | | | | | | | | | | | | | | | | | | | | | | | | | | | | | | | | | | | | | | | | | | | | | | | | | | | | | | | | | | | | | | | | | | | | | | | | | | | | | | | | | | | | | | | | | | | | | | | | | | | | | | | | | | | | | | | | | | | | | | | | | | | | | | | | | | | | | | | | | | | | | | | | | | | | | | | |
| 0 5 | F | | | | | | | | | | | | | | | | | | | | | | | | | | | | | | | | | | | | | | | | | | | | | | | | | | | | | | | | | | | | | | | | | | | | | | | | | | | | | | | | | | | | | | | | | | | | | | | | | | | | | | | | | | | | | | | | | | | | | | | | | | | | | | | | | | | | | | | | | | | | | | | | | | | | | | | | | | | | | | | | | | | | | | | | | | | | | | | | | | | | | | | | | | | | | | | | | | | | | | | | | | | | | | | | | | | | | | | | | | | | | | | | | | | | | | | | | | | | | | | | | | | | | | | | | | | | | | | | | | | | | | | | | | | | | | | | | | | | | | | | | | | | | | | | | | | | | | | | | | | | | | | | | | | | | | | | | | | | | | | | | | | | | | | | | | | | | | | | | | | | | | | | | | | | | | | | | | | | | | | | | | | | | | | | | | | | | | | | | | | | | | | | | | | | | | | | | | | | | | | | | | | | | | | | | | | | | | | | | | | | | | | | | | | | | | | | | | | | | | | | | | | | | | | | | | | | | | | | | | | | | | | | | | | | | | | | | | | | | | | | | | | | | | | | | | | | | | | | | | | | | | | | | | | | | | | | | | | | | | | | | | | | | | | | | | | | | | | | | | | | | | | | | | | | | | | | | | | | | | | | | | | | | | | | | | | | | | | | | | | | | | | | | | | | | | | | | | | | | | | | | | | | | | | | | | | | | | | | | | | | | | | | | | | | | | | | | | | | | | | | | | | | | | | | | | | | | | | | | |
| 0 6 | F | | | | | | | | | | | | | | | | | | | | | | | | | | | | | | | | | | | | | | | | | | | | | | | | | | | | | | | | | | | | | | | | | | | | | | | | | | | | | | | | | | | | | | | | | | | | | | | | | | | | | | | | | | | | | | | | | | | | | | | | | | | | | | | | | | | | | | | | | | | | | | | | | | | | | | | | | | | | | | | | | | | | | | | | | | | | | | | | | | | | | | | | | | | | | | | | | | | | | | | | | | | | | | | | | | | | | | | | | | | | | | | | | | | | | | | | | | | | | | | | | | | | | | | | | | | | | | | | | | | | | | | | | | | | | | | | | | | | | | | | | | | | | | | | | | | | | | | | | | | | | | | | | | | | | | | | | | | | | | | | | | | | | | | | | | | | | | | | | | | | | | | | | | | | | | | | | | | | | | | | | | | | | | | | | | | | | | | | | | | | | | | | | | | | | | | | | | | | | | | | | | | | | | | | | | | | | | | | | | | | | | | | | | | | | | | | | | | | | | | | | | | | | | | | | | | | | | | | | | | | | | | | | | | | | | | | | | | | | | | | | | | | | | | | | | | | | | | | | | | | | | | | | | | | | | | | | | | | | | | | | | | | | | | | | | | | | | | | | | | | | | | | | | | | | | | | | | | | | | | | | | | | | | | | | | | | | | | | | | | | | | | | | | | | | | | | | | | | | | | | | | | | | | | | | | | | | | | | | | | | | | | | | | | | | | | | | | | | | | | | | | | | | | | | | | | | | | | | | |
| 0 7 | F | | | | | | | | | | | | | | | | | | | | | | | | | | | | | | | | | | | | | | | | | | | | | | | | | | | | | | | | | | | | | | | | | | | | | | | | | | | | | | | | | | | | | | | | | | | | | | | | | | | | | | | | | | | | | | | | | | | | | | | | | | | | | | | | | | | | | | | | | | | | | | | | | | | | | | | | | | | | | | | | | | | | | | | | | | | | | | | | | | | | | | | | | | | | | | | | | | | | | | | | | | | | | | | | | | | | | | | | | | | | | | | | | | | | | | | | | | | | | | | | | | | | | | | | | | | | | | | | | | | | | | | | | | | | | | | | | | | | | | | | | | | | | | | | | | | | | | | | | | | | | | | | | | | | | | | | | | | | | | | | | | | | | | | | | | | | | | | | | | | | | | | | | | | | | | | | | | | | | | | | | | | | | | | | | | | | | | | | | | | | | | | | | | | | | | | | | | | | | | | | | | | | | | | | | | | | | | | | | | | | | | | | | | | | | | | | | | | | | | | | | | | | | | | | | | | | | | | | | | | | | | | | | | | | | | | | | | | | | | | | | | | | | | | | | | | | | | | | | | | | | | | | | | | | | | | | | | | | | | | | | | | | | | | | | | | | | | | | | | | | | | | | | | | | | | | | | | | | | | | | | | | | | | | | | | | | | | | | | | | | | | | | | | | | | | | | | | | | | | | | | | | | | | | | | | | | | | | | | | | | | | | | | | | | | | | | | | | | | | | | | | | | | | | | | | | | | | | | | |
| 0 8 | F | | | | | | | | | | | | | | | | | | | | | | | | | | | | | | | | | | | | | | | | | | | | | | | | | | | | | | | | | | | | | | | | | | | | | | | | | | | | | | | | | | | | | | | | | | | | | | | | | | | | | | | | | | | | | | | | | | | | | | | | | | | | | | | | | | | | | | | | | | | | | | | | | | | | | | | | | | | | | | | | | | | | | | | | | | | | | | | | | | | | | | | | | | | | | | | | | | | | | | | | | | | | | | | | | | | | | | | | | | | | | | | | | | | | | | | | | | | | | | | | | | | | | | | | | | | | | | | | | | | | | | | | | | | | | | | | | | | | | | | | | | | | | | | | | | | | | | | | | | | | | | | | | | | | | | | | | | | | | | | | | | | | | | | | | | | | | | | | | | | | | | | | | | | | | | | | | | | | | | | | | | | | | | | | | | | | | | | | | | | | | | | | | | | | | | | | | | | | | | | | | | | | | | | | | | | | | | | | | | | | | | | | | | | | | | | | | | | | | | | | | | | | | | | | | | | | | | | | | | | | | | | | | | | | | | | | | | | | | | | | | | | | | | | | | | | | | | | | | | | | | | | | | | | | | | | | | | | | | | | | | | | | | | | | | | | | | | | | | | | | | | | | | | | | | | | | | | | | | | | | | | | | | | | | | | | | | | | | | | | | | | | | | | | | | | | | | | | | | | | | | | | | | | | | | | | | | | | | | | | | | | | | | | | | | | | | | | | | | | | | | | | | | | | | | | | | | | | | | |
| 0 9 | F | | | | | | | | | | | | | | | | | | | | | | | | | | | | | | | | | | | | | | | | | | | | | | | | | | | | | | | | | | | | | | | | | | | | | | | | | | | | | | | | | | | | | | | | | | | | | | | | | | | | | | | | | | | | | | | | | | | | | | | | | | | | | | | | | | | | | | | | | | | | | | | | | | | | | | | | | | | | | | | | | | | | | | | | | | | | | | | | | | | | | | | | | | | | | | | | | | | | | | | | | | | | | | | | | | | | | | | | | | | | | | | | | | | | | | | | | | | | | | | | | | | | | | | | | | | | | | | | | | | | | | | | | | | | | | | | | | | | | | | | | | | | | | | | | | | | | | | | | | | | | | | | | | | | | | | | | | | | | | | | | | | | | | | | | | | | | | | | | | | | | | | | | | | | | | | | | | | | | | | | | | | | | | | | | | | | | | | | | | | | | | | | | | | | | | | | | | | | | | | | | | | | | | | | | | | | | | | | | | | | | | | | | | | | | | | | | | | | | | | | | | | | | | | | | | | | | | | | | | | | | | | | | | | | | | | | | | | | | | | | | | | | | | | | | | | | | | | | | | | | | | | | | | | | | | | | | | | | | | | | | | | | | | | | | | | | | | | | | | | | | | | | | | | | | | | | | | | | | | | | | | | | | | | | | | | | | | | | | | | | | | | | | | | | | | | | | | | | | | | | | | | | | | | | | | | | | | | | | | | | | | | | | | | | | | | | | | | | | | | | | | | | | | | | | | | | | | | | | |
| 1 0 | F | | | | | | | | | | | | | | | | | | | | | | | | | | | | | | | | | | | | | | | | | | | | | | | | | | | | | | | | | | | | | | | | | | | | | | | | | | | | | | | | | | | | | | | | | | | | | | | | | | | | | | | | | | | | | | | | | | | | | | | | | | | | | | | | | | | | | | | | | | | | | | | | | | | | | | | | | | | | | | | | | | | | | | | | | | | | | | | | | | | | | | | | | | | | | | | | | | | | | | | | | | | | | | | | | | | | | | | | | | | | | | | | | | | | | | | | | | | | | | | | | | | | | | | | | | | | | | | | | | | | | | | | | | | | | | | | | | | | | | | | | | | | | | | | | | | | | | | | | | | | | | | | | | | | | | | | | | | | | | | | | | | | | | | | | | | | | | | | | | | | | | | | | | | | | | | | | | | | | | | | | | | | | | | | | | | | | | | | | | | | | | | | | | | | | | | | | | | | | | | | | | | | | | | | | | | | | | | | | | | | | | | | | | | | | | | | | | | | | | | | | | | | | | | | | | | | | | | | | | | | | | | | | | | | | | | | | | | | | | | | | | | | | | | | | | | | | | | | | | | | | | | | | | | | | | | | | | | | | | | | | | | | | | | | | | | | | | | | | | | | | | | | | | | | | | | | | | | | | | | | | | | | | | | | | | | | | | | | | | | | | | | | | | | | | | | | | | | | | | | | | | | | | | | | | | | | | | | | | | | | | | | | | | | | | | | | | | | | | | | | | | | | | | | | | | | | | | | | | |
| | F | | | | | | | | | | | | | | | | | | | | | | | | | | | | | | | | | | | | | | | | | | | | | | | | | | | | | | | | | | | | | | | | | | | | | | | | | | | | | | | | | | | | | | | | | | | | | | | | | | | | | | | | | | | | | | | | | | | | | | | | | | | | | | | | | | | | | | | | | | | | | | | | | | | | | | | | | | | | | | | | | | | | | | | | | | | | | | | | | | | | | | | | | | | | | | | | | | | | | | | | | | | | | | | | | | | | | | | | | | | | | | | | | | | | | | | | | | | | | | | | | | | | | | | | | | | | | | | | | | | | | | | | | | | | | | | | | | | | | | | | | | | | | | | | | | | | | | | | | | | | | | | | | | | | | | | | | | | | | | | | | | | | | | | | | | | | | | | | | | | | | | | | | | | | | | | | | | | | | | | | | | | | | | | | | | | | | | | | | | | | | | | | | | | | | | | | | | | | | | | | | | | | | | | | | | | | | | | | | | | | | | | | | | | | | | | | | | | | | | | | | | | | | | | | | | | | | | | | | | | | | | | | | | | | | | | | | | | | | | | | | | | | | | | | | | | | | | | | | | | | | | | | | | | | | | | | | | | | | | | | | | | | | | | | | | | | | | | | | | | | | | | | | | | | | | | | | | | | | | | | | | | | | | | | | | | | | | | | | | | | | | | | | | | | | | | | | | | | | | | | | | | | | | | | | | | | | | | | | | | | | | | | | | | | | | | | | | | | | | | | | | | | | | | | | | | | | | | | | |
| | F | | | | | | | | | | | | | | | | | | | | | | | | | | | | | | | | | | | | | | | | | | | | | | | | | | | | | | | | | | | | | | | | | | | | | | | | | | | | | | | | | | | | | | | | | | | | | | | | | | | | | | | | | | | | | | | | | | | | | | | | | | | | | | | | | | | | | | | | | | | | | | | | | | | | | | | | | | | | | | | | | | | | | | | | | | | | | | | | | | | | | | | | | | | | | | | | | | | | | | | | | | | | | | | | | | | | | | | | | | | | | | | | | | | | | | | | | | | | | | | | | | | | | | | | | | | | | | | | | | | | | | | | | | | | | | | | | | | | | | | | | | | | | | | | | | | | | | | | | | | | | | | | | | | | | | | | | | | | | | | | | | | | | | | | | | | | | | | | | | | | | | | | | | | | | | | | | | | | | | | | | | | | | | | | | | | | | | | | | | | | | | | | | | | | | | | | | | | | | | | | | | | | | | | | | | | | | | | | | | | | | | | | | | | | | | | | | | | | | | | | | | | | | | | | | | | | | | | | | | | | | | | | | | | | | | | | | | | | | | | | | | | | | | | | | | | | | | | | | | | | | | | | | | | | | | | | | | | | | | | | | | | | | | | | | | | | | | | | | | | | | | | | | | | | | | | | | | | | | | | | | | | | | | | | | | | | | | | | | | | | | | | | | | | | | | | | | | | | | | | | | | | | | | | | | | | | | | | | | | | | | | | | | | | | | | | | | | | | | | | | | | | | | | | | | | | | | | | | | |

Figure 8. Receive Then Transmit Program (No Conversational Reply) (Part 1 of 3)

Telecommunications Specifications (Figure 8, Part 2)

| <i>Column</i> | <i>Description</i> |
|---------------|--|
| 7-14 | GRADES and RESULTS are the BSCA files for this program. |
| 15 | This station is part of a switched network (S). |
| 16 | GRADES is an input file and will receive data (R). RESULTS is an output file and will be transmitted (T). |
| 17 | Polling is not used, so column 17 is blank. |
| 18-19 | EBCDIC code (E) and the transparency feature (Y) are both used. |
| 20 | Autoanswer (A) is used by the called station. |
| 32-47 | Explicit station identification sequences are entered. Station IDs ensure data security on the switched network. |

52

Intermediate block check (I) is used.

53-54

The permanent error indicator used is 55.

55-57

The telecommunications line will be kept open for 70 seconds even though no messages are being sent or received. After 70 seconds have elapsed, a permanent error condition results if the line still is not being used.

Input Specifications (Figure 8, Part 2)

Lines 01-03: The first record received contains the number of questions on the test and the correct answers to the questions. These answers form an array, ANSARR.

Lines 04-05: All records received after the first record contain students' answers to the test questions. These answers form the array STDARR.

IBM International Business Machine Corporation

RPG EXTENSION AND LINE COUNTER SPECIFICATIONS

Form X218091-2
Printed in U.S.A.

| | | | | | | | | | | | |
|------------|--|----------------------|--|---------|--|---------------------|--|----------|--|-----------------------------|--|
| Program | | Punching Instruction | | Graphic | | Card Electro Number | | Page 1 2 | | Program Identification | |
| Programmer | | Date | | Punch | | | | 02 of | | 75 76 77 78 79 80 RTTL00 | |

Extension Specifications

| Line | Form Type | Record description of the Chaining File | | To Filename | Table or Array Name | Number of Entries Per Record | Number of Entries Per Table or Array | Length of Entry | P.B.L.R. | Table or Array Name (Alternating Formats) | Length of Entry | P.B.L.R. | Comments |
|------|-----------|---|------------------------------|-------------|---------------------|------------------------------|--------------------------------------|-----------------|----------|---|-----------------|----------|----------|
| | | From Filename | Number of the Chaining Field | | | | | | | | | | |
| 01 | E | | | | ANSARR | | 50 | 1 | 0 | | | | |
| 02 | E | | | | STDARR | | 50 | 1 | 0 | | | | |
| 03 | E | | | | RES | | 50 | 3 | 0 | | | | |

IBM International Business Machine Corporation

RPG TELECOMMUNICATIONS SPECIFICATIONS

Form GX219116-1
Printed in U.S.A.

| | | | | | | | | | | | |
|------------|--|----------------------|--|---------|--|---------------------|--|----------|--|-----------------------------|--|
| Program | | Punching Instruction | | Graphic | | Card Electro Number | | Page 1 2 | | Program Identification | |
| Programmer | | Date | | Punch | | | | 03 of | | 75 76 77 78 79 80 RTTL00 | |

T

| Line | Form Type | Filename | P.S.M. Configuration | T.R. Type of Station | T.C. Type of Control | U.E. Type of Code | Y.N. Transparency | M.E.S.A.B. | Switched | | Identification | | Remote Device | I.F.B. Permanent Error Indicator | Wait Time | Record Available Indicator | L. Last File | Polling Characters | Addressing Characters | Reserved |
|------|-----------|----------|----------------------|----------------------|----------------------|-------------------|-------------------|------------|-------------|-------|----------------|----------------|---------------|----------------------------------|-----------|----------------------------|--------------|--------------------|-----------------------|----------|
| | | | | | | | | | Dial Number | SE | This Station | Remote Station | | | | | | | | |
| 01 | T | GRADES | SR | EYA | | | | | | E9876 | E1234 | | | L55070 | | | | | | |
| 02 | T | RESULTS | ST | EYA | | | | | | E9876 | E1234 | | | L55070 | | | | | | |

IBM International Business Machine Corporation

RPG INPUT SPECIFICATIONS

Form GX219994-1 U.M. 0507
Printed in U.S.A.

| | | | | | | | | | | | |
|------------|--|----------------------|--|---------|--|---------------------|--|----------|--|-----------------------------|--|
| Program | | Punching Instruction | | Graphic | | Card Electro Number | | Page 1 2 | | Program Identification | |
| Programmer | | Date | | Punch | | | | 04 of | | 75 76 77 78 79 80 RTTL00 | |

I

| Line | Form Type | Filename | Sequence | Number of Records | Record Identification Codes | | | | | | | | | Field Location | | Field Name | Control Code (U.L.L.P.) | Matching Fields or Chaining Fields | F.F.I. Record Indicator | Field Indicators | | |
|------|-----------|----------|----------|-------------------|-----------------------------|--------------------------|-----------|----------|--------------------------|-----------|----------|--------------------------|-----------|----------------|----|------------|-------------------------|------------------------------------|-------------------------|------------------|-------|---------------|
| | | | | | 1 | | | 2 | | | 3 | | | From | To | | | | | Plus | Minus | Zero or Blank |
| | | | | | Position | Not (N) C.Z.D. Character | Character | Position | Not (N) C.Z.D. Character | Character | Position | Not (N) C.Z.D. Character | Character | | | | | | | | | |
| 01 | I | GRADES | AA | 01 | 1 | CA | 2 | CN | 3 | CS | | | | | | | | | | | | |
| 02 | I | | | | | | | | | | | 5 | | 70#QUES | | | | | | | | |
| 03 | I | | | | | | | | | | | 11 | | 60 ANSARR | | | | | | | | |
| 04 | I | | BB | 02 | 1 | CS | 2 | CT | 3 | CD | | | | | | | | | | | | |
| 05 | I | | | | | | | | | | | 11 | | 60 STDARR | | | | | | | | |

Figure 8. Receive Then Transmit Program (No Conversational Reply) (Part 2 of 3)

Calculation Specification (Figure 8, Part 3)

Lines 01-02: If a permanent error occurs, LR is set on and 02 is set off to enter end-of-job processing immediately.

Lines 03-09: The array containing the correct answers (ANSARR) is compared an element at a time to the arrays formed by students' answers (STDARR). From these comparisons the number of wrong answers to each question is computed and entered in the array RES.

Lines 11-18: When the entire input file (GRADES) has been received and the LR indicator set on, RES is transmitted from RESULTS by exception output, one element at a time, unless a permanent error occurs.

Output - Format Specification (Figure 8, Part 3)

Lines 01-04: RESULTS is transmitted as exception output.

Lines 05-06: A permanent error causes an error message to be written.

| C | | Indicators | | Factor 1 | Operator | Factor 2 | Result Field | Resulting Indicators |
|------|------|------------|-------|-----------|----------------|----------|--------------|----------------------|
| Line | Type | And | And | | | | Name | Length |
| 01 | C | 55 | | | SETON | | | LR |
| 02 | C | 55 | | | SETOF | | | 02 |
| 03 | C | | 02N01 | | Z-ADDL | | X | 20 |
| 04 | C | | | REPEAT | TAG | | | |
| 05 | C | 02 | | STDARR, X | COMP ANSARR, X | | | 0606 |
| 06 | C | 06 | 02 | L | ADD RES, X | | RES, X | |
| 07 | C | | 02 | L | ADD X | | X | |
| 08 | C | | 02 | X | COMP #QUES | | | 1010 |
| 09 | C | 10 | 02 | | GOTO REPEAT | | | |
| 10 | C | | | | Z-ADDL | | X | |
| 11 | C | | | LOOP | TAG | | | |
| 12 | C | | | | EXCPT | | | |
| 13 | C | | | | GOTO OUT | | | |
| 14 | C | | | L | ADD X | | X | |
| 15 | C | | | X | COMP #QUES | | | 1111 |
| 16 | C | | | | GOTO LOOP | | | |
| 17 | C | | | OUT | TAG | | | |

| O | | Output Indicators | | Field Name | Constant or Field Word |
|------|------|-------------------|-----|------------|------------------------|
| Line | Type | And | And | | |
| 01 | O | RESULTS | E | LRN55 | |
| 02 | O | | | RES, X | 10 |
| 03 | O | | | X | 29 |
| 04 | O | | | | 31 |
| 05 | O | PRINT | E | 55 | |
| 06 | O | | | | 14 |
| 07 | O | | | | |
| 08 | O | | | | |
| 09 | O | | | | |
| 10 | O | | | | |
| 11 | O | | | | |

Figure 8. Receive Then Transmit Program (No Conversational Reply) (Part 3 of 3)

Transmit Interspersed with Receive (System/3 to OS or DOS Only)

A “transmit interspersed with receive” program transmits data from one file and receives data in another; the data in the two files may or may not be related. Unlike conversational programs, a “transmit interspersed with receive” program may intersperse data several records or several blocks at a time.

The receive file must be defined as a Demand file on the RPG File Description Specification. The record available indicator must be defined on the RPG Telecommunication Specification. This method of transmission can be used only when System/3 is the remote terminal that initiated the transmission. When data is transmitted from the control station, System/3 suspends its transmit file to receive the incoming data.

Programming Considerations

Once System/3 BSC has begun to process the last record in the BSCA transmit file, System/3 will ignore the record available indicator, whether or not the last record has actually been transmitted. When BSC accepts for transmission the last record in the file, RPG II completes LR processing and begins to close the file.

This means that after RPG II passes the last record in the transmit file to BSC, RPG II completes Last Record (LR) processing and begins to close the file. Consequently, if OS or DOS requests to transmit a response to a record or block transmitted by System/3, the request is ignored if it is a response to the last record or last block in the file. If OS or DOS requests a response on the next-to-the-last record or block in the file, the request is ignored only if the file has already been closed.

The System/3 programmer can avoid problems this may raise in a particular program by agreeing with the OS or DOS programmer upon a special record to be added to the end of the System/3 transmit file. This record would signal OS or DOS that System/3 has gone to end-of-job and cannot honor a request to receive from OS or DOS, even though that request may have just been transmitted.

In Figure 9, a card file containing information about a student test is read in and transmitted to an OS or DOS for processing. During transmission, OS or DOS may interrupt to send back results. When this occurs, RPG will turn on record available indicator 04. The input file is then read and the incoming data is printed on the printer. System/3 then resumes transmission.

File Description Specifications (Figure 9, Part 1)

| <i>Column</i> | <i>Description</i> |
|---------------|--|
| 7-14 | RESULTS and GRADES are BSC files. |
| 15 | RESULTS will receive data; therefore, it is an input file. GRADES will be transmitted and is an output file. |
| 16 | To receive data intermittently, a BSC file must be a demand file. |
| 17 | End-of-file on RESULTS does not determine end-of-job time. |
| 19 | BSC files always have a fixed length format. |
| 20-27 | Neither BSC file is blocked. |
| 40-46 | BSCA is the device for BSC files. |

RPG CONTROL CARD AND FILE DESCRIPTION SPECIFICATIONS

| | | | |
|------------|----------------------|---------|---------------------|
| Program | Punching Instruction | Graphic | Card Electro Number |
| Programmer | Date | Punch | |

Page 1 of 2
 Program Ident. Location TRTRØL

Control Card Specifications

| Line | Form Type | Core Size to Compile | Object Output Listing Options | Core Size to Execute | Debug MFCM Stacking Sequence | Inverted Print Buffer | Number of Print Positions | Address to Start | Work Tables | Work Tables Overlay Open | Work Tables Overlay Printer | Binary Search | Tape Error | 2152 Checkin Inquiry | Read Write Control | Key Board Control | Sign Handling | 18 Points Position | Indicator Setting | File Transition | Page MFCU Zero | Nonprint Characters | Tape Load Halt | Sheet IO | Card Print | Formatted Core Dump | RPG to RPG II Conversion |
|------|-----------|----------------------|-------------------------------|----------------------|------------------------------|-----------------------|---------------------------|------------------|-------------|--------------------------|-----------------------------|---------------|------------|----------------------|--------------------|-------------------|---------------|--------------------|-------------------|-----------------|----------------|---------------------|----------------|----------|------------|---------------------|--------------------------|
| 01 | H | | | | | | | | | | | | | | | | | | | | | | | | | | |

Refer to the specific System Reference Library manual for actual entries.

File Description Specification

| Line | Form Type | Filename | File Type | | File Designation | | Mode of Processing | | Device | Symbolic Device | Name of Label Exit | Extent Exit for DAM | File Addition/Unordered | |
|------|-----------|----------|-----------|-------------|------------------|---------------|--|---------------------|--------|-----------------|--------------------|---------------------|--|-------------------|
| | | | IO/JUC/D | P/S/C/R/T/D | End of File | Sequence | Length of Key Field or of Record Address Field | Record Address Type | | | | | Number of Tracks for Cylinder Overflow | Number of Extents |
| | | | | File Format | Block Length | Record Length | AP/IK | ID Tap 2 | | | Continuation Lines | | Tape Record | File Condition |
| 02 | F | STUDENT | I | P | | 96 | 96 | | | MFCUL | | | | |
| 03 | F | RESULTS | I | D | | 80 | 80 | | | BSCA | | | | |
| 04 | F | GRADES | Q | | | 80 | 80 | 2 | | BSCA | | | | |
| 05 | F | PRINT | Q | | | L32 | L32 | | | PRINTER | | | | |

Figure 9. Transmit Interspersed With Receive Program (No Conversational Reply) (Part 1 of 3)

Telecommunications Specifications (Figure 9, Part 2)

| <i>Column</i> | <i>Description</i> | | |
|---------------|---|-------|--|
| | | 32-47 | Explicit station identification sequences are given. Station IDs ensure data security on the switched network. |
| | | 53-54 | The permanent error indicator used is 44. |
| 7-14 | RESULTS and GRADES are the BSCA files for this program. | 55-57 | The telecommunications line will be kept open for 70 seconds even though no messages are being sent or received. After 70 seconds have elapsed, a permanent error condition results if the line still is not being used. |
| 15 | This station is part of a switched network (S). | | |
| 16 | RESULTS is an input file and will receive data (R). GRADES is an output file and will be transmitted (T). | 58-59 | The record available indicator is 04. It is set on when the remote station is ready to send a record to be received by RESULTS. |
| 17 | Polling is not used, so column 17 is blank. | | |
| 18-19 | EBCDIC code (E) and the transparency feature (Y) are both used. | | |
| 20-31 | Autocall is used (E), and columns 21-31 contain the dial number of the remote station. | | |

Input Specifications (Figure 9, Part 2)

Lines 07-09: RESULTS receives records from the remote station. These records contain a student number and the student's score. Student scores are calculated by the remote station from the data transmitted from GRADES.

IBM

RPG EXTENSION AND LINE COUNTER SPECIFICATIONS

02

TRTR01

Extension Specifications

E

| | | | |
|--------|----|---|---|
| ANSARR | 50 | 1 | 0 |
| STDARR | 50 | 1 | 0 |

IBM

RPG TELECOMMUNICATIONS SPECIFICATIONS

03

TRTR01

T

| | | | | | |
|---------|----|-----|-------|-------|---------|
| RESULTS | SR | EYE | E9876 | E5678 | 4407004 |
| GRADES | ST | EYE | E9876 | E5678 | 44070 |

IBM

RPG INPUT SPECIFICATIONS

04

TRTR01

I

| | | | | | | | | | | |
|---------|----|----|---|----|---|----|---|----|----|-----------|
| STUDENT | AA | 01 | 1 | CA | 2 | CN | 3 | CS | 5 | 70#QUES |
| | | | | | | | | | 11 | 60 ANSARR |
| | BB | 02 | 1 | CS | 2 | CT | 3 | CD | 3 | 5 STUDID |
| RESULTS | CC | 03 | 1 | CR | | | | | 11 | 60 STDARR |
| | | | | | | | | | 3 | 5 STDNT |
| | | | | | | | | | 8 | 10 SCORE |

Figure 9. Transmit Interspersed With Receive Program (No Conversational Reply) (Part 2 of 3)

Calculation Specifications (Figure 9, Part 3)

The calculation sequence obtains the scores computed by the remote station from GRADES and makes them available for exception output to PRINT.

Lines 01-06: Loop 1 is executed during detail time; that is, before end-of-file is reached on STUDENTS. When the remote station causes the record available indicator (04) to be set on, the READ operation accepts a record from the remote station and places it in RESULTS. Indicator 10 is set on when READ encounters an end-of-file condition. Until 04 is set off and 10 is set on, records will be accepted to RESULTS and will be available for exception output to PRINT. Loop 1 can be entered or re-entered anytime 04 is set on, except after end-of-file has been reached on STUDENTS. Therefore, after one group of records has been read by the receiving station, the receiving station must set the end-of-file indicator (10) off so that the next group of records may be read.

Lines 07-12: Loop 2 is executed during total time, that is, after end-of-file has been reached on STUDENTS and the ER indicator set on. Loop 2 processes records for RESULTS

in the same way as loop 1 with one difference: loop 2 always compares the student number received by RESULTS (STDNT) to the last student number transmitted (STUDID). Loop 2 continues execution until these numbers are equal. This ensures that the results for all student records transmitted are received.

If a permanent error occurs during a transmit or receive operation, ER and 10 are set on to enter end-of-job processing. Indicator 09 is then set on to exit from the total time loop.

Output - Format Specifications (Figure 9, Part 3)

Lines 01-06: GRADES is transmitted to the remote station.

Lines 07-11: Records received by RESULTS are printed.

Lines 12-13: A permanent error causes an error message to be printed.

IBM International Business Machine Corporation

RPG CALCULATION SPECIFICATIONS

Form GX21-9093-2
Revised in U.S.A.

Program _____ Punching _____ Graphic _____ Card Electro Number _____
 Programmer _____ Date _____ Instruction _____ Punch _____

Page 05 of 1 2 Program Identification TRTR01

| Line | Form Type | Control Level (L, D, L, S, R, AN, CR) | Indicators | | | Factor 1 | Operation | Factor 2 | Result Field | | Resulting Indicators | Comments |
|------|-----------|---------------------------------------|------------|-----|-----|----------|--------------|----------|--------------|--------|----------------------|----------|
| | | | And | And | And | | | | Name | Length | | |
| 01 | C | | | | | LOOP1 | TAG | | | | | |
| 02 | C | | 04 | | | | READ RESULTS | | | | L0 | |
| 03 | C | | 03N10 | | | | EXCPT | | | | | |
| 04 | C | | 44 | | | | SETON | | | | LR10 | |
| 05 | C | | 03N10 | | | | GOTO LOOP1 | | | | | |
| 06 | C | | | | | | SETOF | | | | L0 | |
| 07 | C | LR | | | | LOOP2 | TAG | | | | | |
| 08 | C | LR | 04 | | | | READ RESULTS | | | | L0 | |
| 09 | C | LR | 03N10 | | | | EXCPT | | | | | |
| 10 | C | LR | 44 | | | | SETOF | | | | 09 | |
| 11 | C | LRN44 | | | | STDNT | COMP STDNTD | | | | 0909 | |
| 12 | C | LR | 09 | | | | GOTO LOOP2 | | | | | |
| 13 | C | | | | | | | | | | | |
| 14 | C | | | | | | | | | | | |

IBM International Business Machine Corporation

RPG OUTPUT SPECIFICATIONS

Form GX21-9090-2 U/M 050*
Printed in U.S.A.

Program _____ Punching _____ Graphic _____ Card Electro Number _____
 Programmer _____ Date _____ Instruction _____ Punch _____

Page 06 of 1 2 Program Identification TRTR01

| Line | Form Type | Filename | Type (M, D, T, E) | Space | Skip | Output Indicators | | | Field Name | End Position in Output Record | Constant or Edit Word |
|------|-----------|----------|-------------------|-------|------|-------------------|-----|--------|------------|-------------------------------|-----------------------|
| | | | | | | And | And | And | | | |
| 01 | O | GRADES | D | | | | | | 01N44 | | |
| 02 | O | | | | | | | #QUES | 7 | | |
| 03 | O | | | | | | | ANSARR | 60 | | |
| 04 | O | | D | | | | | STUDID | 5 | | |
| 05 | O | | | | | | | STDARR | 60 | | |
| 07 | O | PRINT | T | | | | | 44 | | | |
| 09 | O | | E | | | | | 03N44 | | | 'ERROR OCCURRED' |
| 11 | O | | | | | | | STDNT | 13 | | 'STUDENT #' |
| 12 | O | | | | | | | | 17 | | |
| 13 | O | | | | | | | | 25 | | 'SCORE =' |
| 14 | O | | | | | | | SCORE | 29 | | |
| 15 | O | | | | | | | | | | |

Figure 9. Transmit Interspersed With Receive Program (No Conversational Reply) (Part 3 of 3)

Appendix A. ASCII and EBCDIC Codes

The coded character sets for ASCII and EBCDIC are shown below. Use the set that your adapter and programming system supports.

The data link control characters recognized by System/3 are listed in Appendix B.

ASCII Codes

| Main Storage Bit Positions 4, 5, 6, 7 | | Main Storage Bit Positions 0, 1, 2, 3 | | | | | | | | | | | | | | | |
|---------------------------------------|---|---------------------------------------|------|------|------|------|------|------|------|------|------|------|------|------|------|------|------|
| | | 0000 | 0001 | 0010 | 0011 | 0100 | 0101 | 0110 | 0111 | 1000 | 1001 | 1010 | 1011 | 1100 | 1101 | 1110 | 1111 |
| HEX | 0 | 1 | 2 | 3 | 4 | 5 | 6 | 7 | 8 | 9 | A | B | C | D | E | F | |
| 0000 | 0 | NUL | DLE | SP | 0 | a | P | \ | p | | | | | | | | |
| 0001 | 1 | SOH | DC1 | ! | 1 | A | Q | a | q | | | | | | | | |
| 0010 | 2 | STX | DC2 | " | 2 | B | R | b | r | | | | | | | | |
| 0011 | 3 | ETX | DC3 | # | 3 | C | S | c | s | | | | | | | | |
| 0100 | 4 | EOT | DC4 | \$ | 4 | D | T | d | t | | | | | | | | |
| 0101 | 5 | ENQ | NAK | % | 5 | E | U | e | u | | | | | | | | |
| 0110 | 6 | ACK | SYN | & | 6 | F | V | f | v | | | | | | | | |
| 0111 | 7 | BEL | ETB | ' | 7 | G | W | g | w | | | | | | | | |
| 1000 | 8 | BS | CAN | (| 8 | H | X | h | x | | | | | | | | |
| 1001 | 9 | HT | EM |) | 9 | I | Y | i | y | | | | | | | | |
| 1010 | A | LF | SUB | * | : | J | Z | j | z | | | | | | | | |
| 1011 | B | VT | ESC | + | ; | K | [| k | } | | | | | | | | |
| 1100 | C | FF | FS | , | < | L | \ | l | | | | | | | | | |
| 1101 | D | CR | GS | - | = | M |] | m | } | | | | | | | | |
| 1110 | E | SO | RS | . | > | N | ^ | n | ~ | | | | | | | | |
| 1111 | F | SI | US | / | ? | O | _ | o | DEL | | | | | | | | |

EBCDIC Codes

| | | Main Storage Bit Positions 0, 1, 2, 3 | | | | | | | | | | | | | | | |
|---------------------------------------|-------|---------------------------------------|------|------------|------|------|------|------|------|------|------|------|------|------|------|------|--|
| Main Storage Bit Positions 4, 5, 6, 7 | 0000 | 0001 | 0010 | 0011 | 0100 | 0101 | 0110 | 0111 | 1000 | 1001 | 1010 | 1011 | 1100 | 1101 | 1110 | 1111 | |
| 0000 | 0 | 1 | 2 | 3 | 4 | 5 | 6 | 7 | 8 | 9 | A | B | C | D | E | F | |
| 0001 | SPACE | DEL | DS | | SP | & | - | | | | | | { | } | | 0 | |
| 0010 | 1 | SCF | DC1 | SCS | | | | | i | j | ~ | | A | J | | 1 | |
| 0011 | 2 | DC2 | DC2 | FI | SYN | | | | l | k | u | | B | K | S | 2 | |
| 0100 | 3 | DC3 | DC3 | | | | | | | l | t | | C | L | F | 3 | |
| 0101 | 4 | PI | PI | BYF | PL | | | | d | m | v | | D | M | U | 4 | |
| 0110 | 5 | HI | HI | LF | RS | | | | e | n | v | | E | N | V | 5 | |
| 0111 | 6 | LC | BE | LCB LTb | UC | | | | f | o | w | | F | O | W | 6 | |
| 1000 | 7 | DEI | L | PRE ESC | LOT | | | | g | p | r | | G | P | X | 7 | |
| 1001 | 8 | | CA11 | | | | | | l | q | v | | H | Q | Y | 8 | |
| 1010 | 9 | RLT | TM | | | | | | z | i | z | | I | R | Z | 9 | |
| 1011 | A | JMM | CC | SM | | * | 1 | 1 | | | | | | | | | |
| 1100 | B | LT | | | | . | 2 | . | " | | | | | | | | |
| 1101 | C | FF | BE | | DX3 | < | . | . | | | | | | | | | |
| 1110 | D | CF | IC | T12 | TAK | . | . | . | . | | | | | | | | |
| 1111 | E | UL | BI | ACF | | . | . | > | | | | | | | | | |
| 0000 | F | LI | BI | BL | SUB | 1 | 1 | 2 | " | | | | | | | | |



Appendix B. Data Link Control Characters

The following characters and character sequences are recognized by System/3 BSCA. For detailed information on Data Link Control Characters, see *General Information Binary Synchronous Communications*, GA27-3004.

| <u>Name</u> | <u>Mnemonic</u> | <u>ASCII</u> | <u>EBCDIC</u> |
|---------------------------------|-----------------|--------------|-----------------|
| Start of Heading | SOH | SOH | SOH |
| Start of Text | STX | STX | STX |
| End of Transmission Block | ETB | ETB | ETB |
| End of Text | ETX | ETX | ETX |
| End of Transmission | EOT | EOT | EOT |
| Enquiry | ENQ | ENQ | ENQ |
| Negative Acknowledge | NAK | NAK | NAK |
| Synchronous Idle | SYN | SYN | SYN |
| Data Link Escape | DLE | DLE | DLE |
| Intermediate Block Character | ITB | US | IUS |
| Even Acknowledge | ACK 0 | DLE 0 | DLE (70) |
| Odd Acknowledge | ACK 1 | DLE 1 | DLE/ |
| Wait Before Transmit Pos. Ack. | WACK | DLE; | DLE, |
| Mandatory Disconnect | DISC | DLE EOT | DLE EOT |
| Reverse Interrupt | RVI | DLE < | DLE@ |
| Temporary Text Delay | TTD | STX ENQ | STX ENQ |
| Transparent Start of Text | XSTX | | DLE STX |
| Transparent Intermediate Block | XITB | | DLE IUS |
| Transparent End of Text | XETX | | DLE ETX |
| Transparent End of Trans. Block | XETB | | DLE ETB |
| Transparent Synchronous Idle | XSYN | | DLE SYN |
| Transparent Block Cancel | XENO | | DLE ENQ |
| Transparent TTD | XTTD | | DLE STX DLE ENQ |
| Data DLE in Transparent Mode | XDLE | | DLE DLE |

Appendix C. Polling and Addressing Characters for System/3

Polling and addressing are used on multipoint, nonswitched networks. Polling is a request to a tributary station to transmit data to the control station (central). Therefore, polling characters identifying your station must be entered on the RPG Telecommunications Specifications Sheet for the BSCA output (transmit) file.

Addressing is a request from central to send data to your station. Therefore, the addressing characters must appear on the RPG Telecommunications Specifications Sheet for the BSCA input (receive) file.

A polling character is composed of two identical alphabetic characters; an addressing character is composed of two identical alphabetic or numeric characters. Polling and addressing characters must be used together in certain pairs. When a polling character is selected, the complementary addressing character must be used; when an addressing character is selected, the complementary polling character must be used.

Valid polling and addressing characters for both EBCDIC and ASCII codes are given below in pairs.

EBCDIC CODE

| Polling Character | Addressing Character |
|-------------------|----------------------|
| BB | SS |
| CC | TT |
| DD | UU |
| EE | VV |
| FF | WW |
| GG | XX |
| HH | YY |
| II | ZZ |
| JJ | 11 |
| KK | 22 |
| LL | 33 |
| MM | 44 |
| NN | 55 |
| OO | 66 |
| PP | 77 |
| QQ | 88 |
| RR | 99 |

ASCII CODE

| Polling Character | Addressing Character |
|-------------------|----------------------|
| AA | aa |
| BB | bb |
| CC | cc |
| DD | dd |
| EE | ee |
| FF | ff |
| GG | gg |
| HH | hh |
| II | ii |
| JJ | jj |
| KK | kk |
| LL | ll |
| MM | mm |
| NN | nn |
| OO | oo |
| PP | pp |
| QQ | qq |
| RR | rr |
| SS | ss |
| TT | tt |
| UU | uu |
| VV | vv |
| WW | ww |
| XX | xx |
| YY | yy |
| ZZ | zz |

Appendix D. RPG II Teleprocessing Specifications Summary

RPG II TELECOMMUNICATIONS SPECIFICATIONS

| <i>Column</i> | <i>Subject</i> | <i>Entry</i> | <i>Explanation</i> |
|---------------|---|-------------------------|---|
| 1-2 | Page | 01-99 | Page number |
| 3-5 | Line | 000-999 | Line number |
| 6 | Form Type | T | Identifies a telecommunication specification |
| 7 | Comments | * | Identifies a comment line |
| 7-14 | File name | Alphameric | Name of BSCA file |
| 15 | Configuration | P or blank, M, S | Point to point, nonswitched network, multipoint network, switched network |
| 16 | Type of station | T, R | Transmit or receive (with or without conversational reply) |
| 17 | Type of control | T, blank | Tributary station, non-tributary |
| 18 | Type of code | A, U E or blank | ASCH, (formerly referred to as USACH), EBCDIC |
| 19 | Transparency | Y, N or blank | Transparency feature used or not used |
| 20 | Switched | M, E, S, A, B, blank | Switched or not, manual or auto answer/call, location of dial number if autocall |
| 21-31 | Dial number | Numeric, alphameric | Dial number or location of dial number |
| 32 | Location of identification this station | S, E, blank | Location of ID if ID used |
| 33-39 | Identification this station | Alphameric | ID or location of ID if ID used |
| 40 | Location of identification remote station | S, E, blank | Location of ID if ID used |
| 41-47 | Identification remote station | Alphameric | ID or location of ID if ID used |

RPG II TELECOMMUNICATIONS SPECIFICATIONS (Continued)

| <i>Column</i> | <i>Subject</i> | <i>Entry</i> | <i>Explanation</i> |
|---------------|----------------------------|--|---|
| 48-51 | Remote terminal | Blank, 2770, 2771, 2772, 2773, 2774, 2780 | Columns 48-51 are used only if the Model 10 Disk System, Model 12, Model 15, or Model 6 is to communicate with an IBM 2770 or IBM 2780 (see Appendix E). Otherwise, columns 48-51 are never used with System/3 and must be blank. |
| 52 | ITB | I, blank | Intermediate block check used or not |
| 53-54 | Permanent error indicator | 01-99, L1-L9, LR, H1-H9 | Signal of a permanent error |
| 55-57 | Wait time | Numeric, blank | Wait time specified or assumed |
| 58-59 | Record available indicator | 01-99, L1-L9, LR, H1-H9 | Indicates that the receiving station is ready to transmit |
| 60 | Last file | L | Identifies BSCA input file to be processed last |
| 61-62 | Polling characters | Alphameric | Polling identification |
| 63-64 | Addressing characters | Alphameric | Addressing identification |
| 65-70 | Remote device | Blank, 1442-1, 1442-2, 1443, 0545-3, 0545-4, 2213-1, 2213-2, 2502-1, 2502-2, 5496-1, 5496-2 | Columns 65-70 are used only if the Model 10 Disk System, Model 12, Model 15, or Model 6 is to communicate with an IBM 2770 or IBM 2780 (see Appendix E). Otherwise, columns 65-70 are never used with System/3 and must be blank. |
| 71-74 | (Reserved) | | Not used |
| 75-80 | Program identification | Alphameric | Name of program |

FILE DESCRIPTION SPECIFICATIONS FOR BSCA FILES

| <i>Column</i> | <i>Subject</i> | <i>Entry</i> | <i>Explanation</i> |
|---------------|------------------|--------------|--|
| 7-14 | File name | Alphameric | Name of BSCA file |
| 15 | File type | I, O, C | Input (receive), output (transmit), combined (conversational); C is invalid with an IBM 2770 or IBM 2780 |
| 16 | File designation | D | Demand file for transmit interspersed with receive or for any other use of READ with a BSCA file |
| 17 | End of file | E, blank | End-of-file used to determine end-of-job time |
| 19 | File format | F | Fixed length |
| 20-23 | Block length | Numeric | Block length of BSCA file (same as record length for conversational reply); see Appendix E for entry with IBM 2770 or IBM 2780 |
| 24-27 | Record length | Numeric | Length of BSCA records; see Appendix E for entry with IBM 2770 or IBM 2780 |
| 32 | Additional area | 1-9, blank | Dual or single I/O area; dual for non-conversational BSCA files only |
| 40-46 | Device | BSCA | Device for all BSCA files |

RPG II telecommunications programming supports the IBM 2770 Data Communication System and the IBM 2780 Data Transmission Terminal as remote terminals for the System/3 Model 10 Disk System, Model 12, Model 15, and Model 6. This appendix contains a description of the RPG II specifications required to use the IBM 2770 and the IBM 2780, a discussion of specific System/3 considerations which apply when using these devices, and one sample RPG II program for each device.

Note: Before attempting to write your own RPG II programs for using the IBM 2770 or the IBM 2780, you should read *IBM Systems Reference Library—System Components; IBM 2770 Data Communication System*, GA27-3013; *IBM Systems Reference Library—IBM 2770 System Summary*, GA27-3014; and/or *IBM Systems Reference Library—IBM 2780 Data Transmission Terminal—Component Description*, GA27-3005.

RPG II SPECIFICATIONS

Use of the IBM 2770 Data Communication System and the IBM 2780 Data Transmission Terminal affects RPG file description specifications, RPG line counter specifications, RPG telecommunications specifications, and RPG output-format specifications. Only the entries unique to the IBM 2770 or IBM 2780 are described here.

RPG File Description Specifications

For each IBM 2770 or IBM 2780 device specified on the RPG Telecommunications Specifications sheet (see *RPG Telecommunications Specifications*), a unique file must be defined on the RPG File Description Specifications sheet.

Columns 20-27 (Block Length and Record Length)

The System/3 block length (columns 20-23) and record length (columns 24-27) determine the remote buffer size. For the IBM 2780, buffer size is always 400; for the IBM 2770, the buffer size is as follows:

| System/3 Block Size | Remote Buffer Size |
|---------------------|--------------------|
| ≤ 128 | 128 |
| > 128 | 256 |

Telecommunications RPG II support then blocks all records to ensure that the remote buffer size is never exceeded.

When transmitting to an IBM 2780, no more than two records are blocked if the ratio of block length (columns 20-23) to record length (columns 24-27) is less than 2. If the ratio is greater than 2, no more than 7 records will be blocked.

The IBM 2770 inserts a record separator (RS) character between blocked records, but does not perform intermediate block checking. If you specify ITB for the IBM 2770 in transparent mode, System/3 issues a diagnostic. Otherwise, the specification is ignored for the IBM 2770. Intermediate block checking is always assumed for the IBM 2780.

For record lengths supported by the remote devices you are using, see the appropriate Systems Reference Library manual.

If a record received by System/3 is shorter than the record length specified in columns 24-27, blanks are added to the right. If a record received by System/3 is longer than the record length specified in columns 24-27, the record is truncated on the right.

Columns 33-34 (Overflow Indicator)

An overflow indicator may be specified for IBM 2770 and IBM 2780 printer files.

Columns 40-46 (Device)

The device specified in columns 40-46 of the RPG File Description Specification sheet is always BSCA for each IBM 2770 and IBM 2780 file. The maximum number of files allowed within a program using BSCA files is 12.

Other Entries

All other valid file description specifications are accepted in a BSC program using the IBM 2770 or IBM 2780.

RPG Line Counter Specifications

A line counter specification should be given for every IBM 2770 and every IBM 2780 printer file. If a line counter specification is not given, the overflow line is set at 60 and the form length is set at 66. A warning is issued at compilation time for each IBM 2770 or IBM 2780 printer file lacking a line counter specification.

RPG Telecommunications Specifications

IBM 2770 files and IBM 2780 files require two additional entries on the RPG Telecommunications Specifications sheet: Remote Terminal and Remote Device.

Columns 48-51 (Remote Terminal)

| Entry | Explanation |
|-------|---|
| 2770 | The remote terminal is an IBM 2770. If System/3 is transmitting, the output channel on the IBM 2770 is, by default, output channel 1. |
| 2771 | The remote terminal is an IBM 2770, output channel 1. |
| 2772 | The remote terminal is an IBM 2770, output channel 2. |
| 2773 | The remote terminal is an IBM 2770, output channel 3. |
| 2774 | The remote terminal is an IBM 2770, output channel 4. (Output channel 4 is an optional channel; if it is not available and is specified, a permanent error occurs.) |
| 2780 | The remote terminal is an IBM 2780. |

Note: You cannot specify both the IBM 2770 and the IBM 2780 in the same program.

Columns 65-70 (Remote Device)

| Entry | Remote Terminal | Remote Device |
|--------|-----------------|---------------------------------------|
| 1442-1 | IBM 2780 | IBM 1442 Card Read/Punch (card read) |
| 1442-2 | IBM 2780 | IBM 1442 Card Read/Punch (card punch) |
| 1443 | IBM 2780 | IBM 1443 Printer |
| 0545-3 | IBM 2770 | IBM 0545 Card Punch, Model 3 |
| 0545-4 | IBM 2770 | IBM 0545 Card Punch, Model 4 |
| 2213-1 | IBM 2770 | IBM 2213 Printer, Model 1 |
| 2213-2 | IBM 2770 | IBM 2213 Printer, Model 2 |
| 2502-1 | IBM 2770 | IBM 2502 Card Reader, Model 1 |
| 2502-2 | IBM 2770 | IBM 2502 Card Reader, Model 2 |
| 5496-1 | IBM 2770 | IBM 5496 Data Recorder (card read) |
| 5496-2 | IBM 2770 | IBM 5496 Data Recorder (card punch) |

Before transmitting data from System/3, the System/3 programmer must determine which output channels and/or devices are necessary to his program, and ensure that they will be available when required. Device selection occurs each time a different file is selected.

Related RPG Telecommunications Specifications

A designation of multipoint (M in column 15) and associated entries (T in column 17, addressing and polling characters in columns 61-64) are invalid Telecommunications Specifications entries in a program using the IBM 2770 or IBM 2780. System/3 can not function as the control station in a multipoint network.

All other Telecommunications Specifications entries are valid in a program using the IBM 2770 or the IBM 2780.

RPG Output-Format Specifications

Space and skip entries are restricted by the IBM 2770 and IBM 2780 as follows:

- An entry of 0 or blank is not supported in column 18 (Space After): default is to space 1 after.
- The skip entry is limited to a maximum of 112 for the IBM 2213 Printer, Model 1 (see your system RPG II reference manual to enter 100-112).
- Tape carriage channel control is not supported (confine punches to channel 1).
- Repeated IP forms positioning cannot be used on the IBM 2770 and IBM 2780.

Related Considerations

- The IBM 1443 Printer spaces once each time it is selected for the IBM 2780.
- An escape character (X'27') must not be the first byte sent to the IBM 2780 printer if you are transmitting in transparent mode.
- Each printer for the IBM 2770 and IBM 2780 resets the internal line count to 1 if the print file is reopened after a punch file has been transmitted to an IBM 2770 or IBM 2780.
- The end-of-file card transmitted by the 5496 Data Recorder from the IBM 2770 is received by System/3 as data.
- System/3 cannot print the end-of-media character transmitted by the IBM 2780. Translate this character to avoid an unprintable-character halt on System/3.

SYSTEM/3 CONSIDERATIONS

The System/3 RPG II programmer must constantly be aware of the limits imposed by the IBM 2770 and the IBM 2780 when they are used as remote terminals. For that reason, a thorough reading of the following manuals is imperative:

- *IBM Systems Reference Library—System Components; IBM 2770 Data Communication System, GA27-3013,*

- *IBM Systems Reference Library—IBM 2770 System Summary, GA27-3014,*

and/or

- *IBM Systems Reference Library—IBM 2780 Data Transmission Terminal—Component Description, GA27-3005*

The System/3 programmer must also consider:

- Transmit with conversational reply and receive with conversational reply are not supported with the IBM 2770 or the IBM 2780.
- Transmit interspersed with receive is not supported with the IBM 2770 or the IBM 2780.
- If System/3 answers an IBM 2770 or an IBM 2780 in a switched network, the first file referenced by System/3 cannot be a transmit file. Use a dummy receive file to accommodate your particular needs if System/3 cannot always be programmed to call.
- Without the auto-turnaround feature, the IBM 2780 usually cannot transmit to System/3 and then, immediately after the data has been transmitted, receive from System/3. The IBM 2780 operator cannot, in most cases, ready devices to receive in the short time required by System/3 to turn the line around from receive to transmit. In the absence of auto-turnaround, program System/3 to transmit and then receive.
- Spacing and skipping in transparent mode usually requires more transmission time if an IBM 2770 or an IBM 2780 is the remote terminal:

IBM 2770 — To space or skip more than one line requires an escape sequence (command to printer) to be transmitted in nontransparent mode (executed by RPG II). This entails line turn around time and extra transmission time.

IBM 2780 — To space or skip more than three lines requires an escape sequence (command to printer) to be transmitted in nontransparent mode (executed by RPG II). This entails line turn around time and extra transmission time.

EXAMPLES

The following two RPG II programs provide examples of the System/3 Model 10 Disk System or Model 12 using the IBM 2770 and the IBM 2780 as remote terminals. The first program transmits data from System/3 to an IBM 2770; the second controls the transmission of data from an IBM 2780 to System/3.

Transmitting to the IBM 2770 Data Communication System

System/3 reads the input file, CARDIN, from MFCUI (Figure 10). This data forms the output file, PUTONLY, that is transmitted, using the BSCA, to an IBM 2770. Transmission is in nontransparent mode.

The IBM 2770 prints PUTONLY on an IBM 2213 Printer, Model 1. PUTONLY is printed with a heading conditioned on the overflow line.

| IBM | | RPG CONTROL CARD AND FILE DESCRIPTION SPECIFICATIONS | | | | | | | | | | | | | | | FORM 9992 (1-64) (9-67) PROGRAM 4125-A | | | | | | | | | |
|---|-----------|--|-------------------------------|----------------------|--------------|----------------------|------------------------|------------------|---------------|---------------------|--|---------------------|--|--------------|------------------|-----------------------|---|--------------|--|------------------|--------------|----------------|------------------|--------------|--------------|--------------|
| Program | | Date | | | | | | | | | | | | | | | Page 01 | | Program Identification TR2770 | | | | | | | |
| Programmer | | Date | | | | | | | | | | | | | | | Page 02 | | Program Identification TR2770 | | | | | | | |
| Control Card Specifications | | | | | | | | | | | | | | | | | | | | | | | | | | |
| Line | Form Type | Core Size to Compile | Object Output List or Options | Core Size to Execute | Debug | MFCX Subjob Sequence | Number of Print Pivots | Address to Start | Mode | Work File | Work File | Work File | Work File | Work File | Work File | Work File | Work File | Work File | Work File | Work File | Work File | Work File | Work File | Work File | Work File | Work File |
| 0:1 | H | | | | | | | | | | | | | | | | | | | | | | | | | |
| File Description Specification | | | | | | | | | | | | | | | | | | | | | | | | | | |
| Line | Form Type | Filename | File Type | File Description | End of File | Sequence | File Format | Block Length | Header Length | Modified Processing | Length of Key Field or Record Address List | Record Address Type | Typical File Organization or Action Code | Device | Synthetic Device | Number of Label Exits | Extent Level for DAM | Core Index | Number of Tracks for Cylinder Counting | Number of Labels | Label Report | Condition Code | Generation Lines | Update | Entry | |
| 0:2 | F | CARDIN | IPE | F | 96 | 96 | | | | | | | | MFCUI | | | | | | | | | | | | |
| 0:3 | F | PUTONLY | O | F | 132 | 132 | | | | | | | OF | LBSCA | | | | | | | | | | | | |
| RPG EXTENSION AND LINE COUNTER SPECIFICATIONS | | | | | | | | | | | | | | | | | | | | | | | | | | |
| IBM | | RPG EXTENSION AND LINE COUNTER SPECIFICATIONS | | | | | | | | | | | | | | | FORM 9992 (1-64) (9-67) PROGRAM 4125-A | | | | | | | | | |
| Program | | Date | | | | | | | | | | | | | | | Page 02 | | Program Identification TR2770 | | | | | | | |
| Programmer | | Date | | | | | | | | | | | | | | | Page 02 | | Program Identification TR2770 | | | | | | | |
| Line Counter Specifications | | | | | | | | | | | | | | | | | | | | | | | | | | |
| Line | Form Type | Filename | Line Counter | Line Counter | Line Counter | Line Counter | Line Counter | Line Counter | Line Counter | Line Counter | Line Counter | Line Counter | Line Counter | Line Counter | Line Counter | Line Counter | Line Counter | Line Counter | Line Counter | Line Counter | Line Counter | Line Counter | Line Counter | Line Counter | Line Counter | Line Counter |
| 1:1 | L | PUTONLY | 066FL | 066OL | | | | | | | | | | | | | | | | | | | | | | |
| 1:2 | L | | | | | | | | | | | | | | | | | | | | | | | | | |

Figure 10. Transmitting to the IBM 2770 Data Communication System (Part 1 of 2)

RPG TELECOMMUNICATIONS SPECIFICATIONS

Form GX21 9116-1
Printed in U.S.A.

IBM International Business Machines Corporation

Program: _____ Date: _____ Punched Instruction: _____ Card Electro Number: _____
 Programmer: _____ Punch: _____ Page 03 of Program Identification TR2770

| Line | Field Name | Type | Length | Position | Station | | Remote Device | Wait Time | Reserved | |
|------|------------|------|--------|----------|---------------|----------------|---------------|-----------|----------|--------|
| | | | | | Local Station | Remote Station | | | | |
| 01 | PUT ONLY | PT | EN | | | | 2770 | 56 | 90 | 2213-1 |

RPG INPUT SPECIFICATIONS

Form GX21 9054-2-1-104847
Printed in U.S.A.

IBM International Business Machines Corporation

Program: _____ Date: _____ Punched Instruction: _____ Card Electro Number: _____
 Programmer: _____ Punch: _____ Page 04 of Program Identification TR2770

| Line | Field Name | Record Identification Codes | | | | Field Location | | Field Name | Field Indicators | | |
|------|------------|-----------------------------|----|---|----|----------------|----|------------|------------------|------|---------------|
| | | 1 | 2 | 3 | 4 | From | To | | FLN | Mask | Zero or Blank |
| 01 | CARDIN | NS | 01 | 1 | CD | | | DATA | | | |

RPG OUTPUT SPECIFICATIONS

Form GX21 9050-2-1048 090-1
Printed in U.S.A.

IBM International Business Machines Corporation

Program: _____ Date: _____ Punched Instruction: _____ Card Electro Number: _____
 Programmer: _____ Punch: _____ Page 05 of Program Identification TR2770

| Line | Field Name | Type | Length | Position | Output of Columns | Number of Lines | Field Name | Field Location | Field Name | Field Location | Field Name | Field Location |
|------|------------|------|--------|----------|-------------------|-----------------|------------|----------------|------------|----------------|------------|----------------|
| | | | | | | | | | | | | |
| 02 | OR | | | | | | | | | | | |
| 03 | D | L | | | 01N56 | | | | | | | |
| 04 | | | | | | | | | | | | |
| 05 | | | | | | | | | | | | |
| 06 | | | | | | | | | | | | |
| 07 | | | | | | | | | | | | |
| 08 | | | | | | | | | | | | |
| 09 | | | | | | | | | | | | |
| 10 | | | | | | | | | | | | |
| 11 | | | | | | | | | | | | |
| 12 | | | | | | | | | | | | |
| 13 | | | | | | | | | | | | |
| 14 | | | | | | | | | | | | |
| 15 | | | | | | | | | | | | |
| 16 | | | | | | | | | | | | |
| 17 | | | | | | | | | | | | |
| 18 | | | | | | | | | | | | |
| 19 | | | | | | | | | | | | |
| 20 | | | | | | | | | | | | |
| 21 | | | | | | | | | | | | |
| 22 | | | | | | | | | | | | |
| 23 | | | | | | | | | | | | |
| 24 | | | | | | | | | | | | |
| 25 | | | | | | | | | | | | |
| 26 | | | | | | | | | | | | |
| 27 | | | | | | | | | | | | |
| 28 | | | | | | | | | | | | |
| 29 | | | | | | | | | | | | |
| 30 | | | | | | | | | | | | |
| 31 | | | | | | | | | | | | |
| 32 | | | | | | | | | | | | |
| 33 | | | | | | | | | | | | |
| 34 | | | | | | | | | | | | |
| 35 | | | | | | | | | | | | |
| 36 | | | | | | | | | | | | |
| 37 | | | | | | | | | | | | |
| 38 | | | | | | | | | | | | |
| 39 | | | | | | | | | | | | |
| 40 | | | | | | | | | | | | |
| 41 | | | | | | | | | | | | |
| 42 | | | | | | | | | | | | |
| 43 | | | | | | | | | | | | |
| 44 | | | | | | | | | | | | |
| 45 | | | | | | | | | | | | |
| 46 | | | | | | | | | | | | |
| 47 | | | | | | | | | | | | |
| 48 | | | | | | | | | | | | |
| 49 | | | | | | | | | | | | |
| 50 | | | | | | | | | | | | |
| 51 | | | | | | | | | | | | |
| 52 | | | | | | | | | | | | |
| 53 | | | | | | | | | | | | |
| 54 | | | | | | | | | | | | |
| 55 | | | | | | | | | | | | |
| 56 | | | | | | | | | | | | |
| 57 | | | | | | | | | | | | |
| 58 | | | | | | | | | | | | |
| 59 | | | | | | | | | | | | |
| 60 | | | | | | | | | | | | |
| 61 | | | | | | | | | | | | |
| 62 | | | | | | | | | | | | |
| 63 | | | | | | | | | | | | |
| 64 | | | | | | | | | | | | |
| 65 | | | | | | | | | | | | |
| 66 | | | | | | | | | | | | |
| 67 | | | | | | | | | | | | |
| 68 | | | | | | | | | | | | |
| 69 | | | | | | | | | | | | |
| 70 | | | | | | | | | | | | |
| 71 | | | | | | | | | | | | |
| 72 | | | | | | | | | | | | |
| 73 | | | | | | | | | | | | |
| 74 | | | | | | | | | | | | |
| 75 | | | | | | | | | | | | |
| 76 | | | | | | | | | | | | |
| 77 | | | | | | | | | | | | |
| 78 | | | | | | | | | | | | |
| 79 | | | | | | | | | | | | |
| 80 | | | | | | | | | | | | |

Figure 10. Transmitting to the IBM 2770 Data Communication System (Part 2 of 2)

Receiving from an IBM 2780 Data Transmission Terminal

An IBM 2780 reads an input file, GETONLY, from an IBM 1442 Card Read Punch (Figure 11). System/3 initiates the operation by dialing the IBM 2780 and requesting to receive using the BSCA. The IBM 2780 then transmits GETONLY to System/3 in nontransparent mode.

Data received by System/3 from the IBM 2780 forms the output file PRINT. System/3 prints this file, spacing once after each record.

| IBM | | | | | | | | | | RPG CONTROL CARD AND FILE DESCRIPTION SPECIFICATIONS | | | | | | | | | | FORM 104 (REV. 11-77) | | | | | | | | | | | | | | | | | | | | | | | | | | | | | | | |
|---|---------|-----------|------------------|-------------------|---------|------------------|------------|----------|-----------------|--|------|------|--------|-----------|------------------|-------------------|--------|------------------|------------|--------------------------------|-----------------|---------|---------|----|-------|--|------|--|--|--|--|----|-------|---|---------|--|---------|--|--|--|--|--|--|--|--|--|--|--|--|--|--|
| Program: _____ | | | | | | | | | | Routing Instruction: _____ | | | | | | | | | | Page: 01 of 01 | | | | | | | | | | | | | | | | | | | | | | | | | | | | | | | |
| Programmer: _____ | | | | | | | | | | Date: _____ | | | | | | | | | | Program Event location: RV2780 | | | | | | | | | | | | | | | | | | | | | | | | | | | | | | | |
| Control Card Specifications | | | | | | | | | | | | | | | | | | | | | | | | | | | | | | | | | | | | | | | | | | | | | | | | | | | |
| <table border="1"> <tr> <th>Line</th> <th>Card</th> <th>Control</th> <th>Card</th> <th>Control</th> <th>Card</th> <th>Control</th> <th>Card</th> <th>Control</th> <th>Card</th> <th>Control</th> <th>Card</th> </tr> <tr> <td>01</td> <td>H</td> <td></td> <td></td> <td></td> <td></td> <td></td> <td></td> <td></td> <td></td> <td></td> <td></td> </tr> </table> | | | | | | | | | | | | Line | Card | Control | Card | Control | Card | Control | Card | Control | Card | Control | Card | 01 | H | | | | | | | | | | | | | | | | | | | | | | | | | | |
| Line | Card | Control | Card | Control | Card | Control | Card | Control | Card | Control | Card | | | | | | | | | | | | | | | | | | | | | | | | | | | | | | | | | | | | | | | | |
| 01 | H | | | | | | | | | | | | | | | | | | | | | | | | | | | | | | | | | | | | | | | | | | | | | | | | | | |
| File Description Specification | | | | | | | | | | | | | | | | | | | | | | | | | | | | | | | | | | | | | | | | | | | | | | | | | | | |
| <table border="1"> <tr> <th>Line</th> <th>Format</th> <th>File Type</th> <th>File Description</th> <th>Mode of Operation</th> <th>Device</th> <th>Synthetic Device</th> <th>Label List</th> <th>Currents</th> <th>File Attributes</th> </tr> <tr> <td>01</td> <td>GETONLY</td> <td>IP</td> <td>80 80</td> <td></td> <td>BSCA</td> <td></td> <td></td> <td></td> <td></td> </tr> <tr> <td>02</td> <td>PRINT</td> <td>O</td> <td>132 132</td> <td></td> <td>PRINTER</td> <td></td> <td></td> <td></td> <td></td> </tr> </table> | | | | | | | | | | | | Line | Format | File Type | File Description | Mode of Operation | Device | Synthetic Device | Label List | Currents | File Attributes | 01 | GETONLY | IP | 80 80 | | BSCA | | | | | 02 | PRINT | O | 132 132 | | PRINTER | | | | | | | | | | | | | | |
| Line | Format | File Type | File Description | Mode of Operation | Device | Synthetic Device | Label List | Currents | File Attributes | | | | | | | | | | | | | | | | | | | | | | | | | | | | | | | | | | | | | | | | | | |
| 01 | GETONLY | IP | 80 80 | | BSCA | | | | | | | | | | | | | | | | | | | | | | | | | | | | | | | | | | | | | | | | | | | | | | |
| 02 | PRINT | O | 132 132 | | PRINTER | | | | | | | | | | | | | | | | | | | | | | | | | | | | | | | | | | | | | | | | | | | | | | |

| IBM | | | | | | | | | | RPG TELECOMMUNICATIONS SPECIFICATIONS | | | | | | | | | | FORM 104 (REV. 11-77) | | | | | | | | | | | | | | | | | |
|---|---------|---------|----------------|----------------|---------------|------------|----------|--|--|---------------------------------------|--|------|--------|---------|----------------|----------------|---------------|-----------|----------|--------------------------------|---------|----|----------|---------|---------|------------|--------|--|--|--|--|--|--|--|--|--|--|
| Program: _____ | | | | | | | | | | Routing Instruction: _____ | | | | | | | | | | Page: 02 of 02 | | | | | | | | | | | | | | | | | |
| Programmer: _____ | | | | | | | | | | Date: _____ | | | | | | | | | | Program Event location: RV2780 | | | | | | | | | | | | | | | | | |
| Telecommunications Specifications | | | | | | | | | | | | | | | | | | | | | | | | | | | | | | | | | | | | | |
| <table border="1"> <tr> <th>Line</th> <th>Format</th> <th>Station</th> <th>Identification</th> <th>Remote Station</th> <th>Remote Device</th> <th>Wait Time</th> <th>Response</th> </tr> <tr> <td>01</td> <td>GETONLY</td> <td>SR</td> <td>E2234567</td> <td>E2780RV</td> <td>E2780TR</td> <td>2780 99 60</td> <td>1442-1</td> </tr> </table> | | | | | | | | | | | | Line | Format | Station | Identification | Remote Station | Remote Device | Wait Time | Response | 01 | GETONLY | SR | E2234567 | E2780RV | E2780TR | 2780 99 60 | 1442-1 | | | | | | | | | | |
| Line | Format | Station | Identification | Remote Station | Remote Device | Wait Time | Response | | | | | | | | | | | | | | | | | | | | | | | | | | | | | | |
| 01 | GETONLY | SR | E2234567 | E2780RV | E2780TR | 2780 99 60 | 1442-1 | | | | | | | | | | | | | | | | | | | | | | | | | | | | | | |

Figure 11. Receiving from an IBM 2780 Data Transmission Terminal (Part 1 of 2)

IBM International Business Machines Corporation

RPG INPUT SPECIFICATIONS

GX21-9090 2/11/80
Printed in U.S.A.

Program: _____ Card Electro Number: _____
 Program: _____ Date: _____ Purchase Instruction: _____ Purchase: _____
 Page **03** of _____ Program Identification: **RV2780**

| Line | Form Type | Filename | Sequence | Record Length | Record Indicator | Record Identification Codes | | | | | | | | | | Field Location | | | Field Indicators | | |
|------|-----------|----------|----------|---------------|------------------|-----------------------------|--------|---------|--------|---------|--------|------|----|------------|----------|------------------------------------|-----------------|-------|------------------|--|--|
| | | | | | | 1 | | 2 | | 3 | | From | To | Field Name | Constant | Machine Fields or Character Fields | Field Indicator | Blank | | | |
| | | | | | | Postion | Length | Postion | Length | Postion | Length | | | | | | | | | | |
| 01 | I | GETONLY | NS | 01 | 01 | 1 | CD | | | | | | | 1 | 32 | DATA | | | | | |
| 02 | I | | | | | | | | | | | | | | | | | | | | |
| 03 | I | | | | | | | | | | | | | | | | | | | | |
| 04 | I | | | | | | | | | | | | | | | | | | | | |
| 05 | I | | | | | | | | | | | | | | | | | | | | |
| 06 | I | | | | | | | | | | | | | | | | | | | | |
| 07 | I | | | | | | | | | | | | | | | | | | | | |
| 08 | I | | | | | | | | | | | | | | | | | | | | |
| 09 | I | | | | | | | | | | | | | | | | | | | | |
| 10 | I | | | | | | | | | | | | | | | | | | | | |
| 11 | I | | | | | | | | | | | | | | | | | | | | |
| 12 | I | | | | | | | | | | | | | | | | | | | | |

IBM International Business Machines Corporation

RPG OUTPUT SPECIFICATIONS

GX21-9090 2/11/80
Printed in U.S.A.

Program: _____ Card Electro Number: _____
 Program: _____ Date: _____ Purchase Instruction: _____ Purchase: _____
 Page **04** of _____ Program Identification: **RV2780**

| Line | Form Type | Filename | Type | Sequence | Space | Skip | Output Indicators | | Field Name | Field Location | Field Indicators |
|------|-----------|----------|------|----------|-------|------|-------------------|------------|------------|----------------|------------------|
| | | | | | | | And | And | | | |
| | | | | | | | End Print | End Record | | | |
| 01 | O | PRINT | D | 01 | | | 01 | 99 | DATA | 32 | |
| 02 | O | | | | | | | | | | |
| 03 | O | | | | | | | | | | |
| 04 | O | | | | | | | | | | |
| 05 | O | | | | | | | | | | |
| 06 | O | | | | | | | | | | |
| 07 | O | | | | | | | | | | |
| 08 | O | | | | | | | | | | |
| 09 | O | | | | | | | | | | |
| 10 | O | | | | | | | | | | |
| 11 | O | | | | | | | | | | |
| 12 | O | | | | | | | | | | |
| 13 | O | | | | | | | | | | |
| 14 | O | | | | | | | | | | |
| 15 | O | | | | | | | | | | |

Figure 11. Receiving from an IBM 2780 Data Transmission Terminal (Part 2 of 2)

Appendix F. Communicating with the Operating System Telecommunications Access Method (TCAM)

System/3 can be part of a telecommunications network that includes the Operating System Telecommunications Access Method (TCAM). (For information regarding TCAM, see *IBM System/360 Operating System Telecommunications Access Method (TCAM) Concepts and Facilities*, GC30-2022, and *IBM System/360 Operating System Telecommunications Access Method (TCAM) Programmer's Guide and Reference Manual*, GC30-2024.)

System/3 communicates with TCAM in the same way it communicates with another System/3 except that it cannot exchange conversational messages with TCAM. The System/3 programmer may only approximate conversational mode by using RPG II.

The RPG II technique for approximating conversational mode consists of:

- Using the READ operation code to receive data and the EXCPT operation code to transmit data.
- Indicating a transmit or a receive operation via TCAM to the System/3 program so that System/3 will perform the appropriate BSCA transmit or receive operation.

Instead of using one combined file for transmitting and receiving data, the RPG II technique requires two files: a demand file for input from the BSCA, and another file for output to the BSCA.

The following two sample programs use the RPG II technique to approximate conversational mode. System/3 is the primary station in the first sample program (System/3 initiates transmission to TCAM); System/3 is the remote station in the second sample program (TCAM initiates transmission to System/3).

SYSTEM/3 TO TCAM

Extension Specifications

System/3 transmits to TCAM (Figure 12) the answers (Y or N) that students have given on a test. TCAM determines which answers are correct and which are not, and then returns the results to System/3.

MFC1TAB contains the tables TABME and TABYOU. TABME is the System/3 station ID; TABYOU is the TCAM station ID.

File Description Specifications

System/3 reads student answers from MFCU1. The answers will be transmitted to TCAM. MFC1TAB is a table file containing station ID's. ANSWER and RESULTS are used to transmit and receive, respectively. RESULTS must be a demand file (D in column 16) because the READ operation code will be used to receive records to the file.

IBM International Business Machines Corporation Form X21-9091-4 Printed in U.S.A.

RPG CONTROL CARD AND FILE DESCRIPTION SPECIFICATIONS

Program: _____ Date: _____ Punching Instruction: _____ Graphic: _____ Card Electro Number: _____
 Programmer: _____ Date: _____ Punch: _____

Page 02 of 2 Program Identification: S3TOTC

File Description Specification

| Line | Form Type | Filename | File Type | | Mode of Processing | | Device | Symbolic Device | Lubr/S/N/E/M | Name of Label Exit | Extent Exit for DAM | | File Addition/Unordered | |
|------|-----------|----------|------------------|-------------|--|---------------------|--------|-----------------|--------------|--------------------|---------------------|--|-------------------------|----|
| | | | File Designation | End of File | Length of Key Field or of Record Address Field | Record Address Type | | | | | Storage Index | Number of Tracks for Cylinder Overflow | Number of Extents | |
| 3 | 4 | 5-13 | 14 | 15 | 16 | 17 | 18 | 19 | 20 | 21 | 22 | 23 | 24 | 25 |
| 0 2 | F | MFCU1 | IP | | 96 | 96 | | MFCU1 | | | | | | |
| 0 3 | F | MFC1TAB | IT | | 4 | 4 | | EMFCU1 | | | | | | |
| 0 4 | F | ANSWERS | O | | 70 | 70 | | BSCA | | | | | | |
| 0 5 | F | RESULTS | ID | | 25 | 25 | 2 | BSCA | | | | | | |
| 0 6 | F | PRINT | O | | 132 | 132 | OF | PRINTER | | | | | | |

IBM International Business Machines Corporation Form X21-9091-4 Printed in U.S.A.

RPG EXTENSION AND LINE COUNTER SPECIFICATIONS

Program: _____ Date: _____ Punching Instruction: _____ Graphic: _____ Card Electro Number: _____
 Programmer: _____ Date: _____ Punch: _____

Page 02 of 2 Program Identification: S3TOTC

Extension Specifications

| Line | Form Type | Record Sequence of the Changing File | | To Filename | Table or Array Name | Number of Entries Per Record | Number of Entries Per Table or Array | Length of Entry | P.B.L.R. Designation Sequence (A-D) | Table or Array Name (Alternating Format) | Length of Entry | P.B.L.R. Designation Sequence (A-D) | Comments |
|------|-----------|--------------------------------------|------------------------------|-------------|---------------------|------------------------------|--------------------------------------|-----------------|-------------------------------------|--|-----------------|-------------------------------------|----------|
| | | From Filename | Number of the Changing Field | | | | | | | | | | |
| 3 | 4 | 5 | 6 | 7 | 8 | 9 | 10 | 11 | 12 | 13 | 14 | 15 | 16 |
| 0 1 | E | MFC1TAB | | | TABME | 1 | 1 | 2 | | TABYOU | 2 | | |
| 0 2 | E | | | | | | | | | | | | |
| 0 3 | E | | | | | | | | | | | | |
| 0 4 | E | | | | | | | | | | | | |
| 0 5 | E | | | | | | | | | | | | |

Figure 12. System/3 to TCAM (Part 1 of 4)

Telecommunications Specifications

Input Specifications

ANSWERS and RESULTS are transmit and receive files, respectively. Both are part of a switched network.

MFCUI provides data from the card reader. RESULTS provides data from TCAM.

| IBM | | RPG TELECOMMUNICATIONS SPECIFICATIONS | | | | | | | | | | | | FORM 10-68 (REV. 10-68) | | | |
|---------|---------|---------------------------------------|------|-----------------------|--------|---------|---------------|------------------------|--------------|----------------|-----------------|------|------|-------------------------|--|------|--|
| Program | | Page | | Card Electro Number | | Page | | Program Identification | | Page | | Page | | Page | | Page | |
| | | 03 | | | | 03 | | S3T0TC | | | | | | | | | |
| Line | File | Code | Mode | Record Identification | | | Record Length | Field Name | Field Length | Field Position | Field Indicator | Page | | | | | |
| | | | | File | Code | Mode | | | | | | Page | Page | | | | |
| | ANSWERS | ST | M | | STABME | STABYOU | | | 60 | | | | | | | | |
| | RESULTS | SR | M | | STABME | STABYOU | | | 60 | | | | | | | | |

| IBM | | RPG INPUT SPECIFICATIONS | | | | | | | | | | | | FORM 10-68 (REV. 10-68) | | | |
|---------|---------|--------------------------|------|-----------------------------|------|------|----------------|------------------------|------------|--------------|-----------------|------|------|-------------------------|--|------|--|
| Program | | Page | | Card Electro Number | | Page | | Program Identification | | Page | | Page | | Page | | Page | |
| | | 04 | | | | 04 | | S3T0TC | | | | | | | | | |
| Line | File | Code | Mode | Record Identification Codes | | | Field Location | | Field Name | Field Length | Field Indicator | Page | | | | | |
| | | | | File | Code | Mode | From | To | | | | Page | Page | | | | |
| I | MFCUI | AA | 01 | 1 | CX | | 4 | 20 | NAME | | | | | | | | |
| I | | | | | | | 27 | 280 | NUMQES | | | | | | | | |
| I | | | | | | | 30 | 79 | ANS | | | | | | | | |
| I | RESULTS | BB | 02 | 1 | CA | | 2 | 18 | NAME | | | | | | | | |
| I | | | | | | | 19 | 20 | NUM | | | | | | | | |
| I | | | | | | | 21 | 25 | RESULT | | | | | | | | |

Figure 12. System/3 to TCAM (Part 2 of 4)

Calculation Specifications

System/3 records the number of tests transmitted to TCAM for correction. The tests are transmitted by exception output to the BSCA. System/3 receives (using the READ operation code) results from TCAM until System/3 reaches end-of-file on RESULTS. System/3 sets indicators off at end-of-file time to prepare for the next RPG cycle.

Output-Format Specifications

System/3 prints data by exception output as the data is read from the card reader and received from the BSCA. System/3 transmits data to TCAM by exception output as the data is read from the card reader. System/3 signals TCAM (with an 'E') when no more records will be sent.

| IBM | | RPG CALCULATION SPECIFICATIONS | | | | | | | | | | Form C-31 9092 | |
|------------|------|--------------------------------|------|--------|--------------|-----------|------|----------|------------------|-------------|-----------|------------------------|----------|
| Programmer | | Date | | By | | Checked | | Date | | Page | | Program Identification | |
| C | | Indicators | | Factor | | Operative | | Factor 2 | | Result File | | Result Indicators | |
| Line | Code | Appl | Ind | Factor | Operative | Factor 2 | Name | Length | Decimal Position | High Order | Low Order | Final | Comments |
| 0.1 | C | ØL | SENT | | ADD L | | SENT | 3Ø | | | | | |
| 0.2 | C | ØL | | | EXCPT | | | | | | | | |
| 0.3 | C | | LOOP | | TAG | | | | | | | | |
| 0.4 | C | ØL | | | READ RESULTS | | | | | | 72 | | |
| 0.5 | C | Ø2N72 | | | EXCPT | | | | | | | | |
| 0.6 | C | Ø2N72 | | | GOTO LOOP | | | | | | | | |
| 0.7 | C | 72 | | | SET OF | | | | | | Ø272 | | |

Figure 12. System/3 to TCAM (Part 3 of 4)

IBM

RPG OUTPUT SPECIFICATIONS

Model 1000 IBM Corp. Printed in U.S.A.

| | | | | | | | |
|----------|--------------------|---------|------|-------------------|----|------------------------|--------|
| Program | Planning Institute | Graphic | Page | Card Entry Number | 06 | Program Identification | S3T0TC |
| Preparer | Date | | | | | | |

| Line | File name | Output Indicators | Field Name | End Position | Output Format |
|------|-----------|-------------------|------------|--------------|---------------|
| 01 | PRINT | IP | | | |
| 02 | OR | OF | | | |
| 03 | | | | | |
| 04 | | | | | |
| 05 | T | LR | | | |
| 06 | | | | | |
| 07 | | | | | |
| 08 | EF | SENT | X | | |
| 09 | | | | | |
| 10 | | | | | |
| 11 | | | | | |
| 12 | | | | | |
| 13 | | | | | |
| 14 | | | | | |
| 15 | | | | | |

20 'ANSWERS TRANSMITTED'
 41 'AND RESULTS RECEIVED'
 30 'TOTAL RECORDS SENT:'
 35
 1 'X'
 20
 28
 79
 120 'TRANSMITTED'

IBM

RPG OUTPUT SPECIFICATIONS

Model 1000 IBM Corp. Printed in U.S.A.

| | | | | | | | |
|----------|--------------------|---------|------|-------------------|----|------------------------|--------|
| Program | Planning Institute | Graphic | Page | Card Entry Number | 07 | Program Identification | S3T0TC |
| Preparer | Date | | | | | | |

| Line | File name | Output Indicators | Field Name | End Position | Output Format |
|------|-----------|-------------------|------------|--------------|---------------|
| 01 | | | | | |
| 02 | | | | | |
| 03 | | | | | |
| 04 | | | | | |
| 05 | | | | | |
| 06 | | | | | |
| 07 | | | | | |
| 08 | ANSWERS | LR | RESULT | | |
| 09 | T | | | | |
| 10 | | | | | |
| 11 | E | | | | |
| 12 | | | | | |
| 13 | | | | | |
| 14 | | | | | |
| 15 | | | | | |

9 '*STUDENT*'
 39
 50 '*QUESTION*'
 53
 62 '*RESULT*'
 68
 1 'E'
 1 'X'
 18
 20
 70

Figure 12. System/3 to TCAM (Part 4 of 4)

TCAM TO SYSTEM/3

System/3 receives from TCAM (Figure 13) the answers (Y or N) that students have given on a test. System/3 determines which answers are correct and which are not, and then returns the results to TCAM.

File Description Specifications

MFCDUMMY is a dummy file and serves only to begin the RPG II cycle. MFCU1 is a table file, containing station ID's and a table of the correct answers for the tests being processed. ANSWERS and RESULTS are BSCA files used to receive and transmit, respectively. ANSWERS must be a demand file (D in column 16) because the READ operation code will be used to receive records to the file.

Extension Specifications

The first record from MFCU1 contains station ID's. The second record from MFCU1 is a table, MAST, containing the correct answers for the tests to be processed. Two arrays, ANS and RES, will be built during execution of the program. ANS will contain answers received; RES will contain the results of a comparison of the answers received to the correct answers in MAST.

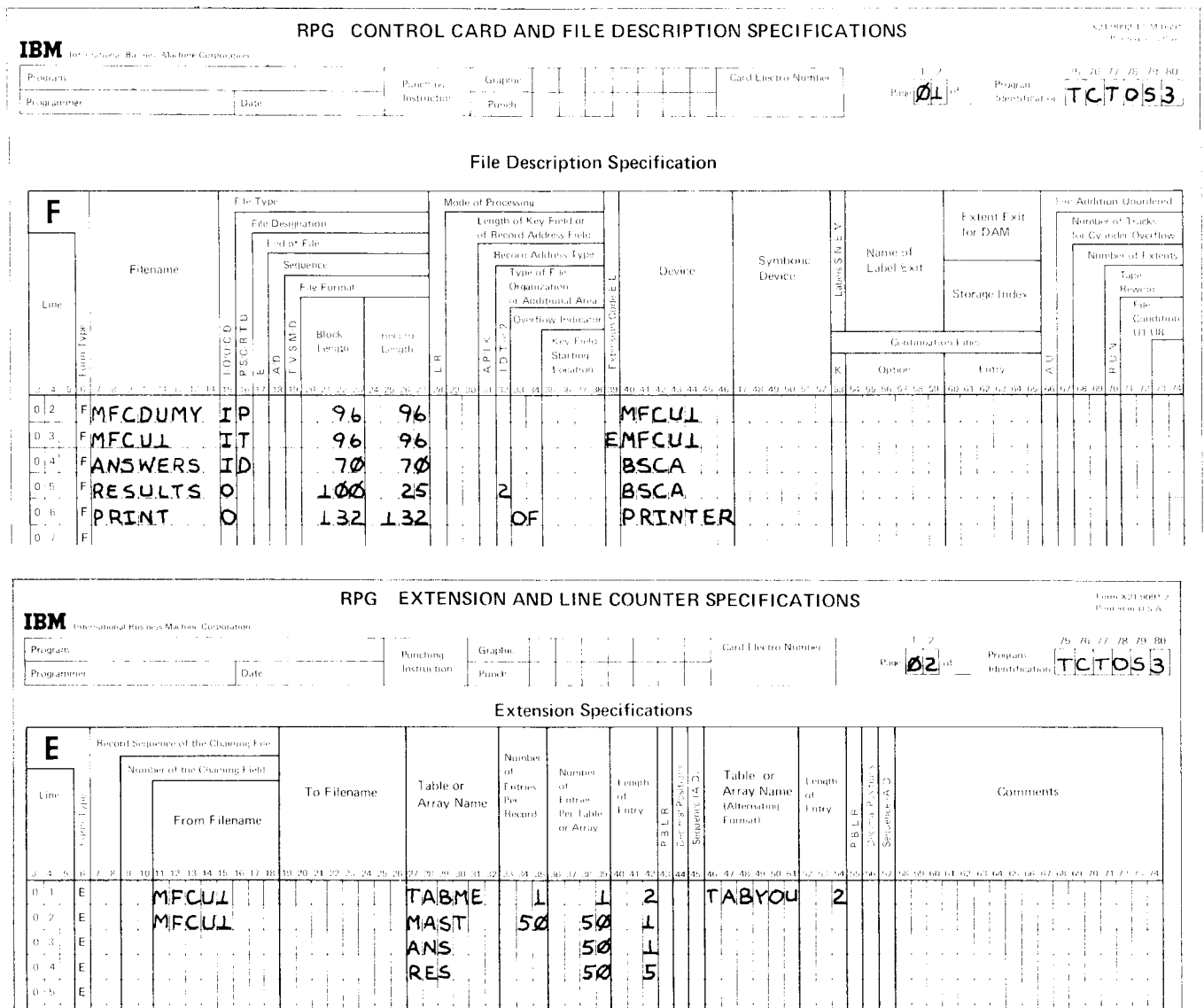

Figure 13. TCAM to System/3 (Part 1 of 5)

Telecommunications Specifications

Input Specifications

ANSWERS and RESULTS are receive and transmit files, respectively. Both are part of a switched network.

ANSWERS receives data from TCAM. The character 'E' will identify the last record to be received (columns 26-27). MFCDUMY contains no data but merely begins the RPG II cycle and sets on indicator 39.

RPG TELECOMMUNICATIONS SPECIFICATIONS

GX21-9016-2 1M 0501
Printed in U.S.A.

Program: _____ Date: _____ Punching Instruction: _____ Graphic Punch: _____ Card Electro Number: _____

Page **03** of **02** Program Identification: **TCTOS3**

| Line | Form Type | Filename | P.S.M. Configuration | T.R. Type of Station | T.6 Type of Control | U.F. Type of Code | Y.N. Transparency | M.E.S.A.B. | Switched | | Identification | | Remote Terminal | Permanent Error Indicator | Wait Time | Records Available Indicator | Last File | Routing Characters | Addressing Characters | Remote Device | Resequest |
|------|-----------|----------|----------------------|----------------------|---------------------|-------------------|-------------------|------------|-------------|------|----------------|----------------|-----------------|---------------------------|-----------|-----------------------------|-----------|--------------------|-----------------------|---------------|-----------|
| | | | | | | | | | Dial Number | S.E. | This Station | Remote Station | | | | | | | | | |
| 01 | T | ANSWERS | SR | A | | | | | | | STABME | STABYOU | | | 60 | | | | | | |
| 02 | T | RESULTS | ST | A | | | | | | | STABME | STABYOU | | | 60 | | | | | | |
| 03 | T | | | | | | | | | | | | | | | | | | | | |
| 04 | T | | | | | | | | | | | | | | | | | | | | |
| 05 | T | | | | | | | | | | | | | | | | | | | | |

RPG INPUT SPECIFICATIONS

GX21-9016-2 1M 0501
Printed in U.S.A.

Program: _____ Date: _____ Punching Instruction: _____ Graphic Punch: _____ Card Electro Number: _____

Page **04** of **02** Program Identification: **TCTOS3**

| Line | Form Type | Filename | Sequence Number (I.N.) | Record Identifying Indicator | Record Identification Codes | | | | | | | | | Field Location | | Field Name | Control Field (I.I.C.) | Varying Fields on Chaining Fields | Field Reversal Region | Field Indicators | | | | |
|------|-----------|----------|------------------------|------------------------------|-----------------------------|---|---|----------|-----------|----------|-----------|----------|-----------|----------------|----|------------|------------------------|-----------------------------------|-----------------------|------------------|-------|---------------|--|--|
| | | | | | 1 | 2 | 3 | Position | Character | Position | Character | Position | Character | From | To | | | | | Plus | Minus | Zero or Blank | | |
| 01 | I | ANSWERS | AA | 01 | | | | | | | | | | | | | | | | | | | | |
| 02 | I | | | | | | | | | | | | | | 2 | 18 | NAME | | | | | | | |
| 03 | I | | | | | | | | | | | | | | 19 | 20 | NUMGES | | | | | | | |
| 04 | I | | | | | | | | | | | | | | 21 | 70 | ANS | | | | | | | |
| 05 | I | | | | | | | | | | | | | | | | | | | | | | | |
| 06 | I | MFCDUMY | 88 | 12 | | | | | | | | | | | | | | | | | | | | |
| 07 | I | | CC | 39 | | | | | | | | | | | | | | | | | | | | |

Figure 13. TCAM to System/3 (Part 2 of 5)

Calculation Specifications

After reading MFCDUMY, System/3 receives a record to ANSWERS, prints the record received (by exception output), determines which of the answers received are correct (by comparing them to the answers in MAST), and then prints and transmits the results (by exception output). After each record has been processed, System/3 prepares for the next RPG II cycle by setting off indicators.

System/3 continues to receive and process answers until the last record, identified by 'E', has been processed.

Output-Format Specifications

System/3 prints and transmits data by exception output.

| IBM | | RPG CALCULATION SPECIFICATIONS | | Form: GX21 9/1937 Revised: 1/5 A | | | | |
|-----------|----------------------------|--------------------------------|---------------|-------------------------------------|-------------------------------|--------------|----------------------|----------|
| Program | Card Electra Number | Punching Instruction | Graphic Punch | Page 05 of 15 | Program Identification TCTOS3 | | | |
| Form Type | Control Level (D, D, L, S) | Indicators | Factor 1 | Operation | Factor 2 | Result Field | Resulting Indicators | Comments |
| 1-5 | 6-9 | 10-15 | 16-27 | 28-33 | 34-43 | 44-53 | 54-63 | 64-74 |
| 1 | 2 | 3 | 4 | 5 | 6 | 7 | 8 | 9 |
| 01 | C | | READ | TAG | | | | |
| 02 | C | 39 | | READ ANSWERS | | | 38 | |
| 03 | C | 12N38 | | SETON | | | LR11 | |
| 04 | C | 12N38 | | GOTO END | | | | |
| 05 | C | 0LN38 | | GOTO READ | | | | |
| 06 | C | 0L | | EXCPT | | | | |
| 07 | C | 0L | | Z-ADDL | X | 20 | | |
| 08 | C | | LOOPIN | TAG | | | | |
| 09 | C | 0L | NUMGES | COMP X | | | 77 | |
| 10 | C | 77 | | GOTO OUT | | | | |
| 11 | C | 0L | MAST,X | COMP ANS,X | | | 656566 | |
| 12 | C | 0L 66 | | MOVE 'RIGHT' | RES,X | | | |
| 13 | C | 0L 65 | | MOVE 'WRONG' | RES,X | | | |
| 14 | C | 0L | X | ADD 1 | X | | | |
| 15 | C | 0LN77 | | GOTO LOOPIN | | | | |

Figure 13. TCAM to System/3 (Part 3 of 5)

| IBM | | RPG CALCULATION SPECIFICATIONS | | | |
|---------|---|--------------------------------|--------|-------------|--------|
| Program | | Job | | 06 | TC7053 |
| C | | | | | |
| 01 | C | | OUT | TAG | |
| 02 | C | 77 | | IZ-ADDL | X |
| 03 | C | | LOOPOU | TAG | |
| 04 | C | 77 | NUMQES | COMP X | 70 |
| 05 | C | 76 | | GOTO END | |
| 06 | C | 77N76 | | EXCPT | |
| 07 | C | 77N76 | X | ADD L | X |
| 08 | C | 77N76 | | GOTO LOOPOU | |
| 09 | C | | END | TAG | |
| 10 | C | 76 | | EXCPT | |
| 11 | C | 76 | | SETOF | 01 |
| 12 | C | 76 | | SETOF | 777638 |
| 13 | C | | NLL | GOTO READ | |

| IBM | | RPG OUTPUT SPECIFICATIONS | | | |
|---------|---|---------------------------|-------|-------|---------------------------|
| Program | | Job | | 07 | TC7053 |
| O | | | | | |
| 01 | 0 | PRINT | H 306 | IP | |
| 02 | 0 | | OR | OF | |
| 03 | 0 | | | | 2L 'ANSWERS RECEIVED AND' |
| 04 | 0 | | | | 4L 'RESULTS TRANSMITTED' |
| 05 | 0 | | D 21 | LL | |
| 06 | 0 | | T 33 | LR | 65 'LR RECORD RECEIVED' |
| 07 | 0 | | EF L | 0LN77 | 32 'ALL TESTS PROCESSED' |
| 08 | 0 | | | | |
| 09 | 0 | | | | NAME 20 |
| 10 | 0 | | | | NUMQESX 28 |
| 11 | 0 | | | | ANS 79 |
| 12 | 0 | | | | 10 'ANSWERS RECEIVED' |

Figure 13. TCAM to System 3 (Part 4 of 5)

| IBM | | RPG OUTPUT SPECIFICATIONS | |
|------------|-----------|---------------------------|---------------------|
| Program | | Output | Output Line Number |
| Programmer | | | Ø8 TCTOS3 |
| 0 | | | |
| 0 | EF 1 | 77N76 | |
| 0 | | | NAME 20 |
| 0 | | | X 37 |
| 0 | | | RES, X 46 |
| 0 | EF 2 | 76 | |
| 0 | | | NAME 20 |
| 0 | | | 51 'TEST PROCESSED' |
| 0 | RESULTS E | 77N76 | |
| 0 | | | NAME 18 |
| 0 | | | X 20 |
| 0 | | | RES, X 25 |

Figure 13. TCAM to System/3 (Part 5 of 5)

TCAM CONSIDERATIONS

Two restrictions not apparent in the preceding examples must be considered when you communicate with TCAM:

1. To avoid "unidentified record" halts, your RPG II program must recognize and ignore any blank records transmitted by TCAM. (TCAM may transmit to you blank records received from its other terminals.)
2. To maintain a switched line connection, you must begin transmitting to TCAM within nine seconds after receiving end-of-file from TCAM. Otherwise, you must dial to re-establish the line connection.

Appendix G. Using the IBM 3741 and IBM 5230

RPG II telecommunications programming supports the IBM 3741 Model 2 Data Station, the IBM 3741 Model 4 Programmable Work Station, and the 5230 Model 2 Data Collection Controller in communicate mode as a remote device via the BSCA on the IBM System/3 Model 6, Model 8, Model 10 Disk System, Model 12, and Model 15. The 3741 and 5230 are also supported when locally attached to the System/3 Model 6, Model 10 Disk System, and Model 15 via the Local Communications Adapter. In addition, remote and local attachment is supported via the Integrated Communications Adapter on the IBM System/3 Model 8 and Model 12.

This appendix contains a description of the RPG II specifications required to use the 3741 and 5230 (identical to specifications used to receive from a 3741 without expanded communications) and three sample RPG II programs.

It is recommended that only one data set be transmitted from the 3741 during the execution of an RPG II program. If more than one data set is transmitted, erroneous records may be passed to the RPG II program. Data sets with different record lengths are not permitted, since only one BSCA input file can be defined.

For more detailed explanation of transmitting data sets on 3741, refer to the *IBM System/3 3741 Models 3 and 4 Programmable Work Station Programming Reference Manual*, GA21-9194, or *IBM 3741 Data Station Reference Manual*, GA21-9183.

A 3741 with an Expanded Communications Feature (Feature 1680) has a maximum buffer size of 512 bytes.

The Operator Identification Card Reader Feature (Feature 5450) and the Expanded Communications/Multipoint Data Link Control Feature (Feature 1685) on the 3741 are not supported by System/3 RPG II.

Note: If an RPG II program is communicating with a 3741 and an error occurs on the 3741, the System/3 could loop on I/O attention. To prevent this, the RPG II program must use the permanent error indicator to force the application program to end of job or other non-BSCA operations. The user program should print a message if this occurs.

RPG II SPECIFICATIONS

Use of the IBM 3741 affects RPG II file description specifications, RPG II telecommunications specifications, and RPG II output format specifications. Only the entries unique to the 3741 are described here.

RPG II File Description Specifications

Only two BSCA files are allowed (one input and/or one output) per RPG II program. If two BSCA files are used, the input file must be processed completely before processing the output file.

Column 15 (File Type)

| Entry | Explanation |
|-------|------------------------------------|
| I | This is an input (receive) file. |
| O | This is an output (transmit) file. |

Columns 20-23 (Block Length)

When using an RPG II program to communicate with a 3741 without the expanded communication feature, the maximum block length is 128 bytes.

When using an RPG II program to transmit to a 3741 with the expanded communications feature, the maximum block length is 512 data bytes plus a number of IRS (interrecord separator) characters equal to the blocking factor. The IRS characters are stripped by 3741 hardware so the block will fit into a 512-byte buffer. When using an RPG II program to receive data from a 3741 with the expanded communication feature, the maximum block size is 512 bytes. This block contains the data records as well as the record separator characters placed in the 3741 buffer before transmission. The RPG II program may remove or ignore the IRS character. See Expanded Communications Feature in the *IBM 3741 Data Station Reference Manual*, GA21-9183.

Note: When the 3741 is in ECB transmit mode (J) it will block records, including the IRS characters, to get the maximum number of records into a 512-byte buffer. An X'1E' must be used as the IRS character when transmitting to the 3741 (see Figures 16 and 18).

Columns 24-27 (Record Length)

Maximum record length is 128 data bytes (129 bytes, which includes the IRS character, if expanded communications feature is used).

Columns 40-46 (Device)

BSCA is specified when 3741 attachment is via either the Binary Synchronous Communications Adapter or the Local Communications Adapter.

RPG II Telecommunications Specifications

The 3741 files require some restrictions to the telecommunication specifications. Only the columns affected are listed here.

| <i>Column</i> | <i>Entry Not Allowed</i> | <i>Description</i> |
|---------------|--------------------------|---|
| 15 | M | Multipoint network |
| 17 | T | Tributary station on a multipoint network |
| 18 | A, U | ASCII |
| 19 | Y | Transparency (Not allowed when the 3741 is attached via the Local Communications Adapter) |
| 52 | I | ITB |

Columns 61-74 must be blank.

RPG II Output Format Specifications

Columns 17-22 must be blank.

EXAMPLES

Transmitting to the IBM 3741

The following RPG II programs provide examples of the System/3 Model 10 Disk System, System/3 Model 12, and System/3 Model 15 using the 3741. The first program transmits data from the System/3 to a 3741, the second program receives data from a 3741, the third program transmits data to a 3741 with the expanded communications feature using the expanded communications buffer, and the fourth program receives data from a 3741 Model 2 and receives a status message.

System/3 reads the input file CARDIN from MFCU1 (Figure 14). This data forms the output file BSCAOUT that is transmitted, using the BSCA, to a 3741. The 3741 writes the data on a diskette. The printer file is used to indicate normal end of job and any errors.

| IBM International Business Machine Corporation | | RPG CONTROL CARD AND FILE DESCRIPTION SPECIFICATIONS | | | | | | | | | | GX21-9092-3 UM/050* Printed in U.S.A. | | | | | | | | | | | | | | |
|--|-----------|--|-------------------------------|----------------------|---------------------|------------------------|------------------|---------------------------|------------------------------|--------------------|---------------------|---|--------------------|--|-------------|--------------------|-----------------------|--------------------|---------------------|------------|-------------------------|--|-------------------|-------------|----------------------|--|
| Program | | Punching Instruction | | Graphic | | Card Electro Number | | | | | | Page 1 2 of 2 | | Program Identification 75 76 77 78 79 80 | | | | | | | | | | | | |
| Programmer | | Date | | Punch | | | | | | | | BSCAØL | | | | | | | | | | | | | | |
| Control Card Specifications | | | | | | | | | | | | | | | | | | | | | | | | | | |
| Line | Form Type | Core Size to Compile | Object Output Listing Options | Core Size to Execute | Debug | MFCM Stacking Sequence | Inverted Print | Number Of Print Positions | Alternate Collating Sequence | Model 20 | Model 20 | Refer to the specific System Reference Library manual for actual entries. | | | | | | | | | | | | | | |
| 01 | H | | P | | | | | | | | | | | | | | | | | | | | | | | |
| File Description Specification | | | | | | | | | | | | | | | | | | | | | | | | | | |
| Line | Form Type | Filename | File Type | File Designation | End of File | Sequence | File Format | Block Length | Record Length | Mode of Processing | Record Address Type | Type of File Organization or Additional Area | Overflow Indicator | Key Field Starting Locator | Device | Symbolic Device | Labels S/E/M | Name of Label Exit | Extent Exit for DAM | Core Index | File Addition/Unordered | Number of Tracks for Cylinder Overflow | Number of Extents | Tape Rewind | File Condition U1 U8 | |
| 02 | F | CARDIN | IPE | F | | | | 96 | 96 | | | | | | MFCU1 | | | | | | | | | | | |
| 03 | F | BSCAOUT | O | F | | | | 96 | 96 | 2 | | | | | BSCA | | | | | | | | | | | |
| 04 | F | PRINTER | O | F | | | | 96 | 96 | | | | | | PRINTER | | | | | | | | | | | |
| 05 | F | | | | | | | | | | | | | | | | | | | | | | | | | |
| 06 | F | | | | | | | | | | | | | | | | | | | | | | | | | |
| 07 | C | | | | | | | | | | | | | | | | | | | | | | | | | |
| RPG TELECOMMUNICATIONS SPECIFICATIONS | | | | | | | | | | | | | | | | | | | | | | | | | | |
| IBM International Business Machine Corporation | | RPG TELECOMMUNICATIONS SPECIFICATIONS | | | | | | | | | | Form GX21-9116-1 Printed in U.S.A. | | | | | | | | | | | | | | |
| Program | | Punching Instruction | | Graphic | | Card Electro Number | | | | | | Page 1 2 of 2 | | Program Identification 75 76 77 78 79 80 | | | | | | | | | | | | |
| Programmer | | Date | | Punch | | | | | | | | BSCAØL | | | | | | | | | | | | | | |
| Line | Form Type | Filename | P/S/M Configuration | T/A Type of Station | T/B Type of Control | U/E Type of Code | Y/N Transparency | M/E/S/A/B | Switched | Identification | Remote Device | I = ITB Permanent Error Indicator | Wait Time | Record Available Indicator | L LARS File | Rolling Characters | Addressing Characters | Reserved | | | | | | | | |
| 01 | T | BSCAOUT | SIT | ENM | | | | | | | | | 99030 | | | | | | | | | | | | | |
| 02 | T | | | | | | | | | | | | | | | | | | | | | | | | | |

Figure 14. Transmitting to the IBM 3741 (Part 1 of 2)

RPG INPUT SPECIFICATIONS

GX21-9094 2 U/M 0507
Printed in U.S.A.

| | | | | | | |
|------------|------|----------------------|---------|---------------------|---------------------------|--------------------------------------|
| Program | | Punching Instruction | Graphic | Card Electro Number | Page <u>1</u> of <u>2</u> | Program Identification <u>BSCA01</u> |
| Programmer | Date | Punch | | | | |

| Line | Form Type | Filename | Sequence Number (L-N) | Record Identifying Indicator | Record Identification Codes | | | | | | | | | Field Location | | Field Name | Control Level (L1-L9) | Matching Fields or Chaining Fields | Field Record Relation | Field Indicators | | | |
|------|-----------|----------|-----------------------|------------------------------|-----------------------------|---|---|---|---|---|---|---|---|----------------|------|------------|-----------------------|------------------------------------|-----------------------|------------------|------|-------|---------------|
| | | | | | 1 | 2 | 3 | 4 | 5 | 6 | 7 | 8 | 9 | 10 | From | | | | | To | Plus | Minus | Zero or Blank |
| 01 | I | CARDIN | NS | 01 | | | | | | | | | | | | 1 | 96 | | | | | | |
| 02 | I | | | | | | | | | | | | | | | | | | | | | | |
| 03 | I | | | | | | | | | | | | | | | | | | | | | | |
| 04 | T | | | | | | | | | | | | | | | | | | | | | | |

RPG CALCULATION SPECIFICATIONS

Form GX21-9093 2
Printed in U.S.A.

| | | | | | | |
|------------|------|----------------------|---------|---------------------|---------------------------|--------------------------------------|
| Program | | Punching Instruction | Graphic | Card Electro Number | Page <u>1</u> of <u>2</u> | Program Identification <u>BSCA01</u> |
| Programmer | Date | Punch | | | | |

| Line | Form Type | Control Level (L0-L9) | Indicators | | | | Factor 1 | Operation | Factor 2 | Result Field | | Resulting Indicators | Comments |
|------|-----------|-----------------------|------------|-----|-----|-------|----------|-----------|----------|--------------|--------|----------------------|----------|
| | | | And | And | Not | Not | | | | Name | Length | | |
| 01 | C | | 01 | 99 | | RECNT | ADD | 1 | RECNT | 30 | | | |
| 02 | C | | 99 | | | | SETON | | | | LR | | |

RPG OUTPUT SPECIFICATIONS

GX21-9090 2 U/M 0507
Printed in U.S.A.

| | | | | | | |
|------------|------|----------------------|---------|---------------------|---------------------------|--------------------------------------|
| Program | | Punching Instruction | Graphic | Card Electro Number | Page <u>1</u> of <u>2</u> | Program Identification <u>BSCA01</u> |
| Programmer | Date | Punch | | | | |

| Line | Form Type | Filename | Type (H/D/T/E) | Space | Skip | Output Indicators | | | Field Name | End Position in Output Record | Constant or Edit Word |
|------|-----------|----------|----------------|-------|------|-------------------|-----|-----|------------|-------------------------------|-------------------------|
| | | | | | | And | And | Not | | | |
| 01 | O | BSCAOUT | D | | | 01 | 99 | | DATA | 96 | |
| 02 | O | | | | | | | | | | |
| 03 | O | PRINTER | T | | | LR | 99 | | RECNT | 5 | |
| 04 | O | | | | | | | | | | |
| 05 | O | | | | | | | | | | |
| 06 | O | | | | | | | | | | 'RECORDS TRANSMITTED' |
| 07 | O | | | | | | | | | | 'SUCCESSFUL COMPLETION' |
| 08 | O | | | | | | | | | | |
| 09 | O | | | | | | | | | | 'RECORDS TRANSMITTED' |
| 10 | O | | | | | | | | | | 'PERMANENT ERROR' |

Figure 4. Transmitting to the IBM 3741 (Part 2 of 2)

Receiving from an IBM 3741

The IBM 3741 transmits a record using the BSCA to System/3. This data forms the input file BSCAIN. The System/3 writes the data received to the printer file PRINTER (Figure 15).

| IBM | | RPG CONTROL CARD AND FILE DESCRIPTION SPECIFICATIONS | | | | | | | | | | Page 1 of 5 | | | | | | | | | | | | | | | | | | | | | | | | | | | | | | | | | | | | | | | | | | | | | | | |
|---|------|--|-----------|----------------------|-------------|--------------|---------------|----------------------|---------|-------------------|---------------------|------------------------|------------------------|-------------|-------------------|-----------|-----------|------------------|-------------|--------------|---------------|--------------------|--------|-------------------|---------------------|---------------------|------------------------|-------------|-------------------|----------|----------|----|---|--------|-----|---|--|----|----|---|------|--|--|--|--|----|---|---------|---|---|--|----|----|--|---------|--|--|--|--|
| Program | | Date | | Punching Instruction | | Graphic | | Card Electric Number | | Page | | Program Identification | | | | | | | | | | | | | | | | | | | | | | | | | | | | | | | | | | | | | | | | | | | | | | | |
| | | | | | | | | | | | | BSCA02 | | | | | | | | | | | | | | | | | | | | | | | | | | | | | | | | | | | | | | | | | | | | | | | |
| Control Card Specifications | | | | | | | | | | | | | | | | | | | | | | | | | | | | | | | | | | | | | | | | | | | | | | | | | | | | | | | | | | | |
| <table border="1"> <thead> <tr> <th rowspan="2">Line</th> <th rowspan="2">Code</th> <th rowspan="2">File Name</th> <th rowspan="2">File Type</th> <th rowspan="2">File Description</th> <th rowspan="2">End of File</th> <th rowspan="2">Block Length</th> <th rowspan="2">Record Length</th> <th rowspan="2">Mode of Processing</th> <th rowspan="2">Device</th> <th rowspan="2">Secondary Control</th> <th rowspan="2">Name of Output File</th> <th rowspan="2">Alert Exit from IBM</th> <th rowspan="2">Additional Information</th> </tr> <tr> <th>File Format</th> <th>Overflow Handling</th> <th>Language</th> <th>Language</th> </tr> </thead> <tbody> <tr> <td>01</td> <td>H</td> <td></td> <td></td> <td></td> <td></td> <td></td> <td></td> <td></td> <td></td> <td></td> <td></td> <td></td> <td></td> </tr> <tr> <td>02</td> <td>P</td> <td></td> <td></td> <td></td> <td></td> <td></td> <td></td> <td></td> <td></td> <td></td> <td></td> <td></td> <td></td> </tr> </tbody> </table> | | | | | | | | | | | | | | Line | Code | File Name | File Type | File Description | End of File | Block Length | Record Length | Mode of Processing | Device | Secondary Control | Name of Output File | Alert Exit from IBM | Additional Information | File Format | Overflow Handling | Language | Language | 01 | H | | | | | | | | | | | | | 02 | P | | | | | | | | | | | | |
| Line | Code | File Name | File Type | File Description | End of File | Block Length | Record Length | Mode of Processing | Device | Secondary Control | Name of Output File | Alert Exit from IBM | Additional Information | | | | | | | | | | | | | | | | | | | | | | | | | | | | | | | | | | | | | | | | | | | | | | |
| | | | | | | | | | | | | | | File Format | Overflow Handling | Language | Language | | | | | | | | | | | | | | | | | | | | | | | | | | | | | | | | | | | | | | | | | | |
| 01 | H | | | | | | | | | | | | | | | | | | | | | | | | | | | | | | | | | | | | | | | | | | | | | | | | | | | | | | | | | | |
| 02 | P | | | | | | | | | | | | | | | | | | | | | | | | | | | | | | | | | | | | | | | | | | | | | | | | | | | | | | | | | | |
| File Description Specification | | | | | | | | | | | | | | | | | | | | | | | | | | | | | | | | | | | | | | | | | | | | | | | | | | | | | | | | | | | |
| <table border="1"> <thead> <tr> <th rowspan="2">Line</th> <th rowspan="2">Code</th> <th rowspan="2">File Name</th> <th rowspan="2">File Type</th> <th rowspan="2">File Description</th> <th rowspan="2">End of File</th> <th rowspan="2">Block Length</th> <th rowspan="2">Record Length</th> <th rowspan="2">Mode of Processing</th> <th rowspan="2">Device</th> <th rowspan="2">Secondary Control</th> <th rowspan="2">Name of Output File</th> <th rowspan="2">Alert Exit from IBM</th> <th rowspan="2">Additional Information</th> </tr> <tr> <th>File Format</th> <th>Overflow Handling</th> <th>Language</th> <th>Language</th> </tr> </thead> <tbody> <tr> <td>01</td> <td>F</td> <td>BSCAIN</td> <td>IPE</td> <td>F</td> <td></td> <td>96</td> <td>96</td> <td>2</td> <td>BSCA</td> <td></td> <td></td> <td></td> <td></td> </tr> <tr> <td>02</td> <td>F</td> <td>PRINTER</td> <td>O</td> <td>F</td> <td></td> <td>96</td> <td>96</td> <td></td> <td>PRINTER</td> <td></td> <td></td> <td></td> <td></td> </tr> </tbody> </table> | | | | | | | | | | | | | | Line | Code | File Name | File Type | File Description | End of File | Block Length | Record Length | Mode of Processing | Device | Secondary Control | Name of Output File | Alert Exit from IBM | Additional Information | File Format | Overflow Handling | Language | Language | 01 | F | BSCAIN | IPE | F | | 96 | 96 | 2 | BSCA | | | | | 02 | F | PRINTER | O | F | | 96 | 96 | | PRINTER | | | | |
| Line | Code | File Name | File Type | File Description | End of File | Block Length | Record Length | Mode of Processing | Device | Secondary Control | Name of Output File | Alert Exit from IBM | Additional Information | | | | | | | | | | | | | | | | | | | | | | | | | | | | | | | | | | | | | | | | | | | | | | |
| | | | | | | | | | | | | | | File Format | Overflow Handling | Language | Language | | | | | | | | | | | | | | | | | | | | | | | | | | | | | | | | | | | | | | | | | | |
| 01 | F | BSCAIN | IPE | F | | 96 | 96 | 2 | BSCA | | | | | | | | | | | | | | | | | | | | | | | | | | | | | | | | | | | | | | | | | | | | | | | | | | |
| 02 | F | PRINTER | O | F | | 96 | 96 | | PRINTER | | | | | | | | | | | | | | | | | | | | | | | | | | | | | | | | | | | | | | | | | | | | | | | | | | |

Figure 15. Receiving from an IBM 3741 (Part 1 of 5)

| IBM | | RPG TELECOMMUNICATIONS SPECIFICATIONS | | | | | | | | | | Page 1 of 5 | | | | | | | | | | | | | | | | | | | | | | | | | | | | | | | | | | | | | | | | | | | | | | | | | | | | | | | | | | | | | | | | | | | | | | | | | | | |
|--|------|---------------------------------------|-----------|----------------------|-------------|--------------|---------------|----------------------|--------|-------------------|---------------------|------------------------|------------------------|-------------|-------------------|-----------|-----------|------------------|-------------|--------------|---------------|--------------------|--------|-------------------|---------------------|---------------------|------------------------|-------------|-------------------|----------|----------|----|---|--------|----|-----|--|--|--|--|--|--|--|--|-------|----|---|--|--|--|--|--|--|--|--|--|--|--|--|----|---|--|--|--|--|--|--|--|--|--|--|--|--|----|---|--|--|--|--|--|--|--|--|--|--|--|--|
| Program | | Date | | Punching Instruction | | Graphic | | Card Electric Number | | Page | | Program Identification | | | | | | | | | | | | | | | | | | | | | | | | | | | | | | | | | | | | | | | | | | | | | | | | | | | | | | | | | | | | | | | | | | | | | | | | | | | |
| | | | | | | | | | | | | BSCA02 | | | | | | | | | | | | | | | | | | | | | | | | | | | | | | | | | | | | | | | | | | | | | | | | | | | | | | | | | | | | | | | | | | | | | | | | | | | |
| File Description Specification | | | | | | | | | | | | | | | | | | | | | | | | | | | | | | | | | | | | | | | | | | | | | | | | | | | | | | | | | | | | | | | | | | | | | | | | | | | | | | | | | | | | | | | |
| <table border="1"> <thead> <tr> <th rowspan="2">Line</th> <th rowspan="2">Code</th> <th rowspan="2">File Name</th> <th rowspan="2">File Type</th> <th rowspan="2">File Description</th> <th rowspan="2">End of File</th> <th rowspan="2">Block Length</th> <th rowspan="2">Record Length</th> <th rowspan="2">Mode of Processing</th> <th rowspan="2">Device</th> <th rowspan="2">Secondary Control</th> <th rowspan="2">Name of Output File</th> <th rowspan="2">Alert Exit from IBM</th> <th rowspan="2">Additional Information</th> </tr> <tr> <th>File Format</th> <th>Overflow Handling</th> <th>Language</th> <th>Language</th> </tr> </thead> <tbody> <tr> <td>01</td> <td>T</td> <td>BSCAIN</td> <td>SR</td> <td>ENM</td> <td></td> <td></td> <td></td> <td></td> <td></td> <td></td> <td></td> <td></td> <td>99030</td> </tr> <tr> <td>02</td> <td>T</td> <td></td> <td></td> <td></td> <td></td> <td></td> <td></td> <td></td> <td></td> <td></td> <td></td> <td></td> <td></td> </tr> <tr> <td>03</td> <td>T</td> <td></td> <td></td> <td></td> <td></td> <td></td> <td></td> <td></td> <td></td> <td></td> <td></td> <td></td> <td></td> </tr> <tr> <td>04</td> <td>T</td> <td></td> <td></td> <td></td> <td></td> <td></td> <td></td> <td></td> <td></td> <td></td> <td></td> <td></td> <td></td> </tr> </tbody> </table> | | | | | | | | | | | | | | Line | Code | File Name | File Type | File Description | End of File | Block Length | Record Length | Mode of Processing | Device | Secondary Control | Name of Output File | Alert Exit from IBM | Additional Information | File Format | Overflow Handling | Language | Language | 01 | T | BSCAIN | SR | ENM | | | | | | | | | 99030 | 02 | T | | | | | | | | | | | | | 03 | T | | | | | | | | | | | | | 04 | T | | | | | | | | | | | | |
| Line | Code | File Name | File Type | File Description | End of File | Block Length | Record Length | Mode of Processing | Device | Secondary Control | Name of Output File | Alert Exit from IBM | Additional Information | | | | | | | | | | | | | | | | | | | | | | | | | | | | | | | | | | | | | | | | | | | | | | | | | | | | | | | | | | | | | | | | | | | | | | | | | | |
| | | | | | | | | | | | | | | File Format | Overflow Handling | Language | Language | | | | | | | | | | | | | | | | | | | | | | | | | | | | | | | | | | | | | | | | | | | | | | | | | | | | | | | | | | | | | | | | | | | | | | |
| 01 | T | BSCAIN | SR | ENM | | | | | | | | | 99030 | | | | | | | | | | | | | | | | | | | | | | | | | | | | | | | | | | | | | | | | | | | | | | | | | | | | | | | | | | | | | | | | | | | | | | | | | | |
| 02 | T | | | | | | | | | | | | | | | | | | | | | | | | | | | | | | | | | | | | | | | | | | | | | | | | | | | | | | | | | | | | | | | | | | | | | | | | | | | | | | | | | | | | | | |
| 03 | T | | | | | | | | | | | | | | | | | | | | | | | | | | | | | | | | | | | | | | | | | | | | | | | | | | | | | | | | | | | | | | | | | | | | | | | | | | | | | | | | | | | | | | |
| 04 | T | | | | | | | | | | | | | | | | | | | | | | | | | | | | | | | | | | | | | | | | | | | | | | | | | | | | | | | | | | | | | | | | | | | | | | | | | | | | | | | | | | | | | | |

Figure 15. Receiving from an IBM 3741 (Part 2 of 5)

IBM

RPG INPUT SPECIFICATIONS

Form 500 (Rev. 11-20-59)

Program Name: BSCA02

| Field Location | Field Name | Field Indicators | |
|----------------|------------|------------------|------|
| | | To | From |
| 1-96 | DATA | | |

BSCAIN NS 01

1 96 DATA

Figure 15. Receiving from an IBM 3741 (Part 4 of 5)

IBM

RPG CALCULATION SPECIFICATIONS

Form 500 (Rev. 11-20-59)

Program Name: BSCA02

| Name | Format | Constant or Edit Word | |
|-------|----------------|-----------------------|------|
| | | To | From |
| RECNT | ADD 1 SETON | | |
| RECNT | | 30 | LR |

0LN99
99

RECNT

ADD 1
SETON

RECNT 30

LR

Figure 15. Receiving from an IBM 3741 (Part 4 of 5)

IBM

RPG OUTPUT SPECIFICATIONS

Form 500 (Rev. 11-20-59)

Program Name: BSCA02

| Printer Location | Printer Name | Field Name | Format | Constant or Edit Word | |
|------------------|--------------|------------|--------|-----------------------|-------------------------|
| | | | | To | From |
| 0 | PRINTER | DATA | | 96 | |
| 8 | T 8 | RECNT | Z | 5 | 'RECORDS RECEIVED' |
| 8 | T 8 | RECNT | Z | 55 | 'PERMANENT ERROR' |
| 8 | T 8 | RECNT | Z | 5 | 'RECORDS RECEIVED' |
| 8 | T 8 | RECNT | Z | 55 | 'SUCCESSFUL COMPLETION' |

PRINTER 0

T 8

0LN99
99 LR

DATA 96

RECNT Z 5 'RECORDS RECEIVED'

RECNT Z 55 'PERMANENT ERROR'

RECNT Z 5 'RECORDS RECEIVED'

RECNT Z 55 'SUCCESSFUL COMPLETION'

Figure 15. Receiving from an IBM 3741 (Part 5 of 5)

Transmitting to a 3741 with Expanded Communications Feature

This program (Figure 16) shows the BITON and BITOF coding needed to generate the interrecord separator character to separate records when transmitting data to a 3741 using the expanded communications feature.

System/3 reads the input file DISKA from DISK. The RPG II program will then attach an IRS (interrecord separator) character to each record in this file. This forms the output file T3741 which is then transmitted, using BSCA, to a 3741. The PRINT file is used to indicate any errors and a total card count at end of job.

| RPG CONTROL CARD AND FILE DESCRIPTION SPECIFICATIONS | | | | | | | | | | | | | | | | | | | | | | | | | | | | | | | | | | | | | | | | | | | | | | | | | | | | | | | | | | | | | | | | | | | | | | GX21-9082-3 UM/060* Printed in U.S.A. | | | | | | | | | |
|--|--|--|--|--|--|--|--|--|--|----------------------|--|--|--|--|--|--|--|--|--|---------|--|--|--|--|--|--|--|--|--|---------------------|--|--|--|--|--|--|--|--|--|---|--|--|--|--|--|--|--|--|--|--|--|--|--|--|--|--|--|--|--|--|--|--|--|--|--|--|--|--|--|--|--|--|--|--|--|--|--|--|--|
| Program | | | | | | | | | | Punching Instruction | | | | | | | | | | Graphic | | | | | | | | | | Card Electro Number | | | | | | | | | | Page <u>1</u> of <u>2</u> Program Identification <u>75 76 77 78 79 80</u> | | | | | | | | | | | | | | | | | | | | | | | | | | | | | | | | | | | | | | | |
| Programmer | | | | | | | | | | Date | | | | | | | | | | Punch | | | | | | | | | | | | | | | | | | | | Program Identification <u>BSCA03</u> | | | | | | | | | | | | | | | | | | | | | | | | | | | | | | | | | | | | | | | |

| Control Card Specifications | | | | | | | | | | | | | | | | | | | | | | | | | | | | | | | | | | | | | | | | | | | | | | | | | | | | | | | | | | | | | | | | | | | | | | | | | | | | | | | | | | | | |
|------------------------------|--|--|--|--|--|--|--|--|--|--|--|--|--|--|-------------------------------------|--|--|--|--|--|--|--|--|--|--|--|--|--|--|-------------------------------|--|--|--|--|--|--|--|--|--|-------------|--|--|--|--|---------------------------|--|--|--|--|-------------|--|--|--|--|------------------------------|--|--|--|--|-------------------------|--|--|--|--|--------------|--|--|--|--|---|--|--|--|--|-----------------|--|--|--|--|--|--|--|--|--|
| Line | | | | | | | | | | | | | | | Core Size to Compile | | | | | | | | | | | | | | | Object Output Listing Options | | | | | | | | | | | | | | | Core Size to Execute | | | | | | | | | | | | | | | Model 20 | | | | | | | | | | Model 20 | | | | | | | | | | | | | | |
| Form Type | | | | | | | | | | | | | | | Debug | | | | | | | | | | | | | | | MFCM Stacking Sequence | | | | | | | | | | | | | | | Inverted Print | | | | | | | | | | | | | | | Address to Start | | | | | | | | | | Work Tapes | | | | | | | | | | | | | | |
| H | | | | | | | | | | | | | | | P | | | | | | | | | | | | | | | | | | | | | | | | | | | | | | Number of Print Positions | | | | | | | | | | Alternate Collating Sequence | | | | | | | | | | Overlap Open | | | | | | | | | | Overlap Printer | | | | | | | | | |
| 3 4 5 6 7 8 9 10 11 12 13 14 | | | | | | | | | | | | | | | 15 16 17 18 19 20 21 22 23 24 25 26 | | | | | | | | | | | | | | | 27 28 29 30 | | | | | | | | | | 31 32 33 34 | | | | | | | | | | 35 36 37 38 | | | | | | | | | | 39 40 41 42 43 44 45 46 | | | | | | | | | | 47 48 49 50 51 52 53 54 55 56 57 58 59 60 61 62 63 64 65 66 67 68 69 70 71 72 73 74 | | | | | | | | | | | | | | |
| 0 1 | | | | | | | | | | | | | | | | | | | | | | | | | | | | | | | | | | | | | | | | | | | | | | | | | | | | | | | | | | | | | | | | | | | | | | | | | | | | | | | | | | | | |

| File Description Specification | | | | | | | | | | | | | | | | | | | | | | | | | | | | | | | | | | | | | | | | | | | | | | | | | | | | | | | | | | | | | | | | | | | | | | | | | | | | | | | | | | | | | | | | | | | | | | | | | | | |
|--------------------------------|--|--|--|--|--|--|--|--|--|--|--|--|--|--|--|--|--|--|--|--|--|--|--|--|-----------------------------|--|--|--|--|--|--|--|--|--|--|--|--|--|--|--|--|--|--|--|--|--|--|--|--|--|--|--|--|--|--------------------|--|--|--|--|--|--|--|--|--|--|--|--|--|--|--|--|--|--|--|--|--|--|--|--|--|--|--|--|--|---|--|--|--|--|--|--|--|--|--|--|--|--|--|--|
| Line | | | | | | | | | | File Type | | | | | | | | | | | | | | | File Designation | | | | | | | | | | | | | | | Mode of Processing | | | | | | | | | | | | | | | Device | | | | | | | | | | | | | | | Symbolic Device | | | | | | | | | | | | | | | File Addition/Unordered | | | | | | | | | | | | | | |
| Form Type | | | | | | | | | | I/O/U/C/D | | | | | | | | | | | | | | | P/S/C/R/T/D | | | | | | | | | | | | | | | Length of Key Field or of Record Address Field | | | | | | | | | | | | | | | | | | | | | | | | | | | | | | | | | | | | | | | | | | | | | | | | | | | | | | | | | | | |
| | | | | | | | | | | End of File | | | | | | | | | | | | | | | Record Address Type | | | | | | | | | | | | | | | Type of File Organization or Additional Area | | | | | | | | | | | | | | | Name of Label Exit | | | | | | | | | | | | | | | Extent Exit for DAM | | | | | | | | | | | | | | | | | | | | | | | | | | | | | |
| | | | | | | | | | | Sequence | | | | | | | | | | | | | | | Overflow Indicator | | | | | | | | | | | | | | | Label S/N/E/M | | | | | | | | | | | | | | | Core Index | | | | | | | | | | | | | | | Number of Tracks for Cylinder Overflow | | | | | | | | | | | | | | | | | | | | | | | | | | | | | |
| | | | | | | | | | | File Format | | | | | | | | | | | | | | | Key Field Starting Location | | | | | | | | | | | | | | | Continuation Lines | | | | | | | | | | | | | | | Number of Extents | | | | | | | | | | | | | | | Tape Rewind | | | | | | | | | | | | | | | | | | | | | | | | | | | | | |
| | | | | | | | | | | Block Length | | | | | | | | | | | | | | | Extension Code E/L | | | | | | | | | | | | | | | Option | | | | | | | | | | | | | | | Entry | | | | | | | | | | | | | | | File Condition U1-U8 | | | | | | | | | | | | | | | | | | | | | | | | | | | | | |
| | | | | | | | | | | Record Length | | | | | | | | | | | | | | | L/R | | | | | | | | | | | | | | | K | | | | | | | | | | | | | | | A/U | | | | | | | | | | | | | | | R/U/N | | | | | | | | | | | | | | | | | | | | | | | | | | | | | |
| 3 4 5 6 7 8 9 10 11 12 13 14 | | | | | | | | | | 15 16 17 18 19 20 21 22 23 24 25 26 27 | | | | | | | | | | | | | | | 28 29 30 | | | | | | | | | | | | | | | 31 32 33 34 | | | | | | | | | | | | | | | 35 36 37 38 | | | | | | | | | | | | | | | 39 40 41 42 43 44 45 46 | | | | | | | | | | | | | | | 47 48 49 50 51 52 53 54 55 56 57 58 59 60 61 62 63 64 65 66 67 68 69 70 71 72 73 74 | | | | | | | | | | | | | | |
| 0 2 | | | | | | | | | | F DISKA | | | | | | | | | | | | | | | IP | | | | | | | | | | | | | | | F 256 | | | | | | | | | | | | | | | 128 | | | | | | | | | | | | | | | DISK | | | | | | | | | | | | | | | | | | | | | | | | | | | | | |
| 0 3 | | | | | | | | | | F T3741 | | | | | | | | | | | | | | | O | | | | | | | | | | | | | | | F 516 | | | | | | | | | | | | | | | 129 | | | | | | | | | | | | | | | BSCA | | | | | | | | | | | | | | | | | | | | | | | | | | | | | |
| 0 4 | | | | | | | | | | F PRINT | | | | | | | | | | | | | | | O | | | | | | | | | | | | | | | F 132 | | | | | | | | | | | | | | | 132 | | | | | | | | | | | | | | | PRINTER | | | | | | | | | | | | | | | | | | | | | | | | | | | | | |
| 0 5 | | | | | | | | | | | | | | | | | | | | | | | | | | | | | | | | | | | | | | | | | | | | | | | | | | | | | | | | | | | | | | | | | | | | | | | | | | | | | | | | | | | | | | | | | | | | | | | | | | | |
| 0 6 | | | | | | | | | | | | | | | | | | | | | | | | | | | | | | | | | | | | | | | | | | | | | | | | | | | | | | | | | | | | | | | | | | | | | | | | | | | | | | | | | | | | | | | | | | | | | | | | | | | |
| 0 7 | | | | | | | | | | | | | | | | | | | | | | | | | | | | | | | | | | | | | | | | | | | | | | | | | | | | | | | | | | | | | | | | | | | | | | | | | | | | | | | | | | | | | | | | | | | | | | | | | | | |
| 0 8 | | | | | | | | | | | | | | | | | | | | | | | | | | | | | | | | | | | | | | | | | | | | | | | | | | | | | | | | | | | | | | | | | | | | | | | | | | | | | | | | | | | | | | | | | | | | | | | | | | | |
| 0 9 | | | | | | | | | | | | | | | | | | | | | | | | | | | | | | | | | | | | | | | | | | | | | | | | | | | | | | | | | | | | | | | | | | | | | | | | | | | | | | | | | | | | | | | | | | | | | | | | | | | |

| RPG TELECOMMUNICATIONS SPECIFICATIONS | | | | | | | | | | | | | | | | | | | | | | | | | | | | | | | | | | | | | | | | | | | | | | | | | | | | | | | | | | | | | | | | | | | | | | Form GX21-9116-1 Printed in U. S. A. | | | | | | | | | |
|---------------------------------------|--|--|--|--|--|--|--|--|--|----------------------|--|--|--|--|--|--|--|--|--|---------|--|--|--|--|--|--|--|--|--|---------------------|--|--|--|--|--|--|--|--|--|---|--|--|--|--|--|--|--|--|--|--|--|--|--|--|--|--|--|--|--|--|--|--|--|--|--|--|--|--|--|---|--|--|--|--|--|--|--|--|--|
| Program | | | | | | | | | | Punching Instruction | | | | | | | | | | Graphic | | | | | | | | | | Card Electro Number | | | | | | | | | | Page <u>1</u> of <u>2</u> Program Identification <u>75 76 77 78 79 80</u> | | | | | | | | | | | | | | | | | | | | | | | | | | | | | | | | | | | | | | | |
| Programmer | | | | | | | | | | Date | | | | | | | | | | Punch | | | | | | | | | | | | | | | | | | | | Program Identification | | | | | | | | | | | | | | | | | | | | | | | | | | | | | | | | | | | | | | | |

| Telecommunications Specifications | | | | | | | | | | | | | | | | | | | | | | | | | | | | | | | | | | | | | | | | | | | | | | | | | | | | | | | | | | | | | | | | | | | | | | | | | | | | | | | | | | | | | | | | | | | | | | | | | | | | | | | | | | | | | | | | | | | | | | | | | | | | | | | | | | | | | | | | | | | | | | | | | | | | | | | | | | | | | | | | | | | | |
|-----------------------------------|--|--|--|--|--|--|--|--|--|--|--|--|--|--|---|--|--|--|--|--|--|--|--|--|--|--|--|--|--|-------------------------|--|--|--|--|--|--|--|--|--|--|--|--|--|--|----------------------|--|--|--|--|--|--|--|--|--|--|--|--|--|--|----------------------|--|--|--|--|--|--|--|--|--|--|--|--|--|--|---|--|--|--|--|--|--|--|--|--|--|--|--|--|--|-----------|--|--|--|--|--|--|--|--|--|--|--|--|--|--|----------------------------|--|--|--|--|--|--|--|--|--|--|--|--|--|--|-------------|--|--|--|--|--|--|--|--|--|--|--|--|--|--|--------------------|--|--|--|--|--|--|--|--|--|--|--|--|--|--|-----------------------|--|--|--|--|--|--|--|--|--|--|--|--|--|--|
| Line | | | | | | | | | | | | | | | Switched | | | | | | | | | | | | | | | Identification | | | | | | | | | | | | | | | Reserved | | | | | | | | | | | | | | | | | | | | | | | | | | | | | | | | | | | | | | | | | | | | | | | | | | | | | | | | | | | | | | | | | | | | | | | | | | | | | | | | | | | | | | | | | | | | | | | | | | | | | | | | | | | | | | | | | | | | | | | |
| Form Type | | | | | | | | | | | | | | | Dial Number | | | | | | | | | | | | | | | This Station | | | | | | | | | | | | | | | Remote Station | | | | | | | | | | | | | | | Remote Device | | | | | | | | | | | | | | | Permanent Error Indicator | | | | | | | | | | | | | | | Wait Time | | | | | | | | | | | | | | | Picord Available Indicator | | | | | | | | | | | | | | | L Last File | | | | | | | | | | | | | | | Polling Characters | | | | | | | | | | | | | | | Addressing Characters | | | | | | | | | | | | | | |
| T | | | | | | | | | | | | | | | S/E | | | | | | | | | | | | | | | S/E | | | | | | | | | | | | | | | | | | | | | | | | | | | | | | I = ITB | | | | | | | | | | | | | | | | | | | | | | | | | | | | | | P | | | | | | | | | | | | | | | L | | | | | | | | | | | | | | | P | | | | | | | | | | | | | | | A | | | | | | | | | | | | | | | | | | | | | | | | | | | | | |
| 3 4 5 6 7 8 9 10 11 12 13 14 | | | | | | | | | | | | | | | 15 16 17 18 19 20 21 22 23 24 25 26 27 28 29 30 31 32 | | | | | | | | | | | | | | | 33 34 35 36 37 38 39 40 | | | | | | | | | | | | | | | 41 42 43 44 45 46 47 | | | | | | | | | | | | | | | 48 49 50 51 52 53 54 | | | | | | | | | | | | | | | 55 56 57 58 59 60 61 62 63 64 65 66 67 68 69 70 71 72 73 74 | | | | | | | | | | | | | | | | | | | | | | | | | | | | | | | | | | | | | | | | | | | | | | | | | | | | | | | | | | | | | | | | | | | | | | | | | | | | | | | | | | | | | | | | | |
| 0 1 | | | | | | | | | | | | | | | T T3741 | | | | | | | | | | | | | | | ST ENM | | | | | | | | | | | | | | | | | | | | | | | | | | | | | | | | | | | | | | | | | | | | | 98 | | | | | | | | | | | | | | | | | | | | | | | | | | | | | | | | | | | | | | | | | | | | | | | | | | | | | | | | | | | | | | | | | | | | | | | | | | | | | | | | | | | | | | | | | |
| 0 2 | | | | | | | | | | | | | | | | | | | | | | | | | | | | | | | | | | | | | | | | | | | | | | | | | | | | | | | | | | | | | | | | | | | | | | | | | | | | | | | | | | | | | | | | | | | | | | | | | | | | | | | | | | | | | | | | | | | | | | | | | | | | | | | | | | | | | | | | | | | | | | | | | | | | | | | | | | | | | | | | | | | | |
| 0 3 | | | | | | | | | | | | | | | | | | | | | | | | | | | | | | | | | | | | | | | | | | | | | | | | | | | | | | | | | | | | | | | | | | | | | | | | | | | | | | | | | | | | | | | | | | | | | | | | | | | | | | | | | | | | | | | | | | | | | | | | | | | | | | | | | | | | | | | | | | | | | | | | | | | | | | | | | | | | | | | | | | | | |

Figure 16. Transmitting to a 3741 Using an Expanded Communications Buffer (Part 1 of 2)

This page intentionally left blank

Receiving a Status Message from an IBM 3741 Data Station

Figure 17 shows how to receive the status message from a 3741 Data Station when a BSCA error has occurred.

The IBM 3741 transmits data via the BSCA to System/3. This data forms the input file INBSCA. System/3 then writes the data received in printer file OUTBSCA.

When an error occurs on the 3741, the permanent error indicator in the RPG II program is turned on. BSC data management closes the INBSCA file and opens INERROR to receive the status message. The 1-byte character received is compared to the 3741 status indicators and the appropriate message is placed in printer file OUTBSCA.

Control Card Specifications

| Column | Field Name | Field Type | Length | Position | Other |
|--------|------------|------------|--------|----------|-------|
| 1-2 | INBSCA | IPE | F 128 | 128 | |
| 3-4 | OUTBSCA | O | F 132 | 132 | |
| 5-6 | INERROR | ID | F 128 | 128 | |

File Description Specification

| File Name | File Type | File Format | File Length | File Position | File Description | File Comment |
|-----------|-----------|-------------|-------------|---------------|------------------|--------------|
| INBSCA | IPE | F | 128 | 128 | BSCA | |
| OUTBSCA | O | F | 132 | 132 | PRINTER | |
| INERROR | ID | F | 128 | 128 | BSCA | |

• Figure 17. Receiving a Status Message from an IBM 3741 Data Station (Part 1 of 7)

Extension Specifications

| Extension Name | Extension Type | Extension Length | Extension Position | Extension Description | Extension Comment |
|----------------|----------------|------------------|--------------------|-----------------------|-------------------|
| | CHAR | 3 | 9 | 1 | MSG 30 |

• Figure 17. Receiving a Status Message from an IBM 3741 Data Station (Part 2 of 7)

| IBM | | RPG CALCULATION SPECIFICATIONS | | | | | | | | | | GX21-9093 2 U/M 0501 Printed in U.S.A. | | | | | |
|---------|-----------|--------------------------------|-----|----------------------|---------|-----|---------------------|-----------------|--------------|----------|-------------------------------|---|----------------|--------------------|------|-------|------|
| Program | | Date | | Punching Instruction | Graphic | | Card Electro Number | | Page 05 of 7 | | Program Identification STATUS | | | | | | |
| Line | Form Type | Indicators | | | | | | Factor 1 | Operation | Factor 2 | Result Field | | | Results Indicators | | | |
| | | And | And | And | And | And | And | | | | Name | Length | Decimal Places | Arithmetic | Plus | Minus | Zero |
| 01 | C | 01 | | | | | COUNT | ADD 1 | | COUNT | 30 | | | | | | |
| 02 | C | 50 | | | | | | READ INERROR | | | | | | | | | 03 |
| 03 | C | 50 | | | | | | Z-ADD1 | | INX | 20 | | | | | | |
| 04 | C | 50 | | | | | STAT | LOOKUPCHAR, INX | | | | | | | | | 60 |
| 05 | C | 50N60 | | | | | | MOVE 'UNKNOWN' | | MSAVE | 30 | | | | | | |
| 06 | C | 50 | | | | | | MOVE MSG, INX | | MSAVE | 30 | | | | | | |
| 07 | C | 50 | | | | | | SETON | | | | | | | | | 51LR |

Figure 17. Receiving a Status Message from an IBM 3741 Data Station (Part 5 of 7)

| IBM | | RPG OUTPUT SPECIFICATIONS | | | | | | | | | | GX21-9093 2 U/M 0501 Printed in U.S.A. | | | | | | | | |
|---------|-----------|---------------------------|----------------|----------------------|---------|-------|---------------------|-------|--------------|-----|-------------------------------|---|------------------------|---------|------------|------------|-------------------------------|---------|-----------------------|----|
| Program | | Date | | Punching Instruction | Graphic | | Card Electro Number | | Page 06 of 7 | | Program Identification STATUS | | | | | | | | | |
| Line | Form Type | Filename | Type (H/D/T/E) | | | | Space | | Skip | | | Output Indicators | | | Field Name | Edit Codes | End Position in Output Record | P/B/L/R | Constant or Edit Word | |
| | | | Before | After | Before | After | Before | After | Not | Not | Not | Commas | Zero Balances to Print | No Sign | | | | | | CR |
| 01 | O | OUTBSCA | H | | | | | | | | | | | | | | | | | |
| 02 | O | | | | | | | | | | | | | | | | | | | |
| 03 | O | | | | | | | | | | | | | | | | | | | |
| 04 | O | | | | | | | | | | | | | | | | | | | |
| 05 | O | | | | | | | | | | | | | | | | | | | |
| 06 | O | | | | | | | | | | | | | | | | | | | |
| 07 | O | | | | | | | | | | | | | | | | | | | |
| 08 | O | | | | | | | | | | | | | | | | | | | |
| 09 | O | | | | | | | | | | | | | | | | | | | |
| 10 | O | | | | | | | | | | | | | | | | | | | |
| 11 | O | | | | | | | | | | | | | | | | | | | |
| 12 | O | | | | | | | | | | | | | | | | | | | |
| 13 | O | | | | | | | | | | | | | | | | | | | |
| 14 | O | | | | | | | | | | | | | | | | | | | |
| 15 | O | | | | | | | | | | | | | | | | | | | |
| 16 | O | | | | | | | | | | | | | | | | | | | |
| 17 | O | | | | | | | | | | | | | | | | | | | |
| 18 | O | | | | | | | | | | | | | | | | | | | |
| 19 | O | | | | | | | | | | | | | | | | | | | |
| 20 | O | | | | | | | | | | | | | | | | | | | |

Figure 17. Receiving a Status Message from an IBM 3741 Data Station (Part 6 of 7)

| | ** 3741 STATUS CHARACTER INDICATORS FOR A RECEIVE PROGRAM. | DISK OVERFLOW | DISK ERROR ON DISK |
|-------------------------------|--|---------------|--------------------|
| TTTRANSPARENCY ERROR OCCURRED | SRESET WAS PRESSED ON 3741 | | |
| LENGTH ERROR ON DISK | AND RECORD FOUND ON DISK | | |
| THREAD ERROR ON DISK | | | |
| | | | |
| | | | |
| | | | |
| | | | |
| | | | |
| | | | |
| | | | |
| | | | |

* 3741 STATUS CHARACTER INDICATORS FOR A RECEIVE PROGRAM.

RPG INPUT SPECIFICATIONS

GX21 9094 2 U.M. 0507
Printed in U.S.A.

| | | | | | | | |
|------------|--|----------------------|--|---------|--|---------------------|--|
| Program | | Punching Instruction | | Graphic | | Card Electro Number | |
| Programmer | | Date | | Punch | | | |

Page 1 of 2 Program Identification **BSCAØ4** 75 76 77 78 79 80

| Line | Form Type | Filename | Sequence Number (1-N) | Record Identifying Indicator | Record Identification Codes | | | | | | | | | Field Location | | Field Name | Control Level (L1-L9) | Matching Fields or Chaining Fields | Field Record Relation | Field Indicators | | |
|------|-----------|----------|-----------------------|------------------------------|-----------------------------|---------|-----------------|----------|---------|-----------------|----------|---------|-----------------|----------------|----|------------|-----------------------|------------------------------------|-----------------------|------------------|-------|---------------|
| | | | | | 1 | | | 2 | | | 3 | | | From | To | | | | | Plus | Minus | Zero or Blank |
| | | | | | Position | Not (N) | C/Z/D Character | Position | Not (N) | C/Z/D Character | Position | Not (N) | C/Z/D Character | | | | | | | | | |
| 01 | I | R3741 | NS | ØL | | | | | | | | | | | | | | | | | | |
| 02 | I | | | | | | | | | | | | | | | | | | | | | |
| 03 | I | | | | | | | | | | | | | | | | | | | | | |
| 04 | I | | | | | | | | | | | | | | | | | | | | | |
| 05 | I | | | | | | | | | | | | | | | | | | | | | |

L 128 DATA
 * RECORD SEPARATOR FOLLOWING EACH REC 129 129 RECSCP
 * USER NEED NOT CODE FOR SEPARATOR ON INPUT

Figure 18. Receiving from a 3741 Data Station with Expanded Communications Feature (Part 3 of 5)

RPG CALCULATION SPECIFICATIONS

Form GX21 9093 2
Printed in U.S.A.

| | | | | | | | |
|------------|--|----------------------|--|---------|--|---------------------|--|
| Program | | Punching Instruction | | Graphic | | Card Electro Number | |
| Programmer | | Date | | Punch | | | |

Page 1 of 2 Program Identification **BSCAØ4** 75 76 77 78 79 80

| Line | Form Type | Control Level (L1-L9) | Indicators | Factor 1 | Operation | Factor 2 | Result Field Name | Length | Decimal Positions | Resulting Indicators | | | Comments |
|------|-----------|-----------------------|------------|----------|-----------|----------|-------------------|--------|-------------------|----------------------|-------|---------------|----------|
| | | | | | | | | | | Plus | Minus | Zero | |
| | | | | | | | | | | 1 > 2 | 1 < 2 | 1 = 2 | |
| 01 | C | | N98 ØL | COUNT | ADD | | COUNT | 40 | | | | COUNT RECORDS | |
| 02 | C | | 98 | | SETON | | | | | | | LR LINE ERROR | |
| 03 | C | | | | | | | | | | | | |
| 04 | C | | | | | | | | | | | | |
| 05 | C | | | | | | | | | | | | |

Figure 18. Receiving from a 3741 Data Station with Expanded Communications Feature (Part 4 of 5)

RPG OUTPUT SPECIFICATIONS

GX21 9090 2 U.M. 0507
Printed in U.S.A.

| | | | | | | | |
|------------|--|----------------------|--|---------|--|---------------------|--|
| Program | | Punching Instruction | | Graphic | | Card Electro Number | |
| Programmer | | Date | | Punch | | | |

Page 1 of 2 Program Identification **BSCAØ4** 75 76 77 78 79 80

| Line | Form Type | Filename | Type (H/D/T/E) | Space Before | Space After | Skip | Output Indicators | Field Name | End Position in Output Record | Constant or Edit Word | | | | | | | | | | | |
|------|-----------|----------|----------------|--------------|-------------|------|-------------------|------------|-------------------------------|-----------------------|------------------------|---------|----|---|---|------------------|--|--|--|--|--|
| | | | | | | | | | | Commas | Zero Balances to Print | No Sign | CR | - | X | Remove Plus Sign | | | | | |
| | | | | | | | | | | Yes | Yes | 1 | A | J | Y | Date | | | | | |
| 01 | O | PRINT | D | | | | ØLN98 | | | | | | | | | | | | | | |
| 02 | O | | | | | | | DATA | 128 | | | | | | | | | | | | |
| 03 | O | | | | | | LR | | | | | | | | | | | | | | |
| 04 | O | | | | | | | | | | | | | | | | | | | | |
| 05 | O | | | | | | | COUNT | | | | | | | | | | | | | |
| 06 | O | | | | | | | | | | | | | | | | | | | | |
| 07 | O | | | | | | 98 | | | | | | | | | | | | | | |
| 08 | O | | | | | | 98 | | | | | | | | | | | | | | |
| 09 | O | | | | | | | | | | | | | | | | | | | | |
| 10 | O | | | | | | | | | | | | | | | | | | | | |

Figure 18. Receiving from a 3741 Data Station with Expanded Communications Feature (Part 5 of 5)

This page intentionally left blank

RPG CONTROL CARD AND FILE DESCRIPTION SPECIFICATIONS

GX21-9092-3 UM/050*
Printed in U.S.A.

| | | | | | | | |
|------------|------|----------------------|---------|--|--|--|---------------------|
| Program | | Punching Instruction | Graphic | | | | Card Electro Number |
| Programmer | Date | | Punch | | | | |

Page 1 of 2 Program Identification 75 76 77 78 79 80
B S C A 0 3

Control Card Specifications

| Line | Form Type | Core Size to Compile | Object Output Listing Options | Core Size to Execute | Debug | MFCM Stacking Sequence | Inverted Print | Number Of Print Positions | Address to Start | Work Tapes | Overlay Open | Overlay Printer | Binary Search | Table Error | 2152 Checking | Inquiry | Read/Write/Compare | Keyboard Output | Sign Handling | IP Forms Position | Indicator Setting | File Translation | Punch MFCU Zeros | Nonprint Characters | Table Load Halt | Shared I/O | Field Print | Formatted Core Dump | RPG to RPG II Conversion |
|------|-----------|----------------------|-------------------------------|----------------------|-------|------------------------|----------------|---------------------------|------------------|------------|--------------|-----------------|---------------|-------------|---------------|---------|--------------------|-----------------|---------------|-------------------|-------------------|------------------|------------------|---------------------|-----------------|------------|-------------|---------------------|--------------------------|
| 01 | H | | D | | | | | | | | | | | | | | | | | | | | | | | | | | |

Refer to the specific System Reference Library manual for actual entries.

File Description Specification

| Line | Form Type | Filename | File Type | File Designation | End of File | Sequence | File Format | Block Length | Record Length | Mode of Processing | Record Address Type | Type of File Organization or Additional Area | Overflow Indicator | Key Field Starting Location | Device | Symbolic Device | Label S/N/E/M | Name of Label Exit | Extent Exit for DAM | Core Index | File Addition/Unordered | Number of Tracks for Cylinder Overflow | Number of Extents | Tape Rewind | File Condition U1-U8 |
|------|-----------|----------|-----------|------------------|-------------|----------|-------------|--------------|---------------|--------------------|---------------------|--|--------------------|-----------------------------|---------|-----------------|---------------|--------------------|---------------------|------------|-------------------------|--|-------------------|-------------|----------------------|
| 02 | F | DISKA | IP | | | | F | 256 | 128 | | | | | | DISK | | | | | | | | | | |
| 03 | F | T3741 | O | | | | F | 516 | 129 | | | | | | BSCA | | | | | | | | | | |
| 04 | F | PRINT | O | | | | F | 132 | 132 | | | | | | PRINTER | | | | | | | | | | |
| 05 | F | | | | | | | | | | | | | | | | | | | | | | | | |
| 06 | F | | | | | | | | | | | | | | | | | | | | | | | | |
| 07 | F | | | | | | | | | | | | | | | | | | | | | | | | |
| 08 | F | | | | | | | | | | | | | | | | | | | | | | | | |
| 09 | F | | | | | | | | | | | | | | | | | | | | | | | | |

RPG TELECOMMUNICATIONS SPECIFICATIONS

Form GX21-9116-1
Printed in U.S.A.

| | | | | | | | |
|------------|------|----------------------|---------|--|--|--|---------------------|
| Program | | Punching Instruction | Graphic | | | | Card Electro Number |
| Programmer | Date | | Punch | | | | |

Page 1 of 2 Program Identification 75 76 77 78 79 80

RPG TELECOMMUNICATIONS SPECIFICATIONS

| Line | Form Type | Filename | P/S/M Configuration | T/R Type of Station | I/E Type of Control | U/E Type of Code | Y/N Transparency | M/E/S/A/B | Switched | Identification | Remote Device | I = IEB Permanent Error Indicator | Wait Time | Record Available Indicator | L Last File | Polling Characters | Addressing Characters | Reserved |
|------|-----------|----------|---------------------|---------------------|---------------------|------------------|------------------|-----------|----------|----------------|---------------|-----------------------------------|-----------|----------------------------|-------------|--------------------|-----------------------|----------|
| 01 | T | T3741 | ST | EN | M | | | | | | | 98 | | | | | | |
| 02 | T | | | | | | | | | | | | | | | | | |
| 03 | T | | | | | | | | | | | | | | | | | |

Figure 16. Transmitting to a 3741 Using an Expanded Communications Buffer (Part 1 of 2)

Appendix H. Using RPG II in Communications Between a System/3 and the IBM 3750 (World Trade Only)

When a System/3 is connected to an IBM 3750 Switching System, the RPG II telecommunication program must be used to code the application programs allowing message exchanges between the two systems. The application program can be written for message exchange related to the following 3750 functions:

1. Call recording
2. Contact monitoring under data processing system control
3. Inquiry to data processing system with recorded answer
4. Real time data collection to data processing system
5. Recorded announcement to extension under data processing system
6. Transfer of recorded data to data processing system

Communications between the System/3 and the 3750 are binary synchronous, point-to-point operations in transparent mode. Only the EBCDIC code can be used. The System/3 operates as a transmit and receive station.

Programming Procedure

On each end of file (EOT) received from a file, the RPG II program must switch to read the other input file.

1. The input files will be defined as receive files on the RPG II telecommunications specifications.
2. The output file will be defined as a transmit file on the RPG II telecommunications specifications.
3. The exit from the RPG II program can be taken when the stop message is received.
4. The remot device field of the RPG II telecommunications specification must be left blank. The 3750 is considered to be a processor by System/3 RPG II BSCA.

Appendix I. System/3 RPG II Interface to BSC Line Protocol

This appendix is intended for a person who is knowledgeable about BSC line protocol. This person should have the following information to:

- Write a program for the remote location to interface with System/3 RPG II
- Write a program for the System/3 to perform a specific sequence of line protocol

The appendix shows RPG II Binary Synchronous Communications (BSC) line protocols and indicates which ones are performed automatically and which ones the RPG II program controls.

Each System/3 transmission of data over the communication line is equal to BLOCK SIZE on the BSCA's File Description Specification. The size of the data blocks received by System/3 is controlled by the transmitting station. (The asterisk in the System/3 Software/Adapter column indicates customer coding logic.)

Note: During the execution of an RPG II telecommunication program, BSC output data management delays transmission of each block of data until the next block is ready to be transmitted. This delay is necessary to allow data management to place the proper line control character (ETX) on the last block of data to be transmitted. For example, the *Transmit Multiple Files* chart shows the last data block of file 1 being transmitted as a result of the user program requesting output to BSC file n.

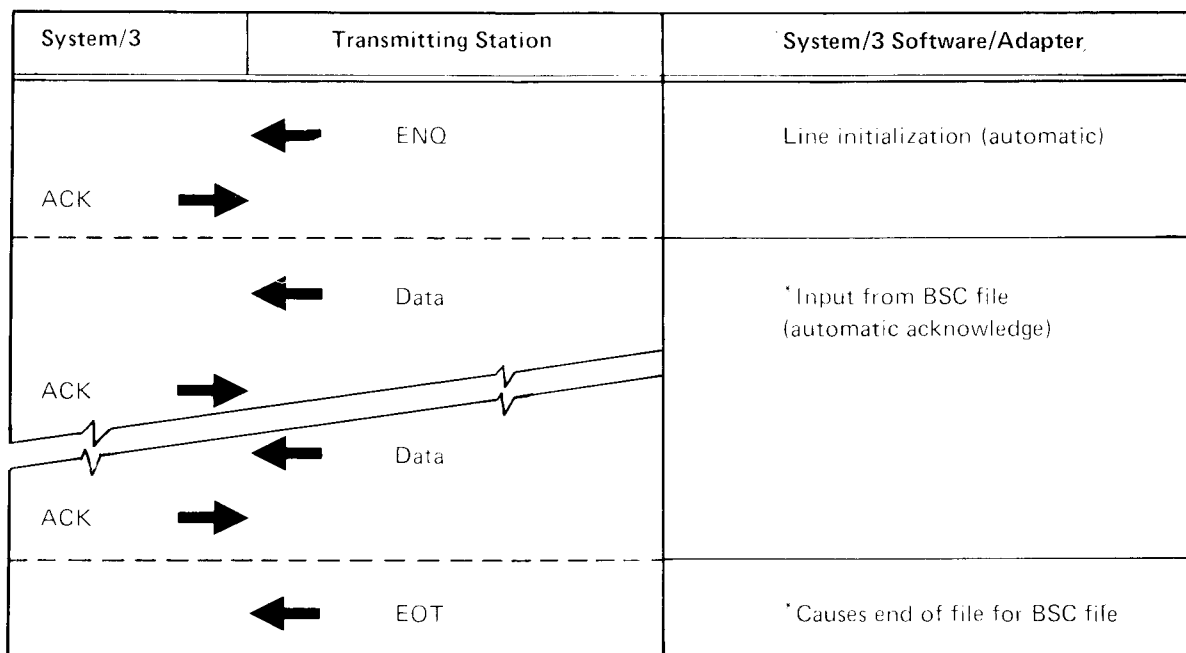

Transmit

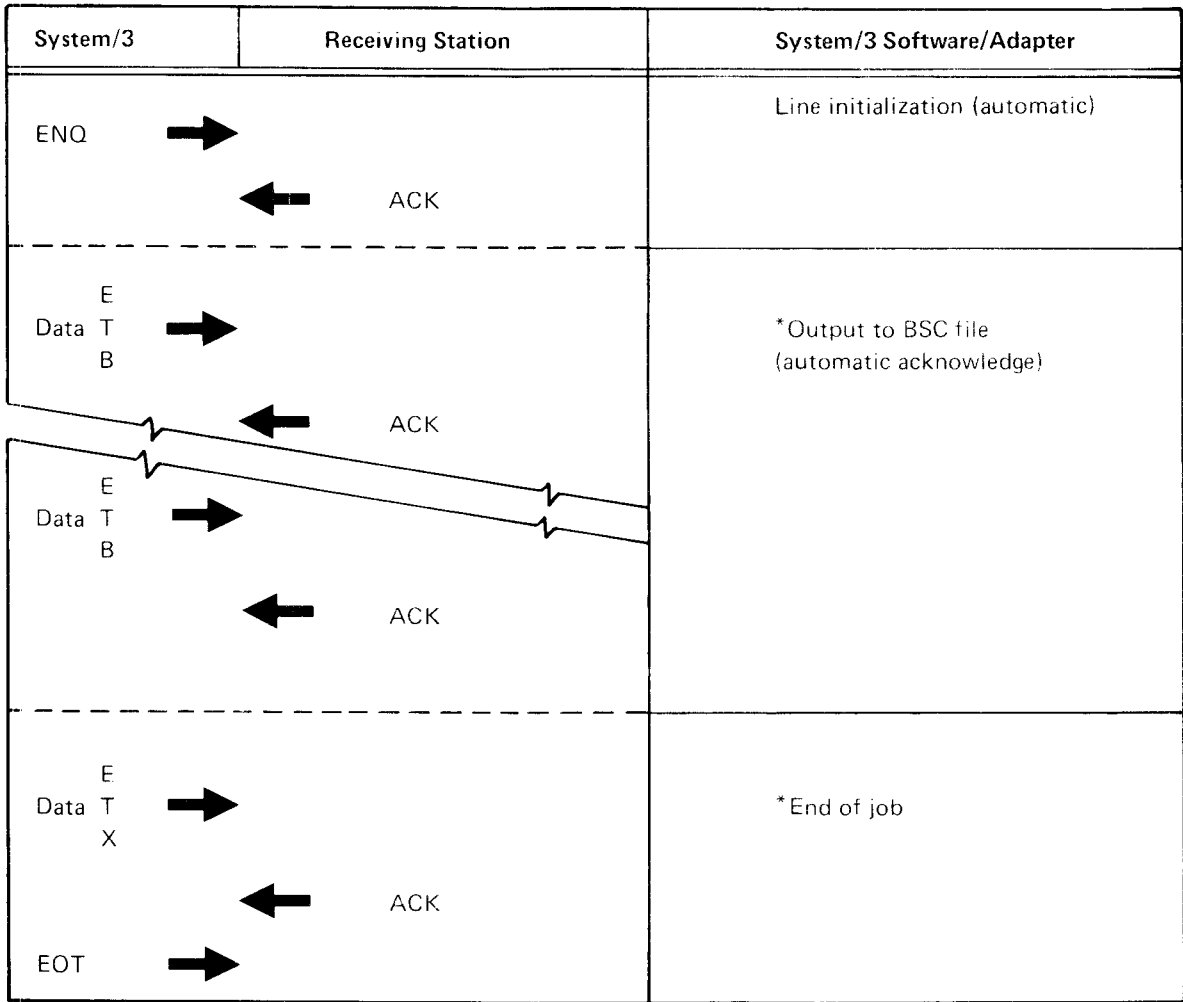

Transmit Multiple Files

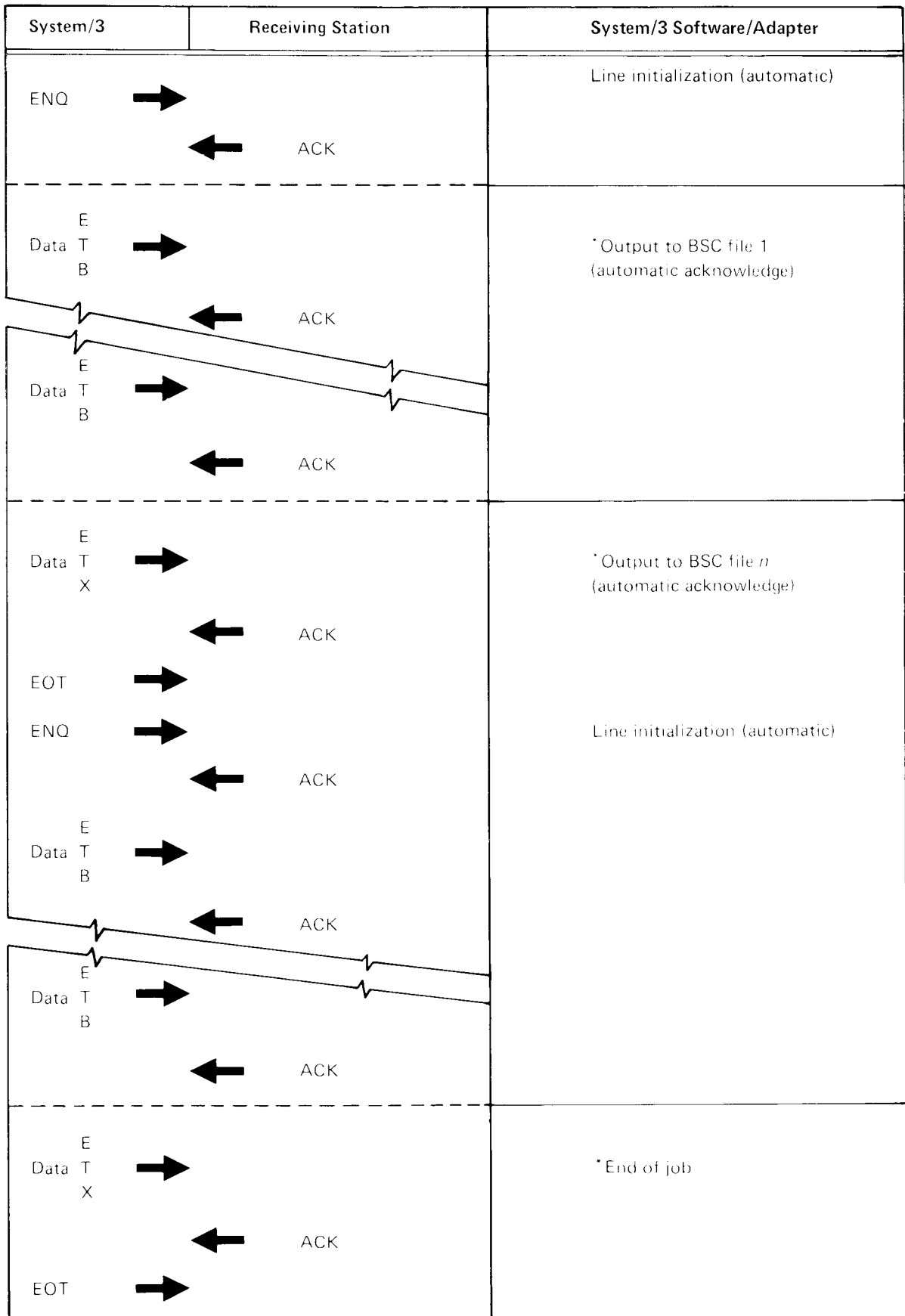

Transmit/Receive

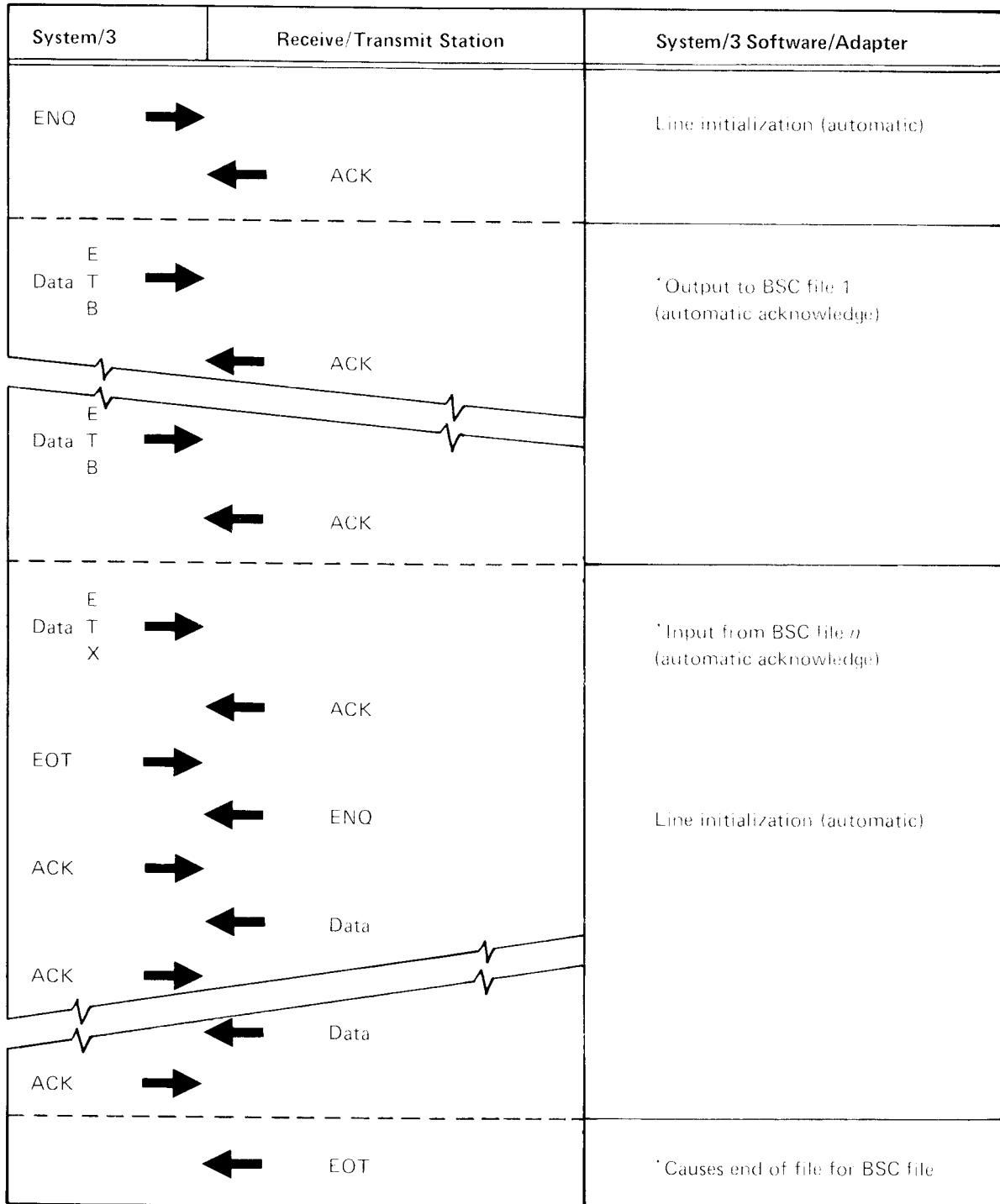

Receive/Transmit

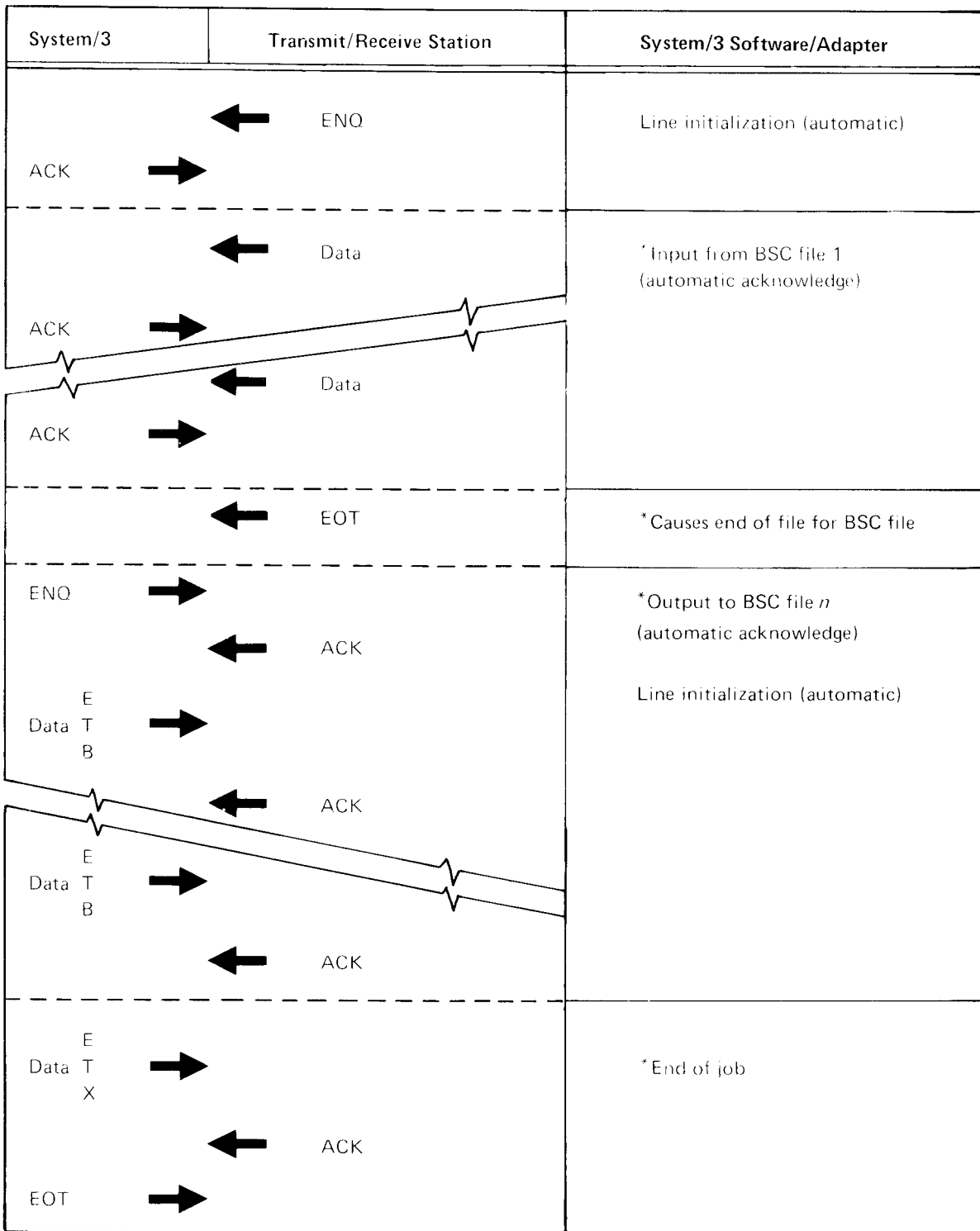

LEASED MULTIPOINT, SYSTEM/3 TRIBUTARY STATION

Receive

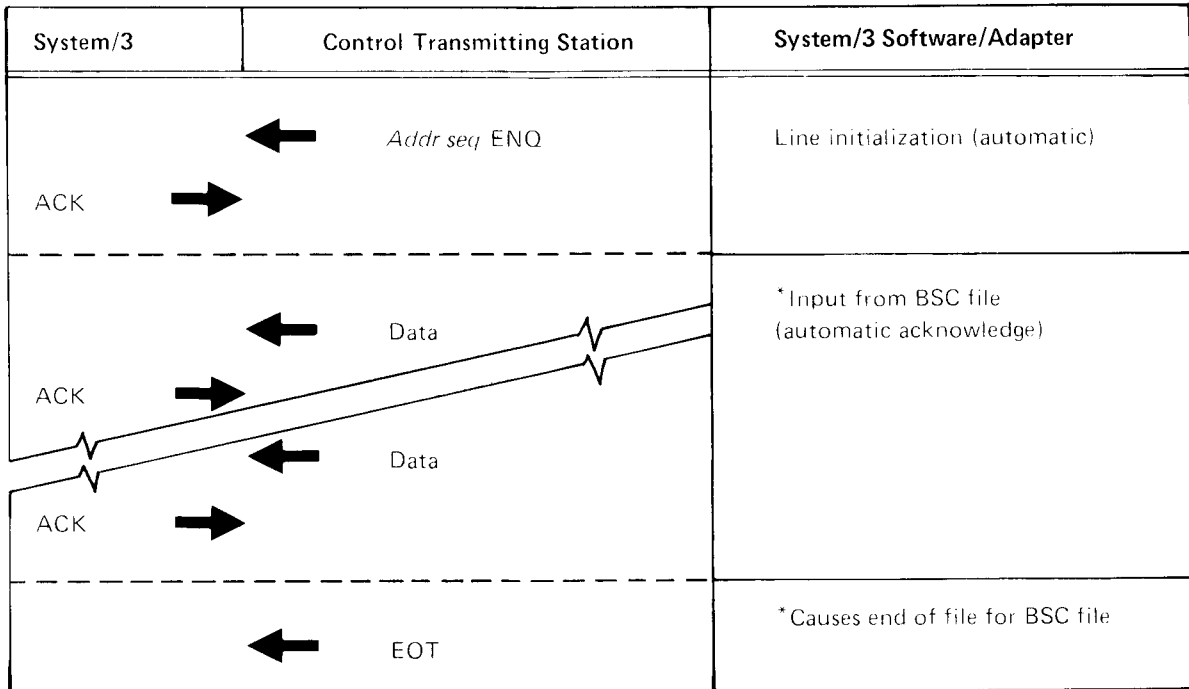

Transmit

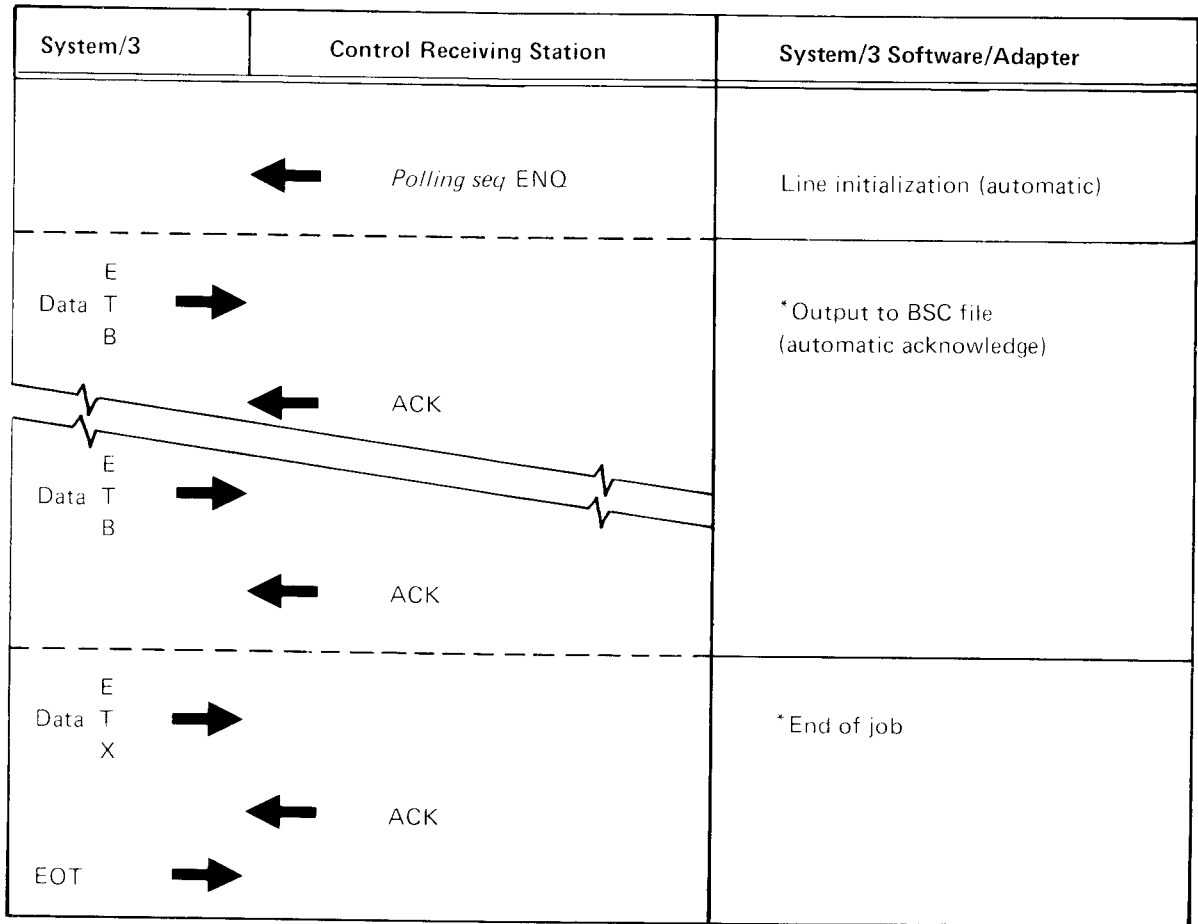

Transmit, Receive

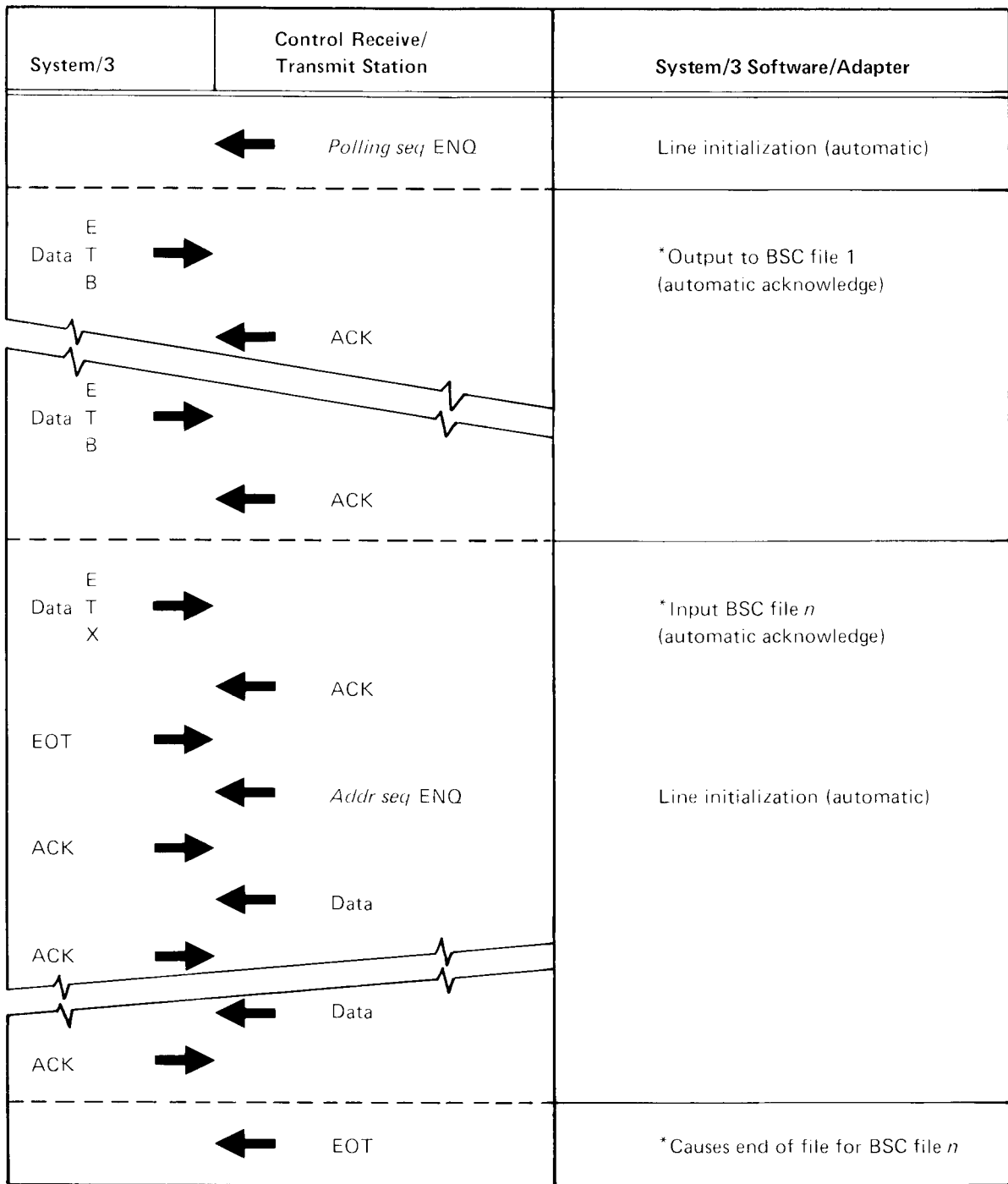

Receive, Transmit

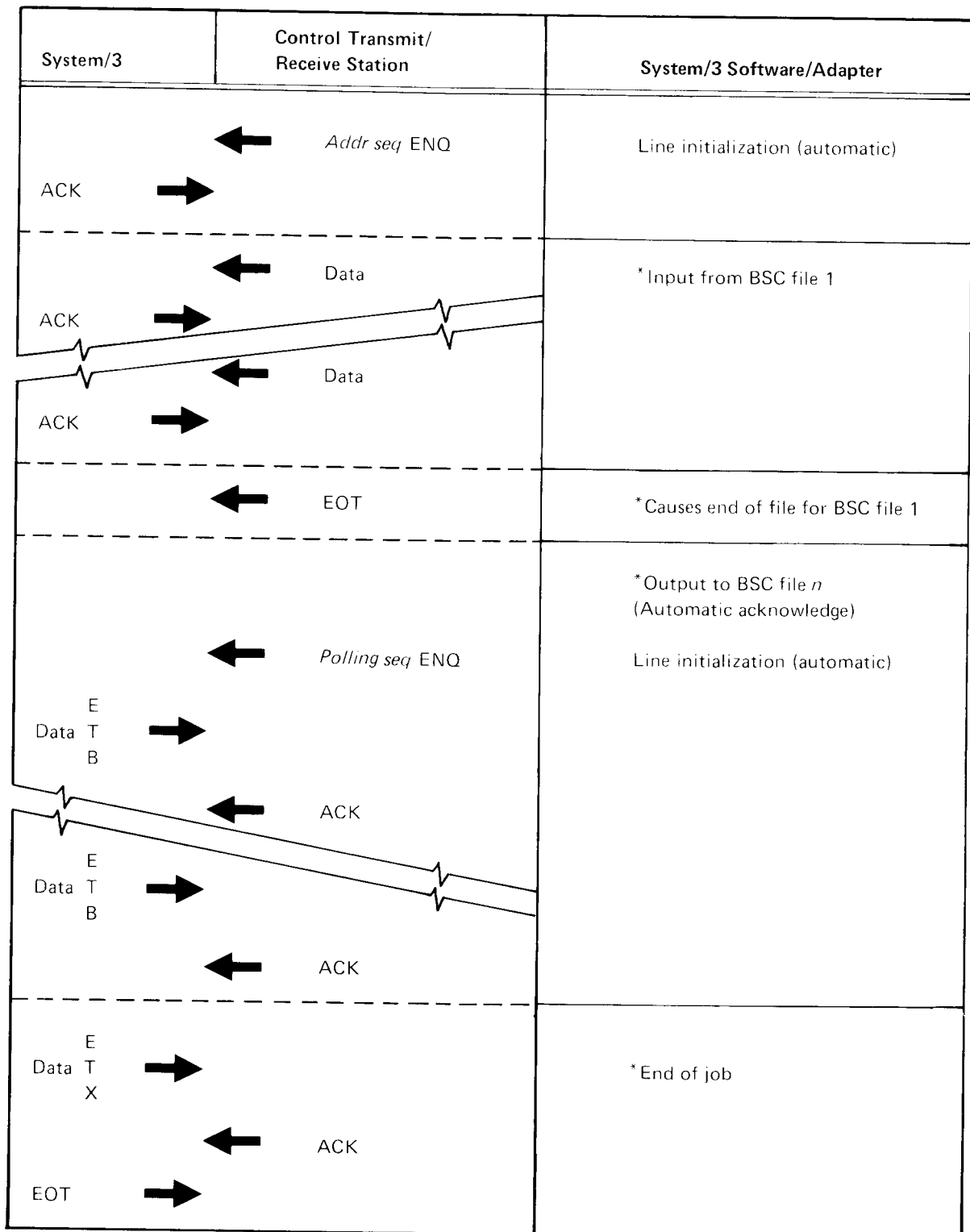

POINT-TO-POINT SWITCHED LINE

ID SEQ: SWITCHED LINE STATION IDENTIFICATION SEQUENCE OPTIONAL

Receive, System/3 Answer Station

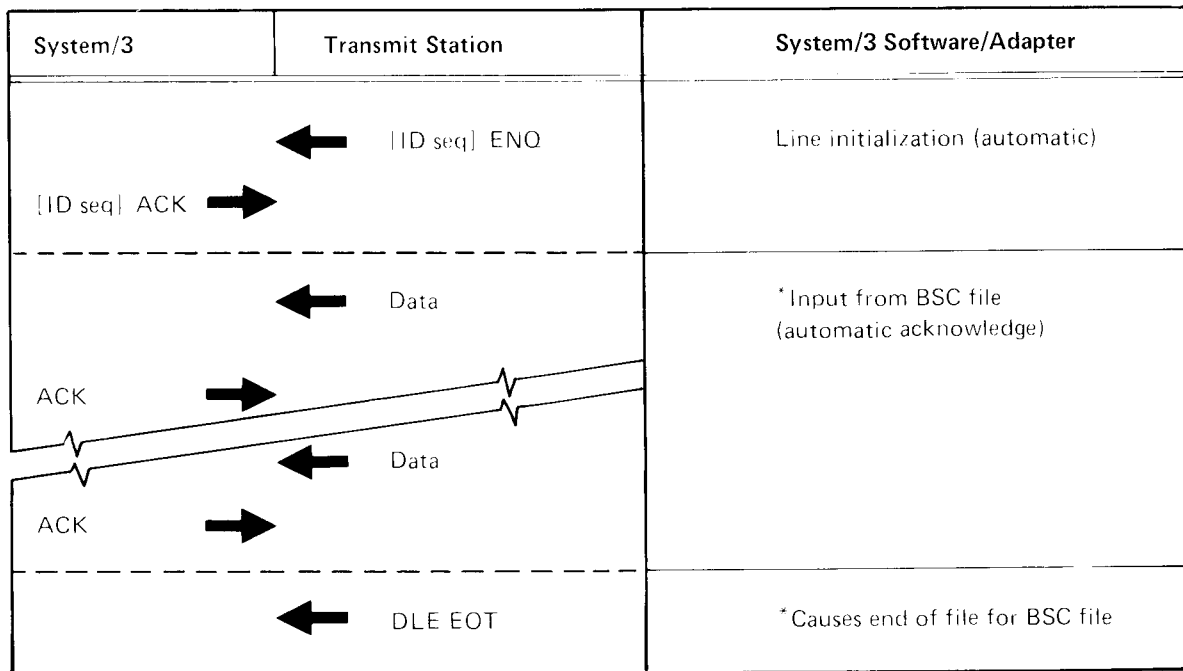

Receive, System/3 Calling Station

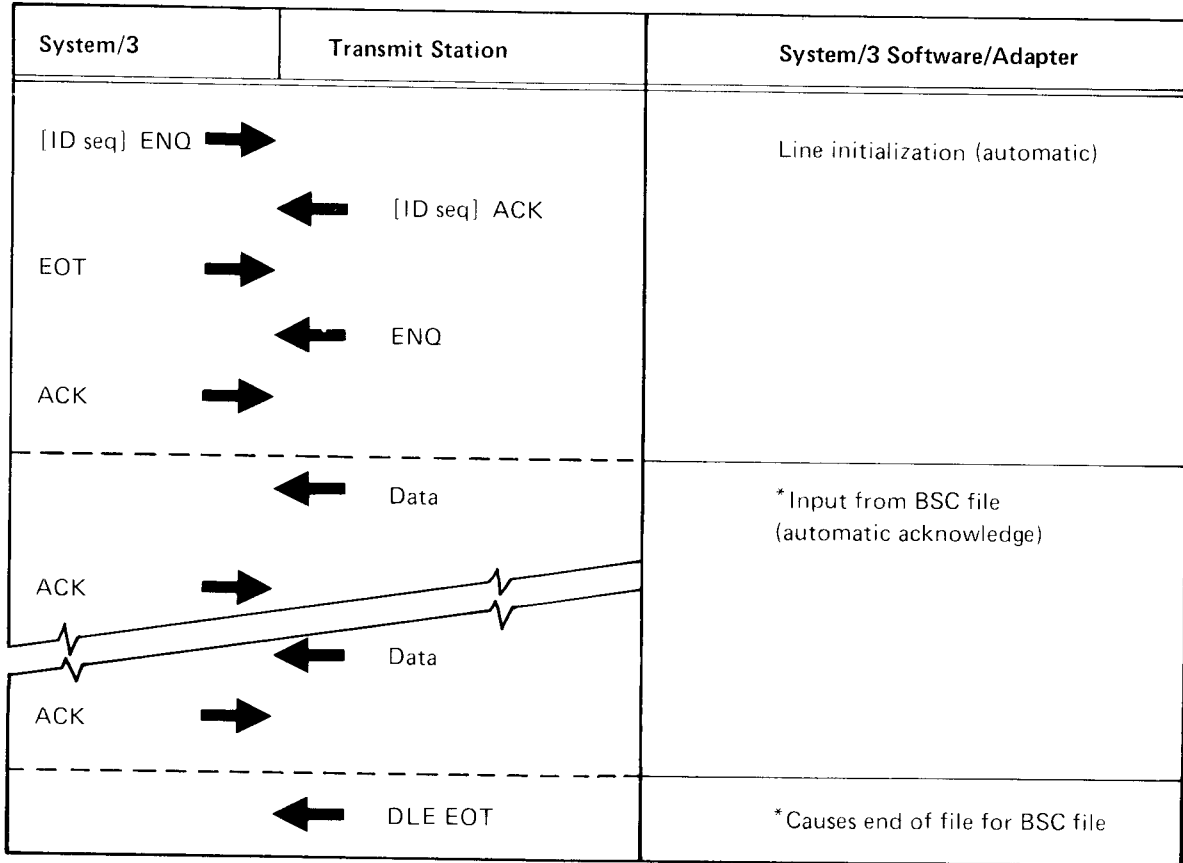

Transmit, System/3 Answer Station

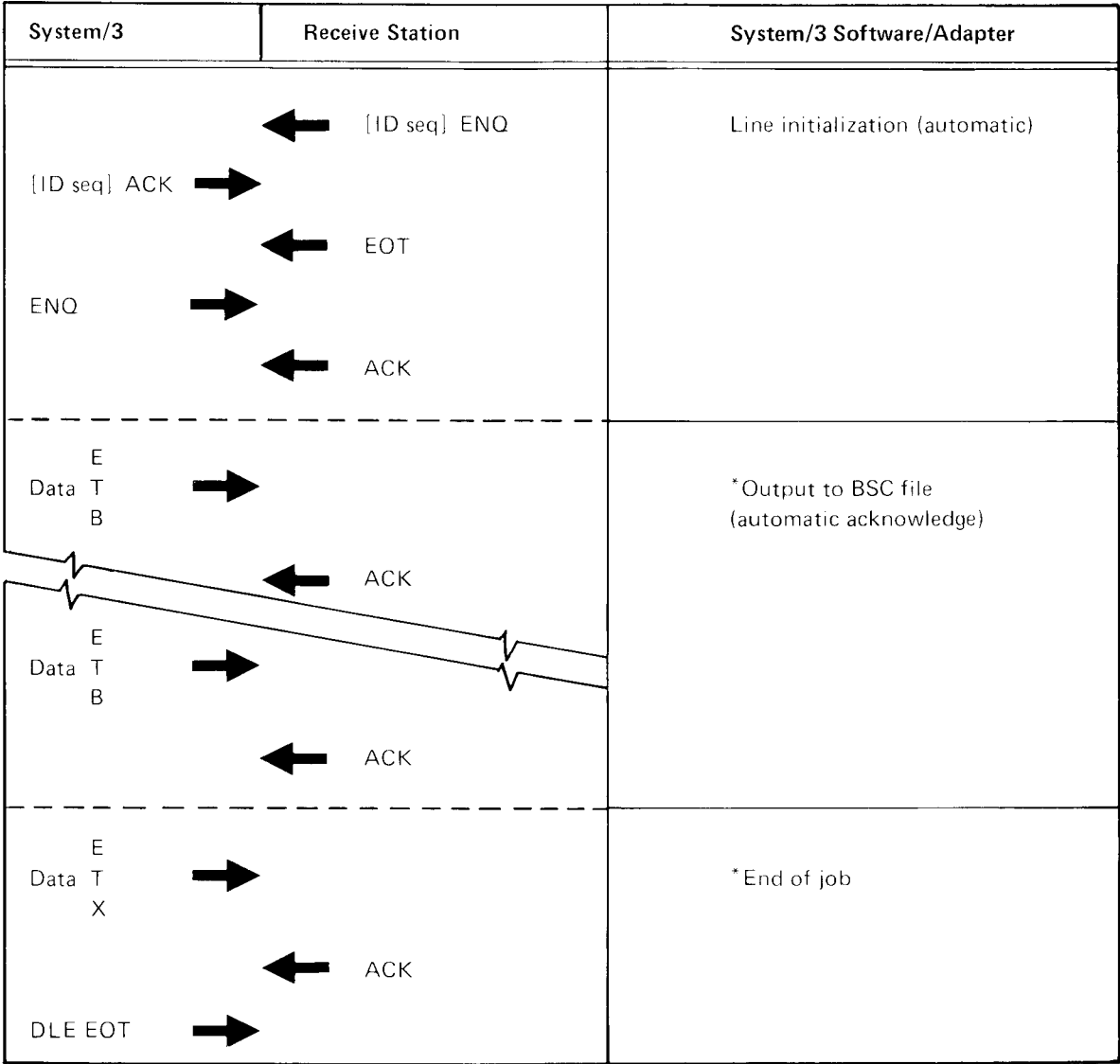

Transmit, System/3 Calling Station

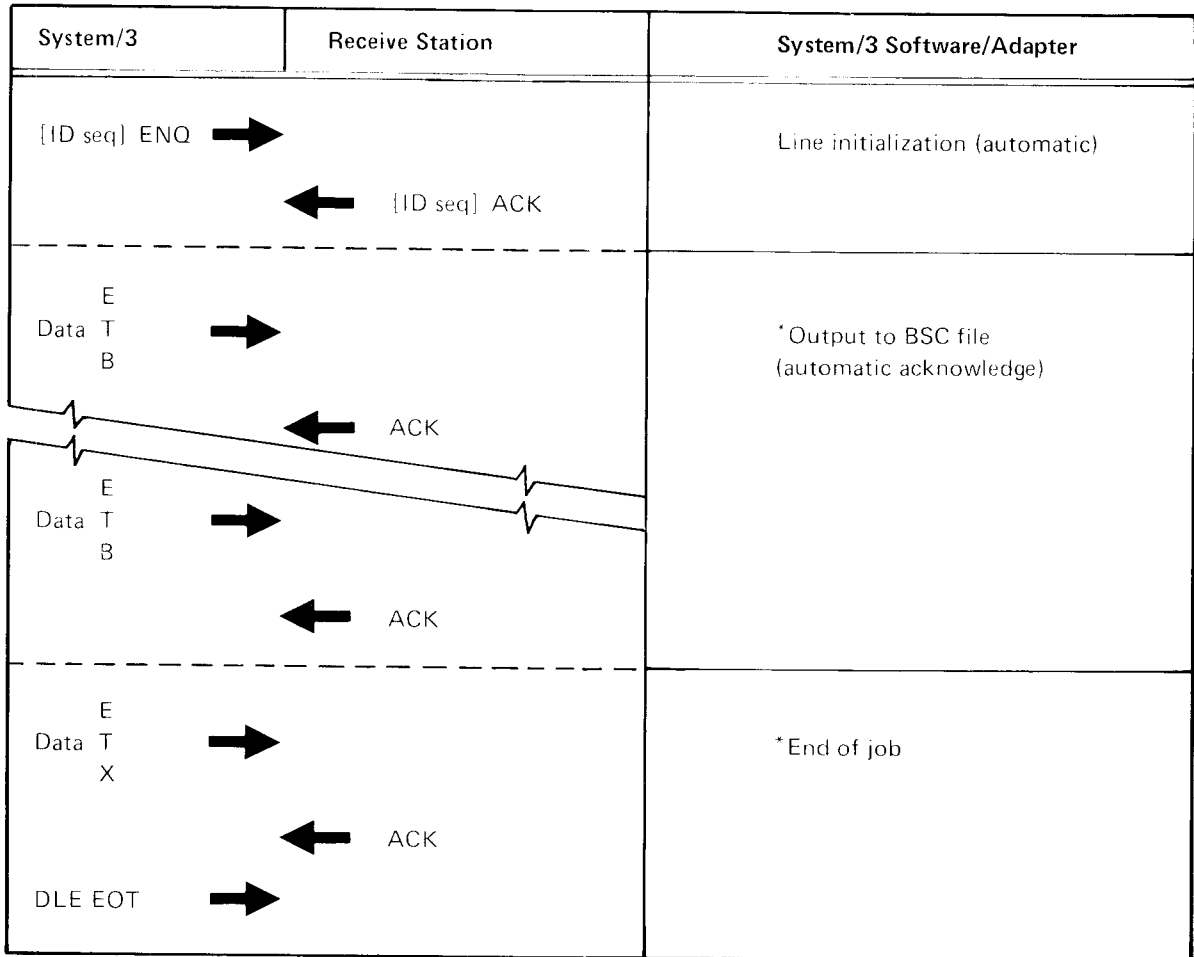

Transmit/Receive, System/3 Calling Station

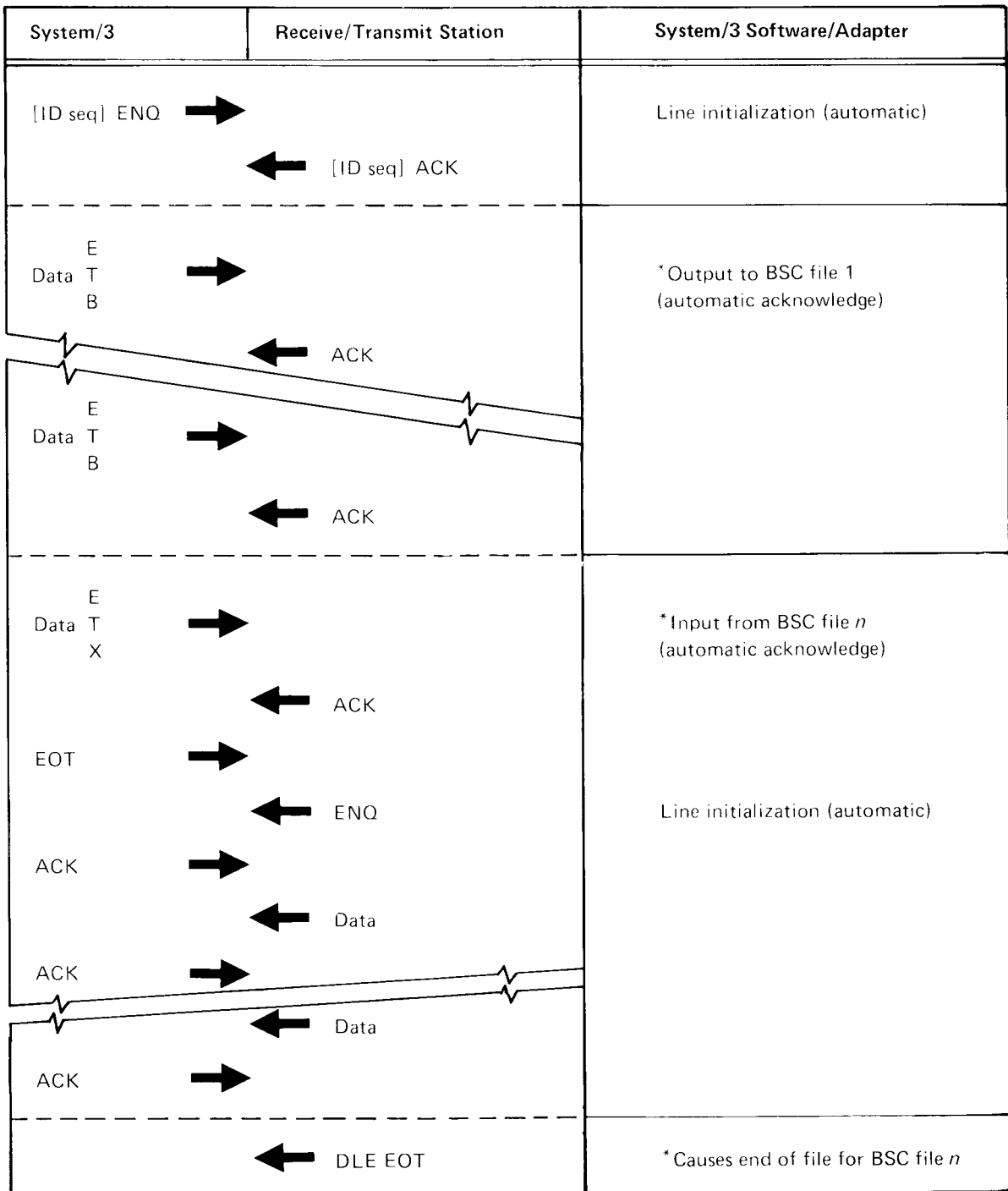

Transmit/Receive, System/3 Answer Station

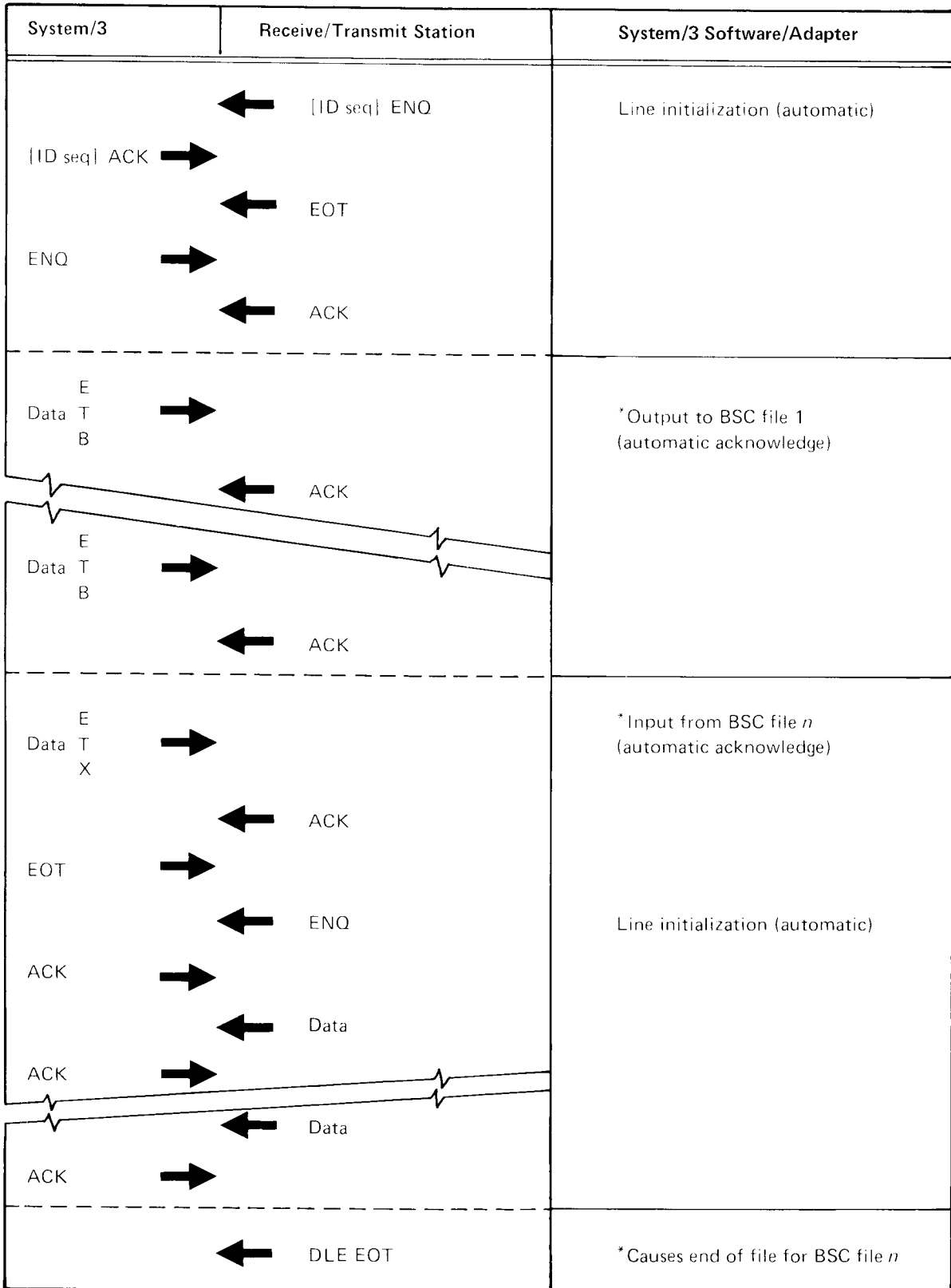

Receive/Transmit, System/3 Answer Station

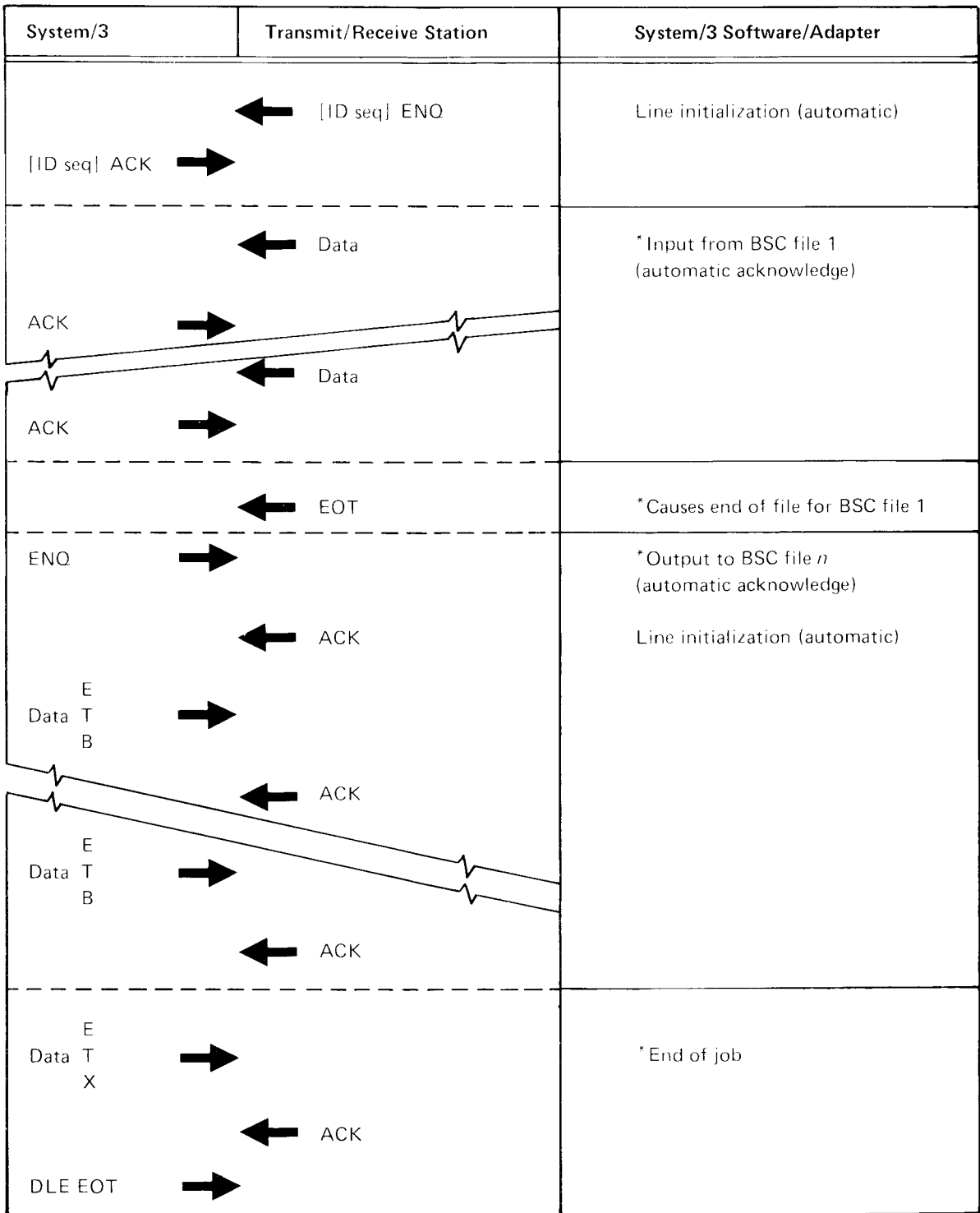

Receive/Transmit, System/3 Calling Station

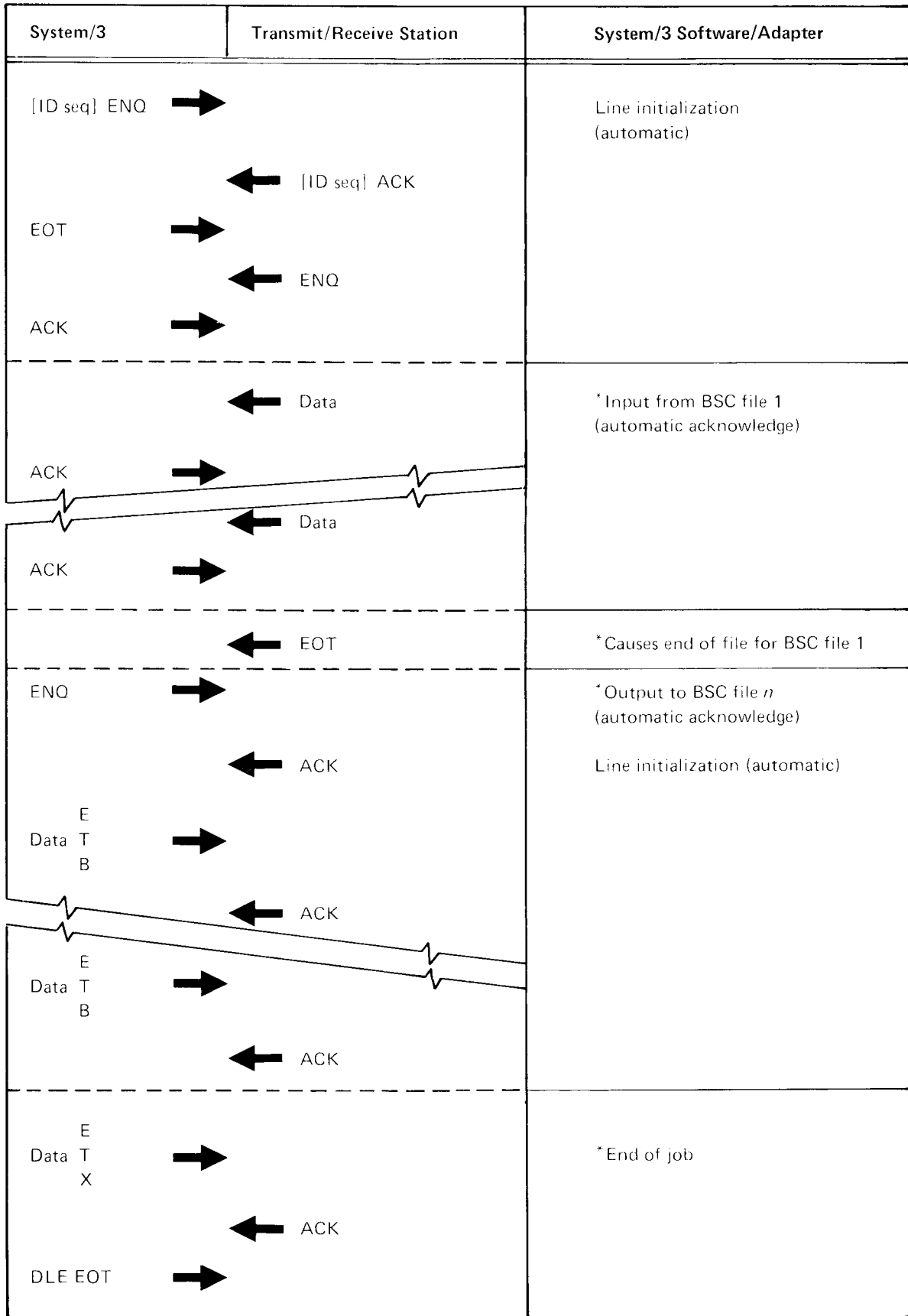

CONVERSATIONAL MODE

Receive with Conversational Reply

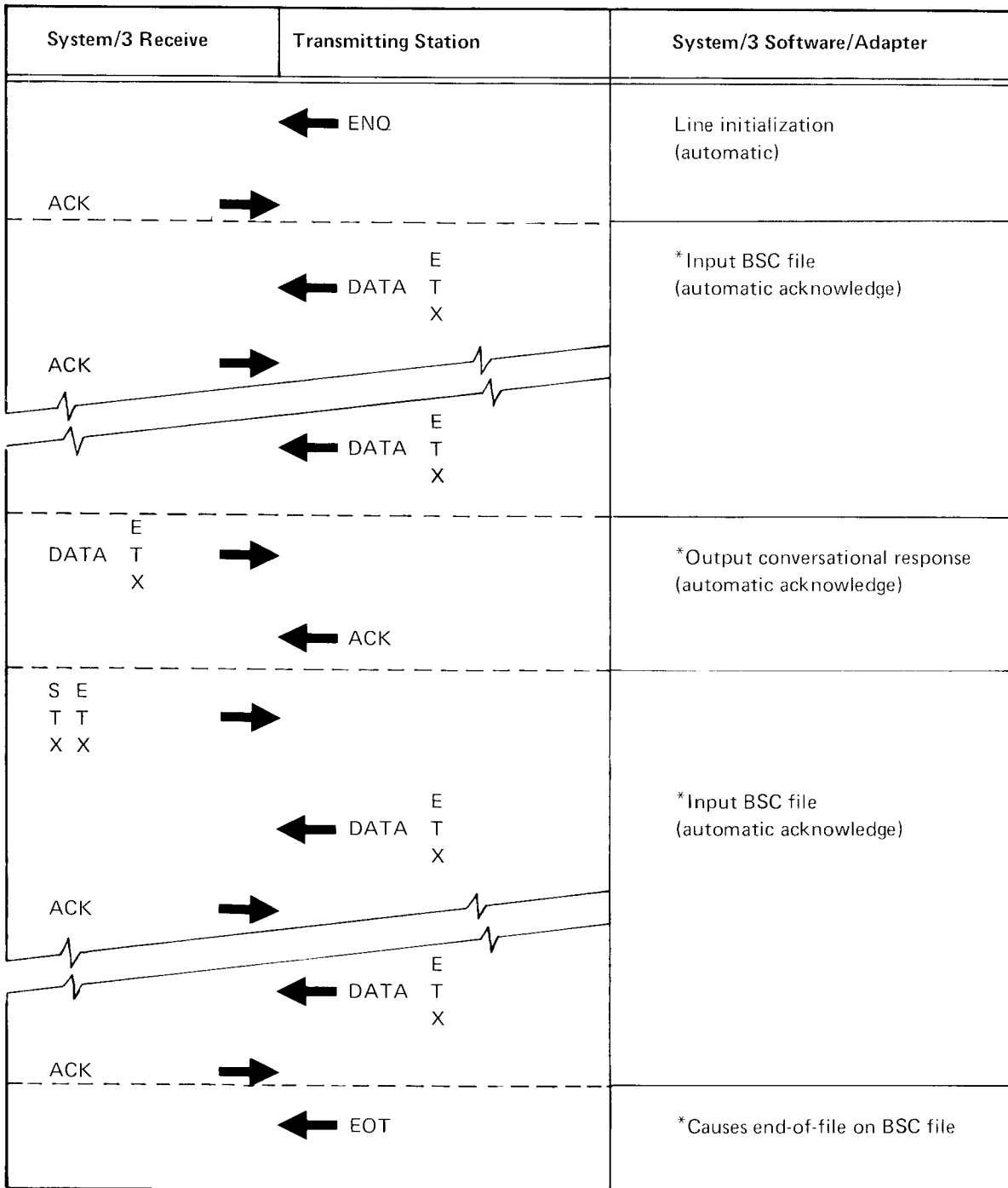

Transmit with Conversational Reply

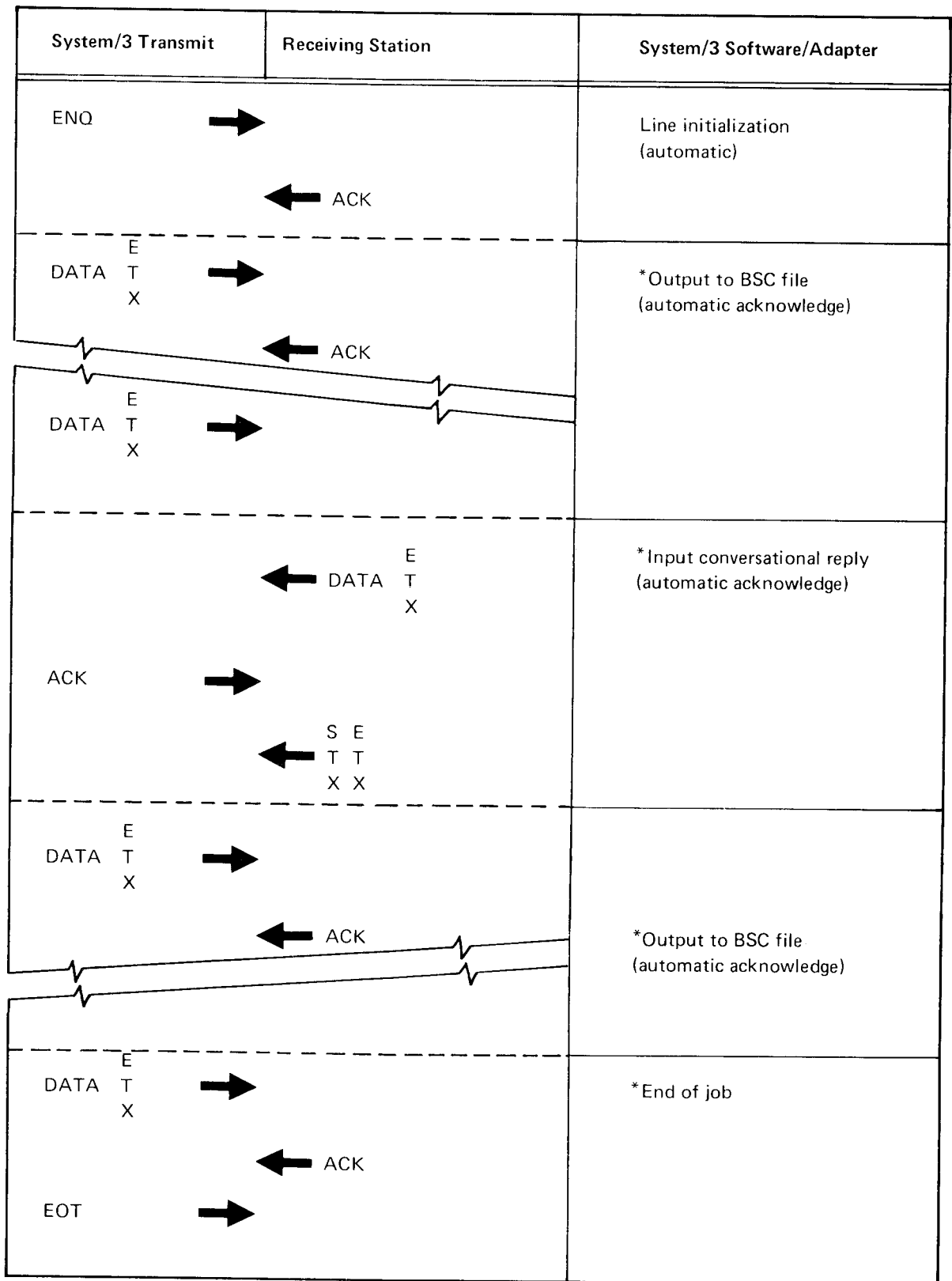

LINE CONDITION—SYSTEM/3 RESPONSES

Data Mode, System/3 Transmitting

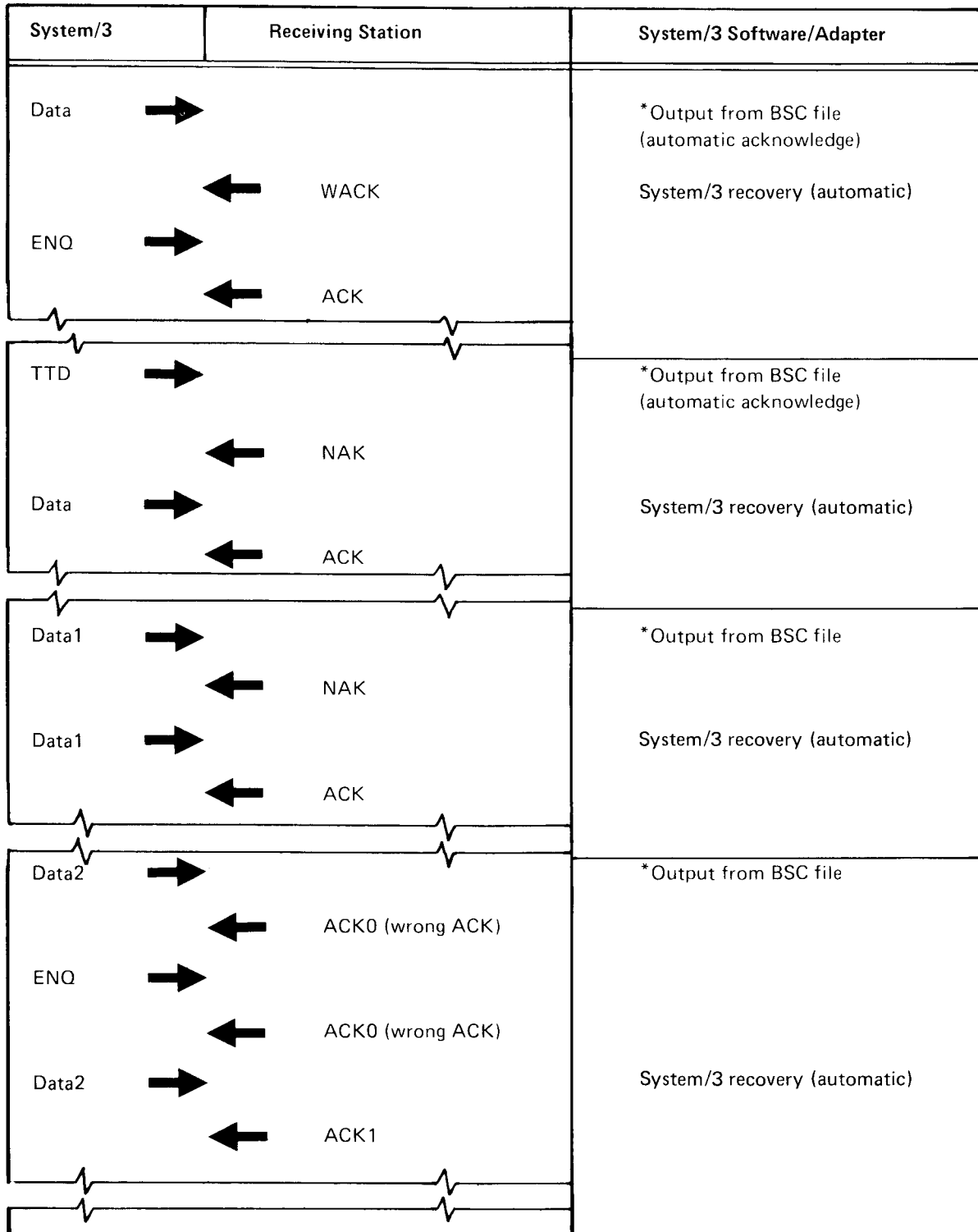

Data Mode, System/3 Transmitting (continued)

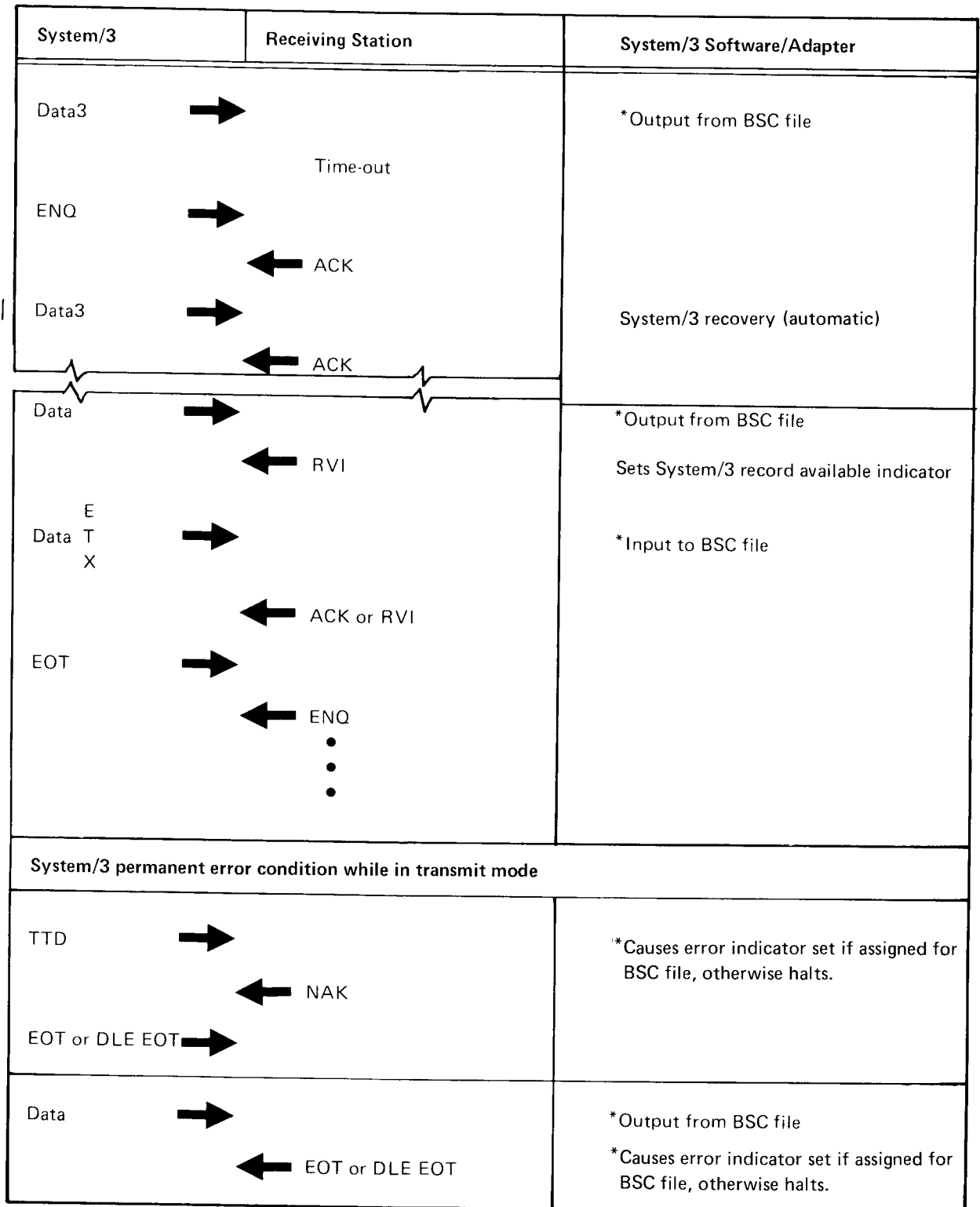

Data Mode, System/3 Receiving

| System/3 | Transmitting Station | System/3 Software/Adapter |
|---|---|---|
| NAK | <p>TTD Data ACK</p> | * Input from BSC file (automatic acknowledge) System/3 recovery (automatic) |
| WACK | <p>Data ENQ ACK</p> | * Input from BSC file System/3 recovery (automatic) |
| ACK | <p>Data1 Time-out ENQ Data1 ACK</p> | * Input from BSC file System/3 recovery (automatic) |
| NAK | <p>Data2 Data2 ACK</p> | * Input from BSC file System/3 recovery (automatic) |
| System/3 permanent error condition while in receive mode | | |
| EOT or DLE EOT | <p>Data EOT or DLE EOT</p> | * Input from BSC file * Causes error indicator set if assigned for BSC file, otherwise halts. |
| NAK | <p>TTD EOT or DLE EOT</p> | * Causes error indicator set if assigned for BSC file, otherwise halts. |

This glossary contains some terms that are used in this manual. Data processing and other communications terms are defined in *IBM Data Processing Glossary*, GC20-1699.

addressing: A request from the control station to a tributary station to receive data.

autoanswer: A machine feature that allows a called station to respond automatically to a call it receives over a switched line.

baud: A unit of measuring the number of data characters sent on a BSCA line in a given time.

binary synchronous communication: A flexible form of line control which provides a set of rules for communication between two devices.

called station: A station that accepts calls.

calling station: The station from which a call originates.

central station: See *control station*.

clocking: A procedure to control the number of data bits sent on a BSCA line in a given time.

control station: The primary or controlling computer in a multipoint telecommunications configuration. It controls the sending and receiving of data.

conversational file: A BSC file that allows receiving or sending data characters as an acknowledgment instead of the ACK0 or ACK1 character.

data link: The communications lines, modems (data sets), stations, terminals, and other communications equipment used for the transmission of data between stations.

data link control characters: The control characters used by the data link and the control station to notify each other of their status and the status of the data sent or received.

data link message: Data sent through BSCA using either EBCDIC or ASCII code.

data mode: A time at which the BSCA is transmitting or receiving characters on the line.

data set: See *modem*.

disconnect timeout: An indication that the BSCA station you were communicating with has gone on hook or hung up.

EBCDIC transparency: A provision that allows BSCA to send and receive messages containing any or all of the 256 character combinations in the EBCDIC code, including data link control characters.

error history file: A push-down stack of the last BSCA errors that have occurred.

full duplex: A BSCA network that allows for simultaneous transmission and reception of data.

half duplex: A two- or four-wire BSCA network that provides for data to be sent in only one direction at a given time.

half rate: A modem feature that provides for transmitting or receiving data at one-half the normal rate.

host: See *control station*.

intermediate block check (ITB): A provision that allows for parity checking on each logical record rather than the total buffer when large buffers of data are received.

line control characters: See *data link control characters*.

manual answer: The machine operator makes the data set ready.

manual dial: Dialing is performed by the machine operator.

master: The BSCA station that is transmitting.

modem: A hardware box used to connect the BSC adapter to the BSC line.

monitor mode: A time during which the BSC adapter is looking for synchronization characters.

multidropped terminal: See *tributary station*.

multipoint data link: More than two stations on a common transmission line or communication facility. Each station has the ability to monitor the transmission line at all times for activity or data that may be directed to it.

nonswitched line: A communication link between a remote station and computer that does not have to be established by dialing.

op end interrupt: A hardware-generated interrupt used to indicate the completion of the software-initiated BSCA input/output operations.

point-to-point data link: A communications facility that connects a single remote station to the computer.

polling: A request from the control station to a tributary station to transmit data. Once the tributary station has accepted the invitation, through recognition of its polling characters sent by the control station, the remote station may use the line to send data.

receive timeout: An indication that no data has been received by this BSC adapter in a given time.

receive initial: A software command to allow the BSC adapter to receive synchronization characters.

receive mode: A time during which the BSC adapter looks for synchronization characters and then stores the data characters in main storage.

remote terminals: Interconnected equipment at a remote location having either input or output capabilities or both.

reverse interrupt: A method of sending data records from one BSCA station to another station before receiving end-of-file indication from the other station.

slave: The BSCA station that is receiving.

standby line: A modem feature that allows a point-to-point leased line modem to also function on a point-to-point switched line.

station: Any of the computers, terminals, or devices that use the communication facilities.

switched line: A communication line in which the connection between the computer and a remote station is established by dialing.

transparency: See *EBCDIC transparency*.

transparent mode: A BSC adapter mode initiated by the sequence DLE STX.

tributary station: A secondary or noncontrolling device in a multipoint telecommunications configuration.

wrap test: A diagnostic procedure that transmits a specific character pattern to or through the modem in a loop and then compares the character pattern received to what was transmitted. It is used when unrecoverable BSCA hardware errors occur.

- access lines 5
- additional area entry 14
- addressing 5
- addressing characters 52, 54
- addressing characters entry 13
- American National Standard Code for Information Interchange 6, 47
- ASCII 6
- ASCII code chart 47
- autoanswer 6, 10
- autocall 6, 10

- block length entry 14
- block size 93
- BSC functions 15
 - telecommunications concepts 3
 - terminology 3
- BSCA station types 7

- central 5
- code type entry 9
- combined file 14
- comments line entry 9
- common carrier 5
- configuration entry 9
- considerations
 - conversational reply 27
 - programming 15
 - System/3 59
 - TCAM 74
 - 2770/2780 59
- control breaks and overflow 15
- control characters, data link 6, 49
- control sequence 6
- control station 5
- control type entry 9
- conversational mode
 - receive with conversational reply 110
 - transmit with conversational reply 111

- Data Communication System (2770) 1, 57
- data formats 15
- data link
 - control 6
 - control characters 6, 49
 - message codes 6
 - message formats 6
- data restrictions 15
- Data Station (3741) 75
- Data Transmission Terminal (2780) 1, 57
- dedicated lines 5
- demand file 14
- device entry 14
- dial number entry 10
- DOS 1, 7
- dual I/O areas 14

- EBCDIC 6
- EBCDIC code chart 48
- EBCDIC transparency 6
- end-of-file entry 14
- end-of-transmission 5, 6
- EOT 5, 6
- errors 16
- Extended Binary Coded Decimal Interchange Code 6, 48

- file description specifications sheet entries 17
 - BSC files 13
- file designation entry 14
- file format entry 14
- file name
 - file description entry 9, 13
 - telecommunications entry 9
- file type entry 13
- form type entry 8

- glossary 115

- identification
 - remote station entry 10
 - this station entry 10
- intermediate block checking entry 11
- intermediate block checking mode 6
- ITB 6, 11

- last file
 - entry 12
 - example 33
- leased lines 5
- leased multipoint, System/3 tributary station
 - receive 98
 - receive, transmit 101
 - transmit 99
 - transmit, receive 100
- line condition--System/3 responses
 - data mode, System/3 receiving 114
 - data mode, System/3 transmitting 112
- line number entry 8
- line protocol 93
- location of identification
 - remote station entry 10
 - this station entry 10

- manual answer 6, 10
- manual dial 6, 10
- message codes, data link 6
- message formats, data link 6
- multidropped terminal 5
- multipoint 5

- network control 5
- networks, telecommunications 3
- nonswitched 6
- nonswitched entry 9
- nonswitched network 5

- operating procedures 1
- OS 1, 7
- overflow, control breaks and 15

- page number entry 8
- permanent error indicator entry 11
- point-to-point 5
- point-to-point leased line
 - receive 93
 - receive/transmit 97
 - transmit 94
 - transmit multiple files 95
 - transmit/receive 96
- point-to-point switched line
 - ID seq: switched line station identification sequence optional
 - receive/transmit, System/3 answer station 108
 - receive/transmit, System/3 calling station 109
 - receive, System/3 answer station 102
 - receive, System/3 calling station 103
 - transmit/receive, System/3 answer station 107
 - transmit/receive, System/3 calling station 106
 - transmit, System/3 answer station 104
 - transmit, System/3 calling station 105
 - polling 5
 - polling characters 51, 52
 - polling characters entry 12
 - private lines 5
 - program identification entry 13
 - programming considerations 15
- READ operation code 65
- receive a file, then transmit a file program 36
- receive only program 16
- receive with transmittal of conversational reply program 20
- record available indicator
 - entry 12
 - use 41, 65
- record length entry 14
- remote device entry 13
- remote terminal entry 10
- reserved entry 13
- RPG II
 - BSCA programming 7
 - diagnostics 16
- RPG telecommunications specifications sheet 8

- specifications sheet, telecommunications 8
- specifications summary, teleprocessing 53
- station identification 5
- station identification entries 10
- station identification location entries 10
- station type entry 9
- station types, BSCA 7
- switched 5
- switched entry 10
- switched network 5
- Switching System (3750) 89

- TCAM (OS telecommunications access method) 1, 65
- TCAM considerations 74
- telecommunications
 - networks 3
 - specifications sheet 8
 - specifications summary 53

- transmit a file, then receive a file program 31
- transmit and receive (no conversational reply) 31
- transmit interspersed with receive program 41
- transmit only program 24
- transmit with reception of conversational reply program 27
- transparency entry 9
- transparency, EBCDIC 6
- tributary station 5
- type of
 - code entry 9
 - control entry 9
 - station entry 9

wait time entry 12

- 2770 Data Communication System 1, 57
- 2780 Data Transmission Terminal 1, 57
- 3741 Data Station 75
- 3750 Switching System 89

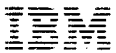

International Business Machines Corporation
General Systems Division
5775D Glenridge Drive N.E.
Atlanta, Georgia 30301
(USA Only)

IBM World Trade Corporation
821 United Nations Plaza, New York, New York 10017
(International)

READER'S COMMENT FORM

IBM System/3
RPG II Telecommunications
Programming
Reference Manual

SC21-7507-5

YOUR COMMENTS, PLEASE . . .

Your comments assist us in improving the usefulness of our publications; they are an important part of the input used in preparing updates to the publications. All comments and suggestions become the property of IBM.

Please do not use this form for technical questions about the system or for requests for additional publications; this only delays the response. Instead, direct your inquiries or requests to your IBM representative or to the IBM branch office serving your locality.

Corrections or clarifications needed:

Page *Comment*

I would like a reply.

Name _____

Address _____

- Thank you for your cooperation. No postage necessary if mailed in the U.S.A.

Cut Along Line

IBM System/3 RPG II Telecommunications (File No. S3-28) Printed in U.S.A. SC21-7507-5

Fold

Fold

FIRST CLASS
PERMIT NO. 387
ROCHESTER, MINN.

BUSINESS REPLY MAIL

NO POSTAGE STAMP NECESSARY IF MAILED IN THE UNITED STATES

POSTAGE WILL BE PAID BY . . .

IBM Corporation
General Systems Division
Development Laboratory
Publications, Dept. 245
Rochester, Minnesota 55901

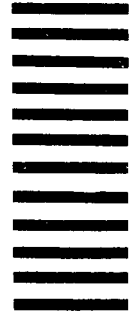

Fold

Fold



International Business Machines Corporation
General Systems Division
5775D Glenridge Drive N.E.
Atlanta, Georgia 30301
(USA Only)

IBM World Trade Corporation
821 United Nations Plaza, New York, New York 10017
(International)



This Newsletter No. SN21-5428
Date 24 September 1976
Base Publication No. SC21-7507-5
File No. S3-30
Previous Newsletters None

IBM System/3 RPG II Telecommunications Programming Reference Manual

© IBM Corp. 1969, 1970, 1971, 1972, 1973, 1975

This technical newsletter, a part of version 05, modification 00, of the IBM System/3 Model 15 RPG II, version 02, modification 00, of the IBM System/3 Model 12 RPG II (Program Product 5704-RG2), and version 01, modification 00 of IBM System/3 System Control Program (Program Product 5704-SC2), provides replacement pages for the subject publication. These replacement pages remain in effect for subsequent versions and modifications unless specifically altered. Pages to be inserted and/or removed are:

- Cover, Edition Notice
- iii through vi
- 1, 2
- 9, 10
- 15 through 18
- 41, 42
- 75 through 78
- 87 through 92
- 111 through 114
- Back Cover
- Reader's Comment Form, Business Reply

Changes to text and illustrations are indicated by a vertical line at the left of the change.

Summary of Amendments

Changes effected by Program Number 5704-RG2 and other miscellaneous changes have been added.

Note: Please file this cover letter at the back of the manual to provide a record of changes.



Technical Newsletter

This Newsletter No. SN21-5624

Date 30 June 1978

Base Publication No. SC21-7507-5

File No. S3-30

Previous Newsletters SN21-5428

IBM System/3 RPG II Telecommunications Programming Reference Manual

© IBM Corp. 1969, 1970, 1971, 1972, 1973, 1975

This technical newsletter applies to the current versions and modifications of the applicable System/3 programs listed in the edition notice and provides replacement pages for the subject publication. These replacement pages remain in effect for subsequent versions and modifications unless specifically altered. Pages to be inserted and/or removed are:

| | |
|---|---------------------------|
| Cover, Edition Notice | 75, 76 |
| 9, 10 | 80.1 through 80.4 (added) |
| 10.1, 10.2 (added to accommodate moved text) | 83, 84 |
| 11, 12 | 87, 88 |
| 35, 36 | 89, 90 (deleted) |

Changes to text and illustrations are indicated by a vertical line at the left of the changes.

Summary of Amendments

Miscellaneous technical changes

Note: Please file this cover letter at the back of the manual to provide a record of changes.

IBM Corporation, Publications, Department 245, Rochester, Minnesota 55901

© IBM Corp. 1978

Printed in U.S.A.



International Business Machines Corporation
General Systems Division
5775D Glenridge Drive N.E.
Atlanta, Georgia 30301
(USA Only)

IBM World Trade Corporation
821 United Nations Plaza, New York, New York 10017
(International)

READER'S COMMENT FORM

IBM System/3
RPG II Telecommunications
Programming
Reference Manual

SC21-7507-5

YOUR COMMENTS, PLEASE . . .

Your comments assist us in improving the usefulness of our publications; they are an important part of the input used in preparing updates to the publications. All comments and suggestions become the property of IBM.

Please do not use this form for technical questions about the system or for requests for additional publications; this only delays the response. Instead, direct your inquiries or requests to your IBM representative or to the IBM branch office serving your locality.

Corrections or clarifications needed:

Page *Comment*

I would like a reply.

Name _____

Address _____

- Thank you for your cooperation. No postage necessary if mailed in the U.S.A.

Cut Along Line

Fold

Fold

FIRST CLASS
PERMIT NO. 387
ROCHESTER, MINN.

BUSINESS REPLY MAIL
NO POSTAGE STAMP NECESSARY IF MAILED IN THE UNITED STATES



POSTAGE WILL BE PAID BY . . .

IBM Corporation
General Systems Division
Development Laboratory
Publications, Dept. 245
Rochester, Minnesota 55901

Fold

Fold

IBM System/3 RPG II Telecommunications (File No. S3-30) Printed in U.S.A. SC21-7507-5



International Business Machines Corporation
General Systems Division
5775D Glenridge Drive N.E.
Atlanta, Georgia 30301
(USA Only)

IBM World Trade Corporation
821 United Nations Plaza, New York, New York 10017
(International)