

TROUBLESHOOTING THE IBM SELECTRIC TYPEWRITER

Includes
IBM
Selectric III

by
R. L. SUMMERS

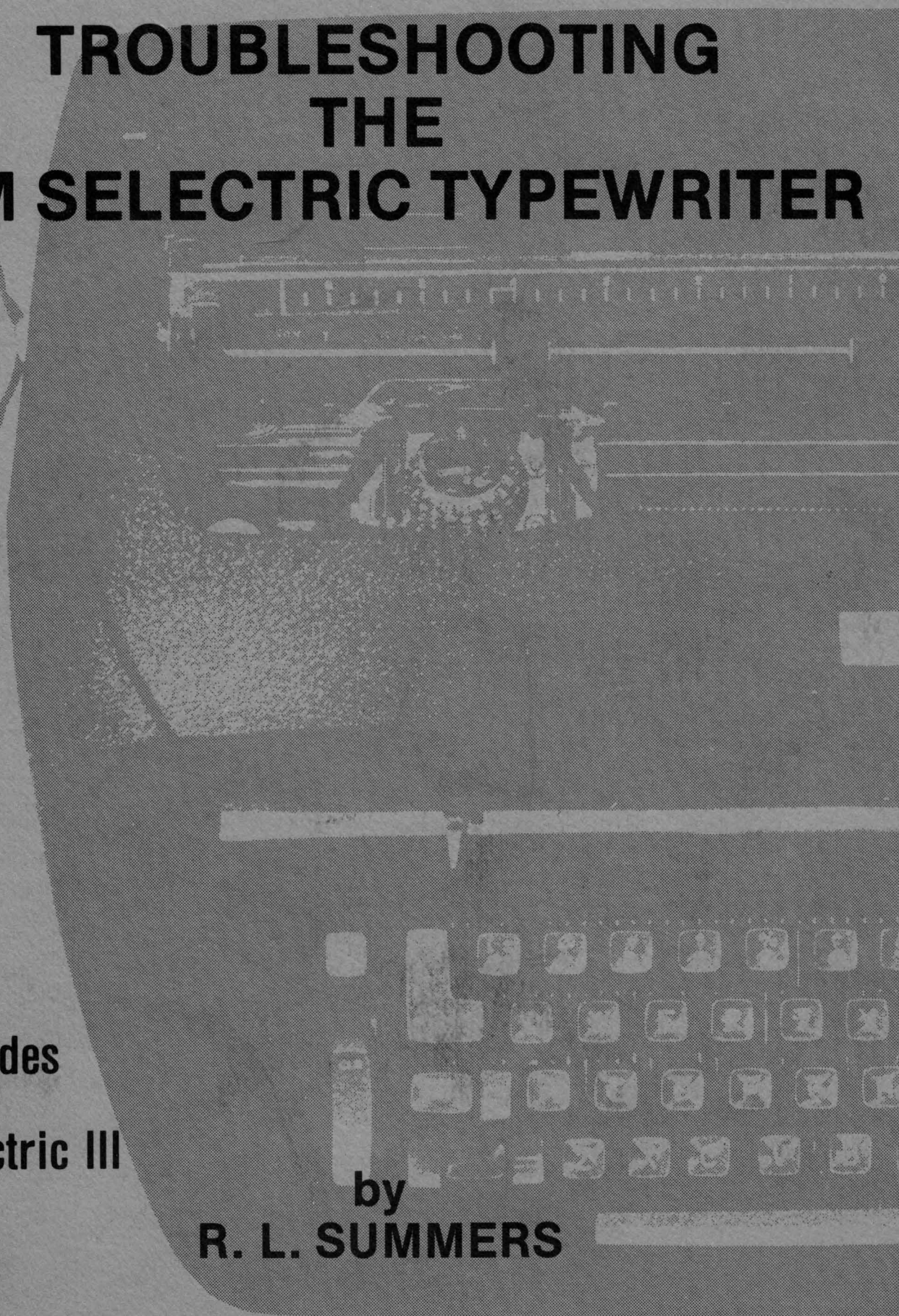

TROUBLESHOOTING The IBM SELECTRIC® TYPEWRITER



**PUBLISHED BY R.L. SUMMERS — SANTA ANA, CALIFORNIA 92712
PRINTED BY BEARD PUBLISHING CO. — SANTA ANA, CALIFORNIA 92706**

"IBM" AND "SELECTRIC" ARE REGISTERED TRADEMARKS OF THE INTERNATIONAL BUSINESS MACHINES CORPORATION

Copyright © 1976, Revision 1981

R.L. SUMMERS
Santa Ana, California

All Rights Reserved

This manual or any parts thereof may not be reproduced in any form or in any language without permission.

ORDER COPIES OF THIS MANUAL FROM:

SUMCO
P. O. Box 12190
Santa Ana, California 92712

This troubleshooting manual is intended primarily for technicians and students.

The photographs or illustrations contained in this manual should be studied in connection with the troubleshooting material and are of great assistance in locating parts and adjustments.

The figures or photographs in this manual are denoted as follows: (120-19) - The 120 denotes the figure, and 19 denotes a part within that figure.

The author of this manual has spent many years teaching students the repair of the IBM Selectric typewriter in vocational schools and private industry.



IBM Selectric III

CONTENTS

ALIGNMENT SECTION	2
BACKSPACE	13
CARRIER RETURN	22
CORD TENSION PULLEY ADJUSTMENT	100
CORRECTABLE TAPE	28
CROWDING	35
DETENTING, HOW TO CHECK	12
ESCAPEMENT & escapement bracket illustration	185, 41
EXCESSIVE HEADPLAY	44
EXPRESS BACKSPACE	20
EXTRA PRINT CYCLES	45
FLICKING	101, 62
HALF PRINTING	46
IMPRESSION OF CHARACTERS	50
INDEX	52
KEYBOARD	57
LOCKED MACHINE	56
MALSELECTION	63
MARGIN UNEVEN	25
NOISE	68

RIBBON	73
ROTATE ALIGNMENT	83
SHIFT	85
SKIRT CLEARANCE	11
SLUGGISH MACHINE	92
SPACEBAR	93
SPECIAL SECTION	
Cord tension pulley adjustment	100
Flicking	101, 62
TABULATION	102
TILT ALIGNMENT	109
TIMING	2

Troubleshooting the Selectric typewriter, properly, requires a thorough and systematic approach.

One point I can't reiterate on enough, is that, the selectric typewriter is a sequence adjustment machine. This means that any adjustments made, usually, affects other adjustments.

Repeat service calls are caused by not understanding the problem, or by trying to correct the problem with the incorrect adjustments.

There are certain basis steps that should be followed in troubleshooting:

1. Quiz the operator about the circumstances that caused the problem, in other words, ask the operator to duplicate what she was doing when the problem occurred.
2. Closely examine any samples of the problem, looking for a pattern or systematic failure.
3. Verify that there is a problem - if possible.
If a problem cannot be reproduced, check all adjustments that could produce that symptom.
4. Use the most appropriate troubleshooting chart in this book to see which adjustments should be made or to help trace the cause of the failure.
5. When the problem has been corrected properly; check and adjust any other functions that were affected by this correction.
6. Give the typewriter a complete operational check and have the operator try the machine.

Before correcting any adjustments, you should be able to explain why you are making the adjustment, and how it will eliminate the problem.

THINK BEFORE YOU ACT

ALIGNMENT SECTION

If this section is followed closely, it will guide you from gear train thru rotate alignment.

I. GEAR TRAIN

There are many ways that have been tried in the adjustment of the gear train (47). To eliminate guess work, as a preliminary step, loosen all gears in the gear train. This permits 360° rotation of the gears to ensure there are no binds.

After all gears are loose:

1. Adjust the lower idler gear (47-36) for maximum mesh, no binds between filter shaft gear (47-34) and cycle clutch gear (47-35).
2. Adjust upper idler gear (47-37) for maximum mesh, no binds between lower idler gear (47-36) and print shaft gear (47-38).

II. ADJUST CYCLE SHAFT, FILTER SHAFT, PRINT SHAFT TIMING

1. Tighten cycle clutch gear, observing full lateral mesh and enough clearance between cycle clutch gear (47-35) and cycle clutch left bearing to prevent binds.

NOTE: Remember, the cycle clutch gear does not control the end play of the cycle shaft. The end play is controlled by shims (1-1) on early level machines and by a collar on late level machines.

2. Rotate the cycle shaft until:
 1. the high lobe on the negative 5 cam (124-18) is approximately vertical, and until
 2. the cycle clutch check ratchet (124-19) is backed up against the cycle clutch check pawl (124-20).

When the above two conditions are met, the cycle shaft is in the rest position.

When the cycle shaft is in the rest position, you are ready to adjust the filter shaft (55) and the print shaft (70-39).

3. Adjust the filter shaft for .015" clearance between a latched down interposer and the filter shaft. Observe clearance between the filter shaft gear (47-34) and filter shaft left bearing when the filter shaft gear is tighten.
4. Adjust the print shaft (70-39) so the keyway is in line with the per-trussion (41-21) on the left side of the carrier. (This is only a preliminary adjustment).
5. Next, you have to perform a very important step; rotate the cycle clutch spring to the rest position.
 1. Using the pusher end of a spring hook, rotate the turned up ear (136-30) on the left end of the cycle clutch spring top to front until the turned up ear (136-31) on the right end of the cycle clutch spring is resting down against the bottom edge of the window in the cycle clutch sleeve (136-32).

NOTE: For a check to see if the cycle clutch spring is at rest, do the following:

1. With your turning wheel, slightly rotate the machine top to front, while observing the cycle shaft; If
 1. the cycle clutch spring is at rest, the cycle clutch shaft will remain stationary.
 2. the cycle clutch spring is not at rest, the cycle clutch shaft will start to rotate also.

If the cycle clutch shaft starts to rotate, STOP!

If the cycle clutch shaft moved, it is no longer at the rest position. Therefore, the cycle clutch shaft must be returned to the rest position.

In order to return the cycle clutch to the rest position, do the following:

1. With your fingers, rotate the print shaft top to front, until the cycle clutch ratchet (124-19) is backed up against the cycle clutch check pawl (124-20). The cycle clutch shaft is now back in the rest position.

If the cycle clutch had to be reset, go back to adjustment 5.

If the cycle shaft did not move, go to adjustment 6.

6. Adjust for .010" clearance between the cycle clutch pulley hub(136-33) and the cycle clutch spring (136-30).
7. Adjust for .015" clearance between the cycle clutch pulley hub(136-33) and the cycle clutch sleeve (136-32). *Then go to 1 below.*
8. *A. Too much movement - Grab print shaft and slightly rotate top to rear.
B. Not enough movement - Slightly rotate print shaft top to front, then push down on left ear (136-30) of Spring. After A or B go to 1 below.*
9. Adjust the cycle clutch overthrow stop left to right (63-25) for .010" clearance between overthrow stop (63-25) and cycle clutch sleeve (63-24).
At the same time, radially adjust a clearance of .010" between the cycle clutch sleeve and overthrow stop (63-28). Tighten the clamp (63-26).

TO CHECK ADJUSTMENT OF CYCLE CLUTCH SPRING, DO FOLLOWING:

1. Depress the bracket keybutton and rotate the cycle shaft, with the turning wheel, until the cycle shaft stops rotating.
2. Depress the bracket keybutton again; lay your finger on the cycle clutch check pawl (124-20).
Rotate the turning wheel slowly, while observing the movement of the print shaft gear (47-38) - the gear should rotate 1/2 to 1 tooth as the cycle clutch check pawl (124-20) falls under the cycle clutch ratchet (124-19).

If the cycle clutch spring adjustment is not correct, go back to adjustment 8. *If the cycle clutch spring is correct, go back to adjustment 9.*

NOTE: When the cycle shaft is rotated with the turning wheel, the cycle clutch check pawl (124-20) should not fall under the cycle clutch ratchet (124-19). The check pawl should fall under the ratchet only under power.

ROTATE & TILT ALIGNMENT

The purpose of this section is to relay a procedure on the adjustment of the tilt and rotate alignment system.

Under normal wear, the following procedure has proven successful for the past decade.

If there is a problem being experienced with alignment, it is advisable to start adjustments with the gear train.

Before starting adjustments rotate (horizontal) alignment, a preliminary adjustment of the rotate link (123-15) should be made. Adjust rotate link buckel (123-16) so there is an equal amount of threads on each side of buckel.

The adjustment of the rotate system has to be made in the upper case position. This has to be done because the detenting of the upper case and the lower case should be the same.

The adjustment of the shift motion by the stop screw (85-26) controls the rotate detenting of the lower case - the stop screw is adjusted to match lower case detenting to upper case detenting.

There is no way to adjust the upper case to match the lower case; therefore the machine is adjusted in upper case.

If a machine is having problems with the alignment or detenting, it is also advisable to perform the adjustments in the cycle clutch and shift section prior to advancing.

The following section has been included to give you a better explanation of the adjustments required for ROTATE, TILT and TIMING.

INTERPOSER STOP LUGS & SELECTOR LATCH LINKS

When the filter shaft contacts the interposer (55), the transfer of that motion is for the operation of the selector latches (40-26).

It is good practice to have maximum overlap of the selector latches (40-26) over the bail (51-27).

A good method to check for lost motion is to lay your finger on each latch, in turn, while picking up on each corresponding latch bail with a spring hook. When you pick up on the latch bails, the selector latch should move simultaneously.

SELECTOR LATCHES

The selector latches (125-28) should fall under the bail (51-27) as the cycle clutch check pawl (124-20) resets. Also, the negative 5 latch (72-41) should reset over the negative adjusting screw (72-42) as the cycle clutch check pawl resets (124-20).

The ideal situation is to adjust the stop pads (40-25) up and down so the latches fall under the bail (51-27) at the same precise time the cycle clutch check pawl resets (124-20). It is not likely for this to happen, so if the latches (125-28) reset before the cycle clutch check pawl, this is acceptable.

The stop latch pads, which are the upper limits for the latches, are adjusted up and down, by forming, using a screwdriver and hammer.

NEGATIVE 5 BAIL & STOP SCREW

When the cycle clutch shaft (1) is in the rest position, the negative 5 latch bail (125-29) is held down by the negative cam (124-18) and not the negative 5 latch (72-41). When the stop screw is adjusted, it should allow the negative 5 latch to reset over the stop screw. When the cycle shaft is at rest, there should be minimum clearance between the negative 5 latch (72-41) and the negative 5 latch screw (72-42).

When the cycle shaft is rotated, the negative cam (124-18) allows the negative bail (72-27) to move upward until the negative 5 stop screw (72-42) contacts the negative 5 latch (72-41).

The greater distance the negative bail has to move before it contacts the stop screw, the more it will effect rotate alignment.

ROTATE SPRING TENSION

The tension of the rotate spring (46-33) is a very important adjustment. If there is not enough tension in the rotate system, there may not be enough rotational torque to properly detent negative characters such as the x, m, and g.

The rotate spring tension should be approximately 2 pounds, measured with a spring gage.

To check rotate spring tension (46-33), do the following:

1. Remove the typing element.
2. Half cycle a lower case "m".
The lower case "m" is used because the tension of the rotate system in that position is the least it will ever be.
3. Attach the spring gage to the shift arm (126-30) and push the shift arm outward from the side frame. Slowly, allow the shift arm to return to the side frame; as the shift arm contacts the side frame the gage should measure approximately 2 pounds.

To increase the rotate spring tension, rotate the spring cage(46-33) clockwise.

To decrease the spring tension, rotate spring cage counterclockwise. In order to decrease the spring tension, you must release the spring cage detent (127-31) before rotating the cage counterclockwise.

TILT ALIGNMENT

There are two adjustments to be concerned about for tilt alignment. For the two adjustments, use the "Z" and "J" characters; using the "Z" and "J" gives a tilt 0 and a tilt 3 respectively, which are the extreme limits for tilt operation.

All that you are concerned about is that the "Z" and "J" detent the same, nothing else.

Adjustments:

1. Half cycle the machine - engage tilt detent (37-3) with tilt ring(39-23)
2. Remove detents (37-3) from engagement with tilt ring by pushing the detent actuating lever(38-44) to the left.
3. Remove tilt ring play by pushing down on front of tilt ring.
4. Slowly, let tilt detent (37-3) engage tilt ring (39-23) and observe where detent contacts tilt ring.
5. Adjust tilt link (87-29) up and down for equal detenting of "Z" and "J".
6. Adjust right hand pulley (88-27) so the tilt detent (37-3) enters the proper tooth on tilt ring (39-23) approximately 1/3 distance from the vertex.

TYPEHEAD HOMING

Typehead homing is nothing more then half cycling the machine to see if the rotate detent enters the proper tooth on the element.

Half cycle the letter "J", if the rotate detent (37-4) enters the proper tooth, the letter "J" will be facing the platen (130-30). No adjustment necessary.

If the detent enters the wrong tooth on the element, do the following:

1. Half cycle a letter "J".
2. Loosen the set screw for the rotate shaft - the set screw is under the carrier (43-30).
3. With your fingers, rotate the element so the "J" is facing the platen.
4. Release detent actuating lever to reengage detent with element.
5. Tighten the set screw (43-30) observing minimum end play of rotate shaft.

Sometimes the rotate shaft is frozen and difficult to move when trying to reposition element to proper tooth - if this happens, tap the bottom of the rotate shaft lightly with a screwdriver and hammer.

BALANCE ARM

The adjustment of the balance arm (40-31) is to achieve proper balance in the differential system between positive and negative operations.

To adjust the balance arm, do the following:

1. Depress and half cycle the letter "J" - observe the detenting, see where detent contacts element on negative slope.
2. Depress the letter "B" - rotate the turning wheel until the cycle shaft starts to move - STOP!
3. Pull out the negative 5 latch and continue the rotation of the turning wheel until the element is half cycled; a letter "T" should be facing the platen.
4. Check detenting; the letter "T" and the cancelled "B" should detent the same. If they do not detent the same, do the following:

Loosen balance arm locking screw and nut (40-31) - adjust balance arm left or right.

To check- go back to 1.

ROTATE ARM MOTION

1. Depress the letter "M" and half cycle the machine. With the play removed in the negative direction, check where detent contacts the element tooth.
2. Depress the letter "W" and half cycle the machine. With the play removed in the negative direction, check where detent contacts the element tooth.

If the two characters "M" and "W" don't detent the same, adjust the stud (87-31) up and down until they do.

ROTATE LINK

After the adjustment of typehead homing, balance arm and rotate arm, check the detenting of characters W, O, M, and T - they should all detent the same. The point to understand, is that, it doesn't matter where the detent contacts the element; just so all the characters contact the element at the same point or they all detent the same.

After they are detenting the same - adjust the rotate link (123-15) with the rotate link turn buckel (123-16) until a half cycled letter "G" detents .015" down the negative slope. (Similiar to figure 131).

SHIFT MOTION

With machine in the lower case position, adjust the shift arm stop screw (85-26) so a half cycled "g" detents the same as a half cycled upper case "G".

FINE TIMING

To check fine timing:

1. Depress the letter "M" and slowly rotate the turning wheel until the detent (37-3) enters the tooth and starts to exit; when the detent exits the tooth it should gently touch the positive side of the tooth (132-32).

To adjust:

1. Loosen the print shaft gear (47-38).
2. Rotate the print shaft, top to rear or top to front to achieve the correct adjustment.

ROTATE SYSTEM WITHOUT ADJUSTABLE BALANCE ARM

When the balance arm adjustment was eliminated, it became necessary for a change in the rotate adjustment procedure for those machines.

Having the knowledge of two methods of adjusting the rotate system is always a benefit to the technician.

It is possible to use this procedure on IBM Typewriters that have the adjustable balance arm.

In order to use this procedure on the earlier machines that still have the compensation arm, you must;

1. Cripple the rotate arm, using the procedure in the IBM Manual.
2. Preset the adjustable balance arm so the inner arm aligns to the left by half the width of the notch in the outer arms as shown in figure 143.
3. Preset the negative 5 (-5) stop screw with the cycle shaft at rest. Adjust the screw until it contacts the stop - then backoff $\frac{1}{2}$ turn. Rotate the cycle shaft and check both sides of the -5 cam to be sure the -5 latch drops over the screw.
4. Adjust the rotate arm, with the turnbuckle (123-16) to the #1 scribe line on hooverometer. Because the IBM Selectric III typewriters have a different cut on the negative cam to give it 6 units of motion, the rotate arm should be preset 1 unit more positive to prevent interference. One way to approximate this adjustment is to divide the distance between position 1 and position 2 on the hooverometer into 5 increments. Then adjust the rotate arm to the 1st increment past the #1 mark.

I. TYPEHEAD HOMING

Half cycle an upper case "O" , If the rotate detent (37-4) enters the proper tooth; No adjustment necessary.

If the detent enters the wrong tooth on the element., do the following:

1. Half cycle a letter "O".
2. Loosen the set screw for the rotate shaft.
(The set screw is under the carrier (43-30).
3. With your fingers, remove the detents and rotate the element so the "O" is facing the platen.
4. Release detent actuating lever (71-39) to reengage detent (37-4) with element.
5. Tighten the set screw (43-40) observing minimum end play of the rotate shaft. (42-27)
(Sometimes the rotate shaft is frozen and difficult to move when trying to reposition element to the proper tooth; If this happens, tap the bottom of the rotate shaft lightly with a screwdriver & hammer.)

II. BALANCE ARM

The adjustment of the balance arm (40-31) is to achieve proper balance in the differential system between positive and negative operations.

To adjust the balance arm do the following:

1. Depress and half cycle the letter "J" - observe the detenting, see where detent contacts element on negative slope.
2. Adjust the stop screw (72-42) for the negative 5 bail so the "J" detents like the "O".

III. ROTATE ARM

1. Depress the letter "M" and half cycle the machine. With the head play removed in the negative direction, check where detent contacts the element tooth.
2. Depress the letter "W" and half cycle the machine. With the play removed in the negative direction, check where detent contacts the element tooth.

If the two characters "M" & "W" don't detent the same, adjust the stud (87-31) up and down until they do.

IV. ROTATE LINK

After the adjustment of typehead homing, balance arm and rotate arm, check the detenting of characters W, O, M, and J - they should all detent the same. The point to understand, is that, it doesn't matter where the detent contacts the element; just so all the characters contact the element at the same point or they all detent the same.

V. FINE TIMING

To check fine timing:

1. Depress the letter "M" and slowly rotate the turning wheel until the detent (37-4) enters the tooth and starts to exit; when the detent exits the tooth it should gently touch the positive side of the tooth (132-32).

To adjust:

1. Loosen the print shaft gear (47-38).
2. Rotate the print shaft top to rear or top to front to achieve the correct adjustment.

VI. SHIFT MOTION

With machine in lower case position, adjust the shift arm stop screw (85-26) so a half cycled "g" detents the same as a half cycled upper case "G".

IBM SELECTRIC III ROTATE SYSTEM ADJUSTMENTS
PROCEDURE FOR ADJUSTING TRIPLE LUG HEAD HOLDER WITH ADJUSTABLE ROTATE LINK

I. TYPEHEAD HOMING

Half cycle the underscore, if the detent enters the proper tooth;
No adjustment necessary.

If the detent enters the wrong tooth of the element, do the following:

1. Half cycle the underscore.
2. Raise the element lever (144), push down on element and loosen the upper ball socket screw (144-1).
3. Rotate the element so the underscore faces the platen.
4. Hold the element so it does not move and tighten the upper ball socket screw (144-1).

(When you tighten the screw, the adjustment of the element tends to move - you can refine the adjustment later with the rotate link.)

II. BALANCE ARM

To adjust the balance arm, do the following:

1. Half cycle the letter "P" - Observe the detenting and see where the detent contacts the element on the negative slope.
2. Adjust the stop screw (72-42) for the negative 6 bail so the "Y" detents like the "P".

III. ROTATE ARM

1. Depress the underscore and half cycle the machine. With the play removed in the negative direction, check where the detent contacts the element tooth.
2. Depress the comma (,) and half cycle the machine. With the play removed in the negative direction, check where detent contacts the element tooth.

If the two characters, the underscore and the comma don't detent the same, adjust the stud (87-31) up and down until they do.

IV. ROTATE LINK

After the adjustment of the typehead homing, balance arm and rotate arm, check the detenting of characters "P", "Y", "_" (Underscore) and Comma (,). They should all detent the same.

After they are detenting the same - adjust the rotate link (123-15) with the rotate link turn bucket (123-16) until the characters detent .015" down the negative slope. (Similiar to figure 131)

V. SHIFT MOTION

With machine in the lower case position, adjust the shift arm stop screw (85-26) so a half cycled "p" detents the same as a half cycled Upper case "P".

VI. FINE TIMING

To check fine timing:

1. Depress the letter "M" and slowly rotate the turning wheel until the detent (37-4) enters the tooth and starts to exit; When the detent exits the tooth it should gently touch the positive side of the tooth (132-32).

To adjust:

1. Loosen the print shaft gear (47-38).
2. Rotate the print shaft, top to rear or top to front, to achieve the correct adjustment.

SKIRT CLEARANCE

What is skirt clearance:

Skirt clearance is the distance between a tooth on the element and the rotate detent, when element is held in a tilt two position (133).

When skirt clearance is adjusted, it affects the adjustment clearance of .001" between detent lever (71-40) and detent actuating lever(71-39).

Therefore, the two adjustments should be performed alternately until both are correct.

Skirt clearance adjustment:

1. Loosen ribbon feed and detent cam (106-18) and adjust laterally until there is .025" clearance between rotate detent and a tooth on the element, when element is held in a tilt two position (133).

Detent clearance adjustment:

1. Loosen locking nut (133-34); adjust screw (133-35) up or down for .001" clearance between detent lever (71-40) and detent actuating lever (71-39).

HOW TO CHECK DETENTING OF THE ELEMENT

How to check the proper detenting of the element seems to be a widely misunderstood procedure.

To check detenting, simply do the following:

1. Half cycle a letter "J". (With a letter "J" half cycled, it should look like Figure (130).
2. With your finger, remove the rotate detent from the element by pushing the detent actuating lever (38-44) to the left. (The front of the machine is the reference for these adjustments).
3. Remove the headplay in the negative or clockwise direction and allow the rotate detent to reenter the tooth of the element - observe where the detent contacts the element - it should look similar to Figure 131.

BACKSPACE

SYMPTOM	POSSIBLE CAUSE	REMEDY	REMARKS
<p>1. Machine will not backspace</p>	<p>1. Not enough backspace rack motion (9-4)</p> <p>2. Carrier binding on dust cover (12-1)</p> <p>3. Card holder binding on platen (13-1)</p> <p>4. Tab overthrow stop (9-5) hitting tab rack (14-10).</p> <p>5. Cords off pulley</p> <p>6. Binds in backspace rack or teeth on rack missing.</p> <p>7. Return spring for backspace rack broken or missing (7-9)</p>	<p>a) Adjust clearance between cam follower (10-5) and backspace latch (10-7).</p> <p>b) Intermediate lever broken or maladjusted (11-1)</p> <p>Check and adjust covers and cover latches.</p> <p>Adjust card holder.</p> <p>Adjust tab overthrow stop for clearance between the tab trigger and tab overthrow stop.</p> <p>Check and replace cords on all pulleys.</p> <p>Observe all teeth on rack (9-4)</p> <p>Replace or repair spring (7-9)</p>	<p>Adjust latch clearance for minimum clearance - no binds (10-8)</p> <p>Some dust covers may have to be formed.</p> <p>Check with four copies of paper in machine and multiple copy lever in #1 position.</p> <p>To adjust:</p> <ol style="list-style-type: none"> 1. Machine off. 2. Depress tab keybutton and latch out tab lever (9-6). 3. Adjust .005" clearance between overthrow stop (9-5) and tab trigger (9-7). <p>Move backspace rack back and forth manually using the intermediate lever (11-1) to check for binds.</p>

BACKSPACE

SYMPTOM	POSSIBLE CAUSE	REMEDY	REMARKS
<p>Machine will not backspace. (Continued)</p>	<p>8. Binds in backspace pawl (15-11)</p> <p>9. Spring missing on backspace pawl (15-11)</p> <p>10. Not enough pawl bite on backspace rack.</p>	<p>Check ease of movement of backspace pawl with spring hook (15-11)</p> <p>Check and replace or repair</p> <p>a) Check backspace pawl spring</p> <p>b) Adjust clearance between escapement torque bar (16-4) and backspace pawl (15-11).</p> <p>c) Adjust clearance between escapement torque bar (16-4) and pawl mounting stud (15-12).</p>	<p>If spring is missing or damaged, pawl will not be held into rack.</p> <p>Pull backspace pawl (15-11) to rear with spring hook, release pawl and it should snap back into rack. Clearance adjusted by bristol screw (16-5).</p> <p>Adjust pawl mounting stud for .001" clearance between stud and escapement torque bar. The pawl mounting stud is an eccentric screw. After the last two adjustments are made, check and adjust the following:</p> <p>1. Adjust escapement link (23-14) for .010" clearance between trigger (22-11) and escapement torque bar (22-13). *Before adjusting escapement trigger - check trigger upstop (22-12) and spacebar latch screw (21-6) to insure they are not restricting the escapement trigger (22-11).</p>

BACKSPACE

SYMPTOM	POSSIBLE CAUSE	REMEDY	REMARKS
Machine will not backspace. (Continued)	11. Mainspring tension too tight.	Mainspring tension is adjusted by rotating spring cage (17-1)	Mainspring tension should be approximately 6 turns.
	12. Backspace keylever pawl overlap.	Adjust the overlap of the backspace pawl (18-10) with the backspace interposer (19-2) using the keylever guide (19-5).	Overlap approximately .040"
	13. Backspace keylever pawl clearance	Adjust "U" shaped slot in keylever for clearance between keylever pawl (18-10) and backspace interposer (19-2).	Clearance approximately .020"
	14. Backspace latch (10-7) not under cam follower (10-5).	a) Adjust bristol screw (21-7) so latch will move freely under cam follower, when keybutton is depressed. b) Adjust bristol screw (20-1) until latch moves to rear beyond cam follower approx. .010"	Backspace interposer (19-2) pushes the backspace latch (10-7) under the cam follower (10-5).
	15. Backspace interposer binding (19-2).	Check and adjust for binds.	Check spring on interposer.
	16. Clutch release arm (20-2) not releasing cam (3B-5).	Adjust cams (3B-5) left or right. Arm may be binding on cam.	Function cams adjust left and right until clutch release arms have equal bite on both cams.

BACKSPACE

SYMPTOM	POSSIBLE CAUSE	REMEDY	REMARKS
Machine will not backspace. (Continued)	17. Backspace pawl binding on tab lever (9-6).	Form extension on escapement bracket to eliminate binds and to adjust clearance between backspace pawl (15-11) and tab lever (9-6).	Use spring hook - push backspace pawl left and right to check for bind.
Machine will not backspace. (Selectric II typewriter dual pitch) In addition to previous adjustments.	<p>1. Not enough carrier motion from driver (24-16).</p> <p>2. Pitch cam cable broken or damaged (25-18)</p> <p>3. Backspace bellcrank stud broken.</p> <p>4. Worn teeth on backspace driver or ratchet.</p>	<p>Adjust backspace latch (26-20) and form extension (26-21) alternately until both are correct.</p> <p>Be sure driver does not contact ratchet at rest position.</p> <p>Replace or repair</p> <p>Stud and screw available for replacement.</p> <p>Replace driver (24-16) or and ratchet (24-17)</p>	<p>Clearance between backspace latch (26-20) and cam follower (26-22) approximately .005".</p> <p>Clearance between backspace driver (24-16) and ratchet (24-17) approximately .030".</p> <p>If cable is broken:</p> <ol style="list-style-type: none"> 1. Replace cable 2. Place machine in 12 pitch position. 3. Depress backspace keybutton. 4. Rotate machine with turning wheel until backspace driver just contacts backspace ratchet. 5. Loosen sheath and adjust until mark (27-24) lines up with stud (27-23).

BACKSPACE

SYMPTOM	POSSIBLE CAUSE	REMEDY	REMARKS
Machine will not repeat backspace	1. Backspace repeat stop (28-25)	Adjust repeat stop (28-25) by forming extension (28-26).	Adjust repeat stop (28-25) by forming extension (28-26) for a single function operation.
	2. Keylever pawl overlap (18-10)	Adjust keylever guide for overlap of the backspace pawl (18-10) with the backspace interposer (19-2).	Overlap approx. .040".
	3. Keylever pawl clearance (18-10)	Adjust "U" shaped slot in keylever for clearance between keylever pawl (18-10) and backspace interposer (19-2).	Clearance is approximately .020".
	4. Backspace latch height (10-7)	Adjust bristol screw (21-7) so latch (10-7) will move freely under cam follower (10-5) when key-button is depressed.	Backspace interposer (19-2) pushes the backspace latch (10-7) under the cam follower (10-5).
	5. Backspace interposer restoring bail (29-26)	Adjust restoring bail (29-26) by forming lugs (29-27) until the interposers restore approx. .020" beyond the latch plate (30-28).	Lug (29-27) on right side is for carrier return and index interposer restoring. Lug on left side is for spacebar and backspace interposer restoring.
	6. Worn pawl (5-3) on backspace cam (3B-5).	Replace pawl (5-3)	Also check spring. When replacing pawl the pin goes in small window of cam wheel.
	7. Broken or damaged spring on cam pawl.	Repair or replace	

BACKSPACE

SYMPTOM	POSSIBLE CAUSE	REMEDY	REMARKS
<p>Machine continues to backspace against margin.</p>	<ol style="list-style-type: none"> 1. Backspace interposer latch binding or worn (33-34) 2. Worn latch plate (30-28) 3. Interposer restoring bail (29-26) 4. Binds in clutch release arm (20-2). 5. Not enough clutch release arm bite (20-2). 6. Too much mainspring tension (17-1) 	<ol style="list-style-type: none"> a) Lubricate b) Replace worn latch <p>Replace</p> <p>Adjust restoring bail (29-26) by forming lugs (29-27) until the interposers restore .020" beyond the latch plate (30-28).</p> <p>Lubricate and release binds. Adjust cams (3B-5) left or right, arm may be binding on cam.</p> <p>Adjust cams (3B-5) left or right for more bite.</p> <p>Check number of rotations on mainspring. Mainspring should be rotated approx. 6 turns.</p>	<p>Replacement latch, screw and nut available.</p> <p>If latch plate is worn - remove plate and rotate it 180° - reinstall and adjust.</p> <p>Lug (29-27) on right side is for carrier return and index interposer restoring. Lug on left side is for spacebar and backspace interposer restoring.</p> <p>Not enough bite will cause cam to repeat.</p> <p>Too much mainspring tension puts a load on restoring system (29-26).</p>

BACKSPACE

SYMPTOM	POSSIBLE CAUSE	REMEDY	REMARKS
Machine backspaces intermittently.	1. Keybutton binding on machine cover.	Adjust machine cover or form keybutton stem.	
	2. Backspace interposer binding (19-2).	Check and adjust for binds.	
	3. Carrier binding on dust cover (12-1).	Adjust dust covers latch or form dust covers.	Also check for objects under carrier binding on dust cover.
	4. Card holder binding on platen.	Adjust card holder.	
	5. Carrier cords off pulleys	Install cords on pulleys - check pulley in back center frame of machine.	Check cord tension on tension pulley (19B-29).
	6. Binds in pinion gears.	Adjust tab pinion gear (31-30) and carrier return pinion gear (31-31) for approximately .005" backlash with escapement cord drum (31-32)	
	7. Backspace latch height (10-7).	Adjust bristol screw (21-7) so latch (10-7) will move freely under cam follower (10-5) when keybutton is depressed.	Backspace interposer (19-2) pushes the backspace latch (10-7) under the cam follower (10-5).
	8. Backspace rack motion (9-4).	a) Adjust clearance between cam follower (10-5) and backspace latch (10-7). b) Intermediate lever loose, broken or maladjusted (11-1).	Adjust latch clearance with adjusting screw for minimum clearance without failure (10-8).

BACKSPACE

SYMPTOM	POSSIBLE CAUSE	REMEDY	REMARKS
<p>Machine backspaces intermittingly. (Continued)</p>	<p>9. Clutch release arm(20-2) binding against backspace cam (3B-5).</p> <p>10. Keylever pawl overlap (18-10)</p> <p>11. Keylever pawl clearance (18-10).</p> <p>12. Binds in carrier shoe.</p> <p>13. No lubrication</p>	<p>Adjust function cams left or right.</p> <p>Adjust the keylever guide (19-5) for overlap of the backspace pawl (18-10) with the backspace interposer (19-2).</p> <p>Adjust "U" shaped slot in keylever for clearance between keylever pawl (18-10) and backspace interposer (19-2).</p> <p>Loosen locking nut and adjust screw (32-33) for shoe clearance minimum clearance - no binds.</p> <p>Lubricate machine.</p>	<p>Overlap approx. .040".</p> <p>Clearance is approx. .020".</p> <p>Position carrier at different points along writing line and check clearance.</p>
<p>Express backspace keybutton will not move carrier.</p>	<p>1. Shoe clearance (34-36)</p> <p>2. Shoe overlap (34-36)</p> <p>3. Keylever pawl (33-39) on wrong side of bellcrank (33-40).</p>	<p>Adjust bellcrank (33-40) by forming, to get shoe clearance</p> <p>Adjust shoe bracket by forming at arrow 36.</p> <p>Correct pawl position and go to adjustment 1.</p>	

BACKSPACE

SYMPTOM	POSSIBLE CAUSE	REMEDY	REMARKS
Carrier jams at left margin after express back-space.	<ol style="list-style-type: none"> 1. Shoe clearance (34-36) 2. Restoring spring missing or damaged on express shoe. 	<p>Adjust bellcrank (33-40) by forming to get shoe clearance.</p> <p>Repair or replace spring.</p>	
Express back-space operates intermittently	<ol style="list-style-type: none"> 1. Oil on carrier return spring. (31-31) 2. Shoe clearance (34-36) 3. Shoe overlap (34-36) 4. Shoe restoring spring damaged. 	<p>Clean oil off spring with cleaning solution.</p> <p>Adjust bellcrank (33-40) by forming to get shoe clearance.</p> <p>Adjust shoe bracket by forming at arrow 36.</p> <p>Repair or replace spring.</p>	Carrier return spring should never be oiled.
Machine indexes as well as back-spaces. (Selectric II typewriter)	<ol style="list-style-type: none"> 1. Index interlock (Paddle) broken or maladjusted (33A-35) 2. Not enough clutch release arm bite (20-2). 	<p>Replace or adjust paddle - when backspace keybutton is depressed the interlock lug (33A-36) is pushed to rear for index operation.</p> <p>Adjust cam (3B-5) left or right for more bite.</p>	<p>Check paddle clips - they hold the paddle shaft in place (33A-35).</p> <p>Not enough bite will cause cam to repeat.</p>

CARRIER RETURN

SYMPTOM	POSSIBLE CAUSE	REMEDY	REMARKS
<p>Machine will not carrier return.</p>	<ol style="list-style-type: none"> 1. Carrier binding on dust cover (12-1). 2. Torque limiter extension spring off or broken (96-17). 3. Oil on carrier return spring (31-31). 4. Carrier return spring clip missing. 5. Transport cords off pulleys. 6. Carrier return keylever pawl is overlapped on the wrong side of the index keylever pawl. 7. Adjustment screw for carrier return clutch arm loose or missing (97-19) 8. Spring between clutch arm (97-19) and actuating arm (96-21) broken or missing. 	<p>Remove binds</p> <p>Replace spring. (Replacement spring must be correct tension)</p> <p>Flush oil off spring with cleaning solution. Spring should not be oiled.</p> <p>Replace clip (96-18).</p> <p>Replace cords on pulleys and check cord tension pulley (19B-29).</p> <p>Reposition carrier return keylever pawl (18-12) on the correct side of index keylever pawl (18-13).</p> <p>Reposition pivot pin (97-20) and tighten screw (97-19).</p> <p>Replace</p>	<p>Dust covers may have to be readjusted.</p> <p>The extension spring applies correct tension for carrier return and also allows the torque limiter spring to slip when carrier is at the left margin.</p> <p>If carrier return problems persist - change carrier return spring.</p>

CARRIER RETURN

SYMPTOM	POSSIBLE CAUSE	REMEDY	REMARKS
<p>Machine will not carrier return</p> <p>(Continued)</p>	<p>9. Too much carrier return shoe clearance (31-33).</p> <p>10. Carrier hitting against a tab stop.</p> <p>11. Carrier return latch will not go under cam follower.</p> <p>12. Check carrier return interposer for damage.</p> <p>13. Carrier return keylever pawl broken (18-12).</p> <p>14. Cam follower worn or broken.</p>	<p>Adjust screw (31-34) for clearance between carrier return spring (31-31) and shoe (31-33).</p> <p>Usually happens with the silicone tab rack.</p> <p>Adjust carrier return latch screw (97-24) so latch (97-22) will go under cam follower (97-23).</p> <p>Repair or replace interposer (19-3).</p> <p>Replace</p> <p>Replace</p>	<p>Replace silicone tab rack with friction.</p>
<p>Carrier oscillates back and forth.</p>	<p>1. Grease or oil on carrier return spring (31-31).</p> <p>2. Extension spring missing or damaged.</p> <p>3. Too much carrier return shoe clearance (31-33).</p> <p>4. Clip on carrier return spring missing or damage</p>	<p>Flush carrier return spring with cleaning fluid.</p> <p>Replace extension spring (96-17).</p> <p>Adjust carrier return shoe clearance (31-33) with adjusting screw (31-34).</p> <p>Replace spring clip (96-18).</p>	<p>Carrier return spring should not be lubricated. If failure continues replace carrier return spring.</p> <p>Must be replaced with correct spring.</p>

CARRIER RETURN

SYMPTOM	POSSIBLE CAUSE	REMEDY	REMARKS
<p>Carrier does not return all the way to the left hand margin.</p>	<ol style="list-style-type: none"> 1. Carrier binding on dust cover (12-1). 2. Clutch latch overthrow 3. Worn latch keeper 4. Cords off pulleys. 5. Carrier return tab interlock maladjusted. 6. Spring missing or broken on latch keeper. 7. Damaged or weak extension spring (96-17) on torque limiter. 	<p>Remove binds</p> <p>Adjust clutch latch (99-27) to overthrow keeper (99-26).</p> <p>Replace keeper (99-26)</p> <p>Replace cords on pulleys</p> <p>Adjust interlock for clearance (99-28). Rotate interlock clip (100-29) radially for clearance between clip interlock (100-29) and tab interlock (100-30)</p> <p>Replace spring (99-31) on latch keeper.</p> <p>Replace</p>	<p>Dust covers may have to be formed or readjusted.</p> <ol style="list-style-type: none"> 1. Overthrow adjustment should be enough to ensure latch up. 2. When checking overthrow, be sure platen is installed. <p>Also check cord tension pulley for proper adjustment.</p> <p>Tab interlock restricts carrier return latch keeper (99-26) from moving towards rear, this prevents the keeper(99-26) from latching up carrier return latch (99-27).</p>
<p>Carrier return jams or hesitates at left margin.</p>	<ol style="list-style-type: none"> 1. No clearance between express backspace shoe (34-36) and carrier return spring (31-31). 	<p>Adjust bellcrank (33-40) by forming to obtain shoe clearance</p>	<p>Selectric II typewriter only.</p>

CARRIER RETURN

SYMPTOM	POSSIBLE CAUSE	REMEDY	REMARKS
Uneven left hand margin.	1. Carrier binding on dust cover (12-1).	Remove binds	Dust covers may have to be formed or readjusted.
	2. Carrier indicator binding on top cover.	Adjust indicator up or down on front of carrier to prevent binds.	Red Carrier indicator shows the position of the carrier.
	3. Overbank	Adjust bellcrank (101-32) back and forth for even left hand margin	
	4. Velocity cable binding on cord pulleys.	Adjust velocity cable (70-40) to just contact the left inside of machine when carrier is at extreme left side of machine.	
	5. Carrier return clutch unlatching hesitates.	Rotate clevis (101-33) to adjust for correct amount of latch bite (99-27) .	Latch bite effects clutch unlatching
	6. Carrier return shoe clearance.	Adjust screw (31-34) for clearance between carrier return spring (31-31) and shoe (31-33).	
	7. Cords off pulleys.	Replace cords on pulleys.	Check cord tension pulley.
	8. Escapement pawl worn.	Replace pawl (73-43)	If pawl is replaced, check escapement rack also.
	9. Escapement rack worn.	Replace escapement rack (73-44)	If escapement rack is replaced, check escapement pawl also.
	10. Too much pawl clearance during carrier return.	Form clutch latch (99-27) for minimum escapement pawl clearance during carrier return.	

CARRIER RETURN

SYMPTOM	POSSIBLE CAUSE	REMEDY	REMARKS
Uneven left hand margin.	11. Torque limiter spring broken or maladjusted. 12. Too much tension on mainspring (17-1)	Replace torque limiter spring (96-30). Mainspring should be wound clockwise approximately 6 turns.	Lubricate torque limiter spring with grease. Too much mainspring tension (17-1) may not allow carrier to return to left hand margin.
Carrier return gets extra cycle	1. Carrier return keybutton binding on cover. 2. Interposer latch plate worn or maladjusted. 3. Keylever restoring spring off or damaged. 4. Not enough bite on clutch release arm. 5. Interposer restoring bail maladjusted. 6. Check keylever pawl overlap and clearance.	Adjust keybutton by forming or adjust machine within covers. Replace latch plate (30-28) Replace spring (66-32). Adjust function cams (95-15) to the left to provide more bite. Adjust restoring bail (29-26) by forming adjustable lugs (29-27) so interposer (19-4) will overthrow latch plate (30-28). 1. Adjust overlap of carrier return pawl (18-12) and interposer by adjusting screw (18-14) Overlap approximately .040"	Adjust machine foot brackets (65-30) 2. Adjust .025" clearance between keylever pawl (18-12) and interposer with "U" slot in carrier return keylever.

CARRIER RETURN

SYMPTOM	POSSIBLE CAUSE	REMEDY	REMARKS
Carrier return noisy.	<ol style="list-style-type: none"> 1. Escapement pawl dragging on escapement rack. 2. Velocity cable rubbing against carrier (70-40). 3. Tab gang clear bracket rubbing on tab rack. 4. Cords off pulleys 	<p>Form clutch latch (99-27) for minimum escapement pawl clearance during carrier return.</p> <p>A certain amount of velocity cable noise is permissible.</p> <p>Adjust gang clear bracket (92-34) to minimize noise.</p> <p>Replace cords on pulleys and check cord tension pulley.</p>	
Carrier return jams or hesitates at left margin.	<ol style="list-style-type: none"> 1. Carrier binding on dust cover (12-1). 2. Not enough carrier return shoe clearance. 3. Clutch unlatching maladjusted. 4. Overbank 5. Carrier return pinion spring damaged (31-31) 6. Broken torque limiter spring or extension spring. 	<p>Remove binds</p> <p>Adjust screw (31-34) for clearance between carrier return spring (31-31) and shoe (31-33).</p> <p>Adjust clevis (101-33) for correct amount of latch bite (99-27) .</p> <p>Adjust bellcrank (101-32) back and forth for even left hand margin</p> <p>Replace</p> <p>Replace torque limiter spring (96-30) or extension spring (96-17)</p>	<p>Dust covers may have to be formed or readjusted.</p> <p>Proper latch bite prevents hesitation when carrier return is released.</p> <p>Lubricate mechanism.</p> <p>Check for bad loop in carrier return spring (31-31).</p> <p>Lubricate spring (96-30)</p>

CORRECTABLE TAPE

SYMPTOM	POSSIBLE CAUSE	REMEDY	REMARKS
<p>Character is not completely removed.</p>	<ol style="list-style-type: none"> 1. Wrong ribbon on machine 2. Correcting tape installed wrong. 3. Binds in carrier 4. Paper bail arm weak (78-10) 5. Card holder binding on platen. 6. Backspace not working correctly. 7. Correctable tape sticks to card holder. 	<p>Replace with correct ribbon:</p> <p>There are two kinds of correction supplies.</p> <p>The two different supplies for the correctable ribbon should not be mixed.</p> <p>Check and reinstall ribbon correctly.</p> <p>Check adjustments in "Carrier will not escape section".</p> <p>Clean paper bail rollers (78-10) inside and out. Remove binds so they roll freely.</p> <p>Adjust card holder for clearance with platen.</p> <p>" Go to backspace section"</p> <p>Non sticking coating on card holder destroyed.</p>	<ol style="list-style-type: none"> 1. The Solvent ribbon, which has a blue core, uses the blue core correcting tape. This is a cover up technique. 2. The correctable ribbon, which has a yellow core, uses a yellow core correctable tape supply spool. This combination picks the ink up and off the paper. <p>Carrier must rest against escapement pawl completely.</p> <p>The paper is not being held tightly against platen. There is a stronger paper bail available.</p> <p>After operating the correction mechanism, the carrier must rest on the escapement pawl completely.</p> <p>Replace card holder</p>

CORRECTABLE TAPE

SYMPTOM	POSSIBLE CAUSE	REMEDY	REMARKS
Character is not completely removed	8. Correctable tape being lifted too high or too low.	<ol style="list-style-type: none"> 1. Check and correct binds in tape lift assembly (117-45). 2. Tape lift binding on card holder (117-45) 3. Lift arm latch (121-5) slips off tape lift cam follower (121-6)- not enough bite. <ol style="list-style-type: none"> A. Check for binds in torque bar (118-46) and tape lift actuating arm (121-8) 4. Binds in lift arm latch (121-5) 5. Lift actuating arm damaged or bent (121-8). 	<p>Adjust card holder to eliminate binds.</p> <ol style="list-style-type: none"> 1. Adjust lift latch (121-5) back and forth with adjusting screw (121-7), so it clears lift cam follower (121-6) at rest position 2. Adjust lift latch (121-5) up and down for clearance with lift cam follower (121-6), so latch will move over lift cam follower (121-6) when mechanism is operated. <p>Remove binds in latch, and lube.</p> <p>Correct binds in arm (121-8) and lubricate.</p>

CORRECTABLE TAPE

SYMPTOM	POSSIBLE CAUSE	REMEDY	REMARKS
Correctable tape will not feed. FIRST: Check adjustment in correcting tape does not lift, but machine backs spaces.	1. Binds in tape feed inhibitor. 2. Feed bellcrank broken or damaged. 3. Feed link broken or damaged 4. Tape feed pawl or spiked driver broken or damaged 5. Tape cradle supply spool binding (117-46). 6. Tape binding on lift assembly.	Adjust minimum clearance between feed cam follower (114-41) and tape feed inhibitor (114-40) with machine in the rest position. Replace bellcrank (115-42) Replace feed link (115-43) Replace tape feed pawl (116-44) or spiked driver (116-45). Remove binds and check detent (117-44). Correct for binds in tape lift assembly (117-45).	Clearance is adjusted by forming feed cam follower. NOTE: Have experienced correctable ribbon supply spool not staying on supply cradle due to non IBM supplies.
Correctable tape feeds continuous or intermittently. FIRST: Check causes under "Correcting tape does not lift when trying to remove character, but machine backspaces"	1. Warped or damaged torque bar. 2. Binds in tape feed inhibitor.	Replace torque bar (118-46). 1. Remove bind in inhibitor (114-40) at pivot point. 2. Adjust minimum clearance between feed cam follower (114-41) and tape feed inhibitor (114-40) with machine in the rest position.	Clearance is adjusted by forming feed cam follower.

CORRECTABLE TAPE

SYMPTOM	POSSIBLE CAUSE	REMEDY	REMARKS
<p>Correctable tape feeds continuous or intermittently.</p> <p>(Continued)</p>	<p>3. Tape feed cam follower is not being held in latch position.</p> <p>4. Mode latch (119-1) not holding mode actuating bellcrank (119-2).</p>	<p>1. Torque bar (118-46) is not allowing tape feed inhibitor to restore (114-40).</p> <p>2. Remove bind in inhibitor (114-40) at pivot point.</p> <p>Form lug (119-3) on mode actuating bellcrank (119-2) so it will overthrow mode latch (119-1) approximately .005"</p>	<p>3. Adjust minimum clearance between feed cam follower (114-41) and tape feed inhibitor (114-40) with machine in the rest position.</p> <p>The overthrow is to ensure latch up.</p>

CORRECTABLE TAPE

SYMPTOM	POSSIBLE CAUSE	REMEDY	REMARKS
Correcting keybutton will not backspace machine.	Correcting keybutton binding on cover. (120-4) Correcting keylever binding at pivot point. (122-9)	Correct keybutton for binds by controlling side play, forming or repositioning machine within cover Remove bind at pivot point and check side play (122-9)	
Backspace mechanism must be operating properly before repairing Correcting backspace.	Correcting keylever (120-11) broken or off of backspace keylever .	Check and replace keylever if broken. Form keylevers for adjustment if correctable keylever slot is off of backspace keylever.	
Carrier escapes when trying to remove character.	No clearance between escapement trigger (22-11) and escapement torque bar (22-13)	Trigger link broken, damaged or maladjusted (22-4)	Adjustment: 1. Turn machine off. Depress correcting keybutton. 2. Adjust trigger link (22-4) so trigger (22-11) will just miss escapement torque bar (22-13).
Correctable ribbon mechanism activates itself	Weak correcting keybutton restoring spring. Machine has high profile keybutton (120-4).	1. Replace restoring spring with one that is stronger. 2. Replace keybutton with one of lower profile.	

CORRECTABLE TAPE

SYMPTOM	POSSIBLE CAUSE	REMEDY	REMARKS
<p>Correcting tape does not lift when trying to remove character, but machine backspaces.</p>	<ol style="list-style-type: none"> 1. Correcting keylever link broken or maladjusted. (122-12) 2. Mode latch binding or damaged. 3. Mode actuating bellcrank binding or damaged. (119-2) 4. Correcting torque bar link (118-13) broken or out of slot in correcting torque bar (118-46) 5. Correcting torque bar has too much flexing, causing lost motion. 6. Torque bar (118-46) not moving lift arm latch (121-5) over lift cam follower (121-6) 	<ol style="list-style-type: none"> Replace link (122-12) or adjust keylever link so mode actuating bellcrank (119-2) is released slightly before machine backspaces Remove binds in mode latch or replace (119-1). Remove binds in mode actuating bellcrank or replace (119-2) 1. Replace link (118-13) if broken. 2. Normally, link is out of slot in torque bar. 1. Be sure torque bar (118-46) is on proper side of back-up tab on velocity control bracket. (43-29) 2. Adjust torque bar stop bracket (118-14) at right end of torque bar (118-46). 1. Tape lift actuating arm bent (121-8) 2. Check cause #7 in "Character is not completely removed" section. 	<p>If correcting torque link (118-13) is out of slot in torque bar (118-46) replace link in slot and control side play with collar or clip on left side of torque bar (118-14).</p> <p>The velocity control bracket is on the bottom of the carrier (43-29)</p> <p>Adjust stop bracket (118-14) for minimum clearance without flexing or contacting torque bar. (118-46)</p> <p>Correct bend or bind in lift actuating arm (121-8)</p>

CORRECTABLE TAPE

SYMPTOM	POSSIBLE CAUSE	REMEDY	REMARKS
<p>Correcting tape does not lift when trying to remove character, but machine backspaces.</p> <p>(Continued)</p>	<p>7. Tape feed inhibitor not releasing tape feed cam follower.</p> <p>8. Correcting tape binding on card holder or separator wire. (13)</p>	<p>1. Remove binds in tape feed inhibitor (114-40).</p> <p>2. Adjust tape feed cam follower (114-41) by forming for clearance between tape feed inhibitor (114-40) and tape feed cam follower (114-41).</p> <p>1. Adjust card holder to rear to release binds.</p> <p>2. Adjust separator wire so:</p> <p>1. It clears the typehead at the half cycle point.</p> <p>2. It just contacts the card holder.</p> <p>3. It moves away from the card holder when the ribbon load lever is activated for the correctable ribbon.</p>	<p>The clearance between tape feed inhibitor (114-40) and tape feed cam follower (114-41) allows the inhibitor to move freely in and out from under cam follower.</p>

CROWDING

SYMPTOM	POSSIBLE CAUSE	REMEDY	REMARKS
<p>Crowding</p> <p>Sample: crowding</p>	<ol style="list-style-type: none"> 1. Lack of lubrication 2. Escapement pawl clearance. 3. Card holder binding on platen. 4. Mainspring broken or damaged (7-10). 5. Transport cords off pulleys. 6. Binds in escapement shaft bearing (23-15). 7. Binds in tab pinion gear (31-30). 8. Binds in tilt or rotate pulleys. 9. Carrier return shoe clearance (31-33). 10. Defective print shaft - rough keyway, shedding or peeling. 	<p>Lubricate print shaft, escapement rack, carrier, pulleys and etc.</p> <p>Adjust trigger knockoff (74-45) for .015" clearance between escapement pawl (73-43) and rack(73-44).</p> <p>Adjust card holder.</p> <p>Mainspring should be wound clockwise from rear approximately 6 turns.</p> <p>Replace cords on pulleys.</p> <p>Remove binds and lubricate.</p> <p>Check for damaged gear. Adjust tab pinion gear left or right for minimum backlash - no binds.</p> <p>Check, lubricate and remove binds</p> <p>For shoe clearance, adjust screw (31-34).</p> <p>Replace - if keyway is rough, check print shaft key.</p>	<p>Check cord tension pulley(69-41)</p> <p>When print shaft is replaced - adjust fine timing. (See alignment section for fine timing).</p>

CROWDING

SYMPTOM	POSSIBLE CAUSE	REMEDY	REMARKS
Crowding (Continued)	11. Filter shaft timing (55)	For further information "See alignment section".	Filter shaft timing affects the position of escapement cam and spacebar interlock cam.
	12. Escapement cam maladjusted (75-46)	Adjust cam (75-46) radially so cam follower (75-35) is on low dwell of cam, with machine at rest position.	
	13. Pawl mounting stud loose or maladjusted.	Adjust pawl mounting stud for .001" clearance between escapement torque bar (22-13) and pawl mounting stud. (91-35).	
	14. Escapement trip link (23-14).	Adjust escapement trip link for .010" clearance between trigger (22-11) and escapement torque bar (22-13).	
	15. Trigger upstop (22-12).	Adjust trigger upstop, with machine at rest, for .005" clearance between upstop (22-12) and trigger (22-11).	
	16. Trigger restoring spring broken (22-14).	Replace	
	17. Typehead homing	See alignment section	
	18. Balance arm	See alignment section	
	19. Rotate arm motion	See alignment section	
	20. Rotate link	See alignment section	

CROWDING

SYMPTOM	POSSIBLE CAUSE	REMEDY	REMARKS
<p>Crowding (Continued)</p>	<p>21. Shift motion</p> <p>22. Fine timing</p> <p>23. Backspace pawl holding instead of escapement pawl (73-46).</p> <p>24. Check cord tension</p> <p>25. Escapement torque bar flexes or is warped (76-4).</p>	<p>See alignment section</p> <p>See alignment section</p> <p>Adjust backspace</p> <p>For adjustment of cord tension pulley - See special section.</p> <p>If torque bar is warped - replace</p>	<p>Also check shift mechanism for proper shift detenting (See shift section).</p> <p>See backspace section.</p> <p>Adjust torque bar backstop to prevent flexing (7-11). Backstop not on 11" machines.</p>
<p>Crowding Selectric II typewriter only:</p> <p>In addition to the adjustments above.</p>	<p>1. Correcting tape mechanism maladjusted.</p> <p>2. Express backspace shoe binding carrier return spring.</p> <p>3. Escapement rack not parallel to escapement rail.</p>	<p>See correcting tape section</p> <p>Adjust bellcrank (33-40) for clearance between express backspace shoe and carrier return spring.</p> <p>Loosen escapement rack gear(77-5) and rotate escapement rack until it is parallel to escapement rail.</p>	<p>For further information see express backspace section.</p> <p>Figure (78-8) is the margin rail and (78-9) is the margin rack. The margin rack rotates within the margin rail to change from 10 pitch to 12 pitch and vice versa. The escapement rack and rail operate the same.</p>

MACHINE CROWDING IN SAME PLACE CONSISTENTLY.

SYMPTOM	POSSIBLE CAUSE	REMEDY	REMARKS
<p>Machine crowding in same place consistently.</p>	<ol style="list-style-type: none"> 1. Carrier binding on dust cover or shield. 2. Card holder binding on platen or feed rollers. 3. Mainspring broken or damaged. (7-10) 4. Binds due to lack of lubrication. 5. Dirt in keyway of print shaft (70-39) or on print shaft wipers. 6. Binds in cord pulleys 7. Rear shoe on carrier binding (32-33). 8. Binds in tab pinion gear (31-30) or tab springs. 9. Print shaft wipers hard or dirty (41-27). 10. No clearance between carrier return shoe and carrier return spring. 	<p>Adjust and or form dust shield. (12-1).</p> <p>Adjust card holder to prevent binding on platen.</p> <p>Mainspring should be wound clockwise from rear of machine approximately 6 turns.</p> <p>Lubricate machine completely.</p> <p>Clean and lubricate.</p> <p>Lubricate and remove binds.</p> <p>Adjust shoe clearance with adjusting screw (32-33).</p> <p>Adjust tab pinion gear (31-30) left or right for minimum backlash-no binds.</p> <p>Replace</p> <p>Adjust carrier return adjusting screw (31-34) for clearance between carrier return pinion gear and spring (31-33).</p>	<p>Check card holder for damage.</p> <p>Adjustment should be minimum clearance - no binds.</p> <p>Check gears for bad teeth; check tab spring for bad loop.</p> <p>Remove wiper covers on each side of carrier around print shaft(20-39) to remove wipers (41-27).</p>

MACHINE CROWDING IN SAME PLACE CONSISTENTLY

SYMPTOM	POSSIBLE CAUSE	REMEDY	REMARKS
<p>Machine crowding in same place consistently.</p>	<p>11. Bind in escapement shaft (23-15).</p>	<p>Lubricate and remove binds.</p>	
	<p>12. Torque bar warped (76-4).</p>	<p>Replace</p>	<p>If torque bar is warped, it changes the escapement pawl clearance at different points along the writing line.</p>
	<p>13. Tab gang clear bracket binding on tab rack.</p>	<p>Adjust tab gang clear bracket (73-45) to prevent binding on tab rack.</p>	<p>See tab section for further information.</p>
	<p>14. Not enough escapement pawl clearance (73-43).</p>	<p>Adjust trigger knockoff (71-45) for .015" clearance between escapement pawl (73-43) and escapement rack (73-44).</p>	
	<p>15. Backspace pawl holding carrier instead of escapement pawl.</p>	<p>Adjust clearance between backspace pawl (73-46) and backspace rack.</p>	<p>See backspace section for further information.</p>

CROWDING AFTER A BACKSPACE

SYMPTOM	POSSIBLE CAUSE	REMEDY	REMARKS
<p>Crowding after a backspace</p> <p>Problem relates to Selectric I and II single pitch typewriters</p>	<p>1. Backspace pawl holding on escapement rack instead of escapement pawl.</p>	<p>Adjust clearance between backspace pawl (73-46) and backspace rack with backspace bellcrank screw (82-15).</p>	<p>Clearance approximately .010".</p>
<p>Crowding after express backspace. (Selectric II single pitch)</p>	<p>1. Backspace pawl holding on escapement rack instead of escapement pawl.</p> <p>2. Express backspace latch and keylever pawl(83-16)</p>	<p>See adjustment above.</p> <p>Adjust keylever pawl and express backspace latch to release and hold the backspace interposer, until the express keybutton is released.</p>	<p>When the express keybutton is released the backspace mechanism will be activated.</p>
<p>Selectric II dual pitch.</p>	<p>Binds in express backspace shoe (34-36)</p>	<p>Adjust bellcrank (33-40) by forming to get shoe clearance.</p>	<p>Adjust for .010"</p>
<p>Machine crowds after a shift.</p>	<p>1. Trigger knockoff (74-45)</p> <p>2. Shift cam (62-21) not detented with shift arm roller properly (62-20)</p> <p>3. Character interrupter maladjusted or damaged</p>	<p>Adjust trigger knockoff for .015" clearance between the escapement pawl (73-43) and the escapement rack (73-44).</p> <p>Adjust shift mechanism - "See shift section".</p> <p>See "Random malselection, cause 27".</p>	<p>Trigger knockoff controls escapement pawl clearance .</p> <p>When shift is in upper case position, the detent roller should be fully seated in detent dwell.</p>

ESCAPEMENT

SYMPTOM	POSSIBLE CAUSE	REMEDY	REMARKS
Carrier will not escape.	1. Carrier binding on dust shield (12-1).	Adjust dust shields.	Dust shields may have to be formed.
	2. Velocity cable caught on pulley.	Adjust velocity cable (70-40) to just contact the left inside of machine when carrier is at extreme left side of machine.	
	3. Mainspring broken (17-1)	Replace and adjust.	Mainspring should be wound clockwise approximately 6 turns.
	4. Card holder binding on platen.	Adjust card holder towards front of machine .	After adjustment , check that ribbon lifts are not hitting card holder.
	5. Escapement cord off pulley.	Replace cord on pulley and check cord tension pulley. (69-41).	For cord tension pulley adjustment - see "Special section".
	6. Rear carrier shoe binding.	Adjust rear shoe for minimum clearance - no binds with adjusting screw (32-33).	
	7. Print shaft binding on wiper covers (41-27).	Adjust wiper covers (41-27) and lubricate wipers.	
	8. Binds in tab governor pinion gear or spring (31-30).	Loosen tab pinion gear (31-30) and adjust back and forth for minimum backlash - no binds.	Tab pinion spring and gear needs cleaning - flush with chemical solution.
	9. Carrier return shoe binding against carrier return spring.	Adjust clearance between carrier return shoe (31-33) and carrier return spring (31-31) with adjusting screw (31-34).	Also check for bad loop in carrier return spring (31-31).

ESCAPEMENT

SYMPTOM	POSSIBLE CAUSE	REMEDY	REMARKS
Carrier will not escape	10. Filter shaft gear loose.	Tighten filter shaft gear.	Before tighten filter shaft gear, adjust filter shaft (55).
	11. Escapement cam loose on filter shaft (75-46)	Adjust cam (75-46) radially so cam follower (75-35) is on low dwell of cam with machine in rest position.	
	12. Filter shaft maladjusted.	Adjust filter shaft (55)	Adjust escapement link (23-14) for approximately .010" clearance between escapement torque bar (22-13) and trigger (22-11)
	13. Escapement link broken or damaged (23-14)	Replace and adjust	
	14. Cam follower off cam	Check and reposition cam (75-46) for cam follower (75-35).	
	15. Trigger restoring spring broken (22-14)	Replace	
	16. Trigger upstop (22-12) out of adjustment.	Adjust trigger upstop for .005" clearance between escapement trigger (22-11) and upstop (22-12)	
	17. Pawl mounting stud loose or maladjusted. (91-35).	Adjust pawl mounting stud for .001" clearance between escapement torque bar (22-13) and pawl mounting stud (91-35).	

ESCAPEMENT

SYMPTOM	POSSIBLE CAUSE	REMEDY	REMARKS
<p>Carrier will not escape.</p>	<p>18. Escapement torque bar upstop.</p>	<p>Adjust screw (76-5) for minimum clearance between escapement torque bar (22-13) and escapement pawl (73-43).</p>	<p>If the escapement torque bar is adjusted - check adjustment of escapement trigger (22-11).</p>
	<p>19. Trigger knockoff loose or maladjusted (74-45)</p>	<p>Adjust trigger knockoff (74-45) for approximately .010" escapement pawl clearance.</p>	
	<p>20. Escapement bracket loose (89-30).</p>	<p>Adjust bracket (89-30); Loosen 4 screws and adjust escapement bracket parallel to tab torque bar (91-31).</p>	<p>Adjust .010" clearance between escapement bracket (89-30) and tab torque bar (89-31). Tab torque bar and escapement bracket should be parallel to each other.</p>
	<p>21. Print shaft damaged.</p>	<p>Replace - If print shaft is replaced, adjust fine timing. (See alignment section for fine timing)</p>	<p>1. Print shaft may be shedding or peeling outer coating. 2. Print shaft bowed.</p>
	<p>22. Spacebar latch lever screw interfering with escapement (10-8).</p>	<p>To check: Loosen latch lever screw nut and back off latch lever screw (10-8)</p>	<p>When adjusting escapement, to prevent interference, loosen and back off latch lever screw.</p>

EXCESSIVE HEADPLAY

Excessive headplay can be checked by:

1. Half cycle the letter "J". (130)
2. With your finger (on left hand), remove rotate detent from engagement with the element.
3. With your fingers (on right hand), rotate the element in a counter-clockwise direction, and remove the headplay. Hold the element in counterclockwise direction.
4. Slowly, let detent reenter tooth of element and observe where detent contacts element (131-31).
5. With your finger (on left hand), remove the rotate detent from engagement with the element.
6. With your fingers (on right hand), rotate the element in a clockwise or positive direction, and remove the headplay.
7. Let detent reenter tooth of element and observe where detent contacts element (132-32).

The distance between the two points where detent contacts element should not exceed .065".

If .065" is exceeded, replace dog bone (universal joint) (42-28) and or lower ball socket (42-27) or and upper ball socket (41-25).

EXTRA CYCLES

SYMPTOM	POSSIBLE CAUSE	REMEDY	REMARKS
<p>Extra cycles</p> <p>If an operator gets an extra cycle after one character is typed, that character will print, and the next extra cycle should cause a hyphen or dash to print.</p>	<ol style="list-style-type: none"> 1. Worn or damaged cycle clutch latch (50-35). 2. Damper springs broken or missing from cycle bail. 3. Interposer latch springs bent, broken or maladjusted (56-11). 4. Filter shaft timing (55). 5. Cycle clutch restoring. 6. Cycle clutch keeper (54-8). 7. Cycle clutch keeper bracket. 8. Cycle bail upstop (61-19) 	<p>Replace cycle clutch latch.</p> <p>Replace springs (53-32)</p> <p>Repair or replace latch springs (56-11).</p> <p>See alignment section.</p> <p>Adjust restoring stud (50-34) so cycle clutch latch pawl (54-20) will overthrow cycle clutch latch keeper (54-8) approx. .020".</p> <p>See "Flicking" in special section.</p> <p>Check for damage - Loosen screw (58-16) and adjust keeper bracket up or down until cycle clutch latch has a full bite on cycle clutch sleeve (59-17).</p> <p>Adjust cycle bail upstop (61-19) so latch pawl (54-20) is held by 1/2 thickness of keeper (54-8).</p>	<p>Cycle clutch latch adjustment (135).</p> <p>Damper springs (53-32) prevent the cycle bail (53-33) from bouncing, causing extra cycles.</p> <p>Latch springs come in two section</p> <p>Insufficient bite could cause extra cycles. Too much bite could cause a touch problem and could cause cycle clutch not to be released.</p>

HALF - PRINTING

SYMPTOM	POSSIBLE CAUSE	REMEDY	REMARKS
<p>Half printing (Machine not printing a full character)</p>	<ol style="list-style-type: none"> 1. Broken or cracked type-head (36). 2. Broken bias spring in tilt ring. (44-31) 3. No lubrication on type-head (36) 4. Skirt clearance 5. Worn or loose roller on shift arm (69-37) 6. Gear train (47) 7. No lubrication in cycle clutch. 8. Cycle clutch spring worn or damaged (70). 9. Cycle clutch sleeve (63-25) 10. Cycle clutch collar (63-26) 11. Cycle clutch overthrow stop (63-25). 	<p>Replace or repair</p> <ol style="list-style-type: none"> 1. Typehead could cause problems if the silver coating wears off. <p>Replace</p> <p>Lubricate inner circumference of typehead with grease.</p> <p>See alignment section</p> <p>Replace shift arm if roller is worn.</p> <p>Adjust for maximum mesh - no binds.</p> <p>Lubricate cycle clutch with recommended grease (50-45)</p> <p>Replace</p> <p>See alignment section</p> <p>See alignment section</p> <p>See alignment section</p>	<ol style="list-style-type: none"> 2. Latch springs on element broken. 3. Cap loose or broken. <p>Bias spring is in current level tilt ring - remove upper ball socket (44-25) to check bias spring</p> <p>Grease is for bias tilt rings (39-23).</p> <p>Causes rotate detenting to change.</p> <p>See alignment section</p> <p>Lubricate machine completely.</p>

HALF - PRINTING

SYMPTOM	POSSIBLE CAUSE	REMEDY	REMARKS
Half printing (Continued)	12. Tilt arm motion	See alignment section	Maybe binding against upper ball socket (41-25) or inside of element Pins are adjusted to center the tilt ring (39-23) between yoke extensions (39-22). Causes variation in tilt detenting. Adjust for minimum clearance - no binds.
	13. Tilt homing	See alignment section	
	14. Tilt ring spacers (41-26)	Adjust tilt ring spacers for no binds.	
	15. Tilt ring pivot pins worn or maladjusted. (39-21)	Remove and check for wear.	
	16. Tilt pulley link damaged or broken. (46-46)	Replace	
	17. Tilt bellcrank worn loose. (40-24).	Replace	
	18. Binds in tilt or rotate detents	Adjust tilt screws (38-46) and rotate detent screw (38-20)	
	19. Typehead homing	See alignment section	
	20. Balance arm	See alignment section	
	21. Rotate arm motion	See alignment section	
	22. Rotate link	See alignment section	
	23. Shift motion	See alignment section	
	24. Fine timing	See alignment section	
	25. Filter shaft timing (55)	See alignment section	

HALF - PRINTING

SYMPTOM	POSSIBLE CAUSE	REMEDY	REMARKS
Half printing (Continued)	26. Rotate spring tension (46-33)	See alignment section	Spring may be broken - flush out spring cage.
	27. Too much headplay due to worn dog bone (42-28), upper ball socket (41-25) or lower ball socket (42-27).	Replace	This wear can be checked by observing headplay. (See excessive headplay section.)
	28. Binds in rotate or tilt pulleys.	Remove binds and lubricate.	
	29. Character interrupter (49-40)	See "Random malselection section, cause 27. "	
	30. Shift interlock (69-38)	Adjust shift interlock (69-38) to just touch the shift ratchet (4-3) at the half cycle point.	
	31. Selector latch links (51-46)	See alignment section	
	32. Latch stop pads (40-25)	See alignment section	
	33. No clearance between detent cam follower (71-40) and detent actuating lever (71-39).	See alignment section	
34. Rotate shaft set screw loose (43-30).	Tighten screw and check rotate link adjustment.	See alignment section	

HALF - PRINTING

SYMPTOM	POSSIBLE CAUSE	REMEDY	REMARKS
Half printing (Continued)	35. Shift cam backup roller worn or loose (48-39) 36. Spring broken or missing on velocity cam follower (43-32). 37. Negative 5 latch (72-41) and bail stop screw (72-42). 38. Broken rotate bellcrank pivot stud. (40-32).	Replace if worn - older style backup rollers are adjustable - current levels are not. Replace cam follower spring (43-31). See alignment section Replace	Causes detenting to change. Symptom would show periods, comma's and low velocity characters heavily embossing paper.

IMPRESSION PROBLEMS

SYMPTOM	POSSIBLE CAUSE	REMEDY	REMARKS
Impression problems	<ol style="list-style-type: none"> 1. Poor lubrication 2. Broken typehead (36) 3. Check platen for wear and adjustment. 4. Platen latches and platen bearings (81-13). 5. Multiple copy control lever (81-14). 6. Check paper being used 7. Cycle clutch drive (1) 8. Card holder 9. Drive belt (6-7) 	<p>lubricate machine completely.</p> <p>Replace or repair</p> <ol style="list-style-type: none"> 1. Typehead could cause problems if the silver coating wears off. <p>Check platen for high spots and ridges.</p> <p>Check for wear and adjustment.</p> <p>Make sure copy control lever is all the way forward.</p> <p>Some types of paper will not accept ink as readily as others.</p> <p>Observe cycle clutch drive for responsive action after each key depression. It should have in-stance response.</p> <p>Adjust card holder to prevent interference with platen or ribbon lift.</p> <p>Adjust drive belt for slight de-flection with minimum noise.</p>	<p>Lubricate carrier, racks, shafts and cycle clutch mechanism.</p> <ol style="list-style-type: none"> 2. Latch springs on element broken. 3. Cap broken or loose. <p>Adjust platen up and down (80-11); and back and forth (80-12). Use platen gauge.</p> <p>Adjust platen latches for no move-ment of platen.</p> <p>Also check for oil and grease spots on paper.</p> <p>Lubricate cycle clutch with grease</p> <p>Drive belt adjusted by using motor mount brackets (3A-8).</p>

IMPRESSION PROBLEMS

SYMPTOM	POSSIBLE CAUSE	REMEDY	REMARKS
Impression problems (Continued)	10. Power and free flight adjustments. 11. Finger prints or oil on paper. 12. Broken bias spring in tilt ring. (44-31). 13. Ribbon feed 14. Ribbon defective or worn 15. Fine timing 16. For further causes, see escapement section.	See "Noise during print cycle only, cause f section". Check paper closely, notice what kind of paper is being used. Replace See ribbon section Change ribbon See alignment section	Bias spring is in late level tilt ring - remove upper ball socket (41-25) to check bias spring. Some ribbons may have dry or oil spots.

INDEXING

SYMPTOM	POSSIBLE CAUSE	REMEDY	REMARKS
Platen does not rotate or index	<ol style="list-style-type: none"> 1. Index keybutton binding on top cover . 2. Index keylever restoring spring missing or damaged (57-36). 3. Springs on index pawl broken (57-37). 4. Paper deflector not on positioning studs. 5. Feed rollers not in proper holes (93-9). 6. Index link or clevis broken or damaged (93-10). 7. Bind in index interposer 	<p>Form keylever or adjust machine within covers with foot brackets (65-30).</p> <p>Replace</p> <p>Replace</p> <p>Install paper deflector properly on studs.</p> <p>Install feed rollers properly.</p> <p>Replace link or clevis; and adjust</p> <p>Remove binds (19-4)</p>	<p>Paper deflector ends broken or bent.</p> <p>Check feed rollers for wear, and cracks.</p> <p>Observe interposer moving towards the rear of machine when index keybutton is depressed.</p>
Platen indexes incorrect amount.	<ol style="list-style-type: none"> 1. Wrong platen installed 2. Platen binding on covers 	<p>Ratchet on platen may not match index pawl (94-12) or detent (94-11).</p> <p>Form keylever or adjust machine within covers with foot brackets (65-30).</p>	

INDEXING

SYMPTOM	POSSIBLE CAUSE	REMEDY	REMARKS
<p>Platen indexes incorrect amount (Continued)</p>	<p>3. Binds in platen bushings and platen latches(81-13)</p> <p>4. Overthrow stop broken or maladjusted.</p> <p>5. Paper too heavy or thick</p> <p>6. Card holder too close to platen.</p> <p>7. Feed rolls (93-9) or platen cracked or worn from age.</p> <p>8. Too much feed roll tension. (93-14)</p> <p>9. Index pawl springs off. (94-13)</p>	<p>Clean and lubricate platen bushings.</p> <p>Replace or adjust stop (93-11)</p> <p>Platen and feed rollers may be worn and or old.</p> <p>Adjust card holder for .010" clearance between card holder and platen.</p> <p>Replace</p> <p>Adjust tension springs on late level machine for less tension.</p> <p>Replace</p>	<p>Adjustment:</p> <ol style="list-style-type: none"> 1. Loosen overthrow stop - move to front of machine. 2. Rotate index cam on high point. 3. Adjust overthrow stop to the rear against index pawl, leaving a slight clearance.

INDEXING

SYMPTOM	POSSIBLE CAUSE	REMEDY	REMARKS
<p>Platen indexes incorrect amount</p>	<p>10. Index link or clevis broken, damaged or maladjusted.</p>	<p>Replace link and or clevis and or adjust.</p>	<p>Adjustment:</p> <ol style="list-style-type: none"> 1. Loosen overthrow stop (93-11) and move it to the front of machine. 2. Install feed rolls, platen and paper in machine. 3. With spring hook, hold ratchet detent (94-11) away from platen ratchet. 4. Depress carrier return key-button. 5. Rotate machine, with turning wheel, one complete cycle. 6. Slowly, let detent engage ratchet, platen ratchet should not move. <p>Adjust link (93-10) for no movement of ratchet.</p> <p>After adjusting the index link, readjust overthrow stop; For adjustment go back to cause 4.</p>

INDEXING

SYMPTOM	POSSIBLE CAUSE	REMEDY	REMARKS
Carrier return operates when index keybutton is depressed.	1. Carrier return keylever pawl (18-12) overlapped with index keylever pawl (18-13).	Reposition keylever pawls correctly.	
Index gets extra cycles.	<ol style="list-style-type: none"> <li data-bbox="380 505 856 597">1. Index keybutton binding on top cover. <li data-bbox="380 597 856 760">2. Worn interposer latch plate or latch. <li data-bbox="380 760 856 938">3. Interposer restoring bail not transferring enough motion to index interposer. <li data-bbox="380 938 856 1084">4. Not enough bite on clutch release arm. <li data-bbox="380 1084 856 1552">5. Index keylever pawl and carrier return keylever pawl overlapped. 	<p data-bbox="856 505 1430 630">Adjust keybutton by forming or adjust machine within covers with foot brackets (65-30).</p> <p data-bbox="856 630 1430 760">Replace latch plate (30-28) or latch (30-29).</p> <p data-bbox="856 760 1430 938">Adjust restoring bail (29-26) by forming adjustable lugs (29-27) so interposer (19-4) will overthrow latch plate (30-28).</p> <p data-bbox="856 938 1430 1084">Adjust function cams (95-15) to the left to provide more bite for clutch release arm.</p> <p data-bbox="856 1084 1430 1552">Reposition index keylever pawl (18-13) and carrier return pawl (18-12) to correct positions.</p>	

MACHINE LOCKED-UP

SYMPTOM	POSSIBLE CAUSE	REMEDY	REMARKS
Machine locked up.	<ol style="list-style-type: none"> 1. Machine not plugged in or no power at outlet. 2. Motor, on-off switch or wiring defective. 3. On-off switch link. 4. Motor pawl springs off. (3A-7) 5. Motor pawl pulley frozen to motor shaft (3A-5). 6. Broken drive belt (6-7) 7. Cycle clutch spring broken or damaged(50-45) 8. Too much end play in cycle shaft, causing cycle clutch spring loop to drop between cycle shaft and cycle clutch pulley hub. 9. Not enough cycle clutch end play - causes binds 	<p>Check A. C. power at outlet.</p> <p>Check wires using continuity check.</p> <p>Check for binds or broken on-off switch link.</p> <p>Replace damaged or missing springs.</p> <p>Remove motor pulley from motor shaft, clean and lubricate.</p> <p>Replace</p> <p>Replace</p> <p>Replace cycle clutch spring shim cycle clutch shaft to control end play.</p> <p>Adjust end play of cycle shaft for minimum clearance - no binds</p>	<p>Bypass switch to check for defects.</p> <p>If spring is missing on pawls - the motor may not build up enough momentum to start properly.</p> <p>Check for nylon insert between motor pulley and motor shaft. It prevents pulley from freezing to shaft.</p> <p>Early model machines use shims to control end play. Late level machines use a collar (1-1).</p> <p>End play is controlled by shims or a collar (1-1).</p>

MACHINE LOCKED-UP KEYBOARD LOCKED

SYMPTOM	POSSIBLE CAUSE	REMEDY	REMARKS
Machine locked up.	10. Shift spring dropped loop between shift arbor (3-2) and shift cam. 11. For further causes refer to keyboard section.	Replace shift spring - adjust shift arbor for minimum clearance - no binds.	
Keyboard locked	1. Broken drive belt (6-7) 2. Motor pawl springs damaged or broken (7-8). 3. Motor pulley frozen to shaft (3A-6). 4. Interposer latched down, but did not release cycle clutch (55) 5. Compensator (57-13) tube jammed or maladjusted. 6. Character interrupter damaged or maladjusted (49-40).	Replace drive belt Replace Remove pulley, clean and lubricate. Adjust cycle clutch latch keeper (54-8) to release cycle clutch latch link (54-9) as interposer is latched down (55). Adjust end plugs so keybuttons are easily depressed without allowing two keys to be depressed at the same time. SEE "Random malselection, cause 27".	In order to replace drive belt - remove cycle clutch shaft. Check for nylon sleeve between pulley and motor shaft. Keeps motor pulley from freezing to shaft

KEYBOARD LOCKED

SYMPTOM	POSSIBLE CAUSE	REMEDY	REMARKS
Keyboard locked	7. Carrier return print interlock (58-14)	Adjust print interlock up and down shaft so character interrupter pawl (49-40) will prevent printing during carrier return operation.	It may be interfering with cycle clutch.
	8. Keyboard lockout bell-crank binding (52-7).	Remove binds; also check interlock bail lever (53-4).	
	9. Cycle clutch latch keeper (54-8)	Loosen screws (58-16) and adjust keeper bracket up and down until cycle clutch latch has a full bite on cycle clutch sleeve (59-17).	Insufficient bite could cause extra cycles.
	10. Cycle clutch keeper bracket. (60-18).	Check for damage.	
	11. Cycle bail upstop(61-19)	Adjust cycle bail upstop (61-19) so latch pawl (54-20) is held by 1/2 thickness of keeper (54-8).	
	12. Shift arm not detenting.	See Shift section.	Clearance between shift arbor and shift cam should be minimum; no binds.
	13. Shift clutch spring dropped between arbor and cam (62-22).	Replace shift spring and adjust shift arbor (62-23).	
14. No lubrication on cycle clutch spring (50-45).	Lubricate with recommended grease (50-45).		

KEYBOARD LOCKED

SYMPTOM	POSSIBLE CAUSE	REMEDY	REMARKS
<p>Keyboard locked</p>	<p>15. Cycle clutch sleeve end play (63-24).</p>	<p>Loosen clamp (63-26) and adjust overthrow stop left or right for clearance between sleeve(63-24) and cycle clutch pulley (63-27)</p>	<p>If cycle clutch end play is not maintained - the cycle clutch might hesitate to release and the machine will feel sluggish.</p>
	<p>16. Cycle clutch overthrow (63-25).</p>	<p>Loosen clamp (63-26) and rotate overthrow stop radially (63-25) for clearance of .010" between, at point (63-28), sleeve (63-24) and overthrow stop.</p>	<p>Overthrow stop controls the rest position of filter shaft, cycle shaft, and print shaft. Too much overthrow could prevent the depression of keybuttons.</p>
	<p>17. Cycle clutch latch bracket maladjusted. (64-29).</p>	<p>Adjust bracket up and down according to the #3 scribe line on the Hooverometer . (135-29)</p>	<p>If latch is too low, cycle clutch might not release or machine will have a sluggish feeling.</p> <p>If latch is too high, could cause extra cycles.</p>
	<p>18. Cycle clutch latch worn or broken (59-15).</p>	<p>Replace latch</p>	
	<p>19. Bell clapper bellcrank (53-6).</p>	<p>Bellcrank is screwed to the left end of lockout bail (53-4). If bellcrank becomes jammed, it could lock keyboard.</p>	

KEYBOARD TOUCH INCORRECT

SYMPTOM	POSSIBLE CAUSE	REMEDY	REMARKS
<p>Keyboard touch incorrect.</p>	<ol style="list-style-type: none"> 1. Top cover binding on keybuttons. 2. Cycle clutch and machine needs lubricating. 3. Cycle bail upstop (61-19) 4. Keylever restoring springs off (66-31) 5. Cycle clutch latch (59-15) 6. Compensator tube jammed or maladjusted (57-13). 7. Damper springs (53-32) damaged or missing from cycle bail (53-33). 	<p>Loosen machine foot brackets (65-30) to adjust machine within covers.</p> <p>Lubricate machine completely.</p> <p>Adjust cycle bail upstop (61-19) so latch pawl (54-20) is held by 1/2 thickness of keeper (54-8).</p> <p>Replace springs on keylevers</p> <p>Loosen screws (58-16) and adjust keeper bracket up and down until cycle clutch latch has a full bite on cycle clutch sleeve (59-17).</p> <p>Adjust end plugs (57-13) so keys are easily depressed without allowing two keybuttons to be depressed at the same time.</p> <p>Replace spring</p>	<p>Insufficient bite could cause extra cycles.</p> <p>Too much bite could cause the cycle clutch not to release - causes hard touch and sluggish machine.</p> <p>Could cause cycle bail to bounce, causing extra cycles.</p>

KEYBOARD TOUCH INCORRECT

SYMPTOM	POSSIBLE CAUSE	REMEDY	REMARKS	
Keyboard touch incorrect. (Continued)	8. Keyboard lockout bail damaged or maladjusted (53-4).	Check and adjust lockout bail to lock keyboard when carrier is at right margin.		
	9. Keyboard lockout bell-crank (52-7).	Check for binds, also check inter-lock bail lever (53-4).		
	10. Filter shaft timing (55)	See alignment section		Filter shaft may be restricting the movement of the interposer.
	11. Worn or damaged cycle clutch spring (50-45).	Replace		
	12. Drive belt	Check belt for missing or damaged teeth (6-7).		Adjust belt for slight deflection by moving moving motor mount brackets (3A-8).
	13. Bail mounting plate (52-33).	Adjust left bail mounting plate (52-33) up or down to parallel bails to interposers.		
	14. Cycle clutch restoring	Adjust cycle clutch restoring stud (50-34) so cycle clutch latch pawl (54-20) overthrows latch keeper approximately .020".		Check both sides of restoring cam.
	15. Cycle clutch overthrow	SEE "Keyboard locked, cause 16 section".		
16. Lack of lubrication on machine.	Lubricate machine thoroughly.			

KEYBOARD TOUCH INCORRECT

SYMPTOM	POSSIBLE CAUSE	REMEDY	REMARKS
<p>Keyboard touch incorrect.</p> <p>(Continued)</p>	<p>17. Cycle clutch sleeve end play.</p> <p>18. Front keylever guide comb (68-36).</p> <p>19. Bell clapper bellcrank (53-6)</p>	<p>See "Keyboard locked, cause 15 section".</p> <p>Adjust guide comb (68-36) up or down for approx. .030" clearance between keylever pawl (67-35) and interposer.</p> <p>Check for interference with keyboard lockout bail (53-4).</p>	
<p>Flicking</p>	<p>1. Filter shaft timing (55)</p> <p>2. Interposer latch springs bent, broken or maladjusted.</p> <p>3. Cycle clutch keeper damaged or maladjusted.</p> <p>4. Cycle clutch keeper bracket (60-18)</p> <p>5. Cycle bail upstop (61-19)</p>	<p>See alignment section</p> <p>Repair or replace springs (56-11)</p> <p>See Flicking in "Special section".</p> <p>Check for damage and adjust:</p> <p>Loosen screws (58-16) and adjust keeper bracket up and down until cycle clutch latch has a full bite on cycle clutch sleeve (59-17).</p> <p>Adjust cycle bail upstop (61-19) so latch pawl (54-20) is held by 1/2 thickness of keeper (54-8).</p>	<p>Insufficient bite could cause extra cycle or a hyphen to print.</p>

RANDOM MALSELECTION

SYMPTOM	POSSIBLE CAUSE	REMEDY	REMARKS
Malselection, random	1. Broken or cracked type-head (36).	Replace or repair	2. Latch springs on element broken.
		1. Typehead could cause problems if the silver coating wears off.	3. Cap broken or loose.
	2. Broken bias spring in tilt ring (44-31).	Replace	Bias spring is in current level tilt ring - remove upper ball socket (41-25) to check bias spring.
	3. Typehead needs lubricating (36).	Lubricate with grease.	Grease inner circumference of typehead. (36)
	4. Gear train	Adjust gear train (47-34)	See alignment section.
	5. Typehead homing	See alignment section	
	6. Skirt clearance	See alignment section	
	7. Rotate link	See alignment section	
	8. Rotate arm motion	See alignment section	
	9. Shift motion	See alignment section	
	10. Tilt arm motion	See alignment section	
	11. Tilt homing	See alignment section	
	12. Fine timing	See alignment section	
	13. Snapping latches	See alignment section	
14. Broken springs on tilt or rotate latch (45-32)	Replace		

RANDOM MALSELECTION

SYMPTOM	POSSIBLE CAUSE	REMEDY	REMARKS
Malselection, random	15. Filter shaft timing (55)	See alignment section	
	16. Broken rotate spring (46-33)	Replace	Rotate spring is removed from bottom side of carrier.
	17. Binds in tilt and rotate detents.	Adjust tilt screws (38-46) and rotate detent screw (38-20)	Adjust for minimum clearance - no binds.
	18. Set screw in rotate pulley loose.	Tighten screw (43-30)	After screw is tighten - recheck rotate alignment adjustments.
	19. Worn dogbone (42-28), upper ball socket (41-25) or lower ball socket (42-27).	Replace	This wear can be checked by observing headplay. (See excessive headplay section).
	20. Shift cam backup roller worn or loose (48-39).	Replace	Worn backup roller causes rotate detenting to change - normally in upper case.
	21. Rotate spring tension (46-33).	See alignment section	Rotate spring may be broken.
	22. Tilt ring spacer (41-26)	Adjust tilt ring spacers for no binds.	Maybe binding against upper ball socket (41-25) or inside of element
	23. Tilt ring pivot pins worn or maladjusted (39-21)	Remove and check for wear - replace.	Pins are adjusted to center the tilt ring (39-23) between yoke extensions (39-22).
24. Binds in rotate or tilt pulleys.	Remove binds and lubricate		

RANDOM MALSELECTION

SYMPTOM	POSSIBLE CAUSE	REMEDY	REMARKS
<p>Malselection, random</p>	<p>25. Rotate spring cage gummy.</p> <p>26. Cycle clutch drive (50-45)</p> <p>27. Character interrupter maladjusted or broken</p>	<p>Flush cage (46-33) with cleaning solution.</p> <p>Lubricate cycle clutch with recommended grease.</p> <p>1. Loosen screw (49-42) and nut (49-41), adjust character interrupter pawl (49-40) for clearance between pawl (49-40) and cycle clutch link (49-44).</p>	<p>Adjust clutch - See alignment section.</p> <p>2.-1. Remove electrical cord from outlet.</p> <p>2. Depress character key to release cycle clutch.</p> <p>3. Loosen screw (49-43) and adjust for .001" clearance between cycle clutch link (49-44) and character interrupter pawl (49-40).</p>

MALSELECTION - CONSISTENT

SYMPTOM	POSSIBLE CAUSE	REMEDY	REMARKS
Malselection, consistent	1. Broken or cracked type-head (36).	Replace or repair	2. Latch springs on element broken.
		1. Typehead could cause problems if the silver coating wears off.	3. Cap broken or loose.
	2. Broken bias spring in tilt ring. (44-31)	Replace	Bias spring is in current level tilt ring - remove upper ball socket (41-25) to check bias spring
	3. Skirt clearance	See alignment section	
	4. Tilt homing	See alignment section	
	5. Tilt arm motion	See alignment section	
	6. Tilt detent link broken or loose.	Replace or repair link (46-46)	
	7. Typing element binding on ribbon feed plate.	Check and adjust:	
		1. Fine timing	See alignment section.
		2. Powered & free flight adjustments.	See "Noise during print cycle only, cause f."
	8. Selector latch links(51-46)	See alignment section	
	9. Latch stop pads (40-25)	See alignment section	
10. Typehead homing	See alignment section		
11. Balance arm	See alignment section		
12. Rotate arm motion	See alignment section		

MALSELECTION - CONSISTENT

SYMPTOM	POSSIBLE CAUSE	REMEDY	REMARKS
<p>Malselection, consistent</p>	13. Rotate link	See alignment section	<p>Negative 5 latch (72-41) is not resetting over stop screw (72-42).</p> <p>Rotate spring is removed from bottom side of carrier</p> <p>Selectric II correcting typewriter only.</p>
	14. Negative 5 latch link	See alignment section	
	15. Latch interposer restoring spring missing or broken.	Replace spring (52-1)	
	16. Positive bail spring missing or broken.	Replace spring (51-2)	
	17. Check interposer stop lugs (52-3) and springs (52-1).	See alignment section	
	18. Broken rotate spring (46-33)	Replace	
19. Separator wire damaged or maladjusted (13)	<p>Adjust or replace</p> <p>Adjust so:</p> <ol style="list-style-type: none"> 1. Separator wire clears the type-head at the half cycle point. 2. It just contacts the card holder 3. It moves away from the card holder when the ribbon load lever is activated for the correctable ribbon. 		

MACHINE NOISY

SYMPTOM	POSSIBLE CAUSE	REMEDY	REMARKS
1. Noise	Lack of lubrication	Lubricate machine	Use recommended grease and oil lubricants
2. Noise due to binds	a) Cycle clutch end play (1)	Adjust the cycle clutch for minimum clearance - no binds using the collar or shims on the left side of cycle clutch (1-1)	The collar or shims are located between the cycle clutch left bearing and the rebound check pawl ratchet. Check end play by using duck bill pliers on the cycle clutch cams.
	b) Operational shaft end play (2)	Adjust the operational shaft end play - minimum play; no binds (2)	The end play is controlled on 13" and 15" machines by the shift arbor (3-2) and the collar (3B-3) on the right side of the operational shaft. On 11" machines by the shift arbor and the function cams (3B-4)
	c) Shift clutch spring clearance (3)	Adjust shift clutch spring retaining plate (3-3). Loosen two screws (3-4) holding retaining plate and slightly rotate spring in unwinding direction.	When you adjust shift spring, your objective is more clearance between shift spring (3-1) and shift arbor (3-2). Overthrow stop must be checked or readjusted (3-5).
3. Noise Operational shaft	Sleeve at left end of operational shaft worn or missing (6)	Replace sleeve	Remember when trying to remove operational shaft; there is a "C" clip (6-5) on the right side of carrier return pinion gear. Some machines have "C" clips on both sides of carrier return pinion gear (6-6).

MACHINE NOISY

SYMPTOM	POSSIBLE CAUSE	REMEDY	REMARKS
4. Noise	<p>a) Cold machine</p> <p>b) Covers unlatched</p> <p>c) Platen binding on cover</p> <p>d) Motor pawls hitting cover (3A-7)</p> <p>e) Deflector or paper table vibrating (3C-1)</p> <p>f) Shift arbor too close to shift cam (3-2).</p> <p>g) Shift arbor (3-2) and or "e" clip (4-1).</p> <p>h) Machine not centered in covers properly.</p> <p>i) Plastic feet on bottom of machine lower than rubber feet on bottom cover.</p>	<p>When machine is cold, some lubricants thicken and loose effectiveness.</p> <p>Check latches for damage and fasten covers.</p> <p>Adjust platen knobs or machine covers.</p> <p>Adjust covers, check motor mounts.</p> <p>Adjust - be sure each side is properly mounted. Check springs on each side of paper table.</p> <p>Adjust shift cam backup roller (not adjustable on all models)</p> <p>Lubricate</p> <p>Adjust machine within covers.</p> <p>Adjust plastic feet.</p>	<p>If noise is caused by machine being cold - machine may need to be cleaned and relubricated with recommended lubricants.</p> <p>On early machines, top cover latch screws may be loose.</p> <p>Top cover latches could be broken on early machines.</p> <p>Also check motor pawl springs for damage (3A).</p> <p>The deflector pan is under the platen. The paper table is the graduated bar above the platen.</p> <p>Check shift arbor for burrs (3-2)</p> <p>Lubricate shift arbor and "e" clip with grease. Oil may cause shift malfunction.</p> <p>Machine has adjustable mounting brackets (4-2). Rear rubber mounts could be missing or damaged.</p> <p>Check adjustment of typewriter mounting brackets (4-2).</p>

MACHINE NOISY

SYMPTOM	POSSIBLE CAUSE	REMEDY	REMARKS
4. Noise (con't)	j) Cam pawl (5-3) hitting cam ratchet (5-4)	Adjust cam pawl clearance by rotating eccentric adjustment until noise stops (5-5).	There are two locking screws (5-5) that must be loose before adjusting cam pawl clearance.
5. Noise (Motor)	a) Drive belt too loose or too tight (6-7) b) Motor touching machine or brackets. c) Nylon bushing missing or worn (3A). d) Pawls hitting drive belt (3A-7) e) Motor mounts worn or hard (3A). f) Fan blade inside motor hitting against housing	Adjust drive belt by moving motor mounts brackets. Adjust or rotate motor within brackets. Replace bushing - It is located between motor pulley and motor shaft. Check pawls (3A-7) for wear - adjust so pawls rotate freely without contacting pulley. Replace motor mounts. Remove motor - disassemble and check for loose parts.	Also check motor belt for missing cog teeth. Motor mounts could be worn or damaged. Remove drive belt (6-7) and motor pulley (3A-6) in order to check nylon bushing. This adjustment must be checked manually. Also check pawl springs for wear and damage (7-8). Sometimes flywheel moves out of position and contacts motor housing.

MACHINE NOISY

SYMPTOM	POSSIBLE CAUSE	REMEDY	REMARKS
<p>6. Noise in upper case shift position</p>	<p>a) No lubrication</p> <p>b) Operational shaft end play (5-6)</p> <p>c) Shift arbor damaged or loose (3-2).</p> <p>d) Shift cam bearing (8-9).</p> <p>e) Not enough clearance between shift arbor (3-2) and spring (3-1).</p>	<p>Lubricate shift mechanism completely.</p> <p>Adjust operational shaft end play for minimum clearance - no binds.</p> <p>Replace or tighten</p> <p>Adjust or replace</p> <p>Adjust shift clutch spring retaining plate (3-3).</p>	<p>Use only grease on shift spring.</p> <p>End play is controlled on 13" and 15" machines by shift arbor (3-2) and a collar (3B-3) set screwed to right side of operational shaft. On 11" machines the end play is controlled by the shift arbor (3-2) and function cams (3B-4).</p> <p>If shift arbor is loose - readjust operational shaft end play (5-6).</p> <p>If the bearing can be adjusted - there will be a set screw on inside of shift bearing, near collar on right side of operation shaft.</p> <p>Loosen two screws (3-4) holding retaining plate and rotate spring in unwinding direction until noise stops. Check shift overthrow stop adjustment (3-4).</p>

MACHINE NOISY

SYMPTOM	POSSIBLE CAUSE	REMEDY	REMARKS
<p>7. Noise during print cycle only</p>	<p>a) Skirt clearance b) Gear train backlash c) Loose drive belt (6-7) d) Binds in tilt or rotate pulleys. e) Correcting seperator wire damaged or maladjusted . f) Powered and Free flight adjustments incorrect (35-1)</p>	<p>See Alignment Section Adjust gear train for maximum mesh - no binds Adjust drive belt by moving motor mount brackets. Check pulleys for binds and lubricate. Adjust or replace correcting seperator wire (13) Check or adjustment procedure: 1. Put multiple copy control lever to front position. 2. Put impression control lever in #4 position. 3. With machine at rest, adjust detent plate (35-40) so the short leg on the hooverometer spans the distance between the element and platen. 4. With machine half cycled - adjust the eccentric (35-41) until .035" spans the distance</p>	<p>See Alignment Section Seperator wire should be formed so: 1. It clears the typehead at the half cycle point. 2. It just contacts the card holder 3. It moves away from the card holder when the ribbon load lever is activated for the correctable ribbon. A maladjustment here can cause the typing element to break. Adjustment 3 and 4 must be performed alternately until both adjustments are correct. between element and platen.</p>

FILM RIBBON

SYMPTOM	POSSIBLE CAUSE	REMEDY	REMARKS
<p>Print on paper too light.</p>	<ol style="list-style-type: none"> 1. Check quality of ribbon 2. Ribbon folding 3. Characters typing over same area on ribbon. 	<p>Some ribbons have varied amounts of ink content. Check for variation or bad spots on ribbon.</p> <ol style="list-style-type: none"> 1. Dirty or binding ribbon guides (128-20). 2. Dirty or binding shock wire sleeve (128-21). <p>See "Ribbon will not feed section".</p>	<ol style="list-style-type: none"> 3. Adjust right guide on ribbon plate - form for proper tracking. 4. Ribbon lift binding (128-20) or hitting card holder.
<p>Ribbon will not feed.</p>	<ol style="list-style-type: none"> 1. Ribbon feed pawl spring broken or missing. 2. Ribbon feed pawl binding on ribbon plate (129-25). 3. No lubrication 4. Ribbon drive spring broken, weak or dirty. 5. Ribbon feed & lift wheel (111-30) not being held by detent after feed operation 	<p>Replace feed pawl spring (129-24)</p> <p>Adjust ribbon plate (129-26) left or right to prevent feed pawl from binding (129-25).</p> <p>Clean and lubricate ribbon mechanism completely.</p> <p>Replace drive spring; or clean and check spring (128-24).</p> <p>Adjust ribbon feed cam follower stud (129-27) so ribbon feed and lift wheel (111-30) will not rotate beyond detent position on ribbon lift wheel.</p>	

FILM RIBBON

SYMPTOM	POSSIBLE CAUSE	REMEDY	REMARKS
Ribbon will not feed.	6. Ribbon feed pawl eccentric (129-27) loose, broken or maladjusted. 7. Ribbon corner guide binding on ribbon spool.	Adjust pawl eccentric (129-27) until feed pawl (129-25) drives ribbon feed & lift wheel to next detent position (111-30). Form corner guide (128-22) to prevent binding on ribbon spool.	The ribbon feed & lift wheel has windows in it. The detent uses the windows to prevent the ribbon feed & lift wheel from rotating backwards. Each time the machine cycles the ribbon moves one detent position. This method is used on early level machines.
Machine will not print full character.	1. Ribbon lift binding on card holder. 2. Ribbon lift guides binding rivets, causing ribbon to fold. 3. Ribbon folding 4. Ribbon flat links broken or damaged (105-14) 5. Ribbon not feeding properly. 6. Spring off ribbon lift control link.	Adjust card holder to rear to prevent binding on ribbon lift (128-20). Clean and free guides of binds. (128-20). Clean shock wire and sleeve. (128-21). Replace ribbon lift guides (105-13) See "Ribbon will not feed" section. Replace spring (105-15)	Adjust shock wire for slight angle.

FABRIC RIBBON

SYMPTOM	POSSIBLE CAUSE	REMEDY	REMARKS
Print on paper too light.	<ol style="list-style-type: none"> 1. Ribbon worn or old. 2. Check quality of ribbon being used. 3. No lubrication 4. Ribbon spools or feed pawl binding. 5. Adjust brake spring tension (103-3). 	<p>Replace</p> <p>Ink content of ribbons vary from different manufacturers.</p> <p>Lubricate ribbon mechanism</p> <p>Check movement of feed pawl (103-2) and spools (103-1).</p> <p>Adjust brake spring tension(103-3) so ribbon will wind taut.</p>	<p>Noticable at the end of ribbon, before reversing.</p>
Ribbon will not feed.	<ol style="list-style-type: none"> 1. Ribbon selector lever in stencil position. 2. Ribbon exhausted on one spool - machine did not reverse. 3. Ribbon feed pawl binding on ribbon plate. 4. Ribbon feed plate loose or maladjusted (104-6). 5. Ribbon feed pawl spring missing or broken. 	<p>Place ribbon lever in lift position (104-5).</p> <p>See "Ribbon will not reverse section".</p> <p>Adjust feed pawl (103-2) and ribbon plate (104-6) left to right to remove binds.</p> <p>Tighten screws on late model ribbon mechanism (103)</p> <p>Replace feed pawl spring (104-7) (103-8).</p>	<p>Adjust early model ribbon plates (104-6) back and forth until the ribbon spool (103-1) is driven 2 teeth plus .010" while rotating the turning wheel.</p>

FABRIC RIBBON

SYMPTOM	POSSIBLE CAUSE	REMEDY	REMARKS
Ribbon will not feed.	6. Ratchet detent lever springs missing or broken. 7. Ratchet detents (103-4) (104-9) not holding ratchet spools (103-1).	Replace detent springs (104-9) (103-4). Check detent lever for damage and binds (103-4) (104-9).	Ratchet detent spring for figure (103) is under front part of ribbon plate.
Ribbon will not reverse.	1. Lack of lubrication 2. Missing or broken springs binds on ribbon plate (104-6). 3. Ribbon brake tension. 4. Binds in reversing triggers (105-11). 5. Not enough spring tension on ribbon reverse trigger	Clean & Lubricate ribbon mech. completely. Check carefully and replace springs or remove binds in mech. Adjust ribbon brake tension by varying brake spring tension (103-3) on ribbon spools (103-1) Clean & check reversing trigger springs Check reverse trigger (105-11) and reverse trigger spring (105-12)	Causes ribbon reversing to occur at varying points. Reversing springs (105-12) are necessary to activate reverse trigger (105-11). Reverse trigger spring causes trigger to pivot down and contact feed plate when ribbon on that spool is exhausted.

FABRIC RIBBON

SYMPTOM	POSSIBLE CAUSE	REMEDY	REMARKS
<p>Machine not printing full character.</p>	<ol style="list-style-type: none"> 1. Ribbon lift control link (105-16) 2. Ribbon lift guides binding at rivets. 3. Ribbon lift binding on card holder. 4. Ribbon folding 5. Ribbon lift cam timing off (106-17). 6. Ribbon flat links broken (105-14). 7. Spring off ribbon lift control link. 	<p>Adjust ribbon lift control link (105-16) for proper lifting of ribbon.</p> <p>Clean and free guides of binds (71-41).</p> <p>Adjust card holder to prevent binds.</p> <p>Clean and check lift guides.</p> <p>Adjust fine timing (See alignment section).</p> <p>Replace ribbon lift guides (105-13)</p> <p>Replace spring (105-15).</p>	<p>Also check ribbon folding within cartridge.</p>

SELECTIVE RIBBON

SYMPTOM	POSSIBLE CAUSE	REMEDY	REMARKS
Machine will not print full character.	<ol style="list-style-type: none"> 1. Ribbon folds over 2. Ribbon lift failure 3. Spread adjusting plate loose or broken. 4. Ribbon lift adjusting screw loose or maladjusted. 	<ol style="list-style-type: none"> 1. Adjust tracking of ribbon, so it will not bind on inside of cartridge. 2. Clean and remove binds (107-20) in shock wire and ribbon guides (110-27). 1. Replace worn lift lever (112) (108-21) 2. Replace broken ribbon guides (110-27). <p>Adjust spread plate (110-26) for more or less spread between lift positions.</p> <p>Adjust ribbon lift adjusting screw, to raise or lower ribbon.</p>	<ol style="list-style-type: none"> 3. Adjust retaining clips (107-28) to securely hold cartridge on. 4. Replace broken ribbon guides (110-27). 3. Replace broken or missing ribbon lift bias springs(107-32). 4. Ribbon load lever spring missing or broken (107-33). <p>The selectric II has 3 lift positions. The spread adjusting plate controls the distance between these lift positions.</p>
Stencil lever will not operate.	<ol style="list-style-type: none"> 1. Stencil lever forced to the left and out of ribbon plate. 2. Stencil lever will not operate. 	<p>Reinstall stencil lever back in ribbon plate (111-36).</p> <p>Observe:</p> <ol style="list-style-type: none"> 1. That ribbon lift cam follower roller(113-37) has clearance to move laterally across lift cam (109-34). The roller should move to right, out of contact with lift cam (109-34) 	<ol style="list-style-type: none"> 2. That the ribbon lift control lever (108-21) prevents ribbon feed pawl from operating. Lug on lift control lever prevents feed pawl from operating.

SELECTIVE RIBBON

SYMPTOM	POSSIBLE CAUSE	REMEDY	REMARKS
<p>Print on paper too light.</p>	<p>1. Ribbon cartridge projection mode actuator broken (13 -28)</p>	<p>Replace ribbon.</p>	
	<p>2. Oil on ribbon</p>	<p>Replace ribbon</p>	
	<p>3. Ribbon not installed around shock wire.</p>	<p>Install ribbon around shock wire (107-20).</p>	<p>Prevents ribbon from feeding.</p>
	<p>4. Worn ribbon lift lever (108-21)</p>	<p>Replace lift lever (108-21)</p>	<p>Causes characters to overlap between lift positions.</p>
	<p>5. Loose lift control mounting post.</p>	<p>Replace ribbon plate (108-22).</p>	
	<p>6. Ribbon feed gears worn or broken.</p>	<p>Replace feed gears (108-23)</p>	<p>In order to check teeth on gears, remove gears for inspection.</p>
	<p>7. Ribbon feed cam follower eccentric loose or maladjusted.</p>	<p>Adjust cam eccentric (109-24) to drive feed pawl and ribbon feed & lift wheel to the next detent position on the wheel (111-30).</p>	
	<p>8. Broken or damaged spiked driver.</p>	<p>Replace spiked driver (108-25)</p>	<p>Broken spiked drivers are also caused by using incompatible ribbons.</p>
	<p>9. Spread adjusting plate broken, loose or maladjusted (110-26)</p>	<p>Adjust spread plate (110-26) for more or less spread between lift positions.</p>	<p>The selectric II has 3 lift positions the spread adjusting plate controls the distance between these lift positions.</p>
	<p>10. Wobbler bellcrank broken.</p>	<p>Replace wobbler bellcrank(108-27)</p>	<p>Check movement of wobbler bellcrank from one mode to the other.</p>

SELECTIVE RIBBON

SYMPTOM	POSSIBLE CAUSE	REMEDY	REMARKS
Print on paper too light.	11. Cartridge guides and retaining springs not holding cartridge securely (107-28).	Adjust and form cartridge retaining springs.	
Ribbon advances too far (Causes wasted ribbon)	1. Mode buttons binding. 2. Wobbler bellcrank broken or damaged. 3. Feed cam eccentric (109-24)	Replace any damaged mode buttons and remove any binds (111-31). Replace (108-27) Adjust feed cam eccentric(109-24) for proper ribbon feed.	If mode buttons are binding, there will be no gear ratio change for ribbon feed. Wobbler bellcrank is not restoring to latched rest position for film ribbon mode. Drive pawl should move ribbon feed & lift wheel (111-30) to the next detented position.
Ribbon will not feed properly.	1. Check ribbon cartridge for mode projection extension. 2. Worn or damaged feed gears. 3. Spiked driver broken 4. Take-up spool inside cartridge not winding up used ribbon evenly.	If mode projection is missing - change. Replace gears (108-23) Replace driver (108-25) Clean and lubricate ribbon mech. Check and adjust for tracking.	Mode projection is on the cartridge of blue core ribbon. Remove gears to inspect for damage. Some broken spiked drivers are broken due to quality of ribbon being used. If ribbon doesn't track properly, ribbon could fold and or bind inside of cartridge.

SELECTIVE RIBBON

SYMPTOM	POSSIBLE CAUSE	REMEDY	REMARKS
<p>Ribbon will not feed properly.</p>	<p>5. Broken ribbon lift guide</p>	<p>Replace ribbon guide (110-27)</p>	<p>Guide pins in ribbon guides fall out due to cracking of ribbon lift guides.</p>
	<p>6. Ribbon feed pawl eccentric loose or maladjusted</p>	<p>Adjust ribbon feed pawl eccentric (109-24) for proper ribbon feed.</p>	<p>The feed pawl (109-29) drives the ribbon feed and lift wheel (111-30)</p>
	<p>7. Ribbon not installed around shock wire.</p>	<p>Install ribbon properly around shock wire (107-20).</p>	<p>Shock wire controls ribbon supply spool detenting, which keeps the ribbon winding taut (107-20).</p>
	<p>8. Binds in ribbon mode buttons (111-31).</p>	<p>Check mode buttons for damage and binds (111-31).</p>	<p>Mode buttons control ribbon feed gear ratio change - this controls the amount of ribbon feed.</p>

RIBBON

SYMPTOM	POSSIBLE CAUSE	REMEDY	REMARKS
Load lever will not latch.	<ol style="list-style-type: none"> 1. Ribbon lift guides binding on card holder. 2. Load lever spring missing broken or damaged. (107-33). 3. Load lever detent broken, missing or damaged. 	<p>Adjust card holder to rear for clearance with ribbon lift (105-13)</p> <p>Replace</p> <p>Replace or remove binds in detent (111-39) for load lever.</p>	
Machine will not go in stencil position.	<ol style="list-style-type: none"> 1. Stencil lever broken or binding (104-5). 2. Stencil lever lug not preventing ribbon drive. 3. Stencil lever not transferring lift control link to rear of lift cam follower. 	<p>Replace</p> <p>Stencil lever lug should prevent the cam follower from following the contour of the ribbon cam (106-18)</p> <p>Adjust lift control link (105-16) to move all the way to rear of cam follower when in stencil position.</p>	

HORIZONTAL ALIGNMENT INCORRECT

SYMPTOM	POSSIBLE CAUSE	REMEDY	REMARKS
<p>Horizontal alignment incorrect.</p> <p>Sample:</p> <p>Horizontal</p>	<ol style="list-style-type: none"> 1. Broken or cracked type-head. (36) 2. No lubrication inside element or typehead (36). 3. Typehead homing 4. Balance arm 5. Rotate arm motion 6. Rotate link 7. Shift motion 8. Fine timing 9. Broken rotate detent spring (37-3). 10. Excessive headplay 11. Skirt clearance 12. Lower ball socket(42-27) 13. Binds in rotate and or tilt detents. Also check for too much motion. 	<p>Replace or repair</p> <ol style="list-style-type: none"> 1. Typehead could cause problems if the silver coating wears off. <p>Lubricate with recommended grease.</p> <p>See alignment section</p> <p>See alignment section</p> <p>See alignment section</p> <p>See alignment section</p> <p>See alignment section</p> <p>Replace</p> <p>See "Excessive headplay section".</p> <p>See alignment section</p> <p>Replace</p> <p>Adjust tilt screws (38-46) and rotate detent screw (38-20).</p>	<ol style="list-style-type: none"> 2. Latch springs on element broken. 3. Cap broken or loose. <p>Recommended for bias tilt rings (39-23).</p> <p>Lower ball socket is held by bristol screw (43-30).</p> <p>Adjust for minimum clearance-no binds.</p>

HORIZONTAL ALIGNMENT INCORRECT

SYMPTOM	POSSIBLE CAUSE	REMEDY	REMARKS
Horizontal alignment incorrect (Continued)	14. Tilt ring pivot pins(39-21)	Remove and check for wear - if worn, replace	Pins are adjusted to center the tilt ring (39-23) between yoke extensions (39-22).
	15. Tilt ring spacers(41-26)	Binding against upper ball socket (41-25) or inside of element (36).	Adjust tilt ring spacers for no binds.
	16. Gear train	Adjust gear train for maximum mesh - no binds.	See alignment section.
	17. Broken bias spring in tilt ring (44-31).	Replace	Bias spring is in new or late level tilt ring - remove upper ball socket (41-25) to check bias spring.
	18. Tilt ring (39-23) not centered on yoke (39-22)	Loosen pivot pins (39-21) and center tilt ring between upper yoke extensions.	
	19. No lubrication on cycle clutch spring.	Lubricate cycle clutch (1) with recommended grease.	
	20. Loose drive belt	Adjust drive belt for small deflection and minimum noise.	Belt is adjusted with motor brackets. Adjust them back and forth. (3A-8)
21. Negative 5 latch screw	See alignment section		

SHIFT

SYMPTOM	POSSIBLE CAUSE	REMEDY	REMARKS
<p>Machine will not shift to upper case.</p>	<ol style="list-style-type: none"> 1. Shift key binding on cover (84-18) 2. Upper case shift spring off or damaged. 3. Worn or broken shift spring (62-22). 4. Shift clutch spring retaining plate loose or maladjusted. 	<p>Adjust machine within covers.</p> <p>Replace shift spring (84-20).</p> <p>Replace shift spring and lubricate.</p> <p>Retaining plate controls clearance between shift arbor (3-2) and shift spring (3-1).</p>	<p>Adjust with machine foot brackets (65-30).</p> <p>Loosen two screws (3-4) holding retaining plate (3-3) and rotate spring until machine detents properly in upper case position.</p> <p>Check shift detenting by:</p> <ol style="list-style-type: none"> 1. Turn machine on. 2. With your finger, push up on the front end of the shift detent arm (62-20) and rotate it away from the shift cam (62-21). 3. Shift machine to upper case and hold it there. 4. Slowly, allow the shift detent to return to the detent position on the shift cam. The reentry of the detent should not cause the shift cam to move.

SHIFT

SYMPTOM	POSSIBLE CAUSE	REMEDY	REMARKS
Machine will not shift to upper case. (Continued)	5. Shift arbor worn or loose (3-2)	Replace or tighten arbor.	If shift arbor is replaced, readjust operational shaft end play.
	6. Shift release	Observe shift release lever (69-40) releasing shift cam ratchet (62-24)	
	7. Shift interlock (69-38) holding shift cam ratchet (62-24).	Adjust shift interlock to release cam ratchet.	
	8. Shift ratchet (62-24) binding on release lever (69-40).	Adjust release lever (69-40) link, and or check for binds.	
	9. Overthrow stop broken or loose (69-42).	Replace or readjust overthrow stop (69-42).	With shift cam in detented position ; adjust a clearance of .020" between shift overthrow stop (69-42) and lug on shift ratchet (62-24).
	10. Filter shaft gear damaged or loose (47-34).	Replace and or readjust filter shaft (55).	See alignment section.
	11. Filter shaft out of adjustment.	Adjust filter shaft (55)	See alignment section.
	12. Shift brake broken or damaged (69-39)	Adjust shift brake for 1/2 bite on brake surface of shift cam.	

SHIFT

SYMPTOM	POSSIBLE CAUSE	REMEDY	REMARKS
<p>Keyboard locks after shifting.</p>	1. Shift lock	Check shift lock and spring (84-18)	
	2. Shift spring retaining plate (3-3)..	Check for damage and adjust shift plate (3-3).	For adjustment see "Machine will not shift to upper case", cause 4.
	3. No lubrication	Lubricate shift mechanism completely.	Lubricate shift spring only with grease.
	4. Overthrow stop (69-42)	Replace or adjust overthrow stop (69-42).	With shift cam in detented position adjust a clearance of .020" between shift overthrow stop (69-42) and lug on shift ratchet (62-24).
	5. Character interrupter (49-40)	1. Loosen screw (49-42) and nut (49-41), adjust character interrupter pawl (49-40) for clearance between pawl (49-40) and cycle clutch link (49-44).	<p>2. -1 Remove electrical cord from outlet.</p> <p>2 Depress character key to release cycle clutch.</p> <p>3 Loosen screw (49-43) and adjust for .001" clearance between cycle clutch link (49-44) and character interrupter pawl (49-40).</p>
	6. Shift arbor worn or loose (3-2).	Replace or tighten arbor.	If shift arbor is replaced, readjust operational shaft end play.

SHIFT

SYMPTOM	POSSIBLE CAUSE	REMEDY	REMARKS
Typewriter shifts up and down	<ol style="list-style-type: none"> 1. Shift spring broken (62-22) 2. Shift release arm broken or binding (69-40). 3. Shift spring clutch retaining plate broken (3-3) 	<p>Replace spring.</p> <p>Replace or release binds and lubricate (69-40).</p> <p>Replace and adjust.</p>	<p>For adjustment see "Machine will not shift to upper case, cause 4".</p>
Machine will not stay in upper case shift position.	<ol style="list-style-type: none"> 1. Shift latch plate worn or maladjusted (86-22). 2. Shift latch spring broken or missing. 3. Shift release mechanism binding. 	<p>Adjust shift latch plate (86-22) so shift will lock in upper case position and hold, when keybutton is depressed 2/3 distance.</p> <p>Replace and lubricate mechanism.</p> <p>Check and adjust shift release lever (69-40) to release shift ratchet as shift locks in upper case position.</p>	<p>Shift latch plate adjusting screws shown (86-22).</p> <p>Lubricate shift mechanism and check for binds.</p>
Machine locked in upper case shift position.	<ol style="list-style-type: none"> 1. Shift key binding on cover 2. Shift lock binding or damaged. 3. Spring missing or damaged from shift lock. 	<p>Adjust machine within covers.</p> <p>Shift latch is part of shift lock keylever (84-18).</p> <p>Spring is attached to shift lock on keylever (84-18).</p>	<p>Adjust machine foot brackets (65-30).</p> <p>Remove binds and lubricate.</p>

SHIFT

SYMPTOM	POSSIBLE CAUSE	REMEDY	REMARKS
<p>Machine locked in upper case shift position.</p> <p>(Continued)</p>	<p>4. Shift interlock maladjusted or has burrs on it.</p> <p>5. Shift clutch retaining plate (3-3).</p>	<p>Remove burrs and adjust shift interlock (69-38) for clearance between interlock and shift ratchet teeth at rest position (62-24).</p> <p>Retaining plate controls clearance between shift arbor (3-2) and shift spring (3-1).</p>	<p>For adjustment see "Machine will not shift to upper case, cause 4".</p>
<p>Shift sluggish</p>	<p>1. Shift key binding on cover (84-18).</p> <p>2. No lubrication</p> <p>3. Shift release maladjusted or damaged (69-40).</p> <p>4. Shift clutch spring retaining plate. (3-3)</p> <p>5. Shift overthrow stop (69-42).</p> <p>6. Shift arbor worn or loose</p>	<p>Adjust machine within covers.</p> <p>Lubricate shift mechanism completely.</p> <p>Adjust shift release lever (69-40) to release cam ratchet (62-24) as shift locks in upper case position.</p> <p>Replace if broken and or adjust.</p> <p>Replace or adjust overthrow stop.</p> <p>Replace or tighten arbor (3-2)</p>	<p>Adjust machine foot brackets (65-30).</p> <p>Shift spring (62-22) must be lubed with grease only; no oil.</p> <p>For adjustment see "Machine will not shift to upper case, cause 4".</p> <p>With shift cam in detented position adjust a clearance of .020" between shift overthrow stop (69-42) and lug on shift ratchet (69-24).</p> <p>If shift arbor is replaced, readjust operational shaft end play.</p>

SHIFT

SYMPTOM	POSSIBLE CAUSE	REMEDY	REMARKS
Shift sluggish	<p>7. Shift ratchet (62-24) binding on release lever (69-40)</p> <p>8. Operational shaft end play.</p> <p>9. Shift cam backup roller or stud worn. (85-21).</p> <p>10. Shift brake broken or maladjusted (69-39)</p>	<p>Adjust release lever (69-40) so ratchet (62-24) is released when keybutton is depressed 2/3 distance .</p> <p>Operational shaft end play is controlled by shift arbor (3-2) and collar (8-10) on inside of machine, right side of operational shaft.</p> <p>Shift cam backup roller is adjustable on early machines. Not adjustable on later models.</p> <p>Replace or adjust shift brake for 1/2 bite on brake surface of shift cam.</p>	<p>Operational shaft end play should be minimum - no binds.</p> <p>A worn backup roller could case shift cam to vary position, thereby changing rotate alignment.</p>

SHIFT

SYMPTOM	POSSIBLE CAUSE	REMEDY	REMARKS
<p>Malselection or Horizontal alignment problems after shift.</p>	<ol style="list-style-type: none"> 1. Shift clutch retaining plate (3-3). 2. Character interrupter (49-40). 3. Shift interlock (69-38) 4. Overthrow stop (69-42) 5. Shift motion has binds. 6. Worn or loose shift arm roller (69-37). 7. Shift cam backup roller (85-21). 8. For further causes see rotate alignment section. 	<p>Check for damage and adjust shift plate (3-3).</p> <p>For adjustment see "Keyboard locks after shifting, cause 5".</p> <p>Check interlock for interference and adjust to release cam ratchet.</p> <p>Replace or adjust overthrow stop (69-42).</p> <p>Observe operation of shift mechanism for variations in movement of parts and binds.</p> <p>Replace shift arm.</p> <p>Shift cam backup roller is adjustable on early machines. Not adjustable on current model machines.</p>	<p>For adjustment see "Machine will not shift to upper case", cause 4.</p> <p>With shift cam in detented position adjust a clearance of .020" between shift overthrow stop (69-42) and lug on shift ratchet (62-24).</p> <p>Causes variation in rotate detenting.</p> <p>Causes variation in rotate detenting.</p>

MACHINE SLUGGISH

SYMPTOM	POSSIBLE CAUSE	REMEDY	REMARKS
Machine sluggish	<ol style="list-style-type: none"> 1. Lack of lubrication 2. Keybutton binding on cover. 3. Keylever pawls binding at pivot points. (79-10). 4. Drive belt (6-7) 5. Cold machine due to temperature. 6. Cycle clutch spring worn or defective (50-45). 7. Binds in gear train (47) 8. For further causes "See keyboard section". 	<p>Lubricate machine completely.</p> <p>Loosen foot brackets (65-30) to adjust machine within covers.</p> <p>Lubricate pawl pivot points with oil. Rotate pawl back and forth until it is free of binds.</p> <p>Check for wear and adjustment.</p> <p>Machine may have to be washed & lubricated with recommended lubricants.</p> <p>Replace</p> <p>Check gear train for damaged teeth and adjust.</p>	<p>Binds in keylever pawls cause the keylever pawls not to restore above the interposers.</p> <p>Sympton: the operator will complain that while typing the word "seem" the second "e" doesn't print on occasions.</p> <p>Adjust drive belt by moving motor mount brackets (3A-8).</p> <p>Causes lubrication to thicken.</p> <p>For adjustment - See alignment section.</p>

SPACEBAR

SYMPTOM	POSSIBLE CAUSE	REMEDY	REMARKS
<p>Machine will not space.</p>	<ol style="list-style-type: none"> 1. Poor lubrication 2. Spacebar interlock cam (75-2). 3. Spring missing on spacebar latch. 4. Spacebar latch adjustment (10-6). 5. Too much keylever pawl clearance. 6. Spacebar final stop out of adjustment (28-25). 7. No keylever pawl overlap (18-11) 8. Clutch release arm not releasing space cam. 	<p>Lubricate spacebar mechanism completely (18-11).</p> <ol style="list-style-type: none"> 1. Adjust spacebar interlock cam (75-2) radially around filter shaft until spacebar interlock bracket (102-34) is on high point of cam. <p>Replace spring (10-6).</p> <p>Adjust spacebar latch adjusting screw (21-6) until spacebar latch (10-6) moves under cam follower (10-5) without hesitation when spacebar keybutton is depressed.</p> <p>Adjust "U" shaped slot in spacebar keylever for clearance between spacebar pawl (18-11) and spacebar interposer (19-1).</p> <p>Form extension on final stop for single space operation (28-25).</p> <p>Adjust keylever pawl overlap (18-11) with adjusting screw (18-14).</p> <p>Clutch release arm (20-2) not releasing spacebar cam (95-15).</p>	<ol style="list-style-type: none"> 2. Adjust interlock bracket (102-34) back and forth for clearance between A and B when machine is in rest position.

SPACEBAR

SYMPTOM	POSSIBLE CAUSE	REMEDY	REMARKS
<p>Machine will not space.</p> <p>(Continued)</p>	<p>9. Trigger (22-11) not re-setting over escapement torque bar (22-13).</p> <p>10. Interposer adjusting screw missing or maladjusted (20-1).</p>	<p>Check spacebar latch lever screw (10-9)</p> <p>Adjusting screws (20-1) controls the clearance between spacebar latch (10-6) and cam follower (10-5) in rest position.</p>	<p>Spacebar latch lever screw controls escapement pawl clearance for spacebar operation.</p> <p>Cam follower (10-5) is used for backspace and spacebar operation. When the spacebar is operated, there must be enough clearance between backspace latch and cam follower so backspace will not operate.</p>
<p>Machine will not repeat space.</p>	<p>1. Spacebar final stop adjusted too high.</p> <p>2. Spacebar binding on keyboard insulation.</p> <p>3. Too much clearance between keylever pawl (18-11) and interposer (19-1).</p> <p>4. Keylever pawl overlap (18-11).</p>	<p>Adjust repeat stop (28-25) by forming extension.</p> <p>Keyboard insulation may be hard due to age (84-19).</p> <p>Adjust "U" shaped slot in spacebar keylever for clearance between spacebar pawl (18-11) and spacebar interposer (19-1).</p> <p>Adjust keylever pawl overlap (18-11) with interposer (19-1) by adjusting screw (18-14).</p>	

SPACEBAR

SYMPTOM	POSSIBLE CAUSE	REMEDY	REMARKS
Spacebar gives extra cycles	9. Too much keylever pawl overlap. 10. Broken or missing cam pawl springs.	Adjust keylever pawl overlap (18-11) with adjusting screw (18-14). Replace cam pawl & spring (5-3)	Also check cam pawl for damage
Spacebar operation sluggish	1. Spacebar binding on cover. 2. Spacebar binding on hardened keyboard insulation. 3. Clutch release arm binding on cam. 4. Spacebar latch maladjusted (10-6). 5. Latch lever screw maladjusted (10-9). 6. Interposer restoring bail maladjusted.	Adjust spacebar left or right - limit the side motion with grip clips. Keyboard insulation may be hard due to age (84-19). Adjust function cam (95-15) to the left, for clearance between release arm (20-2) and cam(95-15) Adjust spacebar latch adjusting screw (21-6) until spacebar latch (10-6) moves under cam follower (10-5) without hesitating when spacebar keybutton is depressed. Adjust latch lever screw (10-9) for escapement pawl clearance. Adjust extension lugs (29-27) on interposer restoring bail (29-26), by forming, so interposer (19-1) will overthrow latch plate (30-28).	

SPACEBAR

SYMPTOM	POSSIBLE CAUSE	REMEDY	REMARKS
Spacebar operation sluggish.	7. Repeat stop maladjusted (28-25).	Adjust repeat stop (28-25), by forming extension for one single space operation.	
Machine gets extra spaces in same place consistently.	1. Too much escapement pawl clearance (73-43).	Adjust spacebar latch adjusting screw for approx. .010" pawl clearance.	
	2. Damaged escapement rack (73-44).	Replace rack.	Worn or missing teeth on escapement rack. If rack is damaged check escapement pawl for wear. (73-43).
	3. Escapement bracket loose or maladjusted (89-30).	Loosen 4 screws and adjust escapement bracket so it will be parallel to the tab torque bar.	Also adjust .010" clearance between tab torque bar and escapement bracket.
	4. Not enough pawl bite on escapement rack.	1. Adjust pawl mounting stud for .001" clearance between escapement torque bar (76-4) and pawl mounting stud (91-35).	
	2. Adjust screw (76-5) for clearance between escapement pawl (73-43) and escapement torque bar (76-4).	2. Adjust screw (76-5) for clearance between escapement pawl (73-43) and escapement torque bar (76-4).	If escapement torque bar (76-4) is adjusted, check and readjust trigger (22-11) clearance with escapement trip link (23-14).
5. Pawl mounting stud loose or maladjusted.	Adjust pawl mounting stud (91-35) for .001" clearance between the stud and escapement torque bar (76-4).		

SPACEBAR

SYMPTOM	POSSIBLE CAUSE	REMEDY	REMARKS
<p>Machine gets extra spaces in same place consistently.</p> <p>(Continued)</p>	<p>6. Escapement torque bar back stop (17-2) broken or maladjusted.</p>	<p>Adjust backstop (17-2) so escapement torque bar will not flex in the center.</p>	<p>Escapement torque bar backstop is located in the center section at rear of machine.</p>
<p>Random extra spaces.</p>	<p>1. Too much pawl clearance (73-43).</p> <p>2. Escapement bracket loose or maladjusted.</p> <p>3. Pawl mounting stud loose or maladjusted.</p> <p>4. Too much clearance between escapement torque bar and escapement pawl.</p> <p>5. Worn escapement pawl (73-43).</p>	<p>Adjust spacebar latch adjusting screw for approx. .010" pawl clearance.</p> <p>Loosen 4 screws and adjust escapement bracket parallel to tab torque bar(91-31).</p> <p>Adjust pawl mounting stud (91-35) for .001" clearance between the stud (91-35) and escapement torque bar (76-4).</p> <p>Adjust torque bar adjusting screw (76-5) for .008" clearance between escapement torque bar (76-4) and escapement pawl(73-43)</p> <p>Replace</p>	<p>Adjust .010" clearance between tab torque bar and escapement bracket.</p> <p>If escapement torque bar (76-4) is readjusted, you have to adjust trigger pawl clearance (22-11) with escapement link (23-14).</p> <p>If escapement pawl is worn, check escapement rack for wear.</p>

SPACEBAR

SYMPTOM	POSSIBLE CAUSE	REMEDY	REMARKS
<p>Random extra spaces</p>	<p>6. Escapement torque bar flexes too much.</p> <p>7. Not enough pawl bite on escapement rack.</p> <p>8. Spacebar latch lever screw loose, broken or maladjusted.</p>	<p>Adjust escapement torque bar backstop (17-2) so escapement torque bar will not flex in the center.</p> <p>See "Machine gets extra spaces in same place consistently, cause 4".</p> <p>Adjust latch lever screw (10-9) for escapement pawl clearance during spacebar operation.</p>	<p>Escapement torque bar backstop is on 13" and 15" machines.</p>

CORD TENSION PULLEY ADJUSTMENT

1. Turn machine on.
2. Tilt machine on back.
3. Operate spacebar and backspace mechanism to rotate tab cord drum to expose locking screws. (137-47)
4. Loosen FIRST screw - rotate and expose SECOND screw - loosen second screw, BUT LEAVE THE SOCKET WRENCH ON SCREW, (DO NOT REMOVE WRENCH FROM SCREW); rest wrench against frame of machine as shown (138-50)
5. Depress TAB keybutton.
6. Place left hand on left side of carrier; place right hand on cord tension pulley (19B-29).
7. At the same time, push carrier to right and push cord tension pulley to left.
8. To maintain end play of escapement shaft - push escapement cord drum up and push tab cord drum down - tighten screws on tab cord drum. (137)

FLICKING

What is Flicking?

Flicking is when an operator gets a hyphen in a word that is being typed instead of the correct character.

Example;	typetronic	correctly spelled
	type-ronic	not spelled correctly, flicking occurred.

Theoretically, the interposers should latch down under the latch springs at the same time the cycle clutch is released. If the two conditions above do not occur at the same time - for example - if the cycle clutch is released before the interposer is latched down, flicking occurs. It is acceptable for the interposers to latch down slightly After cycle clutch releases.

To check adjustments:

1. Depress a character keybutton and latch down an interposer.
2. Place finger on top of cycle clutch link as in figure 54A and apply slight pressure.
3. With a spring hook, engage cycle clutch sleeve (59-17) and pull towards you until cycle clutch link moves down to edge of cycle clutch keeper as in figure 54. There should be a zero clearance at point (54-46).
4. Depress and check the following keys the same way: Brackets, =/+, the numeral 6 key and the numeral 7 key.
If the clearance at point (54-46) is not the same (allowing a variance of .002") for the four keys, adjust the latch springs (56-11) up or down until they are the same.

To adjust:

1. Slightly loosen screws (54-21) and adjust cycle clutch keeper up or down until there is minimum clearance at point (54-46) between cycle clutch latch pawl (54-20) and cycle clutch keeper (54-8).

TAB

SYMPTOM	POSSIBLE CAUSE	REMEDY	REMARKS
<p>Tab set/clear keybutton will not set or clear tab stops.</p>	<ol style="list-style-type: none"> 1. Tab set/clear keybutton link broken, binding or damaged (86-23). 2. Tab set/clear bracket damaged or broken(87-24) 3. Tab set/clear gang clear bracket maladjusted (73-45). 4. Position of tab rack - left to right. 5. Tab set/clear bellcrank loose or broken (87-28) 	<p>Repair or replace</p> <p>Repair or replace</p> <p>Adjust gang clear bracket (73-45) to set and clear tab stops without excessive noise.</p> <p>Adjust tab rack left or right(14-10)</p> <p>Adjustment:</p> <ol style="list-style-type: none"> 1. Loosen tab set/clear bellcrank (87-28). 2. With machine power off, depress tab keybutton and latch out tab lever (9-6). 	<p>See "Carrier stops at wrong tab position, cause 8".</p> <p>Adjustment:</p> <ol style="list-style-type: none"> 1. Tab to a set tab stop. 2. Backspace one position. 3. Hold carrier with right hand. 4. Slowly depress tab keybutton, while observing the tab lever (9-6) move towards the rear. Adjust tab rack, with adjusting nut (88-26), so tab lever misses tab stop by .010". 3. Rotate tab rack radially and position between escape-ment bracket extension (89-29) and tab lever (9-6).

TAB

SYMPTOM	POSSIBLE CAUSE	REMEDY	REMARKS
<p>Carrier does not move when tab is operated.</p>	<p>1. Tab keybutton binding on cover.</p>	<p>Reposition keybutton or adjust machine within covers.</p>	<p>Adjust machine within covers with foot brackets (65-30).</p>
	<p>2. Tab set/clear keybutton binding on cover.</p>	<p>Same as Remedy 1.</p>	
	<p>3. Cords off pulleys</p>	<p>Replace cords on pulleys and check cord tension pulley.</p>	<p>See "Special section " on cord tension pulley adjustment.</p>
	<p>4. Carrier binding on dust shield (12-1).</p>	<p>Adjust shields to remove binds.</p>	
	<p>5. Velocity cable caught on pulley (70-40).</p>	<p>Adjust velocity cable to just contact the left inside of machine when carrier is at extreme left side of machine.</p>	
	<p>6. Tab keylever link binding or broken (86-23)</p>	<p>Replace or repair link.</p>	
	<p>7. Tab torque bar link off or damaged (90-30).</p>	<p>Replace or repair.</p>	
	<p>8. Too much lost motion between tab torque bar (91-31) and tab trigger (91-32).</p>	<p>Adjust tab torque bar clevis(90-33) for minimum clearance between tab torque bar (91-31) and tab trigger (91-32).</p>	
	<p>9. Tab trigger broken or damaged (91-32)</p>	<p>Replace</p>	

TAB

SYMPTOM	POSSIBLE CAUSE	REMEDY	REMARKS
Carrier does not move when tab is operated.	10. Tab overthrow stop (32-34) blocking tab lever (9-6). 11. Tab lever broken (32-36) 12. Worn or maladjusted escapement (31-32) and tab pinion gears (31-30)	Adjust tab overthrow stop (32-34). Replace Replace or adjust	Adjustment: 1. Turn machine off. 2. Depress tab keybutton and latch out tab lever (9-6). 3. Adjust tab overthrow stop (32-34) for .005" clearance between tab trigger (32-35) and overthrow stop (32-34). Check tab lever spring (32-36). Loosen bristol screws on tab pinion gear (31-30) and adjust gear back and forth for .005" backlash.
Machine will tab only while tab keybutton is depressed.	1. Tab lever not latching out.	1. Check tab latch (92-33) and motion. 2. Tab torque bar (91-31) not transferring enough motion to tab trigger (9-6).	Adjust minimum clearance between tab torque bar (91-31) and tab trigger (91-32) with tab torque bar adjusting link (90-30).

TAB

SYMPTOM	POSSIBLE CAUSE	REMEDY	REMARKS
<p>Machine will tab only while tab keybutton is depressed.</p> <p>(Continued)</p>	<p>2. Tab overthrow stop (9-4) not allowing tab lever to move far enough to rear to be latched out.</p>	<p>Adjust tab overthrow stop (32-34)</p>	<p>Adjustment:</p> <ol style="list-style-type: none"> 1. Turn machine off. 2. Depress tab keybutton and latch out tab lever (9-6). 3. Adjust tab overthrow stop(32-34) for .005" clearance between tab trigger (32-35) and overthrow stop (32-34).
<p>Carrier hesitates while tabbing</p>	<ol style="list-style-type: none"> 1. Poor lubrication 2. Cords off pulleys. 3. Mainspring tension(17-1) 4. Binds in tab pinion and escapement gear. 5. Tab torque bar (91-31) binding against escapement bracket (89-30). 	<p>Lubricate machine completely</p> <p>Replace cords and check cord tension pulley.</p> <p>Mainspring should be wound clockwise approximately 6 turns.</p> <p>Loosen tab pinion gear (31-30) and adjust back and forth for minimum backlash - no binds.</p> <p>Loosen 4 screws holding escapement bracket (89-30) and adjust bracket for clearance between tab torque bar (91-31) and escapement bracket (89-30).</p>	<p>Be sure to lubricate print shaft wipers, escapement rack and cord pulleys.</p> <p>For adjustment of cord tension pulley, "See special section".</p> <p>Check for broken mainspring.</p>

TAB

SYMPTOM	POSSIBLE CAUSE	REMEDY	REMARKS
<p>Carrier stops at wrong tab position.</p>	<p>1. Tab keybutton binding on cover.</p>	<p>Reposition keybutton or adjust machine within covers.</p>	<p>Loosen machine foot brackets (65-30) to adjust machine.</p>
	<p>2. Tab set/clear keybutton binding on cover.</p>	<p>Reposition keybutton or adjust machine within covers.</p>	<p>Loosen machine foot brackets (65-30) to adjust machine.</p>
	<p>3. Tab stops are not being cleared completely.</p>	<p>Check and adjust tab gang clear bracket.</p>	<p>See "Machine noisy when gang clearing set tab stops."</p>
	<p>4. Carrier binding on dust cover (12-1) or card holder.</p>	<p>Check and adjust card holder and dust shield to prevent binds.</p>	
	<p>5. Cords off pulleys</p>	<p>Replace cords on pulleys and check cord tension pulley.</p>	<p>for cord tension pulley adjustment See "Special section".</p>
	<p>6. Check for binds in rear or front carrier supports</p>	<p>Check and adjust rear shoe (32-33) to eliminate binds, lubricate print shaft wipers (41-27).</p>	
	<p>7. Too much escapement pawl clearance.</p>	<p>Form upper extension on tab lever latch (92-33) to adjust for pawl clearance. Adjust for minimum pawl clearance without pawl dragging on escapement rack.</p>	<p>Too much pawl clearance could cause the carrier to go one space too far.</p>

TAB

SYMPTOM	POSSIBLE CAUSE	REMEDY	REMARKS
<p>Carrier stops at wrong tab position.</p>	<p>8. Check position of tab set/clear bracket. Selectric II dual pitch typewriter.</p> <p>The selectric II tab rack stops are not evenly spaced.</p> <p>9. Check tab latch for binds (92-33). Check tab latch spring also.</p> <p>10. Silicone tab rack</p> <p>11. Check position of tab rack - left and right.</p> <p>12. Poor lubrication</p> <p>13. Not enough tab lever bite on tab stop.</p>	<p>Adjust gang clear bracket (92-34) to set proper tab stops.</p> <p>1. Locate the two tab stops that are closer together. (92-36)</p> <p>2. Place switch pitch lever in 10 pitch position.</p> <p>Remove binds and check tab latch spring.</p> <p>Replace with a new friction tab rack.</p> <p>See "Tab set/clear keybutton will not set or clear tab stops, cause 4".</p> <p>Lubricate machine completely.</p> <p>Loosen screw on head of tab lever (9-6) and adjust tab lever pawl for .040" clearance between tab lever pawl and a set tab stop.</p>	<p>3. Adjust gang clear bracket to set the two tab stops together.</p> <p>4. Change machine to 12 pitch position.</p> <p>5. Using same two tab stops, adjust gang clear bracket to set the two tab stops individually.</p> <p>Perform the adjustments until both the 10 and 12 pitch conditions are correct.</p> <p>Friction rack may require the long nose gang clear bracket.</p> <p>Be sure to lubricate print shaft, pulleys and escapement rack.</p>

TAB

SYMPTOM	POSSIBLE CAUSE	REMEDY	REMARKS
Carrier stops at wrong tab position.	14. Oil wiper caps, on side of carrier, binding on print shaft. (41-27). 15. Check governor or tab pinion spring - may have bad loop.	Loosen and center print shaft wiper caps, to prevent binds. Replace	Governor spring is same as tab pinion spring (31-30). May be binding due to dirt - clean with cleaning solution.
Tab set/clear keybutton sets wrong tab stops	1. Tab gang clear bracket maladjusted (73-45).	See "Carrier stops at wrong tab position, cause 8 ".	Most likely to occur on Selectric II typewriters.
Machine noisy when gang clearing set tab stops.	1. Tab gang clear bracket (73-45) (Front to rear adjustment) 2. Tab gang clear bracket nose. (up and down adjustment)	Adjust tab gang clear bracket, front to rear, to clear set tab stops without excessive noise. Form nose up to prevent dragging on rack.	
Tab stops set or clear themselves	Silicone tab rack	Replace silicone grease tab rack with friction tab rack.	After replacing tab rack, go to "Tab set/clear keybutton will not set or clear tab stops, cause 5 and cause 4 ".

TILT OR VERTICAL ALIGNMENT

SYMPTOM	POSSIBLE CAUSE	REMEDY	REMARKS
<p>Tilt or vertical alignment</p> <p>Sample: vertical aligning incorrect.</p>	<ol style="list-style-type: none"> 1. Broken or damaged type-head (36). 2. Tilt detent worn, loose or defective (37). 3. Weak or broken rotate detent spring (37-3) 4. Fine timing 5. No clearance between the detent actuating lever (38-44) and detent cam follower (38-45). 6. Tilt arm motion 7. Binds in tilt & rotate detents. 8. Tilt homing 9. Side play in tilt ring. 	<p>Replace or repair</p> <ol style="list-style-type: none"> 1. Typehead could cause problems if the silver coating wears off. <p>Adjust tilt detent screws (37-1) (37-2) for minimum clearance - no binds.</p> <p>Replace spring (37-3)</p> <p>See alignment section</p> <p>Adjust nut (38-46) up or down until a clearance of .001" is between detent cam follower and detent actuating lever when element is at the printing point or half cycled.</p> <p>See alignment section.</p> <p>Adjust tilt screws (38-46) and rotate detent screw (38-20)</p> <p>See alignment section</p> <p>Adjust tilt ring (39-23) left or right by with pivot pins (39-21)</p>	<ol style="list-style-type: none"> 2. Latch springs on element broken. 3. Cap broken or loose. <p>A groove may be worn in the side of the tilt detent, caused by the tilt detent adjusting screw. (37-1).</p> <p>Check skirt clearance after adjusting clearance between detent actuating lever and detent cam follower. (See alignment section)</p> <p>Adjust for minimum clearance - no binds.</p> <p>The tilt ring (39-23) should be centered between yoke. Side play of the tilt ring is controlled by pivot pins - side play should be minimum - no binds.</p>

TILT OR VERTICAL ALIGNMENT

SYMPTOM	POSSIBLE CAUSE	REMEDY	REMARKS
Tilt or Vertical alignment (Continued)	10. Tilt bellcrank broken or loose (40-24).	Repair or replace	Bellcrank may have to be removed to see worn area.
	11. Upper ball socket worn or damaged (41-25).	Move ball socket back and forth, checking for movement - replace if worn.	Ball socket should have minimum movement - no binds.
	12. Tilt ring spacers(41-26)	Replace. There should be no vertical or minimum vertical movement of upper ball socket.	Spacers allow the upper ball socket to rotate freely within tilt ring (39-23).
	13. Binds or too much play in gear train.	Check for worn or damaged gears and adjust.	Gears should be adjusted for minimum backlash - no binds (See alignment section)
	14. Rotate detent nut (39-24) hitting yoke (39-22).	1. Adjust tilt alignment. 2. Adjust fine timing 3. Part of yoke may have to be filed off.	Affects tilt 3 characters (See alignment section)
	15. Power & Free flight adjustments.	See "Noise during print cycle only, cause f. "	Could cause element to hit ribbon mechanism.

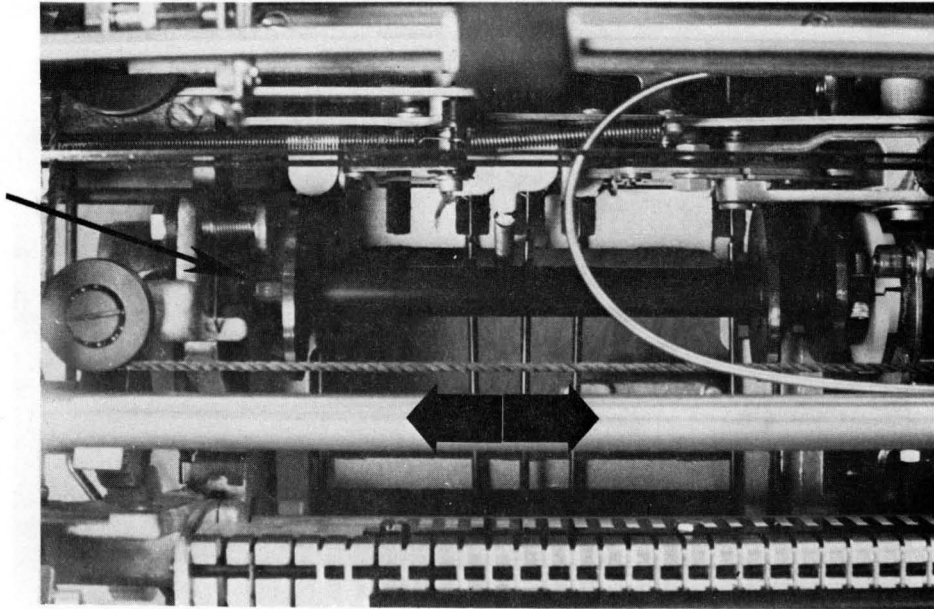

Figure 1 - Cycle shaft

Apply duck bill pliers to cam on cycle shaft and move back and forth in direction of arrows to check for end play. 1. Shims (collar)

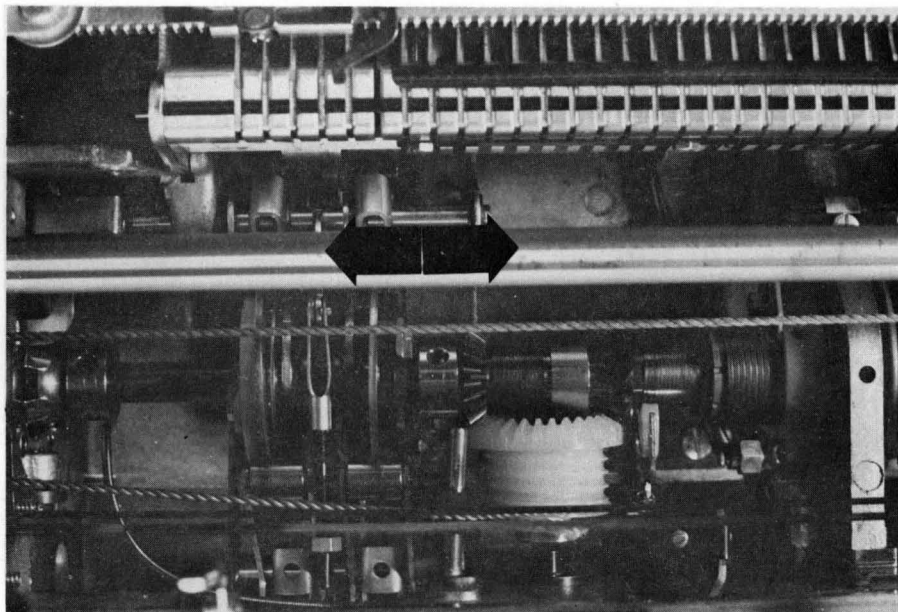

Figure 2 - Operational shaft

Check end play of operational shaft by applying duck bill pliers to function cams and move back and forth in directions of arrows.

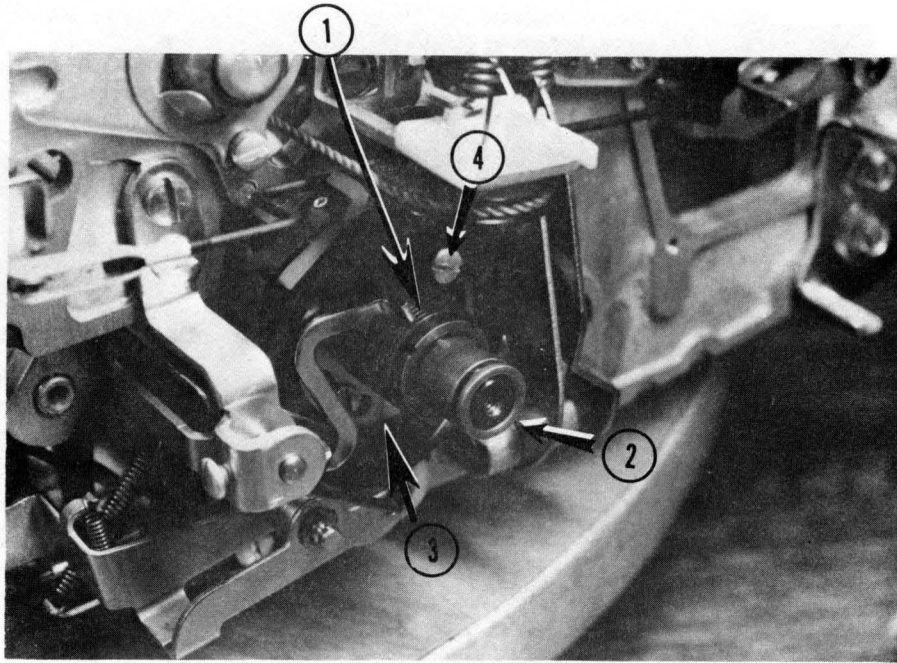

Figure 3 - Shift

1. Shift spring 2. Shift arbor 3. Retaining plate 4. Screws for retaining plate and overthrow stop.

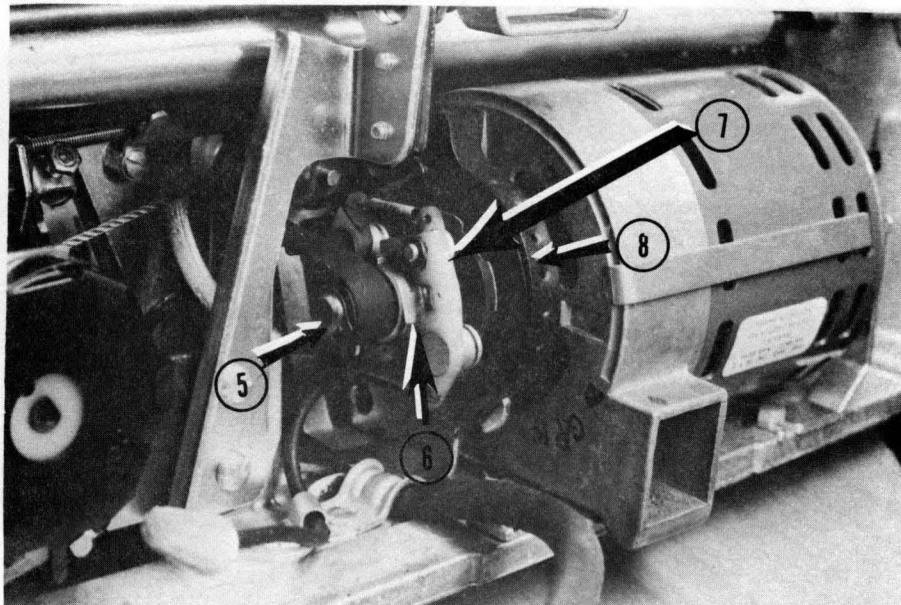

Figure 3A - Motor & Motor pulley

5. Motor shaft 6. Motor pulley 7. Motor pawls 8. Motor mounts

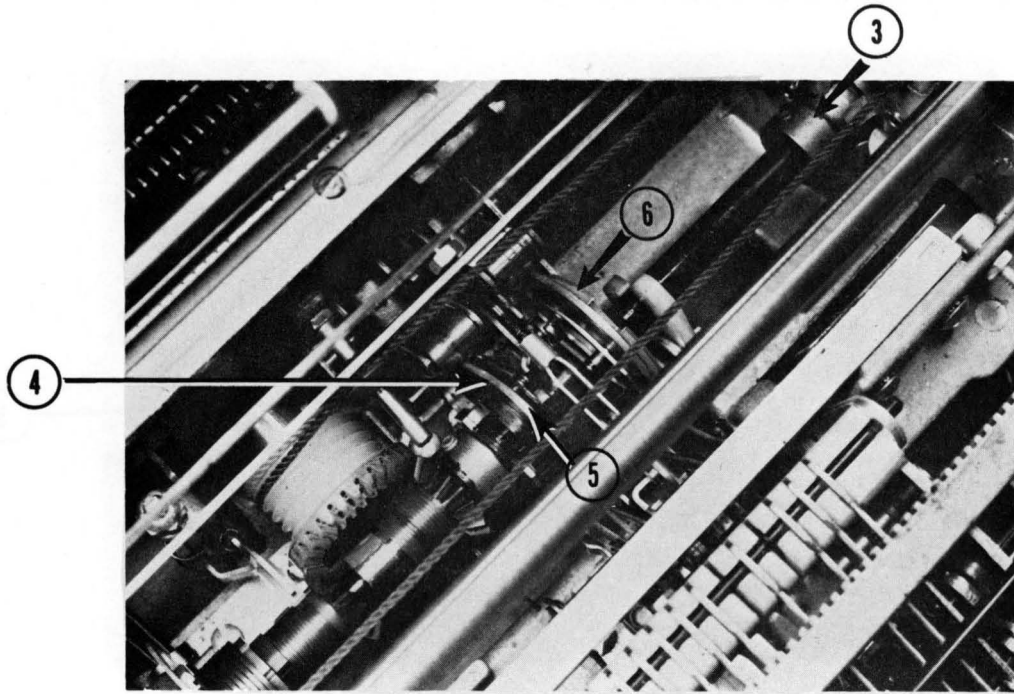

Figure 3B. Operational shaft

- 3. Collar
- 4. Function cams
- 5. Function cam for spacebar - backspace
- 6. Function cam for carrier return - index.

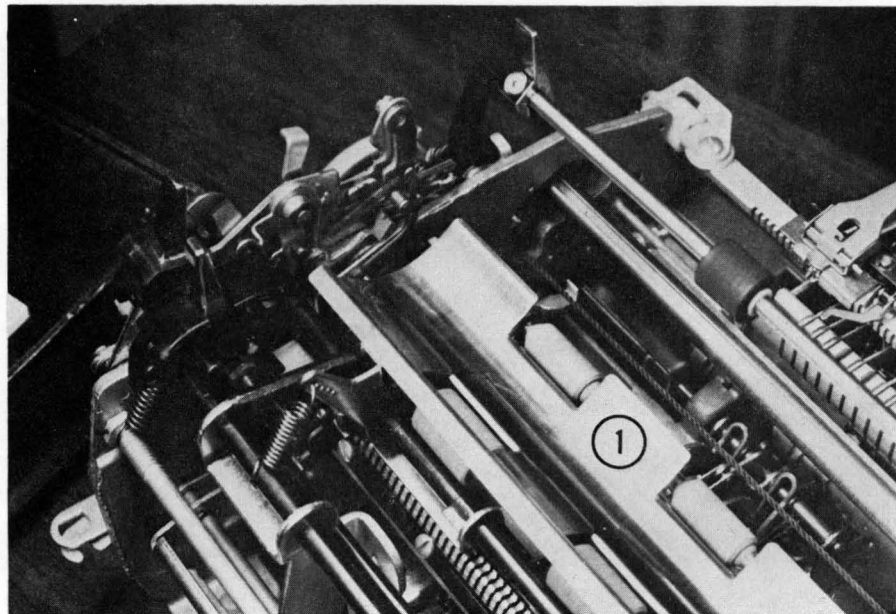

Figure 3C

- 1. Paper pan

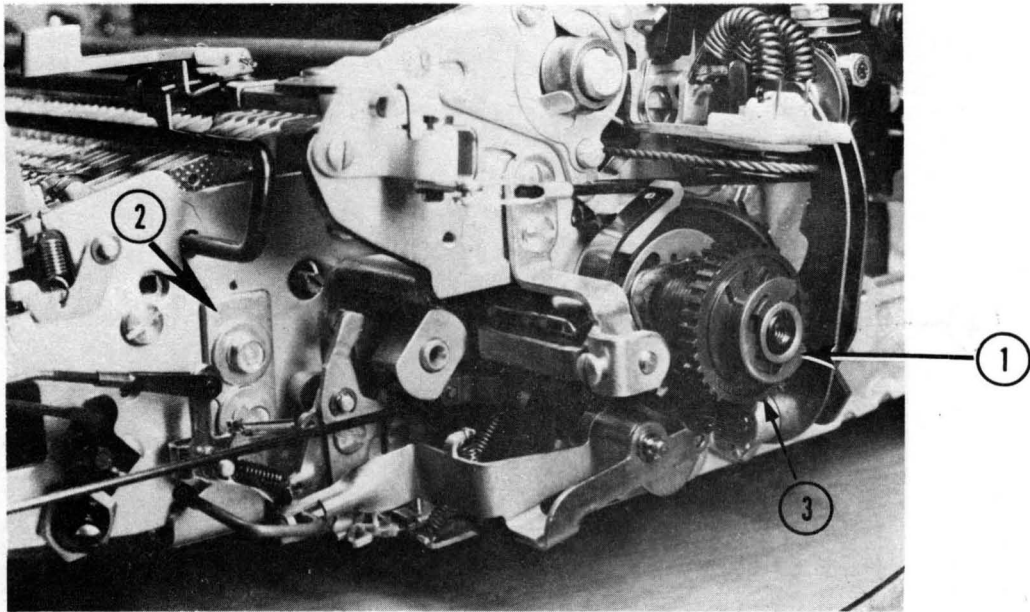

Figure 4

1. Shift "e" clip 2. Frame mounting brackets 3. Shift ratchet

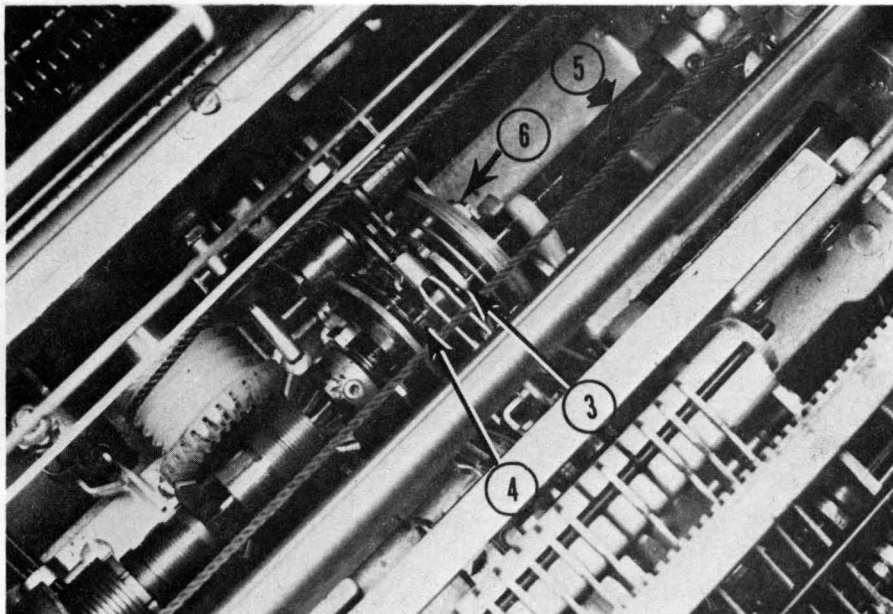

Figure 5

3. Cam pawl 4. Cam ratchet 5. Operational shaft 6. Adjusting eccentric & locking screw.

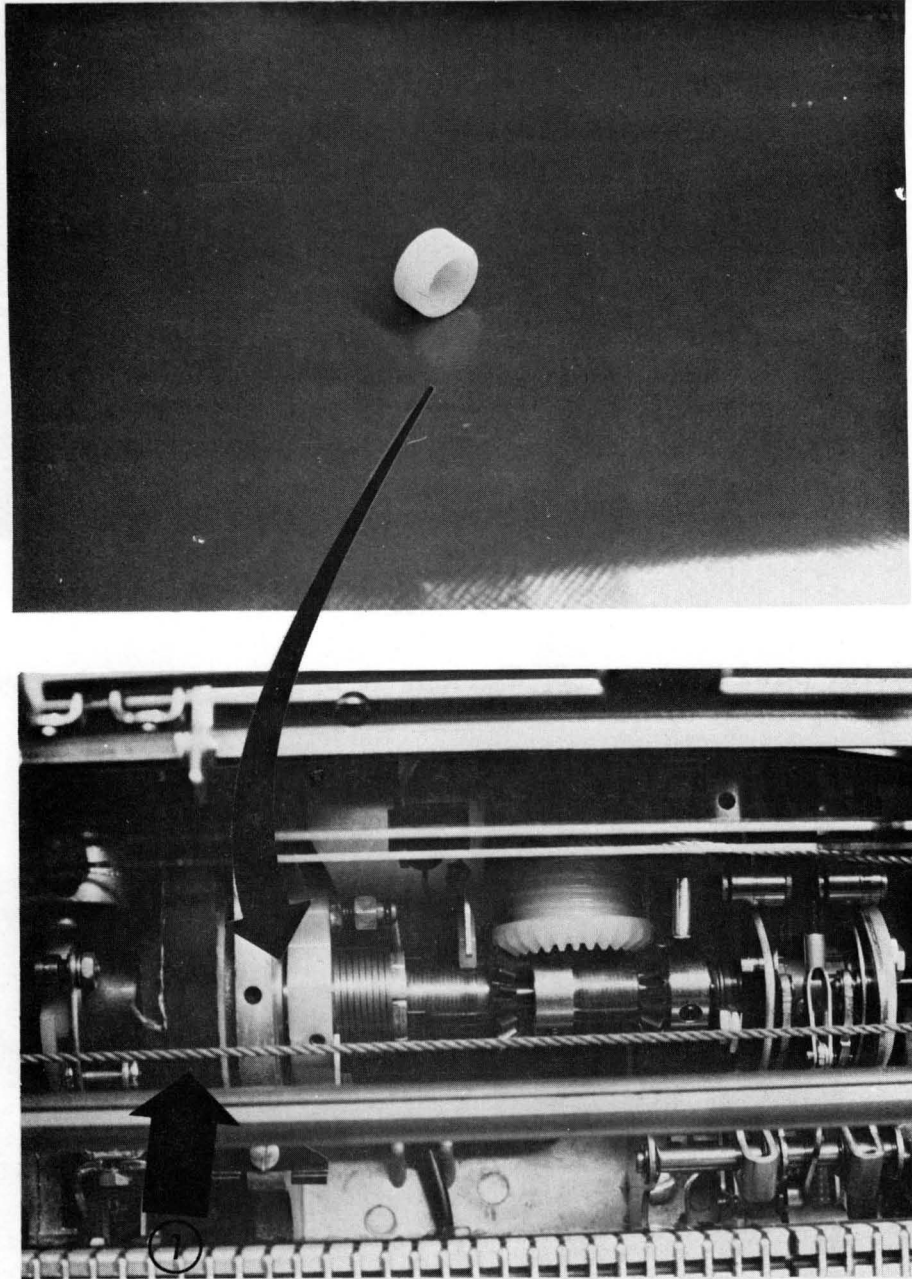

Figure 6

The nylon sleeve in the above picture controls the left side of the operational shaft and if worn causes the operational shaft to make a clicking noise. 7. Drive belt

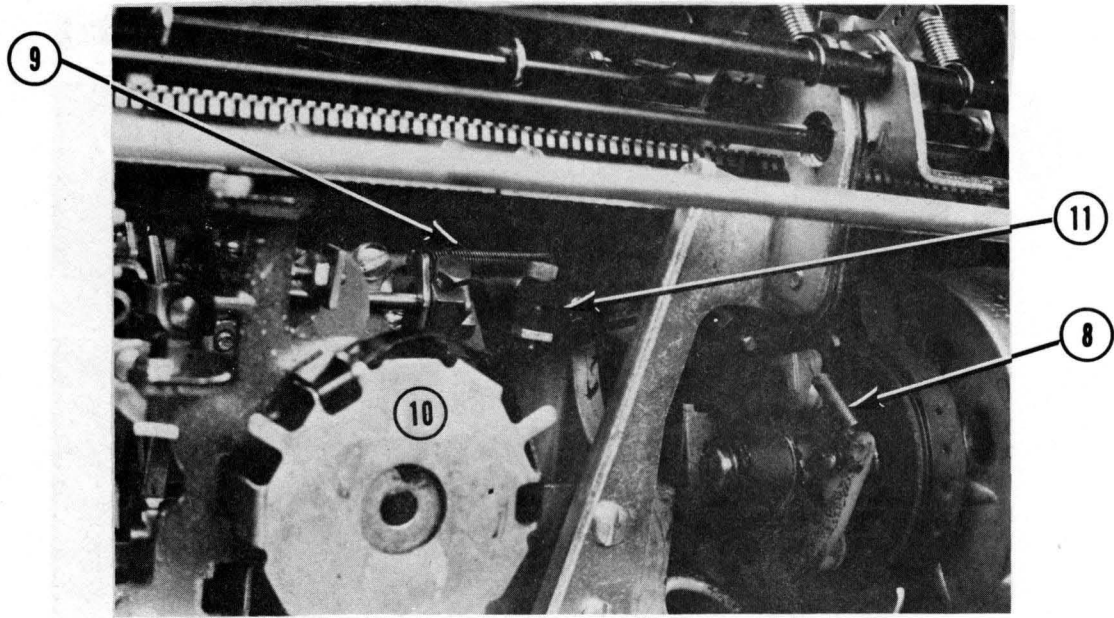

Figure 7

8. Motor pawl springs 9. Backspace spring 10. Mainspring
 11. Escapement torque bar backstop

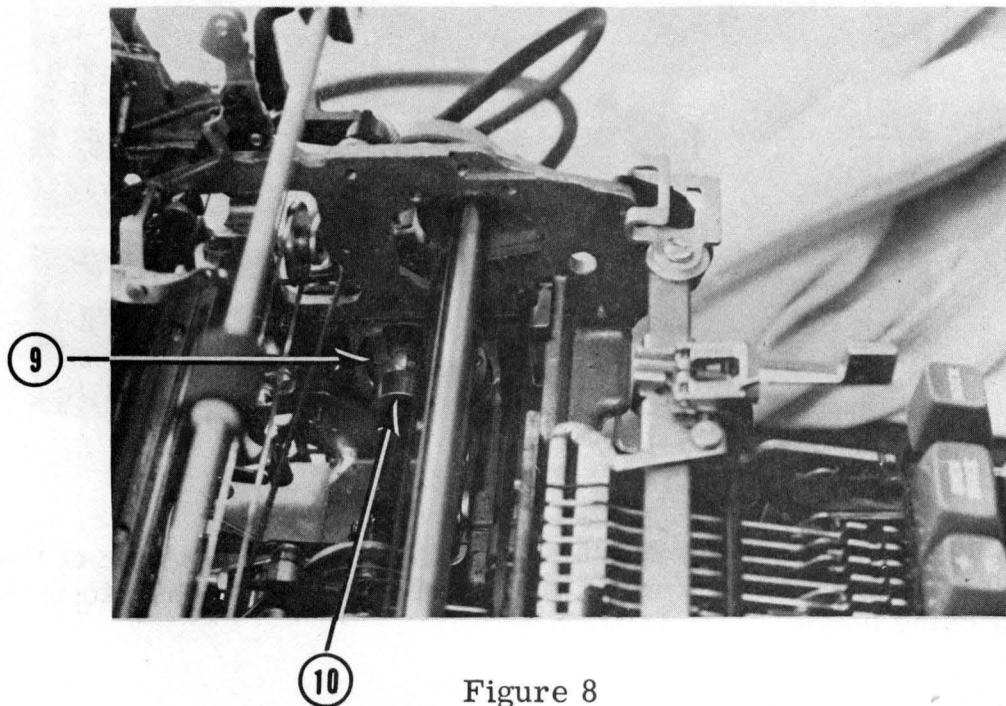
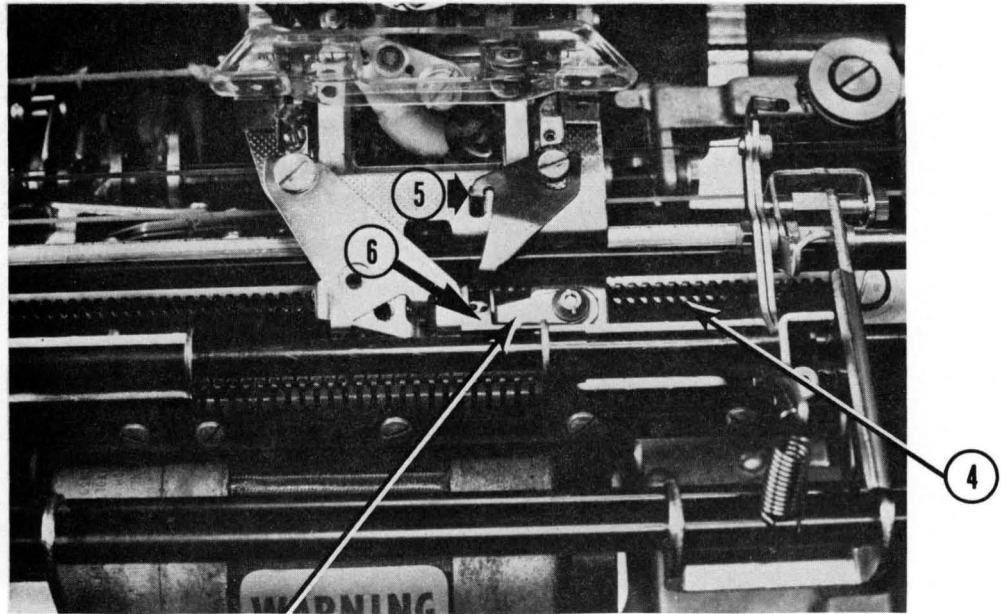

Figure 8

9. Shift cam bearing 10. Operational shaft collar



7

Figure 9

4. Backspace rack 5. Tab overthrow stop 6. Tab lever
7. Tab trigger

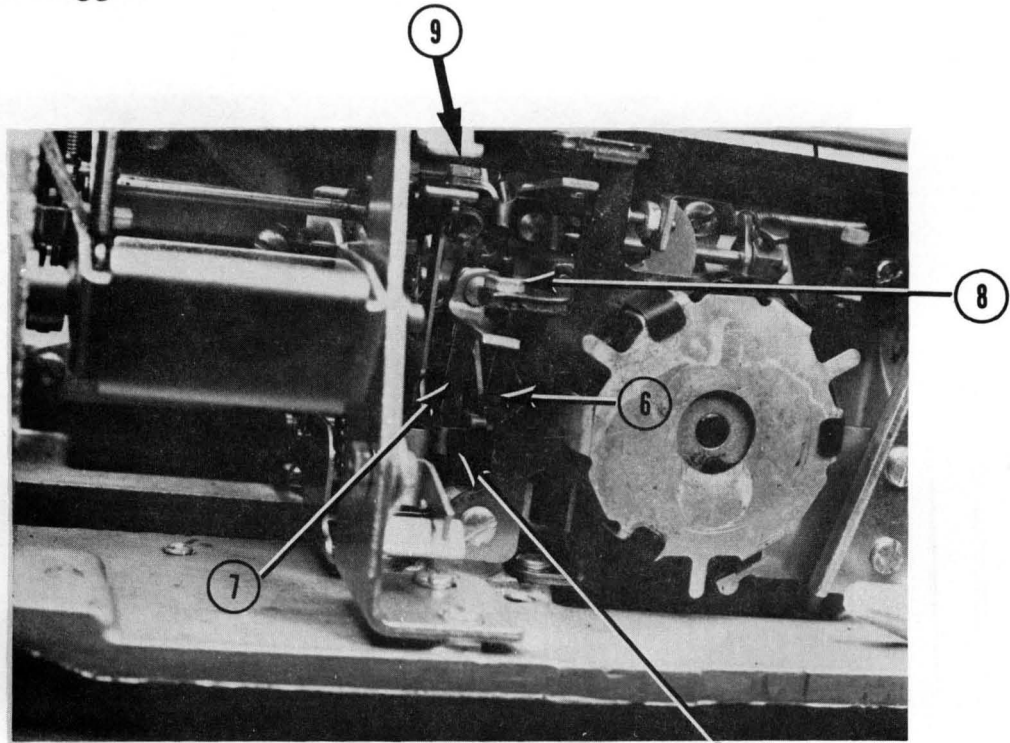

5

Figure 10

5. Cam follower for spacebar and backspace 6. Spacebar latch
7. Backspace latch 8. Backspace latch adjusting screw
9. Spacebar latch lever screw.

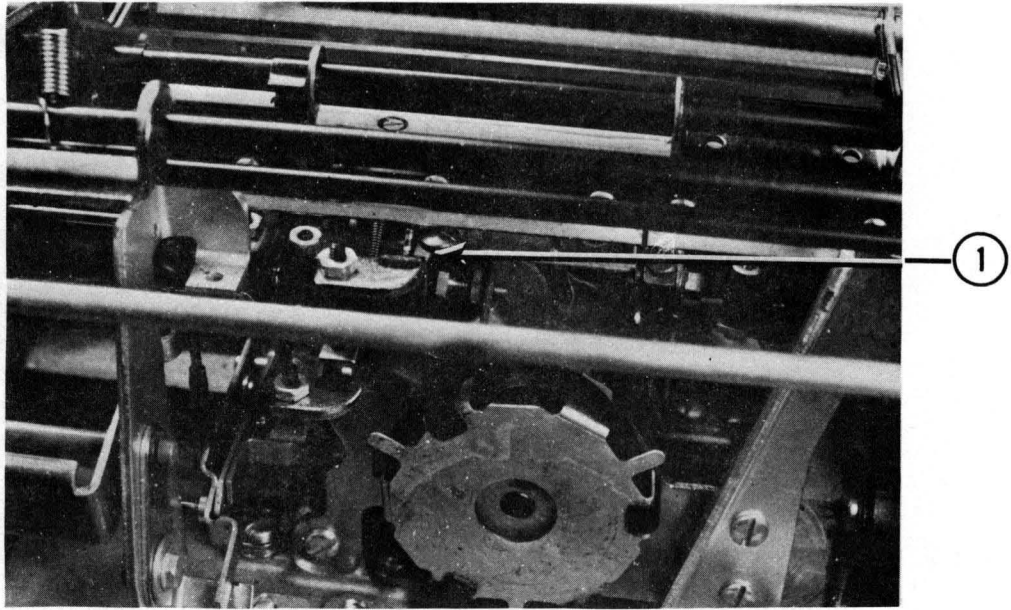

Figure 11

1. Intermediate lever

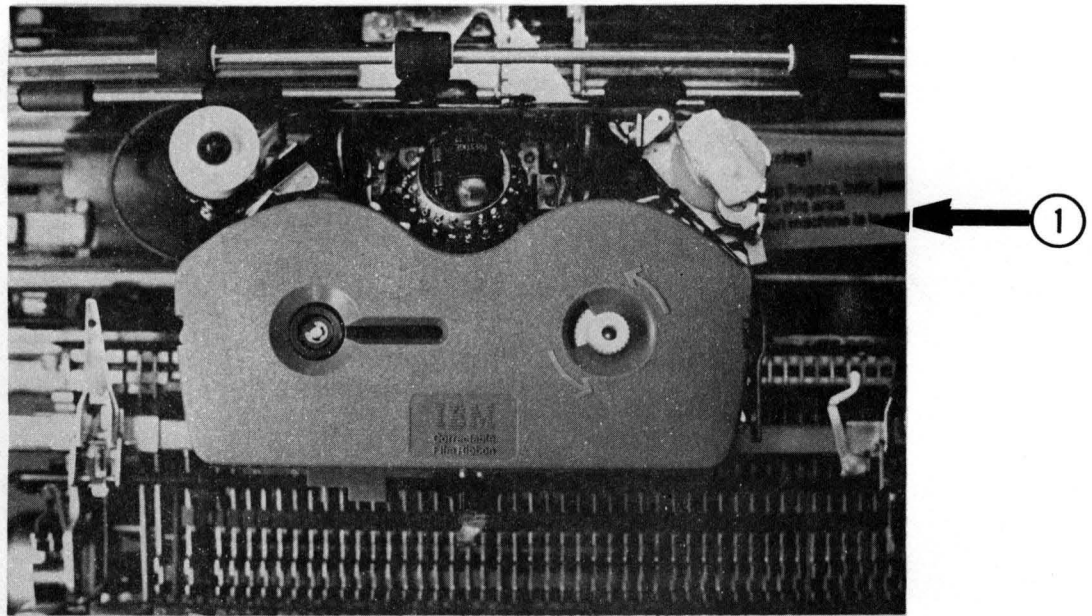

Figure 12

1. Dust cover

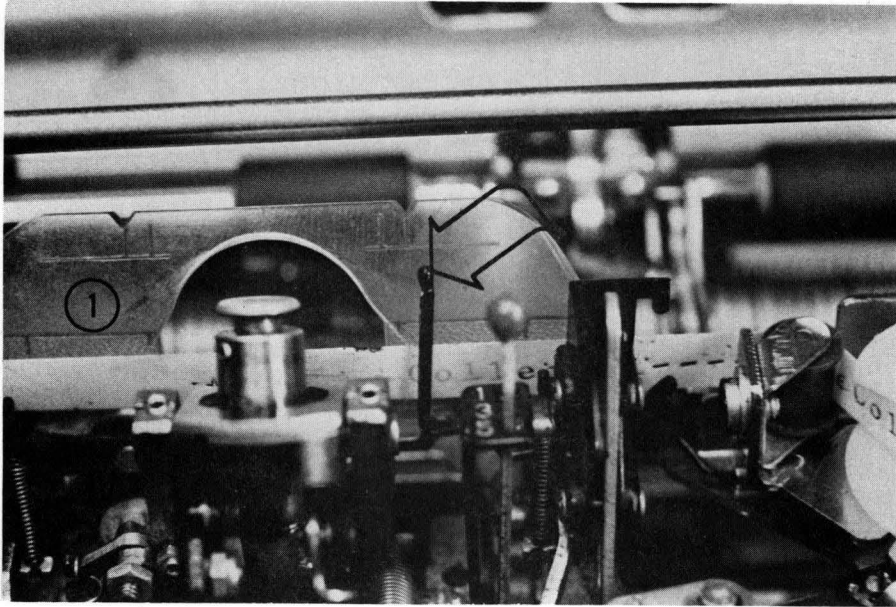

Figure 13

1. Card holder - arrow points to separating wire on the correctable mechanism on the correctable typewriter.

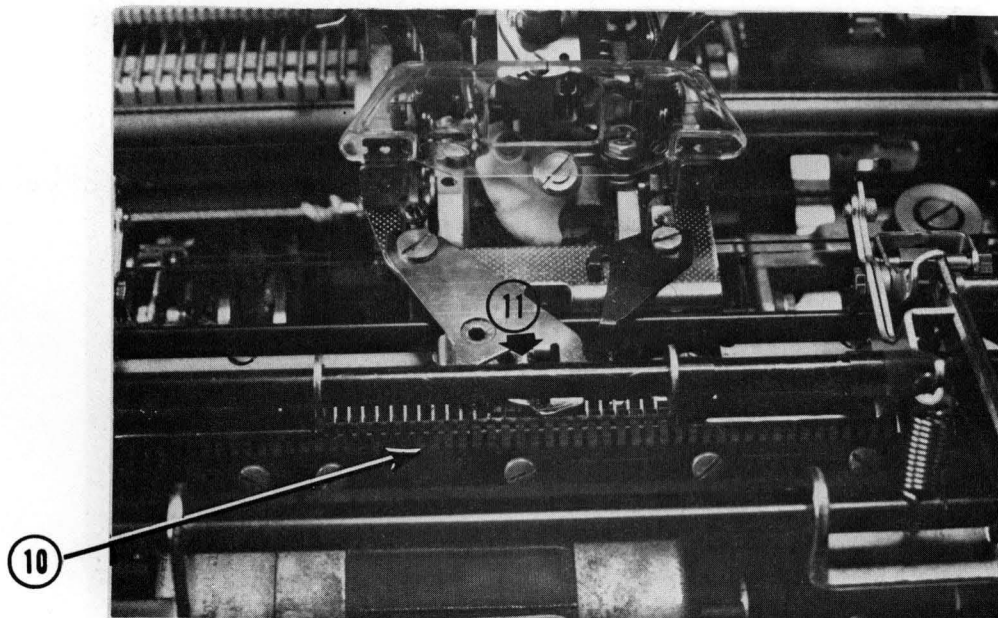

Figure 14

10. Tab rack
11. Escapement bracket extension

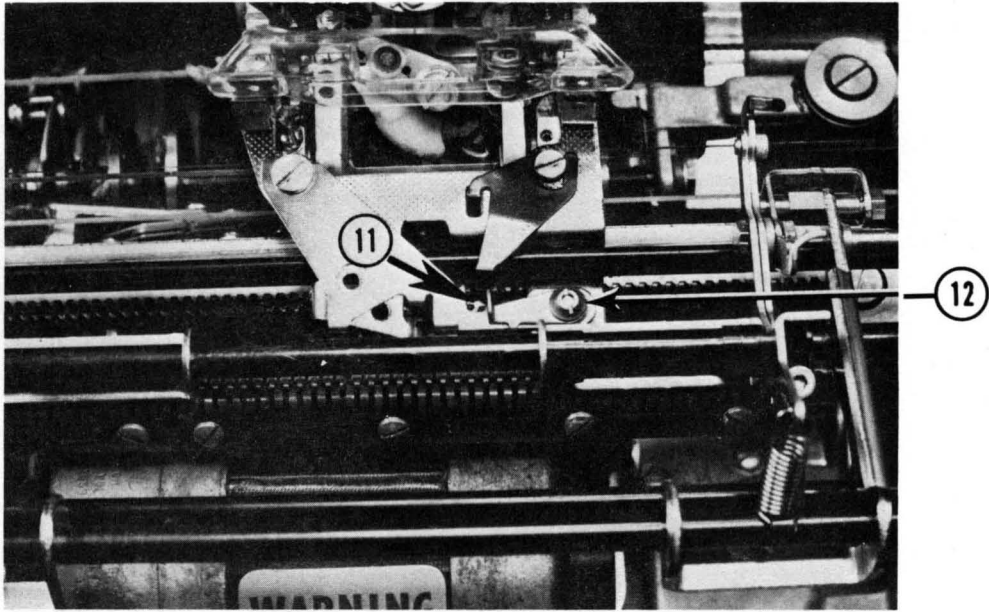

Figure 15

11. Backspace pawl 12. Arrow points to pawl mounting stud nut

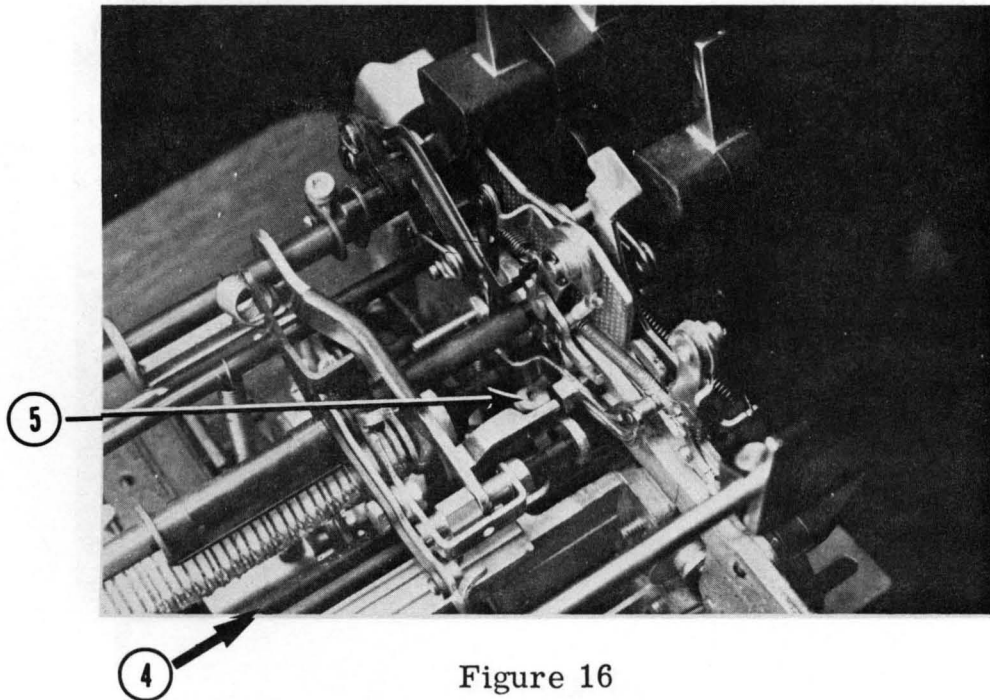

Figure 16

4. Escapement torque bar 5. Torque bar adjusting screw

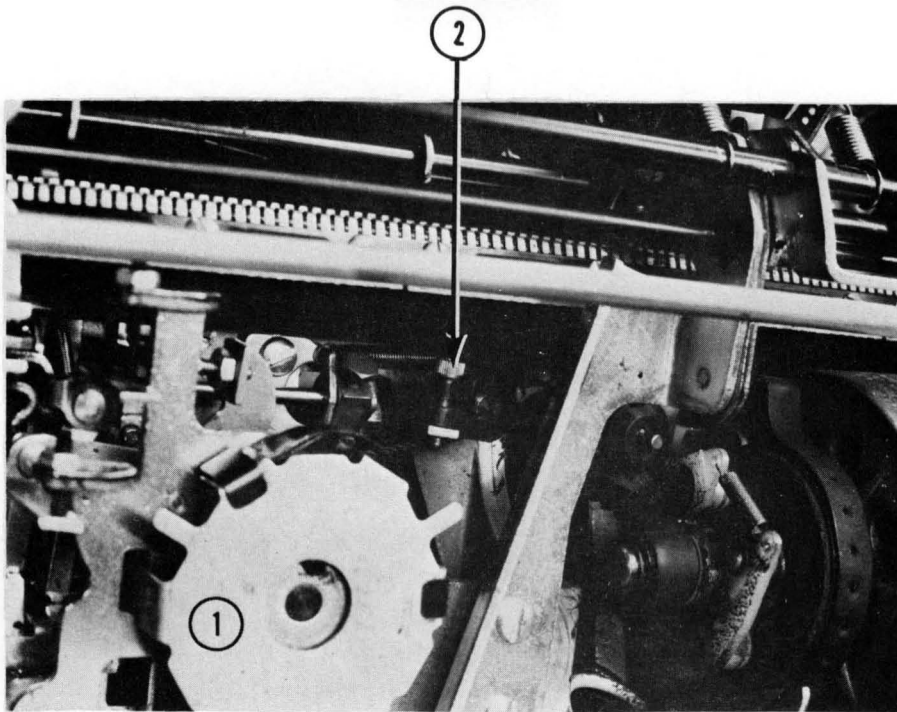

Figure 17

1. Mainspring 2. Escapement torque bar backstop

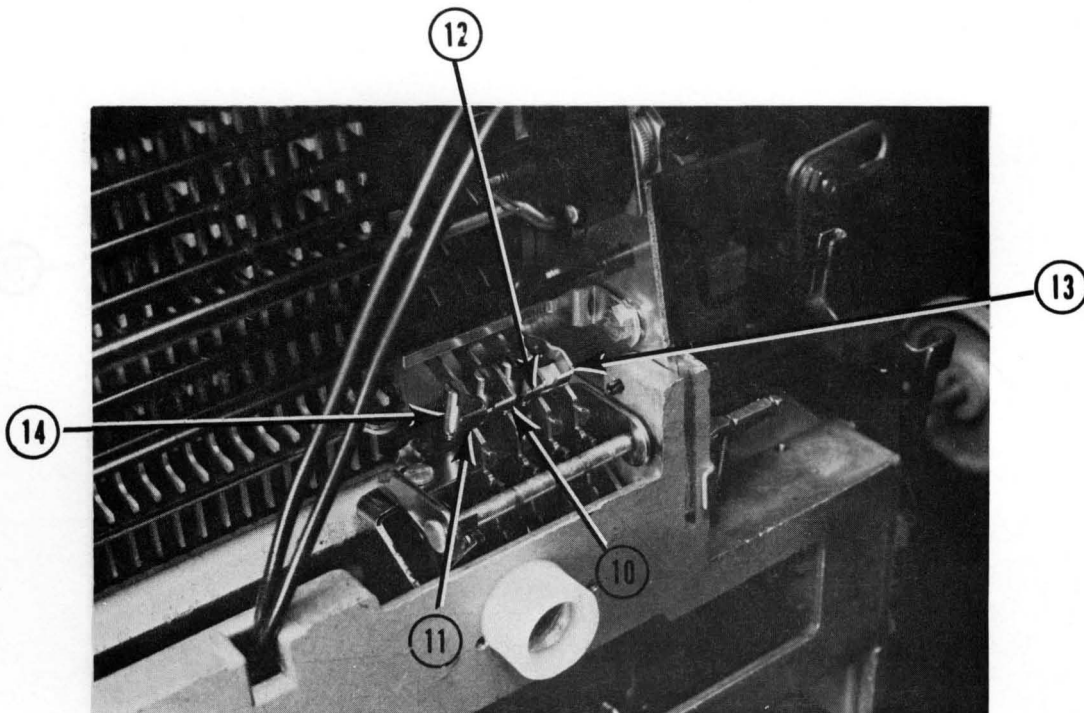

Figure 18

10. Backspace keylever pawl 11. Spacebar keylever pawl
 12. Carrier return pawl 13. Index keylever pawl 14. Adjusting screw

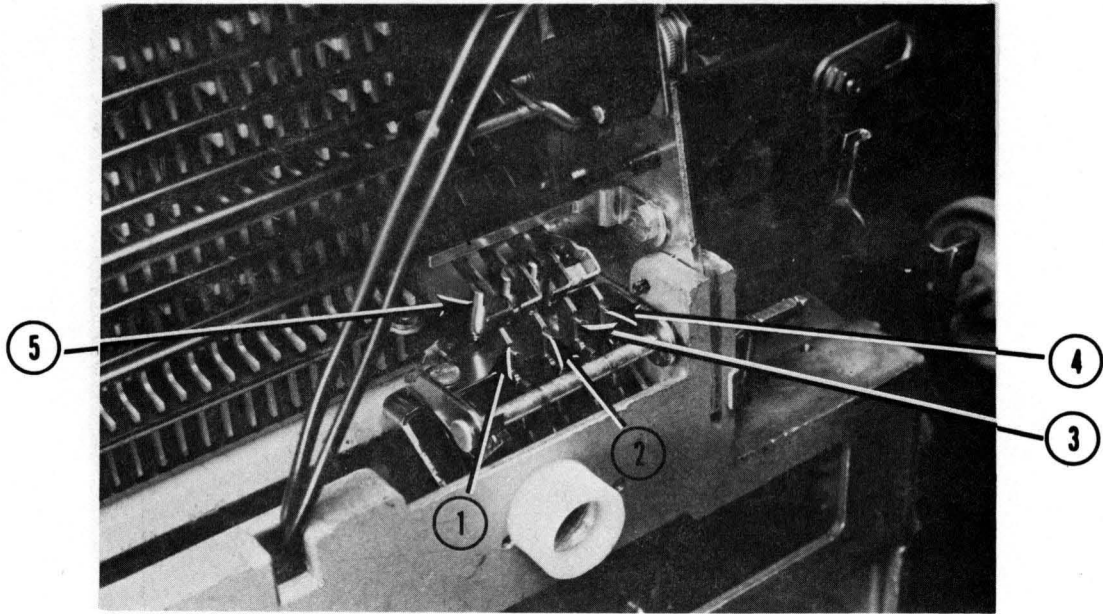

Figure 19

1. Spacebar interposer 2. Backspace interposer 3. Carrier return interposer 4. Index interposer 5. Keylever guide

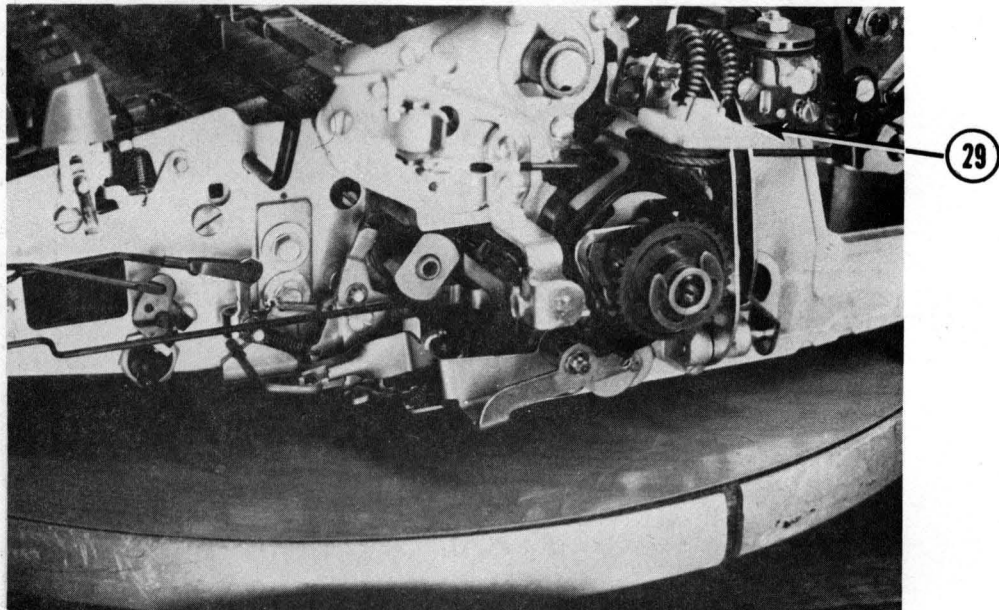

Figure 19B

29. Cord tension pulley

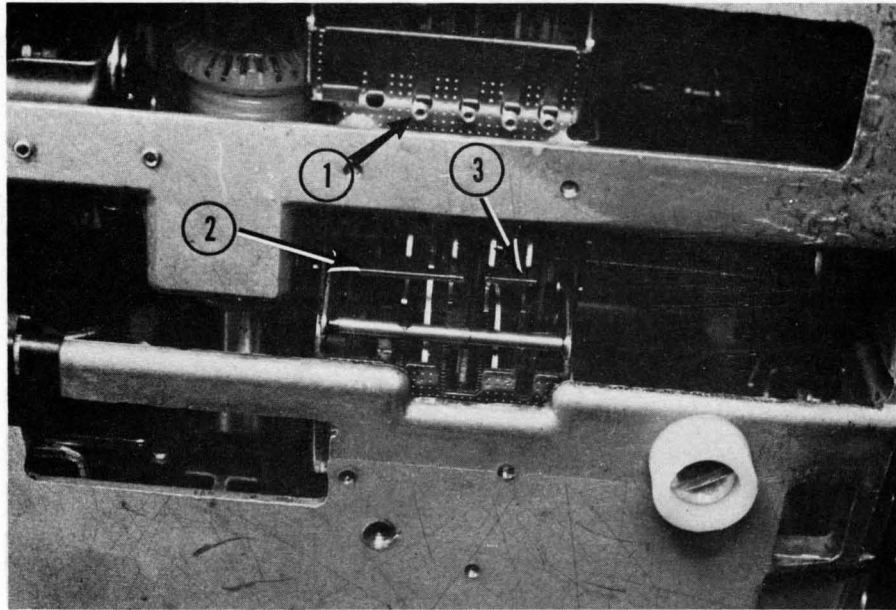

Figure 20

1. Adjustment screw for spacebar latch & etc. 2. Clutch release arm for spacebar-backspace. 3. Clutch release arm for index-carrier return.

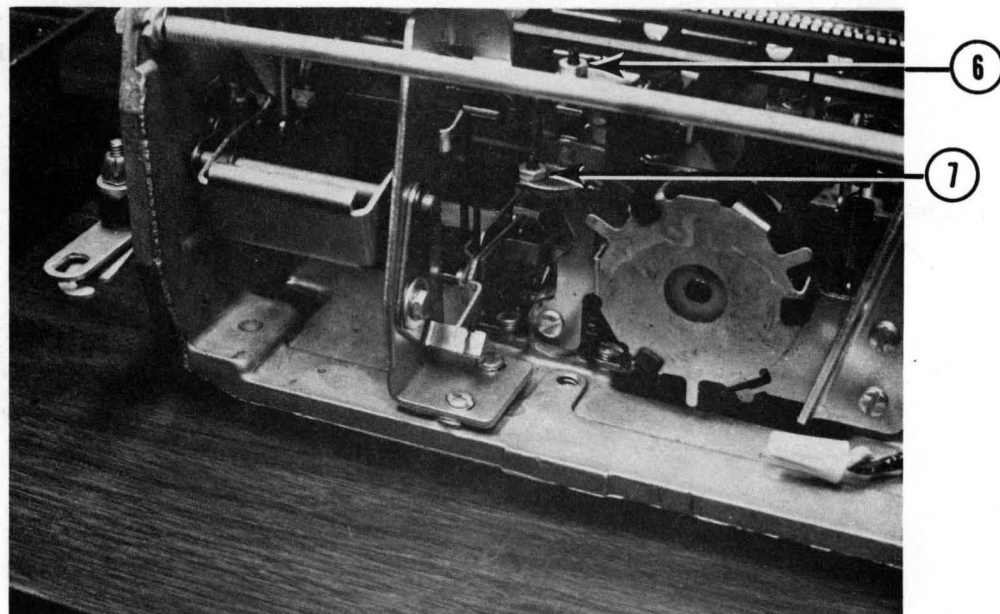

Figure 21

6. Spacebar latch adjusting screw. 7. Backspace latch adjusting screw.

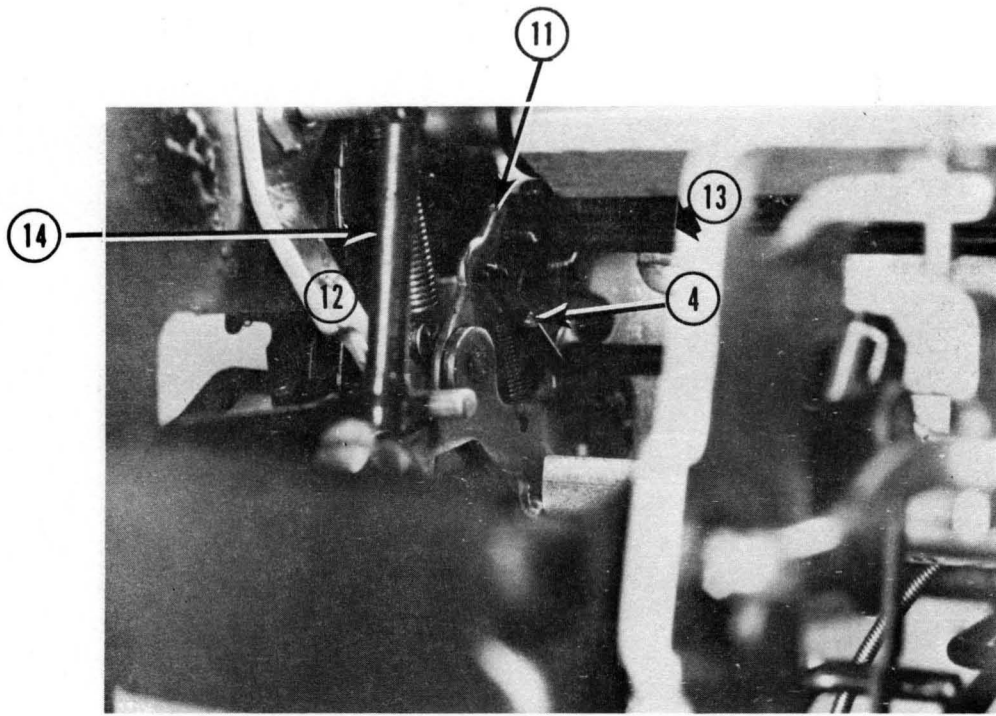

Figure 22

11. Escapement trigger 12. Trigger upstop 13. Escapement torque bar 14. Trigger restoring spring 4. Trigger link

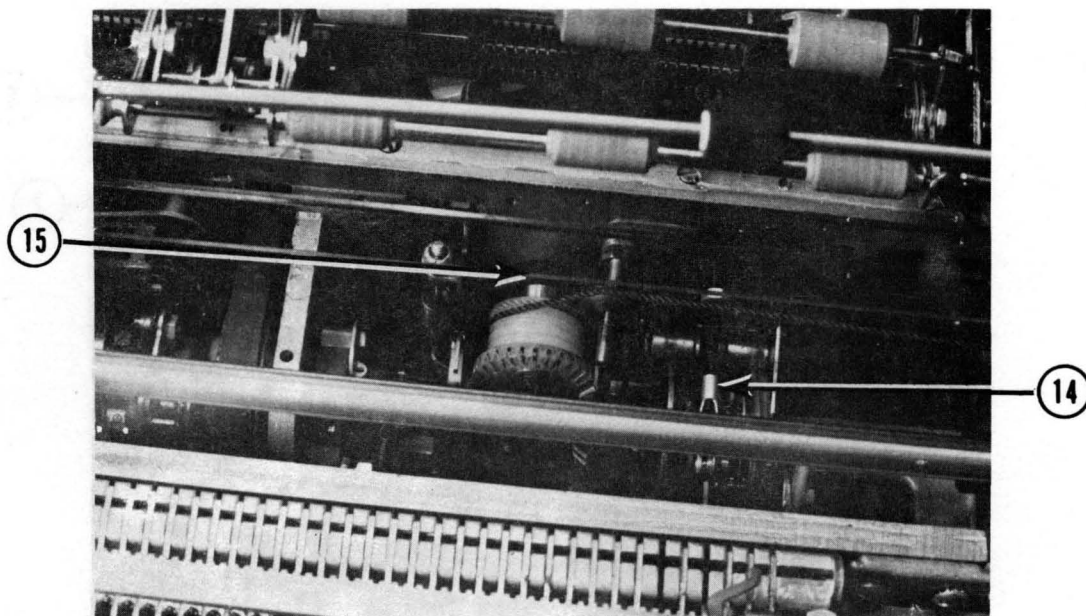

Figure 23

14. Escapement trip link 15. Escapement shaft bearing

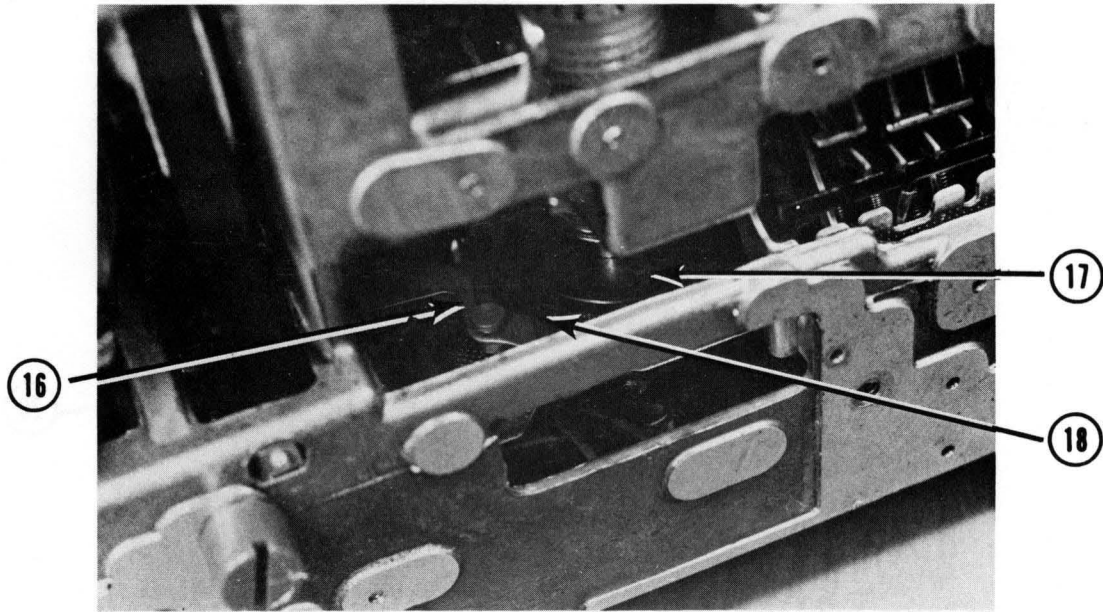

Figure 24

16. Backspace driver 17. Backspace ratchet 18. Clearance between driver and ratchet.

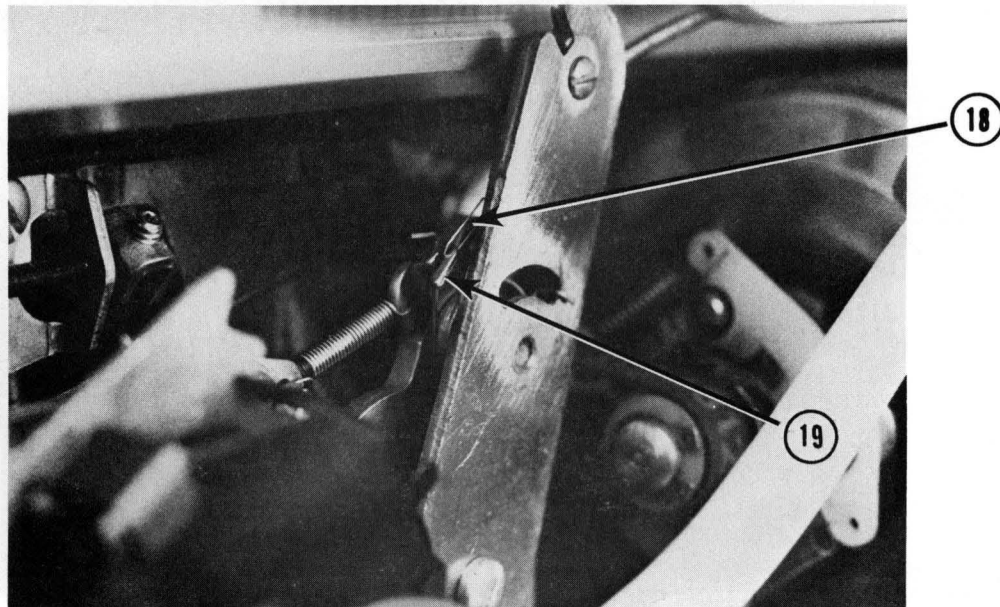

Figure 25

18. Pitch cam cable 19. Pitch cam

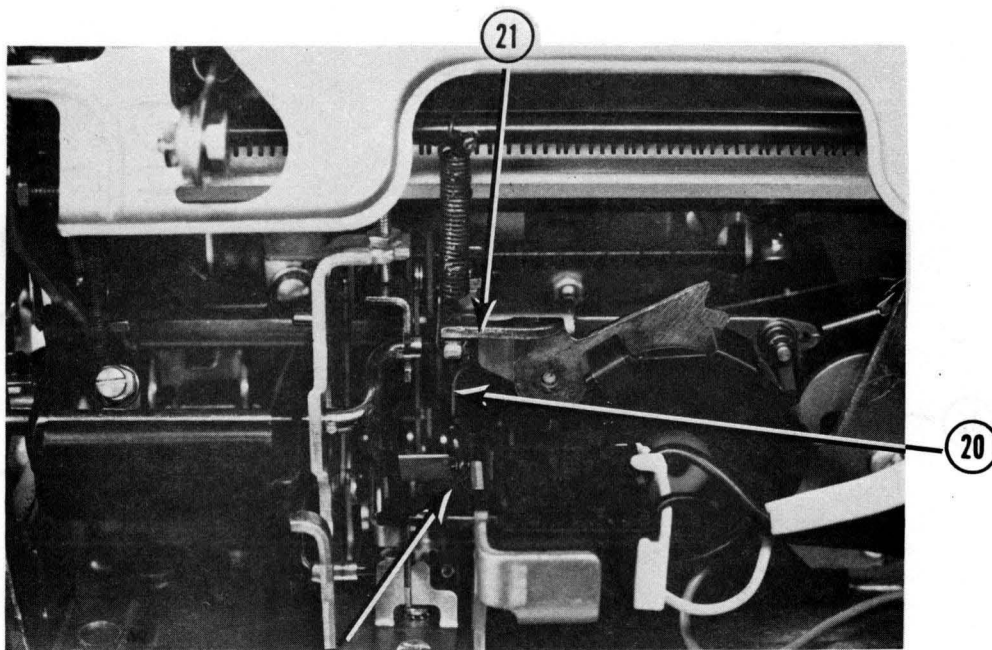

Figure 26

20. Backspace latch 21. Extension 22. Cam follower

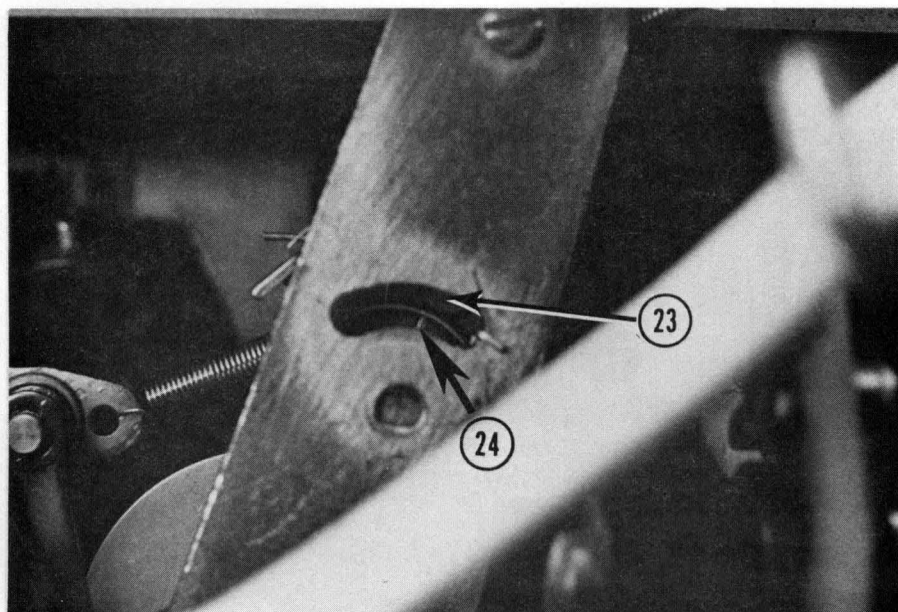

Figure 27

23. Stud 24. Mark (line)

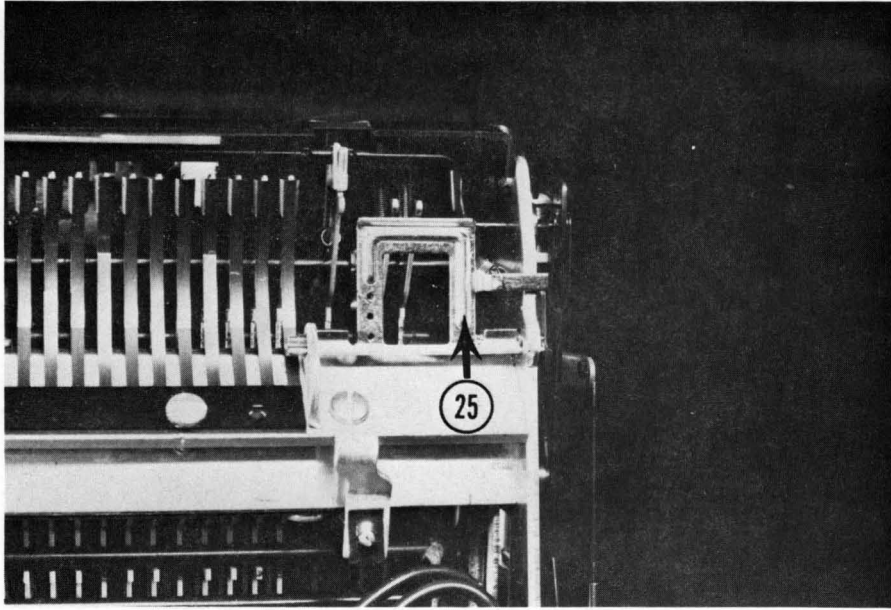

Figure 28

25. Repeat stop

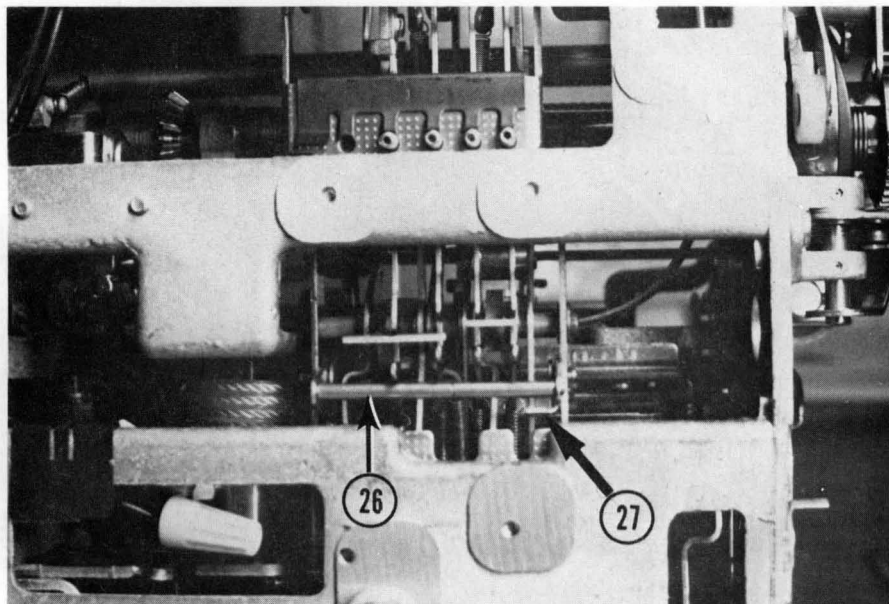

Figure 29

26. Interposer restoring bail 27. Adjustable lugs

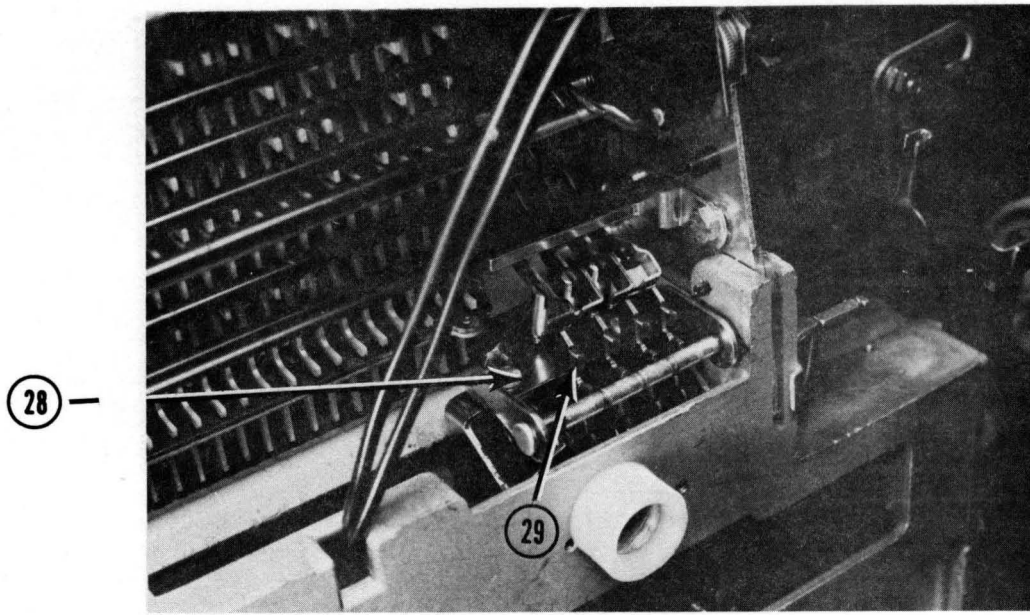

Figure 30

28. Latch plate 29. Latch

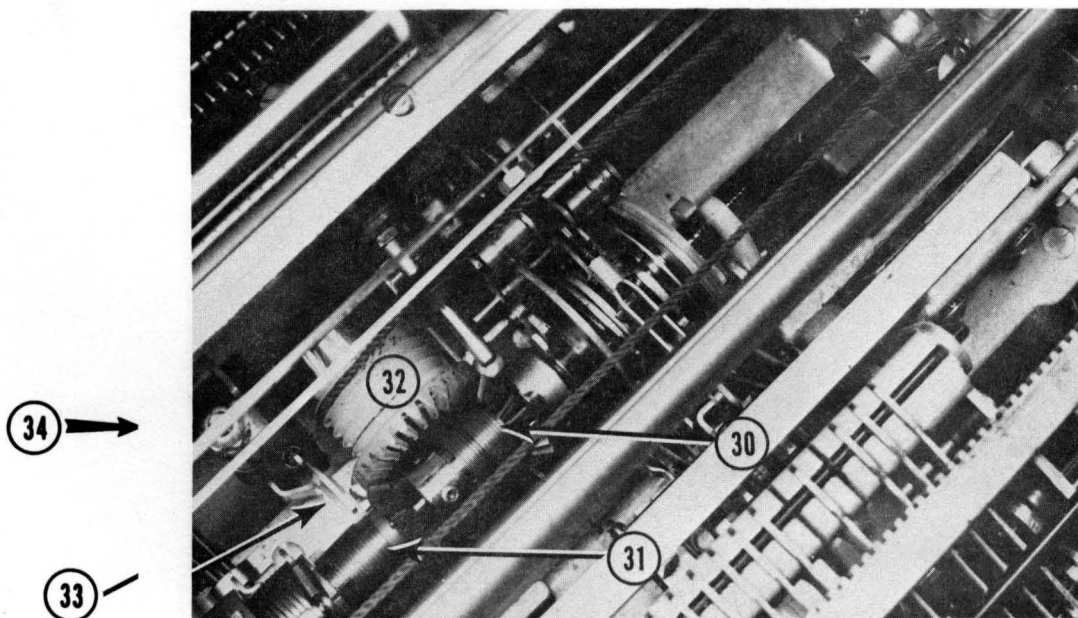

Figure 31

30. Tab pinion gear & spring 31. Carrier return pinion gear & spring
 32. Escapement cord drum & gear 33. Carrier return shoe
 34. Carrier return shoe adjusting screw.

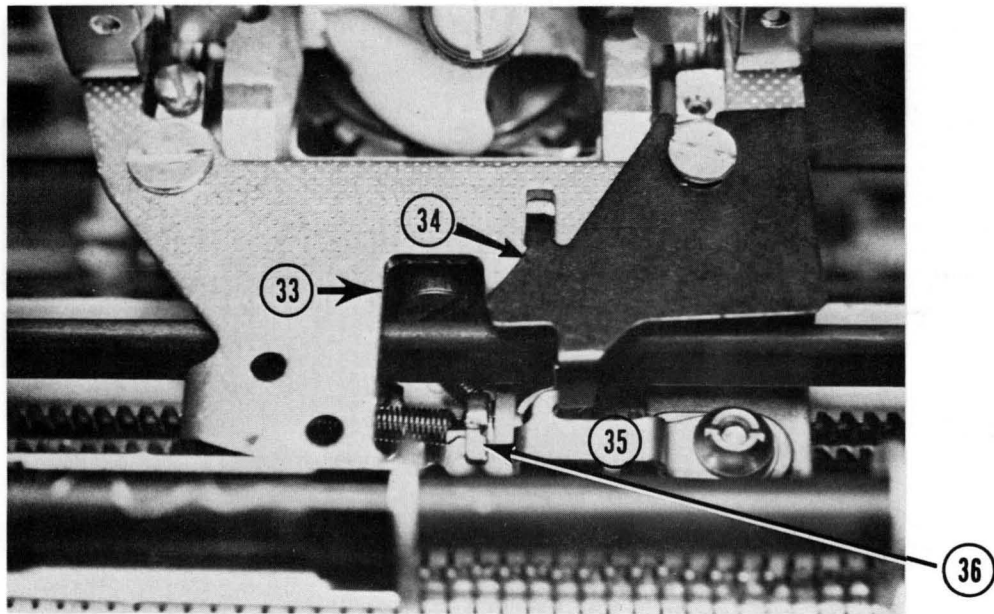

Figure 32

33. Carrier shoe adjusting screw 34. Tab overthrow stop
 35. Tab trigger 36. Tab lever & spring

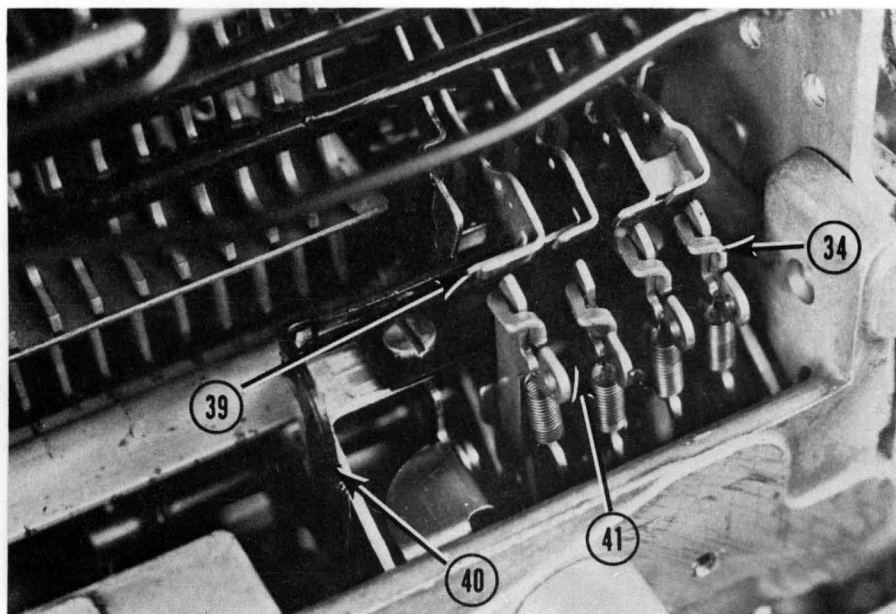

Figure 33

34. Interposer latches 39. Keylever pawl 40. Express bellcrank
 41. Location of single pitch latch for automatic backspace release.

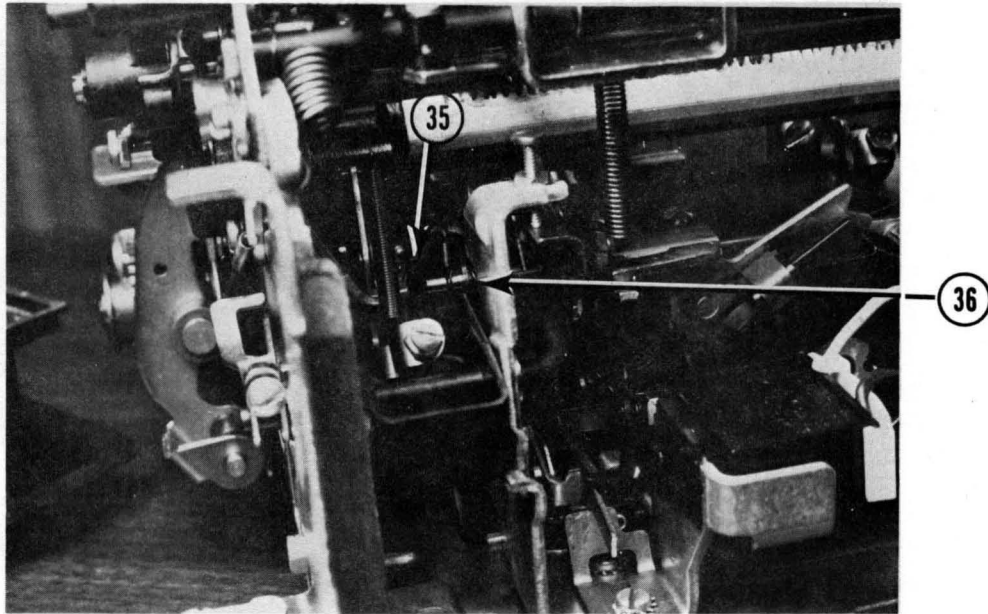

Figure 33A

35. Paddle (interlock) 36. Interlock lug

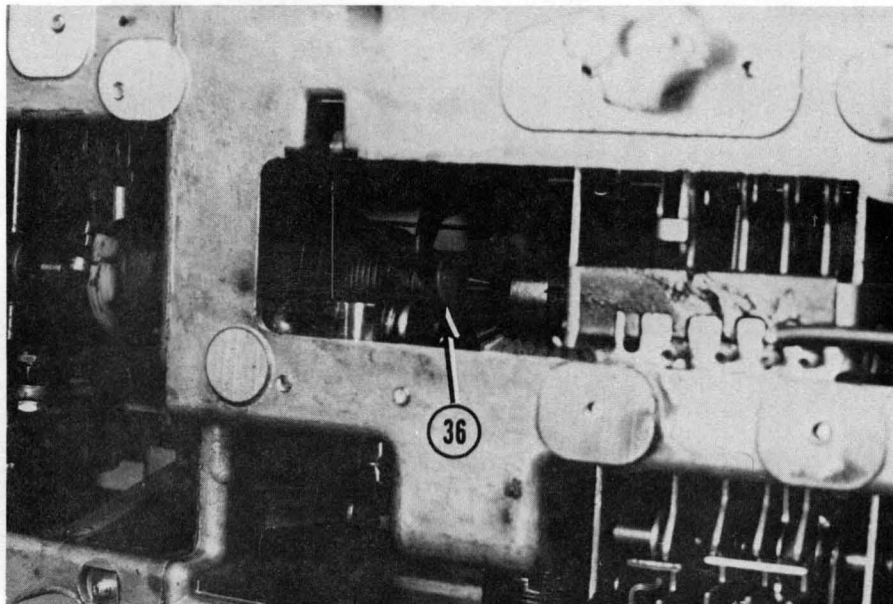

Figure 34

36. Express backspace shoe

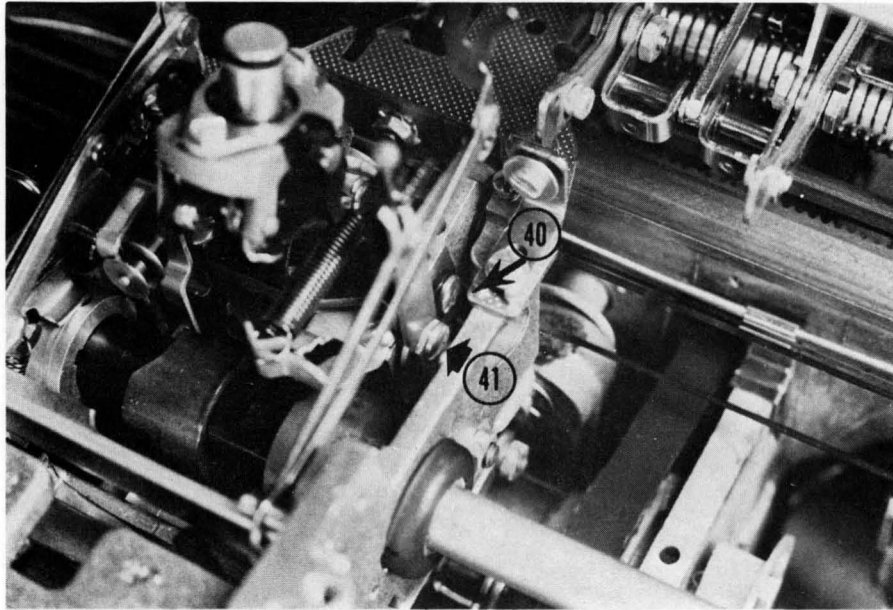

Figure 35

Arrows point to powered and free flight adjusting screws.
40. Adjusting screw 41. Adjusting eccentric

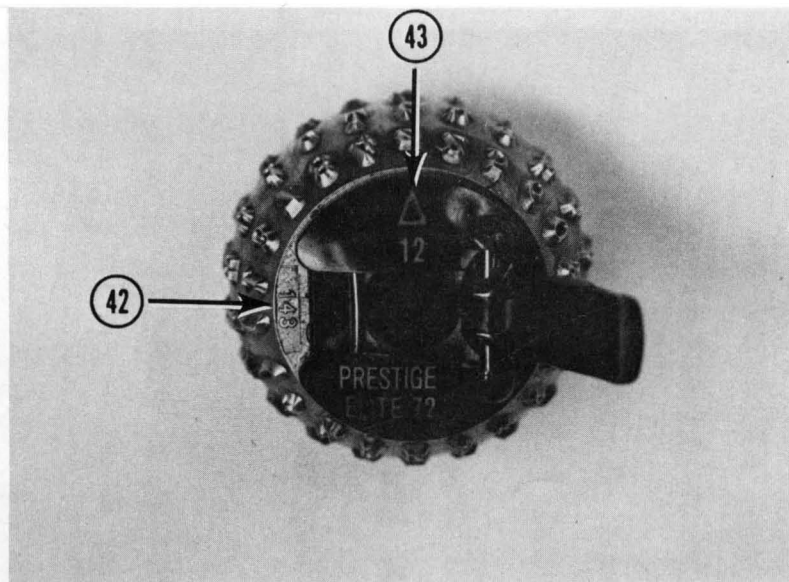

Figure 36

Typing element - Stock number (42) Pitch number (43)

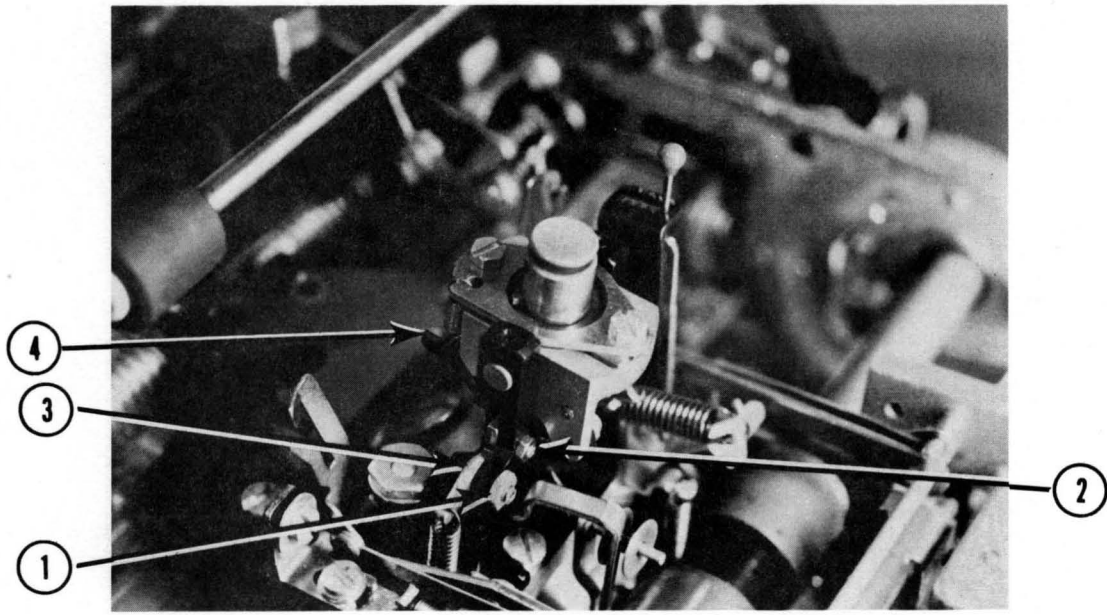

Figure 37

Check for binds in the rotate and tilt detents by rotating the machine, slowly, with the turning wheel while observing detent entry and exit. 1 & 2. Tilt detent adjusting screws 3. Tilt detent 4. Rotate detent and spring.

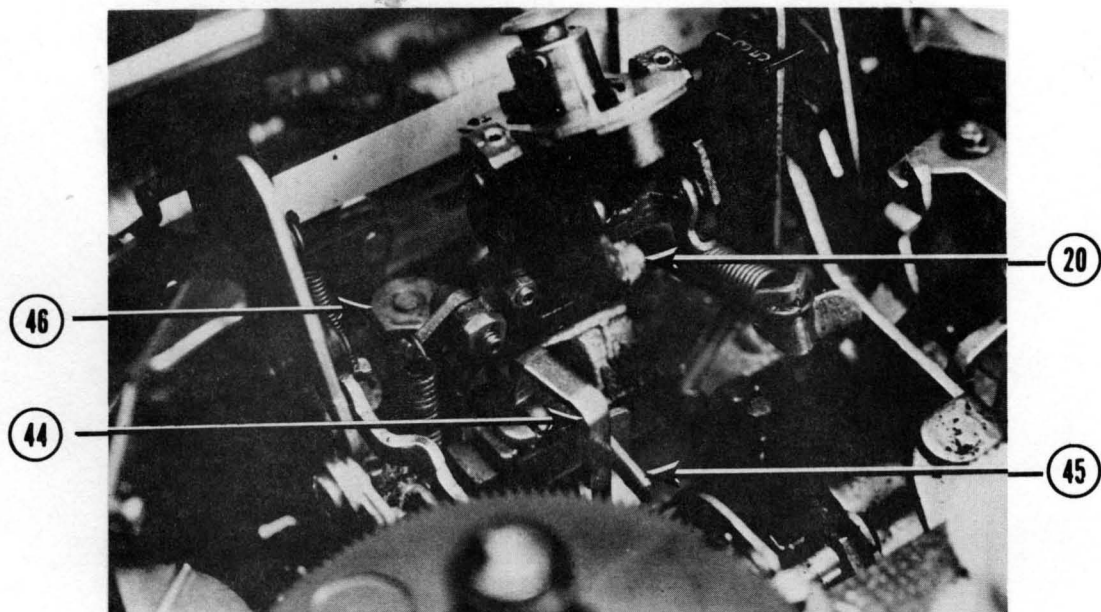

Figure 38

44. Detent actuating lever 45. Detent cam follower 46. Adjusting nut
20. Rotate detent adjusting screw.

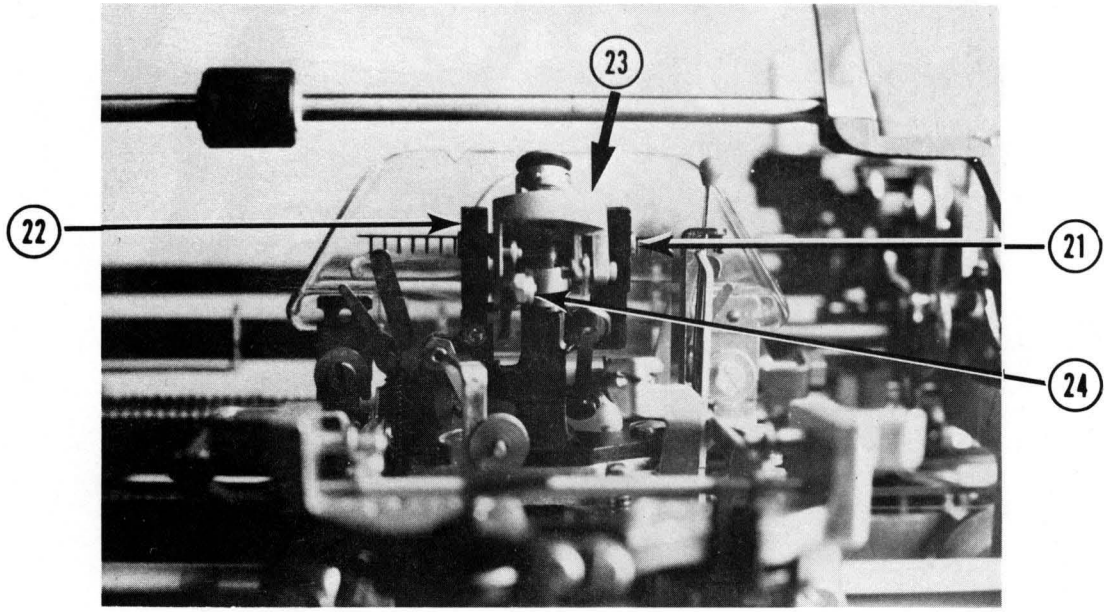

Figure 39

21. Pivot pins 22. Yoke 23. Tilt ring 24. Rotate detent nut

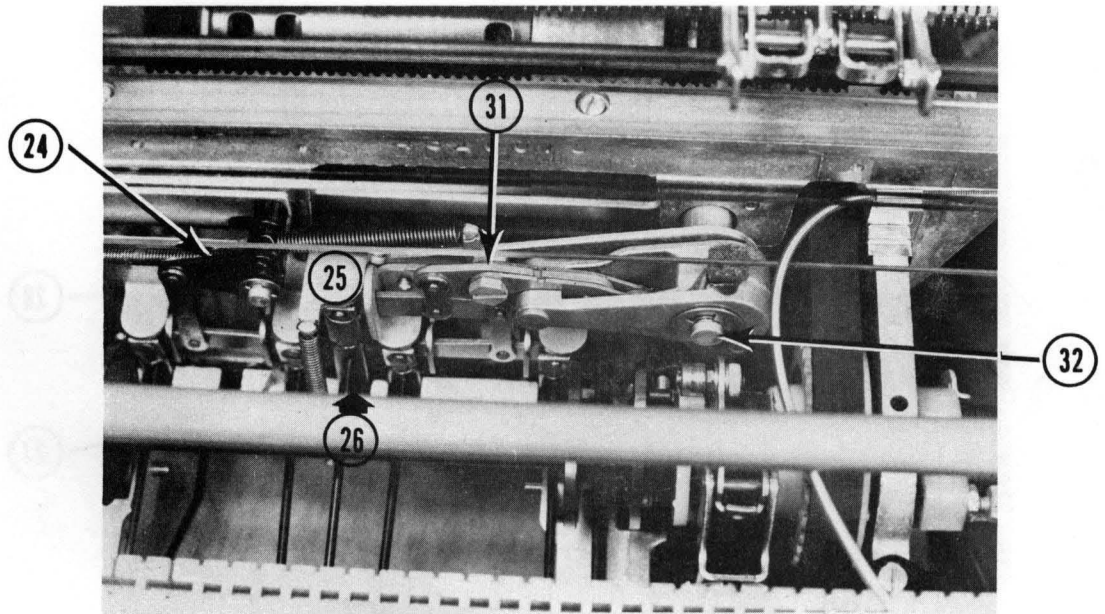

Figure 40

24. Tilt bellcrank 25. Latch stop pads 26. Selector latches
 31. Balance arm and locking screw 32. Rotate bellcrank pivot stud

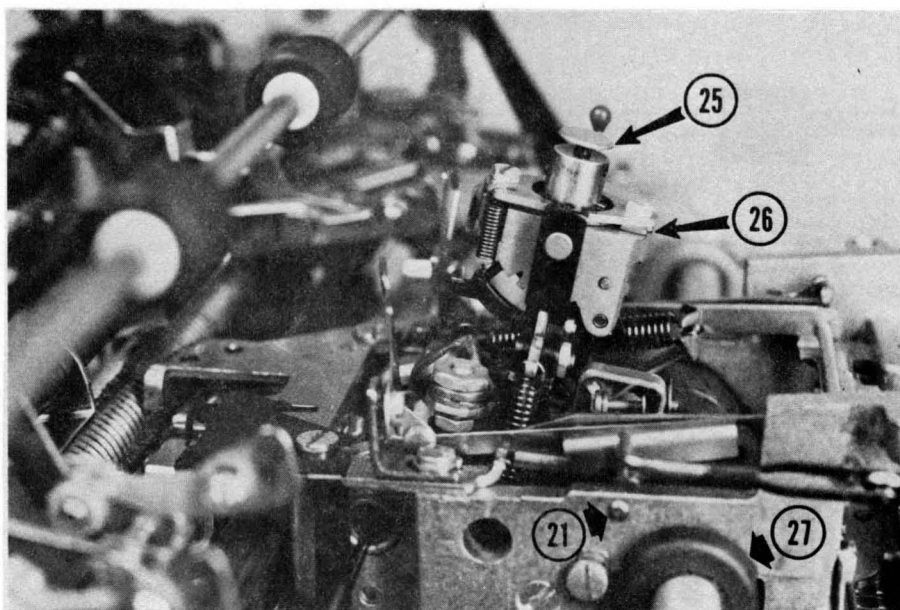

Figure 41

25. Upper ball socket 26. Tilt ring spacers 27. Print shaft wipers
 21. Pertrussion for preliminary alignment of print shaft.

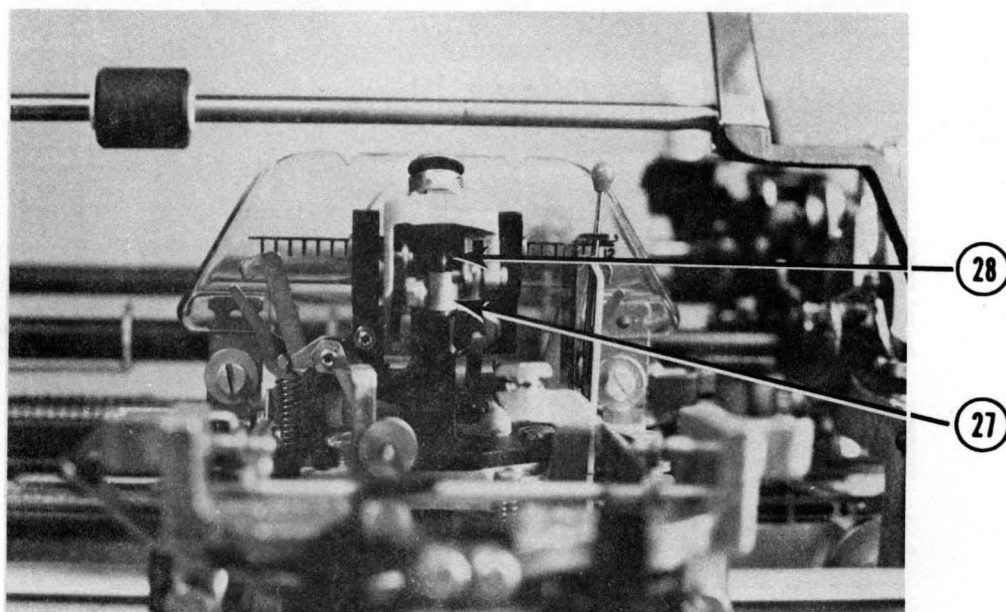

Figure 42

27. Lower ball socket or rotate shaft 28. Dogbone

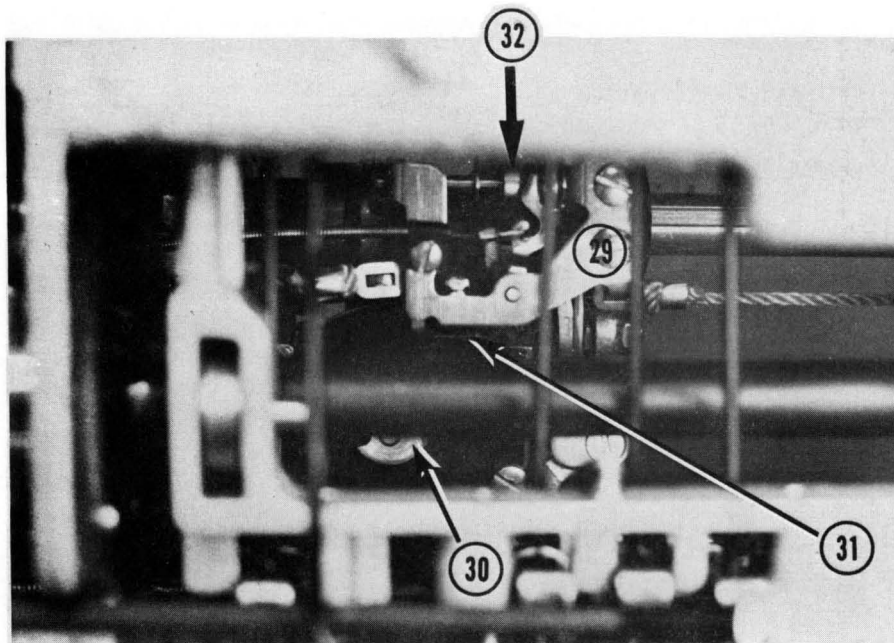

Figure 43

29. Velocity control bracket 30. Rotate shaft screw 31. Velocity
cam follower spring 32. Velocity cam follower

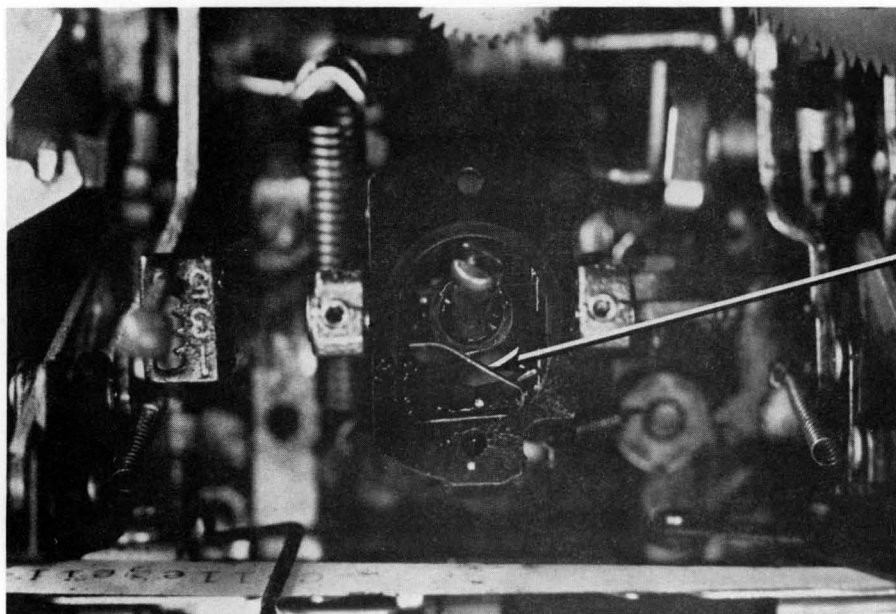

Figure 44

31. Bias spring

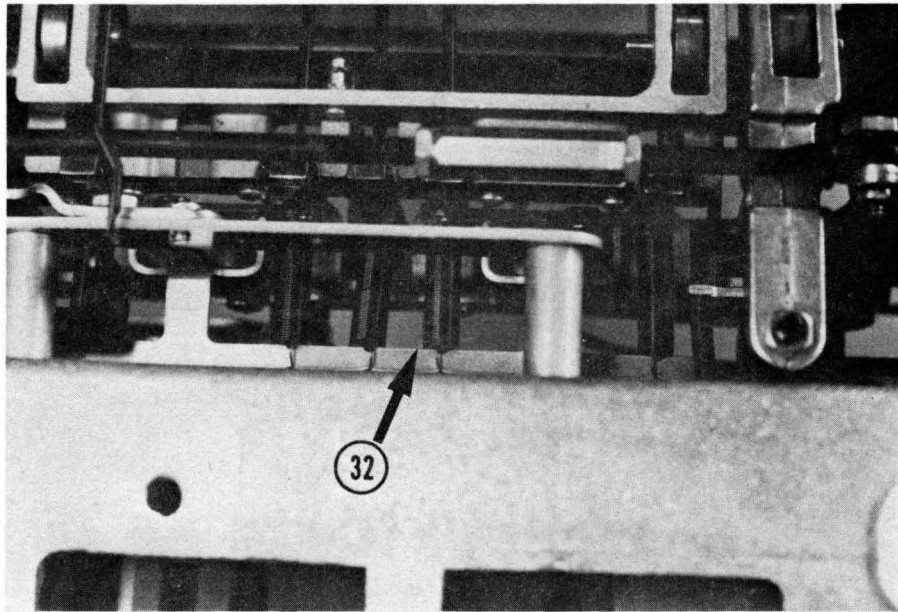

Figure 45

32. Tilt and rotate latch springs

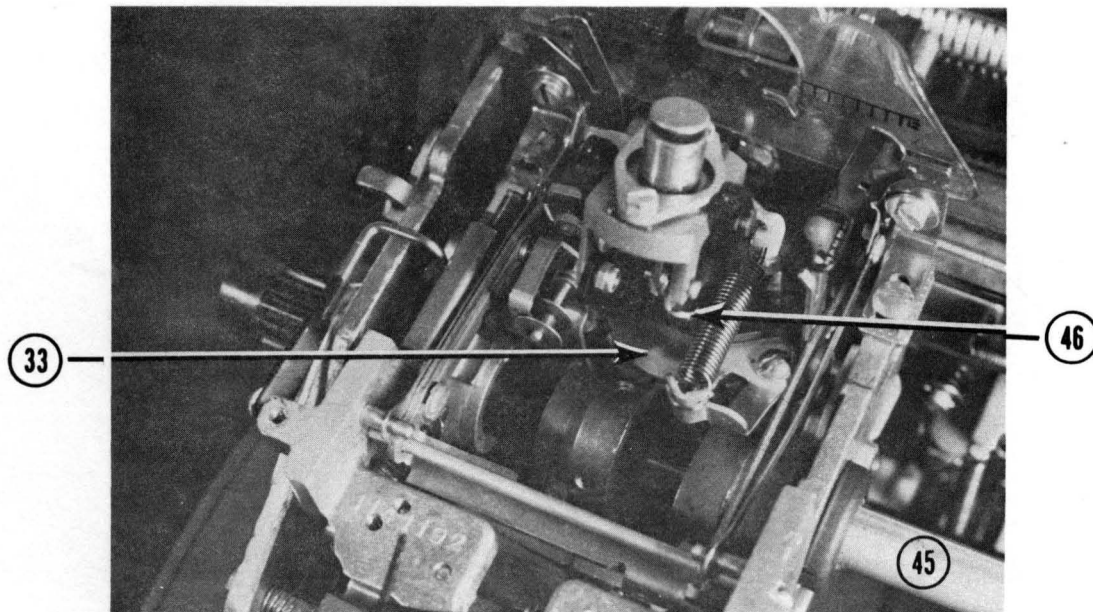

Figure 46

33. Rotate pulley and spring 46. Tilt detent link 45. Print shaft

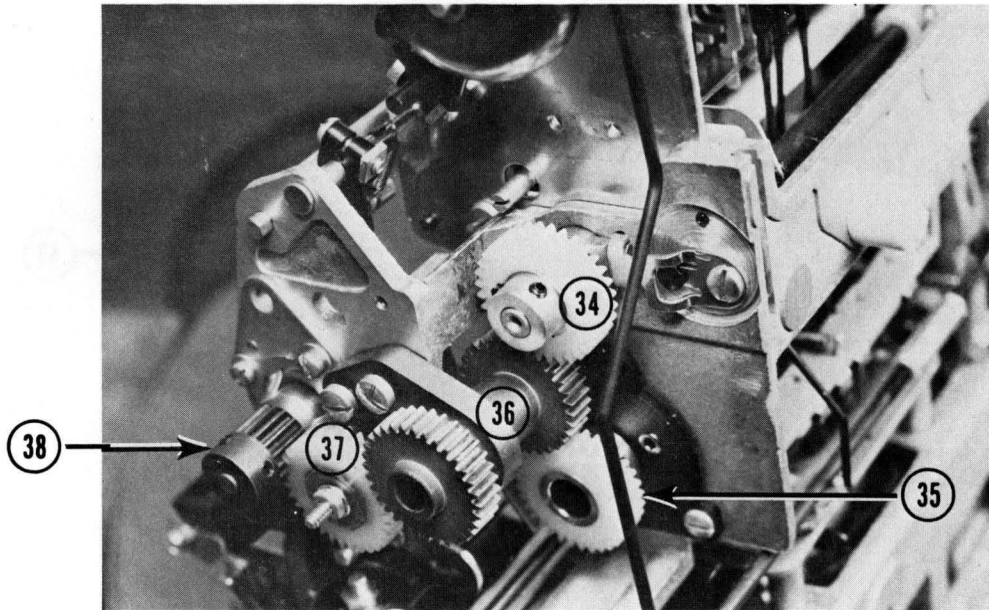

Figure 47

Gear train - 34. Filter shaft gear 35. Cycle shaft gear 36. Lower idler gear 37. Upper idler gear 38. Print shaft gear

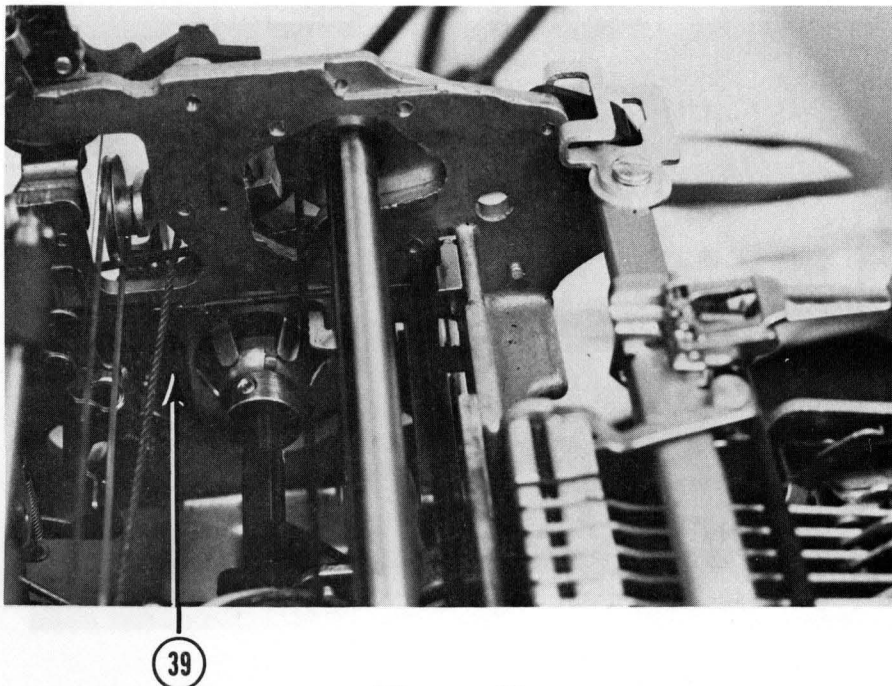

Figure 48

39. Shift backup roller for cam.

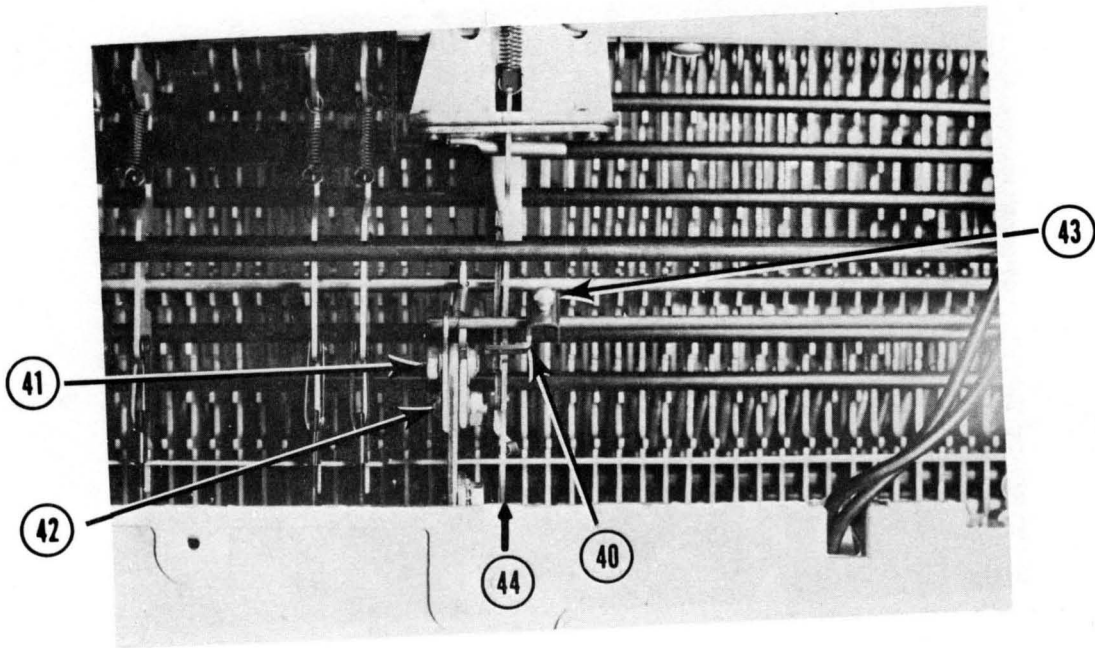

Figure 49

40. Character interrupter 41. Nut 42. Screw 43. Character interrupter adjusting screw 44. Cycle clutch link.

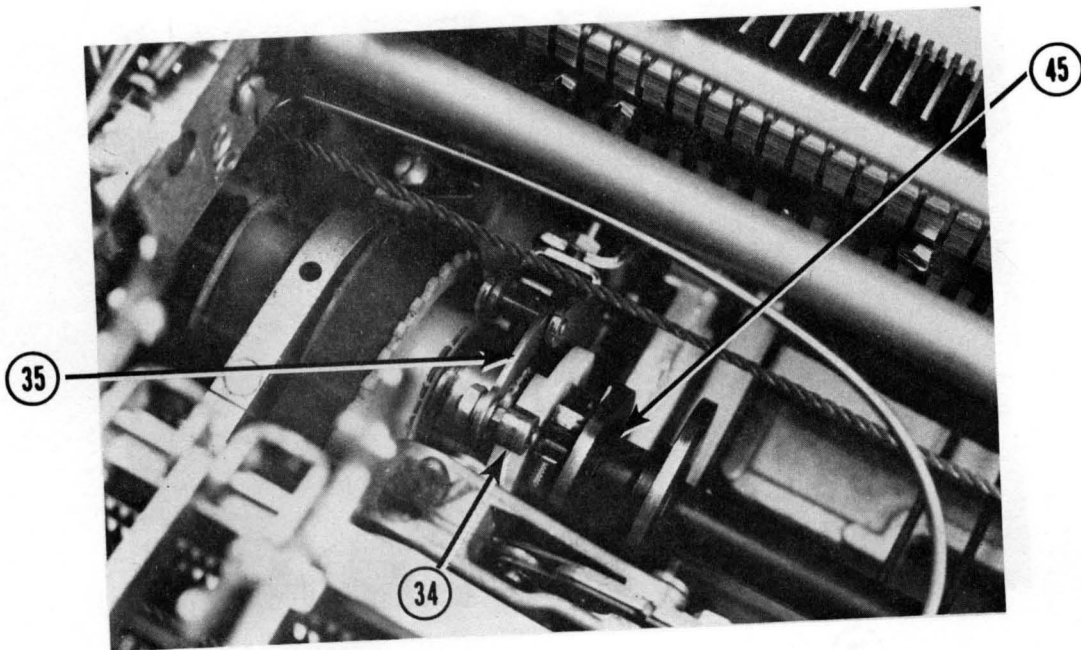

Figure 50. Cycle clutch

45. Lubrication point 34. Restoring stud 35. Cycle clutch latch

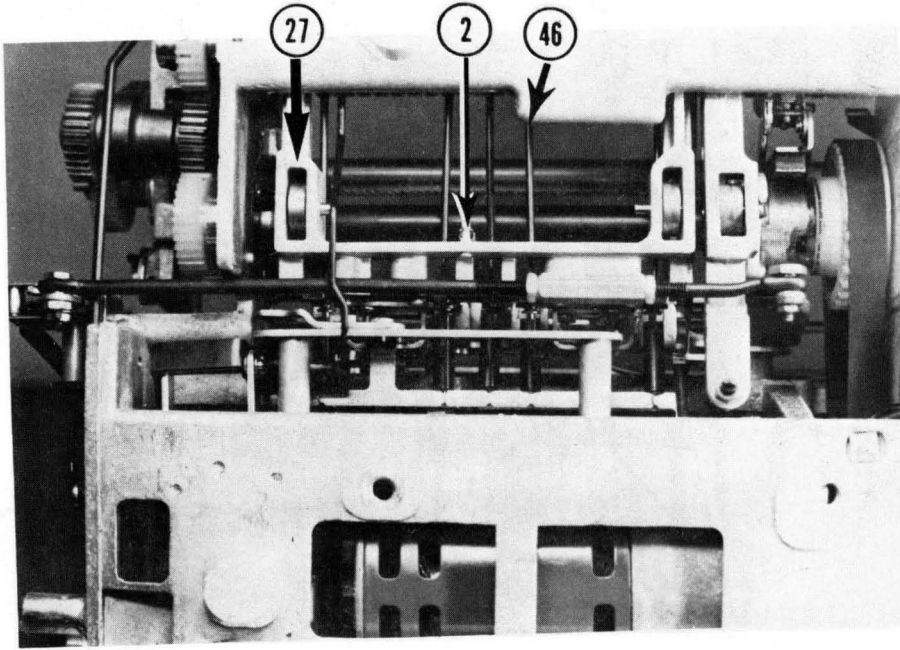

Figure 51

46. Selector latch links 2. Positive bail spring 27. Positive bail

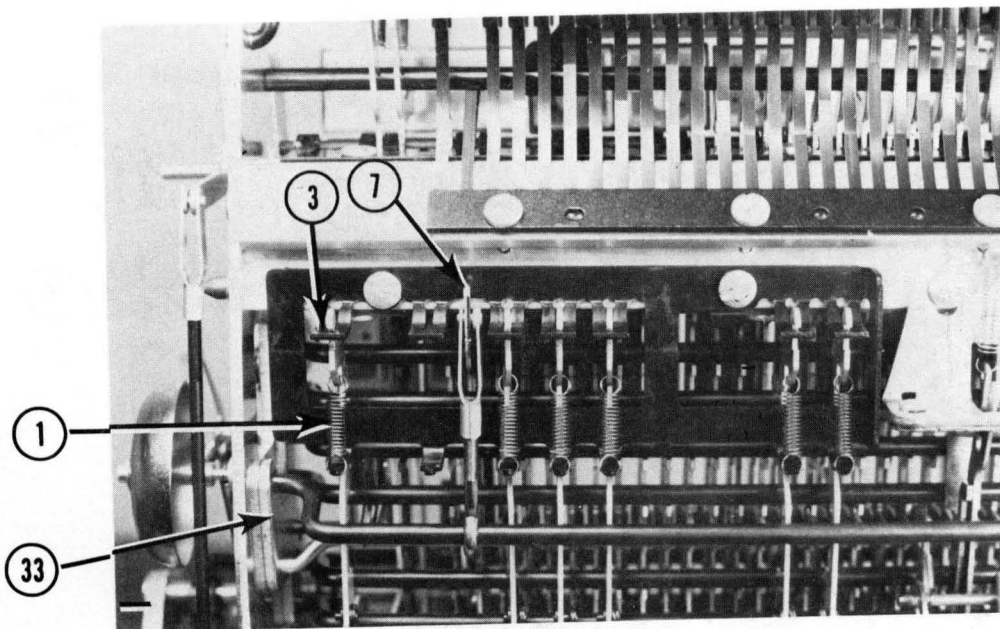

Figure 52

1. Interposer restoring springs 3. Interposer stop lugs 7. Keyboard lockout bellcrank 33. Bail mounting plate

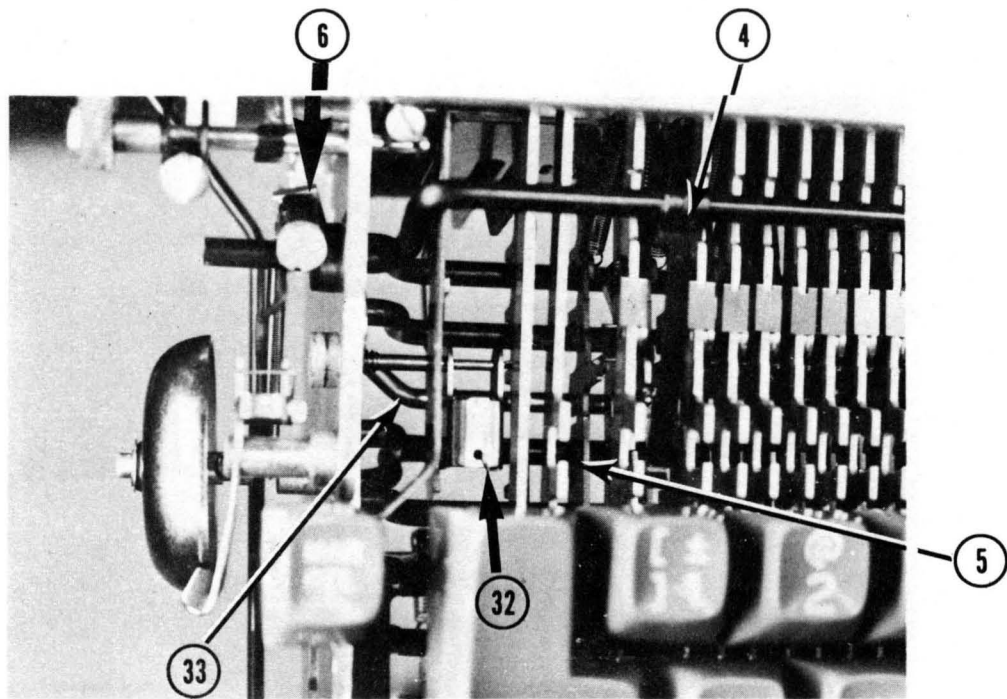

Figure 53

4. Keyboard lock bail 5. Keyboard lockout bellcrank 6. Bell clapper bellcrank 32. Damper springs 33. Cycle bail

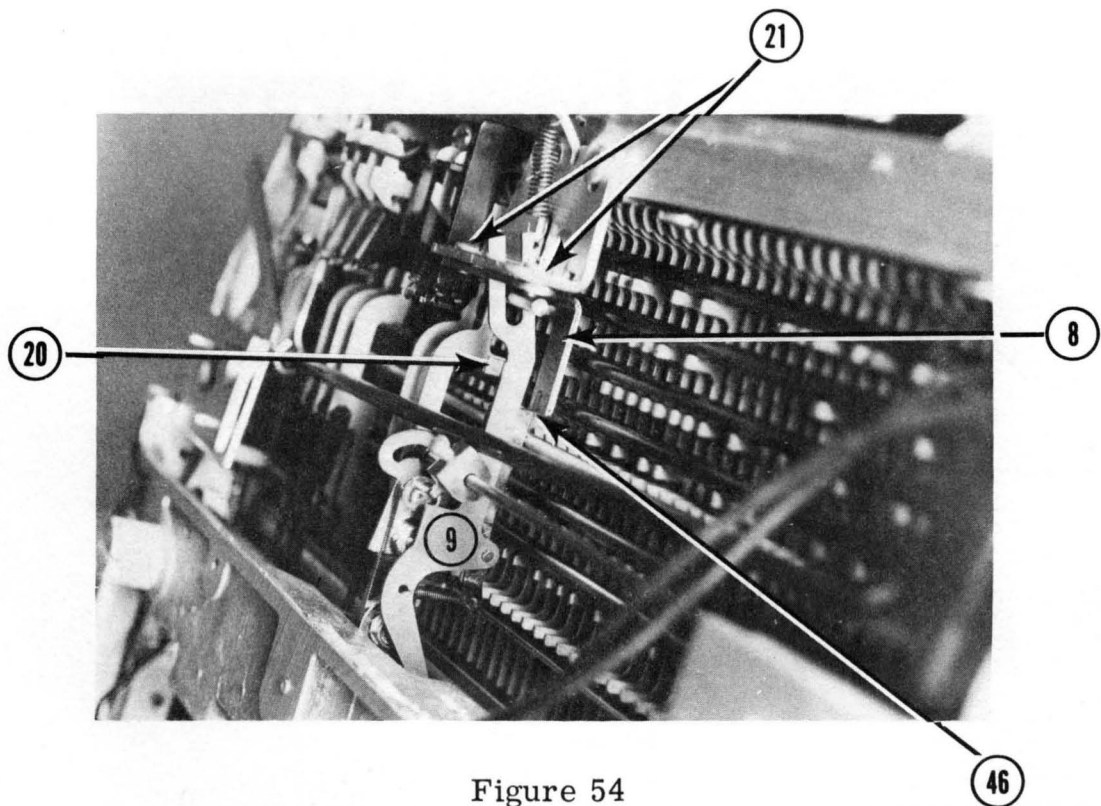

Figure 54

8. Cycle clutch latch keeper 9. Cycle clutch latch link 20. Latch pawl 21. Adjusting screws for cycle clutch latch keeper 46. Adjustable clearance.

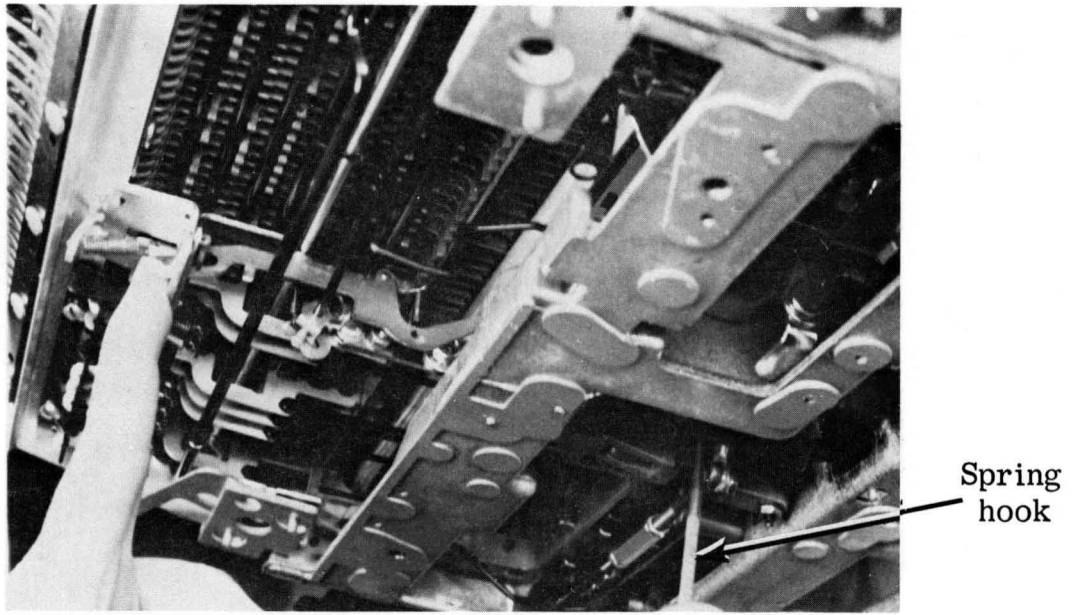

Figure 54A

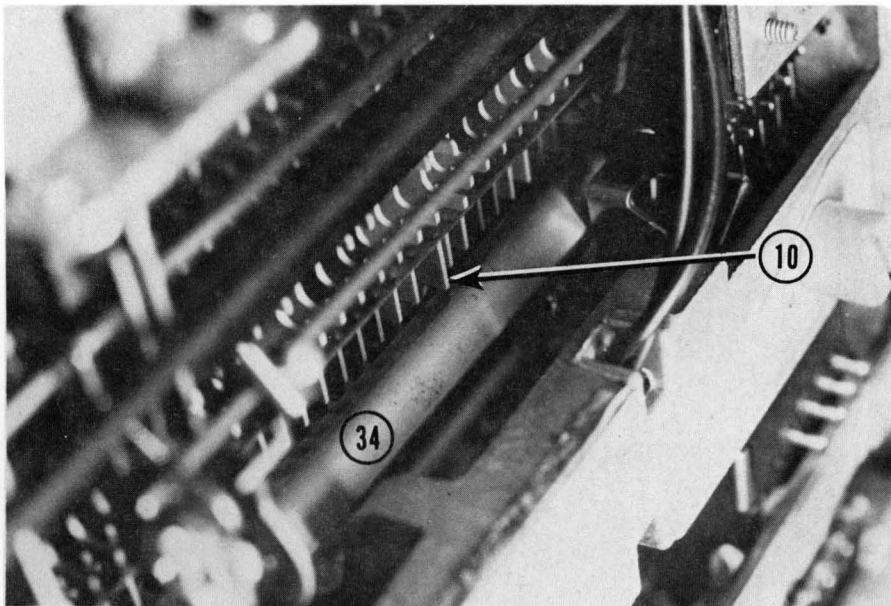

Figure 55

Shown is a latched down interposer (10) and the filter shaft (34). The adjustable clearance between the filter shaft and a latched down interposer is approximately .015". When the filter shaft rotates it contacts the interposer.

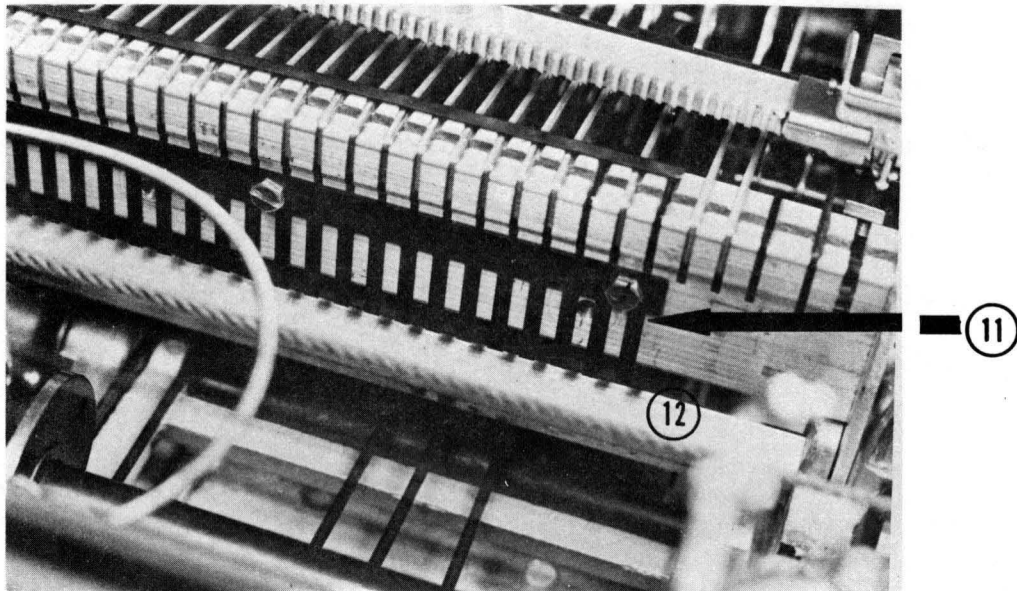

Figure 56

11. Interposer latch springs 12. Filter shaft
 NOTE: Interposer latch springs come in two sections.

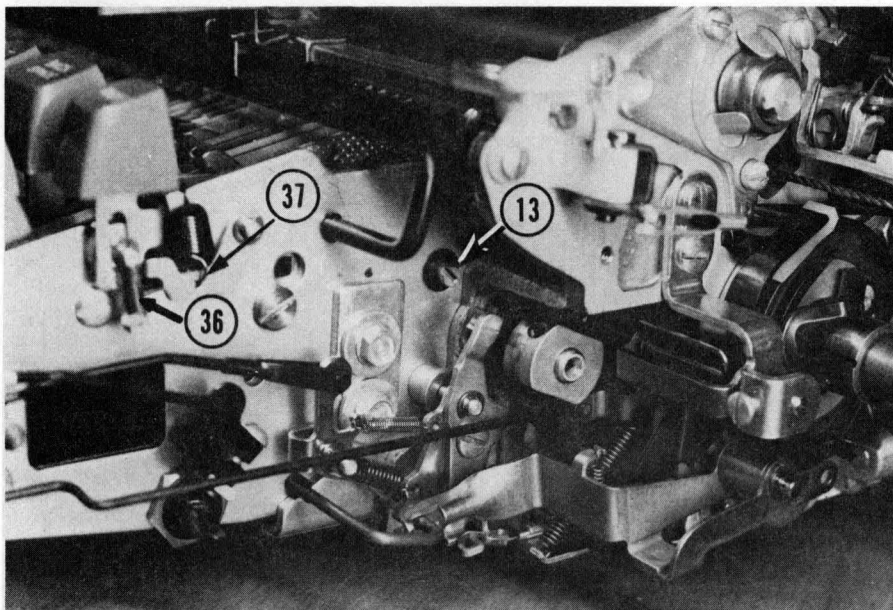

Figure 57

13. Arrow points to compensator adjustable end plug for the interposers
 36. Keylever restoring spring 37. Index pawl spring

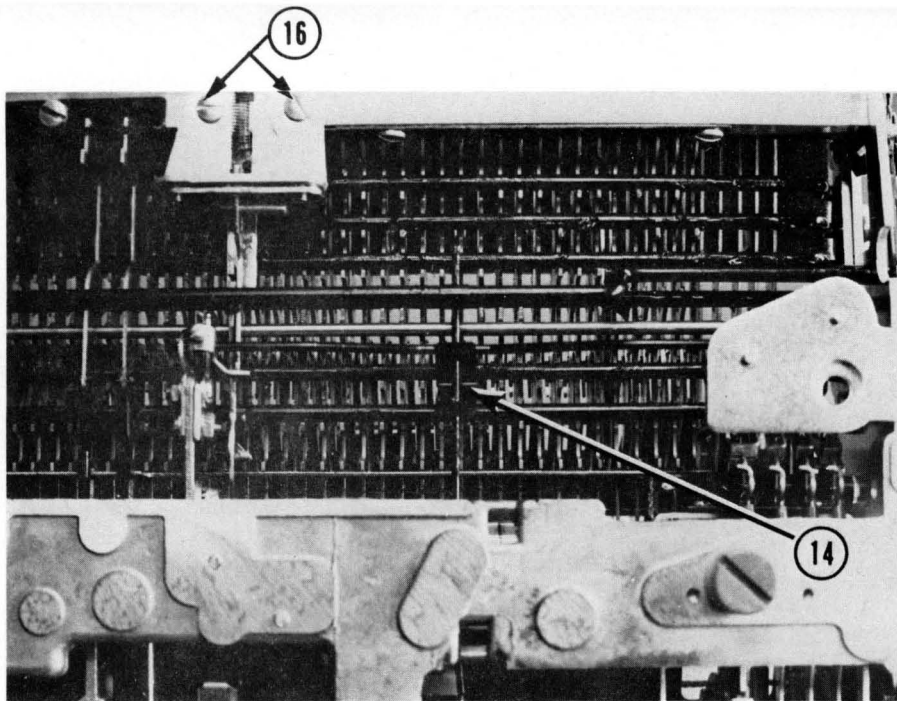

Figure 58

14. Carrier return print interlock 16. Cycle clutch latch adjusting screws

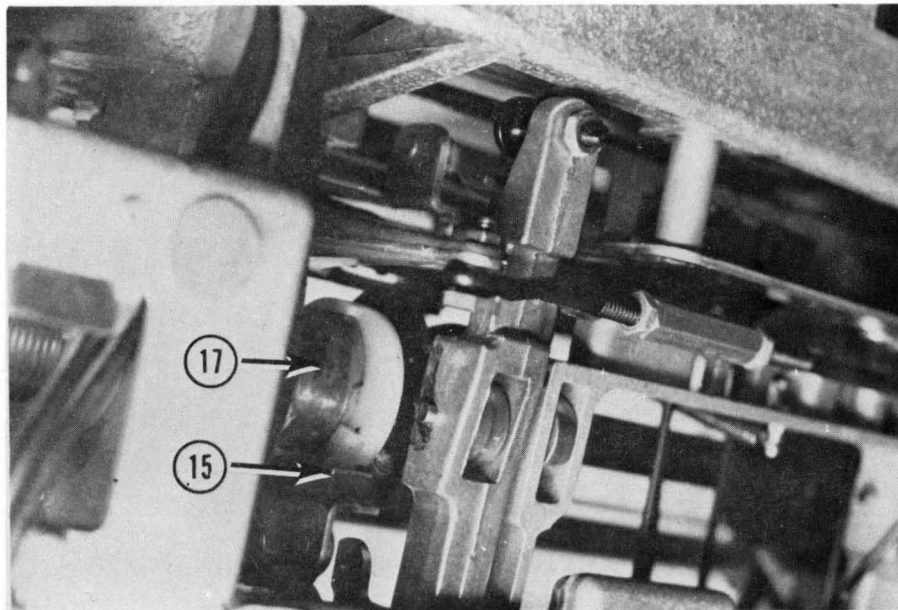

Figure 59

15. Cycle clutch latch 17. Cycle clutch sleeve

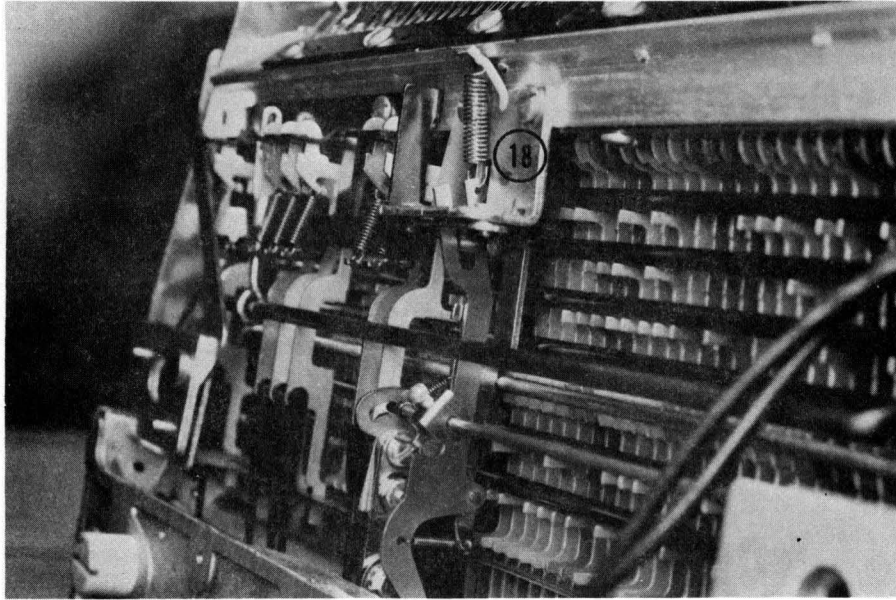

Figure 60

18. Cycle clutch latch keeper bracket

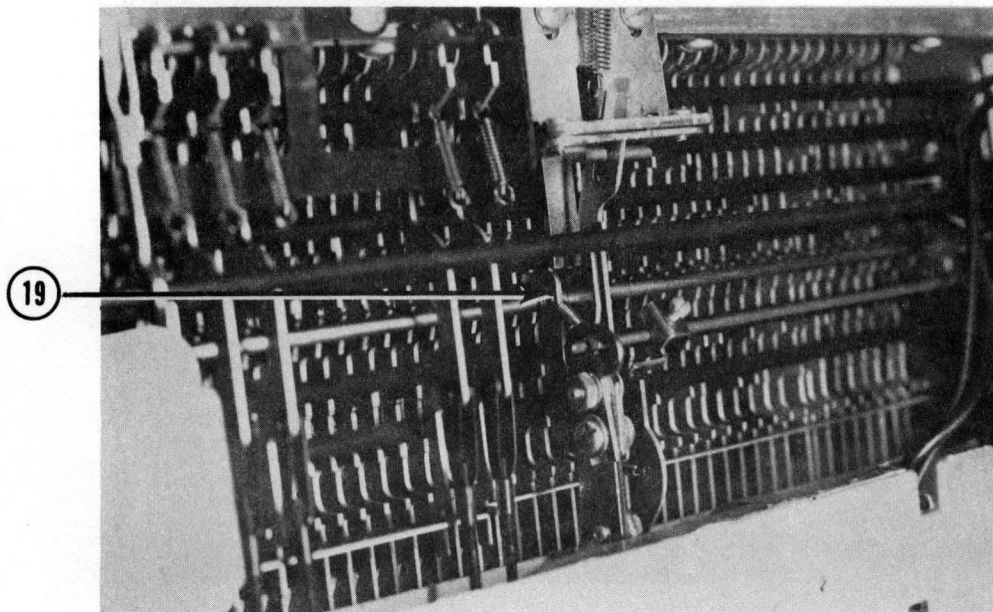

Figure 61

19. Cycle bail upstop

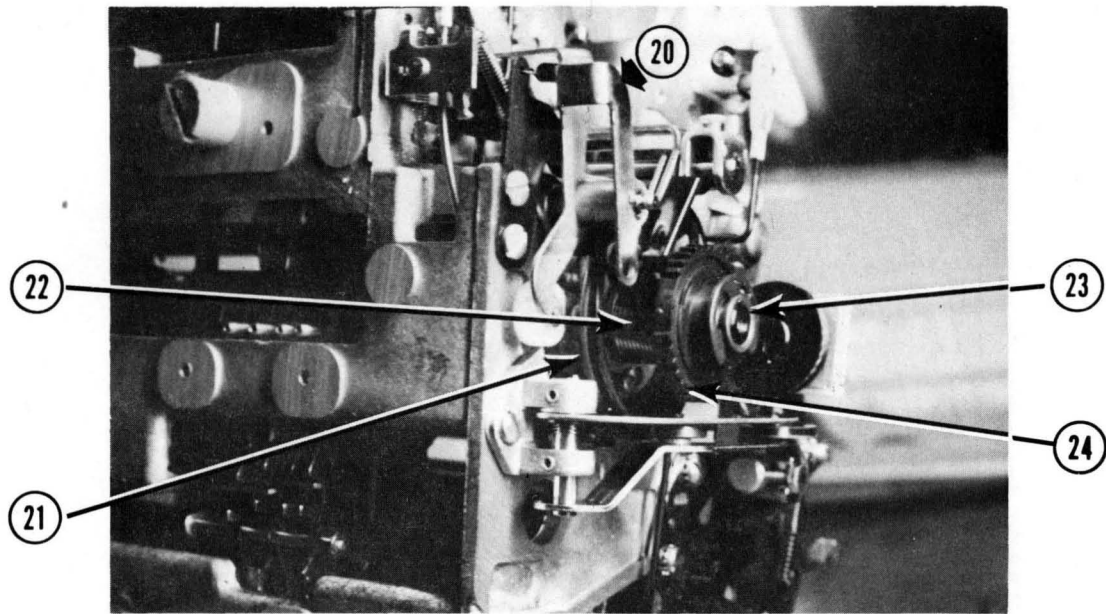

Figure 62

20. Shift detent arm 21. Shift cam 22. Shift spring 23. Shift arbor
 24. Shift ratchet

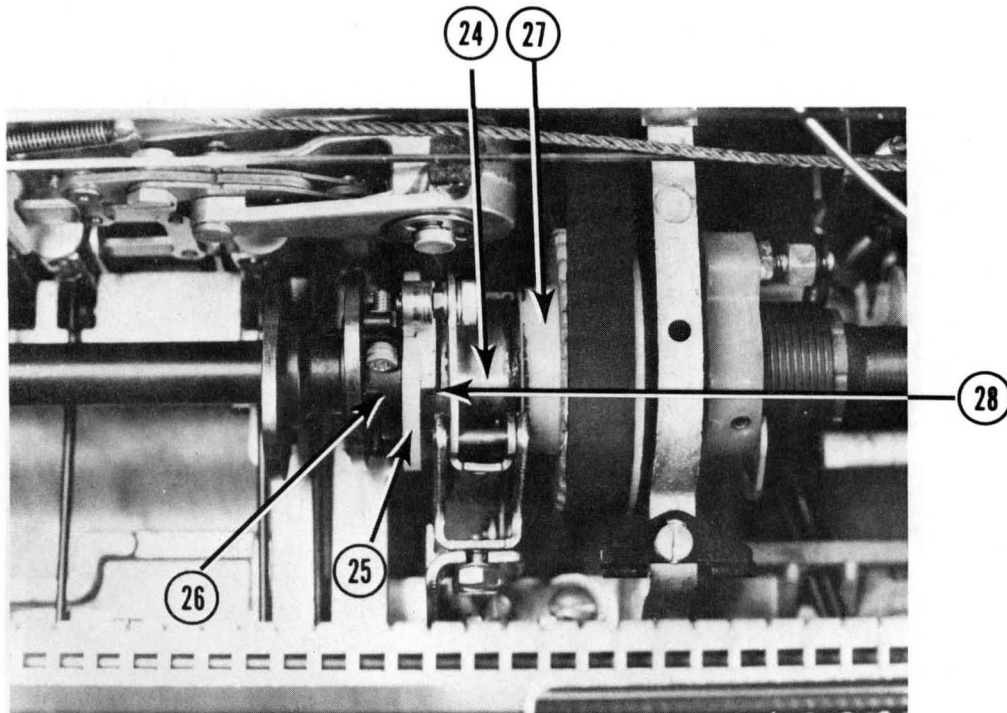

Figure 63

24. Cycle clutch sleeve 25. Overthrow stop and restoring cam
 26. Clamp 27. Cycle clutch pulley & hub 28. Clearance between
 overthrow stop and sleeve.

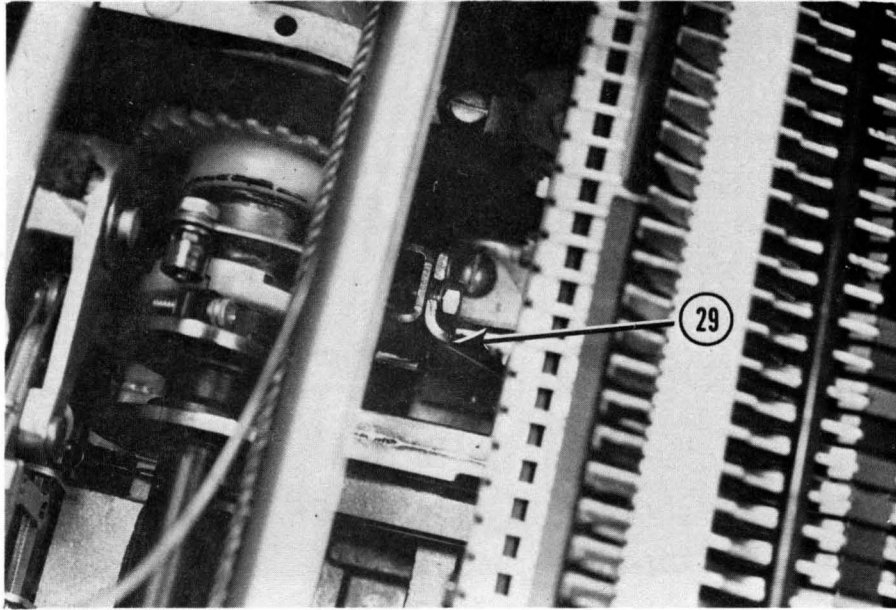

Figure 64.

29. Cycle clutch latch bracket

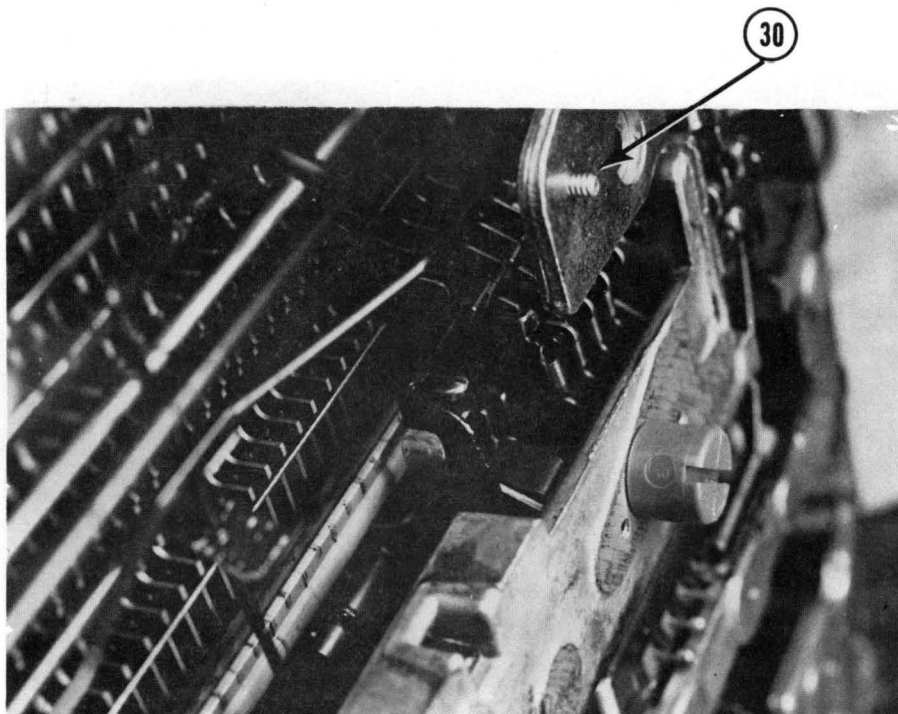

Figure 65

30. Adjustable foot brackets

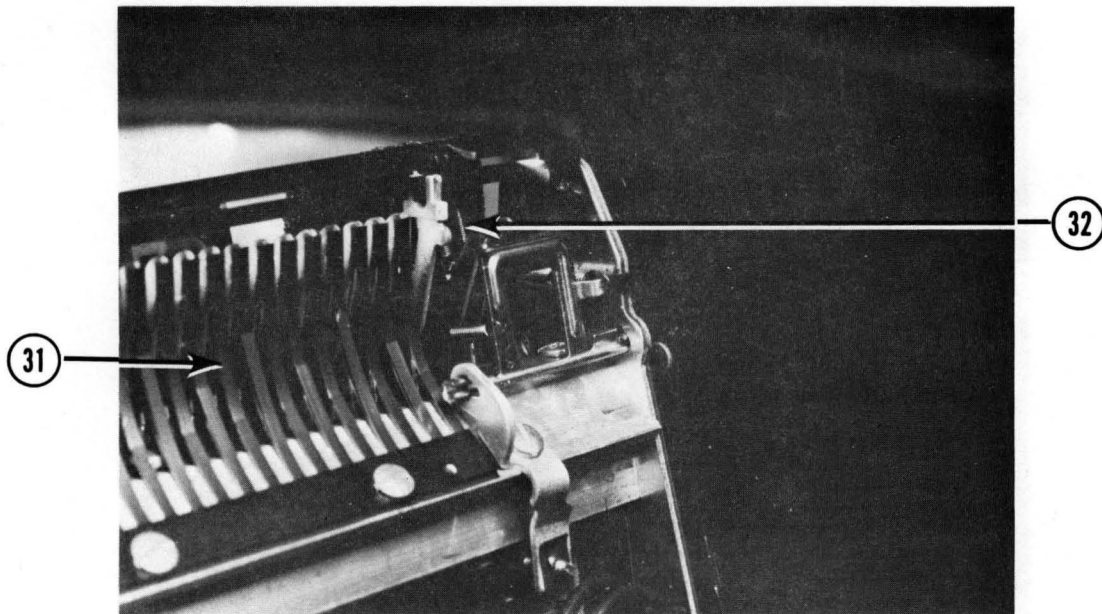

Figure 66

31. Keylever restoring springs 32. Carrier return restoring spring

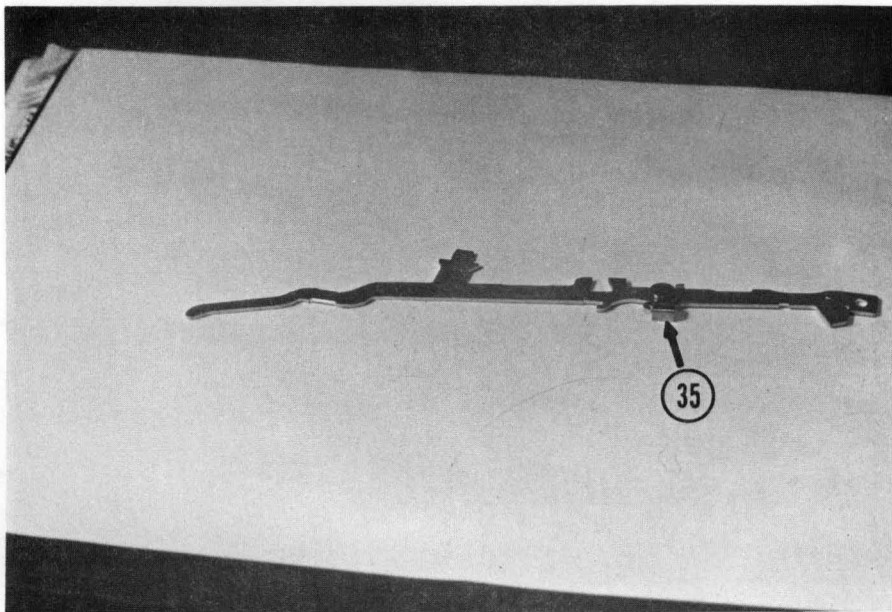

Figure 67

35. Keylever pawl

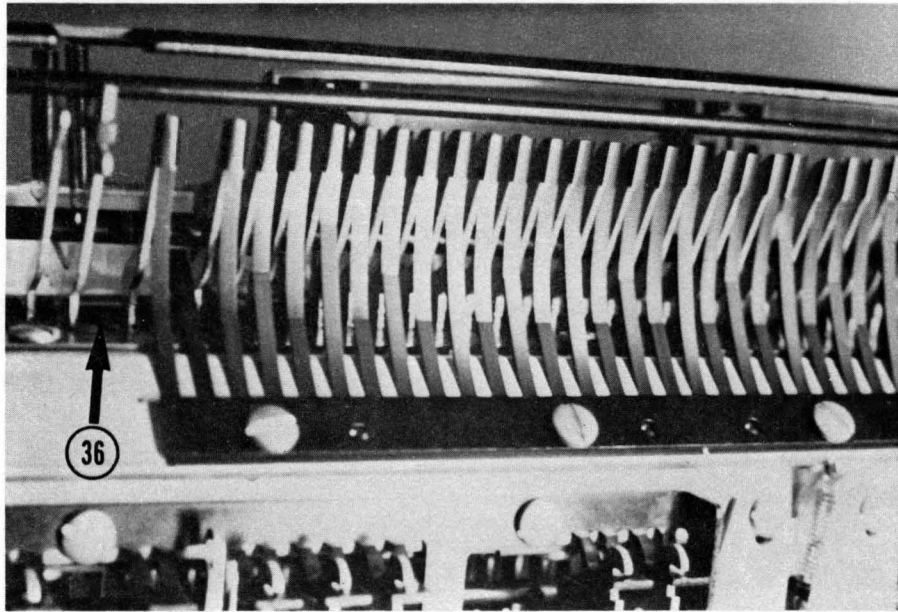

Figure 68

36. Front keylever guide comb.

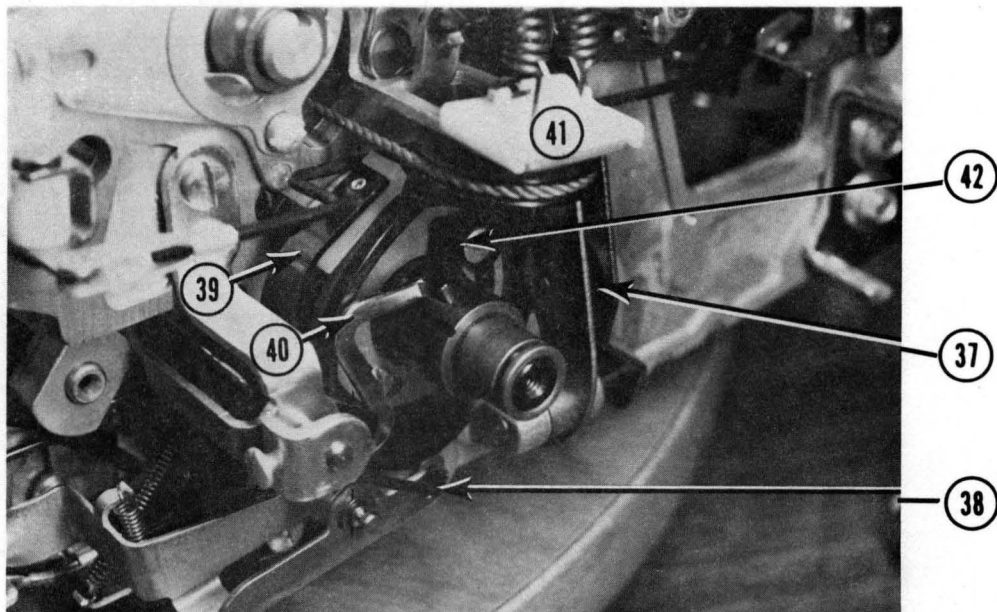

Figure 69

37. Roller on shift arm 38. Shift interlock 39. Shift brake
 40. Shift release lever 41. Cord tension pulley 42. Overthrow stop

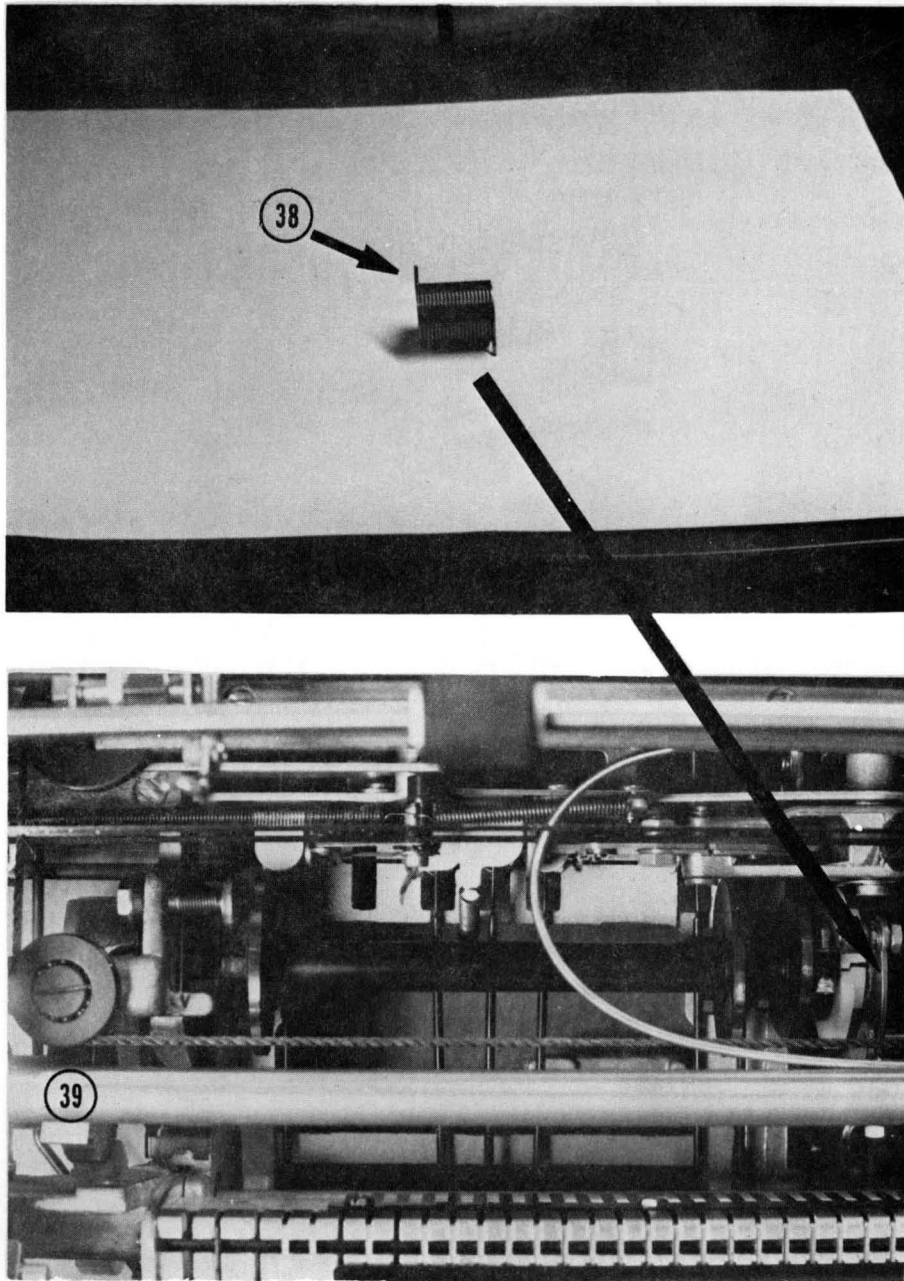

Figure 70

38. Cycle clutch spring 39. Print shaft 40. Velocity cable

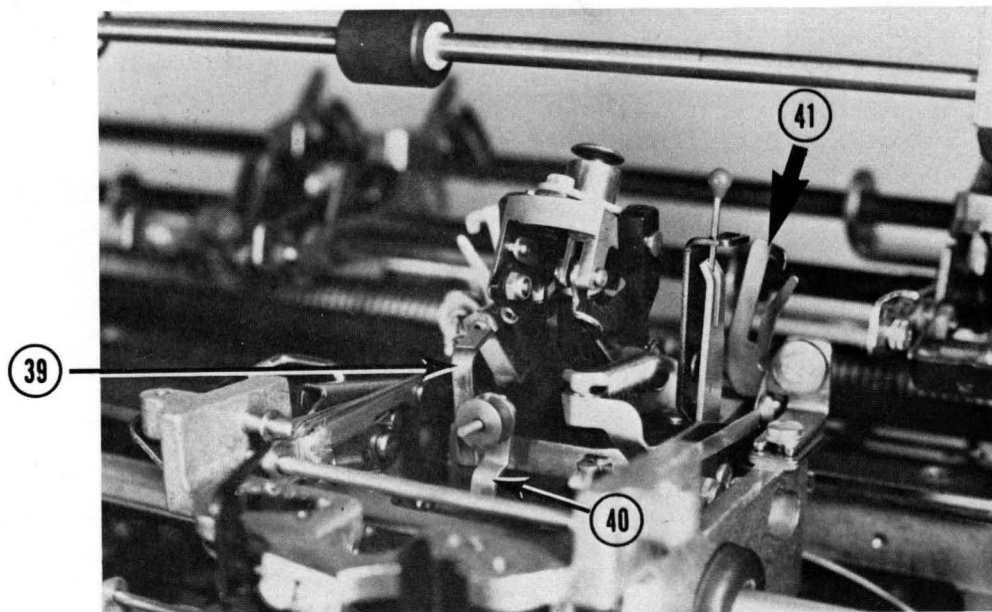

Figure 71

39. Detent actuating lever 40. Detent cam follower 41. Ribbon lift guides

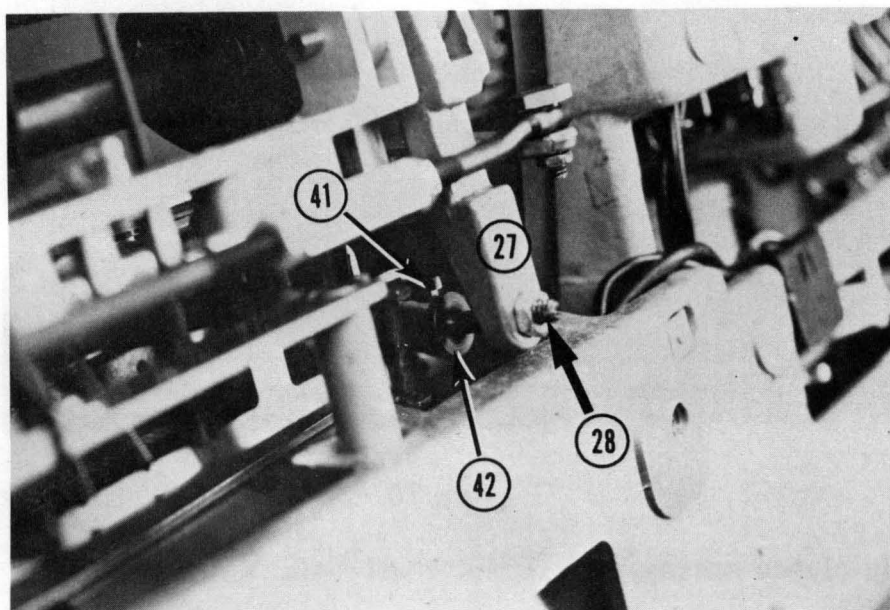

Figure 72

41. Negative 5 latch 42. Bail stop screw 27. Negative bail
28. Negative 5 bail adjusting screw

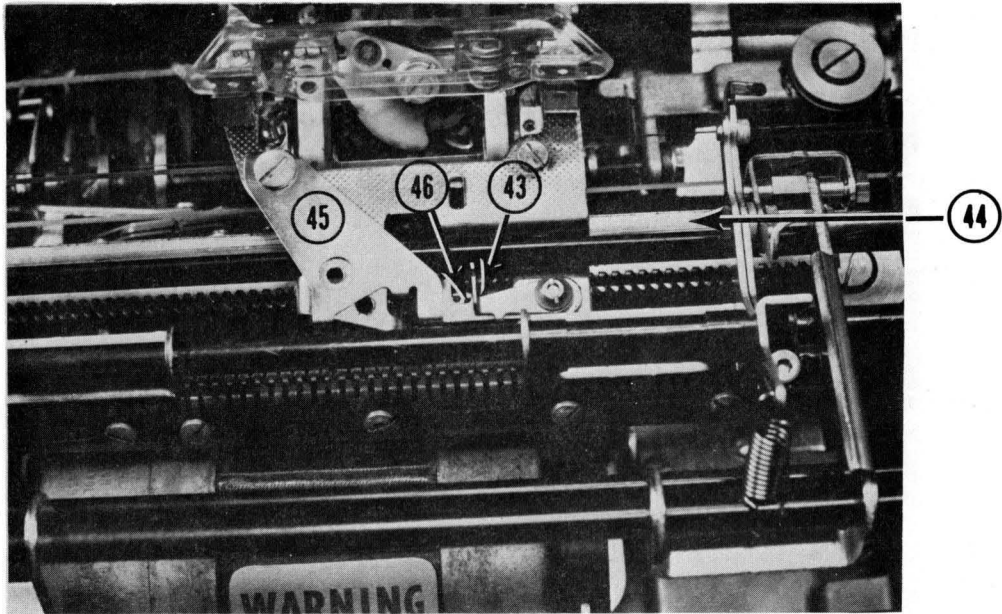

Figure 73

43. Escapement pawl 44. Escapement rack 46. Backspace pawl
45. Tab gang clear bracket

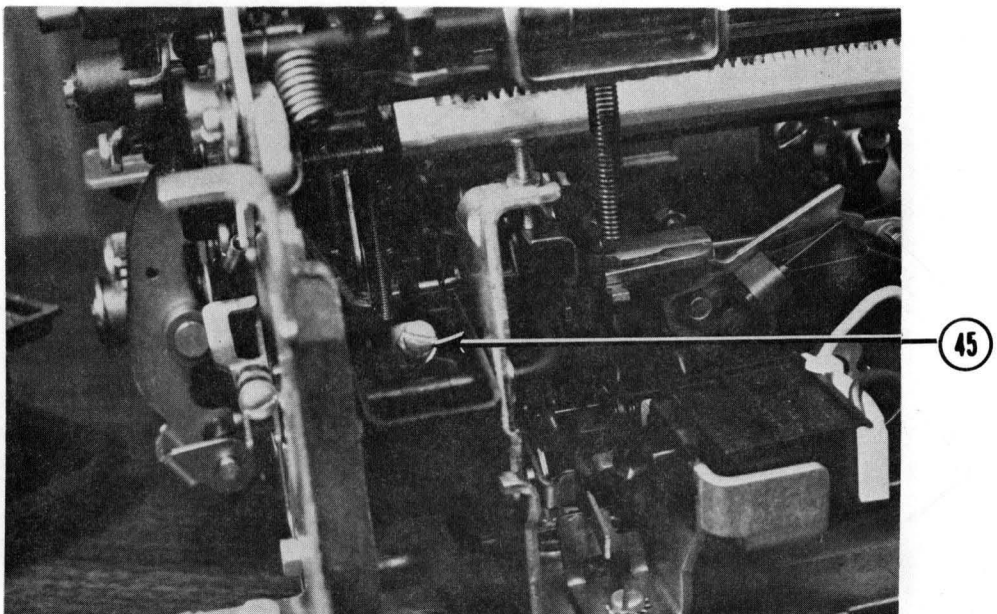

Figure 74

45. Trigger knockoff

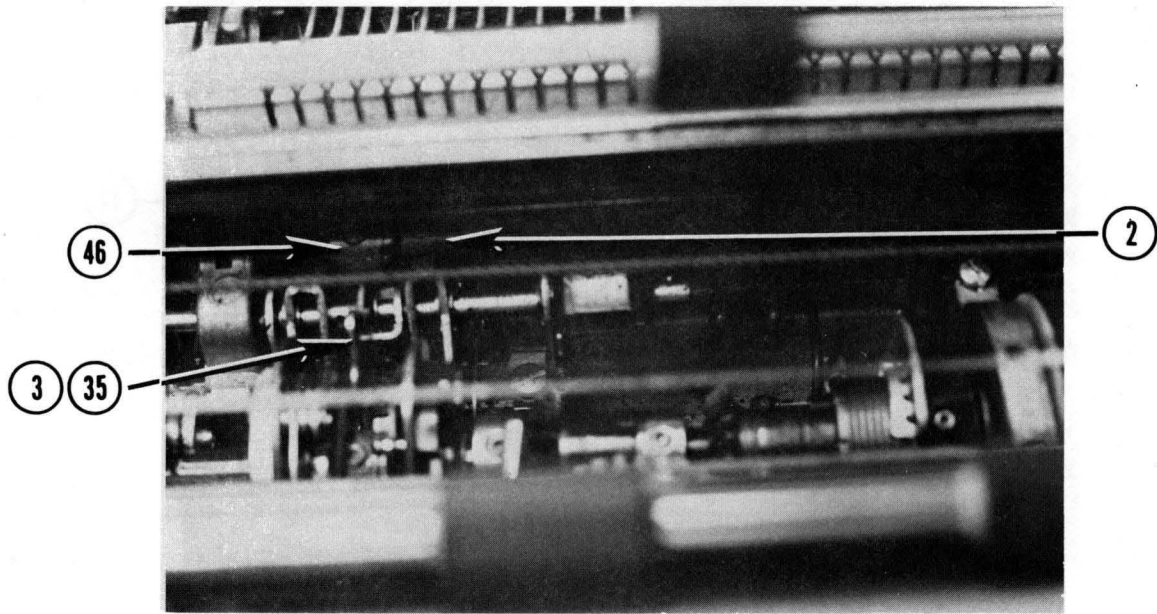

Figure 75

2. Spacebar interlock cam 3. Escapement cam follower 35. Escapement cam follower 46. Escapement cam

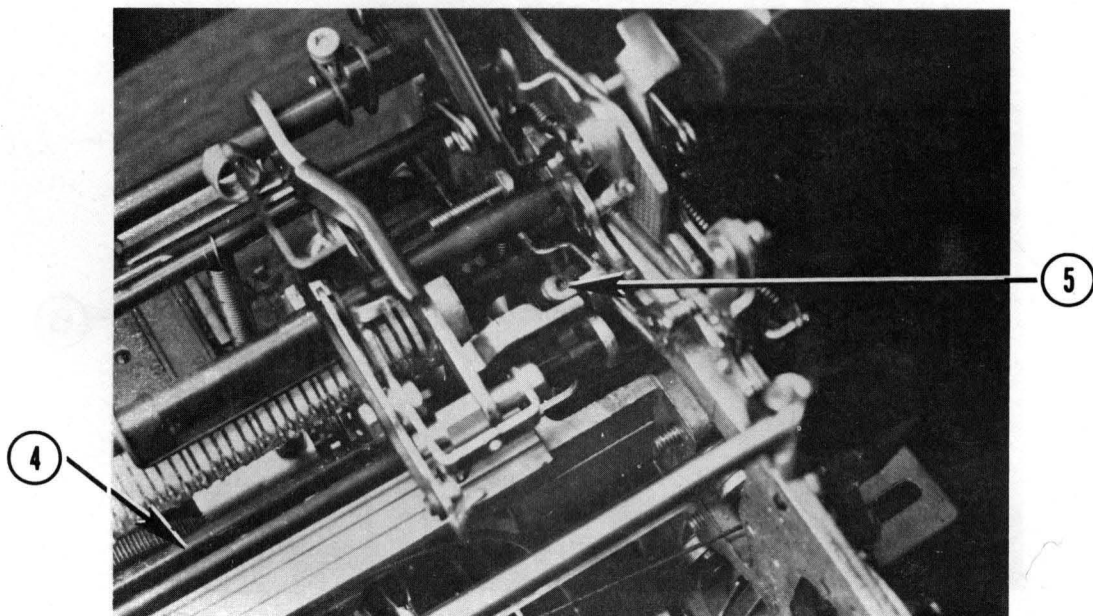

Figure 76

4. Escapement torque bar 5. Escapement torque bar upstop adjusting screw.

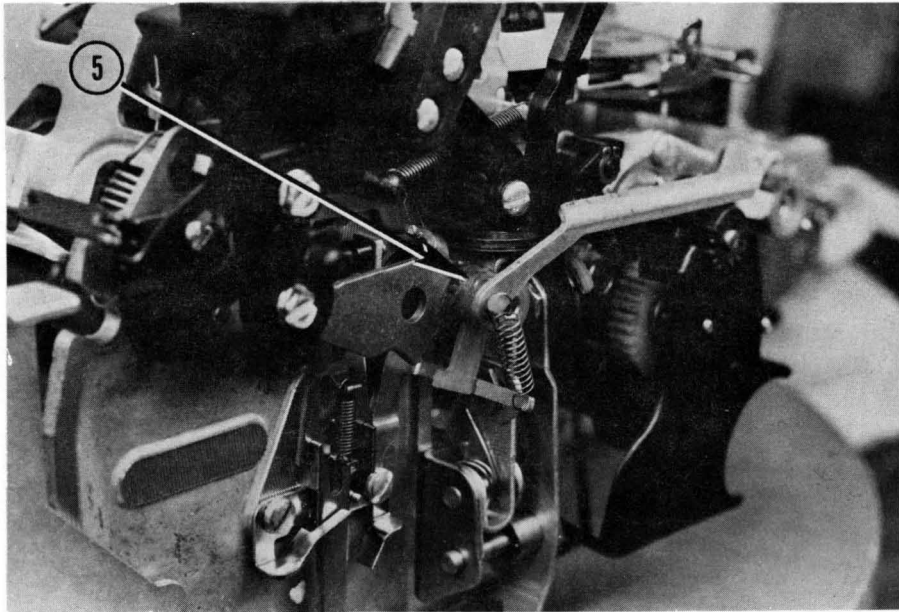

Figure 77

5. Escapement rack gear

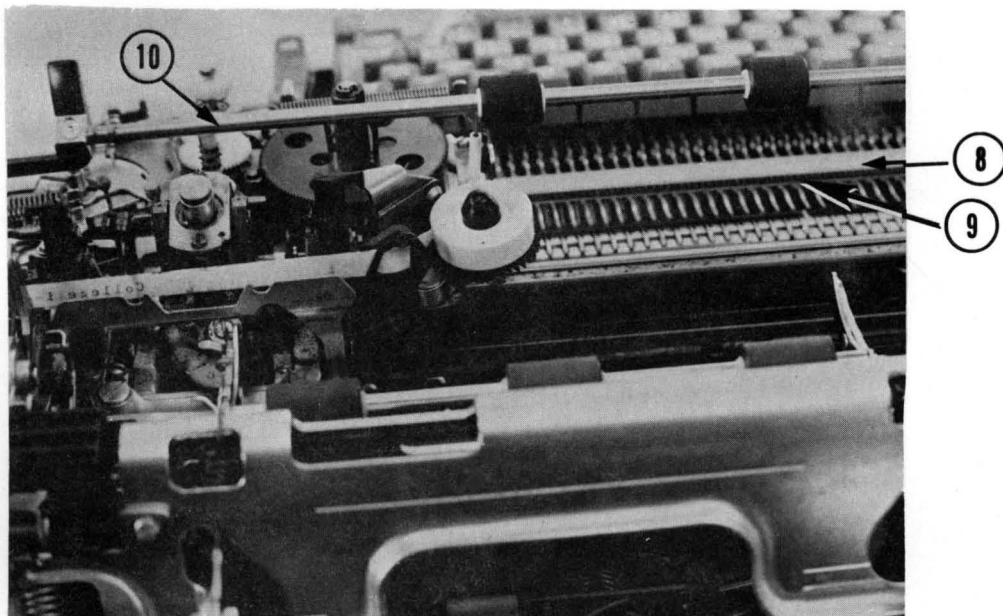

Figure 78

8. Margin rail 9. Margin rack 10. Paper bail

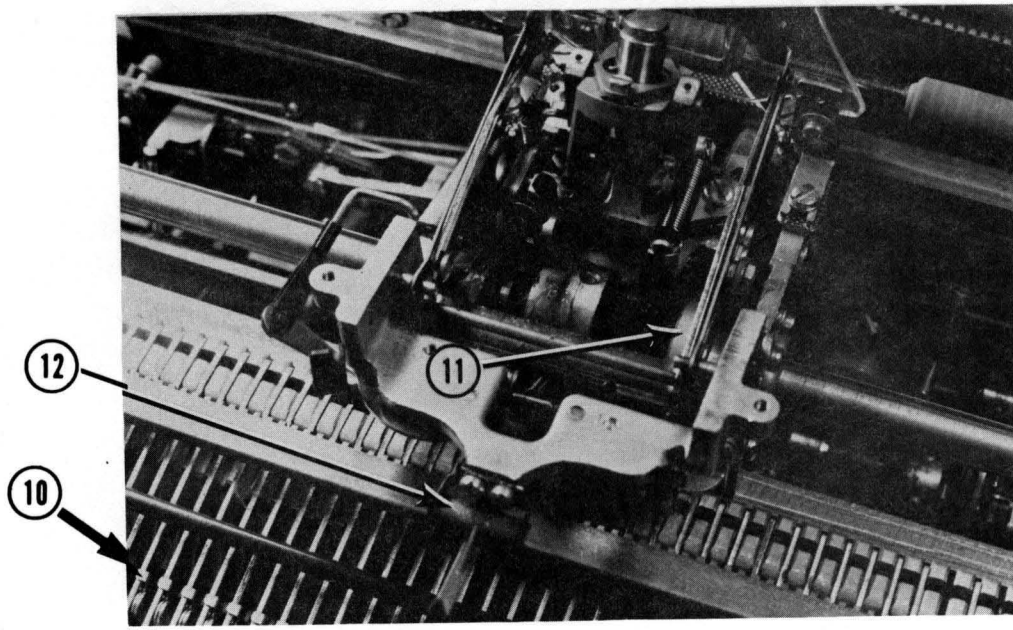

Figure 79

10. Keylever pawl 11. Print cam 12. indicator

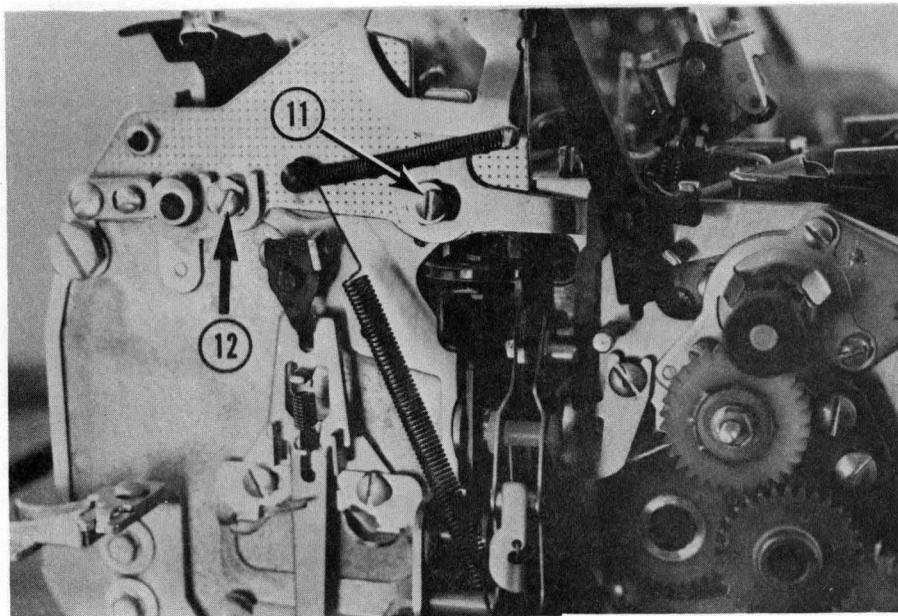

Figure 80

11. Platen height adjusting screw 12. Platen back and forth adjusting screw. Use platen gage for adjustment.

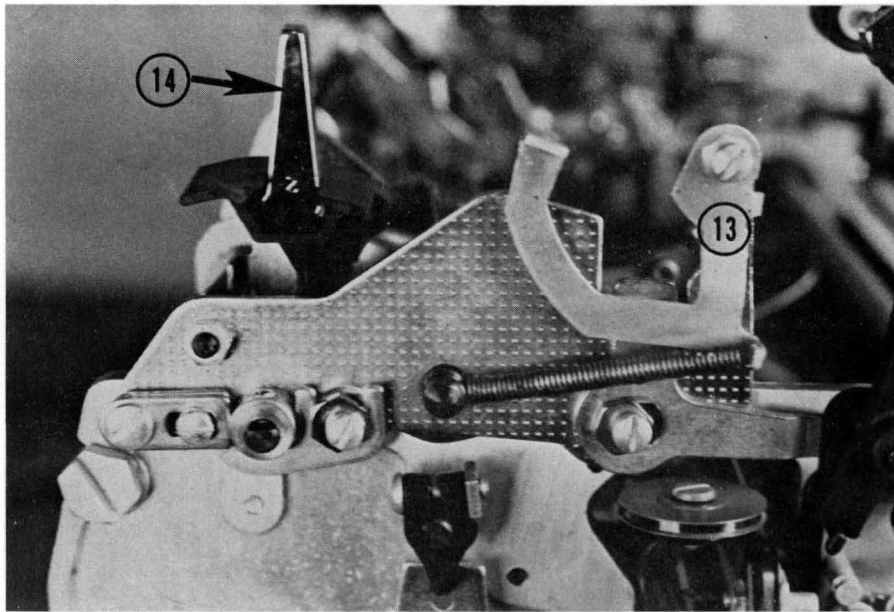

Figure 81

13. Platen latches 14. Multiple copy control lever

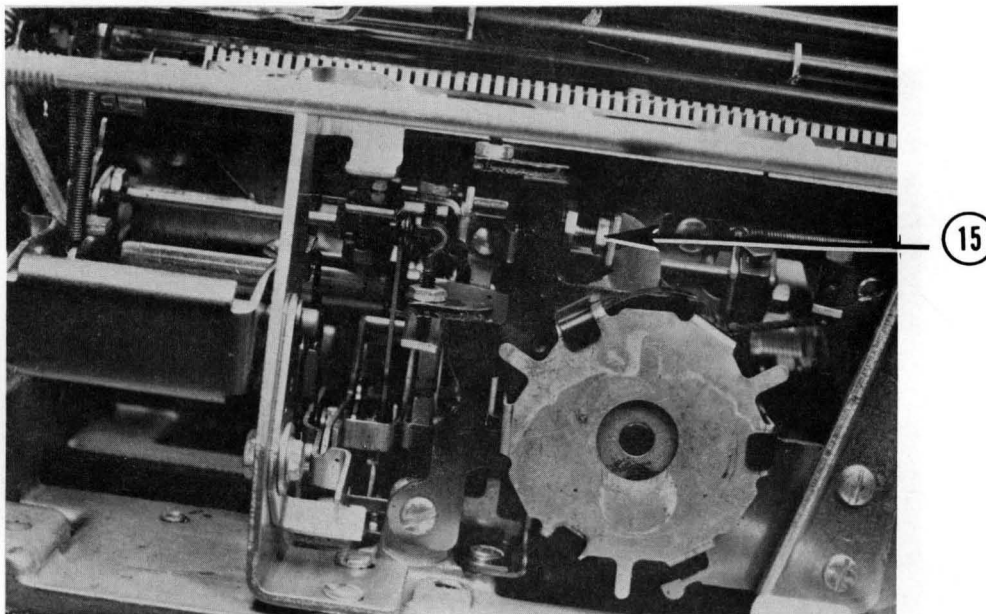

Figure 82

15. Backspace bellcrank screw

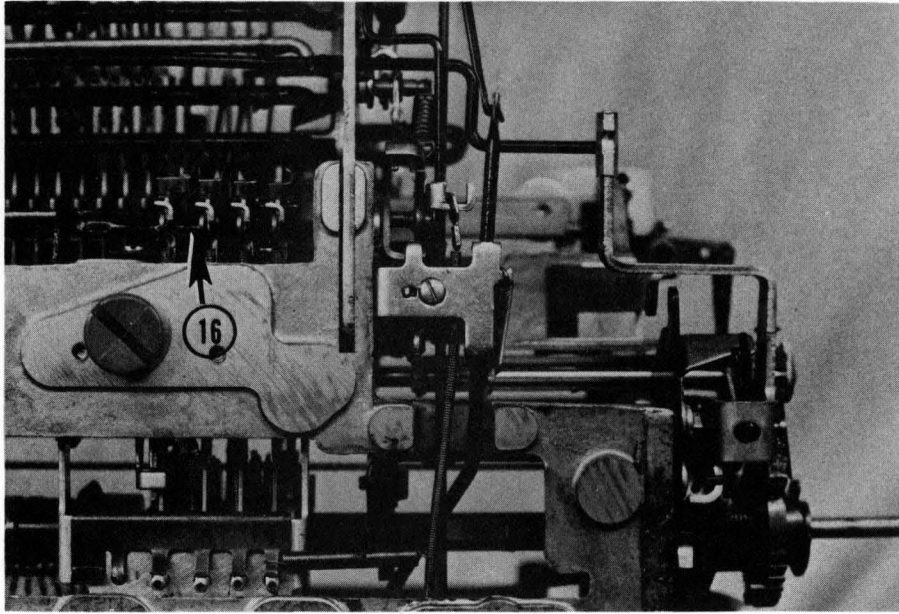

Figure 83

16. Express backspace keylever latch

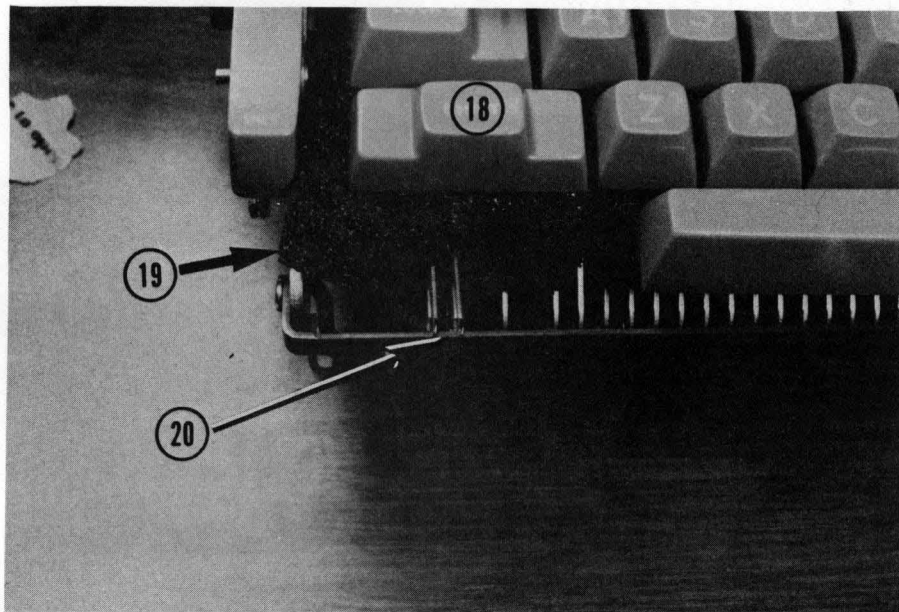

Figure 84

18. Shift key 19. Keyboard dust catcher or insulation 20. Shift keylever restoring spring.

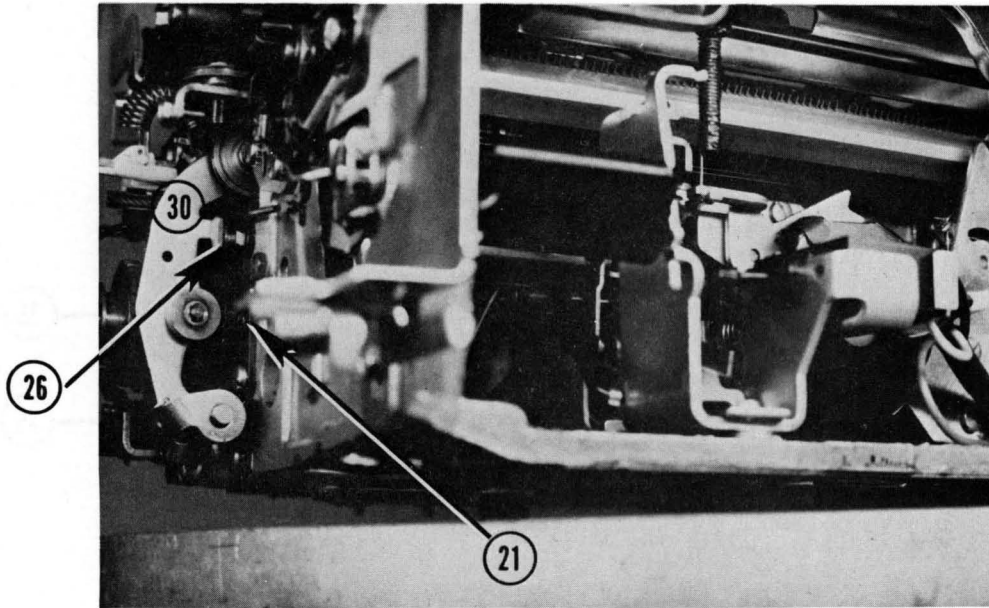

Figure 85

21. Shift cam backup roller or stud 26. Adjustment stop screw for lower case rotate alignment 30. Shift arm

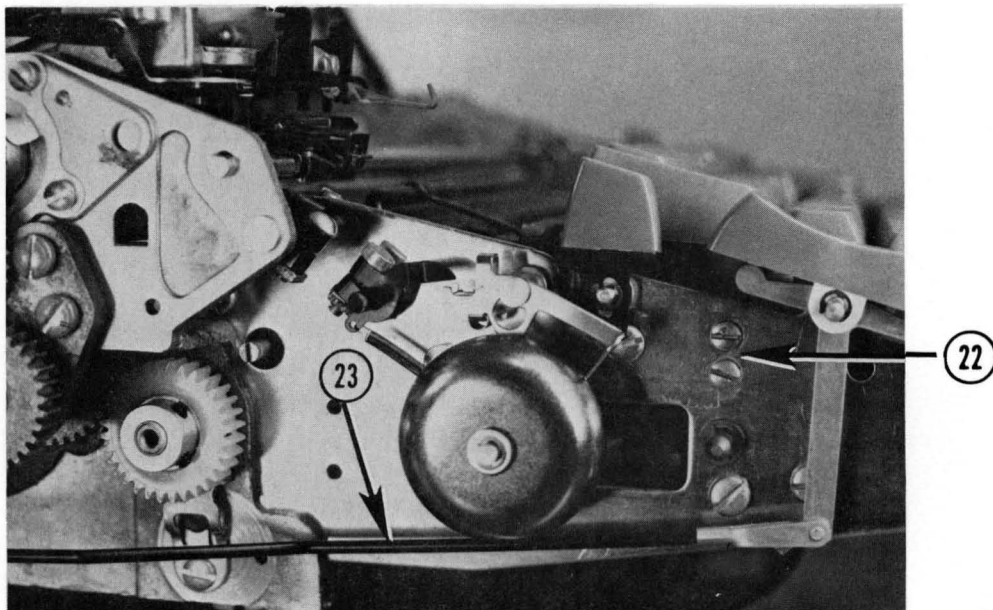

Figure 86

22. Shift latch plate adjusting screws 23. Tab set/clear link

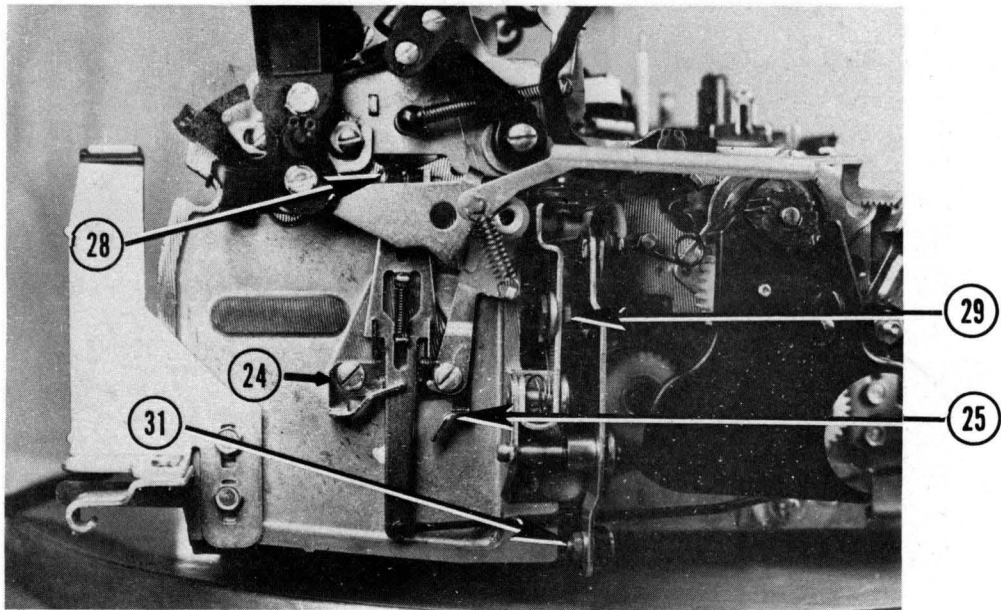

Figure 87

24. Tab set/clear bracket 25. Tab set and clear adjustable limits
28. Tab set/clear bellcrank 29. Tilt link and adjusting screw
31. Rotate arm adjusting screw.

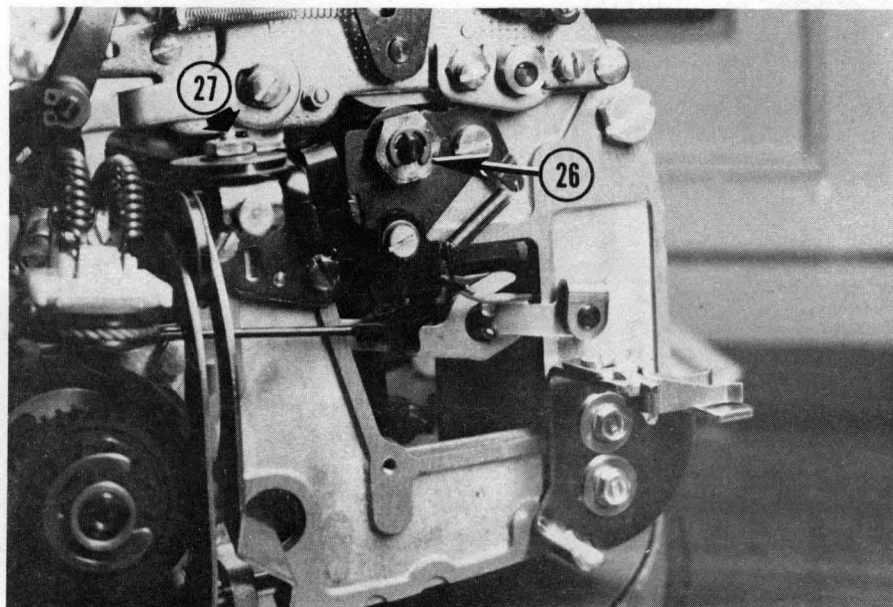

Figure 88

26. Tab rack adjusting nut 27. Adjustment pulley for tilt detenting

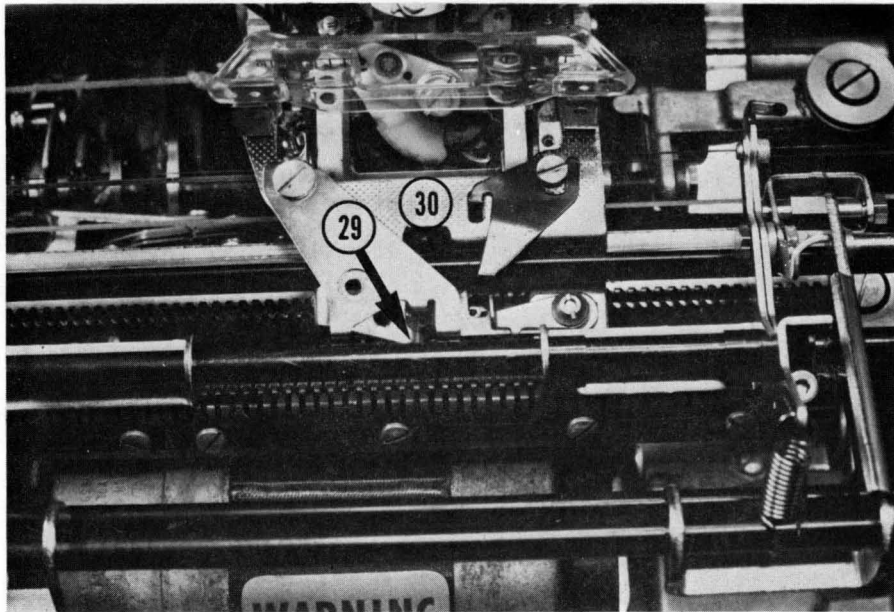

Figure 89

29. Escapement bracket extension 30. Escapement bracket

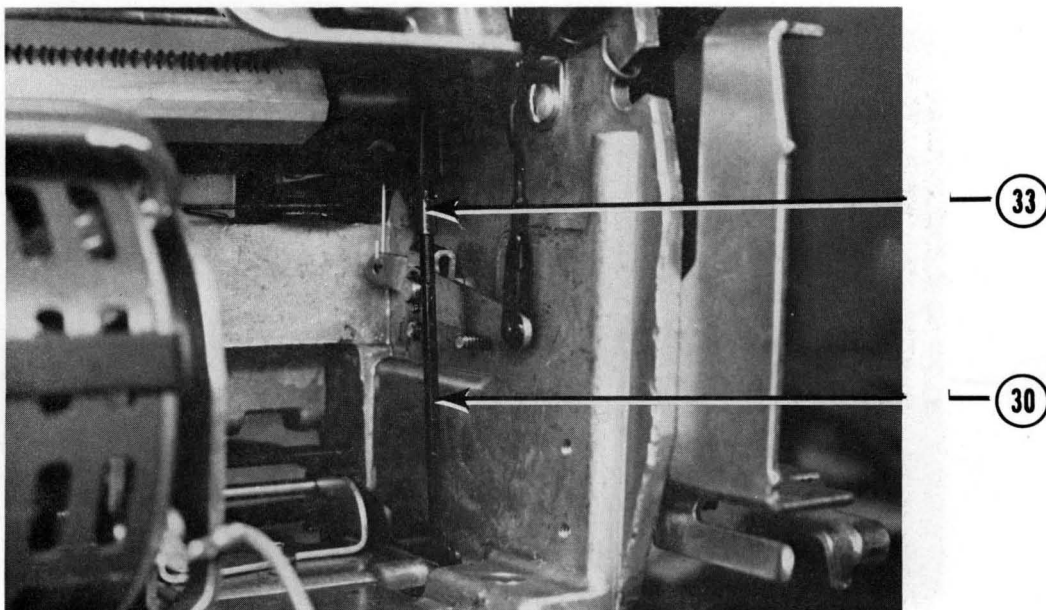

Figure 90

30. Tab torque bar link 33. Torque bar clevis

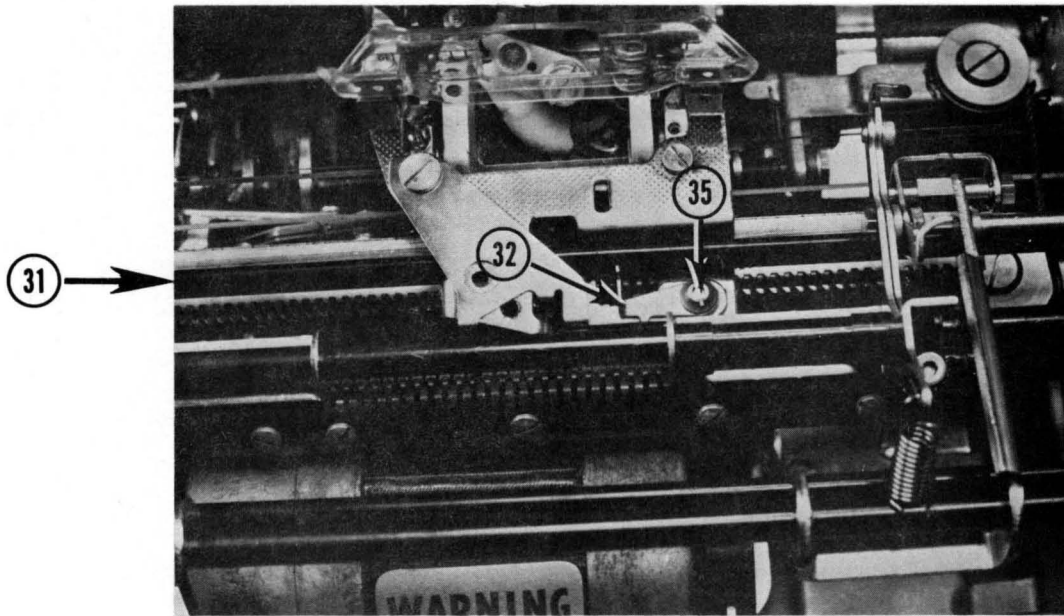

Figure 91

31. Tab torque bar 32. Tab trigger 35. Pawl mounting stud

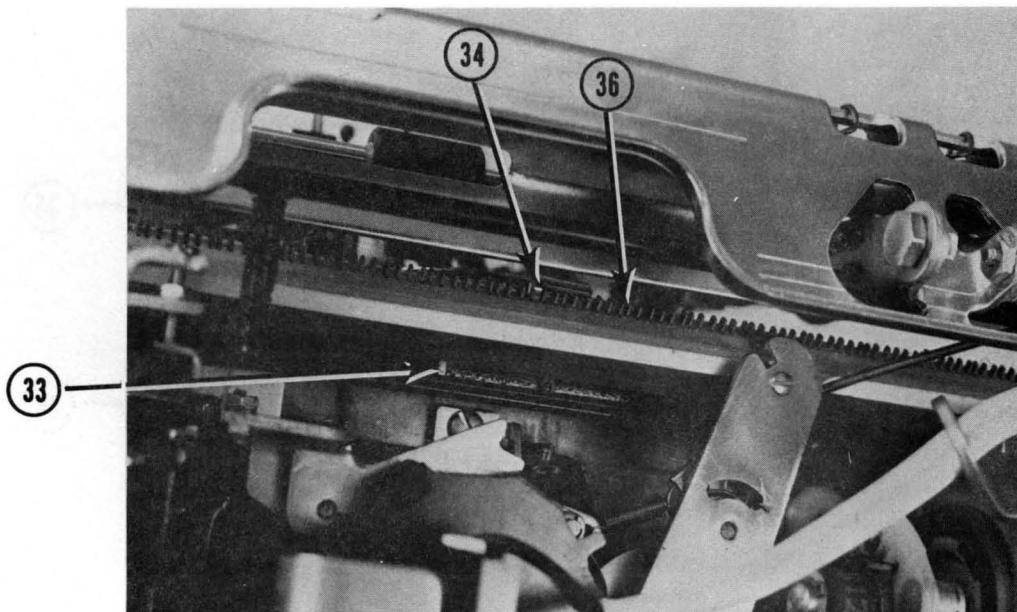

Figure 92

33. Tab lever latch 34. Selectric II tab set bracket 36. Two closer tab stops

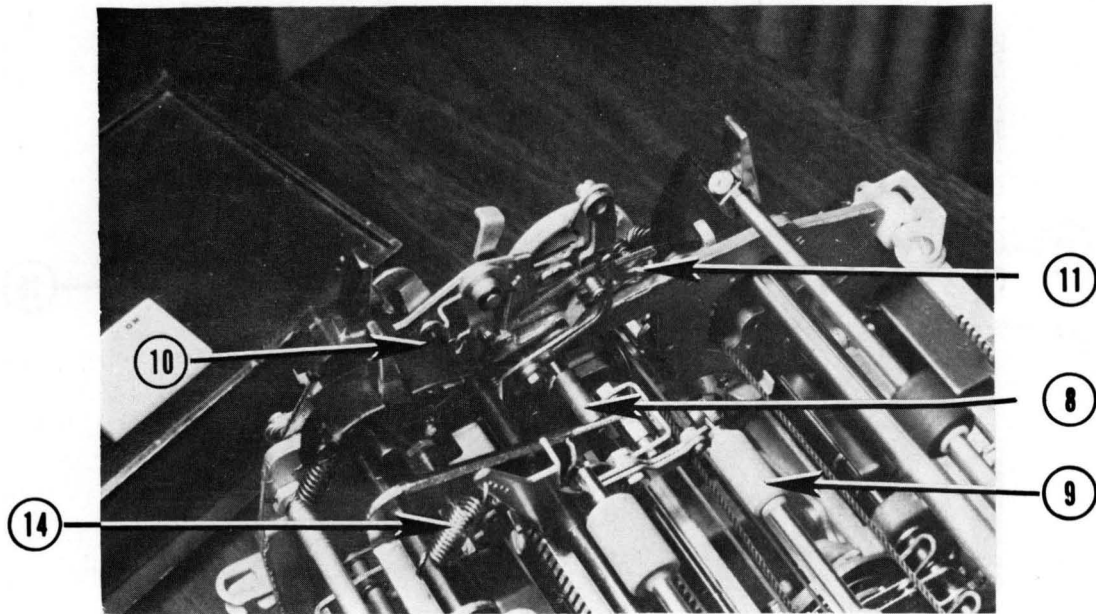

Figure 93

8. Positioning stud 9. Feed rollers 10. Index link 11. Overthrow stop
 14. Feed roll tension adjusting springs

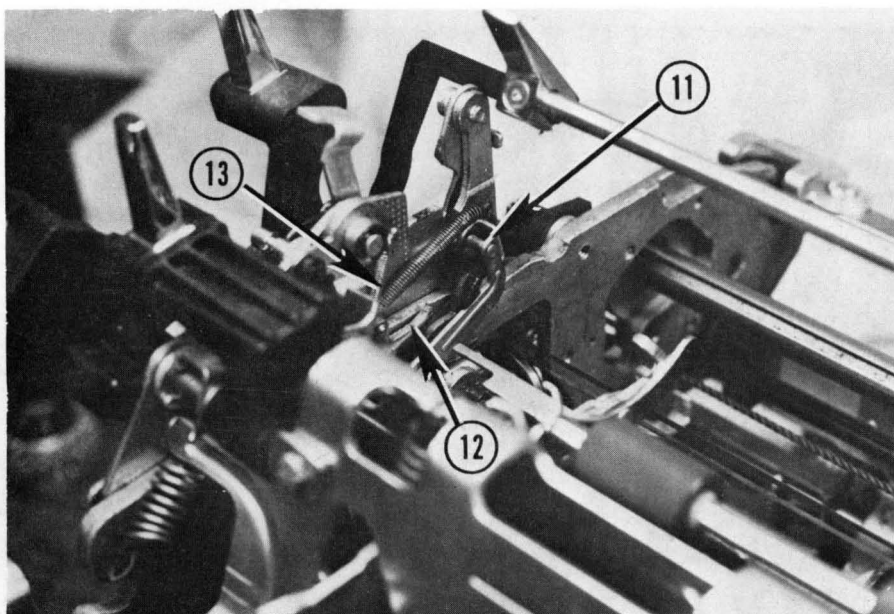

Figure 94

11. Index detent 12. Index pawl 13. Index pawl springs

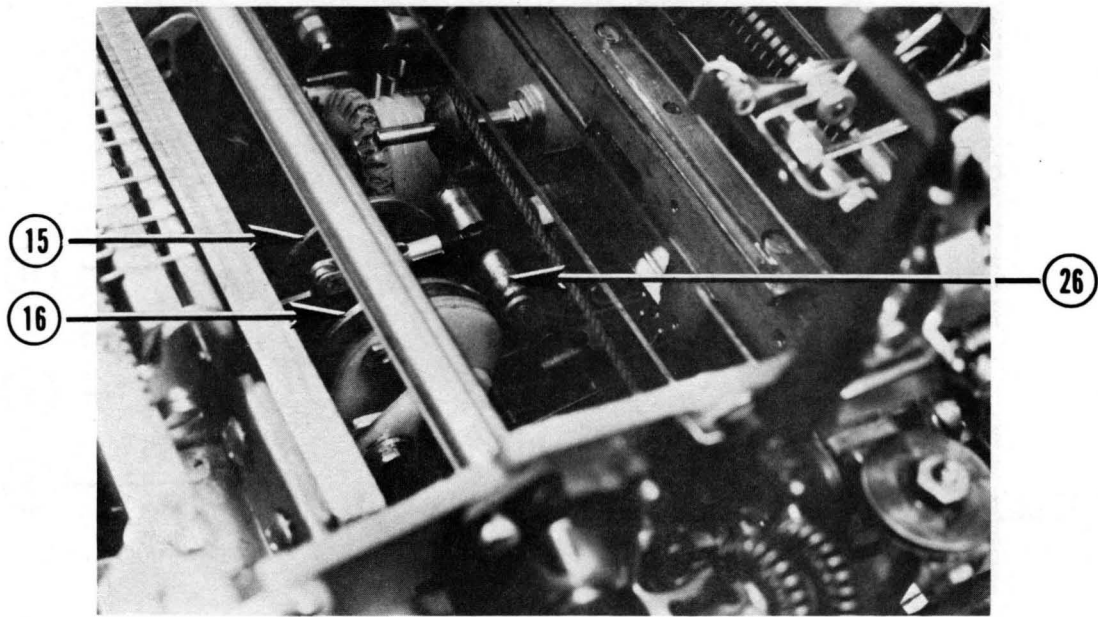

Figure 95

15. Spacebar/backspace cam 16. Carrier return/index cam
 26. Carrier return cam follower

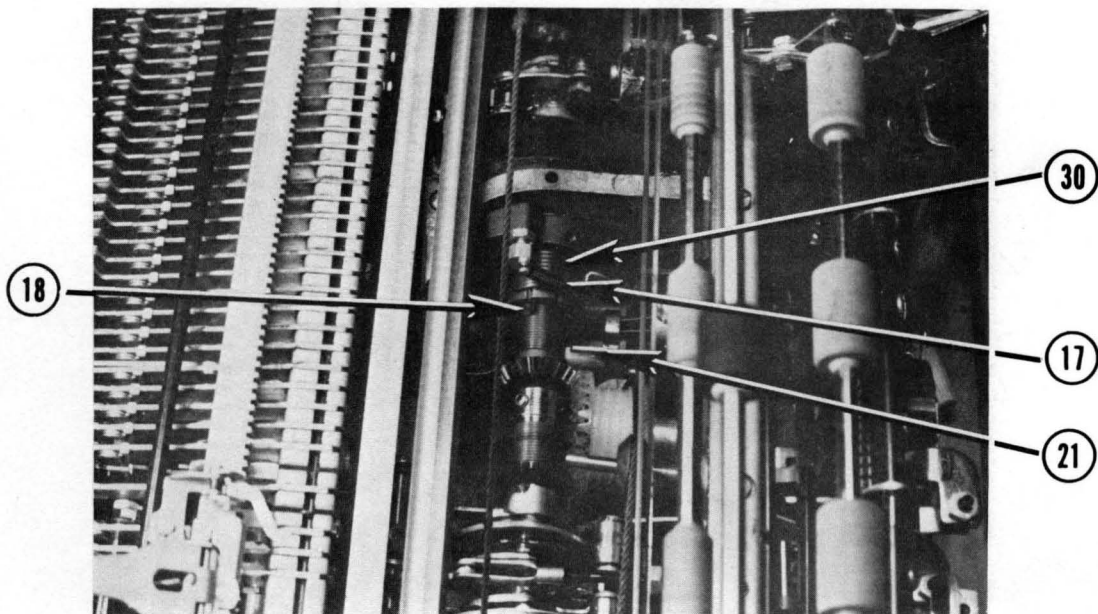

Figure 96

17. Extension springs 18. Spring clip 21. Actuating arm 30. Torque limiter spring

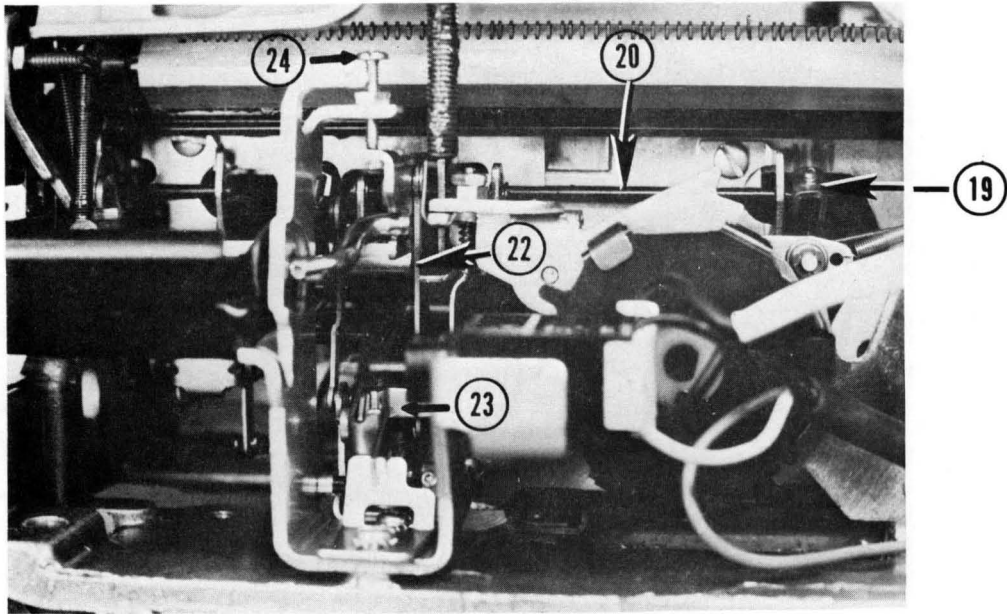

Figure 97

19. Clutch arm & screw 20. Pivot pin 22. Carrier return latch
23. Carrier return cam follower 24. Latch adjusting screw

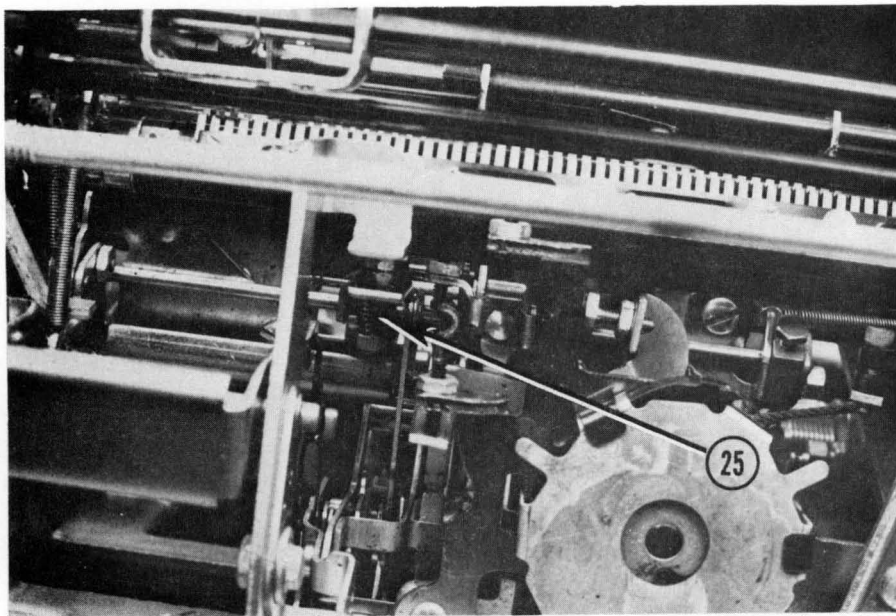

Figure 98

25. Carrier return lever screw

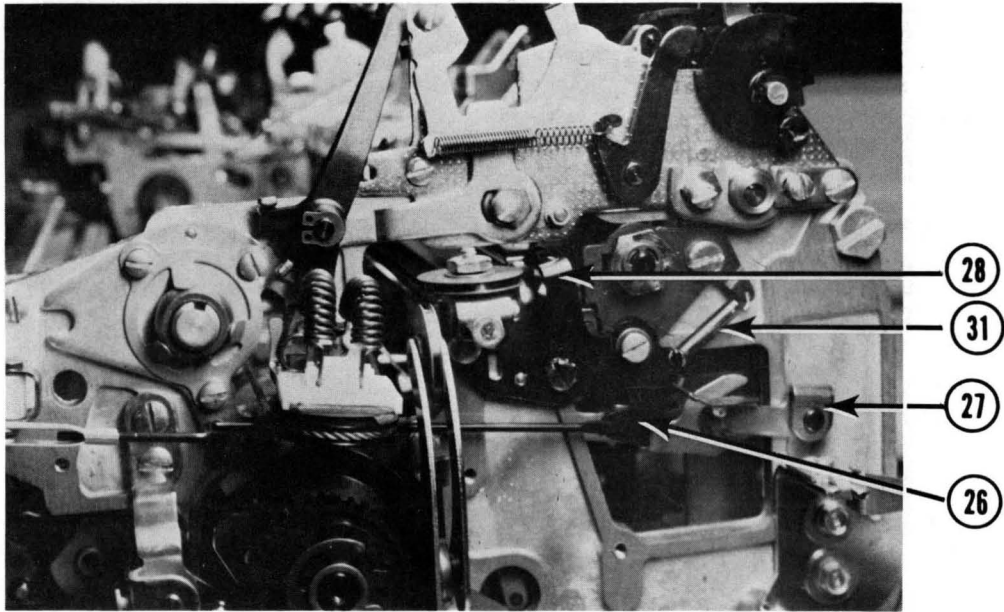

Figure 99

26. Carrier return latch keeper 27. Carrier return latch
28. Tab interlock 31. Latch keeper spring

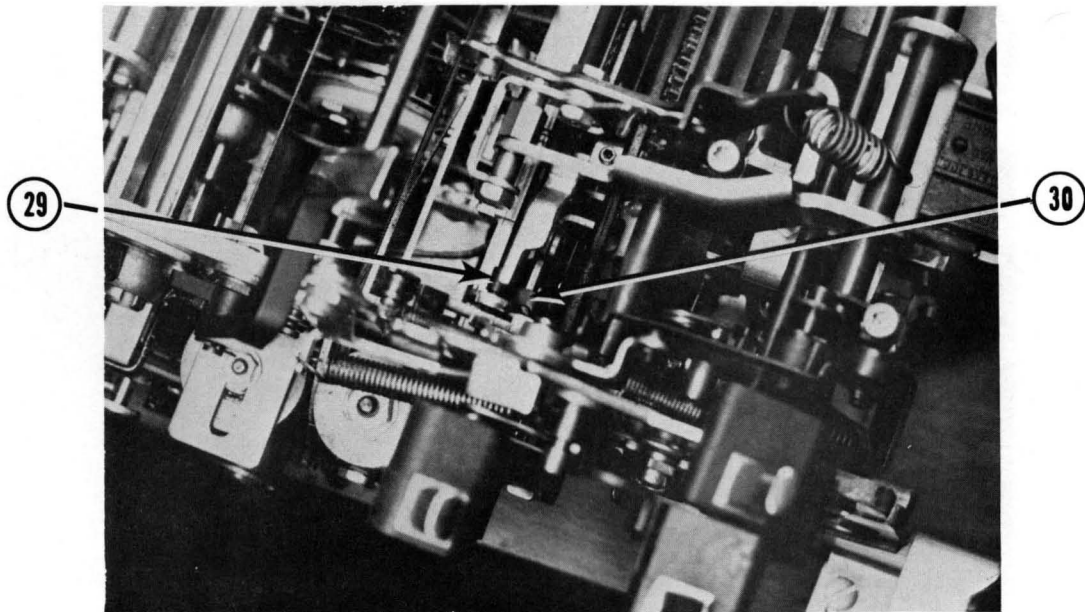

Figure 100

29. Clip interlock 30. Tab interlock

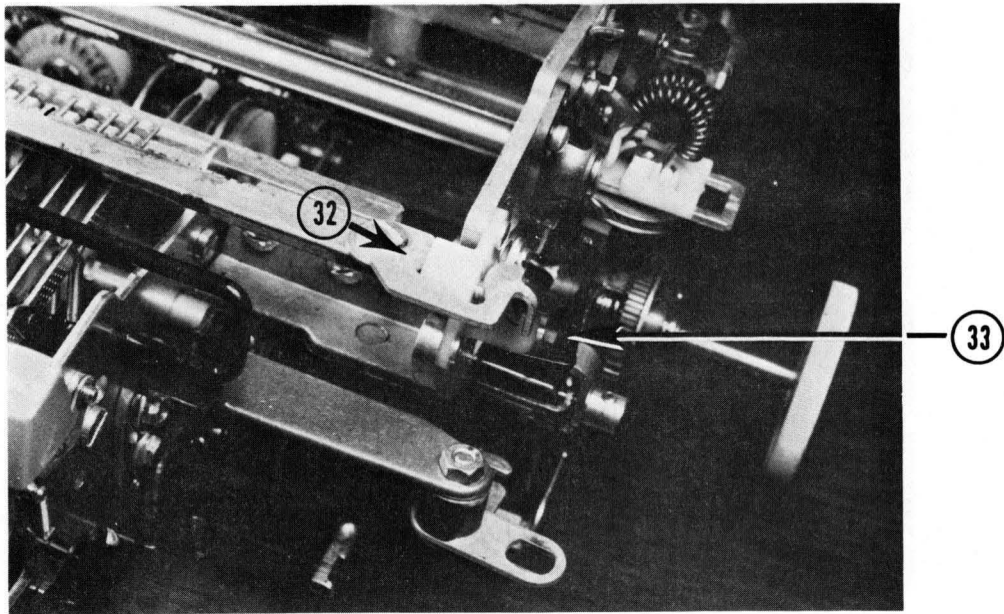

Figure 101

32. Overbank guide 33. Latch link

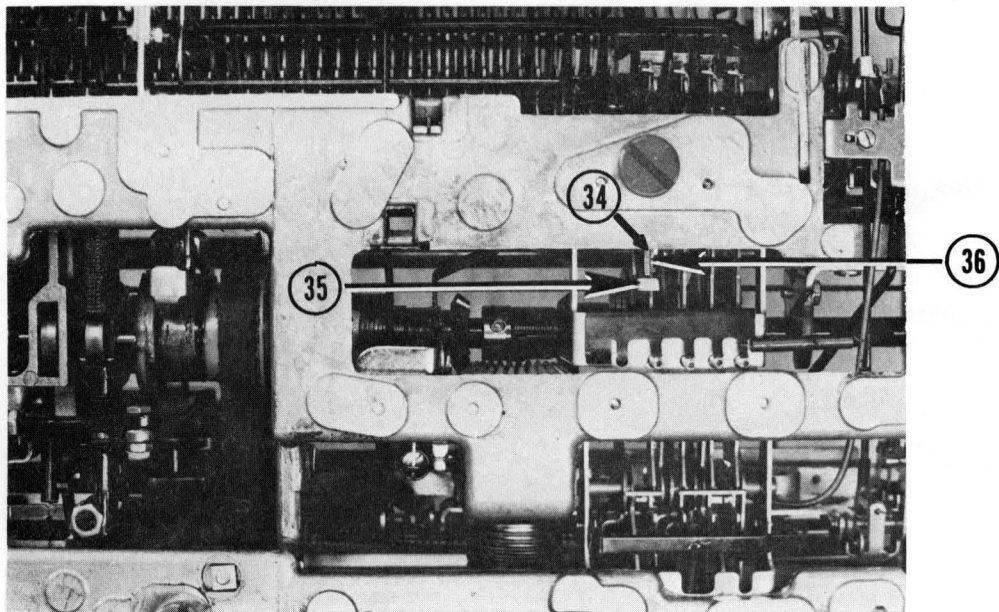

Figure 102

34. Spacebar interlock bracket 35. Point A 36. Point B

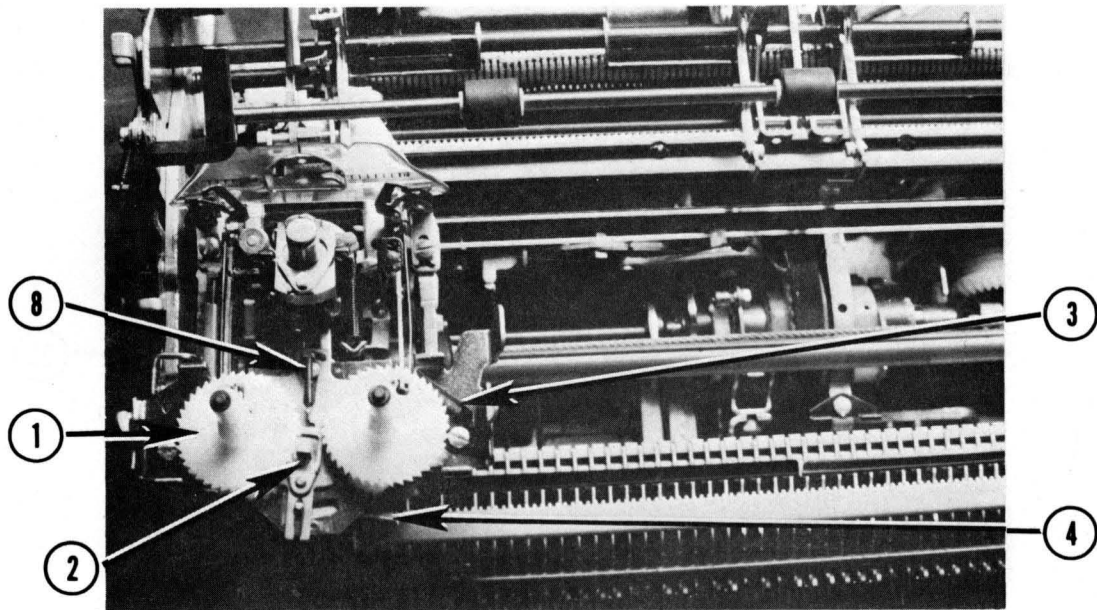

Figure 103 New style

1. Ribbon spools 2. Ribbon feed pawl 3. Brake tension spring
4. Detent and spring 8. Feed pawl spring

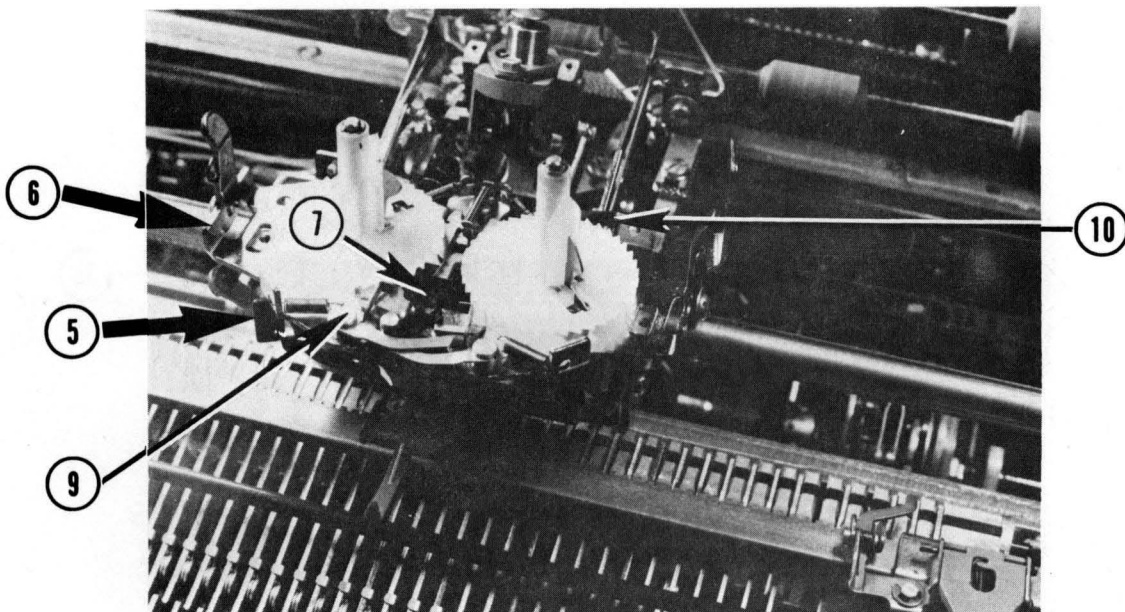

Figure 104 Old style

5. Stencil lever 6. Ribbon plate 7. Feed pawl spring 9. Detent spring
and detent 10. Ribbon spool detents

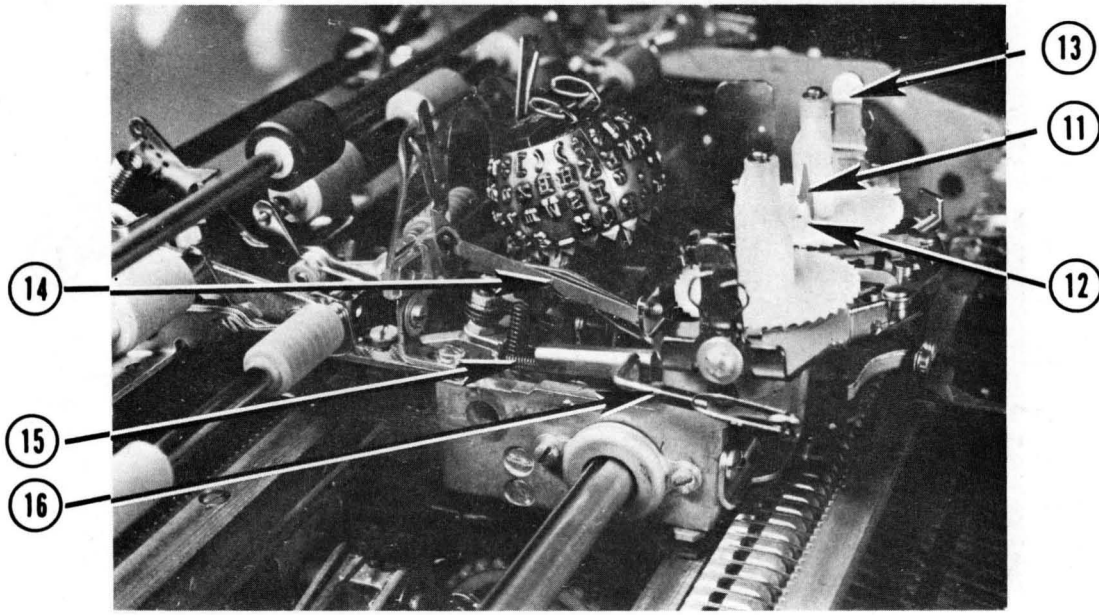

Figure 105

11. Reversing trigger 12. Reverse trigger spring 13. Ribbon guides
 14. Flat links 15. Ribbon lift control spring 16. Ribbon lift control link

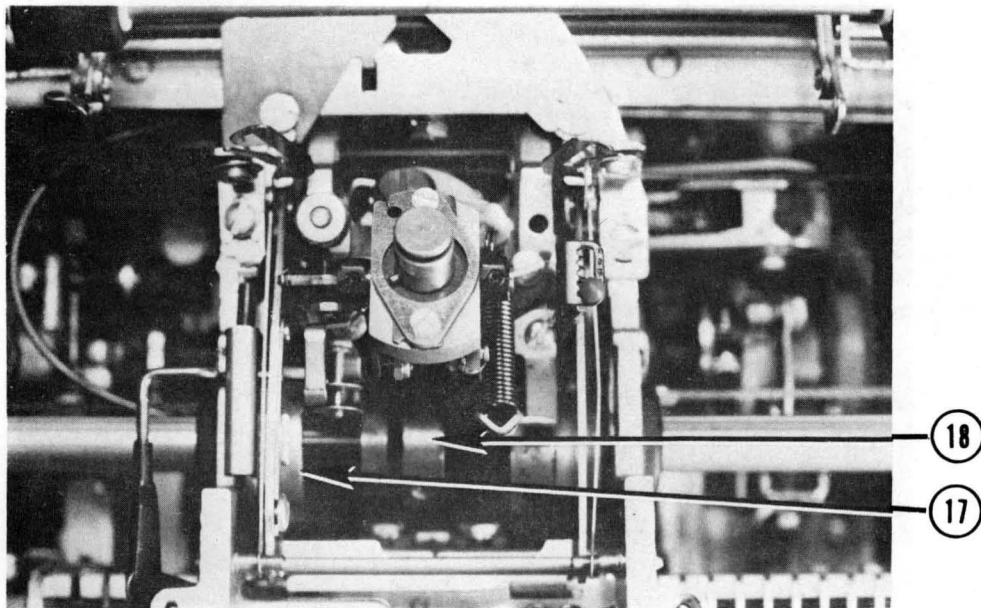

Figure 106

17. Ribbon lift cam 18. Ribbon feed and detent cam

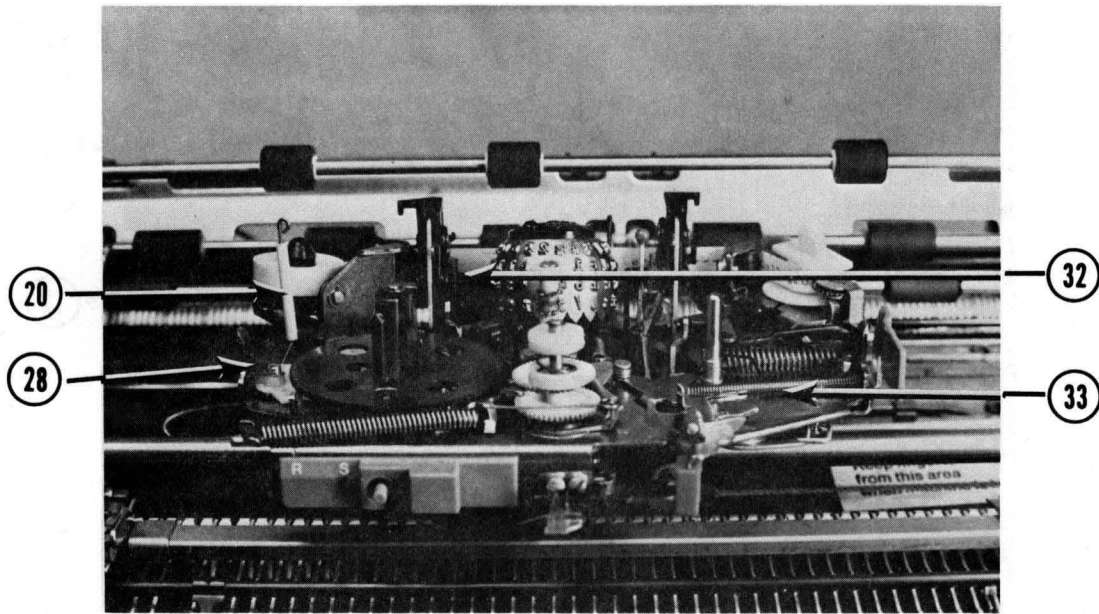

Figure 107

20. Shock wire & sleeve, detent 28. Cartridge guides & retaining clips
 32. Bias springs 33. Load lever spring

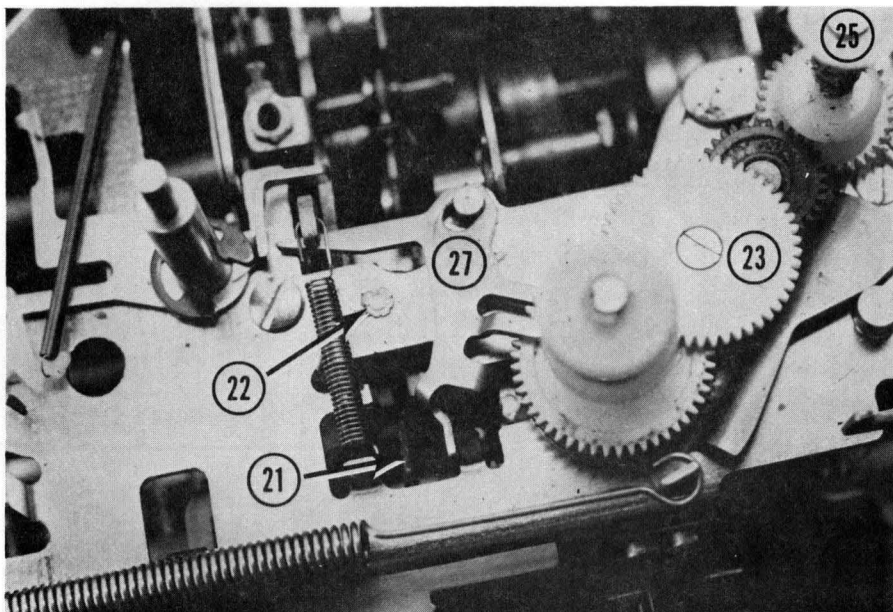

Figure 108

21. Ribbon lift lever 22. Lift control mounting post 23. Feed gears
 25. Spiked driver 27. Wobbler bellcrank

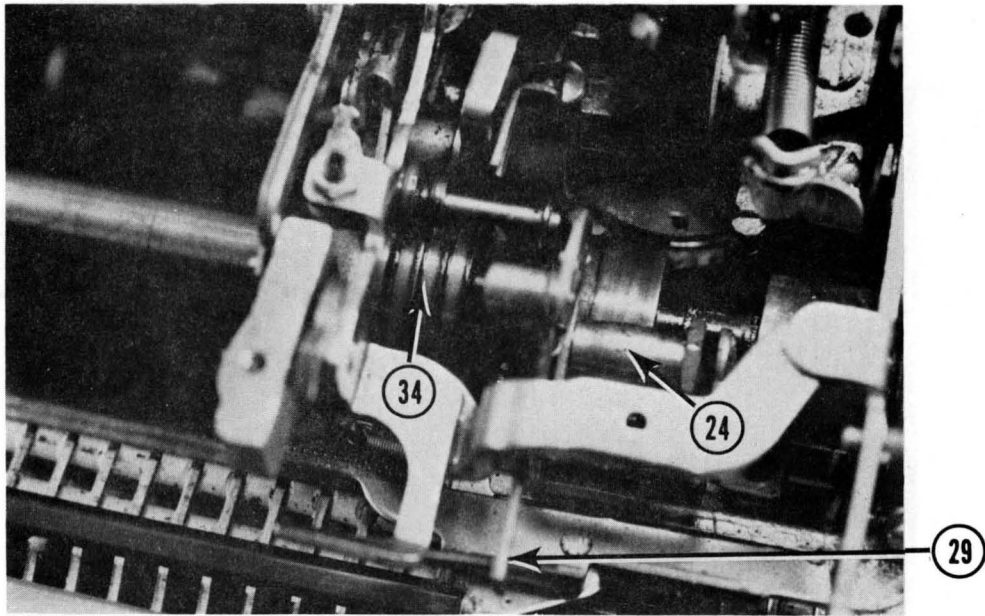

Figure 109

24. Ribbon feed eccentric cam 29. Ribbon feed pawl 34. Ribbon lift cam

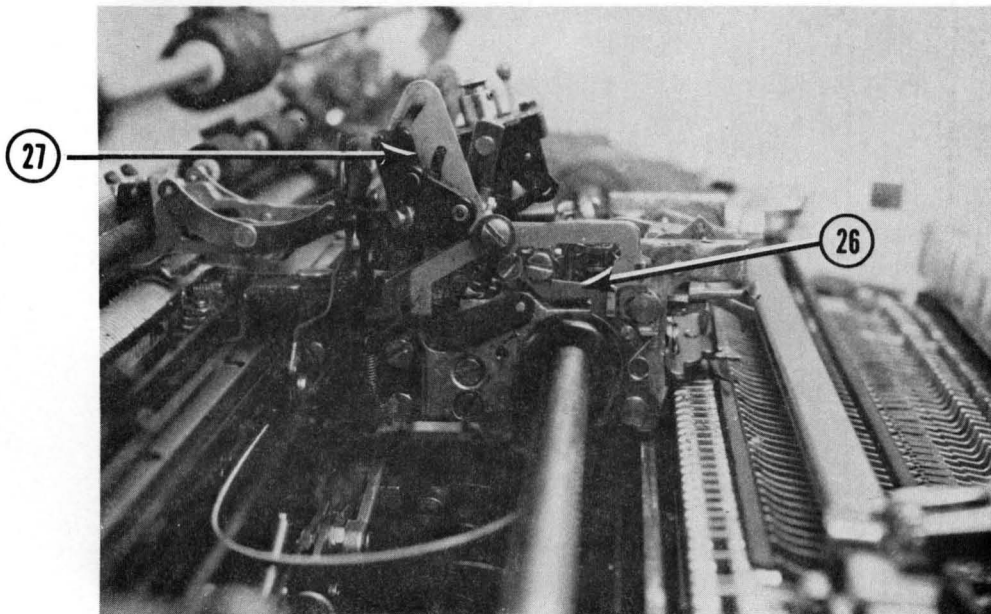

Figure 110

26. Spread adjusting plate 27. Ribbon guide

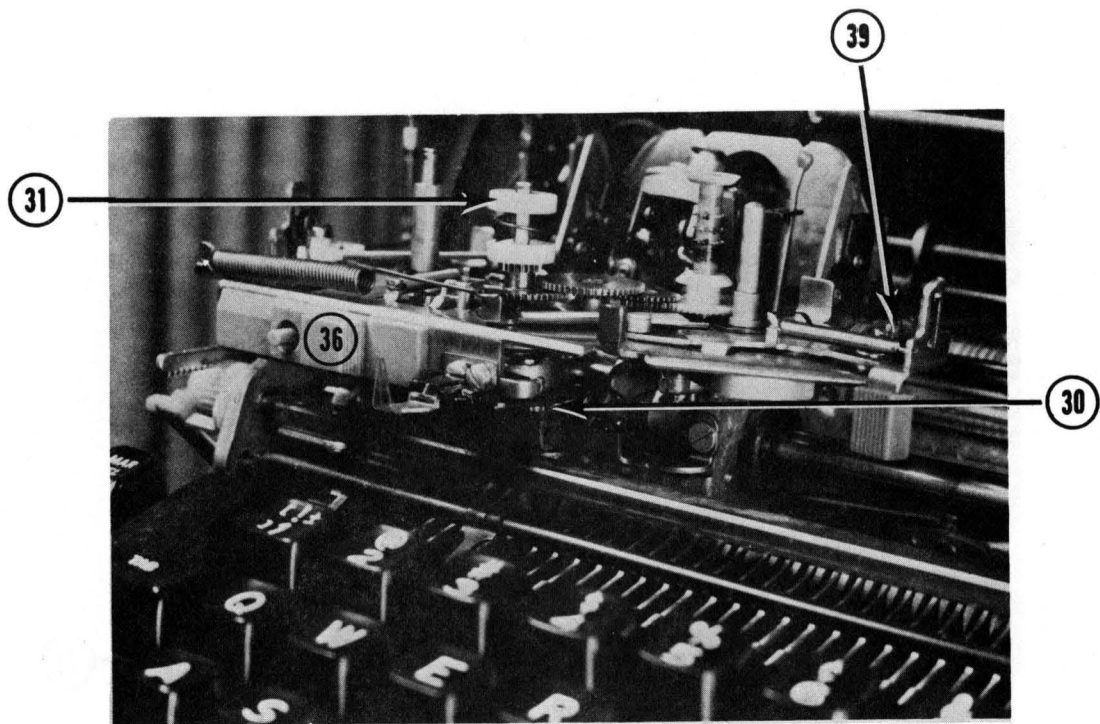

Figure 111

30. Ribbon feed & lift wheel 31. Mode buttons 36. Stencil lever
39. Detent latch for load lever

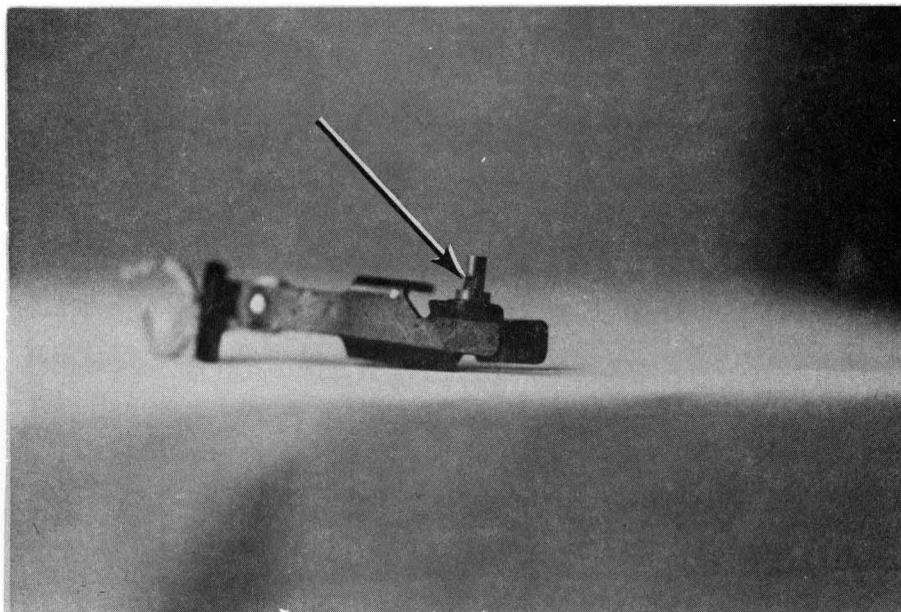

Figure 112

Worn groove in ribbon lift lever (108-21). Groove is caused by ribbon feed & lift wheel (111-30). This groove causes ribbon lift problems.

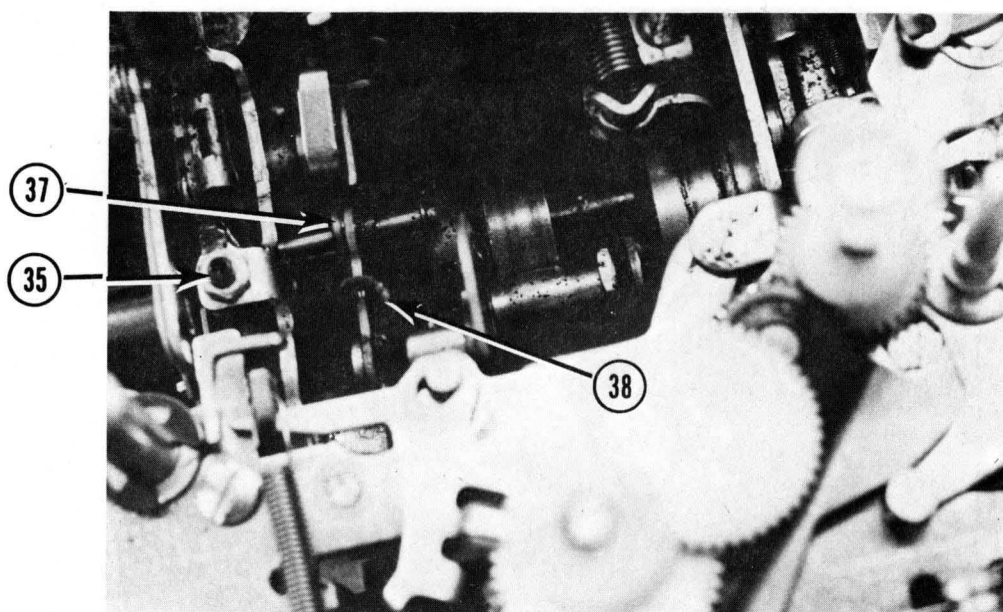

Figure 113

35. Ribbon lift adjusting screw 37. Ribbon lift cam follower roller
38. Lug - prevents feed pawl from operating.

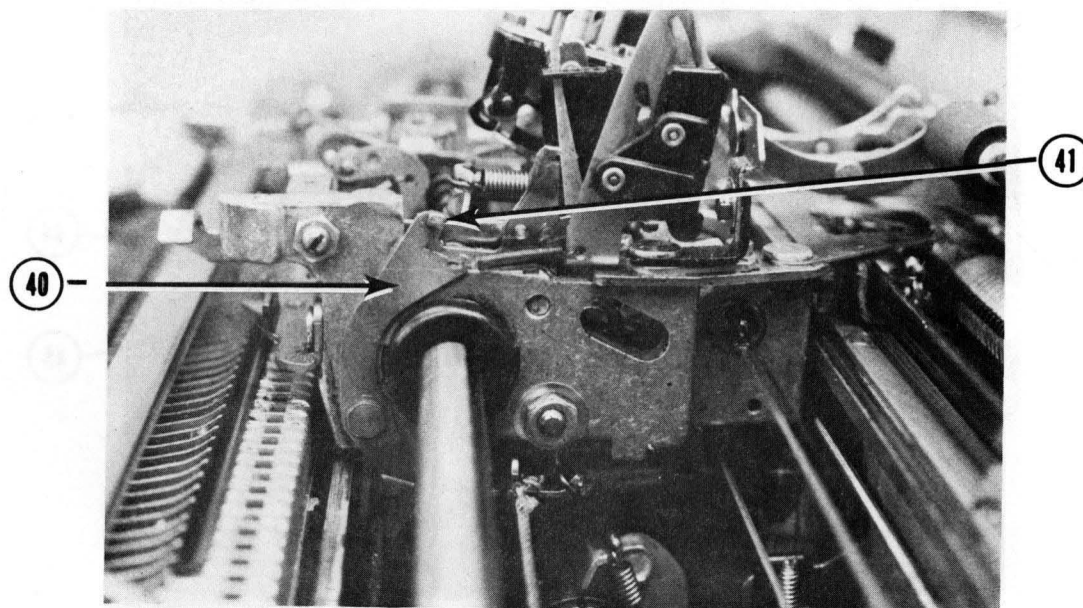

Figure 114

40. Tape feed inhibitor 41. Tape feed cam follower

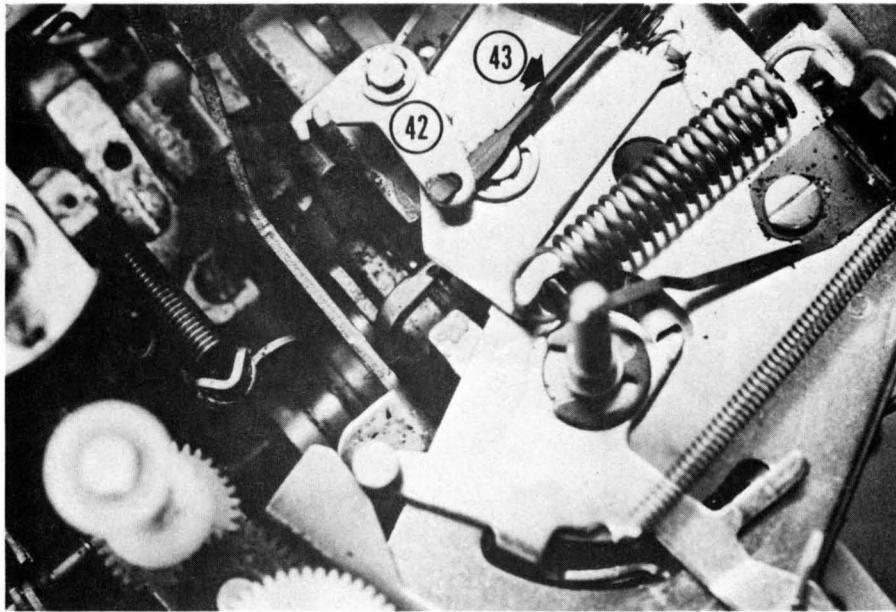

Figure 115

42. Feed bellcrank 43. Feed link

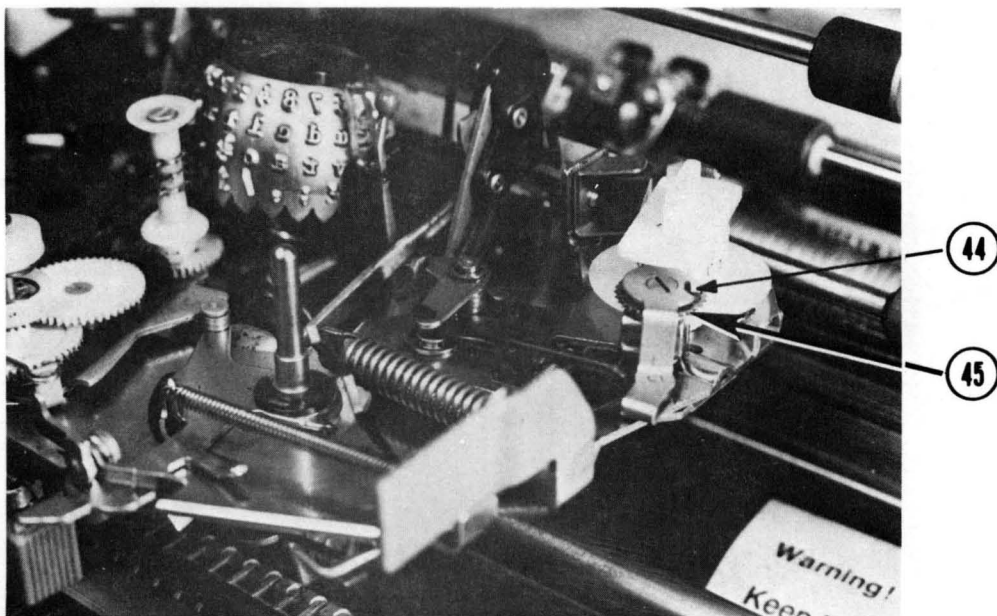

Figure 116

44. Tape feed pawl 45. Spiked driver

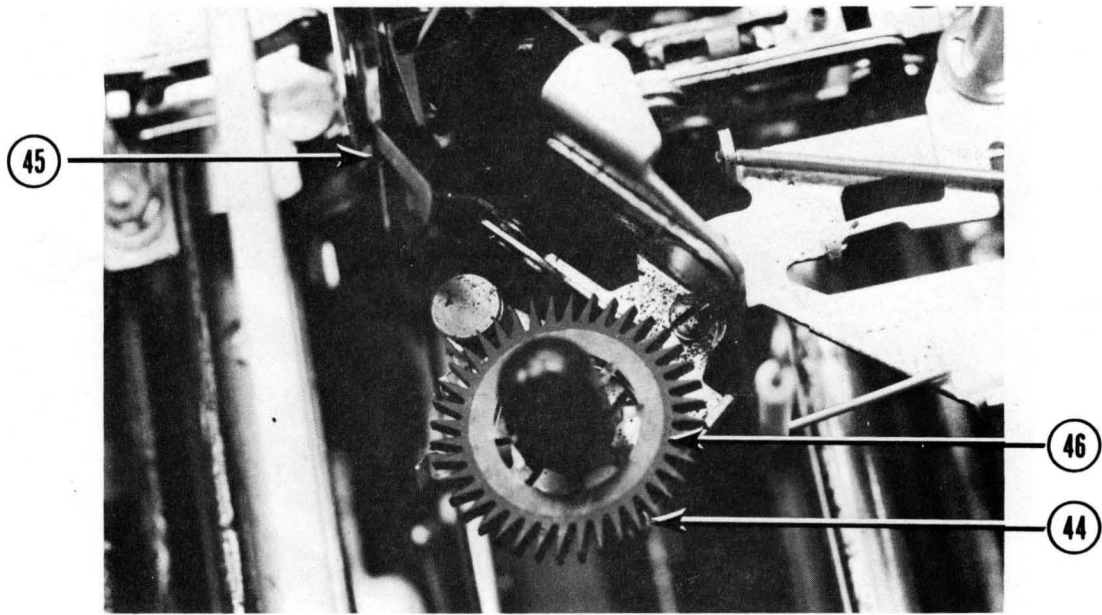

Figure 117

46. Cradle supply spool 45. Tape lift assembly 44. Detent

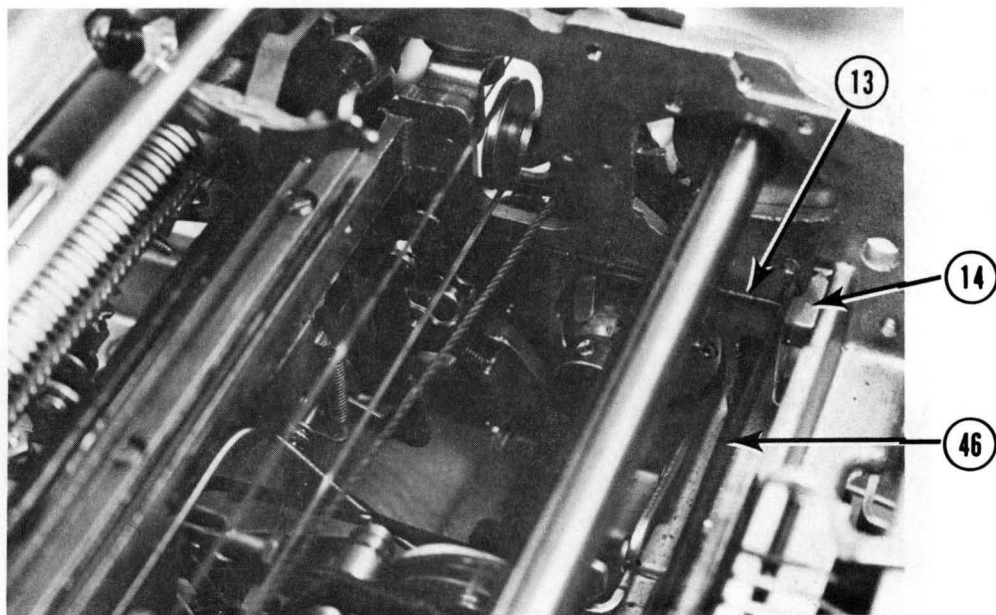

Figure 118

13. Correction torque bar link 14. Torque bar stop bracket 46. Torque bar.

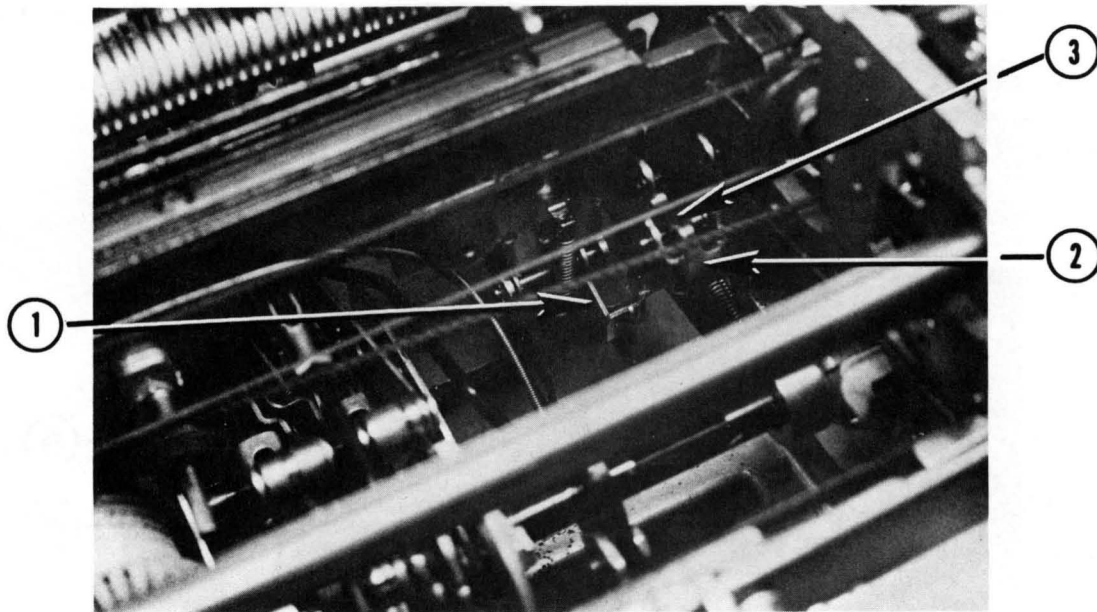

Figure 119

1. Mode latch 2. Mode actuating bellcrank 3. Form lug for adjustment

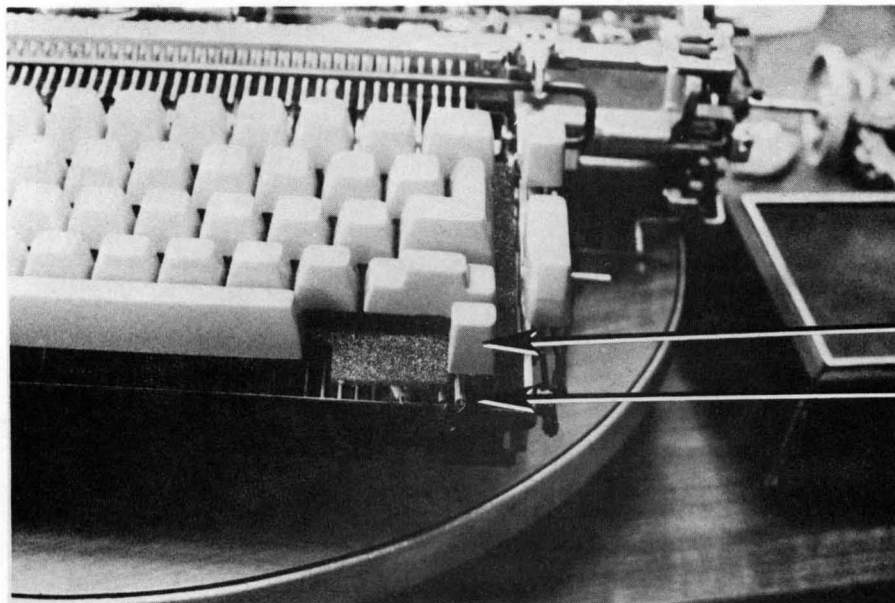

Figure 120

4. Correctable keybutton & spring 11. Correcting keylever slot for mounting over backspace keylever

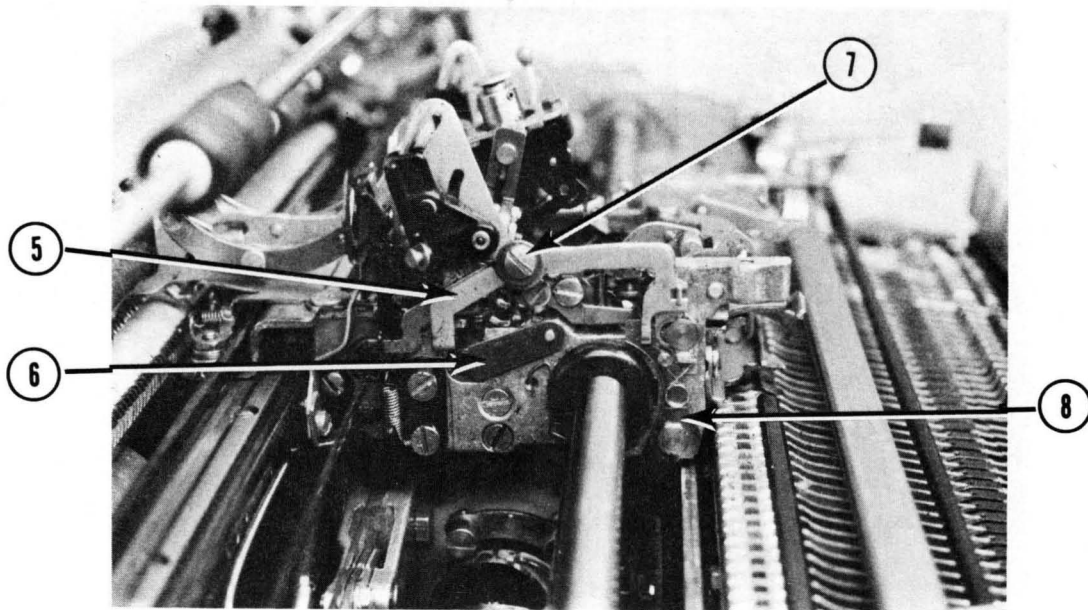

Figure 121

5. Lift arm latch 6. Tape lift cam follower 7. Adjusting screw
8. Tape lift actuating arm

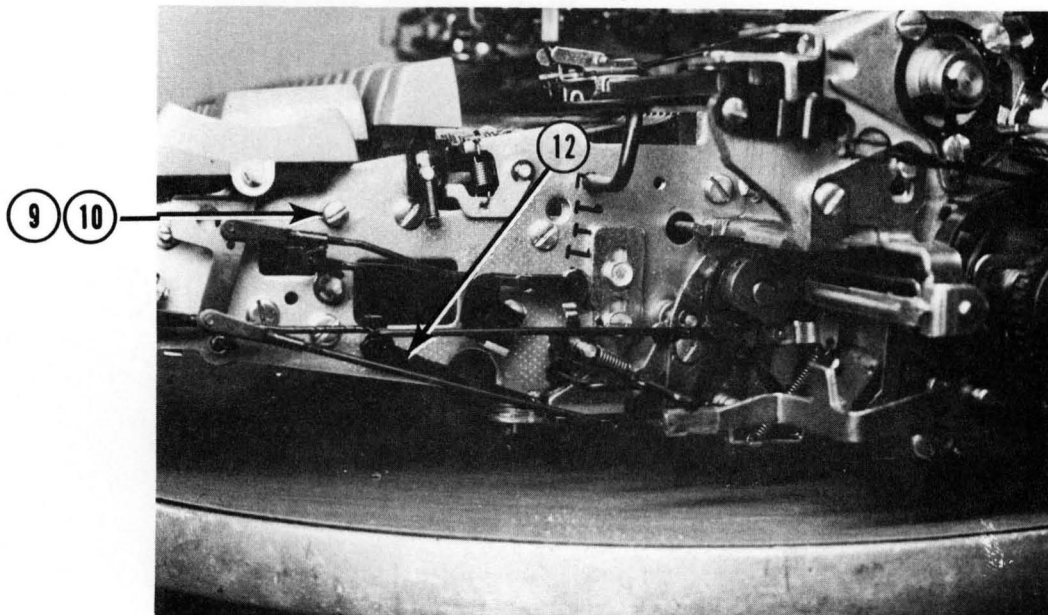

Figure 122

9. Correcting keylever pivot point 10. Adjustment screw for side play
of correction keylever 12. Correction keylever link

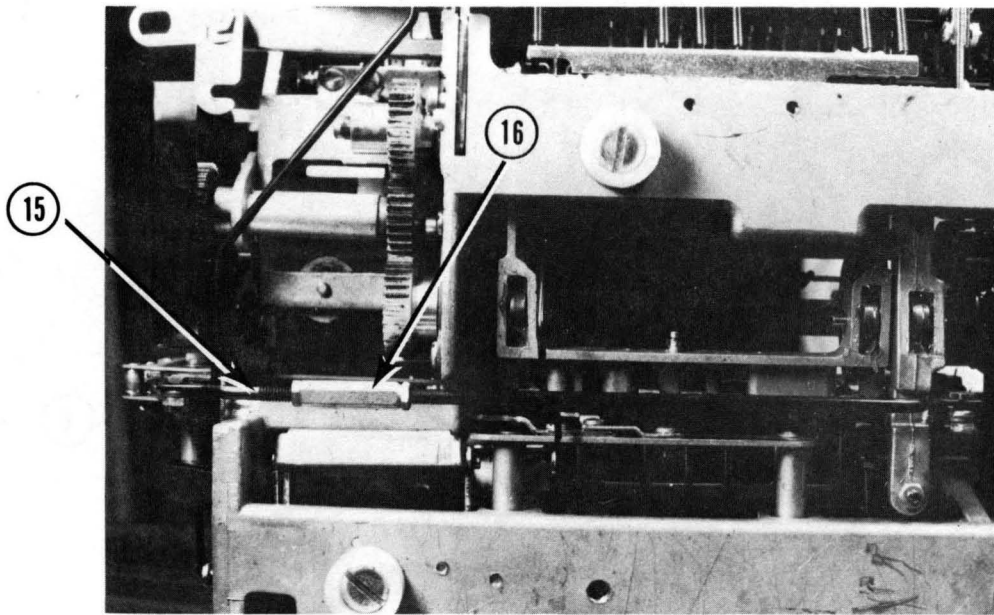

Figure 123

15. Rotate link 16. Turn buckel

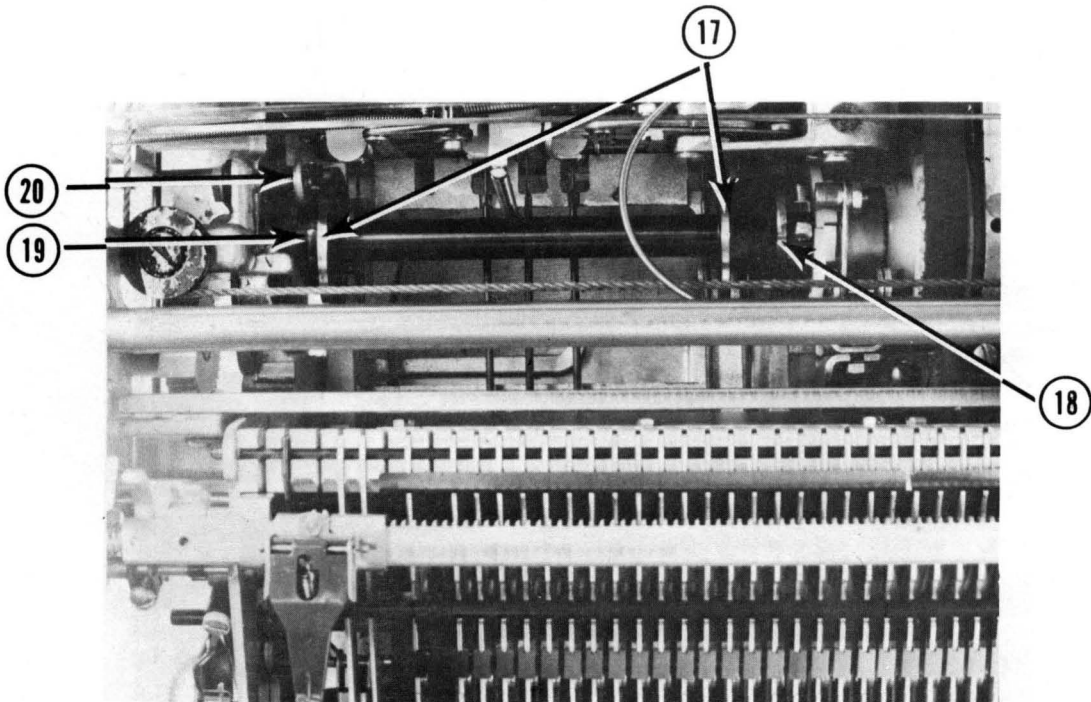

Figure 124

17. Positive cams 18. Negative cam 19. Cycle clutch check ratchet
20. Cycle clutch check pawl

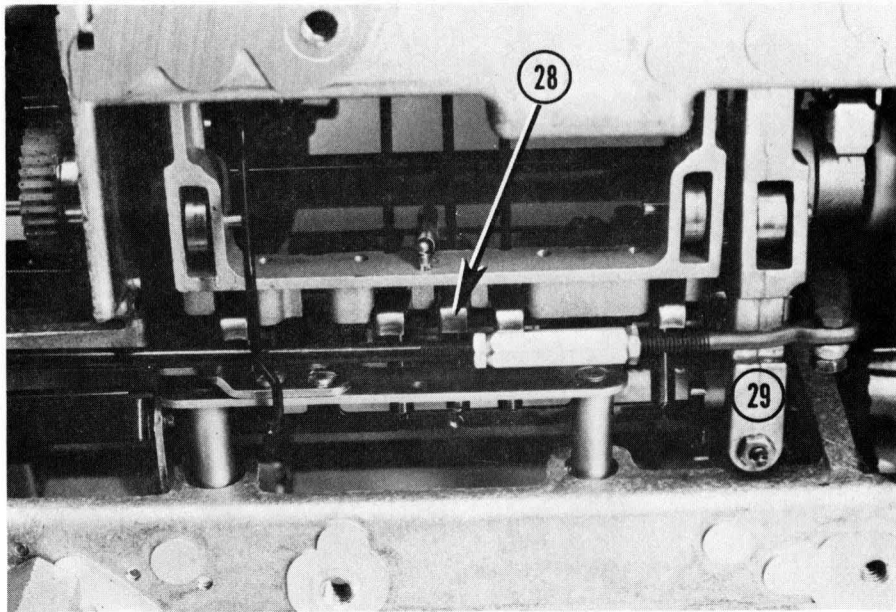

Figure 125

28. Selector latches 29. Negative latch bail

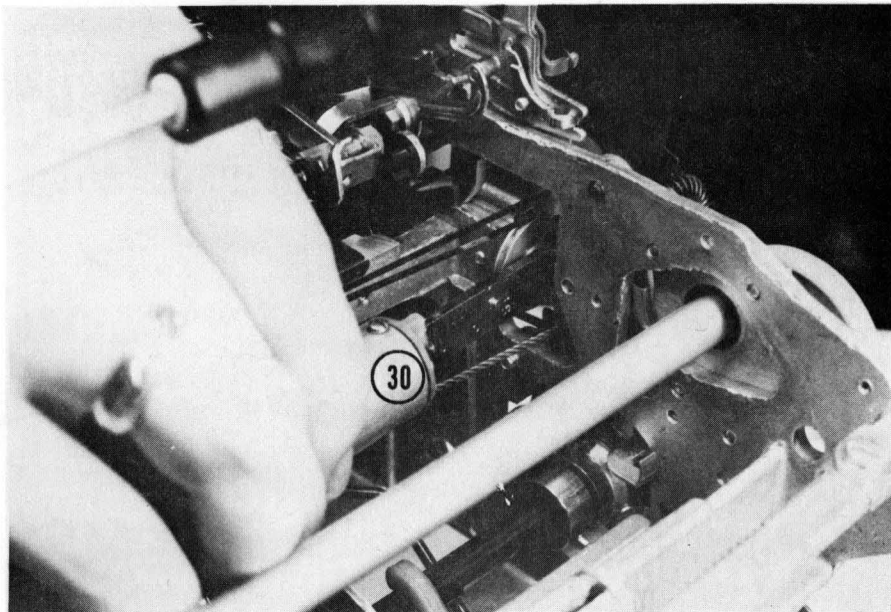

Figure 126

30. Spring gage measuring rotate spring tension - should measure 2 lbs.

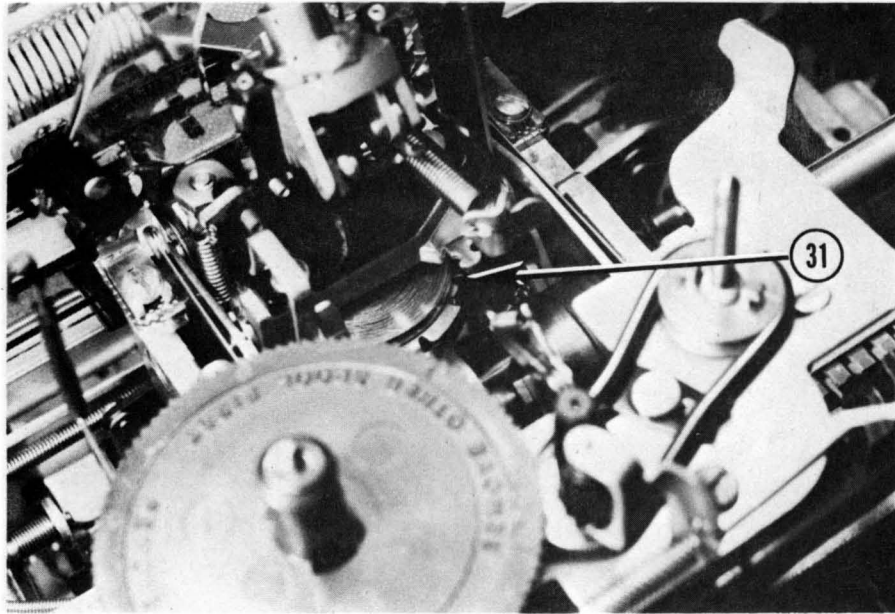

Figure 127

31. Rotate spring cage detent

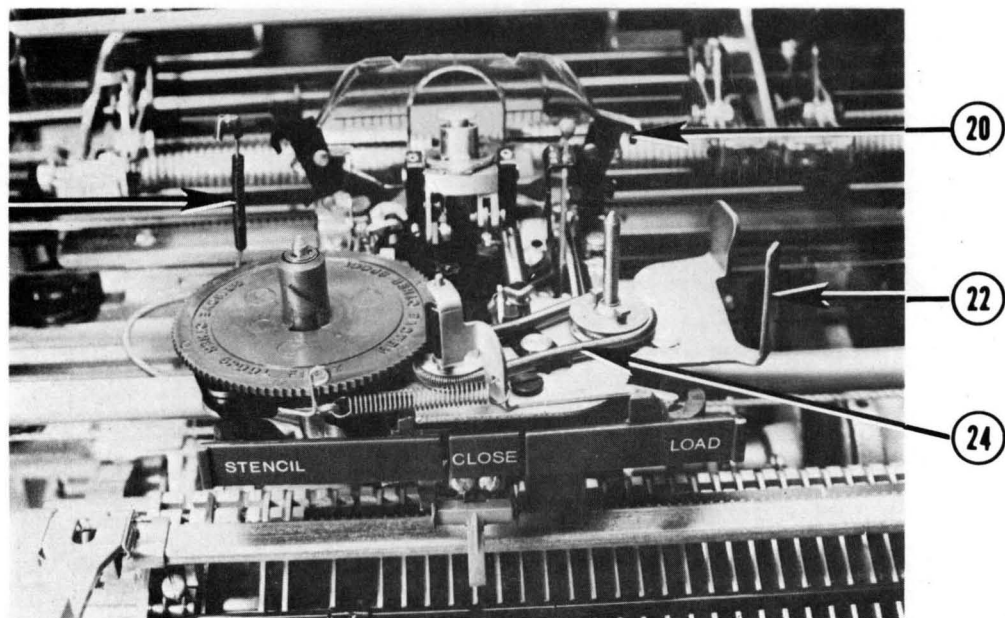

Figure 128

20. Ribbon lift guides 21. Shock wire sleeve 22. Right ribbon corner guide 24. Ribbon drive spring

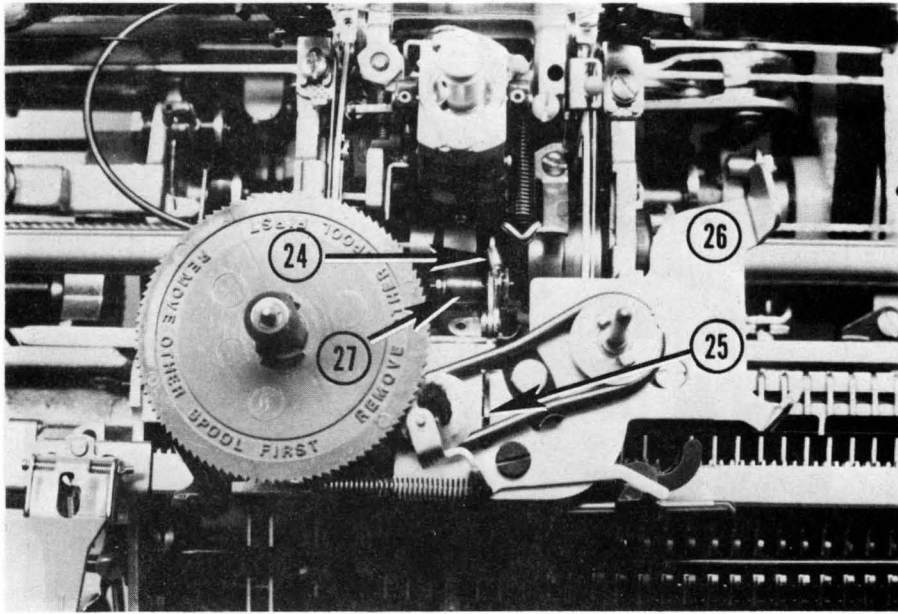

Figure 129

24. Feed pawl spring 25. Ribbon feed pawl 26. Ribbon plate
 27. Ribbon feed cam follower stud or pawl eccentric

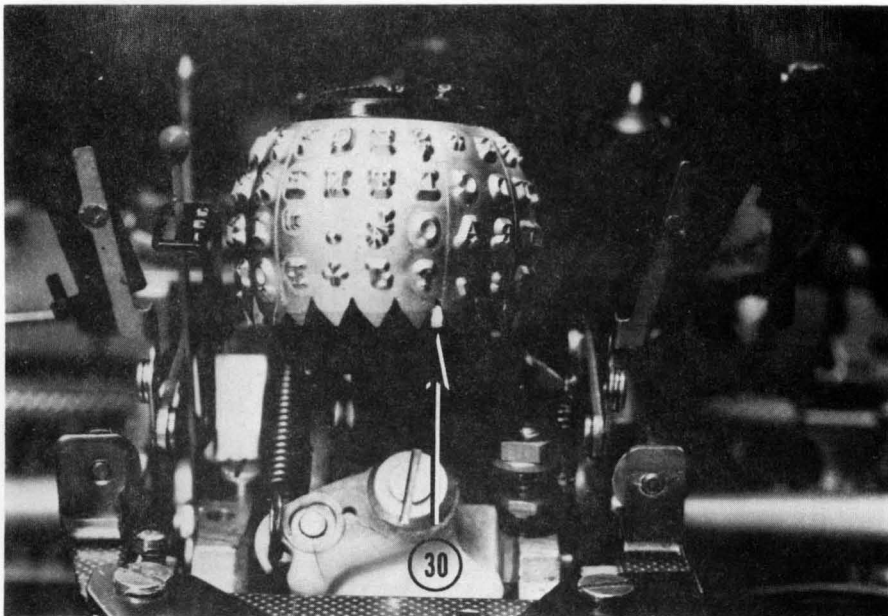

Figure 130

30. Rotate detent shown engaged with element - as the letter "J" is at the half cycle point.

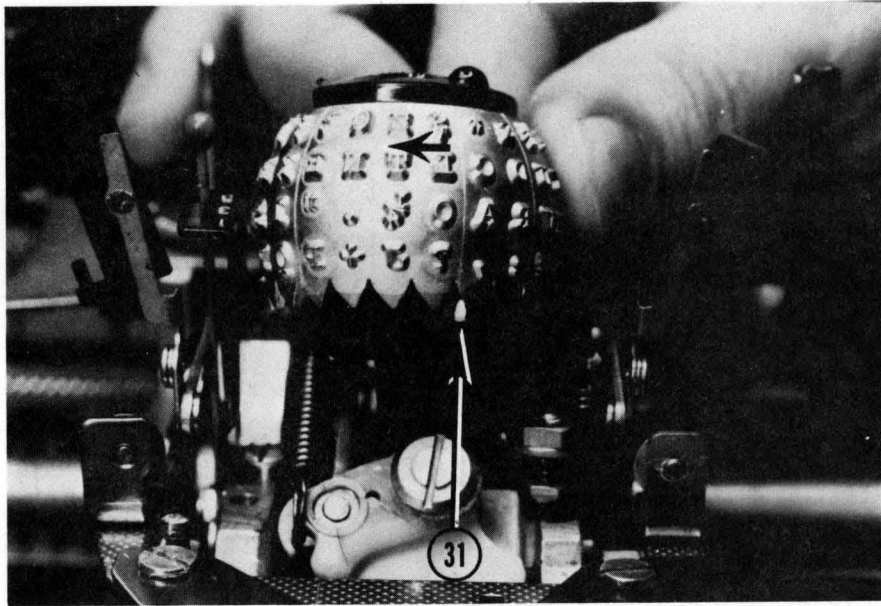

Figure 131

31. Rotate detent contacts the element on the negative slope, with the headplay removed in a clockwise or negative direction.

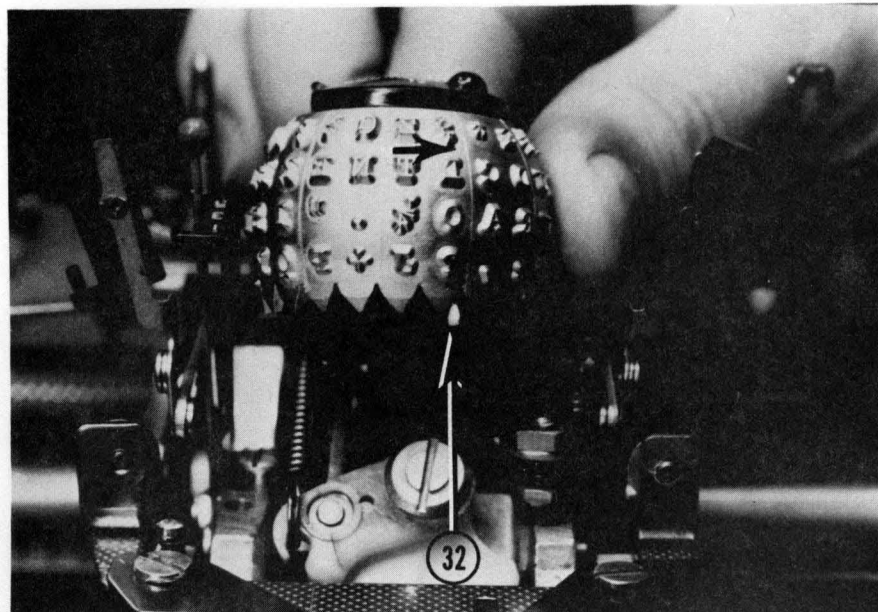

Figure 132

32. Rotate detent is contacting the positive side of tooth on element.

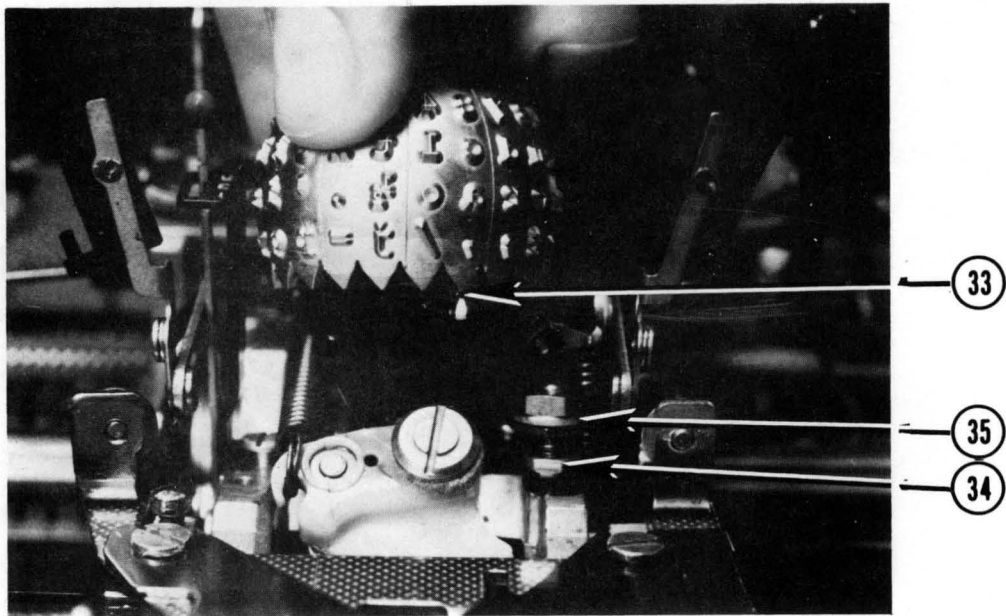

Figure 133

33. The clearance between the rotate detent and element is called skirt clearance - skirt clearance should be approximately .025".
34. Locking nut 35. Adjusting nut

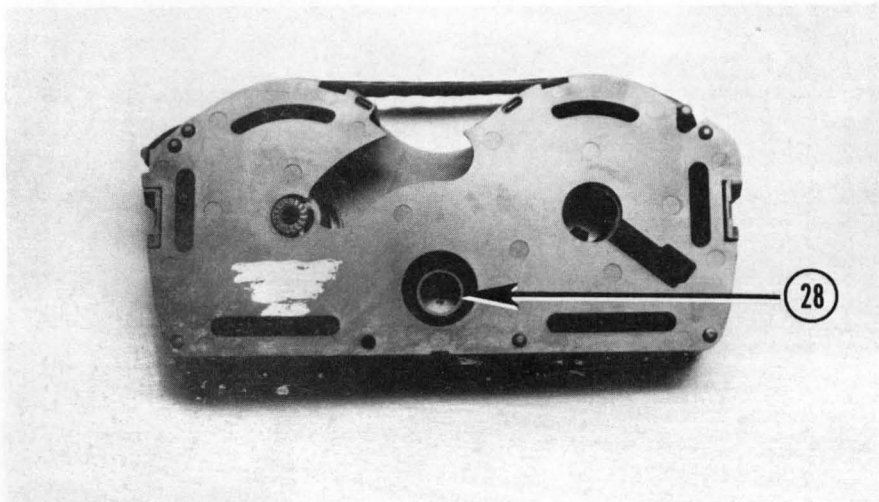

Figure 134

28. Projection mode

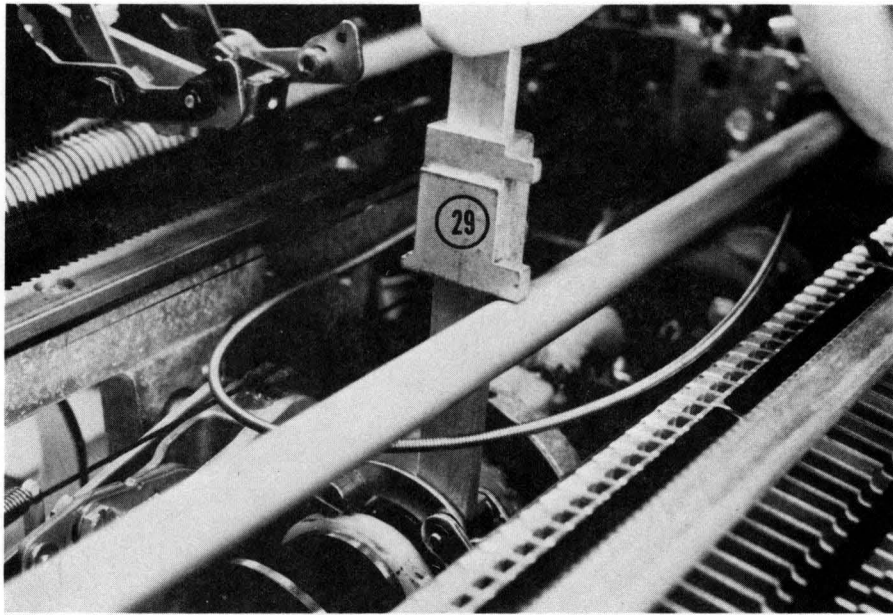

Figure 135

29. Hooverometer - Adjusted at #3 scribe line for adjustment of cycle clutch latch height.

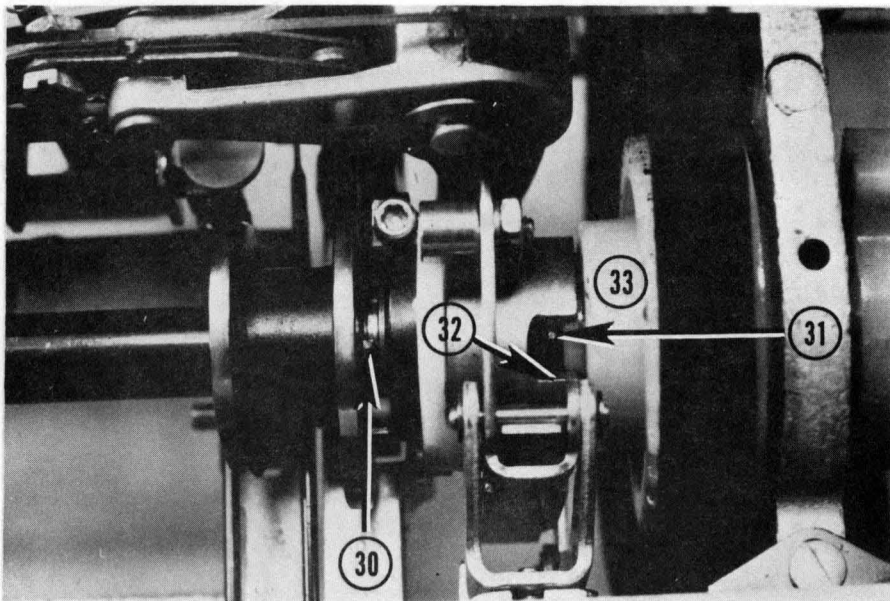

Figure 136

30. Left turned up ear on cycle clutch spring 31. Right turned up ear on cycle clutch spring 32. Bottom edge of window in cycle clutch sleeve 33. Cycle clutch pulley hub

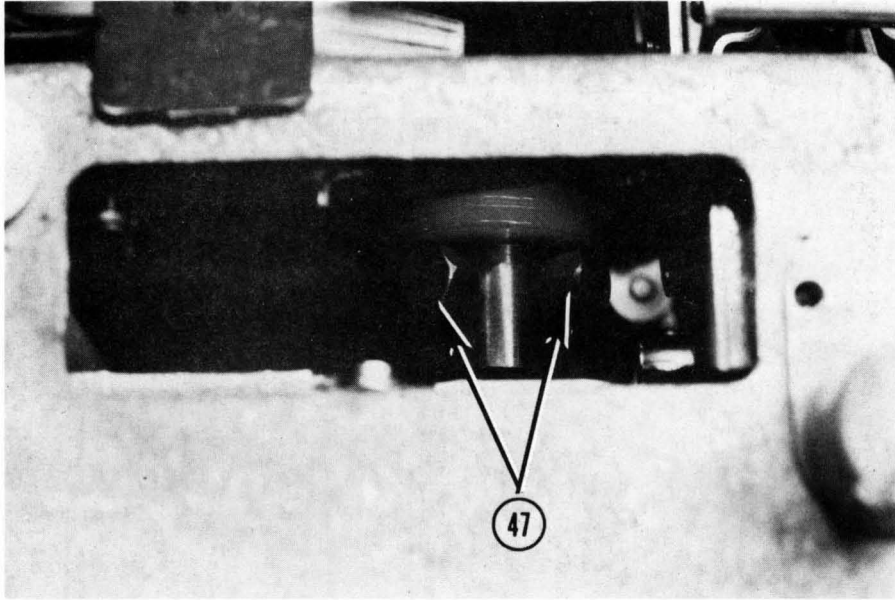

Figure 137

47. Tab cord drum locking screws

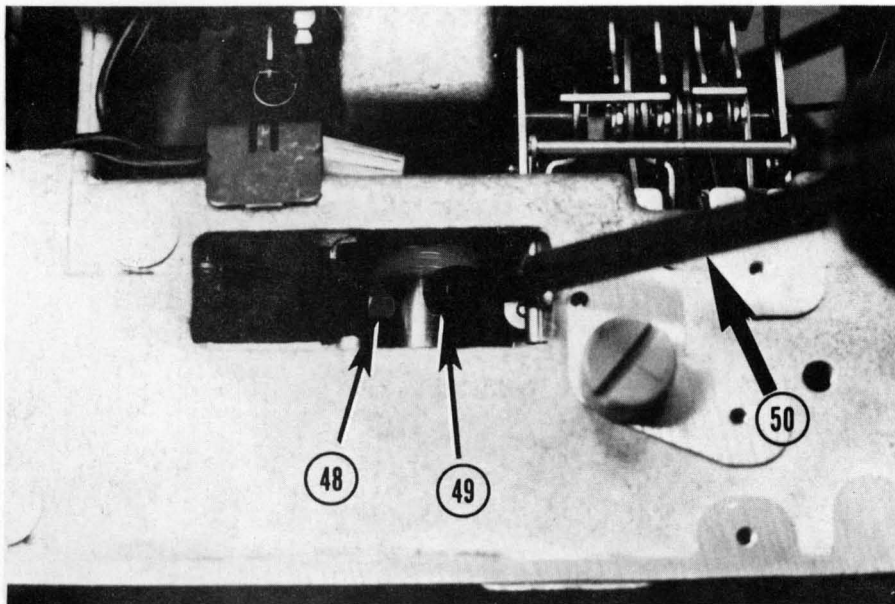

Figure 138

48. 1st screw on tab cord drum 49. 2nd screw on tab cord drum
50. Socket wrench

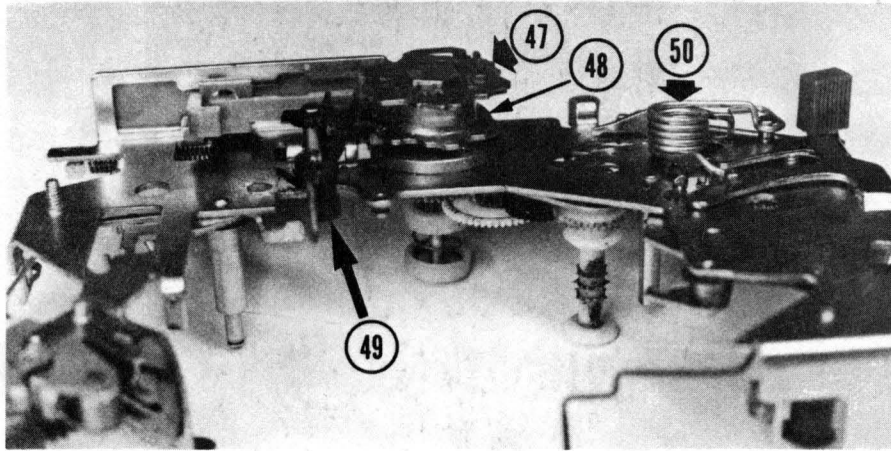

Figure 139 - Selective ribbon mechanism

47. Ribbon feed & lift wheel 48. Wobbler cam 49. Lift control lever
 50. Lift lever spring

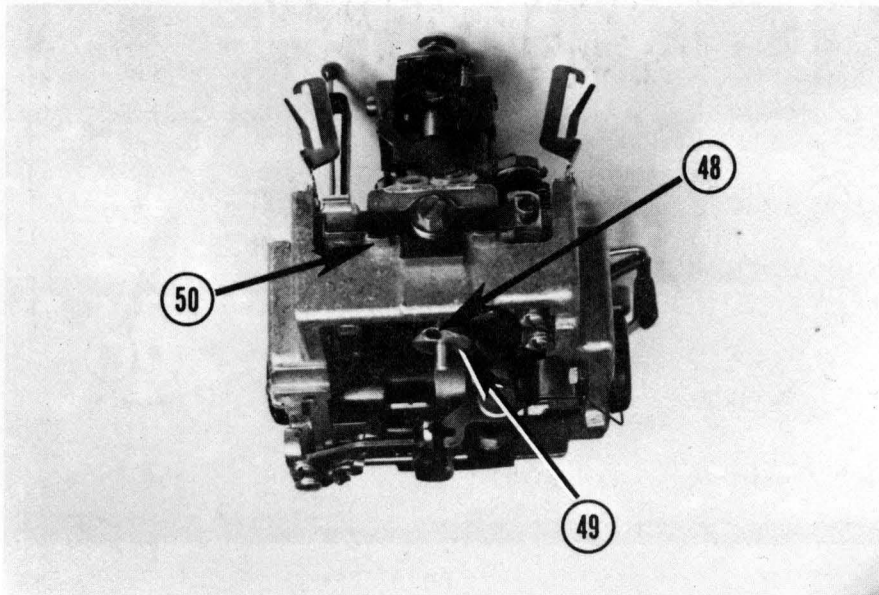

Figure 140 - Carrier (rear view)

48. Rotate shaft locking screw 49. Rotate pulley 50. Carrier shoe

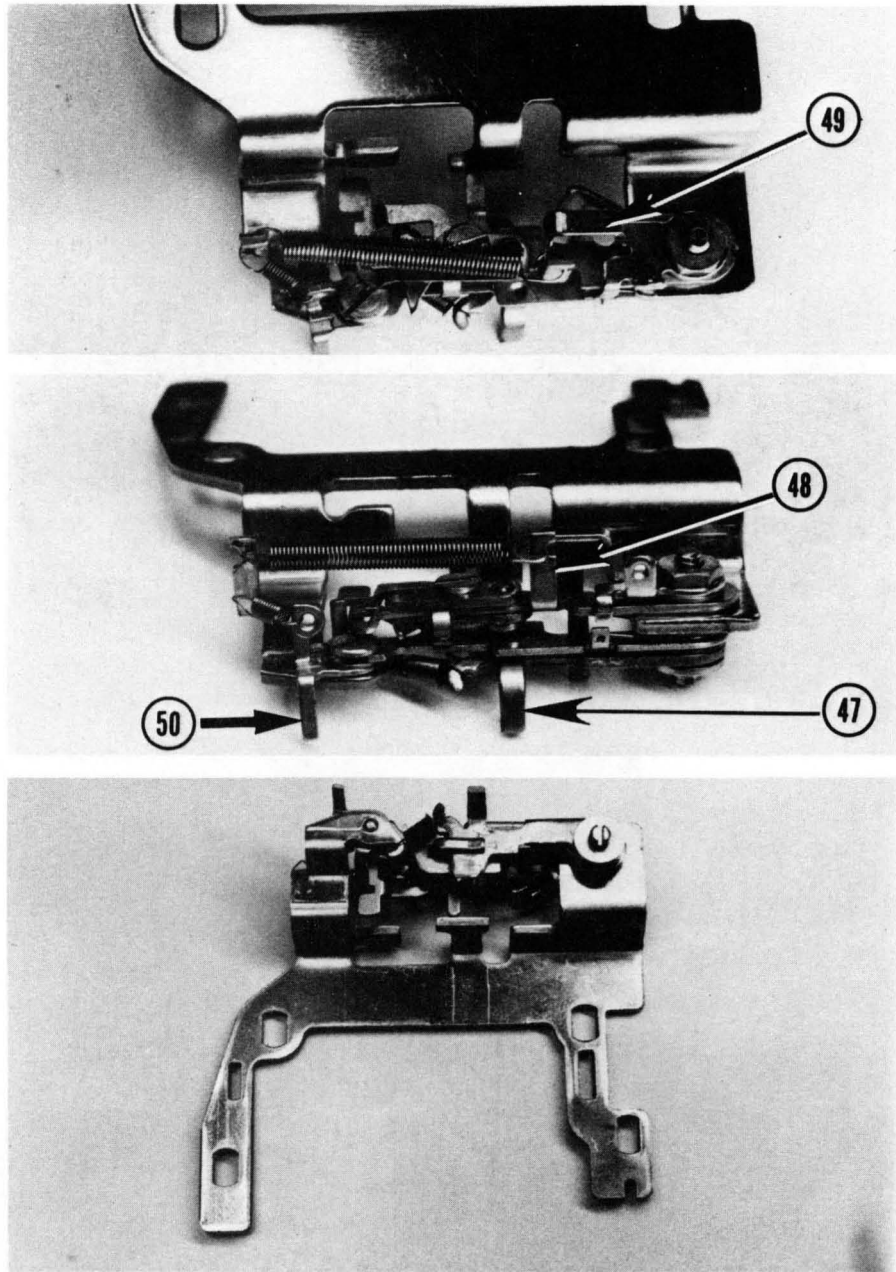

Figure 141 - Selectric II Escapement bracket

47. Escapement pawl 48. Tab lever 49. Tab trigger 50. Tab latch

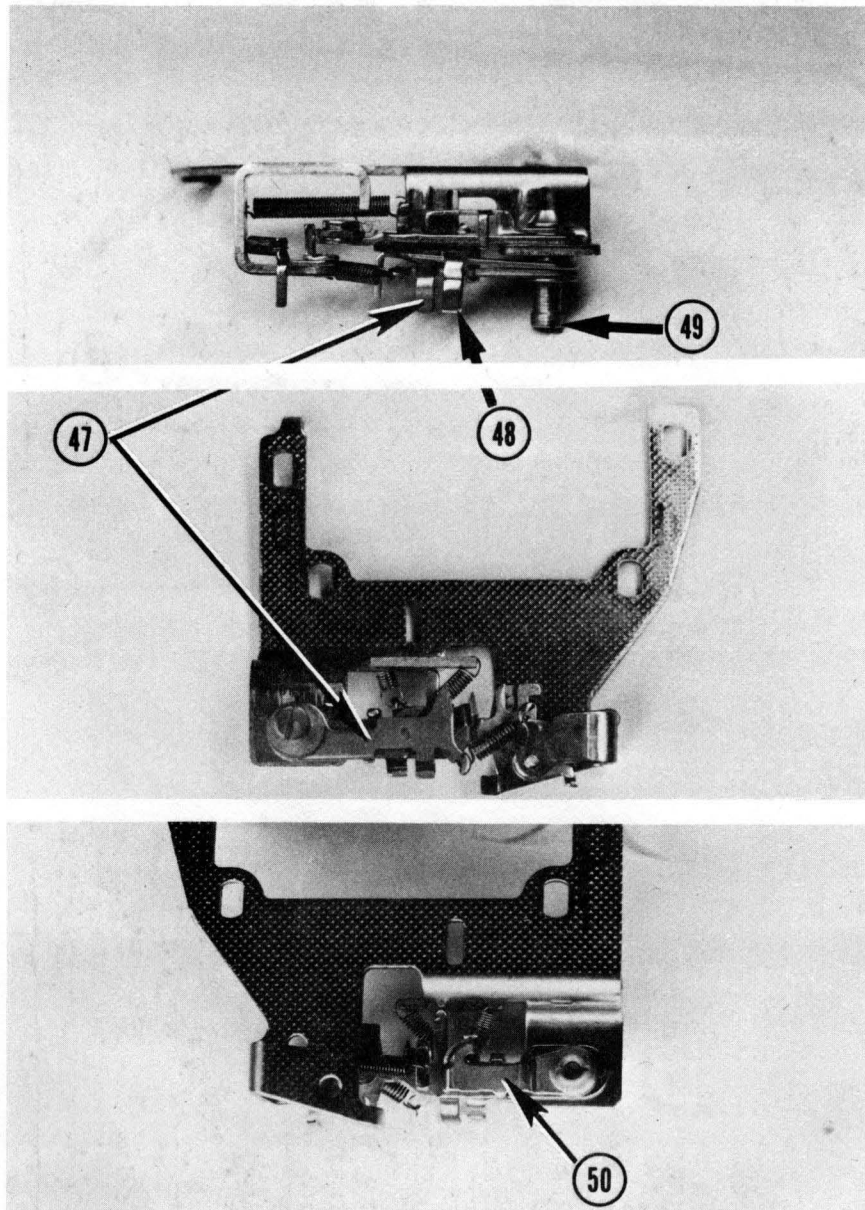

Figure 142 - Selectric I Escapement bracket

47. Escapement pawl 48. Backspace pawl 49. Pawl mounting stud
50. Tab trigger

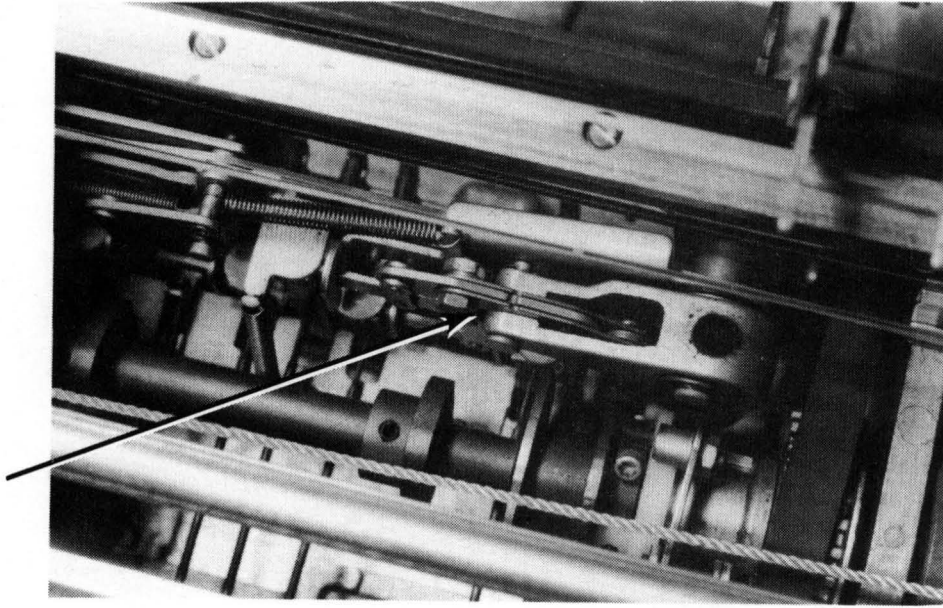

Figure 143

The way the balance arm should look after you preset it.

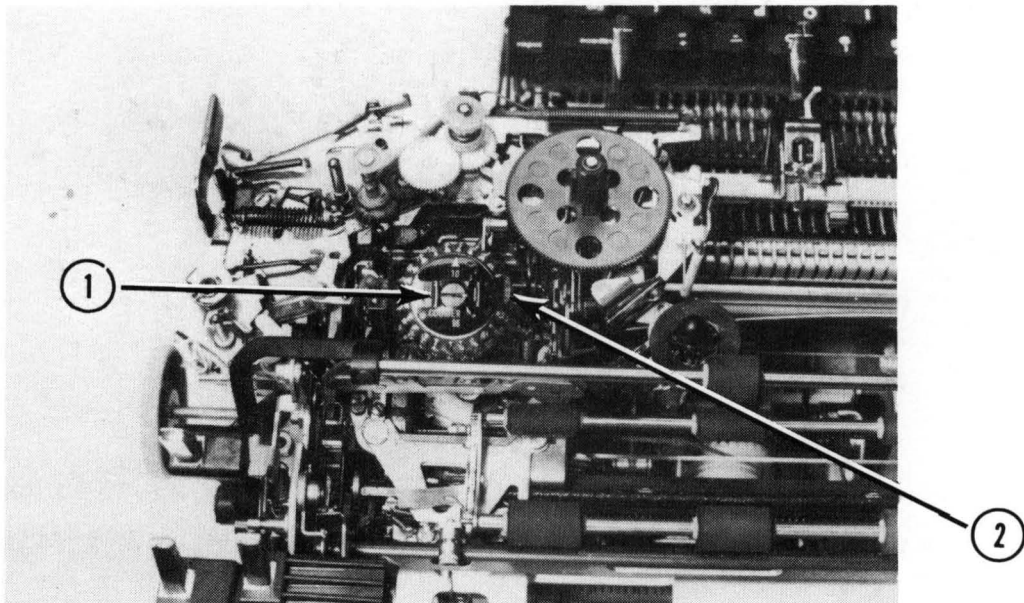

Figure 144

1. Upper ball socket adjustable screw

2. Type element lever