



Technical Bulletin

January 23, 1981

Service Division

81-006

New Large Capacity Disk Option For XL40 Systems

The Pertec XL40 Large Capacity Disk (LCD) unit, shown in the figure below, uses Winchester technology to provide reliable high density performance with 70 megabytes of unformatted storage capacity.

The head/disk module contains three 14-inch platters with ten data heads and two servo heads, all factory-sealed for protection from contamination. The logic module, located behind the head/disk module, contains the power supply, ten plug-in control PCBA's, and an interface PCBA.

Two new XL40 PCBA's (LCD Data Adapter and LCD Control Adapter) make up the LCD Controller that is mounted in the XL40 card cage and provides system-to-LCD interfacing. The LCD Controller has full track buffering and self-test diagnostic capabilities. It also performs automatic retirement of sectors with errors and maintains an error map of such sectors.

The LCD unit is mounted on slides for installation into the existing MCU-1 cabinet or the XL40 expansion cabinet. Field upgrade installation requires removal of existing D1462 or D3462/82 disk drives and the Rigid Disk Controller (DSK1) because mixing of the LCD option with existing D1462 or D3462 drives is not permitted.

NOTE

The XL40 backwiring PCBA (261141) must be at revision level 10 or above to function correctly with the LCD option. Check the status of this PCBA before installing the LCD field kit.

Operating system software for the LCD will be available with software release 1.7B, scheduled for June '81 release. Diagnostic software to support the LCD will be available in release V5.0 scheduled for February '81 release.

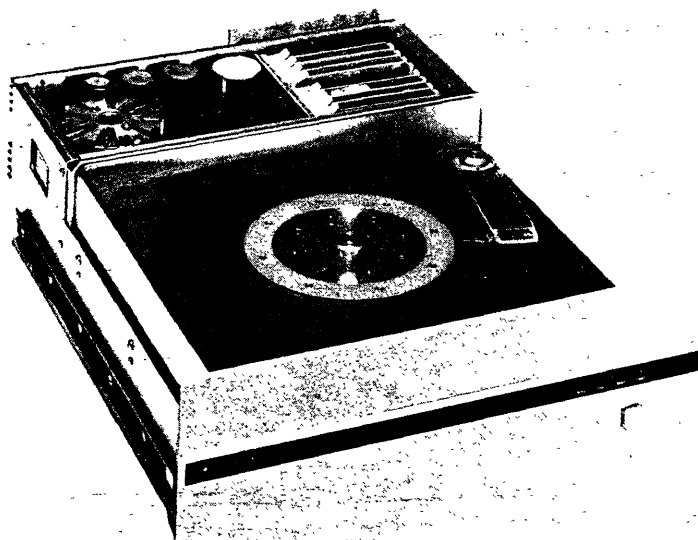

System software allows the LCD option to be marketed in 35-megabyte increments. Hardware units supplied always have 70-megabyte capacity, but the software options may limit actual use to 35-megabytes. The LCD model numbers for both factory-installed and field-installed units are listed below.

Factory Installed

- 4202-0 LCD Controller Set
- 4245-1 First Disk Drive, 35 megabytes
- 4242-2 First Disk Drive, 70 megabytes
- 4245-3 Second Disk Drive, 35 megabytes
- 4245-4 Second Disk Drive, 70 megabytes

Field Installed

- 4245-5 First Disk Drive, 35 megabytes, and LCD Controller
- 4245-6 First Disk Drive, 70 megabytes, and LCD Controller
- 4245-7 Second Disk Drive, 35 megabytes
- 4245-8 Second Disk Drive, 70 megabytes

Specifications for the LCD option are as follows:

Capacity: 70 megabytes unformatted, approximately 60 megabytes formatted.

Number of Platters: 3 fixed, with 10 data heads

Number of Cylinders: 700

Number of Heads per Surface: 2

Number of Heads per Cylinder: 5

Cylinder Capacity: 100,000 bytes

Track Capacity: 20,000 bytes

Rotation Speed: 3,000 rpm

Average Rotational Latency: 10 milliseconds

Track-to-Track Seek Time: 10 milliseconds

Average Seek Time: 45 milliseconds

Maximum Seek Time: 70 milliseconds

MTBF: 8,000 hours

MTTR: 1 hour

Schedule Maintenance: Annual replacement of filter

Height: 6.9 inches (17.5 cm)

Width: 19.0 inches (48.3 cm)

Depth: 23.5 inches (59.7 cm)

Weight: 75 pounds (33.75 kg)

Power Consumption: 240 watts at 115 VAC

Input Line Voltages: 115 VAC, 60 Hz
220 VAC, 50 Hz

Operating Temperatures: 50°F to 93°F (10°C to 34°C)
(XL40 system with LCD)

Doak Hefner
Project Leader
Advance Project Planning

IO CABLE | CDC DRIVE TO XL40

SWITCH 20A ON DATA PCBA  ON OFF

SWITCH 1A ON CONTROL PCBA ALL OFF

SWITCH 2A ON CONTROL PCBA ALL OFF

ALL TOGGLE SWITCHES ON CARDS IN CARD CAGE TOWARD REAR OF DRIVE EXCEPT LOCAL/REMOTE SWITCH TURN TO FRONT (LOCAL)

XL40 BACK VIEW

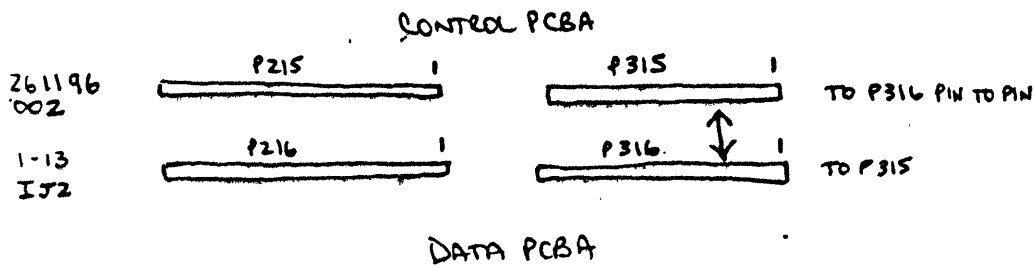

CDC BACK VIEW

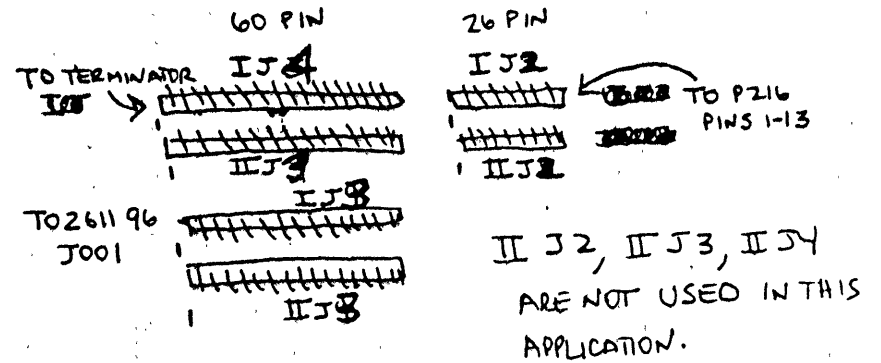

TOP VIEW INTERFACE 50/60 CONNECTOR

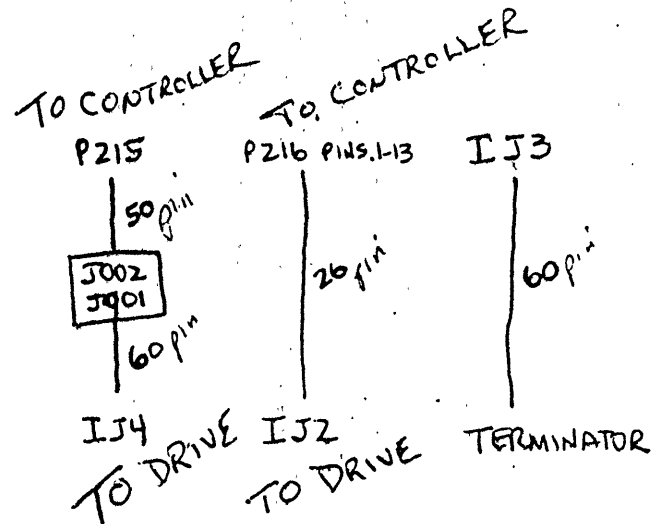
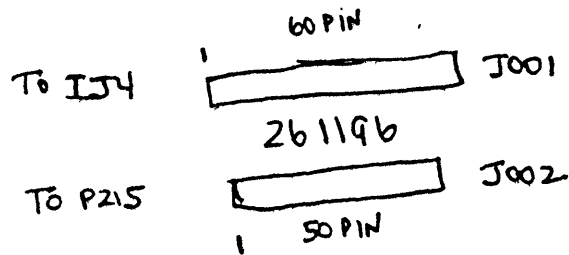

ALL CABLES ARE STRAIGHT PIN TO PIN

Section 20

LARGE-CAPACITY DISK DRIVE

This section is intended to provide the customer engineer (CE) with a quick reference on procedures used to unpack, install, check, adjust, and repair the large-capacity disk drive.

20.1 UNPACKING

The procedure for unpacking is provided for the times when a large-capacity disk drive is shipped individually, either as an add-on or as a replacement.

- a. Open the carton and remove the packing material.
- b. Lift the drive from its carton and lay it on a work surface.

WARNING

The large-capacity disk drive weighs 75 pounds. Do not attempt to lift the drive without assistance.

- c. Check for missing items or damage to the drive and note any discrepancies.

NOTE

Promptly notify the order services and the local agent of the carrier if items are missing or evidence of shipping damage is discovered.

- d. Record the serial number of the drive in the system log book.

CAUTION

Do not unlock the spindle lock restraint at this time.

20.2 INSTALLATION

This paragraph supplies information for both add-on large-capacity disk drives and replacement of existing drives. If an existing drive is being replaced, refer to paragraph 20.2.3.

20.2.1 REMOVAL OF EXISTING HARDWARE

- a. Save all customer jobs, compiles, and files to tape.
- b. Power down the system and set the MCU circuit breaker to OFF.
- c. Remove the lower front panel, left and right side panels, rear panel, and lower back cover from the MCU.
- d. Slide the existing D1460 or D3400 disk drive out to the service position.
- e. Disconnect the AC power cable from the D3400 disk drive or the DC power cable from the D1400 disk drive.
- f. If the MCU has an XL switching mode power supply with an S1416A power supply; disconnect and remove the S1416A power supply (refer to paragraph 2.5.6).
- g. Disconnect the signal cables from the existing disk drive.
- h. Loosen the slide-restraint screws and slide the drive out of the MCU.
- i. Remove the right slide (facing the MCU) from its mounting bracket.
- j. Remove the four nuts securing the left bracket and slide assembly to the MCU frame. Remove the left bracket and slide assembly.
- k. Remove the back lower panel and the air baffle if installed.
- l. Remove the rigid disk controller (DSK1) from the card cage.
- m. Remove the disk signal cable from the rear of the card cage.

20.2.2 NEW HARDWARE AND CABLE INSTALLATION

- a. Install one of the new slides on the new left bracket (Figure 20-1).
- b. Install the new left bracket and slide assembly on the studs on the left side of the MCU frame.
- c. Attach the two cable clamps to the left bracket.
- d. Install the other new slide on the new right bracket.
- e. Install the cable retractor bracket on the right bracket.
- f. Install the LCD 50/60 translator PCBA to the cable retractor bracket with J001 upward.
- g. Install the cable retractor to the cable retractor bracket.

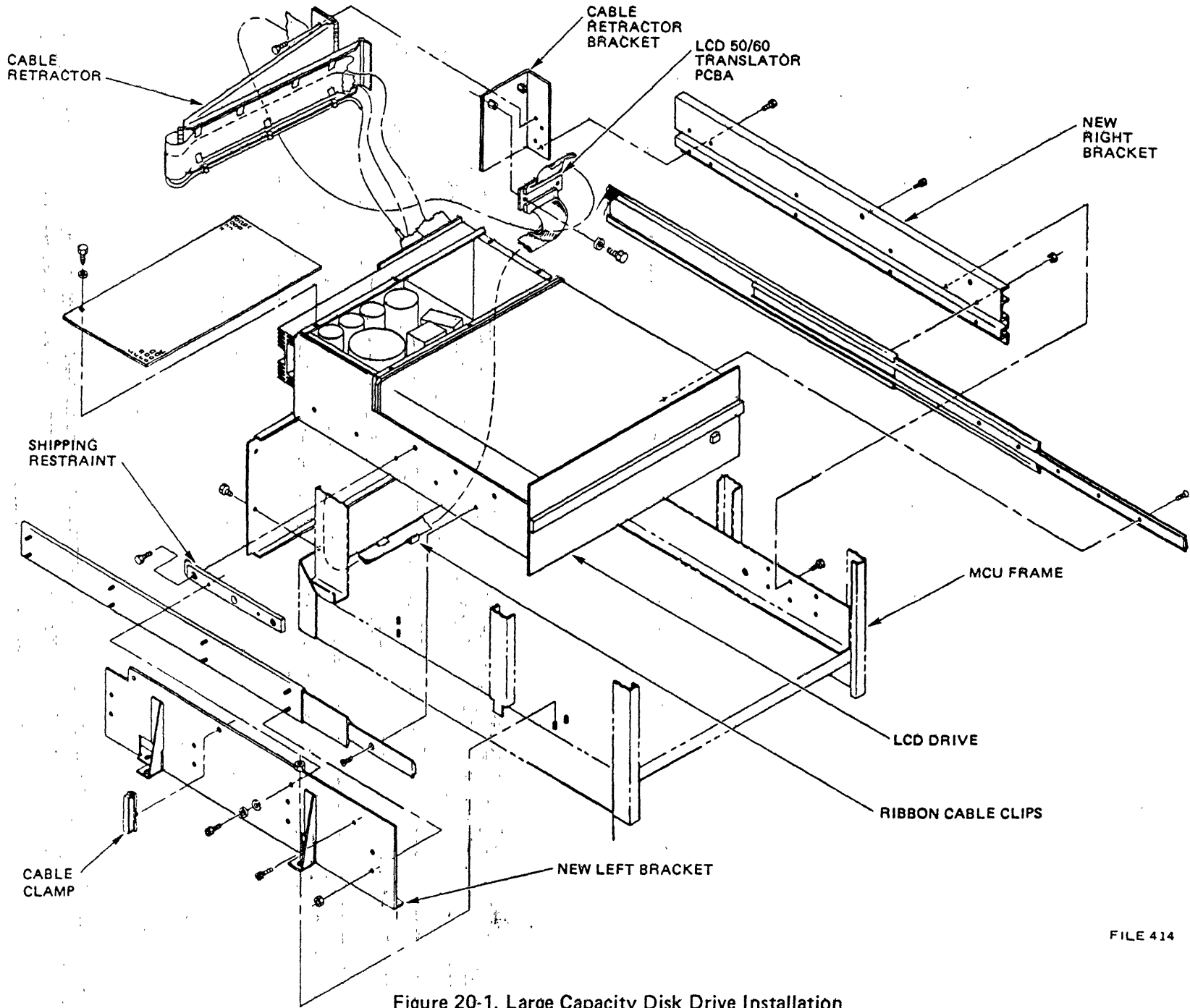
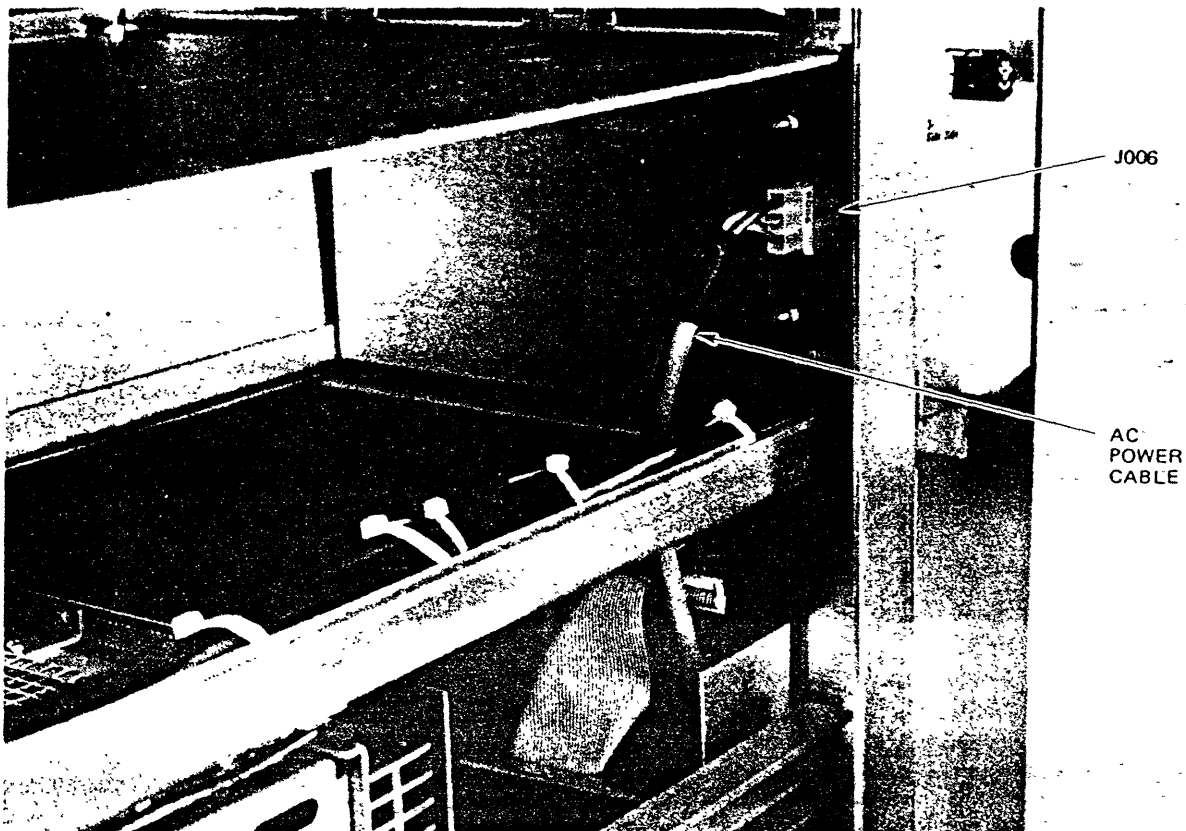

Figure 20-1. Large Capacity Disk Drive Installation

- h. Attach the ribbon cable and line cord clips to the cable retractor.
- i. Route the flat LCD signal cables, LCD data-to-drive cable (W45) and LCD translator-to-drive cable (W43) through the cable retractor. Leave approximately six inches free at the drive end of the retractor. The wider LCD translator-to-drive cable should be on the outside.
- j. Route the LCD AC power cable along the bottom of the cable retractor and secure it with the cable clips. Leave approximately 24 inches free at the drive end.
- k. Attach the right retractor/slide assembly to the existing right bracket in the MCU.
- l. Route the AC power cable as shown in Figure 20-2 and plug the cable into J006 on the switching mode power supply or J005 on the linear power supply. Systems with linear power supplies require use of the extension cable supplied with the kit.
- m. Connect P002 of the LCD control-to-translator cable (W42) to J002 of the LCD 50/60 translator PCBA (Pin 1 should be to the left side).
- n. Connect P001 of the LCD translator-to-drive cable (W43) to J001 of the LCD 50/60 translator PCBA (Pin 1 should be to the left side).
- o. Attach the ribbon cable clips (reference Figure 20-1) to the lower rear of the MCU cabinet and route the LCD signal cables through the clips.



FILE 416

Figure 20-2. AC Power Cable (MCU)

- p. Route the LCD signal cables through the left-side bracket cable clamps and up through the cable duct (Figure 20-3).
- q. Set switch packs 1A and 2A on the LCDC control adapter PCBA and switch pack 20A on the LCDC data adapter PCBA to the appropriate settings as shown in Tables 20-1 and 20-2.
- r. Install the LCDC control adapter PCBA and the LCDC data adapter PCBA in the card cage as shown in Table 20-3. Other controller PCBAs may have to be moved to obtain the required installation sequence.
- s. Install the LCDC control/data interconnect cable (W41) J315 on P315 on the control adapter PCBA and J316 on P316 on the data adapter PCBA.
- t. Install J215 of the LCD control-to-translater cable (W42) on P215 of the control adapter PCBA.
- u. Install J216 of the LCD data-to-drive cable (W45) on P216 of the data adapter PCBA.

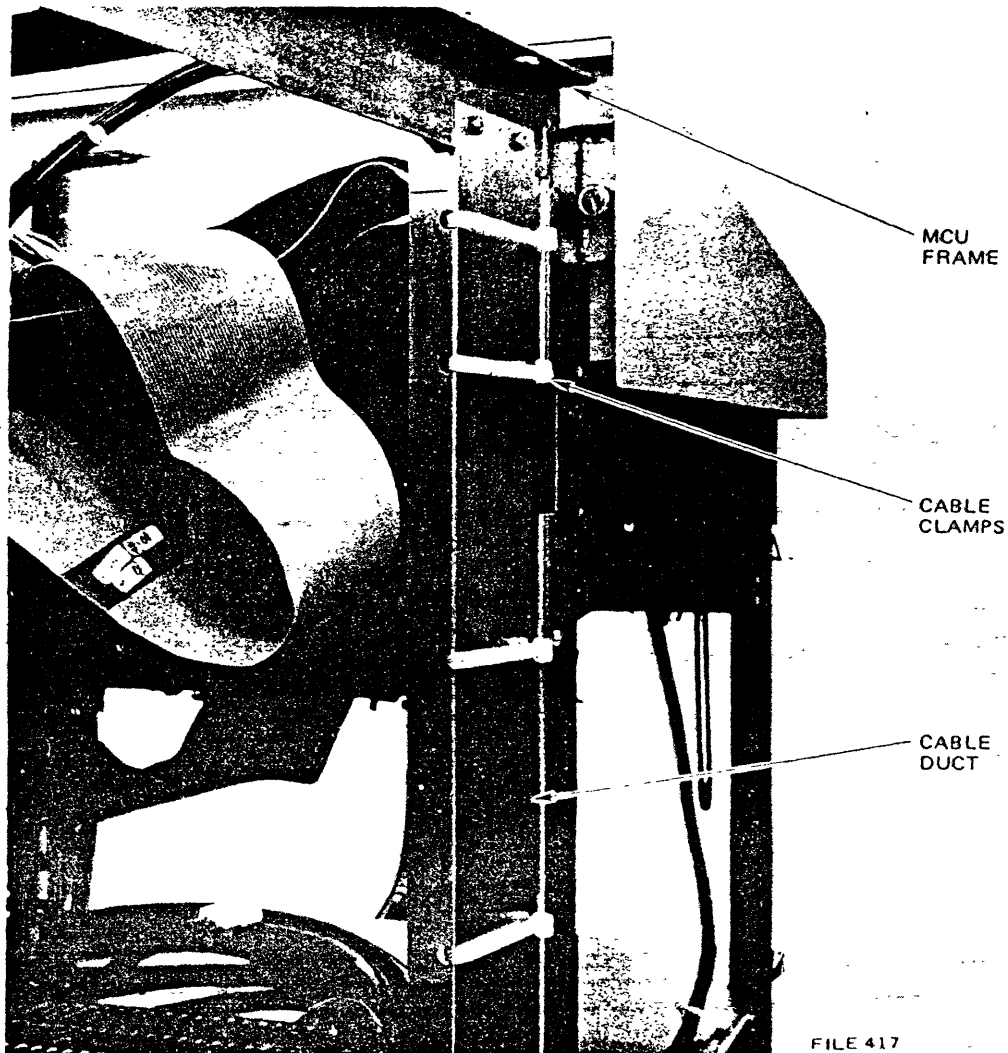

Figure 20-3. Large Capacity Disk Cable Installation

Table 20-1. LCDC Data Adapter PCBA Switch Settings

Switch Pack 20A		
S1	S2	No. of Drives
OFF	OFF	1
ON	OFF	2
OFF	ON	3
ON	ON	4

NOTE: Switches 3 through 8 indicate the type of LCD connected to the LCDC. When switch 3 is ON and switches 4-8 are OFF, the LCD type is a Kennedy Model 5300-70.

Table 20-2. LCDC Control Adapter PCBA Switch Settings

Switch Pack 1A				
Switch No.				Status Selected
1	2	3	4	
OFF				Select LCDC No. 1 Address OFF10-OFF17
ON				Select LCDC No. 2 Address OFF18-OFF1F
	ON	ON		25% of LCD Available for Use (11 MB)
	ON	OFF		50% of LCD Available for Use (26 MB)
	OFF	ON		75% of LCD Available for Use (41 MB)
	OFF	OFF		100% of LCD Available for Use (56 MB)
			NOT USED	S4 Normal Position is OFF
Switch Pack 2A				
NOTE: All switches (1 through 8) to OFF. Switch Pack 2A is a troubleshooting aid only.				

Table 20-3. Card Cage PCBA Sequence

PCBA Slot	PCBA
1 (top)	Station Multiplexer (SMUX1)
2	PE Read Logic (PE 16)
3	Magnetic Tape Controller (MAG1)
4	LCD Control Adapter (LCDCA)
5	LCD Data Adapter (LCDDA)
6	XPU (XPU1) (XPU2)
7	Memory (M1716) (M1764)
8	Memory (M1716) (M1764)
9	Memory (M1716) (M1764)
10	Memory (M1716) (M1764)
11	Option
12	Option
13	Option
14	Not Used

20.2.3 INSTALLATION OF LARGE-CAPACITY DISK DRIVE

- a. Set switch pack S5 on the disk drive bus out PCBA and switch pack S1 on the disk drive radial PCBA to the appropriate settings as shown in Tables 20-4 and 20-5.

Table 20-4. Busout PCBA Switch Settings

Switch Pack S5					
S1	S2	S3 Spare	S4 Spare	LCD Address	System LCD No.
ON	ON	OFF	OFF	0	1
OFF	ON	OFF	OFF	1	2
ON	OFF	OFF	OFF	2	3
OFF	OFF	OFF	OFF	3	4

NOTE: Switch Packs S1, S2, S3, and S4 are not used.

Table 20-5. Radial PCBA Switch Settings

Switch Pack S1			
Switch Function	Switch No.	Switch Position	Status Selected
Troubleshooting and Alignment Aids	1	ON	Normal Operation
	1	OFF	Radial Timing Adjustment
	2	ON	Radial Timing Adjustment
	2	OFF	Normal Operation
	3	ON	Radial Timing Adjustment
	3	OFF	Normal Operation
	4	ON	Radial Timing Adjustment
	4	OFF	Normal Operation

- b. Install the LCD card cage cover.
- c. Lay the drive on its left side.
- d. Slide the third extension member out of the right bracket in the MCU and attach the member to the drive (right side) using flat-head Phillips screws.
- e. Install the cable retractor bracket (reference Figure 20-6).
- f. Turn the drive over onto its right side.
- g. Slide the third extension member out of the left bracket in the MCU and attach it to the drive.
- h. Mount the shipping restraint bar to the left side of the drive. This bar is only used when shipping the MCU and large-capacity disk drive as a unit, but it should be installed on all units.
- i. With the drive laying on its right side in front of the MCU, plug the AC cable into the drive and route the cable along the bottom of the drive as shown in Figure 20-4.
- j. Position the drive on the slides and push it into the MCU to the service position.
- k. Loosen the spindle lock restraint (refer to Figure 20-5) and move it to the UNLOCK position. Retighten the restraint snugly.
- l. Attach the cable retractor to the mounting bracket on the right side of the drive (Figure 20-6).
- m. Connect P003 of the LCD data-to-drive cable to J3 on the SMD interface PCBA. Connect P004 of the LCD translator-to-drive cable to J4A on the SMD interface PCBA.

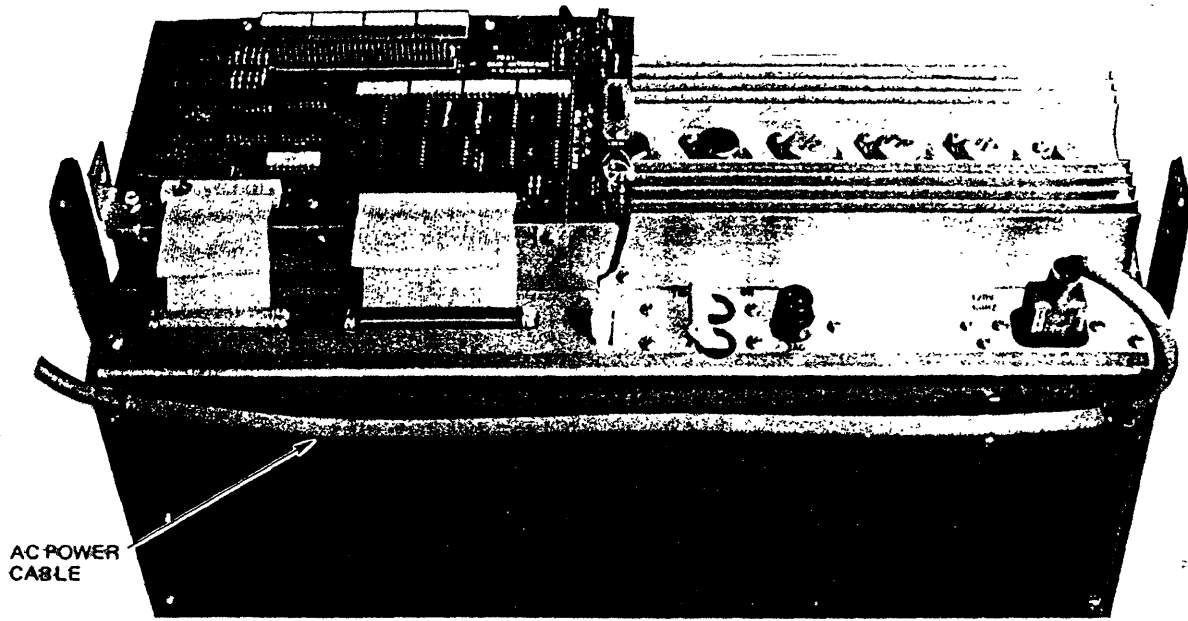

FILE 418

Figure 20-4. AC Power Cable (Disk Drive)

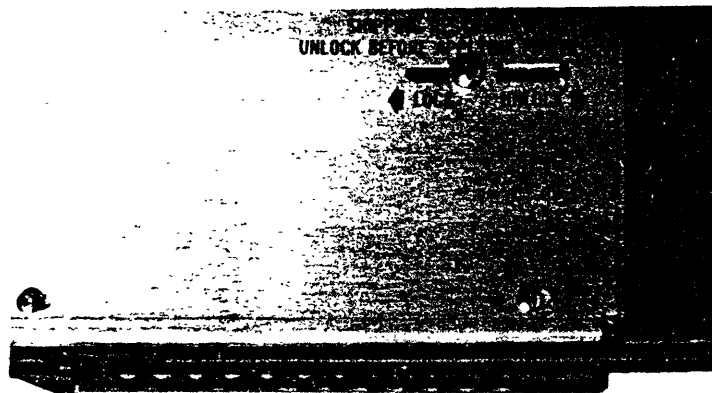

FILE 419

Figure 20-5. Spindle Lock Restraint

- n. Set the LOCAL/REMOTE switch on the SMD interface PCBA to the LOCAL position.
- o. Switch the drive AC circuit breaker to ON.
- p. Set the MCU circuit breaker to ON.
- q. Turn the MCU power key to ON.
- r. Press the white START/STOP button on the front panel of the LCD. The drive will power up and the START and SELECT lights will come on. In approximately 10 seconds the READY light will light.

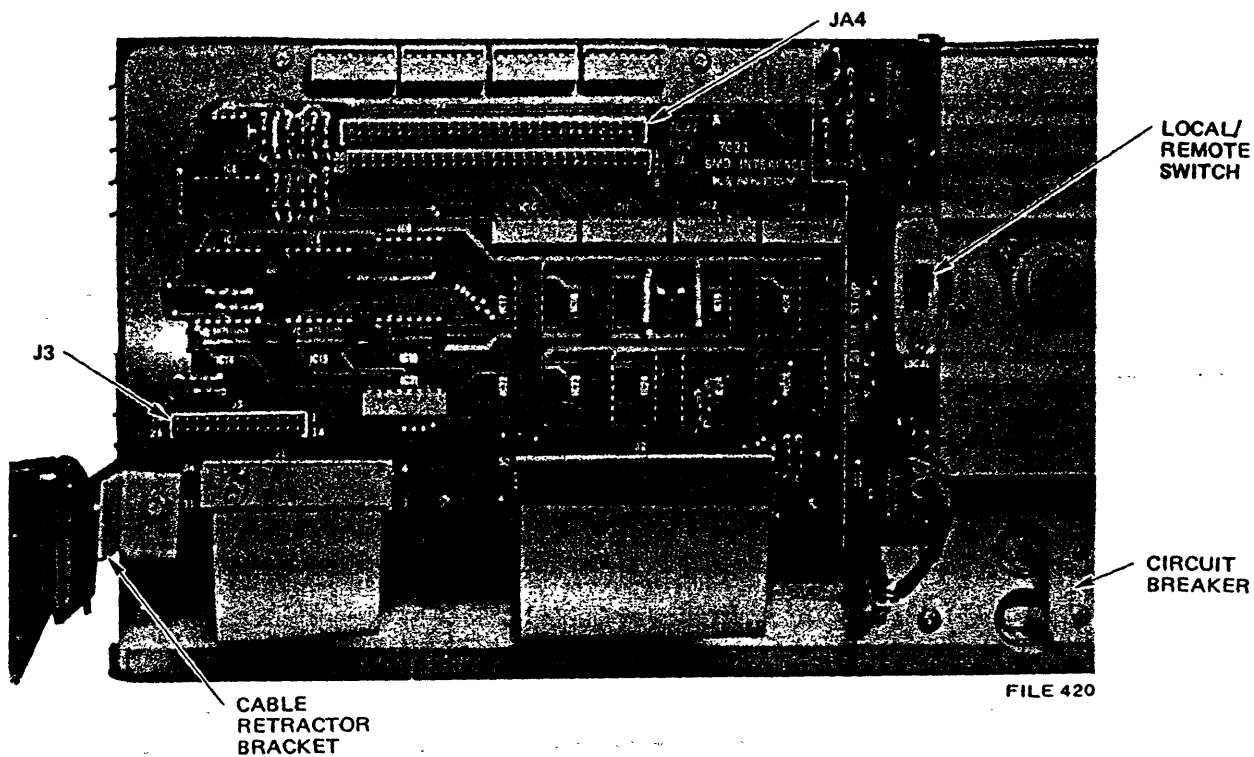

Figure 20-6. SMD Interface PCBA

20.2.4 DIAGNOSTIC CHECKOUT AND SYSGEN

- a. Load an XL40 Diagnostic Tape, Version 5.0, and perform LCD controller diagnostics (LC) and LCD drive diagnostics (LD). See Part III for diagnostic procedures.
- b. After completion of the diagnostics, press the white START/STOP button and allow at least 30 seconds for the drive to come to a complete stop.

CAUTION

Do not power down the system until the drive has come to a complete stop.

- c. Turn the MCU power key to OFF.
- d. Set the SMD interface PCBA LOCAL/REMOTE switch to REMOTE and depress the START/STOP button. This places the drive in its normal operating mode.
- e. Slide the drive into the MCU.
- f. Install the new louvered front panel.

- g. Install the new lower back panel on the rear of the MCU. This may require moving the power supply during installation.
- h. Turn the MCU power key to ON.
- i. Press the RESET and QUALIFIER buttons on the MCU control panel. The drive will power up.
- j. Load a 1.7B SMB tape and perform SYSGEN to create a 1.7B system tape. See Part III for SYSGEN procedures.
- k. If the large-capacity disk drive is a replacement unit for a D3400 or D1400 disk drive, pack all items that are to be returned (disk drive, controller, etc.) for shipment to order services.

20.3 ADJUSTMENTS

CAUTION

When performing adjustments, power down the entire system. Do not remove power from the large-capacity disk drive by turning the drive circuit breaker off. This defeats the disk braking system, greatly accelerating disk wear. The white START/STOP button is NOT an on/off switch.

20.3.1 SERVO BALANCE AND SPEED

Adjustments of the BALANCE and SPEED potentiometers should only be made if there is servo instability or slow or unequal forward and reverse servo arm movement during seek time.

- a. Power down the system.
- b. Remove the lower MCU front panel and extend the disk drive to the service position.

CAUTION

All AC power must be removed from the LCD drive prior to removing any PCBA's or damage may occur.

- c. Extend the servo PCBA using the extender card as shown in Figure 20-7.
- d. On the servo PCBA (Figure 20-8), set R32 (SPEED) fully counterclockwise and R33 (BALANCE) to its midpoint.
- e. Connect oscilloscope channel 1 to TPJ on the servo PCBA and channel 2 to pin 10 of the extender card (TRKFND). Sync on the positive edge of channel 2. Set the oscilloscope to the CHOP mode.

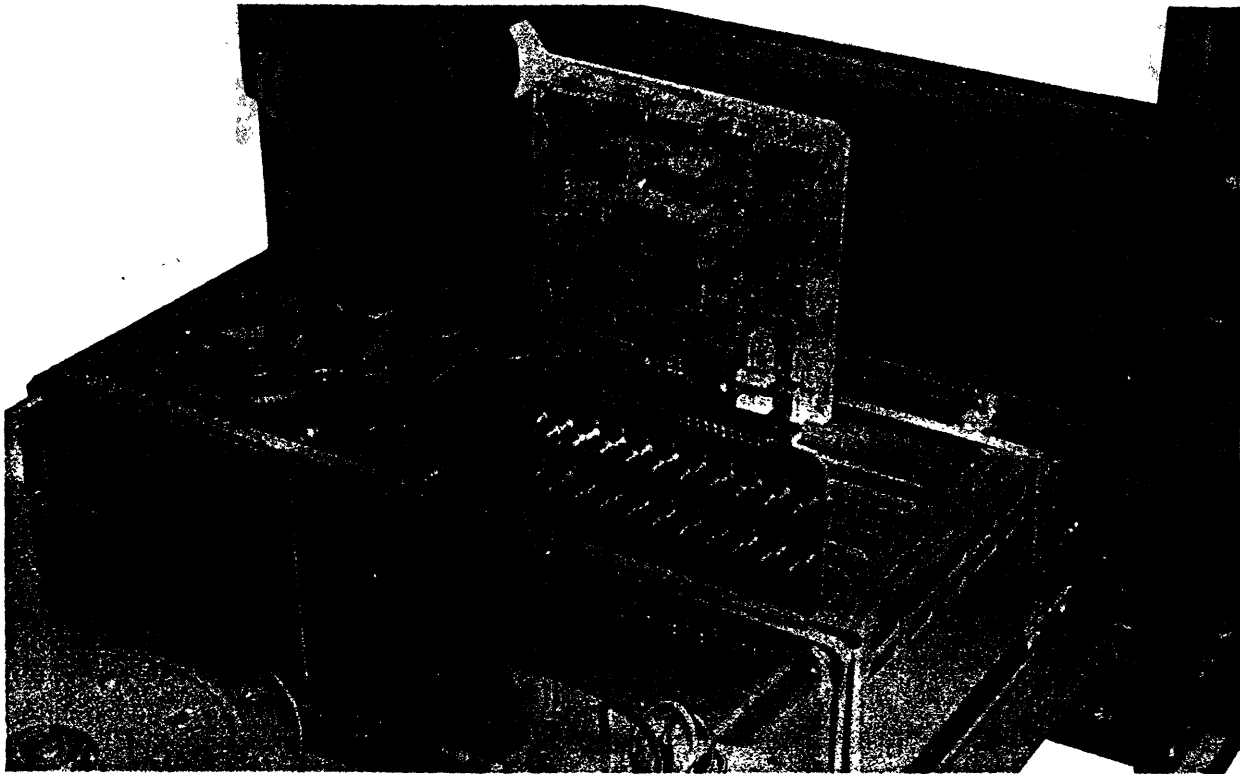
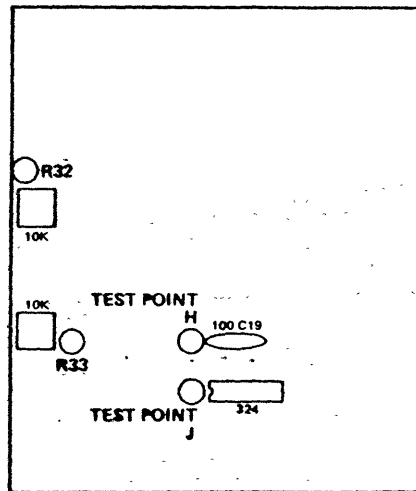

Figure 20-7. PCBA Extender Card

FILE 421



FILE 132

Figure 20-8. Servo PCBA Test Points

- f. Power up the system and execute LD Diagnostics Test 4 for a track seek.
- g. Adjust the sweep so that the inward and outward moving seek signals overlap, indicated by TRKFND (channel 2) hightimes.
- h. Adjust R33 so that the falling edges coincide within ± 5 msecs.
- i. Adjust R32 for $45 \pm$ msecs. Readjust R33 if necessary.

20.3.2 RADIAL TIMING

- a. Power down the system.
- b. Extend the drive to the service position.
- c. Extend the radial PCBA using the extender card.
- d. Set switch SW-1 on the radial PCBA (Figure 20-9) as follows: SW1-1 OFF, SW1-2 through SW1-4 ON.

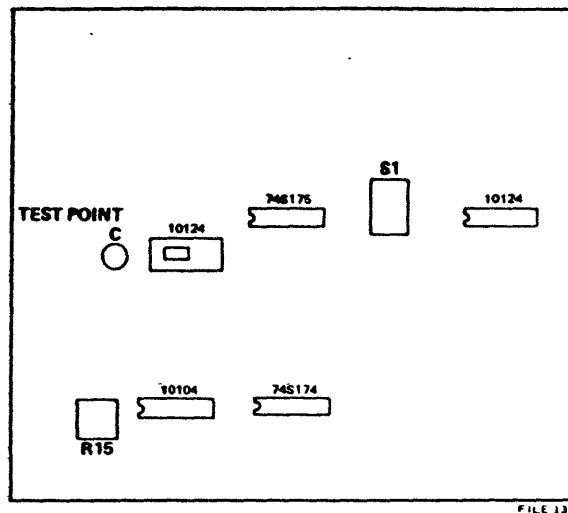

Figure 20-9. Radial PCBA Test Points

- e. Connect an X10 oscilloscope probe to TPC on the radial PCBA. Set the scope to 0.20 msec per division and trigger internally on the positive edge of the signal. Use of trigger holdoff or X10 sweep function may be necessary.
- f. Power up the system and adjust R15 so that the two positive-going edges merge into a single edge as shown in Figure 20-10.

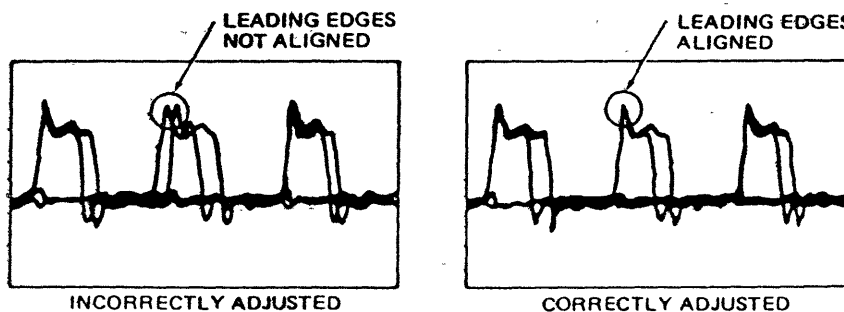

Figure 20-10. Radial Timing Adjustment

- g. When the adjustment is correct, set switch S1-1 ON and S1-2 through S1-4 OFF to resume normal operations.

20.3.3 PLO FREQUENCY

- a. Extend the drive to the service position.
- b. Power down the system.
- c. Extend the PLO PCBA using the extender card.
- d. Power up the system and execute LD Diagnostics Test 12 (see Part III).
- e. With an oscilloscope set at 100 mV per division, monitor TPJ on the PLO PCBA (Figure 20-11). Sync on INDEX (pin 7 on the extender board).
- f. With a nonmetallic tool adjust C11 until the voltage at TPJ settles to $-1.00 \pm 0.05V$.

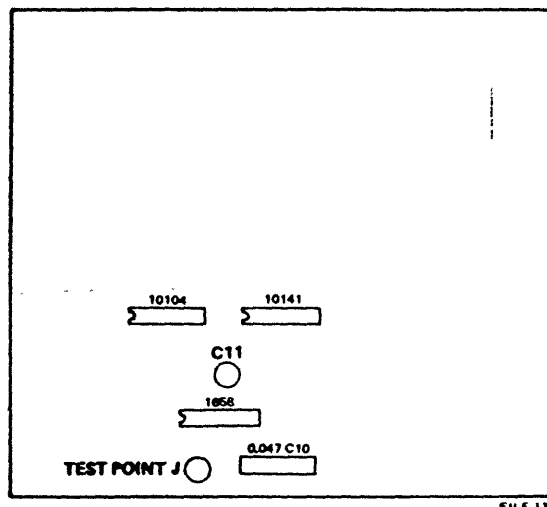

Figure 20-11. PLO PCBA Test Points

20.3.4 SPEED SENSOR

Before adjusting the speed sensor, execute LD Diagnostics Test 4. If rotation timing is not 19 msec, first check to see if a loose belt is causing slippage. If the belt is not slipping then perform the speed sensor adjustment.

- a. Power down the system.
- b. Extend the drive to the service position.
- c. Press the white START/STOP button.
- d. Turn the drive circuit breaker to OFF.
- e. Remove the cables from J3 and J4 on the SMD interface PCBA.
- f. Remove the AC power cable from the drive.
- g. Remove the cable retractor from the drive.

- h. Slide the drive out of the MCU and place it on its right side in front of the MCU.
- i. Plug the AC power cable into the drive.
- j. Set the LOCAL/REMOTE switch on the SMD interface PCBA to LOCAL.
- k. Remove the bottom cover from the drive.
- l. Monitor P2-3 of the pushbutton control PCBA with an oscilloscope set to 1 VDC per division and 1 msec per division.
- m. Set the drive circuit breaker to ON.

CAUTION

Ensure that the white START/STOP button is in the STOP position (extended).

- n. Check for a +4.5 VDC level. If the level is not +4.5 VDC proceed to step o.
- o. Loosen the speed sensor adjustment screw (Figure 20-12).

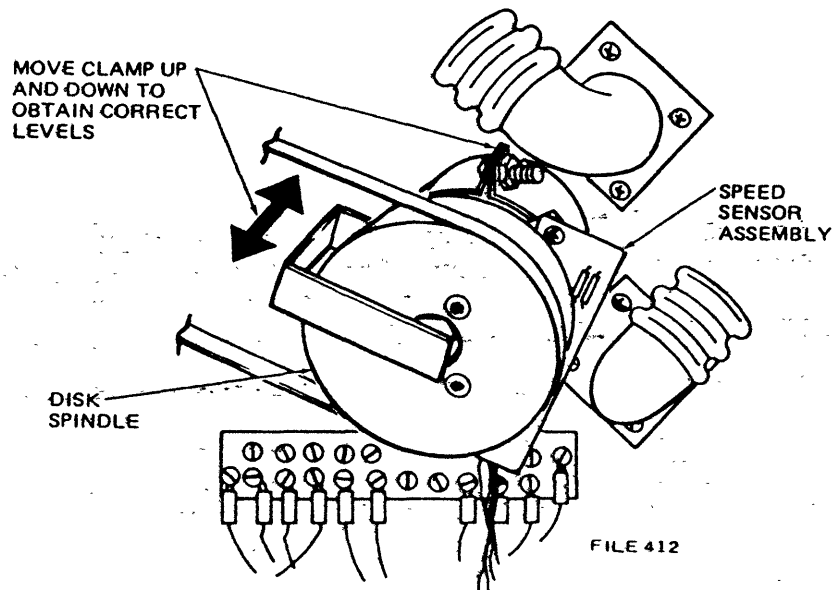

Figure 20-12. Speed Sensor

- p. Move the entire speed-sensor assembly up or down to achieve a +4.5 VDC level.
- q. Tighten the speed-sensor adjustment screw.
- r. Rotate the spindle slightly to verify that a low reading is approximately 0 ± 0.50 VDC.

- s. Press the white START/STOP button and allow approximately 10 seconds for the disk to come up to speed.
- t. A 400-Hz (2.5 msec) square wave should be displayed.
- u. Press the white START/STOP button and allow the disk to come to a halt. Set the drive circuit breaker to OFF.
- v. Place the LOCAL/REMOTE switch in the REMOTE position.
- w. Replace the drive in the MCU and replace the cables on J3 and J4A of the SMD interface PCBA and the cable retractor.
- x. Set the drive circuit breaker to ON and the START/STOP button to START and power up the system.

20.4 REMOVAL AND REPLACEMENT

20.4.1 CARD CAGE PCBA_s

Removal

- a. Power down the system.
- b. Extend the drive to the service position and switch the drive circuit breaker to OFF.
- c. Remove the desired PCBA. The locations of the PCBA_s are given in Table 20-6.

Table 20-6. Large-Capacity Disk Drive Card Cage PCBA Locations

Slot	PCBA
1 (back)	Radial PCBA
2	Busin PCBA
3	Busout PCBA
4	Fault PCBA
5	PLO PCBA
6	Data Detector PCBA
7	Seek Control PCBA
8	Servo PCBA

Replacement

Replacement of the PCBA_s is the opposite of the removal. If the busout PCBA or the radial PCBA is replaced, ensure that the switches are properly set (reference Tables 20-4 and 20-5).

20.4.2 READ/WRITE AMPLIFIER

Removal

- Power down the system.
- Extend the drive to the service position and set the drive circuit breaker to OFF.
- Remove the two screws retaining the drive right-rear side cover and remove the cover (Figure 20-13).

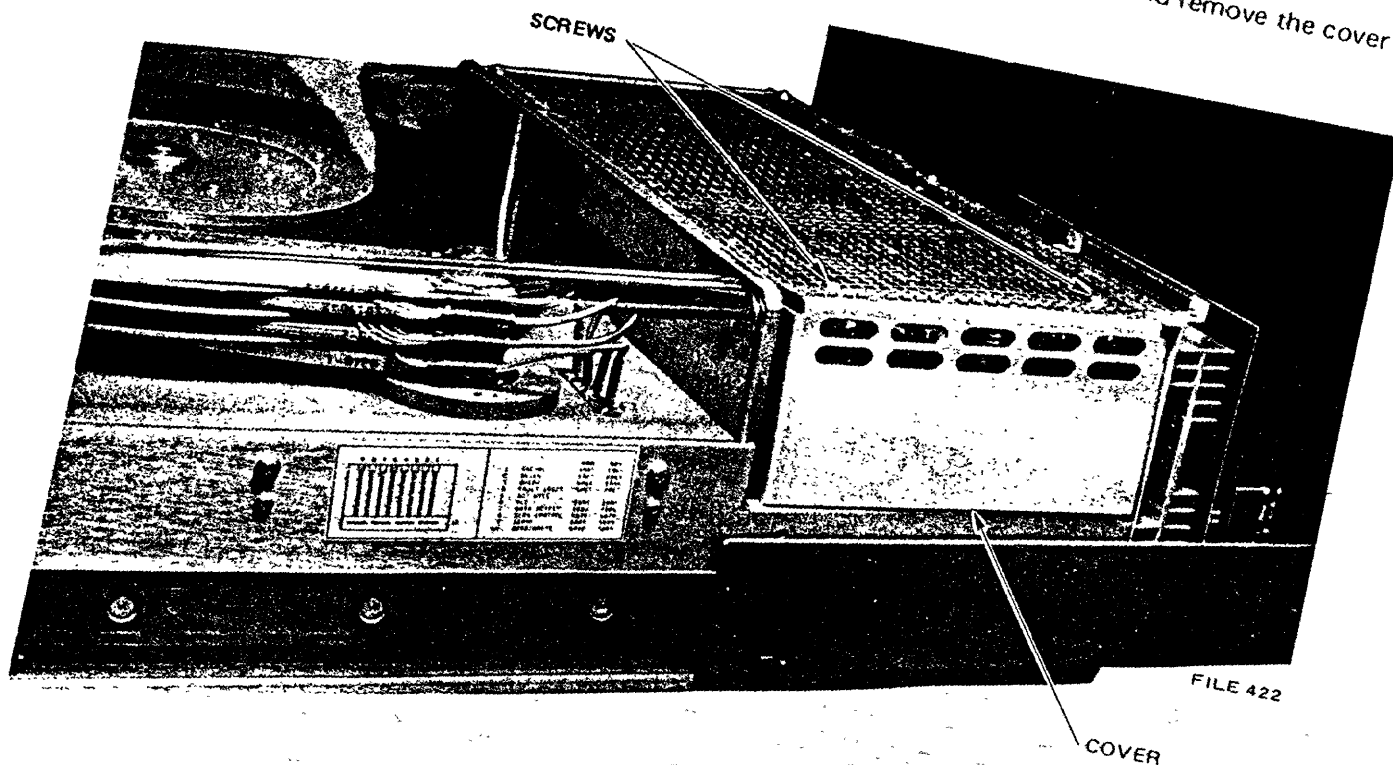

Figure 20-13. Read/Write Amplifier PCBA Access.

- Unplug P-1 from the upper front corner of the read/write amplifier PCBA.
- Remove the two screws from the top corners of the PCBA and withdraw the PCBA from the edge connectors.

Replacement

Replacement of the read/write amplifier PCBA is the reverse of the removal.

20.4.3 SMD INTERFACE PCBA

Removal

- a. Power down the system.
- b. Extend the drive to the service position and set the drive circuit breaker to OFF.
- c. Remove the signal cables from J1, J2, J3, and J4 of the SMD interface PCBA.
- d. Unplug the 4-pin molex connector from the drive.
- e. Remove the cable retractor bracket from the drive.
- f. Remove the three remaining Phillips screws mounting the PCBA to the drive and remove the SMD interface PCBA.

Replacement

Replacement of the SMD interface PCBA is the reverse of the removal.

20.4.4 SERVO HEAT SINK

Removal

- a. Remove the SMD interface PCBA (paragraph 20.5.3).
- b. Unplug the servo molex connector from the top of the power supply.
- c. Remove the six screws from the top and bottom edge of the servo heat sink and remove the heat sink.

Replacement.

Replacement of the servo heat sink is the reverse of the removal.

20.4.5 MAKEUP FILTER

CAUTION

Change the makeup filter as quickly as possible to minimize contamination.

Removal

- a. Power down the system and remove the drive from the MCU.
- b. Lay the drive on its top and remove the bottom cover.
- c. Pull the makeup filter from its holder (Figure 20-14).

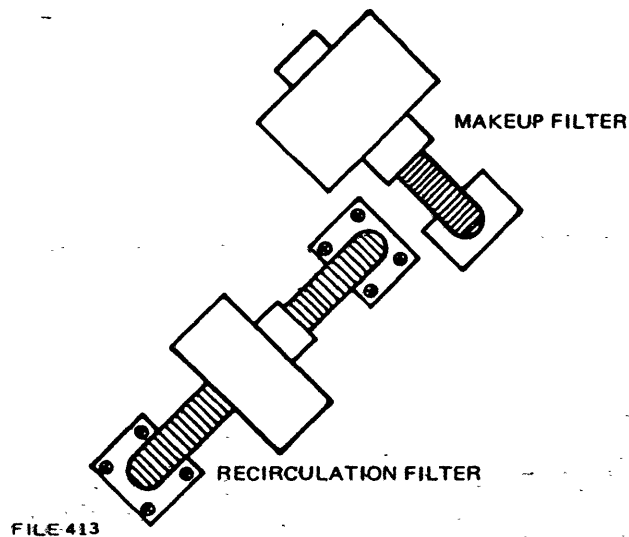

Figure 20-14. Makeup Filter Holder

- d. Cut the tie-wrap securing the filter to the plastic tubing and remove the tubing.

Replacement

- a. Apply a light coating of vacuum grease to the new filter at the tubing connection end.
- b. Slip the tube into the filter and secure it with a tie-wrap.
- c. Press the new filter into its holder.

20.4.6 DRIVE BELT

Removal

- a. Power down the system, set spindle restraint to Lock, and remove the drive from the MCU.
- b. Lay the drive on its top and remove the bottom cover.
- c. Pull the belt away from the drive while turning the spindle in a counterclockwise direction.

Replacement

Replacement of the drive belt is the reverse of the removal.

20.4.7 VELOCITY PREAMPLIFIER PCBA

Removal

- a. Power down the system and remove the drive from the MCU.
- b. Lay the drive on its top and remove the bottom cover.
- c. Remove the two large Phillips screws securing the velocity preamplifier PCBA (Figure 20-15).
- d. Remove connectors P1 and P2 from the velocity preamplifier PCBA.
- e. Remove the PCBA by lifting it straight up.

CAUTION

Do not disturb the stator position when removing the velocity preamplifier PCBA. The stator is properly positioned when the stator wires are facing the farthest side of the drive.

Replacement

Replacement of the velocity preamplifier PCBA is the reverse of the removal.

20-21

10/81

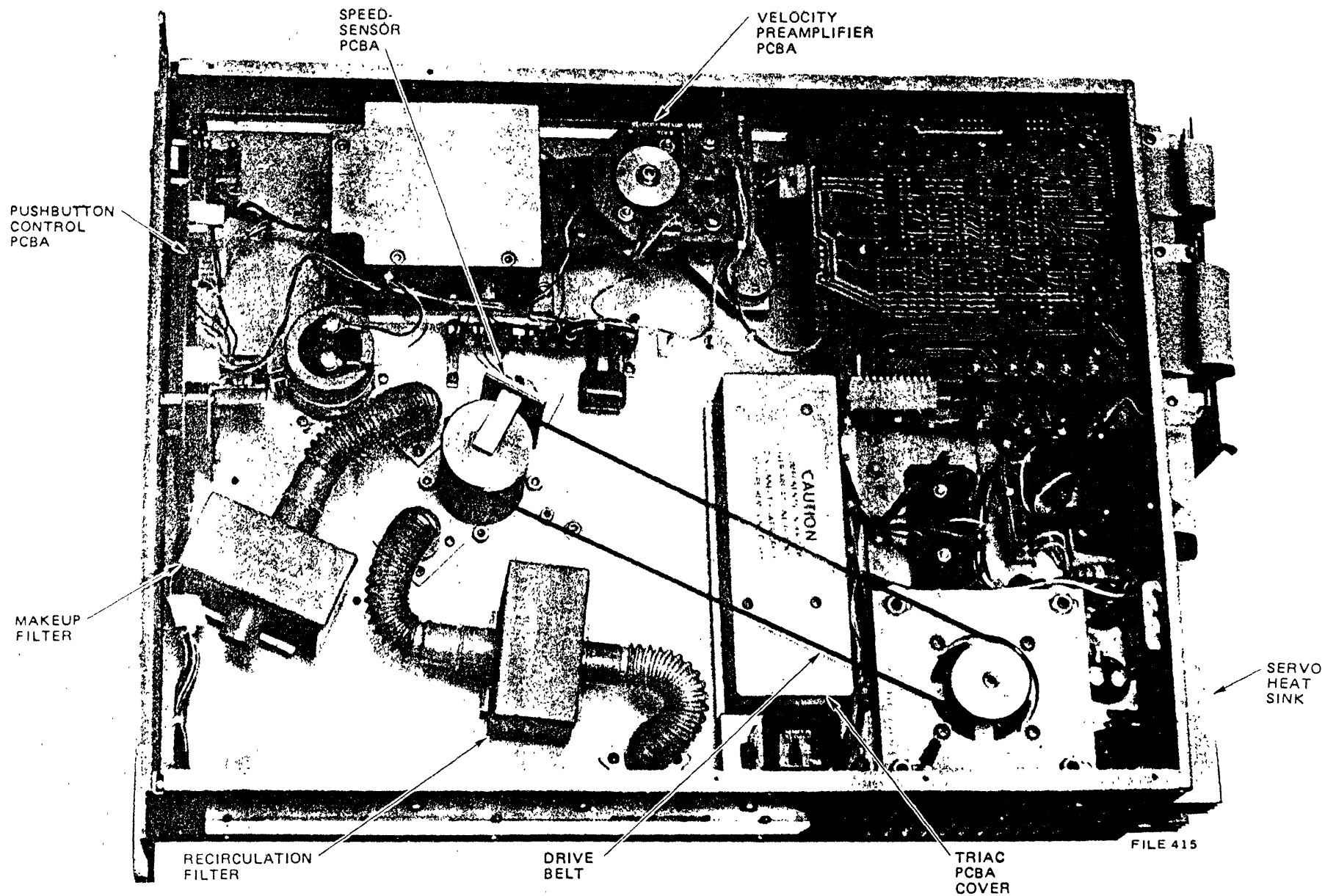

Figure 20-15. Large-Capacity Disk Drive (Bottom View)

20.4.8 SPEED-SENSOR PCBA

Removal

- a. Power down the system, set spindle restraint to Lock, and remove the drive from the MCU.
- b. Lay the drive on its top and remove the bottom cover.
- c. Remove the connector from the speed-sensor PCBA (Figure 20-15).
- d. Remove the two Phillips screws securing the PCBA.
- e. Remove the PCBA from its mounting clamp.

Replacement

Replacement of the speed-sensor PCBA is the reverse of the removal. Perform the speed-sensor adjustment given in paragraph 20.4.4.

20.4.9 TRIAC PCBA

Removal

- a. Power down the system, set spindle restraint to Lock, and remove the drive from the MCU.
- b. Lay the drive on its top and remove the bottom cover.
- c. Remove the drive belt (paragraph 20.5.6).
- d. Remove the cover from the triac PCBA (Figure 20-15).
- e. Remove all of the connecting wires from the triac PCBA. Note the location of the wires for replacement.
- f. Remove the two Phillips screws securing the triac PCBA.
- g. Turn the triac PCBA over and press the release latch on relay K1. Remove the relay.

Replacement

Replacement of the triac PCBA is the reverse of the removal.