

12PleX CD-ROM Drive Operation Manual

**Models PX-12CSi/PX-12TSi Internal
Models PX-12CSe/PX-12TSe External**

12 PLEX™



FCC NOTICE

This equipment has been tested and found to comply with the limits for a Class B digital device, pursuant to Part 15 of the FCC Rules. These limits are designed to provide reasonable protection against harmful interference in a residential installation. This equipment generates, uses, and can radiate radio frequency energy, and, if not installed and used in accordance with the instructions, may cause harmful interference to radio communications. However, there is no guarantee interference will not occur in a particular installation. If this equipment causes harmful interference to radio or television reception, which can be determined by turning the equipment off and on, the user is encouraged to try to correct the interference by one or more of the following measures:

- Reorient or relocate the receiving antenna.
- Increase the separation between the equipment and receiver.
- Connect the equipment into an outlet on a circuit different from that to which the receiver is connected.
- Consult the dealer or an experienced radio/TV technician for help.

For external Model Users: Please use the external shielded SCSI cables supplied with this CD-ROM drive. Using other signal cables may exceed the limits of the Class B Part 15 of the FCC Rules.

Any changes or modifications should be approved by the party responsible for compliance of FCC Rules; otherwise, the user loses authority to operate the equipment.

CAUTION

Use of controls or adjustments or performance of procedures other than those specified herein may result in hazardous radiation exposure.

The laser beam emitted from the optical pickup is invisible. Accordingly:

- **Do not open the optical pickup housing.**
- **Obtain service only from Plextor-authorized personnel.**

CAUTION

To disconnect the CD-ROM drive from an electrical current, pull out the power plug.

VORSICHT

DIE TRENNUNG VOM NETZ ERFOLGTT DURCH ZIEHEN DES NETZSECKES.

Zur Einhaltung der Funk-Entstörung von nicht selbständig betreibbaren Hochfrequenzgeräten (periphere Anlagenkomponenten).

Dieses Gerät entspricht als Einzelgerät den Funk-Entstöranforderungen der Postverfügung Nr. 243/1991. Wird das Gerät innerhalb einer Anlage zusammen mit anderen Geräten betrieben. So muß bei Inanspruchnahme der "Allgemeinen (Betriebs-) genehmigung" nach der BMPT-AmtsblVfg Nr. 243/1991 die gesamte Anlage folgenden Richtlinien entsprechen:



ÜG-Vfg.243

- Grenzwertklases B der EN55022
- Auflagen nach § 2 der BMPT-AmtsblVfg 243/1991

Dies ist bei der Zusammensetzung einer Anlage (z.B. Computersystem) aus nur einzeln geprüften Geräten nicht immer erfüllt.

CD-ROM DRIVE

12 PLEX™

Caddy

PX-12CSi Internal

PX-12CSe External

Tray

PX-12TSi Internal

PX-12TSe External



Plextor reserves the right to make improvements in the products described in this manual at any time without prior notice.

Plextor makes no representation or warranties with respect to the contents hereof and specifically disclaims any implied warranties of merchantability or fitness for any particular purpose. Further, Plextor Corp. reserves the right to revise this manual and to make changes in its content without obligation to notify any person or organization of such revision or change.

This manual is copyrighted, all rights reserved. It may not be copied, photocopied, translated, or reduced to any electronic medium or machine-readable form without Plextor's prior permission.

Manual copyright © 1997 Plextor Corp. Third edition, February 1997.

Licenses and Trademarks

All licenses and trademarks are property of their respective owners.

Table of Contents

1. Introduction	1
2. Box Contents	3
Internal Drives	4
External Drives	5
A Gentle Reminder	6
3. What Else Do I Need?	7
4. Precautions	9
5. Drive Features	10
PX-12CS Caddy Drive (Internal and External)	
Front Panel	10
PX-12TS Tray Drive (Internal and External)	
Front Panel	11
PX-12CSI and PX-12TSI (Internal Drive)	
Rear Panel	12
PX-12CS _e and PX-12TS _e (External Drive)	
Rear Panel	13
6. Drive Switch/Jumper/Dial Settings	14
PX-12XS Internal Drive	15
SCSI ID Number	16
PX-12XS _e External Drive	17
SCSI ID Number	17
Other Switch Settings	18
7. Termination	19
PX-12XS Internal Termination	20
PX-12XS _e External Termination	20

8. Hardware Installation	21
Board Installation	22
Drive Positioning	25
Mounting an Internal Drive	26
External Drive Installation	30
Soundboard Installation	33
Audio Cables	34
9. Software Installation	36
FWB Toolkit for Macintosh	37
OS2	38
Windows NT 3.51 (and Below)	39
10. Using CD-ROM Discs, Caddies, and Trays	41
Caddy Loading	41
Inserting the Disc into a Caddy	41
Loading the Caddy into the Drive	43
Removing the Caddy from the Drive	43
Tray Loading and Operation	43
Cleaning the Disc	44
11. How to Play Audio CDs on Your Drive	45
12. Troubleshooting	48
13. Contacting Plextor's Technical Support Department	63
How to Contact	64
Before You Call/FAX/Log On	64
Returns	65
Helpful Contact Phone/FAX/BBS Numbers	65
14. Specifications	66
About Plextor	68
Warranty Information	inside back cover

Introduction

Thank you for purchasing a Plextor 12PleX, the first twelve speed CD-ROM drive with professional quality specifications. The 12PleX is also the first twelve speed CD-ROM drive able to self-configure SCSI IDs (when purchased in kit form with a SCSI interface board or otherwise connected to a SCAM compliant SCSI interface board). We will discuss this capability in more detail in Chapter 6. The 12PleX is the first Plextor CD-ROM drive released as both a tray version and caddy loading version.

Throughout the rest of this manual we will use the following model numbers when necessary to distinguish between internal and external drives, as well as tray and caddy loading mechanisms:

PX-12CSI (Internal caddy drive)
PX-12CSe (External caddy drive)
PX-12TSI (Internal tray drive)
PX-12TSe (External tray drive)

If we drop the “i” and “e” from the model number, it means the topic applies to both internal and external drives. If we replace the “C” or “T” with an “X,” it means the topic applies to both the caddy and tray versions of the drive. Finally, if we use PX-12XS as the model number, or simply say 12PleX, it means the topic applies to all versions of the 12PleX.

We appreciate the confidence you have shown in us. Our goal is to put you—and keep you—on the leading edge of CD-ROM drive performance. To get you there, we first have to help you install your 12PleX drive properly and operate it correctly. After that the responsibility is yours to discover the applications that make a CD-ROM drive such a powerful and exciting addition to your system.

This manual is designed to be followed in sequence. It is aimed primarily at those who will connect their 12PleX drive to a PC.

Mac users should look for this symbol:



Users of UNIX-based systems should look for this symbol:  as an indicator of sections of the manual that pertain to them.

Many of you reading this manual are experienced computer users who have successfully installed peripherals in the past. There probably are a number of sections in this manual that you can skip over. However, we ask everyone—from novice computer users to experienced computer professionals—to read the sections marked with this symbol:



For those of you with PCs, the installation process may seem a bit complicated. Windows95 has improved things a little bit. Mac people have it easy. But no one should worry. Our manuals have successfully walked many thousands of customers through the installation process, including those who previously had lived in mortal terror of the innards of their computers. Plus, our Technical Support Department is just a phone call or e-mail message away.

In this manual you should find all the information you need to successfully install and operate your drive. If you run into a problem, however, please contact us (see Chapter 13 for the different ways you can contact us). The call is toll-free at our 800 number or through e-mail or our Web site. You will be connected to our friendly, helpful band of tech support reps who know their stuff about CD-ROM drives. What might seem like a lost cause to you could very well be a 30-second fix to them. But we will never know unless you CALL US. If you are having trouble, please don't give up, and don't take your drive back to where you bought it until you have spoken with one of our tech support reps.



Box Contents

-
- YOUR TASK:** Check the contents of the box.
- YOUR OBJECTIVE:** Make sure you got everything you paid for.
- YOUR METHOD:** Compare what you find in the box with the tables on the following pages.
-

What you should find in your Plextor box depends on two factors: 1) what configuration you purchased; and 2) what the company that sold you the box put in—or took out—while it was in their possession.

Plextor currently sells its 12PleX drives in three configurations:

- 1) Drive Only
- 2) Drive with SCSI Interface Kit
- 3) Drive with Mac Kit

The configuration you received is indicated by stickers applied to your box.

Your drive may also have been integrated into a computer system or subsystem sold by a third party.

PLEASE NOTE: A security sticker was applied to the top of your box. The contents of your box were carefully checked before this sticker was applied. If it was cut before you purchased the box, you should carefully check the contents to ensure nothing has been removed. If something is missing, you should contact the party from whom you purchased the box for an explanation.







There may be a perfectly good reason why the security sticker on the box was cut before you received it. For example, a dealer may have purchased a “Drive Only” configuration from Plextor, then added a SCSI interface board and/or software he had purchased separately before selling the box to you.

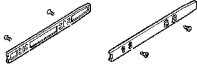

NOTE: If your drive came pre-installed in a computer, the rails, cables, interface boards, and other parts shown on the following pages may have been installed and may not be separately available.

Use the following tables to check the contents of your box:

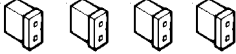
12PleX Internal Drives

	DRIVE ONLY	DRIVE w/ SCSI Interface
CD-ROM drive  (Caddy)  (Tray)	X	X
Side rails with 4 chrome and 4 black screws 	X	X
Caddy (PX-12CS only) 	X	X
Plextor Manager floppy disk	X	X
SCSI interface board & installation guide		X
Audio cable	X (2)	X (2)
SCSI cable 	X	X
Plextor operation manual	X	X
Warranty registration card	X	X
Extra jumpers for setting drive switches 	X	X

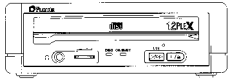
12PleX External Drives

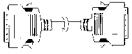
	DRIVE ONLY	DRIVE w/ SCSI Interface	DRIVE w/ Mac Kit
CD-ROM drive  (Caddy)  (Tray)	X	X	X
Caddy (PX-12CSe only) 	X	X	X
Plextor Manager floppy disk	X	X	
SCSI interface board & installation guide		X	
Audio cable	X	X	X
SCSI cable 	X	X	X
Plextor operation manual	X	X	X
Warranty registration card	X	X	X
Mac device drivers manual & disk			X

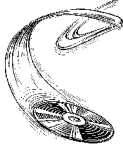

A Gentle Reminder. . .

- YOUR TASK:** Save your box (if you received one).
- YOUR OBJECTIVE:** Have a secure container in which to ship your drive back to Plextor, if necessary.
- YOUR METHOD:** Find an empty space in your home/office and fill it with the Plextor box.
-

If you received your 12PleX CD-ROM drive in a Plextor box, you should save the box after you have installed your drive. There are many sets of hands—some of them potentially unfriendly—that a drive might go through on its way from us to you. Our box and its packaging material were designed and drop-tested to ensure that your 12PleX drive can endure rough treatment and still arrive in working order.



We advise you to hold on to your box in case you should ever need to return your drive to Plextor for any reason. Unfortunately, some of our customers have not held on to their boxes and have had to resort to some less-than-secure methods to get drives back to us. We have received drives in a shoebox, in an unpadded express mail envelope, and in a box filled with buttered popcorn.

We cannot assume liability for any damage your drive sustains during shipment. Therefore, please ship your drive in the safest manner possible. We believe your drive will be most secure if it is shipped in a Plextor box. We hope you will never have to ship your drive back to us. If you do, however, we hope you will send it packaged in a Plextor box.

If you did not receive a Plextor box (if, for example, your drive came pre-installed in a computer), we recommend that you pay a packaging store (e.g., Mail Boxes Etc.) in your area to ship your drive. The drives that we have received from most packaging stores have arrived in good shape. If you don't have a packaging store in your area, call our Technical Support Department for packaging pointers before you ship your drive. In fact, you should call our Technical Support Department to get an RMA number before returning any drive (see Chapter 13, p. 65).



What Else Do I Need?

YOUR TASK: Review the software and hardware installed in your current computer system.

YOUR OBJECTIVE: Determine what else you may need to operate your CD-ROM drive.

YOUR METHOD: Inventory your current computer system; check list below.



If you are a PC owner and you purchased a Plextor box labeled “Drive with SCSI Interface Kit,” your needs are simple: none. The same holds true if you are a Mac owner and purchased a Plextor box labeled “Drive with Mac Kit.” Everything you need to successfully install and operate your 12PleX CD-ROM drive is included in the box you purchased. The only thing you need to add is a CD-ROM disc to play in your new drive.

If you are a PC owner who has purchased a 12PleX “Drive Only” box, life gets a bit more complicated. You fall into one of three groups:

1) **You do not own a SCSI interface board.**

In this case, you have to get one. Your local computer store and numerous mail-order vendors carry them. Call us if you need suggestions on which model to buy. We have provided an internal SCSI ribbon cable or an external SCSI cable to connect the board to your new 12PleX CD-ROM drive.

2) **You own a SCSI interface board.**

If you have only one other internal SCSI peripheral device and a Plextor internal CD-ROM drive, you can use the SCSI ribbon cable we provided. If you have more than one other internal SCSI peripheral, you will need to purchase a different SCSI ribbon cable from your local computer supply store. The cable must have at least as many connectors as you have internal SCSI peripherals (including one for your Plextor CD-ROM drive), plus one additional connector to attach to the interface board.

If you have an external Plextor CD-ROM drive, you will be able to include it in your daisy chain of other external SCSI peripherals with the cable we have provided (if at least one of your other peripherals has the same kind of 50-pin, high-density SCSI connectors as your Plextor drive). Be sure to read the section on “Termination” in Chapter 7 of this manual.

If you purchased your SCSI interface board several months or years before you purchased your 12PleX drive, you may need to update your device drivers. See the discussion about device drivers in Chapter 9 of this manual.

3) **You own a soundboard that has a SCSI interface built into it (e.g., Sound Blaster SCSI II).**

You may need to use the SCSI cable and, most important, the audio cable we have included with your 12PleX (see page 34 for a discussion on audio cables). If you have an external drive, you will also need a special bracket connector and an internal SCSI cable. These should have been provided by the soundboard manufacturer. They allow the internal SCSI connector on your soundboard to be linked or connected to your external drive. If they were not provided by your soundboard manufacturer, you will need to purchase them from a local computer supply store.

You may also need to update your device drivers. See the discussion about device drivers in Chapter 9 of this manual.

Once you have assembled everything you need, you're ready to install your drive. But first, a few words of caution are in order.



Precautions

YOUR TASK: Read the list of precautions below.



YOUR OBJECTIVE: Avoid any undo harm coming to you or your drive.

YOUR METHOD: Review the list and use common sense.

Your new CD-ROM drive is a precision electromechanical device. Like the rest of your computer system, it requires reasonable care in its installation and use.

Please read this manual carefully and keep it handy for easy reference. Use this manual for installation, operation, and troubleshooting. See your dealer, or call Plextor's Technical Support Department, should your drive require repair or service.

- X Do not put your computer monitor (or any other device weighing more than 30 lbs.) on top of the 12PleX external drive.
- X Do not place your drive in direct sunlight, on heating units, or near electrical appliances that draw large amounts of current, such as a high-powered audio amplifier, microwave oven, toaster, hair dryer, etc.
- ✓ Keep the area around your drive clean from dust, smoke, and other contaminants.
- ✓ Use a soft, dust-free cloth for cleaning your drive. Do not allow moisture or liquids such as water, cleaning fluids, or solvents to touch the drive. Thinner, benzene, or alcohol-based solvents can mar your drive's surface.
- ✓ To help ensure that your CD-ROM discs remain free of dirt or other contaminants, they should be stored in either a caddy or jewel case. Use only an industry standard disc or caddy. Do not insert a warped or cracked disc or caddy into the drive.
- ✓ Keep your CD-ROM disc clean. See Chapter 10 for tips on handling and cleaning CD-ROM discs.
- X Do not drop or jolt the drive.
- X Do not attempt to open the drive and service it yourself. Removing the cover may expose you to harmful electrical voltages or the laser beam. For your safety, entrust service to Plextor-authorized service personnel only.



Drive Features

YOUR TASK: Get to know your drive.

YOUR OBJECTIVE: Learn how to operate different features of the drive. Learn what goes where. Learn some terms that will be used elsewhere in the manual.

YOUR METHOD: Match the parts of your drive to the diagrams below.

PX-12CS Caddy Drive—FRONT PANEL (Internal and External)

Door Closed

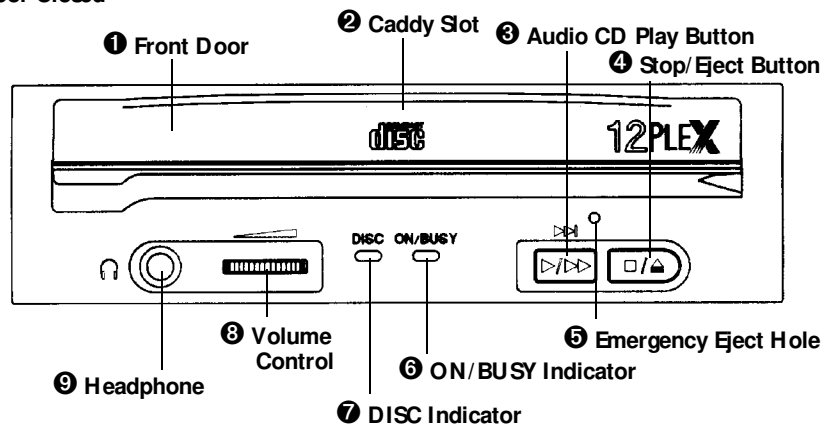

1 Front Door: Open to insert caddy.

2 Caddy Slot: Insert caddy after opening door.

3 Audio CD Play Button: Push to put drive in Audio CD play mode. Push button once during CD play mode to skip. Push and hold down play button more than one second to fast forward.

4 Stop/Eject Button: Push to eject caddy. During Audio CD play mode, however, push once to stop audio play and twice to eject caddy.

5 Emergency Eject Hole: Insert paper clip, or other thin, rigid object to eject caddy if automatic eject button **4** does not work. Turn off power before using this feature.

- ⑥ **ON/BUSY Indicator:** Yellow when power is on. Flashing when disc is inserted and being accessed. Off when disc is inserted and not being accessed.
- ⑦ **DISC Indicator:** Green when power is on and disc is inserted. Off if no disc is inserted.
- ⑧ **Volume Control:** Controls volume of headphone jack. This control has no effect on the rear panel audio outputs.
- ⑨ **Headphone Jack:** Stereo mini-jack for headphones and powered speakers.

PX-12TS Tray Drive—FRONT PANEL (Internal and External)

Door Closed

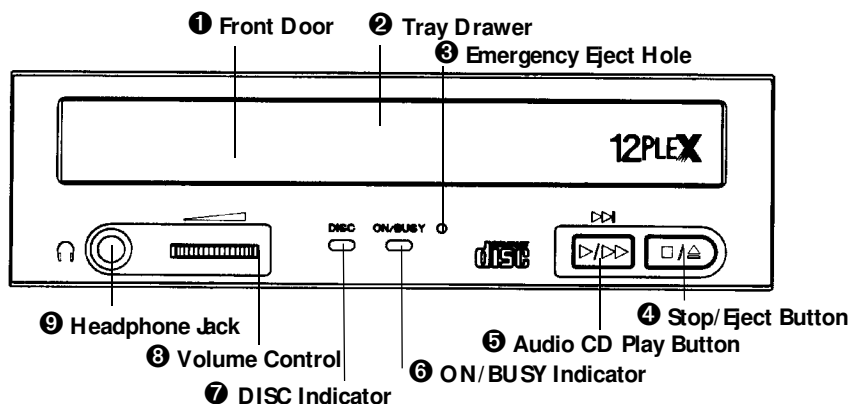

- ① **Front Door:** Press eject button to open and insert disc.
- ② **Tray Drawer:** Insert disc after opening tray drawer. Press eject button to close.
- ③ **Emergency Eject Hole:** Insert paper clip, or other thin, rigid object to eject caddy if automatic eject button ④ does not work. Turn off power before using this feature.
- ④ **Stop/Eject Button:** Push to eject caddy. During Audio CD play mode, however, push once to stop audio play and twice to eject caddy.
- ⑤ **Audio CD Play Button:** Push to put drive in Audio CD play mode. Push button once during CD play mode to skip. Push and hold down play button more than one second to fast forward.
- ⑥ **ON/BUSY Indicator:** Yellow when power is turned on. Flashing when disc is inserted and being accessed. Off when disc is inserted and not being accessed.

⑦ **DISC Indicator:** Green when power is on and disc is inserted. Off if no disc is inserted.

⑧ **Volume Control:** Controls volume of headphone jack. This control has no effect on the rear-panel audio outputs.

⑨ **Headphone Jack:** Stereo mini-jack for headphones and powered speakers.

PX-12CSi Internal Caddy Drive—REAR PANEL PX-12TSi Internal Tray Drive—REAR PANEL

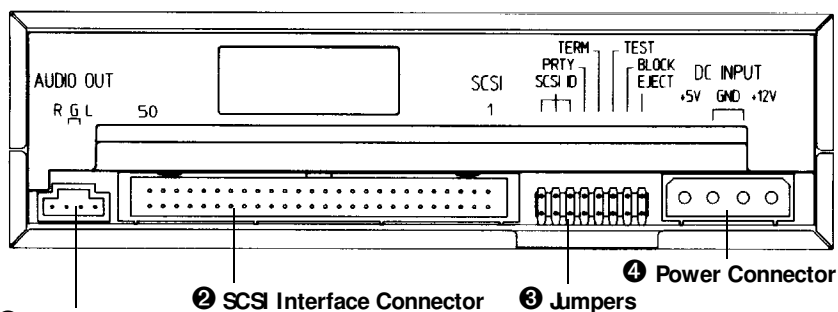

① **Audio Output Connector**

① **Audio Output Connector:** Outputs stereo analog signal. Use to connect to sound-board or audio amplifier.

② **SCSI Interface Connector:** Connects to SCSI interface board using 50-pin to 50-pin flat ribbon SCSI cable.

③ **Jumpers:** Use to select SCSI ID number, parity, termination, test, block size, and eject lock options. Leave these jumpers at their factory settings unless one or more of the following situations pertain to you:

SCSI ID number: If you are using more than one SCSI peripheral, you may have to change your SCSI ID number, see page 16.

Termination: Review Chapter 7 to determine if you need to turn your terminator switch off.



Block size: If you are working in a UNIX environment and want to boot from your CD-ROM drive, see page 18.

Eject lock: If you work in an environment where you need to prevent others from easily removing a CD-ROM disc from your drive, see page 18.

④ **Power Connector:** Connects to your computer's power supply (DC +5V and +12V).

PX-12CSe External Caddy Drive—REAR PANEL PX-12TSe External Tray Drive—REAR PANEL

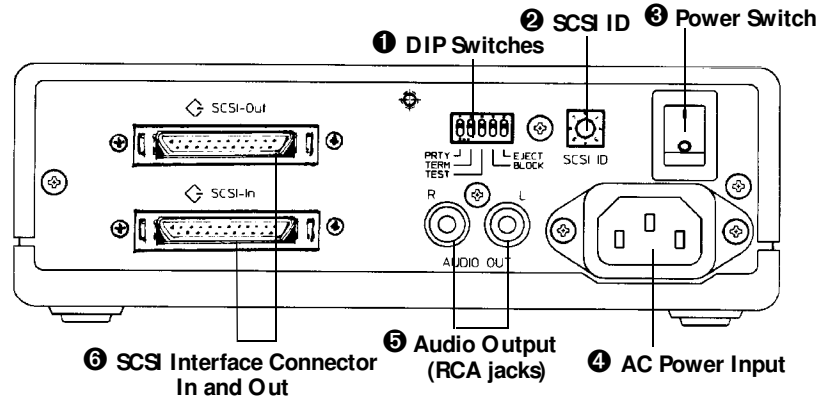

1 DIP Switches: Use to set parity, term, test, block size, and eject lock options. Leave these switches at their factory settings unless either, or both, of the following situations pertain to you:

Termination: Review Chapter 7 to determine if you need to turn your terminator switch off.



Block size: If you are working in a UNIX environment and want to boot from your CD-ROM drive, see page 18.

Eject Lock: If you work in an environment where you need to prevent others from removing a CD-ROM disc from your drive, see page 18.

2 SCSI ID: Use this dial to designate SCSI ID number. Rotate the dial to change the number. If you are using more than one SCSI peripheral, you may need to change your SCSI ID number (see pages 16 and 17).

3 Power Switch: To turn power ON/OFF.

4 AC Power Input: Use the power cord supplied with your drive.

5 Audio Output: Outputs stereo analog signal via RCA jacks. Use to connect to audio amplifier or other audio equipment.

6 SCSI Interface Connector In and Out: One connector should be used to link your CD-ROM drive to your SCSI host adapter; the other, to link your CD-ROM drive to another SCSI peripheral with a daisy chain cable (see page 32). You may use either connector for either purpose.

Drive Switch/ Jumper/Dial Settings



YOUR TASK: Find the location of jumpers (internal drive) or switches and rotary dial (external drive). Check their settings. Change them if necessary.

YOUR OBJECTIVE: To ensure that your new CD-ROM drive can coexist peacefully with other equipment you might have installed in your computer. To ensure that your drive will work properly after it is installed.

YOUR METHOD: Find locations of jumpers/switches/rotary dial on diagram in Chapter 5. Read below to determine if your drive's settings need to be changed. If so, follow the directions on making the necessary changes.

Your 12PleX CD-ROM drive needs to be flexible enough to work with the variety of computer systems (PC, Mac, Sun, Silicon Graphics, DEC, etc.) that can use SCSI peripherals. To provide this flexibility, Plextor gives its customers options on how a drive can be set before it is installed. On an internal drive, settings are determined by the position of jumpers on the jumper block at the rear of the drive. On an external drive, settings are determined by the position of DIP switches and the rotary dial on the rear panel of the drive.

NOTE: Silicon Graphics computers are somewhat proprietary, and historically you needed to buy a Silicon Graphics CD-ROM drive. Now you can purchase kits from Plextor that are specially configured for SGI.

Fortunately, we have a pretty good idea of the environment in which most of our drives will be used (a single SCSI device connected to a PC or Mac). Your drive ships from our factory with its jumpers/switches/dial set to work in this environment.

You should leave the jumpers found on the rear panel of the PX-12XS_i and the switches and rotary dial found on the rear panel of the PX-12XS_e at their factory settings unless: 1) you plan to use another SCSI peripheral (e.g., hard disk, scanner) attached to the same SCSI adapter, in addition to your CD-ROM drive; 2) you work in a UNIX environment and want to boot from your CD-ROM drive; 3) you want to utilize the Eject Lock feature. If you plan to use additional SCSI peripherals, you may need to change the jumper/switch/dial settings of the 12PleX. This section will further describe how to make these changes. For more information on #2 and #3, see page 18.



If the CD-ROM drive is the only SCSI peripheral you will use with your computer, you do not need to boot from the CD-ROM drive in a UNIX environment, and if you do not plan to use the Eject Lock feature, skip now to Chapter 8, Hardware Installation. (Take our word for it, most of you can now skip to Chapter 8.)

PX-12XS_i Internal Drive

Factory Setting of Jumper Block

The functions shown are ON if the jumpers are installed and OFF if jumpers are removed. The jumpers are set by the factory as follows:

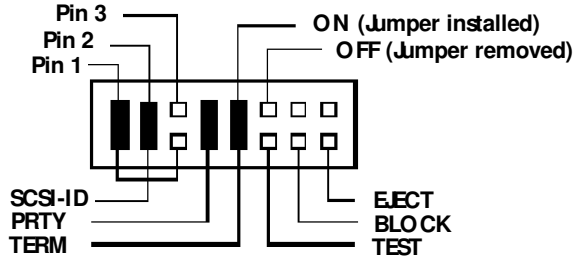

Installing and Removing Jumpers

Ensure power to the drive is OFF before installing or removing jumpers.

To remove a jumper, pull it off with your fingers or a pair of needle-nose pliers.

To add a jumper, push it onto the jumper pins. Three extra jumpers are supplied with the PX-12XS_i in addition to the four jumpers already installed at the factory.

Caution: Install jumpers **across** each pin as shown. Do **not** connect one pin switch to another by installing the jumpers lengthwise. Doing so could result in damage to the drive.

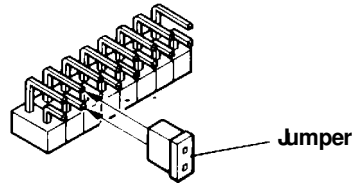

Install Jumpers This Way



Do **NOT** Install Jumpers This Way

SCSI ID Number

It is possible to chain (using a daisy chain cable) up to seven SCSI peripherals to a single SCSI interface board, or to the SCSI port of an Apple computer. When using multiple SCSI peripherals, however, it is necessary to set each peripheral to a unique SCSI ID number.



Your Plextor CD-ROM drive can be set to use one of eight SCSI ID numbers. The drive should arrive with its SCSI ID set to 3. Accordingly, if you already use another SCSI peripheral, and its SCSI ID also is set to 3, you must change the SCSI ID number of either this peripheral or that of the CD-ROM drive. In the past this always had to be done manually. If you connect your 12PiX to an existing SCSI controller, you will still need to go through this exercise of checking and possibly changing SCSI IDs. If, instead, you bought a Plextor kit with a SCSI interface board, both the drive and the board are SCAM* compliant. Each time you turn on your computer, the drive will internally reset its SCSI ID to avoid any conflict. If you separately purchased or already owned a SCSI interface board, it is probably **not** SCAM compliant.

Changing the SCSI ID: PX-12XS

The SCSI ID number of the PX-12XS is determined by the placement of jumpers on pins 1, 2, and 3. To find the location of pin 1, pin 2, and pin 3, refer to the diagram of the Jumper Block on the previous page. To change the SCSI ID number, follow the chart below.

SCSI ID Number	Jumper Installed Across		
	Pin 1	Pin 2	Pin 3
0	No	No	No
1	YES	No	No
2	No	YES	No
Factory Settings 3	YES	YES	No
4	No	No	YES
5	YES	No	YES
6	No	YES	YES
7	YES	YES	YES

* SCAM stands for SCSI Configured Auto Magically

For example, the factory setting of the SCSI ID at 3 is made by installing a jumper on pin 1 and pin 2 of the jumper block, leaving pin 3 uncovered. To set the SCSI ID at 7, you would install a jumper across pin 1, another jumper across pin 2, and a third jumper across pin 3. To set the SCSI ID at 5, you would install a jumper across pin 1 and a jumper across pin 3, leaving pin 2 uncovered.

PX-12XSe External Drive

SCSI ID Number

Please see explanation at the top of page 16. It is also applicable to the external drive.

Factory Setting of Dial and DIP Switches

Caution: Turn the drive's power OFF before changing the setting of the dial or DIP switches.

The SCSI ID number of the PX-12XSe is determined by the position of the pointer on the SCSI ID rotary dial. The drive should arrive with its SCSI ID set to 3. The rotary dial and DIP switches are set by the factory as shown below:

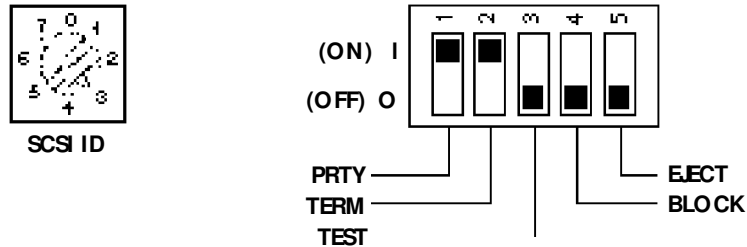

Changing the SCSI ID

Using the blade of a screwdriver, rotate the dial's arrow to a different SCSI ID number.

Changing DIP Switch Settings

Use a screwdriver, pen, or paper clip to push the DIP switches to an OFF or ON setting.

Other Switch/ Jumper Settings—12PleX

The remaining switches (external drives) and jumpers (internal drives) are:

- Parity** Leave this ON. The parity check provided by the ON setting enhances the reliability of the SCSI bus. Set to OFF only if your computer system or SCSI controller specifically requests that parity be disabled.
- Term** This enables or disables (turns ON or OFF) SCSI termination. Factory setting is Enabled (ON). See page 19 for an explanation of SCSI termination and to determine if you need to change this setting.
- Test** Leave this OFF. It is for factory use only.
- Block** Leave this OFF, unless you are working in a UNIX environment and want to boot from your CD-ROM drive. If so, set this switch/jumper ON. 
- Eject** In most situations, you will want to leave this switch/jumper OFF.

However, if you are in an environment where you want to prevent others from borrowing or stealing the disc inserted in your drive (e.g., the drive is located in a public place where multiple users have unlimited access), you can activate the Eject Lock feature. To do so, set this switch/jumper ON.

When this switch/jumper is ON, it is impossible to eject a disc inserted in the drive by pressing the Eject button. A software eject command must be issued for the disc to eject from the drive. Check your device driver manual for instructions on how to issue a software eject command.



Termination

YOUR TASK: Find the location of the SCSI termination jumper or switch.

YOUR OBJECTIVE: Determine if you must disable the SCSI termination.

YOUR METHOD: Your drive was shipped with termination enabled. If necessary, remove termination jumper or turn off SCSI termination DIP switch by following instructions below.

You must enable SCSI termination if the 12PleX is the only SCSI peripheral used with your computer. In addition, you must enable termination if you are using multiple SCSI peripherals with your computer, and the 12PleX is positioned as the **last** peripheral in a daisy chain.

If you have internal SCSI peripherals only, or external SCSI peripherals only (but not both), then you should be using an internal ribbon cable or daisy chained external cables, respectively (but not both). In this case, all devices between the host adapter and the last peripheral on the opposite end of the ribbon cable, or the last peripheral at the end of your daisy chain, should have their termination removed, disabled, or turned off.

If you have both internal and external SCSI peripherals (both the internal and external connectors of your host adapter are used), then the termination of your SCSI host adapter should be removed or disabled. The last peripheral on your internal cable and the last peripheral on your external daisy chain should retain their termination. All other SCSI peripherals connected to the host adapter should have their termination removed, disabled, or turned off.

NOTE: Some host adapters and peripherals have the ability to disable and enable termination *power*. This should not be confused with termination itself. Termination *power* can and should be provided by at least one device attached to your SCSI host adapter. Your Plextor CD-ROM drive automatically supplies termination power. Any additional devices supplying termination power will NOT cause any problems.



Remember: Only the **last** SCSI peripheral in a daisy chain should have termination enabled. If you have any SCSI devices chained **after** your 12PleX, you must **disable** or turn OFF the 12PleX's termination using the following instructions:

PX-12XS_i Internal Termination

The PX-12XS_i is shipped from the factory with its termination enabled (ON).

To disable termination, remove the jumper from the termination pins on the back panel of your drive. Refer to the diagrams on pages 12 and 15 for the location of the termination pins (labeled “Term”). They are the fifth set of pins from the left.

If your drive already is installed in your computer, be sure to turn off your computer power before removing (or reinstalling) the jumpers. We recommend that you retain the jumpers so you can reinsert them onto the termination pins if you later need to turn the drive’s termination ON.

PX-12XS_e External Termination

The PX-12XS_e is shipped from the factory with its termination turned ON.

To turn the termination OFF, first turn off the drive’s power, then change the second DIP switch on the rear panel of the drive to the OFF position. Refer to the pictures on pages 13 and 17 for the location of the termination switch (labeled “Term”). It is the second of the five switches.

Hardware Installation

By itself, your CD-ROM drive is incapable of communicating with your computer. You must use a hardware link that enables your drive to “talk” with the rest of your computer.

Plextor’s 12PleX drives use a SCSI interface as their link. If you own a PC, there are four ways in which you can make the SCSI connection:

- 1) Use a separate SCSI interface board. This is the most common method for both internal and external drives. We recommend using a 32-bit PCI bus mastering SCSI interface board to maximize the drive’s potential. Older 8-bit SCSI interface boards are not recommended. More cost-effective, but with a decrease in video performance, are 16-bit ISA bus mastering SCSI interface boards. Both these bus mastering interface technologies also allow you to take advantage of SCSI multi-tasking in 32-bit operating systems such as Windows 95, Windows NT, UNIX, SCO, Solaris, etc. Another possibility is to use an ISA-PIO SCSI interface board, but performance will suffer, as will multi-tasking.
- 2) Use a soundboard that also has a SCSI interface built onto it. This helps save a slot in your computer by combining the functions of two boards (SCSI interface board and soundboard) into one. *Caution:* Many older soundboards use only an 8-bit SCSI chip. If you need the performance a 16-bit SCSI interface board provides (see page 33), you’ll have to buy a separate SCSI board or a soundboard with a 16-bit SCSI interface built into it.
- 3) If you have an external drive, you can also use a parallel-to-SCSI interface. This is a device that plugs into the parallel port (the one your printer normally is connected to) of your computer. It is convenient, but typically at a cost of reduced performance to your CD-ROM drive.
- 4) If you have an external drive and a portable computer with a PCMCIA slot (Type II or III), use a PCMCIA-to-SCSI card. This is a small, credit-card size device that plugs into the PCMCIA slot. It too is convenient, but also provides less performance than a direct connection to a 32-bit or 16-bit SCSI interface board. PCMCIA connections should, however, provide better performance than a parallel-to-SCSI interface.

NOTE: The following section is only for PC users who need to install a SCSI interface board, or a soundboard with a built-in SCSI interface, in their computer. If you plan to use a parallel-to-SCSI, or PCMCIA-to-SCSI interface, you can skip to Chapter 9. If you are a Mac user with an external drive, you can laugh at how easy life is and skip to page 30. Otherwise, proceed to page 25.



Board Installation

YOUR TASK: Install a SCSI interface board, or a soundboard with a built-in SCSI interface, in your computer.

YOUR OBJECTIVE: Provide the hardware link needed to enable your CD-ROM drive to communicate with your computer.

YOUR METHOD: Remove your computer's case. Install board and attach necessary cables.

Let us point out that this is a CD-ROM drive installation and operation manual—it is not a SCSI interface board or soundboard installation and operation manual. Unless you purchased a SCSI interface board or soundboard (and its accompanying manual) bundled in the same box with a 12PiEX drive, we have no way of knowing which type of board you elect to use. There are dozens of SCSI interface boards and soundboards on the market. Each one is installed somewhat differently. Therefore, our instructions for this section should only be considered as guidelines. For more detailed instructions on how to properly install your SCSI interface board/soundboard, you should refer to the installation/operation manual that you received when you purchased the board.

Caution: If static electricity may be present in the room where you are working, discharge any you may have on your body by touching a grounded object before you remove the host adapter from its packaging.

Static electricity is a silent killer. Just a small jolt to one of the chips on your interface board may render it useless with no apparent damage visible. Positioning your computer in a location without a carpet underfoot is one method of guarding against static electricity damage. Using common sense, such as not walking on a carpeted floor in stocking feet just before you install your drive, is another.

Before proceeding, make sure the power to your computer and any external peripherals is OFF and your computer is UNPLUGGED from its power source.

To remove your computer's cover, follow the directions provided by your computer's manufacturer. Typically, this involves loosening or removing several screws on the back panel of your computer and sliding off your computer's cover.

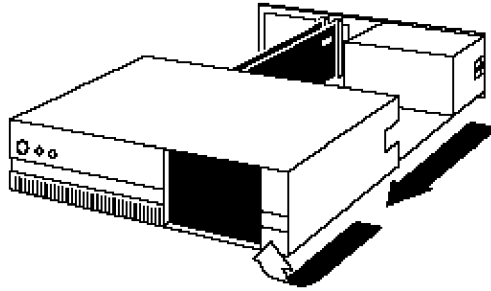

Carefully remove the SCSI interface board from its packaging. Select a vacant slot in your computer where you will install the board (refer to the manual packaged with your interface board for instructions as to which slot in your system to use). Plextor provides both 16-bit ISA and 32-bit PCI SCSI interface boards with its optional bundles, so you must use the correct slot (16-bit slots are longer than 32-bit slots). Older systems may not have a PCI slot, as this is the newer technology. If you install an internal drive, try to pick a slot that is closest to where the drive will be installed.

Remove the cover plate for this slot from the back panel of your computer. Keep the screw from the cover plate nearby as you will need it in a moment. Save the cover plate in case you need it at a later date.

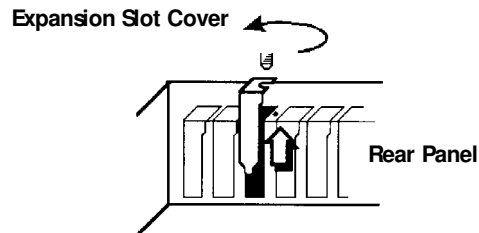

Plug the SCSI interface board into the slot you have selected. Rock the board from end to end to ensure that it seats firmly in the slot. Don't force it. If you cannot push the board down completely into the slot, remove the board and try again.

Once you have successfully inserted the board, fasten it in place using the cover plate screw that you removed earlier.

ISA Board

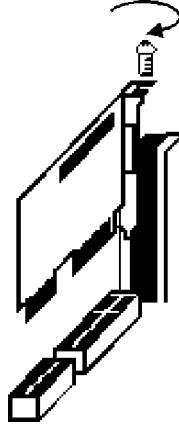

PCI Board

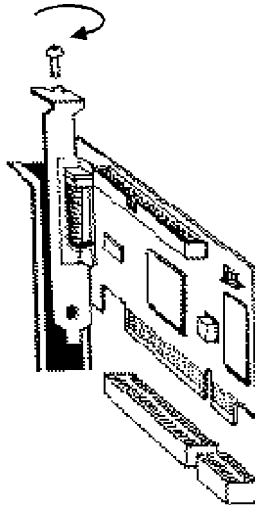



Drive Positioning

YOUR TASK: Determine where you want to install your drive.

YOUR OBJECTIVE: Position the drive in the proper manner so that it operates correctly.

YOUR METHOD: If you have an internal drive, find an open bay in your computer. If you have an external drive, find an open space on your desktop.

The 12PleX may be installed either horizontally or vertically. If installed vertically, make sure that the eject button is positioned near the top of the drive. Doing so will ensure that your drive will perform as specified.

PX-12XS_i

Eject Button UP

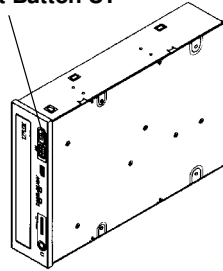

Vertical

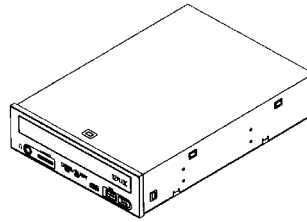

Horizontal

PX-12XS_e

Eject Button UP

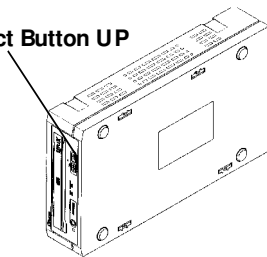

Vertical

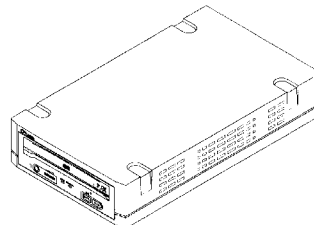

Horizontal

NOTE: The following section is only for those installing internal drives. If you have an external drive, skip to page 30.



Mounting an Internal Drive

YOUR TASK: Mount your internal drive inside your computer.

YOUR OBJECTIVE: A securely positioned drive whose connectors are within easy reach of the various cables that must attach to it.

YOUR METHOD: Identify the drive bay where you will mount your drive. Remove bay cover. If necessary, use mounting rails to install drive in bay.

Your PC probably looks something like this:

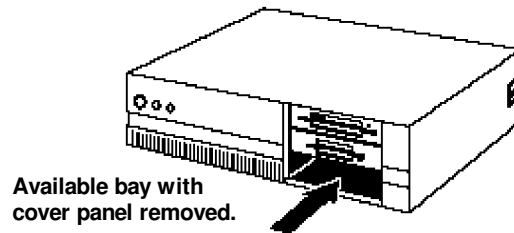

You can mount your drive in any available bay. You must remove the small panel that covers the bay that you want to use. Typically, this is done after you have removed your computer's cover. The panel can then be popped out by pressing outward lightly (in some older cases you may have to remove screws that hold the panel in place).

You now need to determine if you must install mounting rails on the sides of your drive. To do so, insert the drive into the open bay. If the drive fits tightly with little (or no) clearance on either side of the drive, you will not have to use mounting rails. The drive can be mounted directly into your computer.

Caution: Do not mount your drive in your computer using screws other than those supplied by Plextor. You may damage the drive if you insert screws that are too long. If you find that you are having difficulty inserting or ejecting a caddy from your drive, the cause may be that you are using screws other than those supplied by Plextor. Another possibility is that you are using Plextor's screws, but you have tightened them too much. Try backing the screws out a few turns and see if this corrects the problem.



If you must use mounting rails, install them as shown below:

Be sure not to mistake the inner and outer face of the rail when attaching. The smooth side of the rail faces away from the drive's chassis.

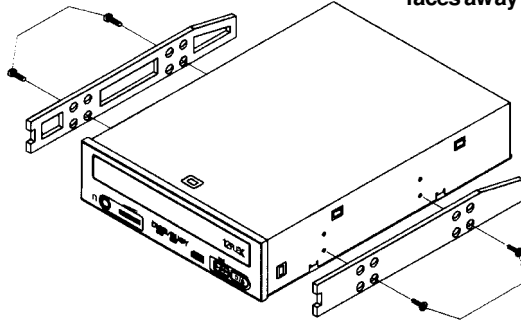

There are four holes provided on each side of the drive. To mount an internal drive in most computers, the rails should be fastened to the lower pair of holes. In some instances you may need to fasten the rails to the upper set of holes.

You will find that eight screws were supplied with your drive: four chrome screws and four black screws. Select which screws to use based on which set of holes you use to attach the mounting rails.

- ✓ Use the *chrome* screws if you use the upper set of mounting holes.
- ✓ Use the *black* screws if you use the lower set of mounting holes.

Check the positioning of the rails by sliding the drive into the bay before you connect any cables.

Check Your Jumper Settings

Once you have determined a) the correct set of holes to use to attach mounting rails, or b) that you don't have to use mounting rails, you are almost ready to finish your drive's installation. Before doing so, however, check your jumper settings one last time.

If you do not have any SCSI peripherals (e.g., hard disk, scanner, printer, etc.) in your system other than your CD-ROM drive, you should not change the jumpers from their factory setting.

If you do have other SCSI peripherals as part of your computer system, you may need to change the settings of the SCSI ID and Terminator. See Chapters 6 and 7 for information on how to change these settings.

Cable Connections

You must make a minimum of two cable connections to your CD-ROM drive. A third cable connection need be made only if you are using a soundboard in your computer.

The two cable connections that you must make are:

- 1) SCSI cable
- 2) power cable

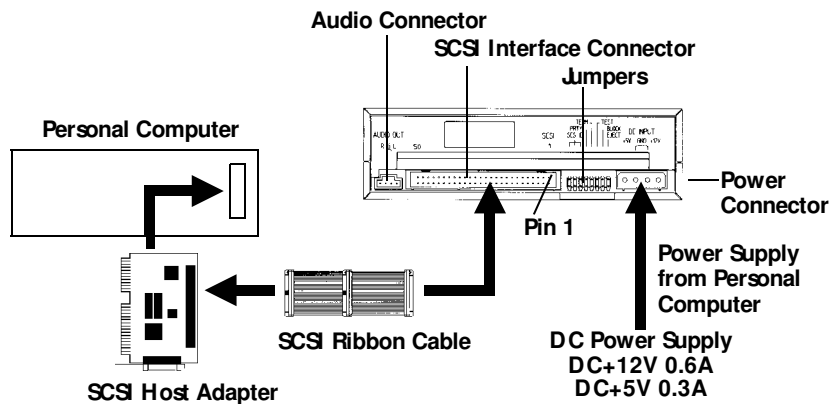

The SCSI cable you will need is included with your drive. It is a standard 50-pin flat ribbon cable with three connectors (one at each end and one in the middle). If you are connecting the host adapter to your Plextor drive only, use the two end connectors and ignore the one in the middle. If you already have one other SCSI peripheral (such as a hard disk), and your existing cable has only two connectors, remove the cable and replace it with the cable provided by Plextor. Connect the SCSI host adapter to a connection on either end of the cable. Connect the two peripherals to the other two connectors (one at the middle connector and one at the end of the cable). Refer to Chapter 7 of this manual for setting the termination of the devices.

If you have more than one other internal SCSI peripheral (besides your Plextor drive), you will need to acquire a SCSI ribbon cable with more connectors (one connector for each internal SCSI device, plus an additional connector for the host adapter—refer to Chapter 3). Refer to Chapter 7 of this manual for setting the termination of the devices.

CAUTION: It is easy to accidentally plug your SCSI ribbon cable upside down into both your drive and SCSI interface board. Accordingly, be sure you match the red stripe along one side of the SCSI cable to pin 1 on the interface board and pin 1 on the drive (as shown on the next page). Each connector on the ribbon cable has a “key” in the middle. This key should fit into a slot in the middle of each connector of the interface board, your 12PleX CD-ROM drive, and any other SCSI peripherals.



Double-check your work; you must ensure the side of the SCSI cable with the red stripe is matched to pin 1 on the interface board and on the drive.

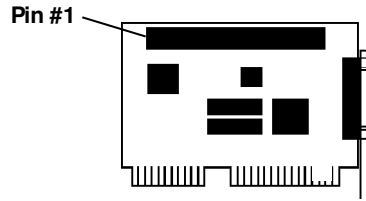
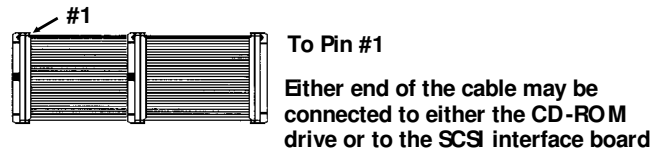

The easiest way to install your SCSI cable is to plug it into the SCSI connector on the rear panel of the drive before you insert the drive into your computer. Then you can thread the cable through the front of the open bay you plan to use and back toward the SCSI interface board. Connect the cable to your SCSI interface board and finish mounting your drive in the proper position. The drive should slide smoothly into the bay. If it does not, check for obstructions in the bay and ensure the side rails (if needed) are attached properly.

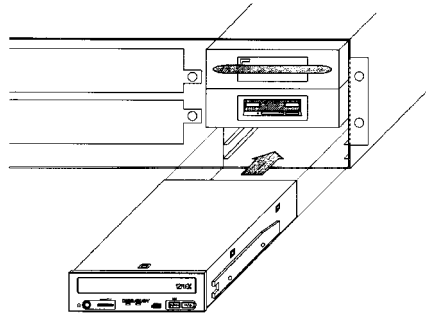

You now need to make the power connection. In most computers you will find additional power connectors that are ready for use. Check the cable running from your power supply to your hard disk and see if it has extra connectors on it. If so, you can plug one of these into the power connector found on the rear panel of the CD-ROM drive.

If you do not find any additional connectors available (either because they were not supplied, or they are all in use), you will have to buy a “splitter” or a “Y-connector.” These can also be found at most computer stores. If you are in a hurry to get started, you can probably unplug the power connector from your 5.25" floppy drive (if you have one) and plug it into your CD-ROM drive. You will be able to use your CD-ROM drive until you have the opportunity to buy a “splitter” or “Y-connector.” (Of course, you will lose the use of your 5.25" drive until you buy a splitter/Y-connector.)

If your computer has only a 3.5" floppy disk drive, you may find that you do not have a power connector that is the correct size to plug into your CD-ROM drive. Once again, you can turn to your local computer store for a splitter to solve this problem, or you might find an adapter that converts the smaller sized power plug found on a 3.5" drive to the size required for your CD-ROM drive.

A third cable, an audio cable, must be used if there is a soundboard in your system. This cable runs from the four-pin audio output connector on the rear panel of your drive to your soundboard. See page 34 for more information about audio cables.

Installation of your internal drive is now complete. Skip to page 33.



External Drive Installation



YOUR TASK: Connect cables from your external drive to your PC or Mac. Check to see if switch, dial, and terminator settings need to be adjusted.

YOUR OBJECTIVE: A well-functioning drive that does not conflict with any other peripherals in your computer system.

YOUR METHOD: Follow directions below for making cable connections. Review your current computer setup to see if the potential for conflicts exists. If so, make necessary switch, dial, and/or terminator changes.

If you are installing a single 12PleX external drive, and you have no other SCSI peripherals attached to your system, you should leave the switches, dial, and terminator found on the rear panel of your drive at their factory settings. If you do have additional SCSI peripherals (e.g., scanner, printer) attached to your computer, you may need to change your switch, dial, and terminator settings. See Chapters 6 and 7 for information on how to change these settings.

If you are installing a single 12PleX external drive, connect it as shown on the next page:

PC Connection

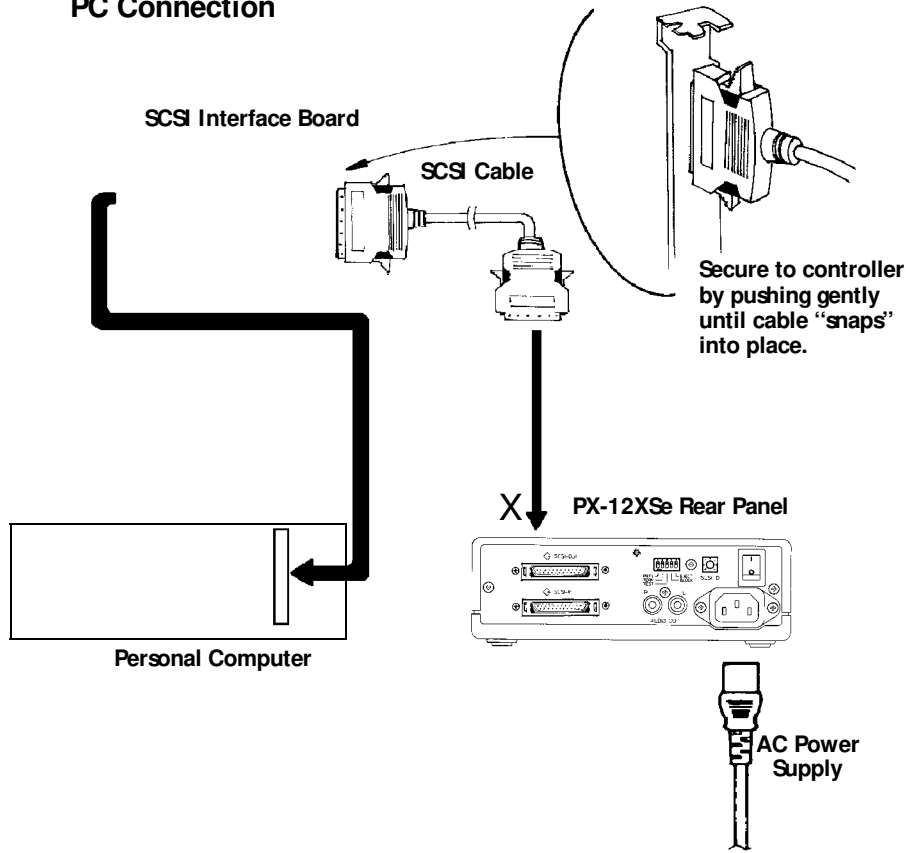

Mac Connection (rear view of a Mac)

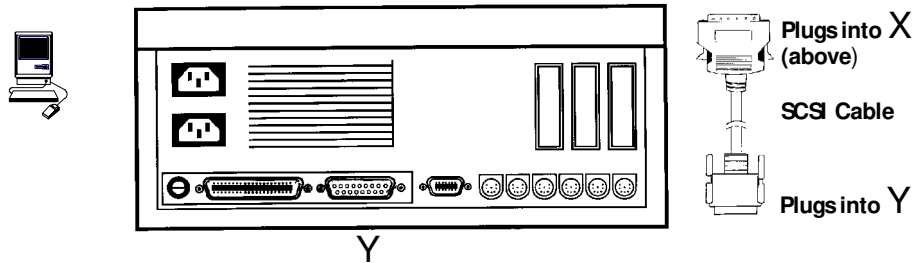

If you are installing more than one PX-12XSe external drive (or one PX-12XSe and other external SCSI peripherals), connect them as shown below:

PC Connection

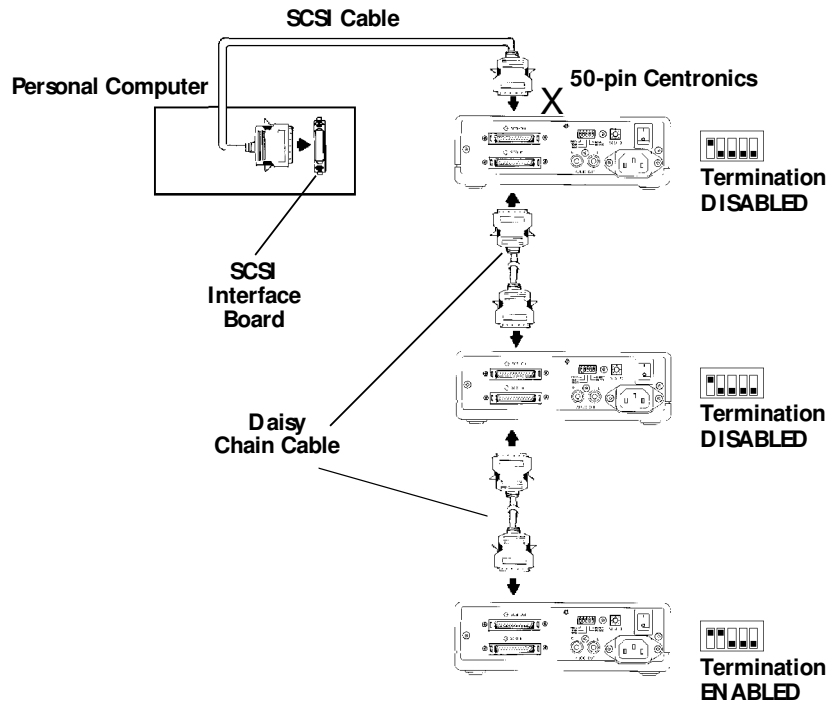

Mac Connection (rear view of a Mac)

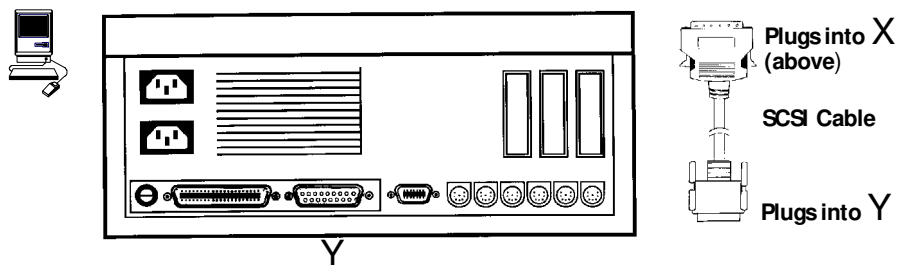

NOTE: The following section is only for those installing a soundboard in their PC. If you are not using a soundboard, skip to Chapter 9.



Soundboard Installation

YOUR TASK: Install a soundboard in your PC.

YOUR OBJECTIVE: Make sure that the soundboard works properly with your CD-ROM drive.

YOUR METHOD: Follow the instructions for installation that came with your soundboard. Follow the instructions given below to connect the soundboard to your CD-ROM drive.

From Plexor's perspective, soundboards fall into one of three major categories:

- 1) Soundboards that have no CD-ROM drive interface (e.g., ATI Stereo F/X, Logitech Sound Man 16, Turtle Beach Multi-Sound). Most soundboards fall into this category.
- 2) Soundboards that have a proprietary or IDE CD-ROM drive interface built onto the board (e.g., Creative Labs Sound Blaster, Orchid Sound Producer Pro, Wearnes Tech Beethoven ADSP-16). Typically, the only drives that can be attached are mediocre performers that sell for a low price.
- 3) Soundboards that have a SCSI CD-ROM drive interface built onto the board (e.g., Media Vision Spectrum 16, Diamond SonicSound, Prometheus Aria 16SE). Any SCSI CD-ROM drive can be attached to this type of soundboard and should work if the proper device drivers are used. However, the SCSI interface will not be high performance.

If you own a soundboard that falls into category #1 or #2 and want to use it with your 12PiEX drive, you must also buy a separate SCSI interface board (e.g., Future Domain TMC-1610, Adaptec AHA-1515). You should follow the directions starting on page 22 regarding the installation of a SCSI interface board. Then, check the diagrams given on page 35 to see how you should connect your audio cable.

If you own a soundboard from category #3, you probably do not have to buy a separate SCSI interface board unless you want maximum performance. Most soundboards with a built-in SCSI interface do not perform well because they use only an 8-bit SCSI interface. (This is true even if you buy a "16-bit" soundboard. The "16-bit" refers to the audio channel, not necessarily the SCSI data channel. The soundboard may have only an 8-bit SCSI interface on it.)

Whichever category your soundboard falls into, you will find that the best source of information about installing the soundboard in your computer is your soundboard's manual. Once you have successfully installed your soundboard in your computer, you can continue to the next section, which describes the different cable connections that need to be made.

Audio Cables

We include two audio cables with your internal CD-ROM drive and one cable with your external drive. One cable delivered with your internal drive is MPC compliant, and the other has connectors designed for use with Sound Blaster sound cards. The cable delivered with your external drive has two RCA-type color-coded connectors at one end, which connect to your drive, and a single stereo mini-jack at the other end, which plugs into the line-in receptacle on your soundboard (at the back of your computer).

If you purchased an internal drive and you have a sound card other than Sound Blaster that is not MPC compliant, you will have to purchase a different audio cable from a computer supply store. We can help by recommending several vendors (see listing, p. 65) who offer audio cables, and can get them to you quickly at a reasonable price. Call our Technical Support Department directly at 800-886-3935.

Please see next page for diagrams illustrating the cable connections.

The following diagrams show where the SCSI cable and audio cable need to be connected to your internal CD-ROM drive:

Soundboard without SCSI Interface

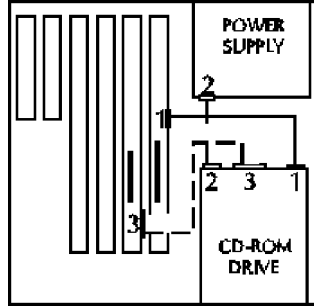

- 1 Audio Connector
- 2 Power Connector
- 3 SCSI Connector

Soundboard with SCSI Interface

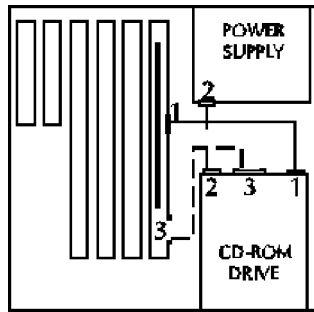

- 1 Audio Connector
- 2 Power Connector
- 3 SCSI Connector



Software Installation

YOUR TASK: Install software onto your computer system to enable the CD-ROM drive to operate optimally within your specific operating system.

YOUR OBJECTIVE: Enable your CD-ROM drive to communicate with the rest of your computer system.

YOUR METHOD: Identify your operating system and refer to the section of this chapter, or the Plextor Manager manual, that pertains to your operating system.

A device driver is a software program that allows your computer to interact with your CD-ROM drive. If you do not use a device driver, or you use an outdated version of the required device driver, you will not be able to operate your CD-ROM drive. The lack of a device driver, or the use of an improper version of a device driver, are the most common source of business for Plextor's Technical Support Department.

- For PC users with Windows 95: please see the Plextor Manager manual.
- For PC users with DOS/Windows: please see the Plextor Manager manual.
- For Apple computer users: please see page 37.
- For PC users with IBM OS/2: please see page 38.
- For PC users with Windows NT: please see page 39.
- For SGI users who purchased Plextor's SGI kit, please refer to the instructions on the enclosed disc cover jacket.

FWB Toolkit for Macintosh Device Driver Installation



The FWB Toolkit provided in your 12PleX MAC kit runs under System 6.08 and 7. In addition to other formats, it supports Photo-CD (Multisession), Audio Extraction, CD+G, CD Plus, and Enhanced CD.

- 1) To begin installation, insert the FWB floppy disk you received with your CD-ROM drive into your disk drive. Make sure that power to your CD-ROM drive is OFF.

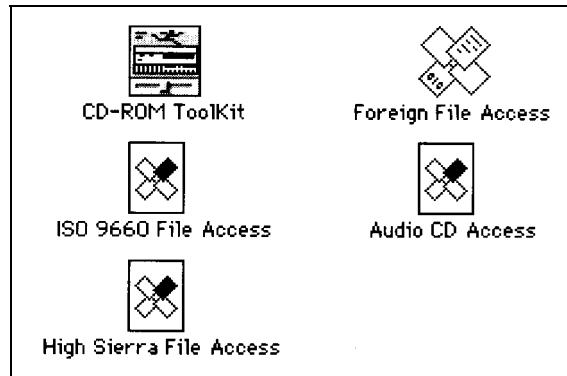

- 2) Drag each icon from the driver window into your **SYSTEM FOLDER** or use the Installation program if one is available on the floppy.
- 3) Select "Shut Down" or "Restart" from your Mac desktop. After restarting your Mac you should see the CD-ROM device driver as the Mac boots up. If the icon appears crossed out, check to see that the CD-ROM drive power is on and that the SCSI ID does not conflict with another device. Otherwise, wait until the Mac is done booting up before inserting a disc.

SYSTEM 7 USERS: At this point, a dialog box will appear telling you that these files need to be stored in special places in the **SYSTEM FOLDER**. Click on OK and all the files will be copied to their appropriate places.

- 4) Insert a caddy containing a CD-ROM disc (written in Mac format) into your 12PleX drive.
- 5) Your Mac will display the CD-ROM disc's icon.
- 6) Double-click on the icon to start the program.

OS/2

Installation Procedure

To install OS/2 from your OS/2 CD-ROM disc, you first need to verify that your SCSI interface board is supported by OS/2. Check your OS/2 manual and the README file on the floppy disk that comes with the OS/2 CD-ROM for information on which SCSI interface boards OS/2 supports.

If your SCSI interface board is on OS/2's list of supported hardware, you can follow the installation instructions provided by IBM.

However, if your SCSI interface board is not on OS/2's list of supported hardware, you must contact the manufacturer of your board and request an OS/2 software device driver. (See listing of key contact phone/fax/BBS numbers on page 65.)

The OS/2 device driver files that you need from your SCSI interface board's manufacturer end with an ".ADD" extension. They need to be copied into the CONFIG.SYS file on the OS/2 installation floppy disk. Your SCSI interface board manufacturer will provide you with specific instructions.

Adding CD-ROM Support After OS/2 Has Already Been Installed

- 1) You first need to verify that your SCSI interface board is supported by OS/2. Check your OS/2 manual, and the README file on the floppy disk that comes with the OS/2 CD-ROM, for information on which SCSI interface boards OS/2 supports. If your SCSI interface board is included on the list of supported hardware, you can skip to step #3.
- 2) If your SCSI interface board is not on OS/2's list of supported hardware, you must contact the manufacturer of your board and request an OS/2 software device driver. (See listing of contact phone/fax/BBS numbers on page 65.)
- 3) Once you have confirmed that your SCSI interface board is supported by OS/2, or you have obtained the necessary device driver files, run OS/2's Selective Install program to set up your SCSI interface board and CD-ROM drive. In the "SCSI Host" field, select your board. (If your board was already installed and running, your SCSI interface board should already be selected, and there is no need for you to change this entry.) In the "CD-ROM Drive" field, select "Texel/Plexor 3024/5024, 3028/5028, 4PleX." Then, select "Install" and insert the OS/2 floppy disks when requested. After rebooting, your CD-ROM drive should appear in the "Drives" folder.

OS/2 Troubleshooting Tip

If you have difficulty getting OS/2 to recognize your CD-ROM drive and SCSI interface board, you should first verify that all of your hardware is operating properly.

This is best done by installing DOS. If your system also does not work under DOS, you probably have a hardware problem that needs to be resolved before you can go any further. Refer to the Troubleshooting guide in Chapter 12. If your system works under DOS, but not OS/2, review your device driver installation and verify that the SCSI interface board driver and CD-ROM support (see step #3 on page 38) is loaded correctly.

Windows NT 3.51 (and Below)

Installation Procedure

To install Windows NT from your NT CD-ROM disc, you first need to verify that your SCSI interface board is supported by NT. Check your NT manual for information on which SCSI interface boards NT supports.

If your SCSI interface board is on NT's list of supported hardware, you can follow the installation instructions provided by Microsoft.

If your SCSI interface board is not on NT's list of supported hardware, however, you must contact your board's manufacturer and request an NT software device driver (see listing of key contact phone/fax/BBS numbers on page 65).

The files you obtain need to be added to the NT installation floppy disk(s) that came with your NT CD-ROM disc. Your SCSI interface board manufacturer will provide you with specific installation instructions.

Adding CD-ROM Support After NT Has Already Been Installed

- 1) You first need to verify that your SCSI interface board is supported by NT. Check your NT manual for information on which SCSI interface boards NT supports. If your SCSI interface board is included on the list of supported hardware, skip to #3.

- 2) If your SCSI interface board is not on NT's list of supported hardware, you must contact your board's manufacturer and request an NT software device driver (see listing of key contact phone/fax/BBS numbers on page 65).
- 3) Run NT's Setup program to add support for your SCSI interface board. Select "Add/Remove SCSI Adapters . . ." from the menu. Choose your SCSI interface board from the list or, alternately, add the driver you obtained from your SCSI interface board manufacturer.
- 4) Run the NT Control Panel and then run Devices. From the list of devices, locate "Scsiscrom" and check the "startable" box. This procedure is fully outlined in the Windows NT manual.
- 5) Reboot. Your 12PleX drive should now be visible to the system.

Windows NT Troubleshooting Tip

If you have difficulty getting NT to recognize your CD-ROM drive and SCSI interface board, you should first verify that all of your hardware is operating properly.

This is best done by installing DOS. If your system also does not work under DOS, you probably have a hardware problem that needs to be resolved before you can go any further. If your system works under DOS, but not NT, review your device driver installation and verify that the SCSI interface board device driver and CD-ROM support (step #4, above) are loaded correctly.

Using CD-ROM Discs, Caddies, and Trays



YOUR TASK: Learn how to handle, load, and care for your discs.

YOUR OBJECTIVE: Protect your discs. Insert and eject discs properly so your drive operates without interruption.

YOUR METHOD: Practice loading discs into caddies and trays.

Until the release of the 12PleX, Plextor only manufactured drives with caddy loading mechanisms. Many applications and users continue to require the performance, protection, and/or mechanics of a caddy. Plextor will continue to produce caddy-based drives to meet these requirements. However, the consumer market has expressed a preference for tray loading. To address that preference the 12PleX is available in both caddy and tray versions. For information on using a tray loading 12PleX, go to page 43. For caddy loading, continue reading below.

Caddy Loading

Plextor's CD-ROM drives use an industry-standard disc caddy to protect the disc from scratches and contamination. A standard caddy is made of plastic and has a metal shutter on its bottom which slides open and shut. Plextor is also constantly evaluating other caddy designs for possible use in the future. Unless provided or recommended by Plextor, use of a non-standard caddy (e.g., one that lacks a metal shutter on its bottom) is not recommended. For their protection, CD-ROM discs should be stored in their original packaging or in a caddy.

Inserting the Disc into a Caddy

- 1) To open the lid of the caddy, press the tabs at the side as shown.



- 2) Place the disc into the caddy with the label facing UP. Be sure to place the disc beneath the edge of the caddy under the arrow mark. Handle the disc by the sides. Don't touch its surface.

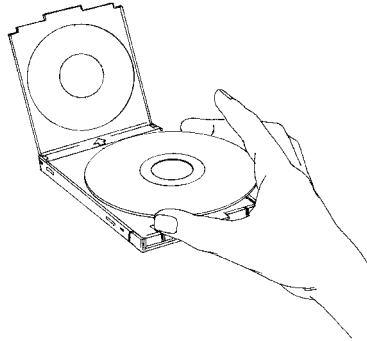

- 3) Close the lid firmly, but not too hard.

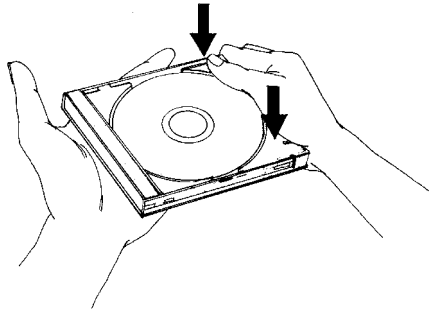

Caution: If the caddy appears defective (e.g., warped, cracked, or bent) do not insert it into the drive. A defective caddy can become stuck inside the drive, requiring the drive's return to your dealer for service. If your caddy appears defective, promptly replace it with a new one.

Handle the caddy as you would any precision component. **Do not:**

- X Allow moisture or dust/contamination either in or on the caddy.
- X Store the caddy in a location subject to direct sunlight, high temperature, or high humidity.
- X Drop the caddy or subject it to shock.
- X Open the shutter manually. The caddy's shutter opens automatically when the caddy is inserted into the CD-ROM drive.

Loading the Caddy into the Drive

1. Open the drive's door.
2. Carefully insert the caddy in the direction shown, with the arrow mark facing the drive.
3. Push the caddy into the drive until the caddy load mechanism is engaged.

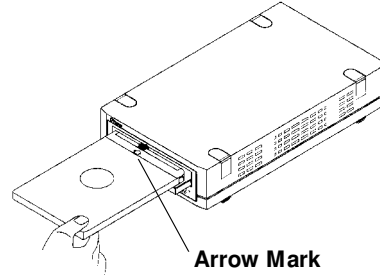

Hint: You need use only one hand to insert the caddy into the drive. This is easily accomplished by placing the front portion of the caddy on top of the lip of the drive's door. You can press down lightly to open the drive's door, then slide the caddy into the drive.

Removing the Caddy from the Drive

- 1) Push the Eject button. The caddy will eject from the drive in 2–3 seconds.
- 2) Pull the caddy straight out of the drive.
- 3) If the caddy will not eject from the drive after pushing the Eject button, you should be able to remove the caddy from the drive by using the Emergency Eject button. Turn off power to the drive. Insert a paper clip into the Emergency Eject hole. The caddy should now eject from the drive. Please contact Plextor's Technical Support Department before attempting to reinsert the caddy into the drive.

Tray Loading and Operating

- 1) While the drive is powered up, push the eject button. The tray drawer will slide out in 2–3 seconds.
- 2) Lay the bare CD (do not use a caddy) into the depression in the tray, label side up. If the drive is mounted in the horizontal position and the CD lays flat in the drive, you do not need to use the clips in the tray. If the drive is mounted in the vertical position (on its side with the tray perpendicular to the ground), the clips should be gently pushed into place over the CD so that it does not fall out of the tray.

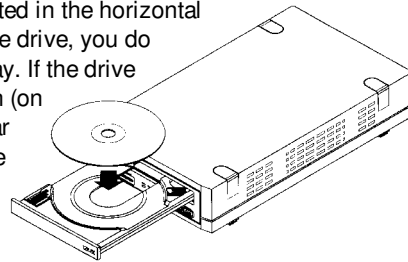

- 3) Press the Eject button again and the tray will slide shut within 2–3 seconds.



Note: We recommend you use the Eject button to close the tray in a smooth and secure manner. Closing the tray by pressing the front of the drawer by hand is not recommended.

Cleaning the Disc

If the disc is merely dusty, you may use a commercially available dust removal spray such as Dust-Off or Vari-Air to blow dust particles off the disc.

After removing the dust particles, you may wipe the disc using a clean, soft cotton cloth. Use a straight-line motion, wiping *from the center out*. Do *not* wipe the disc in a circular motion.

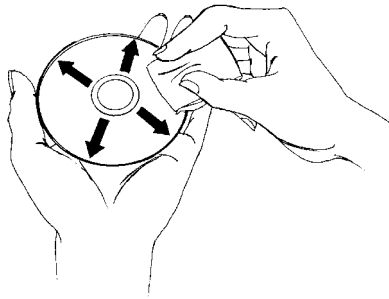

If a disc becomes dirty or soiled with grease or other contaminants not removable by wiping, you may clean the disc with a CD-ROM disc cleaner available at most computer dealers. Follow the directions packaged with the cleaner.

Hint: Keeping your CD-ROM disc in a caddy at all times will prevent the disc from becoming dirty or damaged.

How to Play Audio CDs on Your Drive



YOUR TASK: Learn how to use your CD-ROM drive so that it can also play audio CDs.

YOUR OBJECTIVE: Increase functionality of your drive. Provide musical accompaniment for presentations. Goof off at work.

YOUR METHOD: A variety exists for you to choose from. You can use anything from front panel controls or very basic, bare bones audio CD software utilities up to software utilities that rival or surpass the capabilities of the CD player attached to your stereo system.

- 1) The most basic method is to use the 12PleX front panel audio controls. No special drivers are needed to operate this feature.

Once an AUDIO CD is inserted into the drive, simply push the button to begin AUDIO play. Once the AUDIO is playing, push the play button once for track advance, or hold down the button for more than 1 second to begin a fast forward search (ffwd). To eject the caddy from the drive, press the Stop/Eject button once to stop AUDIO play and a second time to eject the CD.

While in audio CD play mode, you can read a CD-ROM data disc by simply removing the audio CD and inserting a data CD into your CD-ROM drive.

- 2) For PC users, audio utilities are provided with Plextor Manager and Plextor Manager 96. For installation and operating instructions, refer to the separate Plextor Manager software manual.
- 3) Other alternatives include audio utilities designed into your operating system (Media Player in Windows for instance) or various other utilities that can be purchased commercially.



- 4) Mac users can run a program such as CDT Remote (which typically is included with FWB's CD-ROM device driver).

In order to hear the audio CD your drive is playing, you can plug a pair of stereo headphones or self-powered speakers into the headphone jack on the drive's front

CHAPTER 11 — How to Play Audio CDs on Your Drive

panel. You also can connect your drive to an audio amplifier as shown on the next page. The audio cables shown are available at most computer and audio supply stores.

PLEASE NOTE: The volume control wheel on the front panel of your drive adjusts only the sound level of the headphone jack. It has no impact on the volume level of the rear panel audio outputs.

PX-12XS (Internal or External)

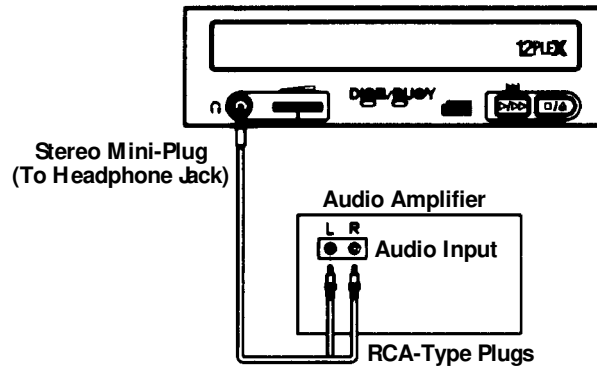

PX-12XSe (External)

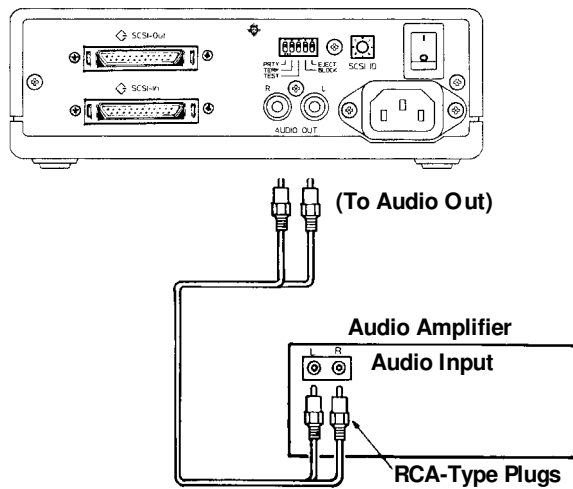



Troubleshooting

YOUR TASK: Review some of the common problems you may encounter when installing or operating your 12PleX drive.

YOUR OBJECTIVE: Gain a better understanding of how your drive operates. Attempt to prevent problems before they occur. Quickly fix, on your own, many simple problems rather than wait for assistance from a Plector representative.

YOUR METHOD: Read this entire section. Many of the problems discussed happen only rarely. Many may seem as if they do not pertain to you. If you are familiar with the variety of problems that **can** occur, however, you will be better prepared to deal with them if they happen to you. 

If you experience trouble with your 12PleX drive, follow these guidelines:

PC Users:

- 1) Most SCSI interface boards can sense when a problem has occurred and will generate an error message on your computer. Take note of this message. Then, run the test (diagnostic) program that probably is included with the device drivers for your SCSI interface board. Follow the instructions given in the SCSI interface board's manual. If the information provided by the error message and test program is not sufficient for you to fix the problem, proceed to step #2.
- 2) If your problem occurs during or immediately after the drive's installation, read Section 12.1—PC Compatibles: Initial Installation. If your problem occurs after you had run the drive successfully for an extended period, read Section 12.2—PC Compatibles: Existing Installations.
- 3) Attempt to match the problem you are having with the entries listed beneath SYMPTOMS. Then narrow your search by checking to see if the ADDITIONAL SYMPTOMS apply to you as well. Because different SCSI interface boards generate differently worded error messages, the messages displayed by your computer may differ from those shown on the following pages.

Apple Computer Users:

Read Section 12.3—Apple Computers



Technical Support

If you still cannot solve your problem after reviewing the relevant sections of this chapter, please contact Plexor's Technical Support Department. See Chapter 13 for information on how to prepare for, and then make contact with, Plexor's technical support staff.

12.1 PC Compatibles: Initial Installation

Symptoms

- No sound when running a CD-ROM program

Additional Symptom

No sound when playing an audio CD

Possible Causes and Solutions

Application Does Not Use CD-Audio

There are two types of audio you may encounter when using CD-ROMs:

1) Sound Card Audio:

This comes from data (e.g., .WAV or .MID files) that is transferred from your CD-ROM disc via the SCSI host adapter into your computer, and is translated by your soundboard into sound. If you do not have a soundboard, you will not be able to hear this form of audio.

2) CD Audio:

This comes from audio discs (like the ones used by your home stereo) that are translated directly by your CD-ROM drive into sound. You do not need a soundboard to hear this audio. You can hear this audio by plugging a set of headphones or powered speakers into the headphone jack on the front of your drive.

One reason, then, that you might not hear sound when playing a CD-ROM disc is that a soundboard is required. These discs use only sound card audio, not CD Audio.

To help you determine if you are having a soundboard problem, or a CD Audio problem, try playing an audio CD in your CD-ROM drive. If you can hear music (through headphones or speakers connected to the headphone jack on the front of your drive), the CD-ROM disc you are playing may require the use of a soundboard in order to hear sound. If possible, check the manual that came with the CD-ROM disc and see if the use of a soundboard is recommended or required.

If you have a soundboard and can hear an audio CD when it is played, but cannot hear sound when you play a CD-ROM disc, you may have configured your soundboard incorrectly. Check the troubleshooting section of your soundboard manual for further advice. If you have a soundboard but you cannot hear an audio CD when it is played, check the following points:

Improper/Missing Audio Cable

If you use a soundboard, you must connect the soundboard to your CD-ROM drive with an audio cable. See page 34 to ensure you have properly installed this audio cable. If you have a soundboard and CD-ROM drive, but lack an audio cable, contact one of the companies listed on page 65, or Plextor's Technical Support Department, for information on where a cable can be purchased.

Device Drivers Need to Be Updated

If you can hear an audio CD in your CD-ROM drive when it is in Audio CD play mode (see Chapter 11), but you cannot hear an audio CD with another music CD utility (e.g., Animation's MCS CDMaster, CorelCD), your device drivers may need to be updated. Contact Plextor Technical Support for assistance.

Soundboard Volume Low

If, when playing an audio CD, you do not hear sound even though everything appears to be functioning normally (busy light on drive flickers, the time counter on your audio CD utility is advancing), you may have the mixer settings for your soundboard set too low. Each soundboard has different settings for each input source, including one for CD Audio. Run your soundboard's mixer program and verify that the volume is turned up.

Bad Soundboard Audio Cable

If you have verified that you have made the proper cable connections between your 12PleX drive and soundboard, and you have the correct device drivers installed but you still do not hear sound when playing an audio CD, the problem may rest with your audio cable. It may be defective and need to be replaced.

You can check to see if this is the case by doing the following: Unplug the audio cable from the rear of your 12PleX drive. Plug a set of headphones or speakers that you know are good into the jack on the front of the drive. Try to play an audio CD. If you can now hear music, you may conclude that you do, in fact, have a bad audio cable.

Symptoms

- Cannot view Photo CD discs
- Can read only first session of a multisession disc
- Receive error messages while reading Photo CD images

Your 12PleX drive is capable of reading Kodak Photo CD multisession discs if you use the appropriate device drivers and you run a Photo CD viewing program (e.g., Magic Lantern, Kodak's Photo CD Access).

Possible Causes and Solutions

Device Drivers Need to Be Updated

Contact Plextor Technical Support for device driver information.

Bad Photo CD Disc

If you can see a list of files from your Photo CD (after issuing a DIR command), but cannot read them, or experience errors while reading them, you may have a bad Photo CD disc. Try another Photo CD disc. If it works, you should have the defective disc replaced.

Symptoms

- Invalid Drive Specification
- No Device Found
- No SCSI Interface Board Found, or No Response from SCSI Interface Board
- No Drives in Use

Additional Symptom

Error Appears upon Initial Installation of the CD-ROM Drive and Device Driver Software

Possible Causes and Solutions

Improper SCSI Device Driver Installation

Your computer needs a SCSI software device driver to link the SCSI interface board to the CD-ROM drive. If this driver cannot be loaded properly, an error message will normally be displayed on the screen.

Try rebooting the computer. Watch as the CONFIG.SYS file executes, and look for an error message to appear. You can press the Control and S keys simultaneously to freeze the display in order to read the error message (use the Control and S combination again to continue).

If the SCSI device driver cannot be loaded properly, either a software or hardware conflict exists. Software conflicts are generally caused by memory managers; hardware conflicts by two peripherals vying for the same DOS address space. Please read the next two paragraphs on software and hardware conflicts.

Software Conflict with Other Device Drivers

The SCSI interface board normally designates the CD-ROM driver as the first device driver loaded by the computer. When the computer has a memory manager (e.g., HIMEM.SYS, 386MAX.SYS, or QEMM.SYS), in most cases the memory manager is loaded first and the CD-ROM driver loaded directly thereafter.

If other device drivers are loading before the CD-ROM driver, place them after the CD-ROM driver. If the memory manager tries to load the CD-ROM driver into high memory (e.g., DEVICEHIGH or LOADHIGH), disable the function so that the driver is loaded into conventional memory.

Hardware Conflict Between the Interface Board and Your Computer

The SCSI interface board may be in conflict with another peripheral in your computer. Normally, this conflict can be settled by selecting a different address for the SCSI interface board. In some cases, you may wish to select a different address for the conflicting peripheral.

If the driver still does not recognize the interface board, follow these steps:

- 1) Remove all non-essential peripherals from your computer (e.g., network boards, fax boards, etc.) and their device drivers from the CONFIG.SYS and AUTOEXEC.BAT files.
- 2) Reboot the computer and ensure that the CD-ROM device driver recognizes the SCSI interface board.
- 3) Turn off the computer and reinstall each peripheral and its device drivers one at a time.
- 4) Repeat steps 2 and 3 until the problem reoccurs. This means that the problem is with the last peripheral you installed.

Improper MSCDEX Installation

The Microsoft CD-ROM Extensions (filename: MSCDEX.EXE) or equivalent files from Corel (COREL.CDX.EXE) are required to run your CD-ROM drive under MS-DOS or DR DOS. If the SCSI driver was successfully loaded, check for proper installation of MSCDEX.EXE by rebooting the computer and watching the AUTOEXEC.BAT file as it executes for an error message.

SCSI Interface Board Not Properly Seated

If the SCSI interface board is not fully seated into the computer's expansion slot, the device driver software will not recognize it. Inspect the interface board where it seats into the connector on your computer's motherboard. There should not be more than a small gap between the interface board and the connector.

Symptom

- Incorrect DOS Version
-

Possible Causes and Solutions

Conflict Between MS-DOS 5.0 and Microsoft's CD-ROM Extensions Version 2.2 (or Lower)

MS-DOS 5.0 users should use Microsoft's CD-ROM Extensions (file name MSCDEX.EXE) Version 2.21 or 2.22. If you do not have either of these versions, and plan to use DOS 5.0 with MSCDEX.EXE Ver 2.2 (or lower), you can resolve this conflict by doing the following:

- 1) Type the following line into your CONFIG.SYS file:
DEVICE=C:\DOS\SETVER.EXE
- 2) Switch to the DOS prompt.
- 3) Type the following: SETVER MSCDEX.EXE 4.01, then press the enter key.
- 4) Reboot your computer.

Conflict Between MS-DOS 6.0 and Microsoft's CD-ROM Extensions (file name: MSCDEX.EXE) Version 2.21 (or Lower)

MSCDEX.EXE ver. 2.22 (or higher) must be used with DOS 6.0. Use of an earlier version will result in an INCORRECT DOS VERSION message. A copy of MSCDEX.EXE ver. 2.22 is included with DOS 6.0. You can find this file in your C:\DOS directory.

If you previously had loaded MSCDEX.EXE ver. 2.21 (or lower), your computer might still be recognizing this lower version rather than 2.22 (or higher).

To correct this problem, you must edit your AUTOEXEC.BAT file using a text editor or word processor. Your AUTOEXEC.BAT file will probably contain a line that looks something like this:

```
C:\TSCSI\MSCDEX.EXE/D:TSLCD /M:10
```

In this example, "C:\TSCI" is the path to MSCDEX.EXE. The path name will vary depending on the type of SCSI device driver software you use.

Change only the path of this line in your AUTOEXEC.BAT file so that it finds the updated MSCDEX.EXE file in your DOS directory. This line should be edited to read:

```
C:\DOS\MSCDEX.EXE/D:TSLCD /M:10
```

Save the AUTOEXEC.BAT file and reboot your computer.

Symptoms

- No Device Found
- No SCSI Interface Board Found or No Response from SCSI Interface Board

Additional Symptom

Driver Fails to Recognize the SCSI Interface Board

Possible Cause and Solution**Drive Not Resetting**

In some cases, even if you restart the computer by pressing its reset button or the Control, Alt, and Del keys simultaneously, the drive does not appear to respond. Try turning the power switches on the drive and computer OFF, then ON. This complete shutdown should fully reset the drive and computer.

Symptom

- CDR101 – Not Ready Reading Drive [X]

Additional Symptom

All Commands Sent to the Drive Result in CDR101 Error

Possible Causes and Solutions**Defective Caddy**

A warped or damaged caddy can cause a CDR 101 error message. Try using another caddy and see if this eliminates the problem. Also, be sure to use only an “industry standard” caddy. This is a caddy made of plastic with a metal shutter on its bottom. If you use another type of caddy (e.g., all plastic, but with no metal shutter on its bottom—just an opening), you may experience problems.

Defective CD-ROM Disc

A fingerprint, contaminants, or deep scratches on the disc’s surface may prevent the drive from reading data. Read Chapter 10 to learn how to clean CD-ROM discs.

You should also review the low performance symptom discussed on page 61.

Bad Connection Between the CD-ROM Drive and the SCSI Interface Board

Inspect the cable, drive, and interface board for recessed, broken, or bent pins. If a ribbon cable is used, inspect for any signs of distress, such as kinking. Ensure the red stripe side of the ribbon cable plugs into pin 1 on both the drive and the interface board.

Audio CD Disc in the Drive

Plexor CD-ROM drives are capable of playing high-quality audio when used with appropriate audio playback software, or when the drive is set to Music CD Player Mode (see Chapter 11). Since audio compact discs do not have computer data, typing computer commands while an audio CD is in your drive will result in an error message.

Disc in Caddy Upside Down

Remove disc from caddy and reinsert label side up.

12.2 PC Compatibles: Existing Installations

Symptoms

- Invalid Drive Specification
- No Device Found
- Drive Not Responding

Additional Symptom

Interface Board Driver Fails to Recognize the CD-ROM Drive

Possible Causes and Solutions

Drive Is Not On

If you have a PX-12XS external drive, check that its front-panel power switch is ON. If the drive is the PX-12XS internal model, ensure the power cord from your computer's power supply is plugged firmly into the drive power connector. Power is applied correctly if one of the front panel LEDs is on.

Bad Connection Between the CD-ROM Drive and the SCSI Interface Board

Inspect the cable, drive, and interface board for recessed, broken, or bent pins. If a ribbon cable is used, inspect for any signs of distress, such as kinking. Ensure the red stripe side of the ribbon cable plugs into pin 1 on both the drive and the interface board.

Improper SCSI Bus Termination

Ensure that only the peripheral at the end of the internal SCSI cable and/or the last peripheral in a daisy chain of external devices is terminated (see Chapter 7). Some

peripherals have a setting marked “termination power” instead of “terminator.” Ensure their termination power switches are set correctly.

Symptom

- CDR101—Not Ready Reading Drive [X]

Additional Symptom

CD-ROM Drive Responds to Directory (DIR) Command but Cannot Run a Program

Possible Causes and Solutions

Bad Connection Between the CD-ROM Drive and the SCSI Interface Board

Inspect the cable, drive, and interface board for recessed, broken, or bent pins. If a ribbon cable is used, inspect for any signs of distress, such as kinking.

Improper SCSI Bus Termination

Ensure that only the last peripheral on the SCSI bus is terminated (see Chapter 7). Some peripherals have a setting marked “termination power” instead of “terminator.” Ensure their termination power switches are set correctly.

Defective CD-ROM Disc

A fingerprint, contaminants, or deep scratches on the disc’s surface may prevent the drive from reading data. Read Chapter 10 to learn how to clean CD-ROM discs.

You should also review the low performance symptom discussed on page 61.

Conflict with a Network Card

Temporarily remove the network card and all related drivers from the AUTOEXEC.BAT and CONFIG.SYS files. Reboot the computer and check that the CD-ROM drivers load successfully.

Conflict with DOS 5.0 EMM386.EXE

The DOS memory manager may be using the address area required by the interface board. (This situation does not apply to interface boards that do not use high memory addressing, such as Trantor’s T-130b/T-160.) If you suspect this problem, edit your CONFIG.SYS file as follows:

```
Before: DEVICE=C:\DOS\EMM386.SYS
After:  DEVICE=C:\DOS\EMM386.EXE X=C800-EFFF
```

This argument prevents EMM386.SYS from using the address space required by the interface board or using the specific address your board requires.

Symptom

- CDR101—Not Ready Reading Drive [X]

Additional Symptom

Errors Occur Intermittently

Possible Causes and Solutions**Defective CD-ROM Disc**

A fingerprint, contaminants, or deep scratches on the disc's surface may prevent the drive from reading data. Read Chapter 10 to learn how to clean CD-ROM discs.

You should also review the low performance symptom discussed on page 61.

Drive Not Terminated

If your CD-ROM drive is the only SCSI peripheral attached to your computer or is the last SCSI peripheral in a daisy chain (i.e., a cable connecting multiple SCSI peripherals to a single SCSI interface board), check that its termination switch is ON. Always turn the drive OFF before changing the setting of the rear-panel switches. See Chapter 7.

Symptom

- CDR101—Not Ready Reading Drive [X]

Additional Symptom

All Commands Sent to the Drive Result in CDR101 Error

Possible Causes and Solutions**Audio CD Disc in the Drive**

Plexor CD-ROM drives are capable of playing high-quality audio when used with appropriate audio playback software or when the drive is set to Audio CD play mode (see Chapter 11). Since audio compact discs do not have computer data, typing standard data commands when an audio CD is in the drive will result in an error message.

Defective CD-ROM Disc

A fingerprint, contaminants, or deep scratches on the disc's surface may prevent the drive from reading data. Read Chapter 10 to learn how to clean CD-ROM discs.

You should also review the low performance symptom discussed on page 61.

Bad Connection Between the CD-ROM Drive and the SCSI Interface Board

Inspect the cable, drive, and interface card for recessed, broken, or bent pins. If a ribbon cable is used, inspect for any signs of distress, such as kinking.

Disc in Caddy Upside Down

Remove disc from caddy and reinsert label side up.

Symptom

- CDR103—Not High Sierra Format

Additional Symptom

Occurs with Certain Discs Only

Possible Cause and Solution**Incorrect Disc**

The disc might be intended for another type of computer, such as a Macintosh or Sun, or it is not mastered in the High Sierra or ISO 9660 formats.

Symptom

- CDR103—Not High Sierra Format

Additional Symptom

Occurs Regardless of the Discs Used

Possible Causes and Solutions**Incorrect Jumper Setting**

You might have the block jumper set to ON. See page 18.

Hardware Conflict

If the SCSI interface board uses DMA channels, try changing the selected DMA channel. See the instruction manual for your SCSI interface board.

Memory Manager Conflict

If the SCSI interface board uses memory-mapped addressing or has a BIOS, exclude the addresses from the memory manager. See the instruction manual for your SCSI interface board.

Incorrect Version of Microsoft CD-ROM Extensions

Version 2.00 or higher of MSCDEX is required to read a High Sierra or ISO 9660 format disc.

Symptom

- Excessive Noise
- Disc Heard Jumping

Additional Symptom

CDR101 Error Message

Possible Causes and Solutions**Defective Caddy**

Replace caddy.

Defective CD-ROM Disc

A fingerprint, contaminants, or deep scratches on the disc's surface may prevent the drive from reading data. See Chapter 10 to learn how to clean CD-ROM discs.

You should also review the low performance symptom discussed on page 61.

CD-ROM Drive Set to Test Mode

Turn this switch OFF. The test mode is for factory use only. Always turn the drive OFF before changing the setting of the switches. See Chapter 6.

CD-ROM Disc is Poorly Balanced

Remove any adhesive labels on the label side of the disc and clean the surface following instructions in Chapter 10. If there is no foreign substance on the disc, you may wish to contact the disc manufacturer for a replacement.

Symptom

- Low Performance of CD-ROM Application Software
-

Possible Cause and Solution

Drive Automatically Set to Standard Throughput (150KB/sec)

Plextor's drives are designed to automatically switch from twelve speed throughput to eight speed, to four speed, to two speed and then to single speed when they encounter a defect or a scratch on your disc. The drive then will continue to read data from the disc at double or single speed until a new read command is transmitted to the drive. The drive will then return to twelve speed mode.

It is also possible that the disc is dirty. Please refer to page 44 for instructions on how to clean your CD-ROM disc.

Symptom

- Disc Is Ejected After Being Inserted
 - ON/BUSY Light Flashes 4 Times
-

Possible Cause and Solution

CD Is Unreadable

Plextor's drives are designed to automatically eject any unreadable CD. Please be sure that the CD-ROM disc or audio CD is "label-side" up in the caddy. If not, this will cause the drive to eject the CD. A blank or incorrectly written CD-R (blank media), a damaged, scratched, or otherwise unreadable CD will cause this same symptom. Inserting a known good disc will correct this problem.



12.3 Apple Macintosh

Symptoms

- Invalid Drive Specification
 - No Device Found
 - Drive Not Responding
-

Possible Cause and Solution

SCSI Address Conflicts with the Hard Disk Drive

This usually can be corrected by selecting another SCSI address (normally addresses 1 to 6) for your CD-ROM drive. Note: The Macintosh's hard disk uses address 0 and its internal SCSI adapter uses address 7.

Symptom

- Computer Does Not Respond
-

Possible Cause and Solution

INIT Conflicts

Remove all INITs except those absolutely needed from your System Folder and the ones copied from the CD-ROM device driver disk. If the CD-ROM drive functions correctly, reinstall the INITs one at a time, restarting the Macintosh after each one, until the problem is solved.

Symptom

- Low Performance of CD-ROM Application Software
-

Possible Cause and Solution

System Set for Virtual Memory

If your Macintosh is using System 7 and is in Virtual Mode, it may exhibit slow performance during real-time graphics and animation. This is because your hard disk drive and CD-ROM drive must use your computer's SCSI bus almost simultaneously. To remedy this, remove Virtual Mode from the system and restart the Macintosh.

Contacting Plextor's Technical Support Department



YOUR TASK: Learn the variety of methods you can use to contact Plextor's Technical Support Department. Learn what information you should gather before contacting Plextor's Technical Support Department.

YOUR OBJECTIVE: Know how to get in contact with Plextor if you experience any problems installing or operating your 12PleX CD-ROM drive.

YOUR METHOD: Store Plextor's e-mail, Web site, phone, fax, and BBS numbers in a convenient location. Keep your drive's serial number and a copy of your sales receipt handy, as well.

If you experience a problem while installing or operating your 12PleX drive, please refer first to the troubleshooting chapter (Chapter 12) in this manual. It contains solutions to the most common types of problems fielded by our technical support staff.



Our Technical Support Department will help you solve problems that relate specifically to your 12PleX drive. In many cases, a problem that appears to be caused by your CD-ROM drive actually originates in another part of your computer. In such instances, our technical support staff will try to help you identify the part (e.g., SCSI interface board) at fault, and will refer you to the manufacturer of that part for further assistance.

Although we think highly of the capabilities of our technical support staff, we recognize that they do suffer from some limitations; namely, they do not possess psychic or telepathic powers. Therefore, their ability to help you depends a great deal on your ability to help them. You must act as their eyes and ears as they try to diagnose and fix your problem. If you gather the information requested on the following page before you contact them, you will find that your problem can be resolved much more quickly.

Plextor's Technical Support Department is available Monday through Friday, 6:30 a.m. to 5:30 p.m., PST. We are closed on weekends and some holidays.

How to Contact

There are three ways for you to contact Plextor's Technical Support Department:

- 1) Send us e-mail at **support@plextor.com.**, or visit our Web site for answers to frequently asked questions.
- 2) Log on to our BBS (2400/9600/14.4/28.8/MNP, V.42bis) at 408-986-1569. You will find a great deal of useful information and software on our BBS. It includes:
 - Device drivers for various SCSI interface boards and soundboards (available only to those who have purchased these boards directly from Plextor).
 - Utilities to enhance the operation of your drive.
 - Discussions of various technical problems you might encounter, with suggestions as to how you might fix or circumvent them.In addition, you can upload questions you have about the installation or operation of your 12PleX drive. A member of Plextor's technical support staff will respond to your question either by phone or modem.
- 3) Send a fax to the attention of the Technical Support Department at 408-986-1010. Include your telephone number and the hours during which you can be reached. Be as detailed as possible in describing your problem. It typically is useful if you also send a printout of your AUTOEXEC.BAT and CONFIG.SYS files.
- 4) Call 800-886-3935 and select the technical support extension.

Before You Call/FAX/Log On



Please gather as much of this information as possible:

- ✓ The serial number of your CD-ROM drive (your serial number can be found both on the warranty card that accompanied the drive and on a label on the drive itself).
- ✓ The name and model number of your SCSI interface board (e.g., Future Domain TMC-1610, Adaptec AHA-1515, Trantor T-130).
- ✓ The version of the software device drivers that came with your SCSI interface board (this typically is found on the label of the floppy disk which contains the device drivers).
- ✓ The version of the Windows, DOS, Mac, Novell, OS/2 or UNIX operating system you are using.
- ✓ The brand name and model number of your computer (e.g., Dell 466/NP, Micron P66PCI Powerstation, ALR Evolution V, Apple Macintosh Performa 575).

- ✓ The type of VGA, Super VGA, or other graphics card you use.
- ✓ Brand name and model number of any other peripherals you have installed/connected to your computer (e.g., scanner, fax board, network board).

Returns

You must receive an RMA (Returned Materials Authorization) number from the Technical Support Department before any Plextor CD-ROM drive can be returned for repair or replacement. Any drive sent to Plextor without an RMA number will not be accepted. Drives must be sent postage prepaid. We recommend that you insure your shipment, as Plextor cannot be held responsible for any damage that may occur during shipment.

Helpful Contacts (Phone/ FAX/ BBS/ Web)



COMPANY <i>Product</i>	PHONE	FAX	BBS <i>Web address</i>
Adaptec <i>SCSI interface boards</i>	408-945-8600	408-262-2533	408-945-7727 www.adaptec.com
AMC <i>Audio cables</i>	206-882-0587	206-861-8391	— cust.svc@amcdirect.com
Basin Comp. <i>SCSI interface boards</i>	800-238-4453	818-598-0110	818-597-0275
Diamond <i>Soundboards</i>	408-736-2000	408-325-7000	408-524-9301 www.diamond.com
DPT <i>SCSI interface boards</i>	407-830-5522	407-260-5366	407-830-1070 www.dpt.com
DTC <i>SCSI interface boards</i>	408-942-4000	408-942-4052	408-942-4010 www.datatechnology.com
Future Domain <i>SCSI interface boards</i>	714-455-8100	714-253-0429	714-253-0432 www.adaptec.com
FWB <i>Mac device drivers</i>	415-325-4392	415-833-4653	— www.fwb.com
Pacific Inter Connects <i>Audio cables</i>	408-654-0234	408-982-9329	— www.piccable.com
Plextor <i>Recommend SCSI soundboards, audio cables, and all other technical support needs</i>	408-980-1838	408-986-1010 / 408-986-1569	www.support@plextor.com
Trantor <i>SCSI interface boards and Mac device drivers</i>	(see Adaptec listing)		

Specifications

	PX-12XSi Internal	PX-12XSe External
Disc		
Useable Formats	CD-ROM Mode 1; CD-DA; CD-I; Video CD (MPEG); CD-ROM XA Mode-2, Form 1, Form 2; Photo CD CD Plus; CD-G, Karaoke	CD-ROM Mode 1; CD-DA; CD-I; Video CD (MPEG); CD-ROM XA Mode-2, Form 1, Form 2; Photo CD CD Plus; CD-G, Karaoke
Disc Diameter	12 cm. (60 min. & 74 min.)	12 cm. (60 min. & 74 min.)
Rotational Speed at 12X	Inner Track: 6360 rpm Outer Track: 2400 rpm	Inner Track: 6360 rpm Outer Track: 2400 rpm
Performance		
Data Transfer Rate	1800 KB/sec.;	1800 KB/sec.;
Sync	Burst: 10 MB/sec.	Burst: 10 MB/sec.
Async	Burst: 5.0 MB/sec.	Burst: 5.0 MB/sec.
Access Speeds:		
Full stroke	220 ms	220 ms
One-third Stroke	150 ms	150 ms
Random Access	105 ms	105 ms
Random Seek	95 ms	95 ms
Data Buffer	512 KB	512 KB
Optical Pickup		
Laser	Semiconductor	Semiconductor
Side Mechanism	Linear Motor	Linear Motor
Spindle Motor	Brushless	Brushless
Error Rate	Mode 1: 1 Block/10 ¹² Bits; Mode 2: 1 Block/10 ⁹ Bits	Mode 1: 1 Block/10 ¹² Bits; Mode 2: 1 Block/10 ⁹ Bits
Front Panel		
Indicator (LED)	DISC IN; Power ON/BUSY	DISC IN; Power ON/BUSY
Disc Loading	Automatic; standard caddy	Automatic; standard caddy
Headphone Jack	Stereo mini-jack, 0.9V at 32 Ohms	Stereo mini-jack, 0.9V at 32 Ohms
Volume Control	Wheel Knob	Wheel Knob
Play Button	Play, Forward, Skip	Play, Forward, Skip
Stop/Eject Button	Stop, Eject	Stop, Eject

	PX-12XSI Internal	PX-12XSe External
Rear Panel		
Power Supply	DC +5V, 0.9A (1.0A Peak); DC +12V, 0.7A (1.8A Peak)	AC 100-240V 50/60 Hz., 0.3A (Auto Switching)
Power Switch	—	Tumbler Type: 3A, 250V
Interface Connector	SCSI, 50-Pin Header Type	SCSI, Two 50-Pin High-density Connector
Audio Output	Analog Output, Molex Connector (P/N 50083-8014 4-pin) Use Molex Housing (P/N 51030-0430 4-pin)	Analog Output, RCA Jacks
Jumper Switches	SCSI ID, Parity, Term, Test, Block, Eject	—
DIP Switch	—	Parity, Term, Test Block, Eject
Rotary Switch	—	SCSI ID
Environmental Conditions		
Operating		
Temperature	0 to 45 degrees Celsius	0 to 45 degrees Celsius
Humidity	20 to 80% Noncondensing	20 to 80% Noncondensing
Storage		
Temperature	-40 to 60 degrees Celsius	-40 to 60 degrees Celsius
Humidity	5 to 95% Noncondensing	5 to 95% Noncondensing
Dimensions and Weight		
Dimensions (W/H/D)	5.79" x 1.64" x 7.95"	7.0" x 2.24" x 12.03"
Weight	2.4 lbs.	5.7 lbs.
Reliability		
MTBF	100,000 POH	100,000 POH
Caddy Loading	200,000 load cycles	200,000 load cycles
Tray Loading	10,000 load cycles	10,000 load cycles

ABOUT PLEXTOR

Plextor is a subsidiary of the Shinano Kenshi Company (SKC), Ltd. SKC's roots stretch back to 1918, when it began to manufacture textiles in Japan's northern prefecture of Nagano. (Nagano, incidentally, will be the site of the 1998 Winter Olympics.) SKC's involvement in the electronics industry started in 1962, when it diversified into the production of stepper motors for commercial audio products. SKC is now one of the world's largest manufacturers of small motors used in hard disks, floppy disks, tape drives, copy machines, video cameras—and your Plextor CD-ROM drive.

Over the past decade, SKC has developed a reputation as an innovator in compact disc and CD-ROM technology. In 1992 it was the second company to begin shipments of double speed CD-ROM drives. In 1994, it was the first company to begin shipments of half-height quad speed CD-ROM drives. In early 1995, SKC was the first company to ship a six speed CD-ROM drive. In early 1996, they shipped the first professional quality eight speed CD-ROM drive. SKC also is a leading manufacturer of compact disc players used for industrial and commercial applications (e.g., background music players for retail stores, restaurants, and shopping centers).

Plextor acts as SKC's sales, service, and support arm throughout the world. In addition to CD-ROM drives, Plextor also sells under its own label professional audio equipment used by radio stations, high-speed printing presses, and a CD encoding system developed by SKC that can pack up to eight hours of audio onto a single compact disc.

Plextor's home office is in Tokyo. Plextor first opened an office in California's Silicon Valley in 1990. Rapid growth has required it to move twice since then to larger offices. Plextor now occupies a 30,000 sq. ft. facility in Santa Clara, California, which is staffed by sales, marketing, technical support, engineering, administrative, and shipping personnel. Our European office (in Brussels) began operation in 1994.

Plextor's CD-ROM Drives					
	MODEL	INTRODUCED	DATA TRANSFER RATE	ACCESS TIME	BUFFER SIZE
1st generation	DM-3020/5020	1990	150KB/sec	430ms	64KB
2nd generation	DM-3021/5021	1991	150KB/sec	340ms	64KB
3rd generation	DM-3024/5024	1992	300KB/sec	265ms	64KB
4th generation	DM-3028/5028	1993	335KB/sec	240ms	64KB
5th generation	PX-43CH/45CH	1994	600KB/sec	220ms	1 MB
6th generation	PX-43CS/45CS	1994	600KB/sec	170ms	256KB
7th generation	PX-63CS/65CS	1995	900KB/sec	145ms	256KB
8th generation	PX-43CE/45CE	1995	675KB/sec	130ms	256KB
9th generation	PX-83CS/85CS	1996	1200KB/sec	115ms	256KB
10th generation	PX-12CS/12TS	1996	1800KB/sec	105ms	512KB

Warranty Information

PLEXTOR CORP. ("PLEXTOR") warrants your 12PleX CD-ROM drive against any defect in material and workmanship, under normal use, for a period of two years following its date of purchase. In the event this product is found to be defective within the warranty period, PLEXTOR will, at its option, repair or replace the defective CD-ROM drive.

This warranty is void if: a) the drive is operated or stored under abnormal use and maintenance conditions; b) if the drive is repaired, modified, or altered, unless such repair, modification, or alteration is expressly authorized in writing by PLEXTOR; c) if the drive is subject to abuse, neglect, lightning strike, electrical fault, improper packaging, or accident; d) if the drive is installed improperly; or e) if the serial number of the drive is defaced or missing.

PLEXTOR will not, under any circumstances, be liable for direct, special, or consequential damages such as, but not limited to, damage or loss of property or equipment, loss of profits or revenues, cost of replacement goods, or expense or inconvenience caused by service interruptions. Under no circumstances will any person be entitled to any sum greater than the purchase price paid for the drive.

To obtain warranty service you may contact PLEXTOR's Technical Support Department by calling 800-886-3935. They will attempt to diagnose and correct your problem by phone. If the drive does not function properly they will issue a Return Material Authorization (RMA) number. You may be asked to furnish proof of purchase to confirm that the drive is still under warranty.

All 12PleX CD-ROM drives returned to PLEXTOR must be securely packaged and shipped postage prepaid. All product returns must be authorized in advance by PLEXTOR's Technical Support Department. Authorization is confirmed by issuance of the RMA number, which must be written prominently on the outside of the box in which the defective drive is returned to PLEXTOR.

Inside back cover



PLEXTOR (U.S.A.)
4255 Burton Drive, Santa Clara, CA 95054
Web Site: www.plextor.com
e-mail: support@plextor.com
Phone: 408-980-1838
FAX: 408-986-1010 BBS: 408-986-1569
Toll Free: 800-886-3935

PLEXTOR (Japan)
Ueno YHK Building, 7th Floor
7-6 Ueno 7-chome, Taito-ku, Tokyo 110
Phone: 81-3-3847-8281 FAX: 81-3-3847-8288

PLEXTOR (Europe)
Excelsiorlaan 1, 1930 Zaventem, Belgium
Phone: 32-2-725-5522 FAX: 32-2-725-9495