

DATA PRODUCTS

B600/B1000

POWER CORD AND IOU 30R INSTALLATION

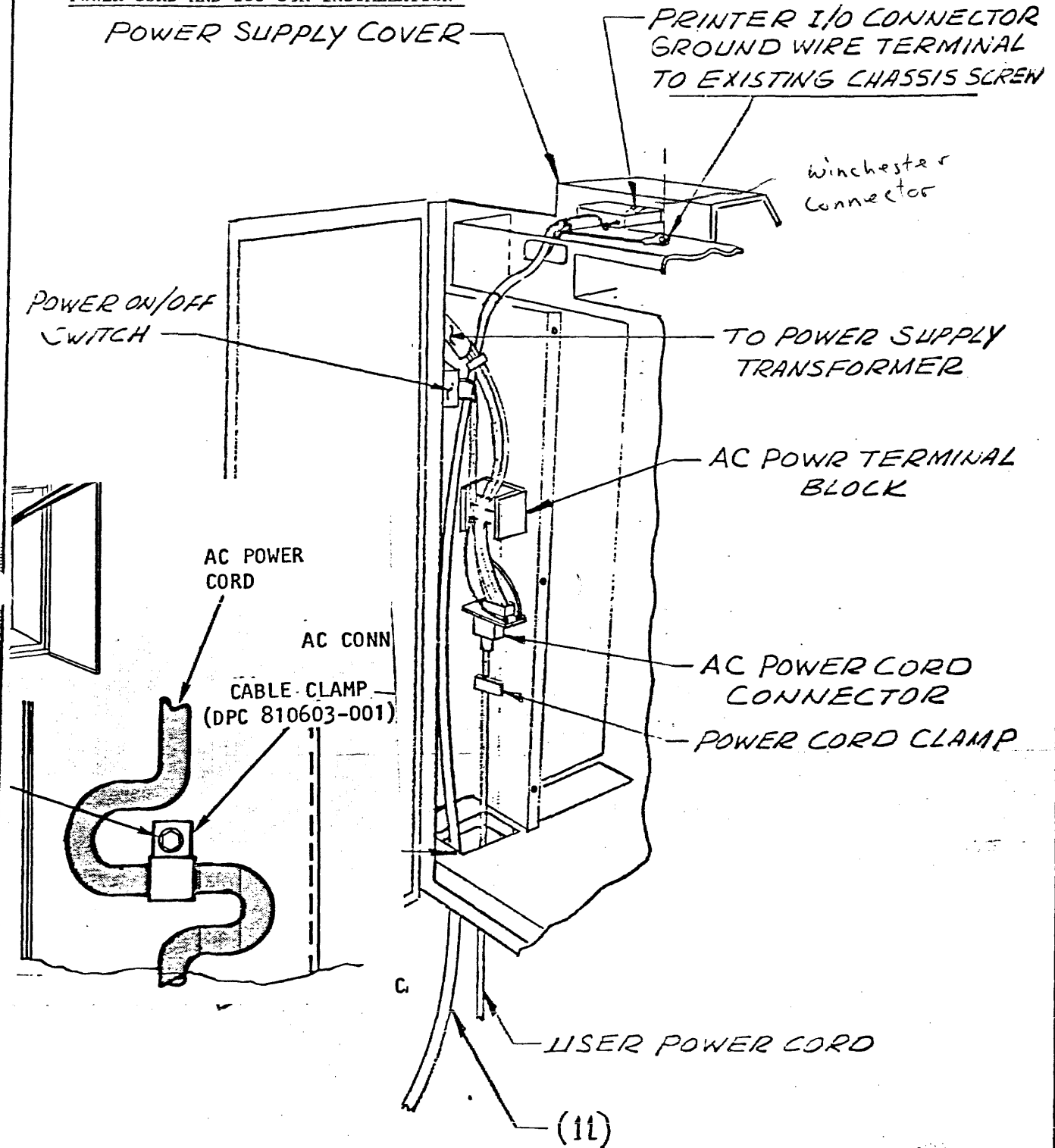

INSTALL POWER CORD AND IOU 30R CABLE

SHEET
3 OF 3

DRAWING NO.
A22073

REV
A

DIRECT CONFIGURATION

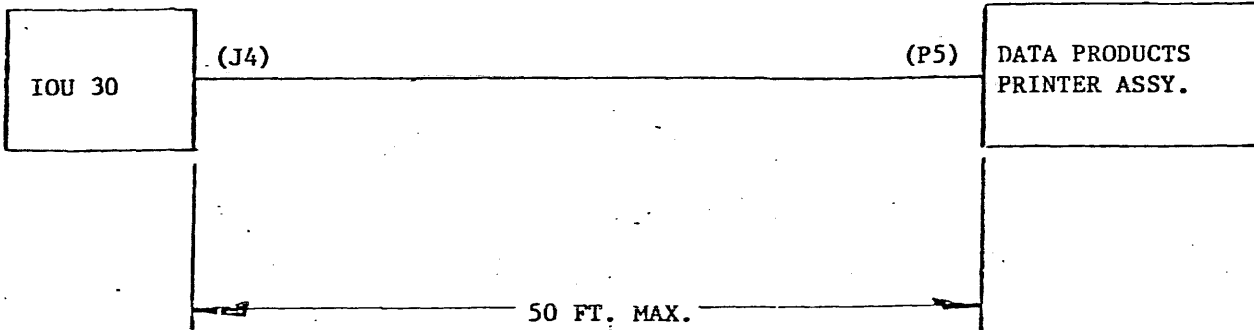

QANTEL PART # MDS CROSS REFERENCE #

M44043 - 00Z

Z = LENGTH

-001 = 12 FT.

042597901

-002 = 25 FT.

042597701

-003 = 50 FT.

042598001

want support Line Drivers

SHEET

DRAWING NO.

REV

Standard Interface Signals

Ready - A PRINTER generated signal which indicates that the printer is ready to be put ON LINE by the printer operator.

When READY is true, the following are true:

- A. Power and DC voltages are on
- B. All interlocks are closed
- C. Paper has been loaded
- D. No printer fault exists
- E. The Alarm light is off

On Line - A PRINTER generated signal which indicates that the printer has been put ON LINE. When ON LINE is true, the following are true:

- A. The Alarm light is off
- B. The printer operator has depressed the ON LINE switch
- C. The printer is ready to accept data from the user
- D. The print inhibit switch is off

Demand Line - A PRINTER generated signal which synchronized data transmission between the printer and the user system. The DEMAND LINE signal requests a character from the user and remains active until the DATA STROBE is received. After the data character has been loaded into the printer, the DEMAND LINE will go inactive.

DEMAND LINE will never be active unless ON LINE is active.

Data Strobe - A USER generated signal which defines when information on the data line is stable and may be stored in the printer buffer. Each time a Data Strobe occurs, the printer samples the Data Lines. After the data lines have been sampled, the DEMAND LINE signal will go inactive. Strobe should be held active until Demand goes inactive. Once a format control character has been transferred to the printer, the DEMAND LINE will remain inactive until printing is complete. Handshaking for the format control character and for print data is identical.

Data Lines - Seven (7) user generated data lines which carry print data codes and format control codes. The data is transferred to the printer memory when the STROBE signal is high. An additional data line is used if Parity data is sent along with the data code.

Interface Verification - Two interface connector pins are jumpered together to allow the user to verify that the interface connector is plugged into the printer.

QANTEL WINCHESTER PIN ASSIGNMENTS
IOU 30 TO B/600 - B/1000

IOU30

Printer

SIGNAL	J4	P5	SIGNAL	J4	P5
READY	23	CC	DATA 1	3	B
RTN	24	EE	RTN	4	D
ON LINE	25	y	DATA 2	5	F
RTN	25	AA	RTN	6	J
DEMAND	21	E	DATA 3	7	L
RTN	22	C	RTN	8	N
VFU RDY	27	W	DATA 4	9	R
RTN	28	U	RTN	10	T
INTERFACE CON	35	v	DATA 5	11	V
VERIFY	36	x	RTN	12	X
PAPER INST.	17	p	DATA 6	13	z
RTN		s	RTN	14	b
DATA STROBE	1	j	DATA 7	15	n
RTN	2	m	RTN	16	k

10u30

10U-30
DATA PRODUCTS 2230/2260
QANTEL MODEL 5049

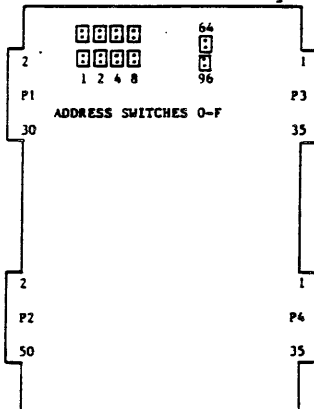

MAX. PWR. REQUIREMENTS

+5V = .71A

PRINTER POWER

115 VAC 60 HZ.
9.0A FOR 2.0 SEC.
4.6A NORMAL

PRINTER HEAT GEN.

1840 BTU/HR.

STATUS IN INSTRUCTIONS

4XY90 X-DEV. ADDRESS
YY=STATUS BYTE

STATUS MEANING

BYTE	MEANING
01	ALWAYS ZERO
02	WRITE BUSY
04	END
08	SERVICE REQUEST
10	INTERRUPT
20	VFU LD. REQUEST
40	ALWAYS ONE
80	INOPERABLE

WRITE CONTROL INSTRUCTIONS

1.XYY90 X= DEVICE ADDRESS YY= CONTROL BYTE

CONTROL BYTE	FUNCTION
00	SLEW TO CHANNEL 0 (TOP OF FORM)
01	SLEW TO CHANNEL 1
02	SLEW TO CHANNEL 2
03	SLEW TO CHANNEL 3
04	SLEW TO CHANNEL 4
05	SLEW TO CHANNEL 5
06	SLEW TO CHANNEL 6
07	SLEW TO CHANNEL 7
08	SLEW TO CHANNEL 8
09	SLEW TO CHANNEL 9
0A	SLEW TO CHANNEL 10
0B	SLEW TO CHANNEL 11 (BOTTOM OF FORM)
0X	SLEW TO LINE X
1X	SLEW X LINES
20	RESET ALLOW TERMINATION INTERRUPT
60	SET ALLOW TERMINATION INTERRUPT
EE	START DAVFU MEMORY LOAD
EF	STOP DAVFU MEMORY LOAD

1-8

Revised 11/77

Parallel Interface

B300/B600 Front View

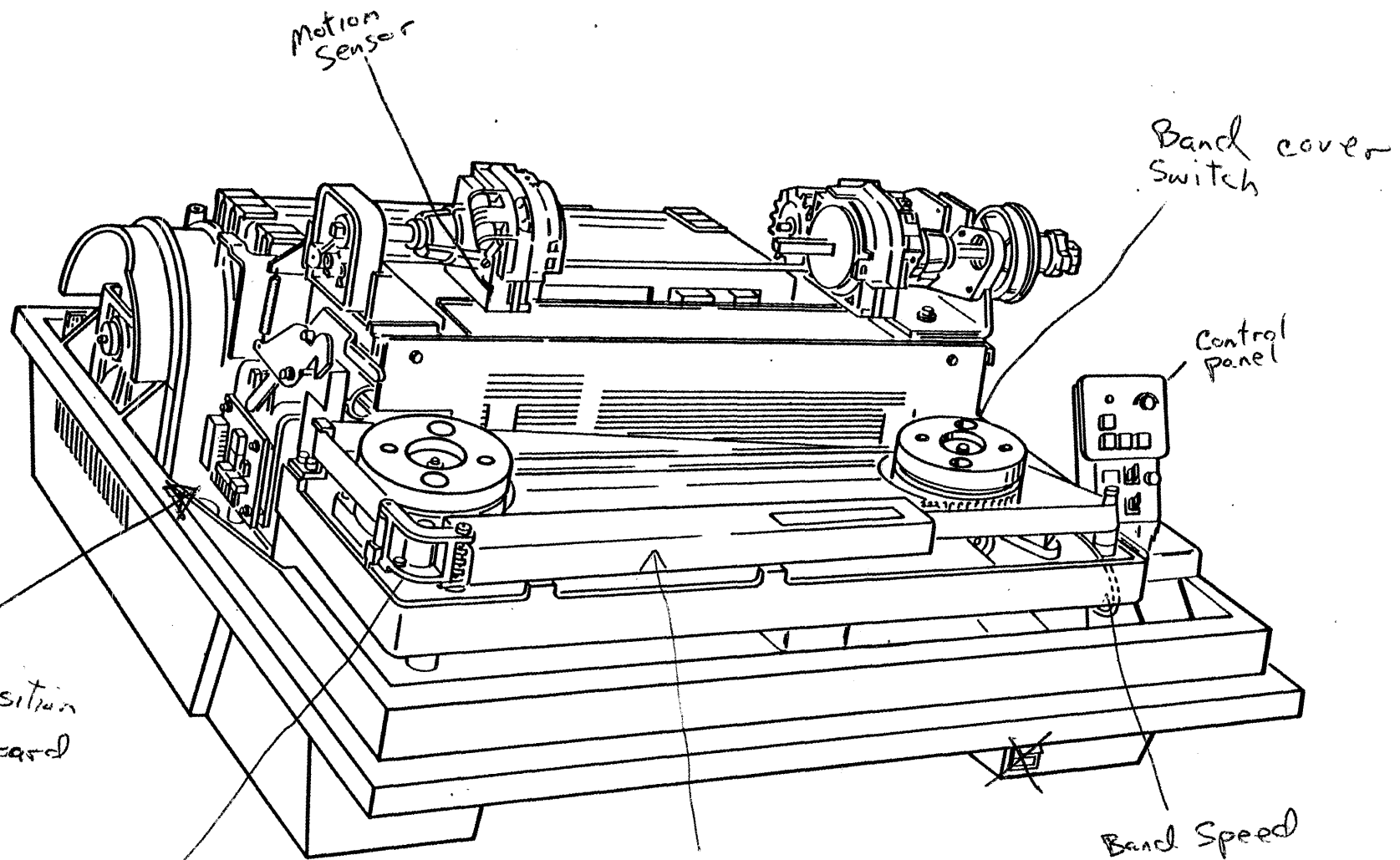

Motion Sensor

Band cover Switch

Control panel

Band Speed Transducer

Band I.D.

Ribbon Cassette
Shake ribbon to one end prior to installation of ribbon

Ribbon Drive Rollers

Interface Transition Detector Board

1-2

Reset Boards
at Installation

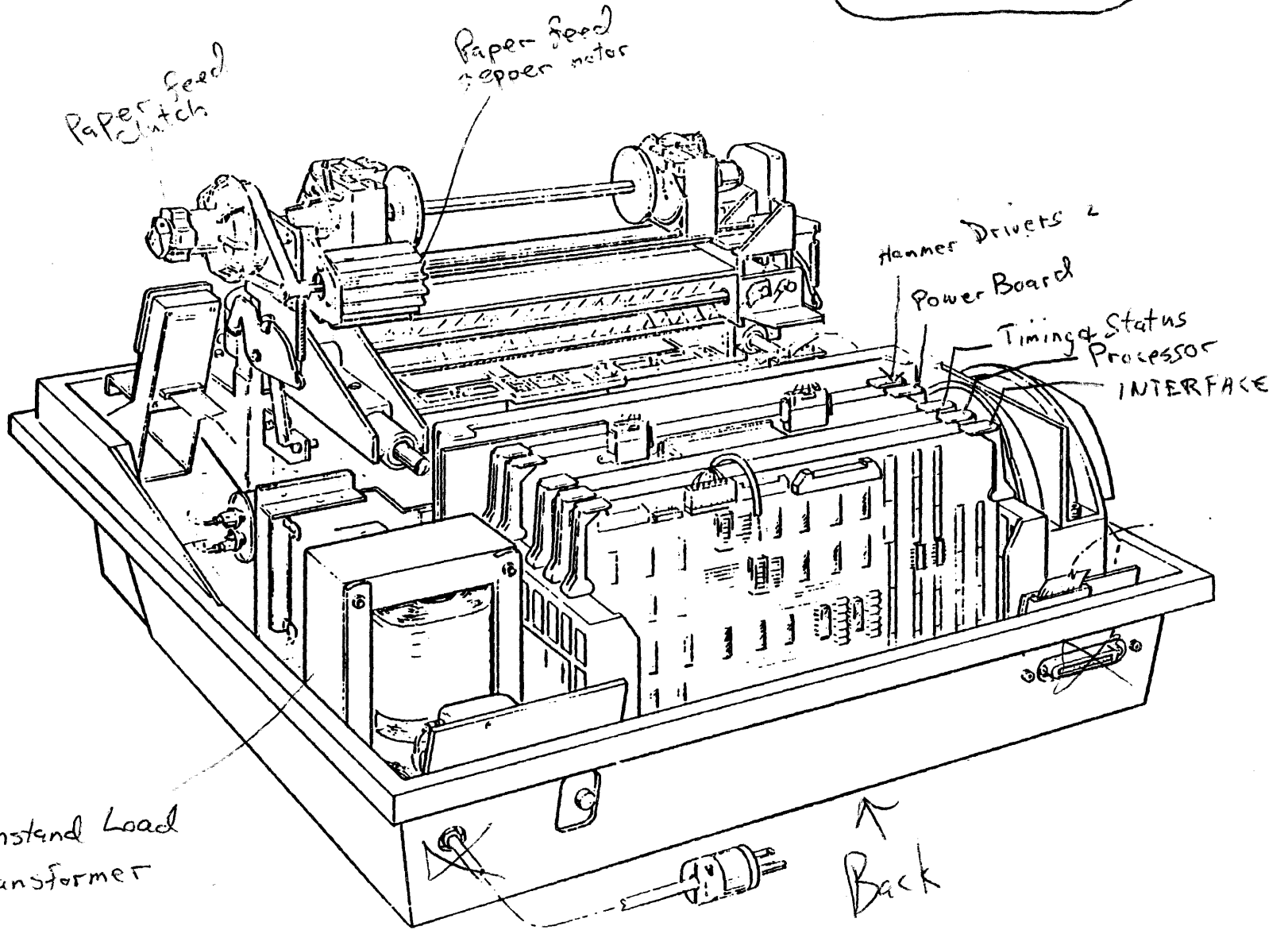

B500/B600 Rear View

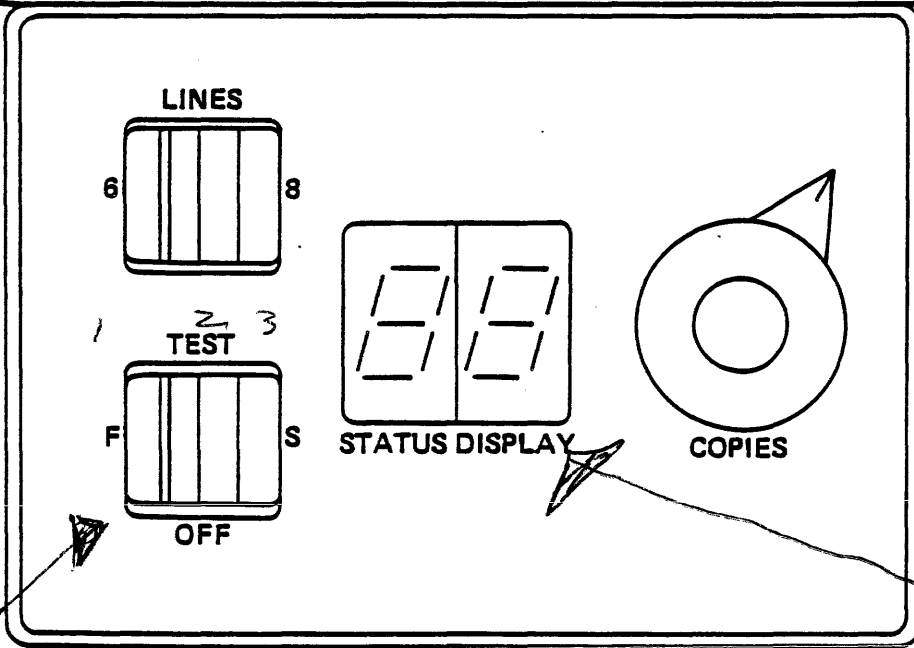
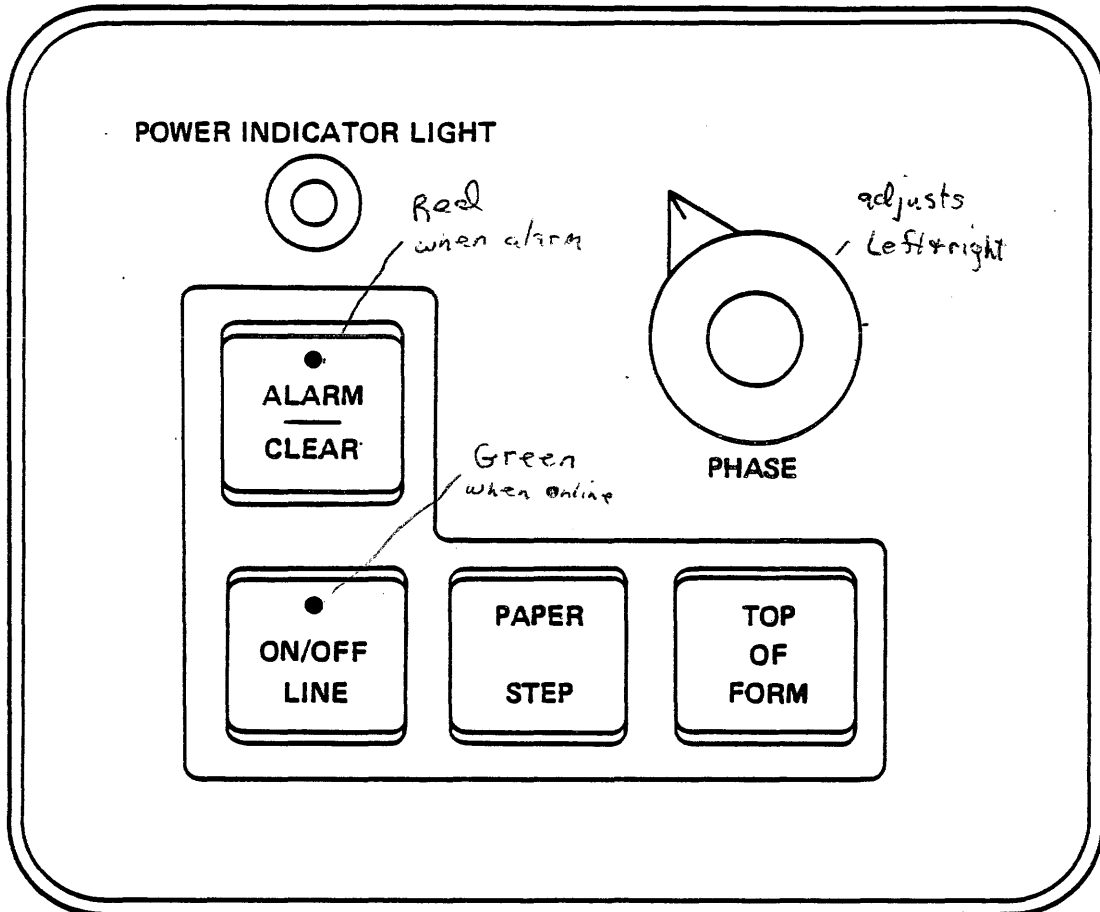

FLSS switch should always be in VFU pass.

status after power up should be 10. Should be 77 after VFU is loaded.

- 1 = all Hi (1000 lines/min on 1000 LPM)
 - 2 = normal or band image (500 LPM on 1000 LPM)
 - 3 = sliding pattern
- Operator Control Panel

DIAGNOSTIC DISPLAY	INDICATION/DEFINITION	CORRECTIVE ACTION
01	PAPER SUPPLY LOW	1
02	PAPER MOTION FAULT	1
03	BAND TENSION OR COVER NOT CLOSED	2
04	HAMMER BANK NOT CLOSED	2
05	UNDEFINED BAND LOADED	1
06	RIBBON MOTION FAULT	1
08	UNDEFINED FORM LENGTH SELECTED	2
09	NO TAPE IN READER	1
10	VFU MEMORY NOT LOADED	1
11	TAPE READER JAM	1
12	NO TOP OF FORM IN TAPE	1
13	TAPE TOO LONG	1
14	CHANNEL NOT FOUND	1
15	UNABLE TO READ TAPE	1
16	SINGLE LINE PRINT MODE	
17	LOSS OF SYNC.	1
20	HUNG IN PRINT - UNPRINTABLE DATA	1
21	PRINT INHIBIT, OFF LINE	1
22	INTERLOCK CABLE ERROR	3
23	I/O PARITY ERROR DURING NORMAL DATA LOAD	1
24	EIGHT CONSECUTIVE CARRIAGE RETURNS	1
25	FORMAT CODE NOT RECOGNIZED	1
26	DAVFU STOP CODE ERROR	1
27	DAVFU DATA TRANSFER > 143 (8F ₁₂)	1
28	VFU CHECK SUM ERROR	1
29	I/O PARITY ERROR DURING DAVFU LOAD	1
30	VFU MEMORY CHECK ERROR	1
40	BAND SPEED FAULT	3
41	PAPER SYSTEM FAULT - CLAMPS	3
42	ODD HAMMER CURRENT FAULT	3
43	EVEN HAMMER CURRENT FAULT	3
44	+12 VOLT FAULT	3
45	-9 VOLT FAULT	3
46	VCL FAULT	3
47	+38 VOLT FAULT	3
48	TRANSDUCER FAULT	3
49	BAND CURRENT FAULT	3
50	SYSTEM STATUS FAULT OF UNIDENTIFIED CAUSE	3
66	SELF TEST, PRINT INHIBIT	
67	SELF TEST, NORMAL	
76	PRINT INHIBIT, ON LINE	
77	NORMAL ON LINE	
88	OFF LINE READY (LAMP TEST)	
P	5V FAULT	
H	AIRFLOW FAULT (OVER TEMPERATURE)	
C	CLOCK FAULT	

"CLEARED BY"

1. PRESS ALARM/CLEAR SWITCH
2. CORRECT ERROR OR CHANGE STATUS
3. TURN PRINTER OFF AND ON

Status Indications

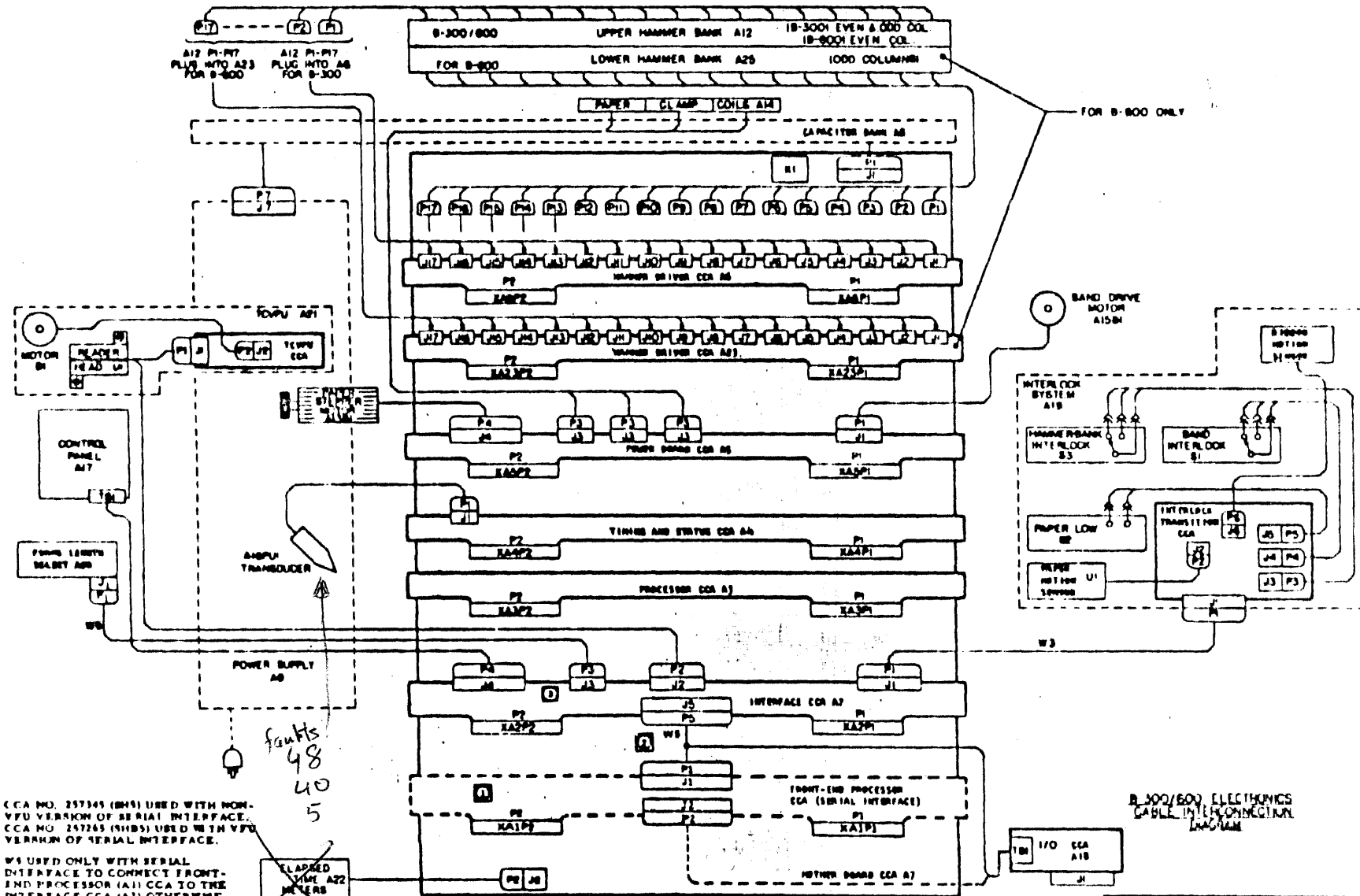

- ① CCA NO. 257345 (MNS) USED WITH NON-VFD VERSION OF SERIAL INTERFACE. CCA NO. 257245 (MHS) USED WITH VFD VERSION OF SERIAL INTERFACE.
- ② WS USED ONLY WITH SERIAL INTERFACE TO CONNECT FRONT-END PROCESSOR (A1) CCA TO THE INTERFACE CCA (A2) OTHERWISE A1P5 GOES DIRECTLY TO THE I/O MARNLS6 ASST.
- ③ A1 IS INSTALLED ONLY WHEN SERIAL INTERFACE IS INSTALLED.

~~RELAY A22
METERS~~

faults
48
40
5

B-300/600 ELECTRONICS
CABLE IN CONNECTION
MARNLS6

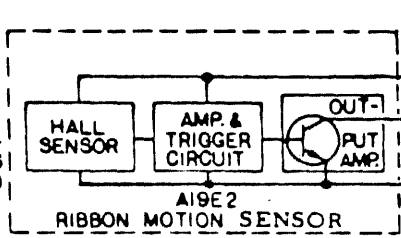
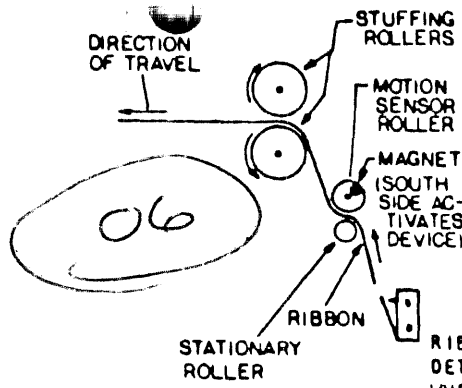

RIBBON JAM DETECTOR-ACTIVATED WHEN PIVOT ARM OPENS

ALL SWITCHES ARE SHOWN IN THEIR ENERGIZED POSITIONS FOR NORMAL PRINTER OPERATION.

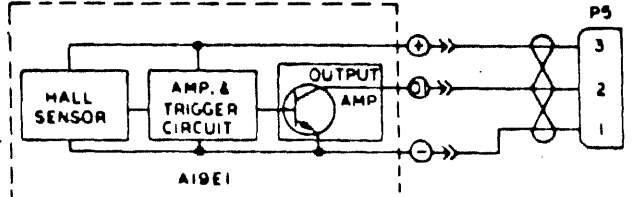
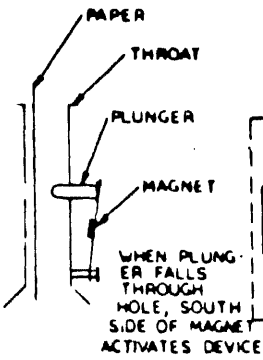
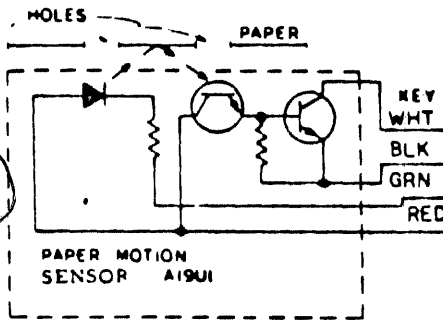
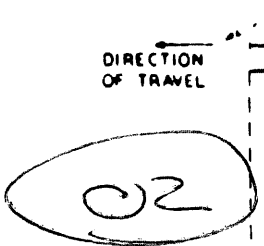
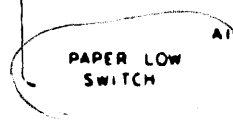
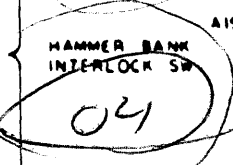
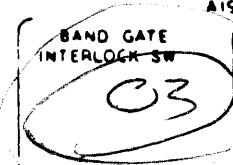
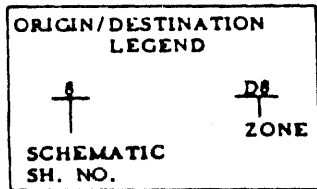

HALL PAPER LOW SENSOR IS INTERCHANGEABLE WITH SWITCH S2.

SUPPLY AND LOAD CONNECTIONS

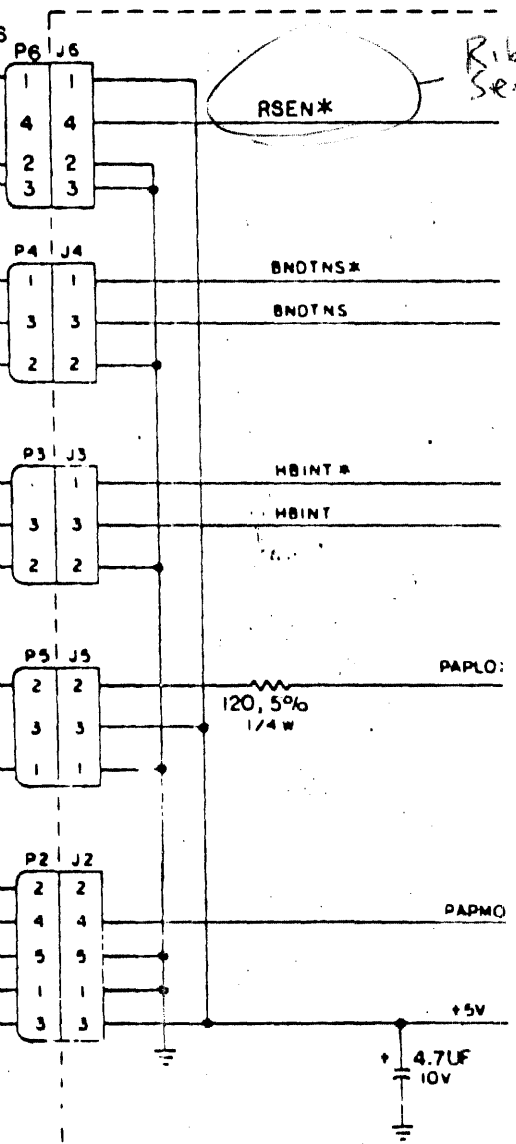

INTERLOCK TRANSITION CCA A19

Ribbon Sense

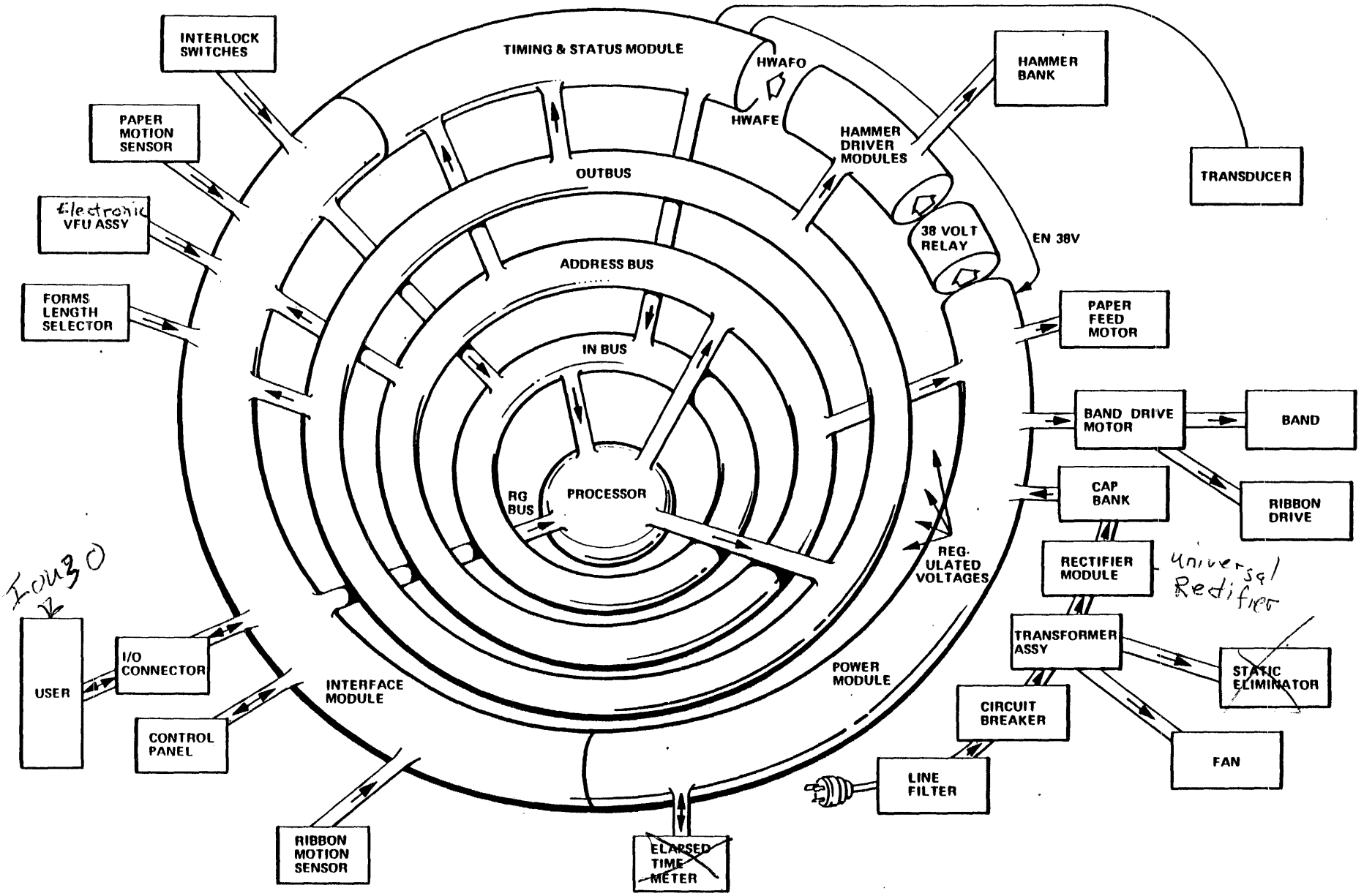

System Block Diagram

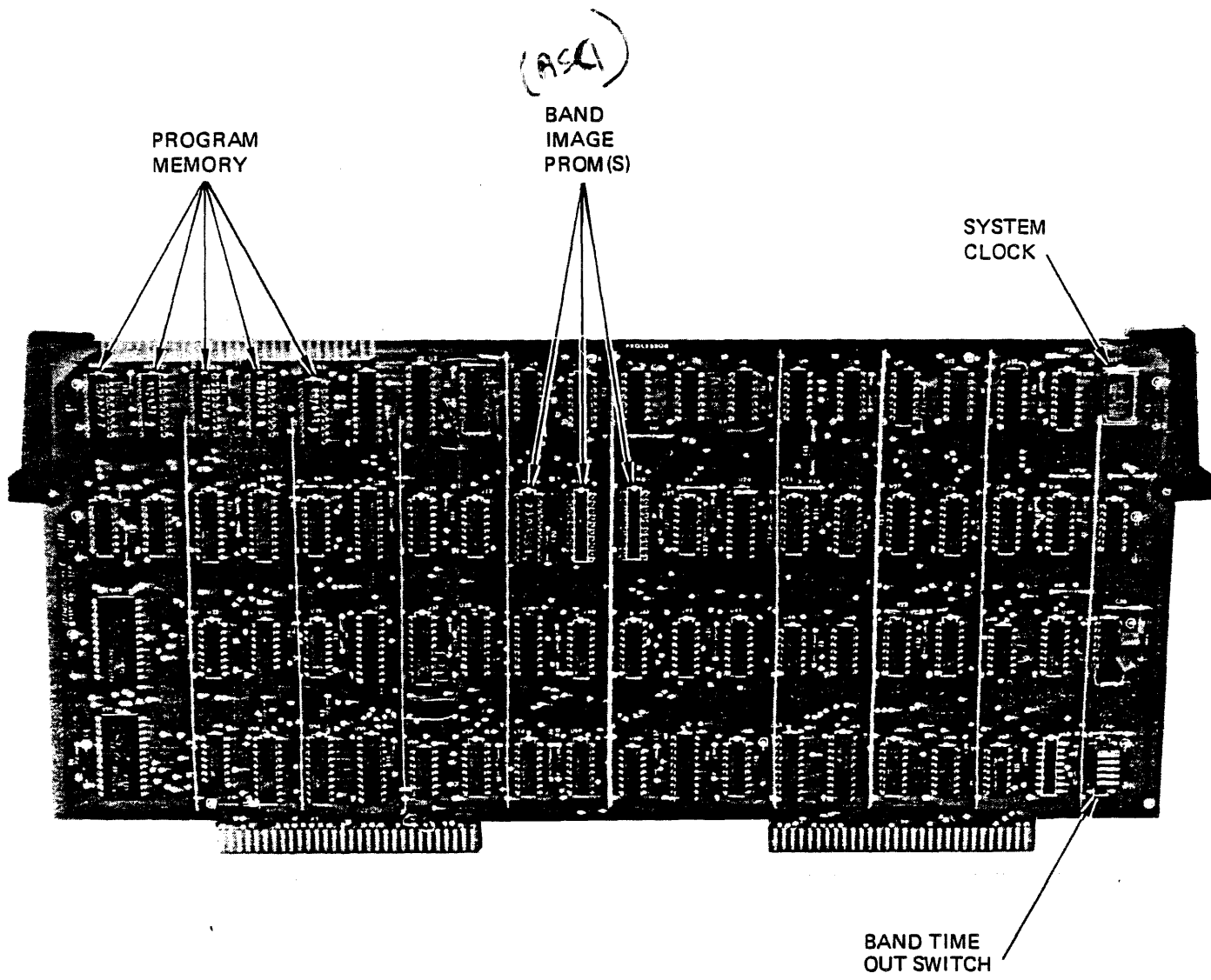

SWITCH SETTINGS					TIME OUT	
S1-1	S1-2	S1-3	S1-4	S1-5	B-100	B-600
ON	OFF	OFF	OFF	OFF	2.0 SEC.	1.8 SEC.
OFF	ON	OFF	OFF	OFF	4.1 SEC.	3.5 SEC.
OFF	OFF	ON	OFF	OFF	8.1 SEC.	7.0 SEC.
OFF	OFF	OFF	ON	OFF	16.3 SEC.	14.0 SEC.
OFF	OFF	OFF	OFF	ON	32.6 SEC.	28.1 SEC.

Processor Module

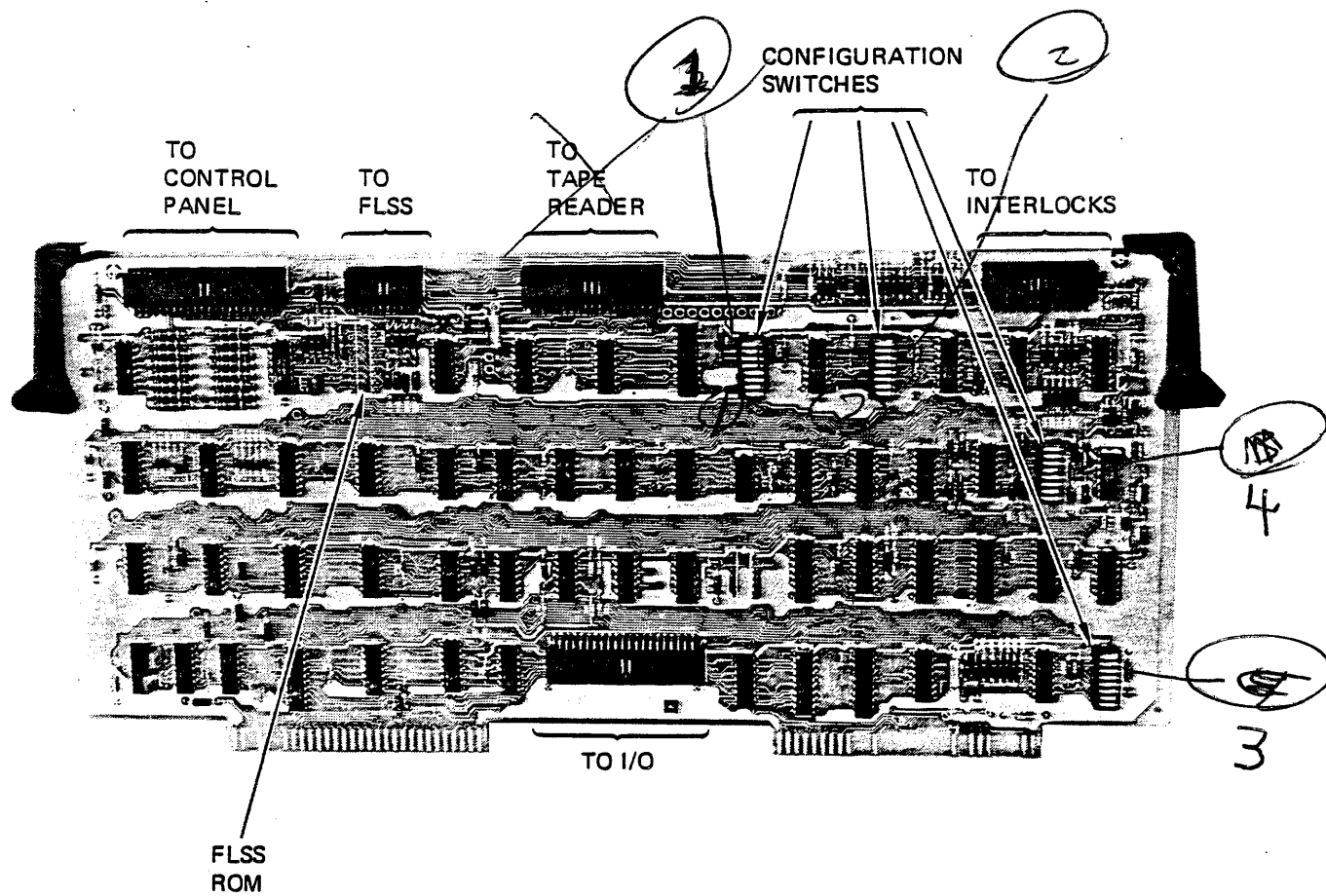

Interface Module

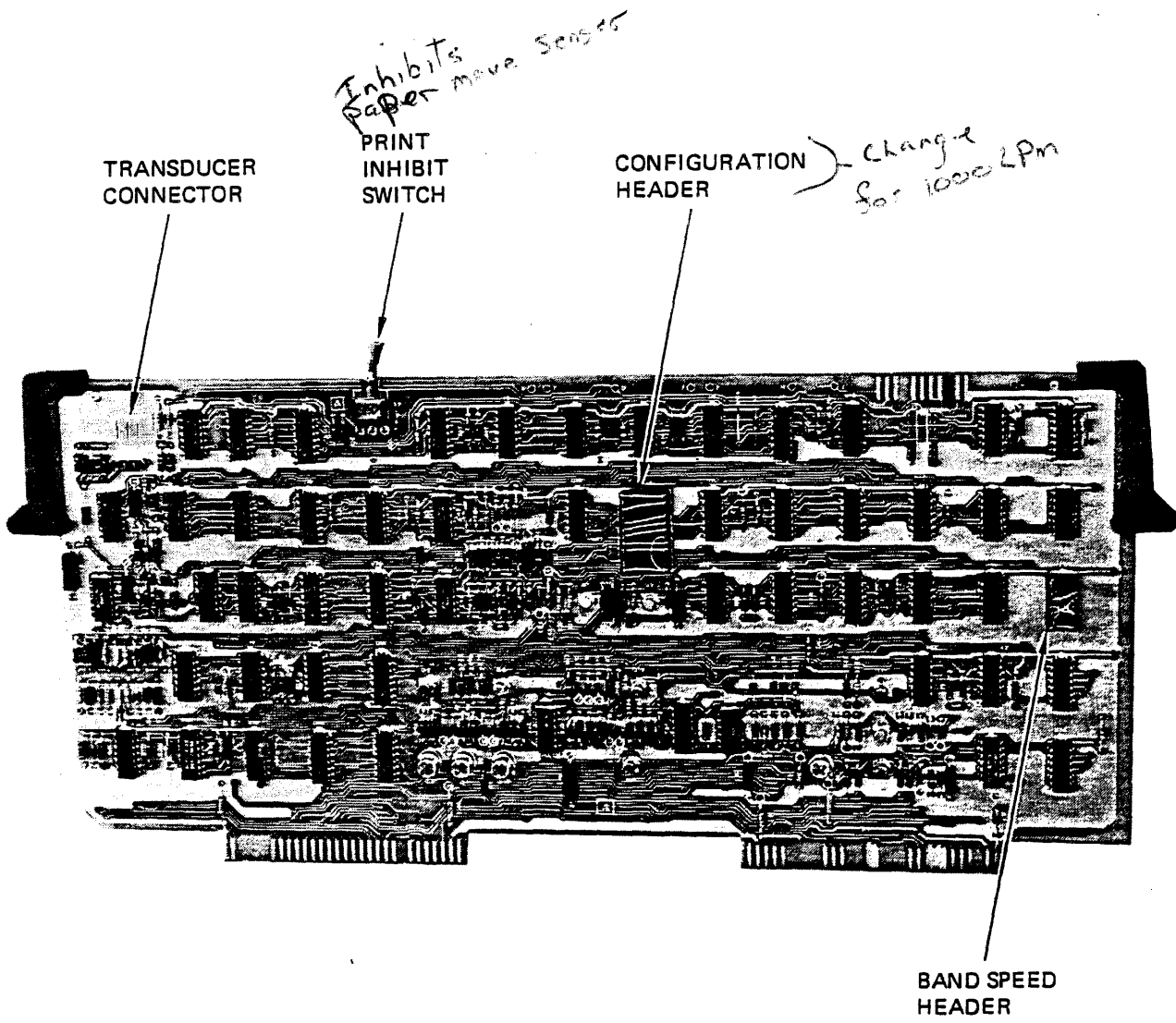

Timing and Status Module

INTERFACE CCA SWITCH SETTINGS

-MDS SERIES AND QANTEL SYSTEMS SWITCH SETTINGS SAME FOR SWITCH 1-

MDS QANTEL

X	X	Sw1-1 off = VFU Verify (N/U) indicates VFU option is not available.
X	X	Sw1-2 off = enables PI when VFU option installed.
X	X	Sw1-3 on = 7 bit interface.
X	X	Sw1-4 on = BUFFER CLEAR (N/U) left floating.
X	X	Sw1-5 off = high true interface.
X	X	Sw1-6 off = 8 bit open to Parity Generator.
X	X	Sw1-7 on = PI 8 bit to Parity Generator.
	X	Sw1-8 off = disable Parity Enable output (N/U).
X		Sw1-8 off = disable Parity Enable output.

-MDS SERIES AND QANTEL SYSTEMS SWITCH SETTINGS VARY FOR SWITCH 2-

X	X	Sw2-1 off = CR will be interpreted as a carriage return only.
	X	Sw2-2/3 on/off = 0 Lines Skipover.
X		Sw2-2/3 off/off = 3 Lines Skipover.
X	X	Sw2-4 off = Print to BOF after paper out detected.
	X	Sw2-5 off = 8 consecutive CR's max.
X		Sw2-5 on = Up to 140 CR's accepted by the Printer.
X	X	Sw2-6 off = 11 inch form length, disabled by FLS option.
X	X	Sw2-7 off = enable S2-2 and S2-3.
X	X	Sw2-8 N/U.

-MDS SERIES AND QANTEL SYSTEMS SWITCH SETTINGS VARY FOR SWITCH 3-

MDS QANTEL

- X Sw3-1 off = VFU Skipover disabled.
- X Sw3-1 on = VFU Skipover enabled.
- X X Sw3-2/3 off/off = BOF Channel 12.
- X X Sw3-4 N/U.
- X X Sw3-5 off = 12 channel tape reader not available.
- X Sw3-6/8 on/off = reports VFU ready status on PRMV interface line (N/U).
- X Sw3-6/8 off/off = reports paper moving status on PRMV interface line.
- X X Sw3-7 off = TOF = Channel 1.

-MDS SERIES AND QANTEL SYSTEMS SWITCH SETTINGS VARY FOR SWITCH 4-

- X X Sw4-1/2 off/off = Data 5 will be used to decode channel or skip commands, logic false = channel command, logic true = skip command.
- X Sw4-3 off = 15 lines maximum skip.
- X Sw4-3 on = 63 lines maximum skip.
- X X Sw4-4 off = not 1403 compatible.
- X X Sw4-5 off = Step Count Truncate option disabled.
- X Sw4-6/7/8 N/U.

PROCESSOR CCA SWITCH SETTINGS

BAND TIMEOUT

- X S1-1 = 1.8 sec.
- S1-2 = 3.5 sec.
- S1-3 = 7.0 sec.
- S1-4 = 14.0 sec.
- X S1-5 = 21.8 sec.

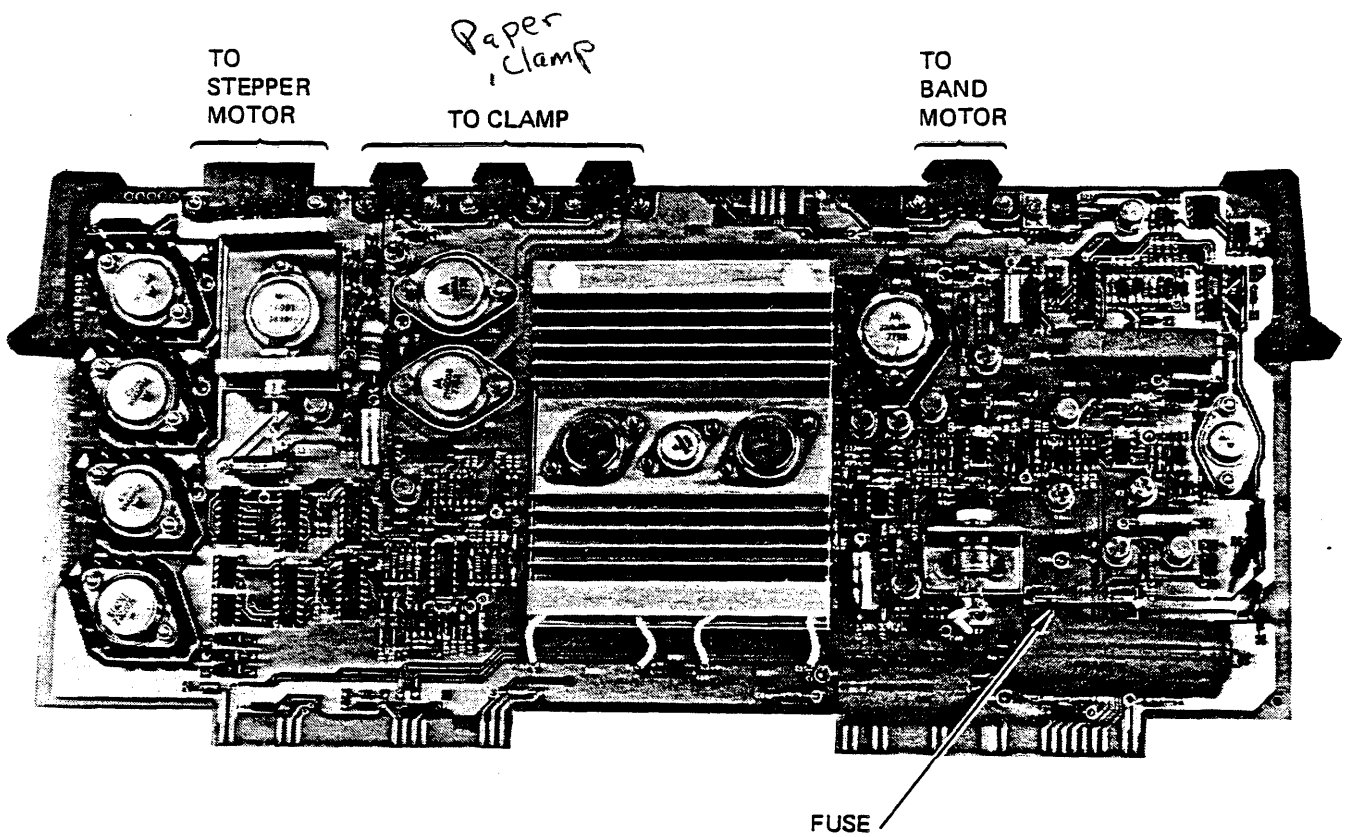

Power Module

TO HAMMERS

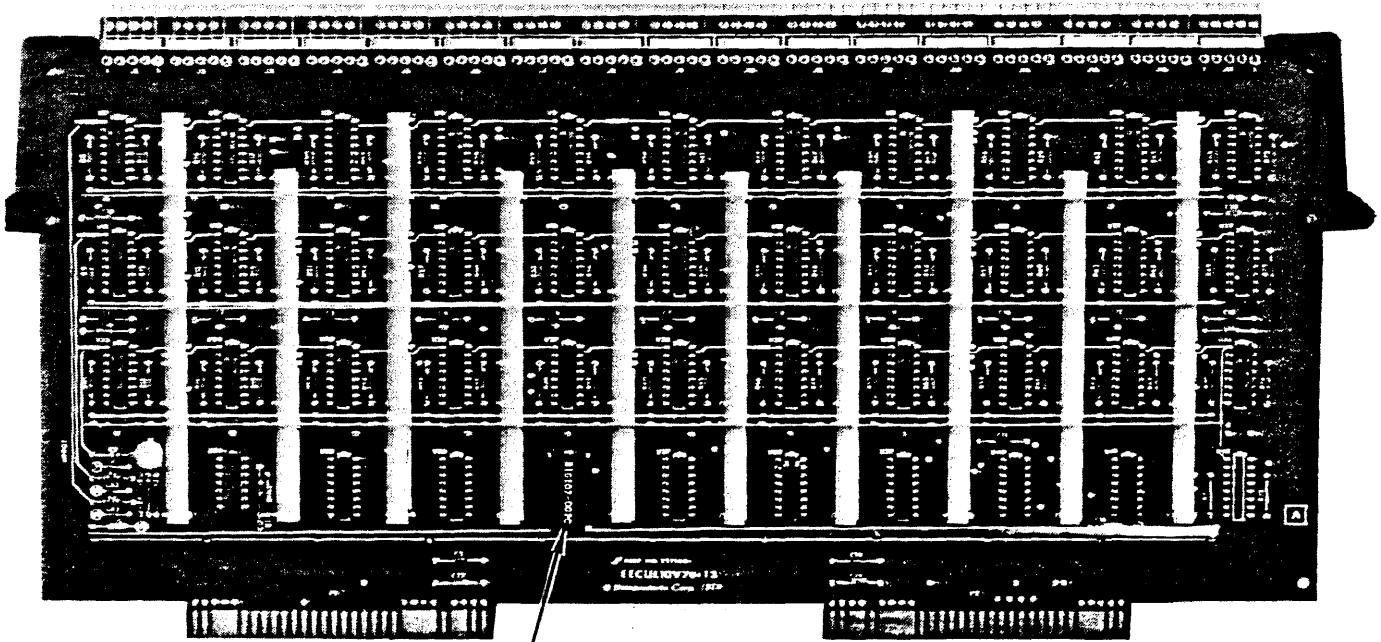

FLIGHT TIME HEADER

1
Different
between 100c & 600

Hammer Driver Module

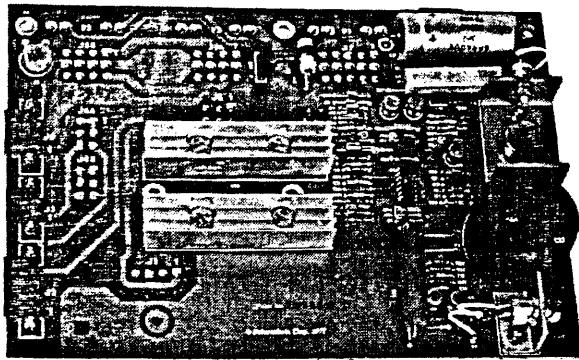

universal Rectifier .

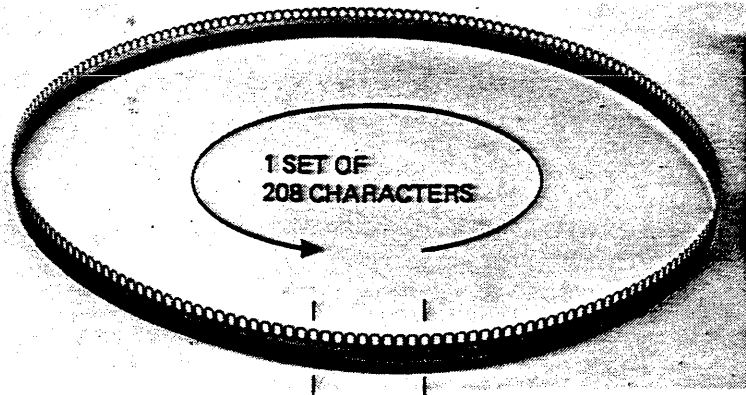

B300

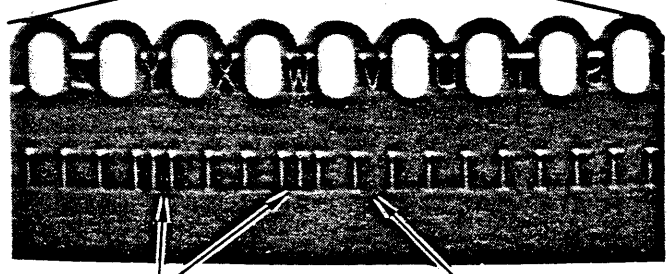

IDENTIFICATION MARKS RAISED CHARACTER MARKS

mid marks
Head of font
Beginning of char.
Band I.D.

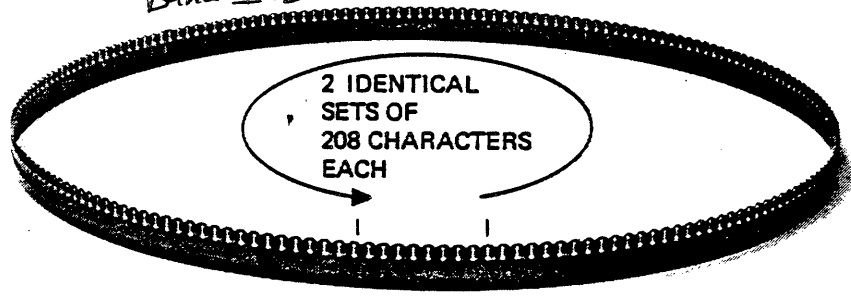

B600

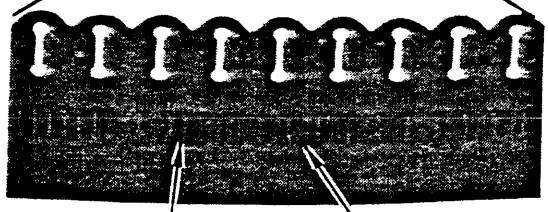

IDENTIFICATION MARKS RAISED CHARACTER MARKS

B300 and B600 Bands

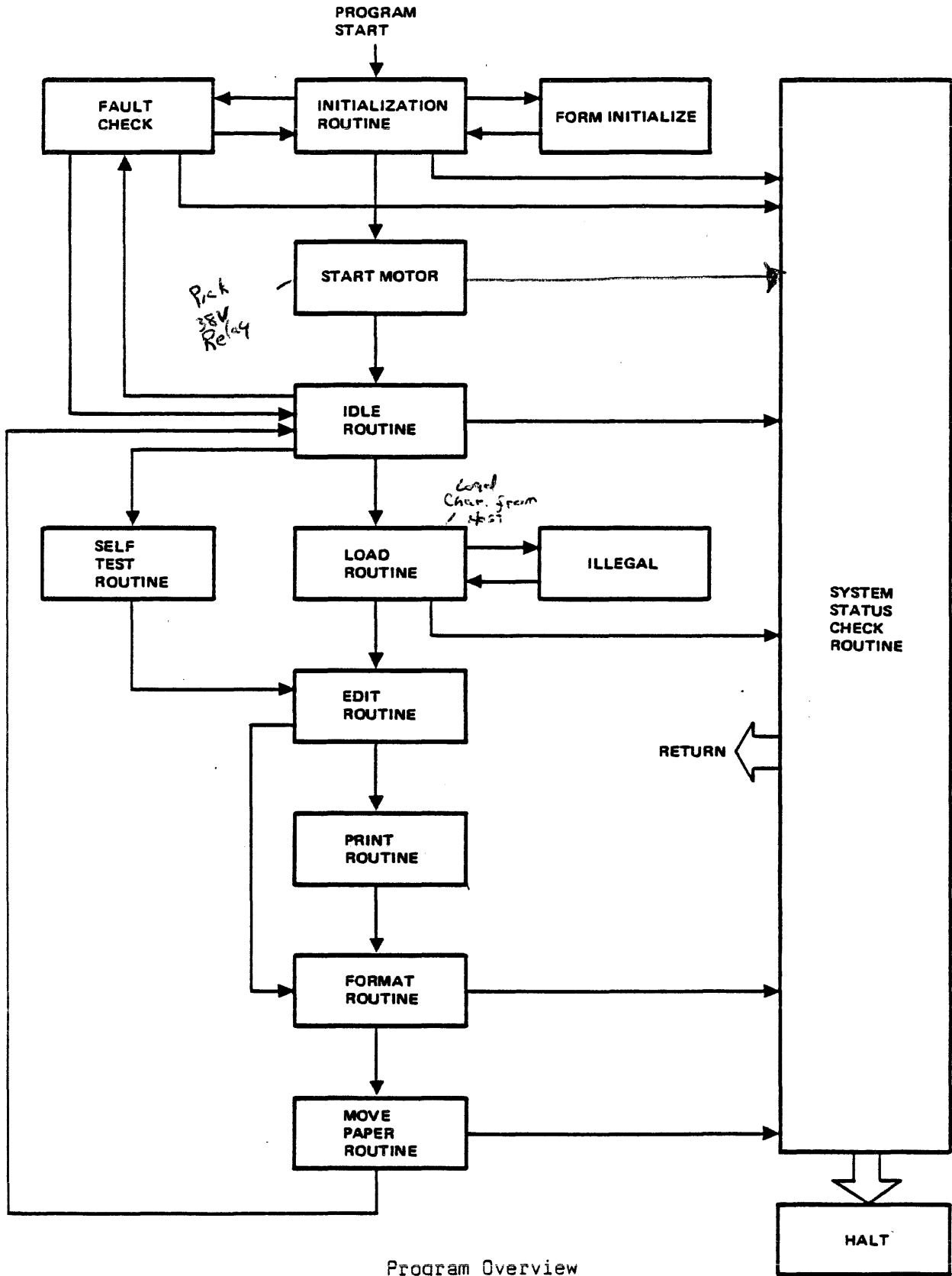

Program Overview

A. Initialization Routine

The primary function of the Initialization routine is to prepare the printer for normal operation. During the Initialization routine, general housekeeping exercises are performed. Voltages are allowed to stabilize and are checked. Should any system status change fault condition occur, the system status check routine would be called. As a part of initialization, the Form Initialize sub-routine is called, the Fault Check sub-routine is called, and the Start Motor sub-routine is called.

In Fault Check, a number of soft faults, such as paper out, are checked. In the Form Initialize sub-routine formatting is set up. In the Start Motor sub-routine the band motor is enabled, band speed and motor current is checked, and the band ID (an 8 Bit Band Identifier code) is read and compared with an on-board band image PROM.

B. The Idle Routine

Once the printer is initialized, the program moves into the Idle routine. If the printer does not go online, the program will simply cycle in the idle routine. The primary function of the idle routine is to await an operator action (a paper step, a top of form, or an online command) and respond accordingly. Note that the fault check sub-routine is recalled to continually monitor soft faults. Additionally, system status changes are also monitored.

C. Self Test Routine

From the Idle routine, if the self test switch is activated, the printer will move into the Self Test routine. During the Self Test routine, built-in exercises (sliding pattern or fixed character) are loaded into the printer Data RAM for later printing.

D. Load Routine

If the self test switch is not activated, from the Idle routine, the program moves to the Load routine. The primary function of the Load routine is to perform the data transfer between user and printer and move user data into the Data RAM.

E. Illegal Routine

The Illegal Routine is entered on receipt of an unprintable character from the user system. Its purpose is to further analyze this unprintable code to see if its possibly one of the three control codes: Line Feed, Form Feed, or Carriage Return.

F. Edit Routine

Both the Self Test routine and the Load routine are followed by the Edit routine. The function of the Edit routine is to weed out illegal, unprintable characters from the printer Data RAM prohibiting these from being printed.

G. Print Routine

If there is legal printable data in the Data RAM, it is printed during the Print routine.

H. Format Routine

During the Format routine, the control character is decoded and the printer is made ready to move the requisite number of lines.

I. Move Paper Routine

During the Move Paper routine, paper movement is initiated and the counter which tracks the current line is updated.

J. System Status Check Routine

At various points in the program, system status changes are checked for, and, if they are occurring, the program is interrupted and the System Status Check routine is begun. During the System Status Check routine, after a 2 millisecond delay, the printer will ask again, "Is there a legitimate system status change?" If the answer is no, the program will return to where the system status check routine was entered. If the answer is yes, the fault is identified, the proper fault number is displayed, the master clear switch is disabled by setting the format mode, and the printer goes to a HALT condition, a dead-end in program flow.

DAVSET sets an IOU-30 direct-access vertical-format unit.

SUBJECT DEVICE : Data Products 2230, 2260, or B600 printer

ROM-version: -

CONTROLLER : IOU-30

Board-ver. : -

ROM-version: -

SYSTEM REQUIRED

CPU-type : X6Q64

Min. memory: 8K bytes

With an uninitialized DAVFU (direct-access vertical-format unit) an IOU-30 printer (Data Products 2230, 2260, or B600) is inoperable. DAVSET initializes such a DAVFU and provides the operator with the repeatable option to print a page of 12 messages, which the operator can use to test both the success of DAVSET and the alignment of the paper.

PROCEDURE

1. Using the program-name DAVSET load the program.

2. The program will identify itself and will request "PRINTER-ADDRESS (DEFAULT = F.):". Perform one of these three alternatives:
 - A. to return to the loader, aborting DAVSET, enter "0" (zero);
 - B. enter the 1-hexadecimal-digit address of the printer; or
 - C. if the printer-address is F, either
 1. enter "F"; or
 2. just hit RETURN. The program will declare "ASSUMING ADDRESS F.", and will ask "CONTINUE?". Hit either
 - A. F3 to return to the loader, or
 - B. F2 to continue.

3. The program will instruct "SET THE PRINTER AND THE PAPER TO TOP-OF-FORM. THEN SAY WHETHER TO CONTINUE.". Either

A. hit F3 to return to step 2, or

B. set the printer and the paper, and then hit F2 to continue. The program will say "DAVFU-MEMORY HAS BEEN LOADED; SHALL WE TEST IT?". Hit either

1. F3 return to step 2, or

2. F2 to test the DAVFU-memory. DAVSET will write 12 messages "CHANNEL n". "n" represents the number of the channel to which the printer has slewn before printing the message. "n" varies from 00 through 11. "CHANNEL 00" is printed on print-line 1, and in all the messages the first character, "C", is printed in print-position 1. After all messages have been printed, the program will ask "RE-TEST?". Hit either

A. F3 to return to step 2, or

B. F2 to run the test again.

ERRORS

1. If the device at the address (h) specified by the operator is not an IOU-30, the program will declare "DEVICE h IS NOT AN IOU-30." and will return to step 2.

2. If the printer is inoperable at any critical point in the program, the program will declare "THE PRINTER IS INOP." and will ask "RE-TEST ITS OPERABILITY?". Hit either

A. F2 to re-test the operability of the printer, or

B. F3 to return to step 2.

3. If the printer fails to accept the VFU-load, the program will say "THE PRINTER IS REQUESTING VFU-LOAD; SHALL WE TRY AGAIN?". Hit either

A. F2 to return the program to the start of the actual DAVFU-memory load, or

B. F3 to return to step 2.

PRINT tests mostly IOU-5 through IOU-37 printers.

SUBJECT DEVICE : various printers

ROM-version: -

CONTROLLER : IOU-5, -17, -23, -27, -30, and -37.

Board-ver. : -

ROM-version: -

SYSTEM REQUIRED

CPU-type : Q6Q64

Min. memory: 16K bytes

PRINT tests IOU-5 Bull, IOU-17 Centronics, IOU-23 and -30 Data Products, IOU-27 Digitronics, and IOU-37 Teletype controller-printer combinations, and it also tests some features of IOU-39 printers. Fourteen printers may be tested at one time.

INITIALIZATION

1. Using the test-name PRINT load the program.

 2. The printers to be tested should ordinarily be of the same type: for example, all Bull (shuttle-) printers; or all Centronics (matrix-) printers. However, Bull and Centronics printers may be tested at the same time if the program has been told (in step 3 below) that the printer-type is Bull. Similarly, Digitronics and Data Products printers may be tested at the same time if the program has been told that the printer-type is Digitronics. In testing other combinations of printer-type, vertical-advance operations will be either inactive or confused. The program will request "PRINTER-ADDRESSES:". The operator-response may have as many as 3 parts (A, B, and C):
 - A. enter a 1-hexadecimal-digit address for each printer to be tested, without spacing between addresses;
 - B. if more than one type of printer is to be tested, disable the program's recognition of printer-type, by setting both Flags 2 and 3; and
 - C. PRINT has an 11-test-block 'manual' part followed by a 6-test-block 'automatic' part. To instruct the program to repeat endlessly the automatic part, type an "r" or an "R" after the last printer-address.

 3. If the program's recognition of printer-type was disabled (in step 2B above), the program will request "PRINTER-TYPE:". To answer, enter one of these codes: bul; cen; 23dat; 30dat; dig; and tel.

 4. The program will seek a device at each address entered and will then try to select a controller at each device found. If the program's recognition of printer-type was not disabled, the program will now identify the printer-type at each device. Any Digitronics and any IOU-23 Data Products printer must be on-line (and operable) for this identification. Then,
 - A. if more than one type of printer is detected, the program will restart, requesting "PRINTER-ADDRESSES:", but
 - B. if only one type of printer is detected, the program will report the type of printer.
 - 1.. If this report is incorrect, the operator must
-

restart the test, and in step 2B must disable the program's recognition of printer-type.

2. If the report is correct, proceed with step 5.

5. The program will request ""MANUAL" ITERATION-COUNT (HH):". Type a 1- or 2-hexadecimal-digit iteration-count to prepare the program to execute the manual part of PRINT that many times. If the iteration-count = 0, the manual part will be skipped.

6. The program will request ""AUTOMATIC" ITERATION-COUNT (HH):". Type a 1- or 2-hexadecimal-digit iteration-count to execute the automatic part that many times. If the count = 0, the automatic part will be skipped.

7. If the printer-type is IOU-30 Data Products (2230 or 2260), the program will instruct "SET PAPER TO TOP-OF-FORM". Set the paper for all printers being tested. The first print-line should be one of the first six lines on the paper. Press either Flag. The program will write a direct-access vertical-format unit, "DAVFU", to each printer being tested.

MANUAL PART

Most test-blocks in this part depend upon printer-type for their operation. For example, the termination-interrupt test is performed only on Digitronics, Data Products, Teletype, and IOU-39 printers, since Bull and Centronics printer-controllers do not have the termination-interrupt feature. Furthermore, some test-blocks are performed only once for each printer, regardless of the iteration-count. Other differences in the relation of various test-blocks to various printers are revealed in the following descriptions of individual test-blocks.

In this part all testing of one printer is completed before the testing of another printer is begun. In testing one printer, all iterations of one test-block are completed before the next test-block is begun. As each test-block begins, the program displays the name of the test-block followed by a question-mark. Then, by setting Flag 2 or 3, the operator may execute or skip the block.

1. Address-switch Test

This test is performed only once per printer.

A. The program will request "CONSTANT ADDRESSES:". Enter the 1-hex-digit address of every device in the system except device 0 and the printer to be tested.

B. The program will request "NEXT PRINTER-ADDRESS:". Either

1. To end the test send
 - A. a blank address or
 - B. a letter after "F" in the alphabet or
 - C. Flag 3 with any character, or

2. to test all 4 address-switches in both the 'on' and the 'off' positions, the following 3 steps must be performed at least twice. (To perform them only twice, choose any pair of addresses whose sum = \$F, so long as these addresses do not conflict with the constraints of step A below. Use one address of the pair the first time, and the other the second time.)

- A. Enter an address not being used by any other device.

- B. Set the address-switches on the printer-controller to this address.

- C. Press ST-SP. The program will return to requesting "NEXT PRINTER-ADDRESS:".

2. Status-Test

This test is performed only once per printer; the operator ends it. It has 2 phases:

A. In the first phase, whenever the status of the printer changes, the program displays the new status-byte. Therefore the operator may change the status of the printer (power it off, power it on, place it off-line, remove its paper, etc.) to test the reliability of the printer's report of its status to the CPU. To begin the second phase, press Flag 3.

B. In the second phase, the program causes the printing of lines of asterisks until either

1. the printer becomes busy, at which time the program will no longer issue the write-instruction, and the test will end, or
-

2. the operator presses either
 - A. Flag 2 to restart the first phase or
 - B. Flag 3 to end the test.

3. Timing-Test

Each of the following 5 operations is executed twice before the next operation is executed. During the second execution of an operation, the program counts the time for busy-status to go down, and then displays this time.

O P E R A T I O N

Name Description

OP1 Print one blank
 OP2 Print a full line of blanks
 OP3 Print a full line of all characters (\$20--\$7F)
 OP4 Skip one line
 OP5 Advance to top of form

Some sample times (in milliseconds) for these operations are shown below for the printers' standard character-sets. A time that differs from the sample by more than 15% is probably an error.

Operation	Printer Type	Time (ms)
OP1	BULL	298.5
OP2	BULL	290.5
OP3	BULL	588.5
OP4	BULL	9.8
OP5	BULL	655.9
OP1	CENTRONICS	227.9
OP2	CENTRONICS	1063.3
OP3	CENTRONICS	1063.5
OP4	CENTRONICS	91.3
OP5	CENTRONICS	2677.0
OP1	101A	227.9
OP2	101A	1063.3
OP3	101A	1063.5
OP4	101A	91.3
OP5	101A	2677.0
OP1	702	23.3
OP2	702	26.1
OP3	702	1343.7
OP4	702	0.6
OP5	702	1474.2
OP1	703	46.8
OP2	703	49.6
OP3	703	836.0
OP4	703	0.6
OP5	703	803.9
OP1	DIGI-TRONICS	60.9
OP2	DIGI-TRONICS	60 or 104
OP3	DIGI-TRONICS	293.8
OP4	DIGI-TRONICS	15.0
OP5	DIGI-TRONICS	958.0
OP1	TELETYPE	29.1
OP2	TELETYPE	45.5
OP3	TELETYPE	205.4
OP4	TELETYPE	13.4
OP5	TELETYPE	600.2
OP1	IOU-23	32.1
OP2	IOU-23	30.3
OP3	IOU-23	196.0
OP4	IOU-23	32.5
OP5	IOU-23	565.3
OP1	IOU-30	15.7
OP2	IOU-30	14.2
OP3	IOU-30	128.5
OP4	IOU-30	15.7
OP5	IOU-30	431.9
OP1	2420	2.1
OP2	2420	170.9
OP3	2420	169.7
OP4	2420	0.2
OP5	2420	1436.7

Centronics and Digitronics printers perform these operations in times that differ greatly from one printer to the next. The times for Digitronics differ from one minute to the next. A time of 0.0 milliseconds can mean that the device stayed busy for more than 3.5 seconds. To end this test at any time, press Flag 3.

4. Vertical-advance Test

Progressively longer lines, each being a number of V's followed by 3 reverse slashes (including a 'middle' slash), are printed on one page at progressively larger vertical distances from the previous line, such that all of the middle slashes lie on the same oblique straight line. Data Products printers print two pages per iteration. Printers of all other types print one page per iteration.

IOU-30 printers (Data Products 2230 and 2260) print 12 lines on the first page, and 10 lines on the second page. Printers of all other types print 10 lines per page.

Preceding the printing of each line, the program issues a vertical-advance command that uses a characteristic write-control byte. This byte and the function of the command are shown in the following table.

P R I N T E R										
I N E	B U L L				D A T A P R O D U C T S				D I G I - T E L E -	
	T R O N I C S				I O U - 2 3				T R O N I C S	
				PAGE 1	PAGE 2	PAGE 1	PAGE 2			
01	36 TOP OF FORM	x6 TOP OF FORM	00 TOP OF FORM	00 TOP OF FORM	00 TOP OF FORM	00 TOP OF FORM	00 TOP OF FORM	00 TOP OF FORM	x6 TOP OF FORM	
02	37 SKIP 1 LINE	x7 SKIP 1 LINE	11 SKIP 1 LINE	11 SKIP 1 LINE	08 SLEW TO CH 8	11 SKIP 1 LINE	11 SKIP 1 LINE	11 SKIP 1 LINE	x7 SKIP 1 LINE	
03	30 SLEW TO 1	x1 VER- TCL TAB	12 SKIP 2 LINES	12 SKIP 2 LINES	09 SLEW TO CH 9	12 SKIP 2 LINES	12 SKIP 2 LINES	12 SKIP 2 LINES	x7 SKIP 1 LINE	
04	31 SLEW TO 2	x1 VER- TCL TAB	01 SLEW TO CH 1	13 SLEW 3 LINES	01 SLEW TO CH 1	13 SLEW 3 LINES	13 SLEW 3 LINES	02 SLEW TO CH 2	x7 SKIP 1 LINE	
05	32 SLEW TO 3	x1 VER- TCL TAB	02 SLEW TO CH 2	14 SLEW 4 LINES	02 SLEW TO CH 2	14 SLEW 4 LINES	14 SLEW 4 LINES	03 SLEW TO CH 3	x7 SKIP 1 LINE	
06	33 SLEW TO 4	x1 VER- TCL TAB	03 SLEW TO CH 3	15 SLEW 5 LINES	03 SLEW TO CH 3	15 SLEW 5 LINES	15 SLEW 5 LINES	04 SLEW TO CH 4	x7 SKIP 1 LINE	
	34 SLEW TO 5	x1 VER- TCL TAB	04 SLEW TO CH 4	16 SLEW 6 LINES	04 SLEW TO CH 4	16 SLEW 6 LINES	16 SLEW 6 LINES	05 SLEW TO CH 5	x7 SKIP 1 LINE	
08	35 SLEW TO 6	x1 VER- TCL TAB	05 SLEW TO CH 5	17 SLEW 7 LINES	05 SLEW TO CH 5	17 SLEW 7 LINES	17 SLEW 7 LINES	06 SLEW TO CH 6	x7 SKIP 1 LINE	
09	30 SLEW TO 1	x1 VER- TCL TAB	06 SLEW TO CH 6	18 SLEW 8 LINES	06 SLEW TO CH 6	18 SLEW 8 LINES	18 SLEW 8 LINES	07 SLEW TO CH 7	x7 SKIP 1 LINE	
10	31 SLEW TO 2	x1 VER- TCL TAB	07 SLEW TO CH 7	19 SLEW 9 LINES	07 SLEW TO CH 7	19 SLEW 9 LINES	19 SLEW 9 LINES	07 SLEW TO CH 7	x7 SKIP 1 LINE	
11								0A SLEW TO CH 10		
12								0B SLEW TO CH 11		

Some printers can be loaded with a Vertical-Format Unit (VFU) only by the use of a paper tape. Success in testing the vertical advance of a printer of this type depends upon the use of a standard vertical-format-test tape. Tapes of this kind were made available to Field Service beginning in 1973 January, and were not shipped with any printers before then.

These tapes are charted on the next 2 pages. For each tape, the lowest punched hole on page 8 is the same hole as the highest punched hole on page 9.

BULL			CENTRONICS			DIGITRONICS			DATA PRODUCTS		
SERIES 700			SERIES 100						IOU-23		
2	5	8	21	5	7	87	654321	123	45678		
L	O		G	L	O		G	L	O		L
I	O		O		I	O		O		I	O
N	O		O		N	O		O		N	O
E	O		O		E	O		O		E	O
X	O	X	1	O	6	O	X	1	O	X	O
O		X	2	O	O		X	2	O	O	6
O			3	O	O			3	O	O	
O			.	O	O			4	O	O	
O			.	O	O			5	O	O	
11	O	X		O	11	O	X	6	X	O	X
O				O	O			.	O	O	
O				O	O			.	O	O	
15	O	X		O	15	O	X		O	X	O
O				O	O				O	O	15
O				O	O				O	O	
O			15	O	O	X		15	O	X	O
20	O	X		O	20	O	X		O	X	O
O				O	O				O	O	20
O				O	O				O	O	
O				O	O				O	O	
O			20	O	O	X		20	O	X	O
X	O	26		O	26	O	X		O	O	O
O				O	O				O	O	26
O			24	O	O	X			O	O	
O				O	O				O	O	
O				O	O			26	O	X	O
O				O	O				O	O	
X	O	X		O	33	O	X		O	X	O
O				O	O				O	O	33
O				O	O				O	O	
O		L		O	O				O	O	
O		I		O	O			33	O	X	O
O		N		O	O				O	X	O
O		E		O	O	X			O	O	O
O			35	O	O				O	O	
X	O	X	41	O	41	O	X		O	O	X
O				O	O				O	O	
O				O	O				O	O	
O				O	O				O	O	
O				O	O			41	O	X	O
O			42	O	O	X			O	O	O

(overlaps the next page)

```

-----
BULL      !   C E N T R O N I C S   ! DIGITRONICS ! DATA
          !   SERIES           ! SERIES      ! PRODUCTS
          !   700             ! 100        ! IOU-23
          ! 2   5   8 !           21 !           5 7 !           87 654321 ! 123 45678
-----
! X O X 41 ! !           0           ! !41 O X  ! !           0           ! !41 O X  !
!  O      ! !           0           ! !  O      ! !           0           ! !  O      !
!  O      ! !           0           ! !  O      ! !           0           ! !  O      !
!  O      ! !           0           ! !  O      ! !           0           ! !  O      !
!L O      ! !           0           ! !L O      ! !41 OX    ! !L O      !
!I O      ! !42  O      X ! !I O      ! !  O      ! !I O      !
-----N-----N-----N-----N-----N-----N-----N-----N-----
!E O      ! !           0           ! !E O      ! !           0           ! !E O      !
!  O      ! !           0           ! !  O      ! !           0           ! !  O      !
!50 O      X ! !           0           ! !50 O X   ! !           0           ! !50 O X   !
!  O      ! !           0           ! !  O      ! !           0           ! !  O      !
!  O      ! !           0           ! !  O      ! !           0           ! !  O      !
!  O      ! !           0           ! !  O      ! !           0           ! !  O      !
!  O      ! !50  O      X ! !  O      ! !50 OX    ! !  O      !
!  O      ! !           0           ! !  O      ! !           0           ! !  O      !
!  O      ! !           0           ! !  O      ! !           0           ! !  O      !
!  O      ! !           0           ! !  O      ! !           0           ! !  O      !
!  O      ! !           0           ! !  O      ! !           0           ! !  O      !
!60 O X    ! !           0           ! !60 O X   ! !           0           ! !60 O X   !
!  O      ! !           0           ! !  O      ! !           0           ! !  O      !
!The 2nd  ! !           0           ! !The 2nd  ! !           0           ! !The 2nd  !
!of 2 it- ! !59  O      X ! !of 2 it- ! !           0           ! !of 3 it- !
!erations ! !           0           ! !erations ! !60 OX    ! !erations !
!of this  ! !           0           ! !of this  ! !           0           ! !of this  !
!pattern  ! !           0           ! !pattern  ! !End of tape ! !pattern  !
!of holes ! !           0           ! !of holes ! !           0           ! !of holes !
!begins   ! !           0           ! !begins   ! !           0           ! !begins   !
!below on ! !           0           ! !below on ! !           0           ! !below on !
!line 72. ! !           0           ! !line 72. ! !           0           ! !line 72. !
!  O      ! !           0           ! !  O      ! !           0           ! !  O      !
! X O X X ! !           0           ! !72 O X X ! !           0           ! !X O X X !
!  O      ! !69  O      X ! !  O      ! !           0           ! !  O      !
!  O      ! !           0           ! !  O      ! !           0           ! !  O      !
!  O      ! !           0           ! !  O      ! !           0           ! !  O      !
!  O      ! !           0           ! !  O      ! !           0           ! !  O      !
!77 O      X ! !           0           ! !77 O X   ! !           0           ! !           !
!  O      ! !           0           ! !  O      ! !           0           ! !           !
!  O      ! !           0           ! !  O      ! !           0           ! !           !
!  O      ! !           0           ! !  O      ! !           0           ! !           !
!81 O X    ! !           0           ! !81 O X   ! !           0           ! !X O 81 !
!  O      ! !           0           ! !  O      ! !           0           ! !  O      !
!and so   ! !           0           ! !and so   ! !           0           ! !and so   !
!forth    ! !           0           ! !forth    ! !           0           ! !forth    !
!  O      ! !81  O      X ! !  O      ! !           0           ! !  O      !
          !           0           !
          !End of tape !
-----

```

The "X"s represent the holes punched in the channels whose numbers are shown immediately above each tape. The columns of "O"s represent tractor-feed holes.

Each tape has 66 lines per iteration of its pattern of punched holes. Refer to the chart for the number of iterations per tape.

The chart contains both vertical and lateral distortions. Actual 8-channel tape is 3/5 as long as the charted versions, and actual 12-channel tape is nearly 7/6 as wide as the charted versions.

An IOU-30 printer does not use a tape; its VFU is loaded directly by the software. A unit of this kind is called a direct-access VFU, or DAVFU. For this test its bits are set thus:

```

LINE      ! 1 ! 3 ! 6 ! 10 ! 15 ! 21 ! 28 ! 36 ! 45 ! 55 ! 57 ! 59
CHANNEL ! 0 ! 8 ! 9 ! 1 ! 2 ! 3 ! 4 ! 5 ! 6 ! 7 ! 10 ! 11
          (top
          of
          form)
    
```

5. Print E's or M's

To check horizontal or vertical alignment, up to 58 lines per iteration can be printed if the printer is not Centronics, and up to 22 lines per iteration can be printed if the printer is Centronics. Flag 3 ends the test at any time.

6. Termination-interrupt Test

This test is for only Data Products, Digitronics, and IOU-39 printers. It does not cause any printing, but the manual iteration-count applies to it.

7. Termination-Test

(The iteration-count applies to this test.) A line whose length is 2 greater than the maximum buffer-length is written. The printer fails the test if the I/O count is not terminated after 136 characters for Bull or IOU-30, or after 132 characters for all other printers.

8. Bang-bang Test

This test is only for Digitronics. Up to 58 lines of a worst-case pattern are printed for each iteration. Don't overdo this test; Flag 3 ends it at any time.

9. Rebale-Test

This test is only for Digitronics. Inhibit Norblink circuit by shorting pins 7 and 8 of J4 in the device. Sets of 5, 10, and 15 Q's appear to move across the page, 1 position at a time. If the printer fails to print a Q in this pattern, it has failed the test.

10. Elongate-Test

This test is only for Centronics. Twenty-two lines of elongated characters are printed for each iteration. Each line to be printed is an expand-print character (\$OE) followed by 66 of the 95 ASCII characters \$21 through \$7F. Flag 3 ends the test at any time.

11. Delay-print Test

A pattern of characters is printed on each line with a time-delay up to 999 seconds before printing the next line. The operator may choose between 2 patterns:

A. a ripple-pattern whose extent depends upon printer-type:

1. if the printer is not Bull, the 96 ASCII characters \$20 through \$7F; or
2. if the printer is Bull, the 91 ASCII characters \$20 through \$7A; or

B. an alternate 'vertical' (non-ripple) pattern of double digits, double letters, and special characters.

The program will request "DELAY IN SECONDS (DDD):". Enter a 1- to 3-digit decimal number to establish a delay of that number of seconds. Flag 3 ends the test at any time.

AUTOMATIC PART

After the manual part has been completed for each device, the automatic part will be executed. All operable printers will be exercised simultaneously. Flag 3 ends any test at any time. If a printer is inoperable or remains busy for more than 3 1/2 seconds, the test will report that the printer is INOP, and will skip further output-commands to it until the beginning of the next test-block, when the program will again test the status of the device. If the device has become operable, the test will start sending output-commands to it. A maximum of 4 "INOP" reports will be displayed for any one printer during one complete iteration through the automatic part. If all printers have gone INOP, the program will halt. Before pressing ST-SP the operator may select either

to restart the test at the beginning of the current test-block, by not pressing Flag 2, or

to continue the test with the next line of the current test-block, by pressing Flag 2.

Before restarting or continuing, the program will test all printers for operable status.

1. All-character Test

This test has 2 parts.

A. In the first part, 64 lines are printed, each line devoting all print-positions to a different one of the 64 ASCII characters \$20 through \$5F.

B. In the second part, 2 groups of lines are printed in the first 64 print-positions. A printer other than Centronics will print 20 lines per group, but a Centronics will print only 10 lines per group, and each elongate character will be replaced with a period.

1. The first group contains the central 64 ASCII characters \$20 through \$5F.

2. The content of the second group depends upon printer-type.

A. A printer other than Bull should print the low 32 (\$00 through \$1F) and the high 32 (\$60 through \$7F) ASCII characters. If the printer is not equipped to print lower-case letters, its second group should be identical to its first.

B. A Bull should print only the characters \$61

through \$7A (letters).

2. Variable-length-write Test

Forty-three lines of asterisks are printed. The first line contains one asterisk. Each successive line contains 3 more asterisks than the previous line. The last line contains 127 asterisks.

3. Ripple-pattern

Lines of a ripple-pattern of characters are printed. Any printer other than Centronics prints 58 lines per iteration, and a Centronics prints 22 lines per iteration. Any printer other than Bull prints the characters \$20 through \$7F, and a Bull prints the characters \$20 through \$7A.

4. Pattern-test

Any printer other than Centronics prints 6 rectangular boxes, and a Centronics prints 3 boxes.

5. Character-quality Test

This test is for only Bull and Data Products printers. A group of 4 characters is printed repeatedly across an entire print-line. The group is "EExE", wherein "x" represents a character peculiar to one print-line. One line is printed for each "x", which varies from \$20 through \$7F for a Data Products printer, and from \$20 through \$7A for a Bull printer.

6. Print E's, M's, and -'s

For each iteration, any printer other than Centronics prints 19 lines of each of the characters "E", "M", and "-". A Centronics prints 7 lines of each.

Supplementary Tables

1. Status-bit Meanings

BIT	P R I N T E R			
	! Bull	! Centronics	! Data Products IOU-23, Digitronics, and Teletype	! Data Products IOU-30
10	! Always 0	! Always 0	! Interrupt	! Interrupt
20	! Always 1	! Always 0	! Always 0	! VFU-load request
40	! Always 0	! Always 0	! Always 1	! Always 1
80	! INOP	! INOP	! INOP	! INOP

2. Write-control Bytes

FUNCTION	P R I N T E R				
	! Bull	! Cen- tronics	! Data Products IOU-23 & Digi- tronics	! Data Products IOU-30	! Teletype
Top of form	! 36	! x6	! 00	! 00	! x6
Skip 1 line	! 37	! x7	! 11	! 11	! x7
Slew n lines	!	!	! 1n	! 1n	!
Tab	!	! x1	!	!	!
Slew to channel n	! 3n	!	! 0n	! 0n	!
Set ATI*	!	!	! 60	! 60	!
Reset ATI*	!	!	! 20	! 20	!
Start DAVFU memory-load	!	!	!	! EE	!
Stop DAVFU memory-load	!	!	!	! EF	!

* ATI = Allow-Termination-Interrupt

ERROR-CODES

P1A There is no device at the address just entered.

P1B A 'non-existent' device, i.e., one that does not have a "CONSTANT ADDRESS...", and that is not the printer being tested, has been detected. The address of the device is printed above the line containing the error-code, and the status of the device is included in the error-code line.

P1C Interrupt was enabled (byte 0012), and the set-allow-termination-interrupt instruction (CTL \$60) was issued to the printer. Interrupt incorrectly occurred at this time although no write-instruction and no line-feed instruction had been sent to the printer.

P1D The controller has failed to interrupt the processor. The program issued a set-allow-termination-interrupt instruction (CTL \$60), enabled interrupt (byte 0012), and then wrote a line of blanks and waited for busy to become false.

P1E Interrupt has occurred after the procedure outlined above in "P1D", but Flag 1 status was not true.

P1F The program issued a line-feed instruction (CTL \$11) in order to reset an interrupt-condition (which existed because of the procedure outlined above in "P1D"). The line-feed instruction should have reset Flag 1, but did not.

P1G The program issued a set-allow-termination-interrupt instruction (CTL \$60), enabled interrupt, and wrote a line of blanks. Then a line-feed instruction (CTL \$11) was issued, and interrupt was enabled (byte 0012). When busy became false, an interrupt-condition should have occurred, but did not.

P1H When an interrupt-condition existed, the resetting of allow-termination-interrupt (CTL \$20) should have reset Flag 1 of the printer, but did not.

P1J The program issued a reset-allow-termination-interrupt instruction (CTL \$20), enabled interrupt, and wrote a line of blanks. Then a line-feed instruction (CTL \$11) was issued, and interrupt was enabled (byte 0012). When busy became false, an interrupt-condition should not have occurred, but did.

P1K A write whose length was 2 greater than the buffer-length was issued to the printer. The printer-controller should have accepted exactly as many characters as were needed to fill the buffer, but did not. The line above the error-code displays both the hex number of characters actually written by the processor, and the hex number of bytes in the buffer.

