

**MCDONNELL DOUGLAS**

**AUGMENT ENGINE**

**TRAINING**

**HANDOUTS**

**BY**

**F.J.R.(Rhett) Williamson**

MANY THANKS TO:

DAN MARTIN  
CARSON JANES  
REED KIRK  
STEVE CAPIK  
MARY GUIOL  
LINDA KINDER

WITHOUT WHOSE HELP THIS MANUAL COULD  
NOT HAVE BEEN ASSEMBLE.

# AUGMENT ENGINE Overview

MACDONNELL DOUGLAS

## CPU

36 bit word length

bit slice microprocessors

*36 words: 60, 61, 62 12 bits/word: interchangeable function  
non-interchangeable bits*

40 Mhz basic machine clock

*TTL not ECL / scratchpad memory  
memory (e.g. memory cache)*

## MOS MEMORY

8 MEG words max (most machines 2 meg)

ECC (error correction)

## CONSOLE BOARD - Replaced by IBM PC; Console Computer

commands to interrogate machine

remote diagnosis interface

floppy disks?  $\frac{1}{2}$  10mi card

## MICROCODE

DEC PDP-10 emulation, Tenex on XXVI, Tops-20 on 26KL

8K of 88 bit words

## F-BUS (I/O BUS)

36 bit parallel data transfers

DMA (direct memory access) *not really - all MA - uses microcode*

*no interleaving; no "bank" Multi-ported memory.*

## I/O DEVICES

\* disk - *Nuport Capricorn*

\* tape

line printer

DLS (data line scanner)

\* micronode (Tymnet interface)

Arpanet interface

## AUGMENT ENGINE SPECIFICATIONS

### I. PHYSICAL CHARACTERISTICS

#### A. SIZE

1. System mounted in two 19" rack mount cabinets
2. Cabinets mounted side-by-side
3. Total floor space required 1518 Sq In or 10.5 Sq. Ft.

#### B. PHYSICAL CONFIGURATION

1. Cabinet #1 contains the CPU, On-board Memory, Console Computer, Controllers, & I/O PCBs.
2. Cabinet #2 contains peripherals of the customers choice. Currently, the configuration is:

- 1 Kennedy 9219 Tape Formatter
- 1 Kennedy 9100 dual density Tape Drive
- \*\* 1 OPTIONAL KENNEDY 9400 TRI-DENSITY TAPE DRIVE
- 1 DEC LSI/23 Tymnet Communication Node
- 3 Ampex "Capricorn" 330 Mbyte Disk Drives

NOTE: The customer may modify the peripheral equipment as to type or quantity to meet his specific needs.

### II. SYSTEM ARCHITECTURE

#### A. MICRO-PROGRAM PROCESSOR CONTROL

1. 88 bit micro-word for engine control
2. Utilizing bit-slice technology

#### B. MEMORY

1. Up to 8 Megawords of internal memory
2. Standard ECC Error Correction
  - (Single bit error detection-correction)
  - (Double bit error detection)

#### C. SPEED OF PROCESSING

1. 350 nanoseconds per memory cycle
2. 2.0 million instructions processed per second
3. Micro code speed is 150-500 ns

#### D. OPERATING SYSTEMS

1. TOPS-10
2. TOPS-20
3. TENEX
4. TYMCOM-X

E. PROGRAMMING LANGUAGES

1. Customer's choice -- no restrictions

F. PERIPHERALS SUPPORTED

1. Up to four disk drives per controller (4)
2. Tape transport 9 track NRZI format (800, 1600 or 6250 CPI)
3. High speed printers
4. Phototypesetters
5. Intelligent VDTs
6. ARPANET communication net
7. Micronode for local communication net or TYMNET tie

G. USERS

1. Up to 100 total
2. Up to 40 simultaneous users

H. MAINTENANCE

1. Local & remote Microcode diagnostics
2. Local & remote Memory diagnostics
3. Highly qualified software and technical support
4. Strategically placed, readily available spares.

*Logic Analyzer*

AUGMENT ENGINE  
PERIPHERAL RACK 2

AMPEX  
330 MBYTE  
DISK DR

SPEC.	MOD 9100 TAPE DR	9219 FORMATTER	11/23 COM INT	AMPEX 330 MBYTE DISK DR	TOTAL
VOLTS	100/126 RMS	115VACI 10%	100-126 RMS	120V	35 AMPS@115 VAC 1 $\phi$ +10%
AMPS	7.0A	.7A	5.5A	5.6X3A	30.0 AMPS
TEMP.	2 $^{\circ}$ -50 $^{\circ}$ C 35.6 $^{\circ}$ -122 $^{\circ}$ F	2 $^{\circ}$ -50 $^{\circ}$ C 35.6 $^{\circ}$ -122 $^{\circ}$ F	5 $^{\circ}$ -40 $^{\circ}$ C 41 $^{\circ}$ -104 $^{\circ}$ F	10 $^{\circ}$ -40 $^{\circ}$ C 50 $^{\circ}$ -104 $^{\circ}$ F	50 $^{\circ}$ -104 $^{\circ}$ F 10 $^{\circ}$ -40 $^{\circ}$ C
R/H	NO COND 15-95%	NON COND 15-95%	NO COND 10-95%	NO COND 20-80%	20%-80%
HT	62.15 CM 24.47 IN	8.48 CM 3.34 IN	13.2 CM 5.19 IN	25.9 CM 10.2 IN	
WIDTH	48.26 CM 19 IN	42.57 CM 16.76 IN	48.3 CM 19 IN	48.3 CM 19 IN	
DEPTH	54.91 CM 21.62 IN	37.13 CM 14.62 IN	67.98 CM 26.76 IN	76.5 CM 30.1 IN	
WT.	150 LB	20.6 LB	28.0 LB	128	
CABINET	200 LB				782.6 LB

# Computer Systems & Support

MODEL NUMBER		DESCRIPTION
TS26KL-A		CPU, data bus, diagnostic front end, console terminal, 512K words of memory, cabinet and power supplies, 115V, 60 Hz
TMS20-A	ME26B	Memory 512K words, 36-bit ECC with parity
DCN30-A		MICRONODE controller, with 16 asynchronous ports, power supply, 115V, 60Hz
DCN30-B	DLVH	Micronode additional 16 asynchronous ports
DCN30-C	D-11	Micronode synchronous port
DCA30	DR26I	Arpa net interface, MILNET
DCF40	CFDA CFDB	Disk controller, single channel, up to 4 drives
DFM42	DS-1000	Single drive, 160 megabyte, 14" fixed media storage
DFM43	DS-200F DM-330	Single drive, 330 megabyte, 14" fixed media storage
DFM44	S	Single drive, 474 megabyte, 14" fixed media storage
DRM43		Single drive, 300 megabyte, removable media
LPC60	LPT	Line printer controller
LPB60		Line printer, 64 character, 1000 LPM
TCR50	MT&C CFTA	Tape controller for tape system
TDR50	TEGA	Tape drive 75 IPS, 800/1600 BPI, includes formatter

Capricorn 2

System Eagle (not used)

Arpa 9600

Peripherals 600

9/04/9100  
Renard

# MODEL TS 26KL

## PHYSICAL CHARACTERISTICS

Size	System mounted in two 19" rack mount cabinets	
	Cabinets mounted side-by-side	
	Total floor space required — 1518 sq. inches or 10.5 sq. feet.	
Physical configuration	Cabinet #1	CPU, on-board memory, console computer, controllers, & I/O PCBs.
	Cabinet #2	contains peripherals
	Typical configuration:	1 TDR50 tape drive 75 IPS 800/1600 DCN30 MICRONODE controller with (16) lines ASYNC DFM43 disk drives 660 megabytes 14" fixed media
Power requirements	2-30 AMPS, 10, 115 V AC	
	Power consumption (CPU)	11 AMPS, 115 V AC (CPU)
	Power consumption (I/O)	Max 20 AMPS, 115 V AC

## PERFORMANCE

Micro-program processor control	88 bit micro-word for engine control
	Utilizing bit-slice technology
Memory	Up to 8 megawords of internal MOS memory
	Standard ECC error correction (Single bit error detection-correction) (Double bit error detection)
Speed of processing	350-500 nanoseconds per memory cycle
	2.0 million instructions average processed per second
	Micro code speed is 150-500 ns
Operating systems	TYMCOM-20
Programming languages	TOPS-20 compatible
Peripherals supported	Up to four disk drives per controller
	Tape transport 9 track NRZI format (800 or 1600 BPI)
	High speed printers
	High resolution color graphics (in development)
	ARPANET communication network/ MIL-NETWORK
	Micronode for local communication net or TYMNET
	High speed local area network connection (in development)
Access	40 interactive users
Maintenance	Local & remote microcode diagnostics
	Local & remote memory diagnostics
	Highly qualified software and technical support fully remote
	Strategically placed, readily available spares
	Remote diagnostics capability software & hardware



# MODEL DFM42 DISK DRIVE

(160 Megabyte Capacity)

## PHYSICAL CHARACTERISTICS

Dimensions and weight	Height	25.9 cm (10.2 inches)
	Width	48.3 cm (19.0 inches)
	Length	76.5 cm (30.1 inches)
	Weight	56.6 kg (125 lbs)
AC power input	60 (+0.6, -1) Hz	120 (+8, -18) V, single phase
	50 (+0.5, -1) Hz	220 (+15, -25) V, single phase 240 (+17, -27) V, single phase
Power	Carriage and disks in motion	120 V: 530 W with maximum line current of 5.6 A. 220/240 V: 530 W with maximum line current of 2.85 A.
	Carriage and disks at rest	120 V: 160 W with maximum line current of 1.5 A. 220/240 V: 180 W with maximum line current of 0.7 A.
Operating temperature	Range	10° to 40° C (50° to 104° F)
	Max change	10° C (18° F) per hr
	Gradient	10° C (18° F)
Humidity	Operating	20% to 80% RH, non-condensing 10% per hr max change

## PERFORMANCE

Transfer rate	Disk speed	9.677 MHz (1,209,625 bytes/sec)
Latency	At 3,600 r/min	Latency is time to reach a particular track address after positioning is complete
	Average	8.33 ms (disk rotation speed at 3,600 r/min)
	Maximum	17.3 ms (disk rotation speed at 3,474 r/min)
Recording	Mode	MFM or NRZ (modified frequency modulation or non-return to zero)
	Density	6,417 bits per inch (inner track)
Seek time	Full	55 ms max
	Average	30 ms
	Single track	7 ms max
Start/Stop time		30 sec max

# MODEL DRM43 DISK DRIVE

(300 Megabyte Capacity)  
(Removable Media)

## PHYSICAL CHARACTERISTICS

		DRM43		
Dimensions	Height	38.0 inches		
	Width	19.25 inches		
	Depth	34.0 inches		
	Clearance	0.5 inch minimum on each side; 36 inches minimum in the front and rear (for operation and maintenance)		
Weight		465 lbs		
Support	Casters under the frame of the unit. The cable entrance is on the bottom, right side rear of the unit.			
<b>Power requirements</b> Input power: The standard drive is designed to operate on 208 VAC±10%, 60 Hz, three-phase, delta-connected power. The following input power configurations are also available: <ul style="list-style-type: none"> <li>• 400 VAC±10%, 50 Hz, three-phase, wye-connected</li> <li>• 220 VAC±10%, 60 Hz, single phase</li> <li>• 230 VAC±10%, 50 Hz, single phase</li> </ul>				
<b>INPUT POWER REQUIREMENTS WITH NOMINAL INPUT OF 208 V, 60 Hz, 3-PHASE</b>				
<b>Type Current</b>		<b>Phase A (Amperes RMS)</b>	<b>Phase B (Amperes RMS)</b>	<b>Phase C (Amperes RMS)</b>
Idle mode		1.5	1.5	1.5
Starting mode current for 7 seconds		27	27	23.5
Running mode current (no seeks)		4	4	2.2
Seeking mode current (random seeks)		6.4	6.4	2.2
Total power consumption at 208 VRMS:		1700 watts during random seeks		
Ambient temperature	Operating	60° to 90° F		
	Nonoperating	50° to 110° F		
	Shipping/storage	0° F to 140° F		
Relative humidity	Operating	20% to 80%		
	Shipping/storage	5% to 90% noncondensing		
Shock and vibration	Vibration	1.5G (5-400 Hz)		
	Shock	5G		
Cooling	The unit is cooled by means of internal fans and blowers			
Altitude	-1,000 ft (-305 m) to 30,000 ft (9,000 m)			
With 208 VRMS input, heating effects of each drive are:		4,100 BTU/hr, Ready status 5,800 BTU/hr, Selected status, random seeks		

## GENERAL OPERATING CHARACTERISTICS

Storage characteristics	Cylinders per pack	815
	Tracks per cylinder	19
	Tracks per pack	15,485
	Track density	370 tracks per inch
	Bit density	6,038 BPI
	8-bit bytes per track	20,160 (unformatted)
	8-bit bytes per cylinder	383,840 (unformatted)
	8-bit bytes per pack	312,177,600 (unformatted)
Disk pack characteristics	Weight	20 lbs
	Diameter	15 inches
	Height	7 inches
	Storage temperature	-40° to 150° F
	Operating temperature	60° to 90° F
Pack rotation speed		3,600±2% rpm
Pack rotation period		16.7 ms for one rotation
Average rotation latency		8.35 ms
Head positioning time	One cylinder	10 ms
	815 cylinders	55 ms
	Duty cycle (rep rate)	No less than 4 ms
	Data transfer rate	1,209,600 8-bit bytes per sec
Start time	After the START/STOP switch is set to START, it takes 15 seconds maximum to reach the point when the READY indicator is lit, indicating a ready condition.	
Stop time	After the START/STOP switch is set to STOP, it takes a maximum of 15 seconds to bring the disk pack to a complete stop. (Braking is accomplished electro-dynamically by means of an eddy-current brake on the spindle shaft.)	

# MODEL DFM43 DISK DRIVE

(330 Megabyte Capacity)

## PHYSICAL CHARACTERISTICS

Dimensions and weight	Height	10.75 inches (with feet) 10.25 inches (w/o feet)
	Width	18.75 inches
	Weight	134 lbs
Power requirements	Voltage (single phase)	120+10%, -15% VAC, 60 Hz 230+10%, -15% VAC, 50 Hz
	Frequency	60+1.0 Hz or 50+1.0 Hz
	Start current (10 seconds)	20 A, 60 Hz 12 A, 50 Hz
Temperature gradient (per hour)	Transit	27°F 15°C
	Operating	18°F 10°C
Storage	Transit	-40° to 140°F -40° to 60°C
	Operating	50° to 110°F 10° to 43.3°C
Relative humidity non-condensing	Transit	10% to 90%
	Operating	20% to 80%
Humidity gradient	Transit	10% per hr
	Operating	10% per hr
Vibration (vertical)	Transit	5-50 Hz 0.01 in. disp. 50-500 Hz 2 gs acc.
	Operating	5-10 Hz 0.004 in. disp. 10-15 Hz 0.02 gs acc. 15-50 Hz 0.0016 in. disp. 50-500 Hz 0.20 gs acc.
Altitude	Transit	-980 to 40,000 feet
	Operating	-980 to 10,000 feet

## FUNCTIONAL SPECIFICATIONS

Storage capacity (unformatted)		330.3 megabytes
Disks		5
Bytes per track		20,160
Tracks per cylinder		16
Tracks per surface		2,048
User cylinders		1,024
Positioning time	Track-to-track	6 ms
	1,024 cylinders (max seek)	55 ms
	Average	30 ms
Average latency		8.33 ms
Rotational speed		3,600 ± (+2.5%, -3.5%) rpm
Recording density		6,250 BPI
Data transfer rate MFM encoding		1,209,600 8-bit bytes per sec 9,676,800 bits per sec
Recording code		MFM (modified frequency modulation)
Interface code		NRZ (non-return to zero)
Interface		SMD (storage module drive)
Heads	R/W Servo	16 1
Head positioning		Servo-controlled
Start time		15 sec max
Stop time		15 sec max

## RELIABILITY

MTTR (mean-time-to-repair)		30 minutes
Components life		5 years
Error rates	Recoverable errors	1 in 10 <sup>10</sup> bits
	Unrecoverable errors	1 in 10 <sup>12</sup> bits
	Seek errors	1 in 10 <sup>6</sup> seeks

# MODEL DFM44 DISK DRIVE

(474 Megabyte Capacity)

## PHYSICAL CHARACTERISTICS

		DFM44/AF
Dimensions and weight	Height	264 mm (10.4 inches)
	Width	482 mm (19.0 inches)
	Depth	660 mm (26.0 inches)
	Weight	64 kg (140 lbs)
Power requirements		100 VAC±10%, 50 Hz±2 Hz, 5.7 A or 60 Hz±2 Hz, 5.4 A
		120 VAC±10%, 60 Hz±2 Hz, 4.6 A
		220 VAC±10%, 50 Hz±2 Hz, 2.9 A
		240 VAC±10%, 50 Hz±2 Hz, 2.6 A
Ambient temperature	Operating	10° to 40°C (50° to 104°F), less than 10°C (18°F) per hr
	Nonoperating	-40° to 60°C (-40° to 140°F), less than 20°C (36°F) per hr
Relative humidity	Operating	20% to 80% noncondensing
	Nonoperating	5% to 95% noncondensing
Vibration	Operating	0.2G (5 to 50 Hz), 1G (50 to 500 Hz) shock: 2G (10 ms max)
	Nonoperating	0.2G (10 to 500 Hz), shock: 3G (10 ms max)
	In storage or during transportation	3G, shock: 5G (30 ms max)
Altitude	Operating	3,000 m (10,000 feet)
	Nonoperating	12,000 m (40,000 feet)

## RELIABILITY SPECIFICATIONS

		DFM44/AF
MTBF (mean-time-between-failures)		More than 10,000 power-on hours
MTTR (mean-time-to-repair)		Less than 30 minutes
Components life		5 years
Error rates	Recoverable errors	10 per 10 <sup>11</sup> bits read
	Unrecoverable errors	10 per 10 <sup>14</sup> bits read
	Seek errors	1 per 10 <sup>7</sup> seeks

## FUNCTIONAL SPECIFICATIONS

		DFM44	DFM44/AF
Storage capacity (unformatted)	Moving heads	474,214,400 bytes	
	Fixed heads	—	1,689,600 bytes
Disks		6	
Bytes per track		28,160	
Tracks per cylinder	Moving heads	20	
	Fixed heads	—	20
Cylinders	Moving heads	842	
	Fixed heads	—	3
Positioning time	Track-to-track	5 ms	
	Average	18 ms	
	Maximum	35 ms	
Average latency		7.5 ms	
Rotational speed		3,961 rotations/minute± 2%	
Recording density		12,790 bits/inch	
Track density		880 tracks/inch	
Data transfer rate		1,859 megabytes/second	
Recording code		MFM (modified frequency modulation)	
Interface code		NRZ (non-return to zero)	
Interface		Modified SMD (modified storage module drive)	
Heads	Moving	20 (2 per surface)	
	Servo	1	
	Fixed	—	60
Head positioning method		Servo-controlled track-following	
Start time		30 seconds	
Stop time		15 seconds	

# MODEL LPB60 BAND PRINTER

## PHYSICAL CHARACTERISTICS

Dimensions and weight	Height	113 cm (44.5 inches)
	Width	87 cm (34.3 inches)
	Depth	75.5 cm (29.7 inches)
	Weight	159 kg (350 lbs)
Power requirements	Electrical voltage/freq	Universal power supply 90-132 V, 180-250 V 50 or 60 Hz
	Operating	600 watts
	Standby	550 watts
Features	Self test	Std
	Auto motor on/off	Std
	Diagnostic display	Std
Pedestal & paper shelf		N/A
Acoustic cabinet		Std
Forms length select switch		Optional
Elapsed time meters		Optional
Tape controlled 12 ch VFU		Optional
Direct access 12 ch VFU		Optional
136 print columns		Optional

## FUNCTIONAL SPECIFICATIONS

Print speed	48 character set	1100 LPM
	64 character set	1025 LPM
	96 character set	820 LPM
Paper slew speed		38 cm (15 inches) per sec
Single line advance		18 ms
Band speed		507 cm (199 inches) per sec
Interface	Parallel with full line buffer (standard)	RS-232 (optional)
		Long line (optional)
Forms type	Continuous fan-fold, edge perforated 7.6 cm (3 inches) to 40.6 cm (16 inches) wide	
Copies		Original plus five
Print format	Horizontal	10 characters per inch
	Vertical	6 or 8 lines per inch

# MODEL TDR50 Computer Systems & Support Tape Drive

## PHYSICAL CHARACTERISTICS

Dimensions and weight	Height	24.5 inches
	Width	19.0 inches
	Depth	21.0 inches
	Weight	155 lbs
Mounting		Std EIA rack
Power		115 VAC±10%, 48-60 Hz 750 watts max
Operating temperature		+2° to 50° C
Humidity		15% to 95% noncondensing
Altitude		0 - 4,000 feet
Options available		High altitude kit Special paint 220, 240 VAC

## FUNCTIONAL SPECIFICATIONS

Data density	7 track - 200/556, 556/800 CPI 9 track - 800/1600 CPI
Number of tracks	7 or 9 read after write
Format	NRZI/PE IBM-compatible
Tape speed	75 IPS
Instantaneous speed variation	±3%
Long term speed variation	±1%
Interchannel displacement error	150μ inches max 800 CPI 200μ inches max 556 CPI
Read data	NRZI 7 or 9 data output levels deskewed with read strobe PE 9 output levels peak and envelope detected
Start/Stop time	5 ms±0.5 ms at 75 IPS inversely proportional to tape speed
Start/Stop displacement	0.1875±0.0125 inches
Gaps	Externally timed
Parity	Externally generated
Tape tension	8.0 oz
Reel size	10.5 inch 2,400 feet 1.5 mil 0.5 wide tape
Drive system	Single capstan 180° wrap
Tape buffer Tape detection	Vacuum column Capacitive
Rewind speed	200 IPS nominal
Electronics	TTL
Tape unit interface	TTL industry-compatible low true

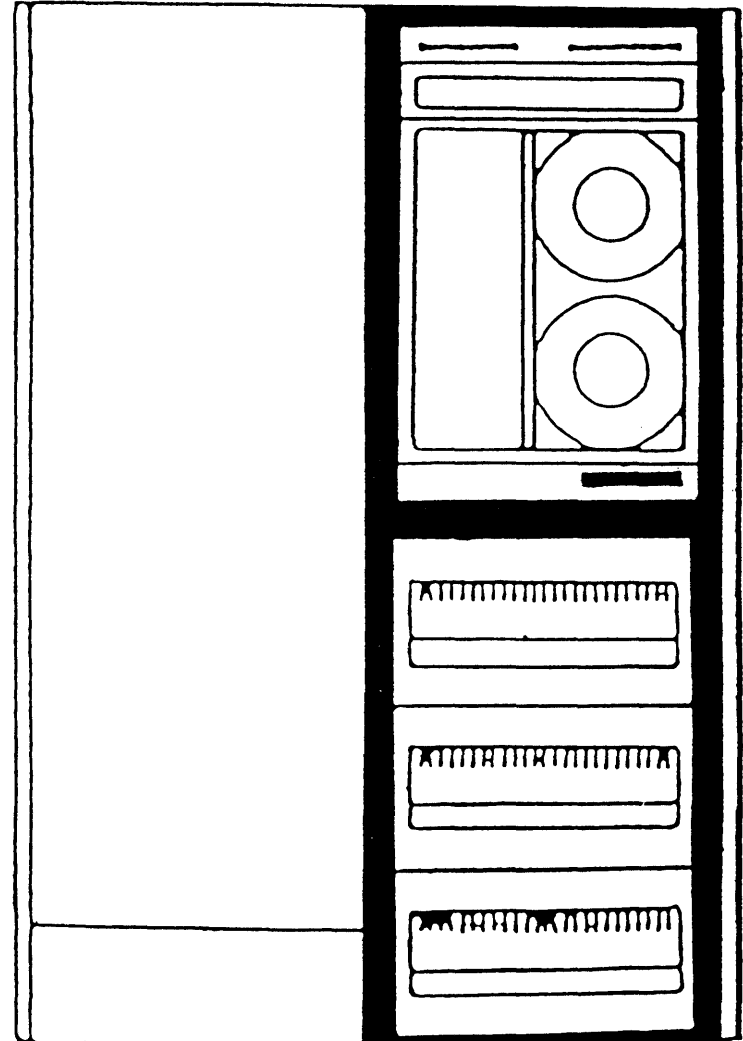
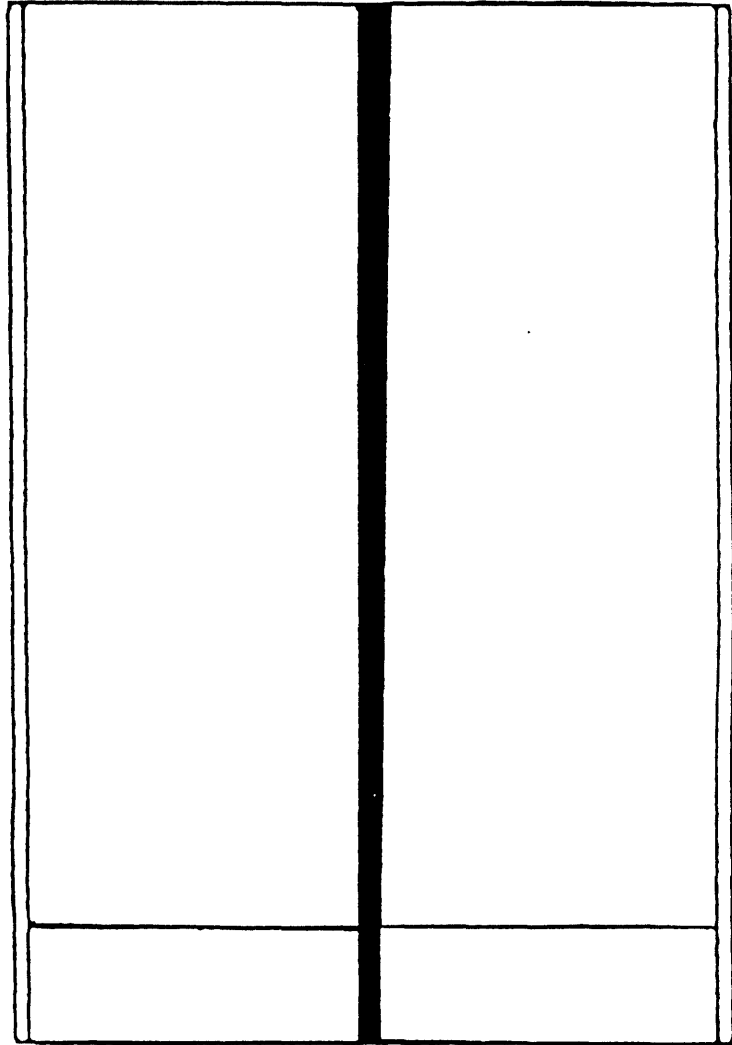

**AUGMENT ENGINE**

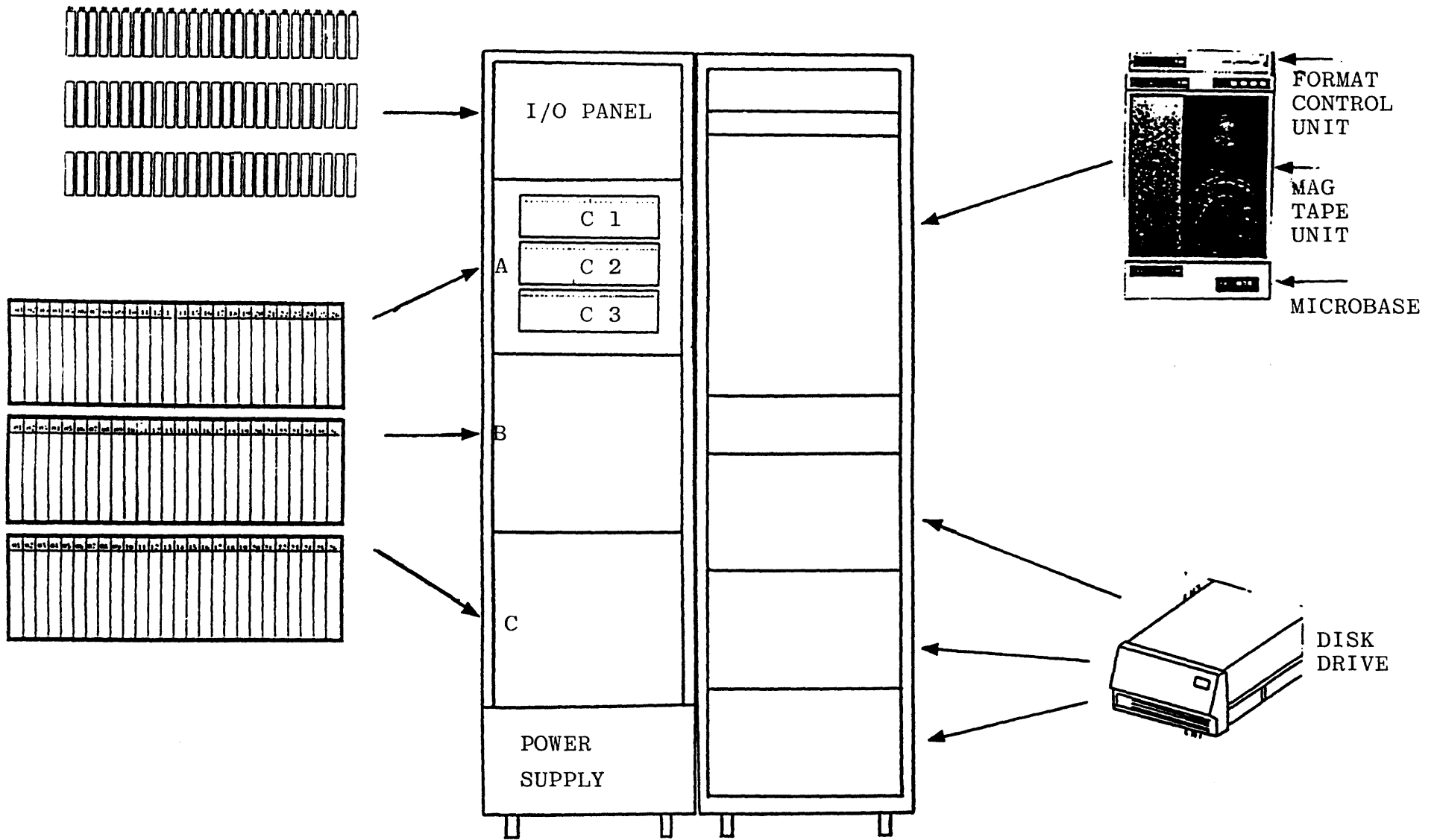

FRONT VIEW

AUGMENT ENGINE MAJOR UNIT LOCATIONS



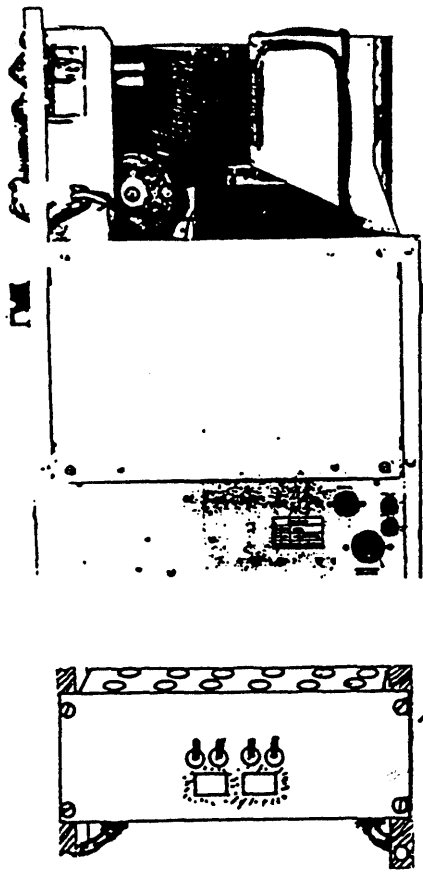

POWER  
DISTRIBUTION  
PANEL

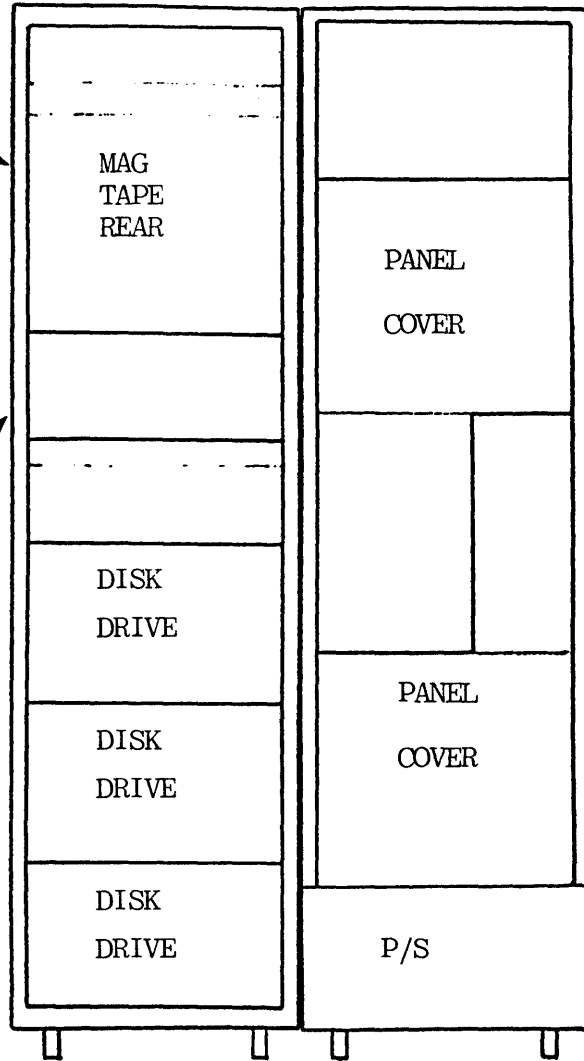

REAR VIEW

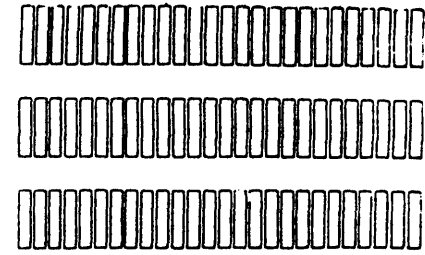

I/O PANEL

AUGMENT ENGINE MAJOR UNIT LOCATIONS

# AUGMENT ENGINE - BOARD DESCRIPTION

## "A" ROW

## SLOT

KLINT - KL INTERFACE BOARD	A01
CFDA - DISK CONTROLLER	A05
CFDB - DISK CONTROLLER (DRIVE INTERFACE)	A07
NET } LINE PRINTER CONTROLLER WITH OR } LPT } OPTIONAL ARPANET INTERFACE	A09
CFTA - TAPE DRIVE CONTROLLER TYMNET MICRONODE INTERFACE OPERATORS TERMINAL	A23

## "B" ROW

MMA } MICROCODE MEMORY BOARDS MMB } 4K X 88 BIT WORDS <u>EACH</u>	B03
SQ - SEQUENCER	B05
SM - SHIFTER/MASKER	B09
MC - MEMORY CONTROL	B15
MP - MAP	B17
B0 - BITSlice 0 (BITS 0 - 11)	B07
B1 - BITSlice 1 (BITS 12 - 23)	B11
B2 - BITSlice 2 (BITS 24 - 35)	B13

## MOS MEMORY

- 556K X 22 BITS EACH BOARD

8 BOARDS - 8 MEG. WORDS MAX.

0 - 15H/HIGH ORDER BITS 0 - 21

0 - 15L/LOW ORDER BITS 22 - 35 + (SIX ECC BITS)  
+ (ONE WORD PARITY BIT)  
+ (ONE SPARE BIT)

# AUGMENT ENGINE

Backplane board and pin locations

SAMPLE PIN LOCATION: A26C1C10

A

01	02	03	04	05	06	07	08	09	10	11	12	13	14	15	16	17	18	19	20	21	22	23	24	25	26
				C		C		N														C			
				F		F		E														F			
				D		D		T														T			
				A		B																A			

BOARD SIDE

B

01	02	03	04	05	06	07	08	09	10	11	12	13	14	15	16	17	18	19	20	21	22	23	24	25	26
M		M		S		B		S		B		B		M		M									
M		M		Q		Ø		M		1		2		C		P									
B		A																7	6	5	4	3	2	1	Ø
																		H	H	H	H	H	H	H	H

BOARD SIDE

C

01	02	03	04	05	06	07	08	09	10	11	12	13	14	15	16	17	18	19	20	21	22	23	24	25	26
15	14	13	12	11	10	9	8		7	6	5	4	3	2	1	Ø		15	14	13	12	11	10	9	8
L	L	L	L	L	L	L	L		L	L	L	L	L	L	L	L		H	H	H	H	H	H	H	H

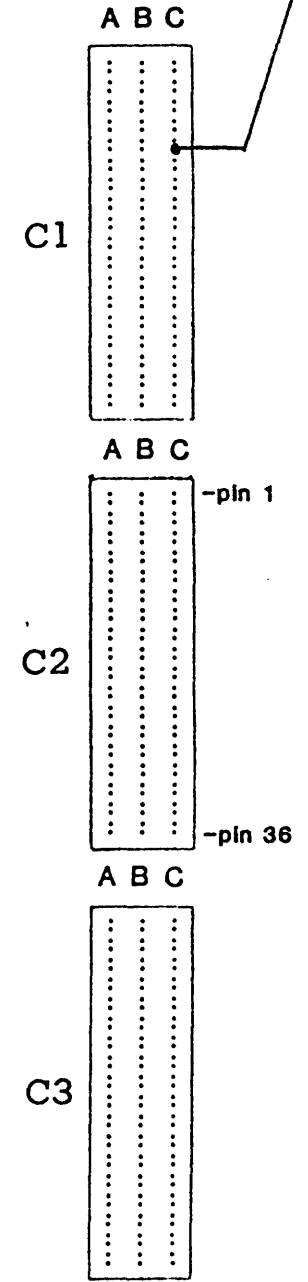

# AUGMENT ENGINE

LOCATION: A26C1A23

Backplane board and pin locations (backplane side)

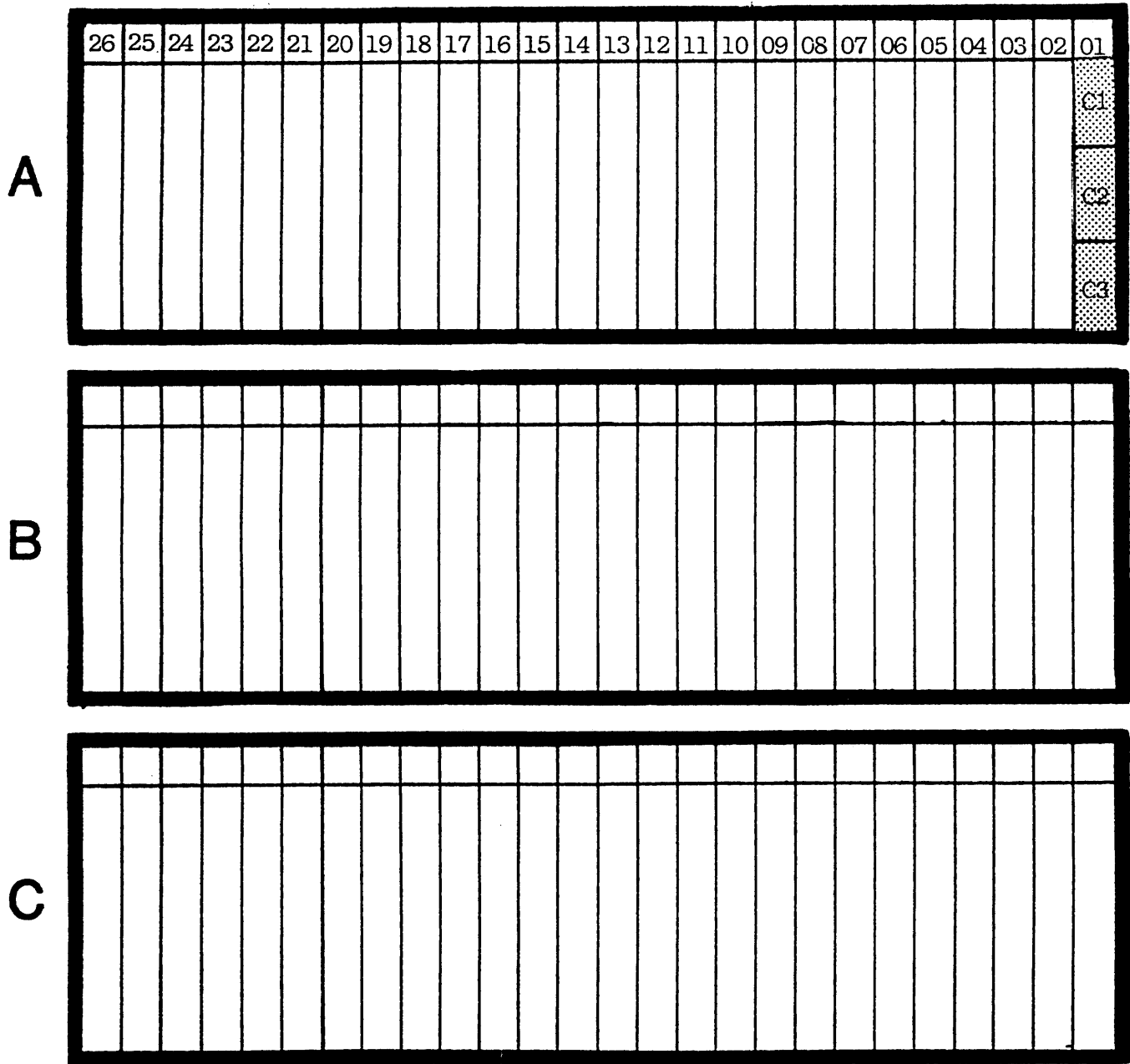

(pin side)

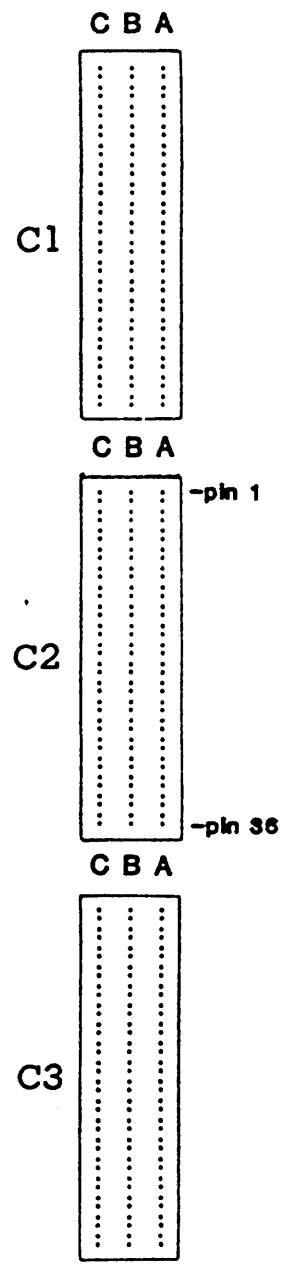

# AUGMENT ENGINE

## I/O DISTRIBUTION PANEL

TOP OF CPU CABINET

CONNECTOR VIEW

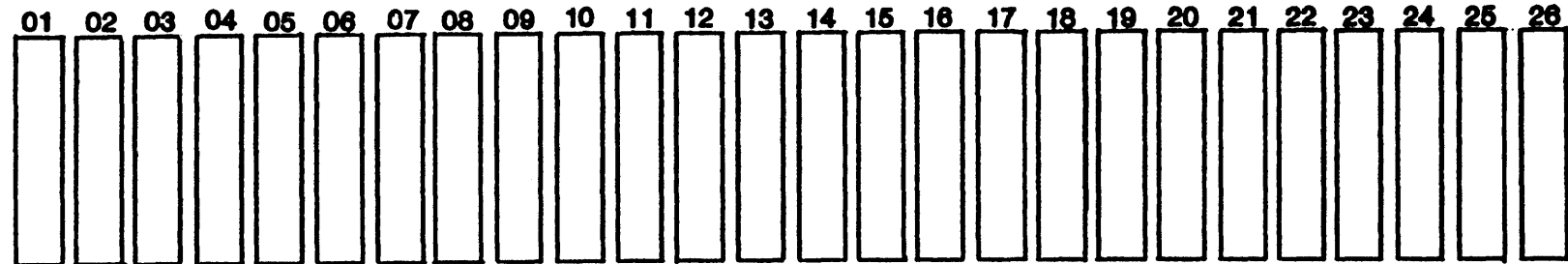

**A**

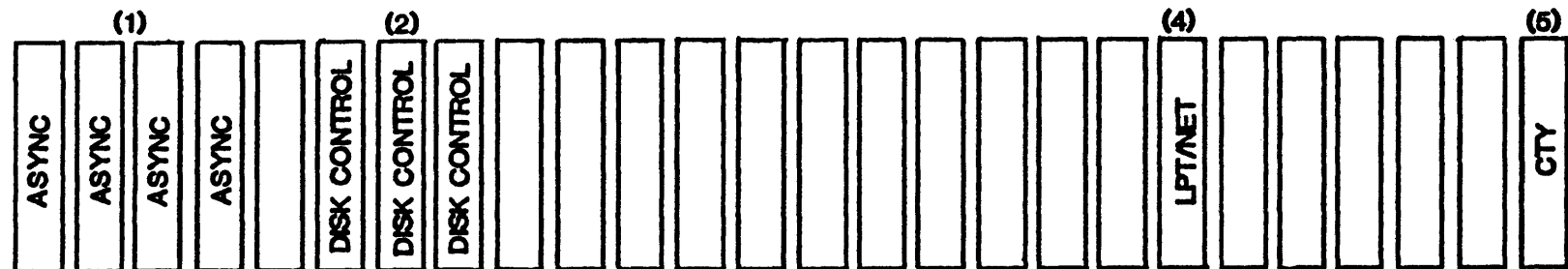

**B**

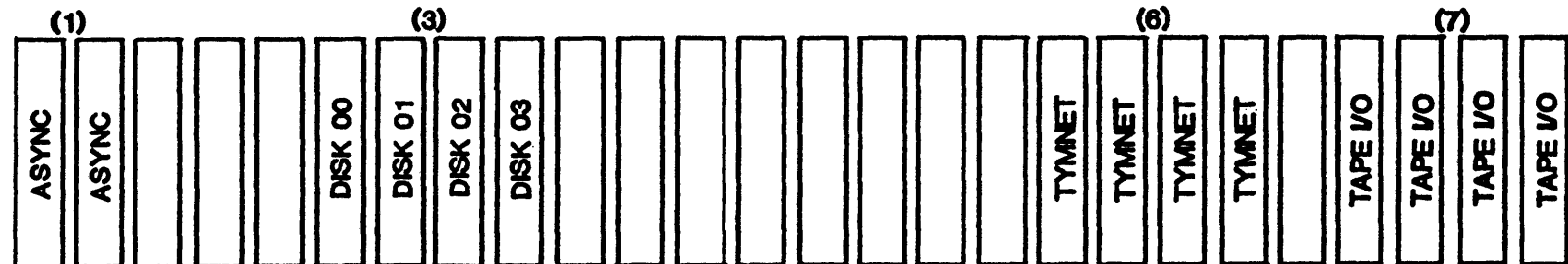

**C**

**NOTES:**

- (1) CONSOLE COMPUTER  
6 ASYNCHRONOUS LINES
- (2) 'A' CONTROL CABLE  
60 LEAD CABLE SPLIT TO 3 CONNECTORS
- (3) 'B' READ/WRITE CABLES
- (4) LPT/NET TO IMP MODULE

- (5) OPERATOR TERMINAL
- (6) I/O TO MICRONODE
- (7) I/O TO TAPE FORMATTER

Fig. 1

KLINT101.DWG  
26KL

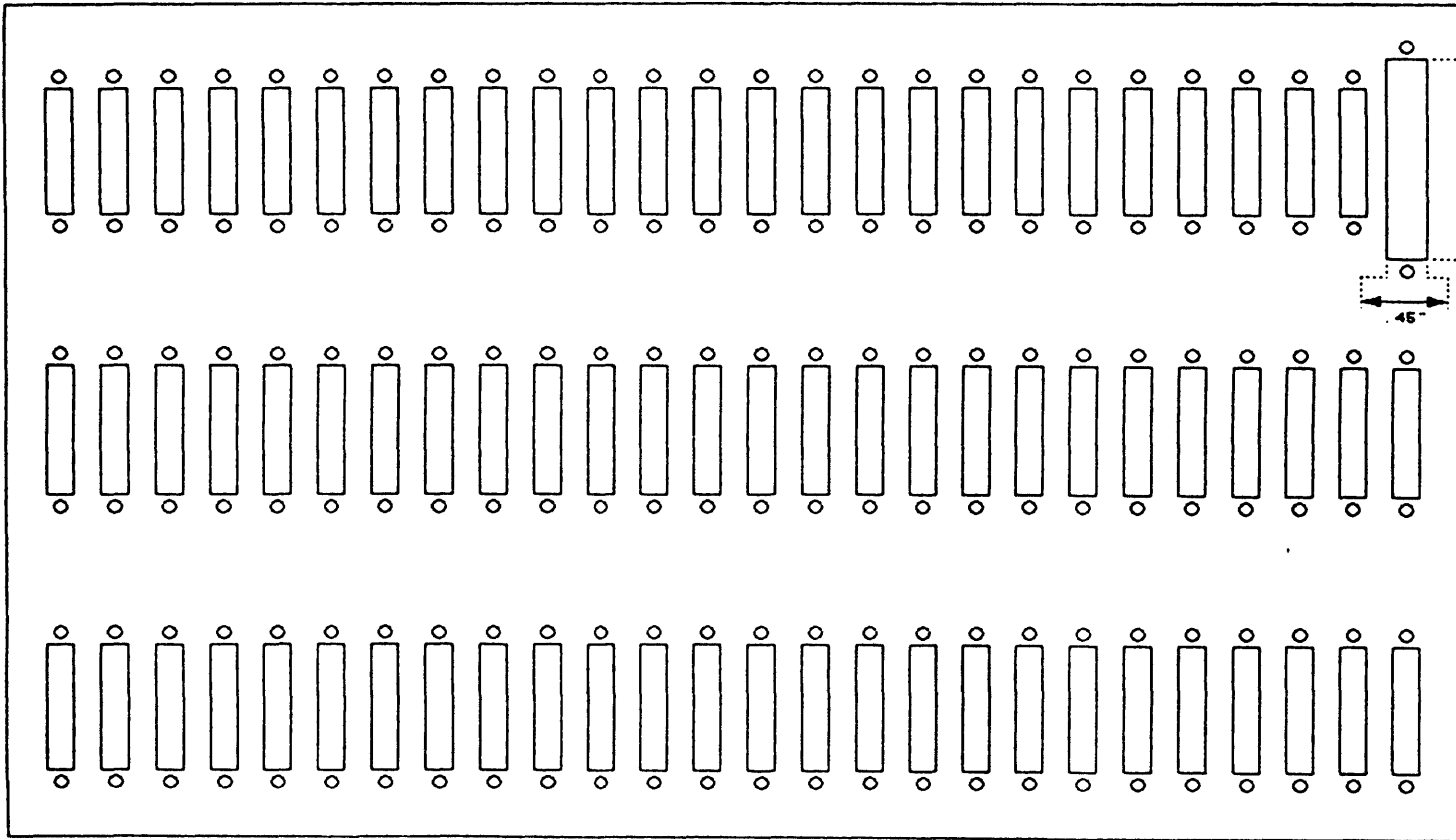

VIEW FROM WIRE WRAP SIDE OF I/O PANEL

**MACDONNELL DOUGLAS**

TITLE KLINT - I/O CONNECTOR  
MOUNTING

SIZE B	CODE	NUMBER	REV A
-----------	------	--------	----------

DATE SEPT. 13. 1984 SHEET 01 OF 02

KLINT102.DWG  
26XL

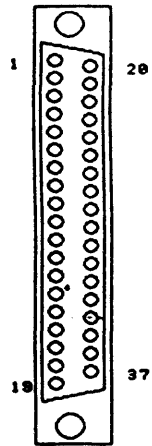

VIEW FROM WIRE WRAP SIDE

				<u>AB1</u>	<u>SIGNAL NAME</u>
( )	CC6-1	RED	TO	J2B-24	DATA 0 +
( )	CC6-20	WHITE	TO	J2B-25	DATA 0 -
( )	CC6-2	RED	TO	J2B-26	DATA 1 +
( )	CC6-21	WHITE	TO	J2B-27	DATA 1 -
( )	CC6-3	RED	TO	J2B-28	DATA 2 +
( )	CC6-22	WHITE	TO	J2B-29	DATA 2 -
( )	CC6-4	RED	TO	J2B-30	DATA 3 +
( )	CC6-23	WHITE	TO	J2B-31	DATA 3 -
( )	CC6-5	RED	TO	J2B-32	DATA 4 +
( )	CC6-24	WHITE	TO	J2B-33	DATA 4 -
( )	CC6-6	RED	TO	J2B-34	DATA 5 +
( )	CC6-25	WHITE	TO	J2B-35	DATA 5 -
( )	CC6-7	RED	TO	J2C-16	DATA 6 +
( )	CC6-26	WHITE	TO	J2C-17	DATA 6 -
( )	CC6-8	RED	TO	J2C-18	DATA 7 +
( )	CC6-27	WHITE	TO	J2C-19	DATA 7 -
( )	CC6-9	RED	TO	J3A-02	ADD 0 +
( )	CC6-28	WHITE	TO	J3A-03	ADD 0 -
( )	CC6-10	RED	TO	J3A-04	ADD 1 +
( )	CC6-29	WHITE	TO	J3A-05	ADD 1 -
( )	CC6-11	RED	TO	J3A-06	ADD 2 +
( )	CC6-30	WHITE	TO	J3A-07	ADD 2 -
( )	CC6-12	RED	TO	J3A-08	ADD 3 +
( )	CC6-31	WHITE	TO	J3A-09	ADD 3 -
( )	CC6-13	RED	TO	J3A-10	ADD 4 +
( )	CC6-32	WHITE	TO	J3A-11	ADD 4 -
( )	CC6-14	RED	TO	J3A-12	BD SEL +
( )	CC6-33	WHITE	TO	J3A-13	BD SEL -
( )	CC6-15	RED	TO	J2B-16	WRITE STRB +
( )	CC6-34	WHITE	TO	J2B-17	WRITE STRB -
( )	CC6-16	RED	TO	J2B-18	DATA PAR +
( )	CC6-35	WHITE	TO	J2B-19	DATA PAR -
( )	CC6-17	RED	TO	J2B-20	PAR ERR +
( )	CC6-36	WHITE	TO	J2B-21	PAR ERR -
( )	CC6-18	RED	TO	J2B-22	WRITE L +
( )	CC6-37	WHITE	TO	J2B-23	WRITE L -

**MACDONNELL DOUGLAS**

TITLE KLINT - I/O CONNECTOR MOUNTING

SIZE B	CODE	NUMBER	REV A
-----------	------	--------	----------

DATE SEPT. 19, 1984 SHEET 02 OF 02

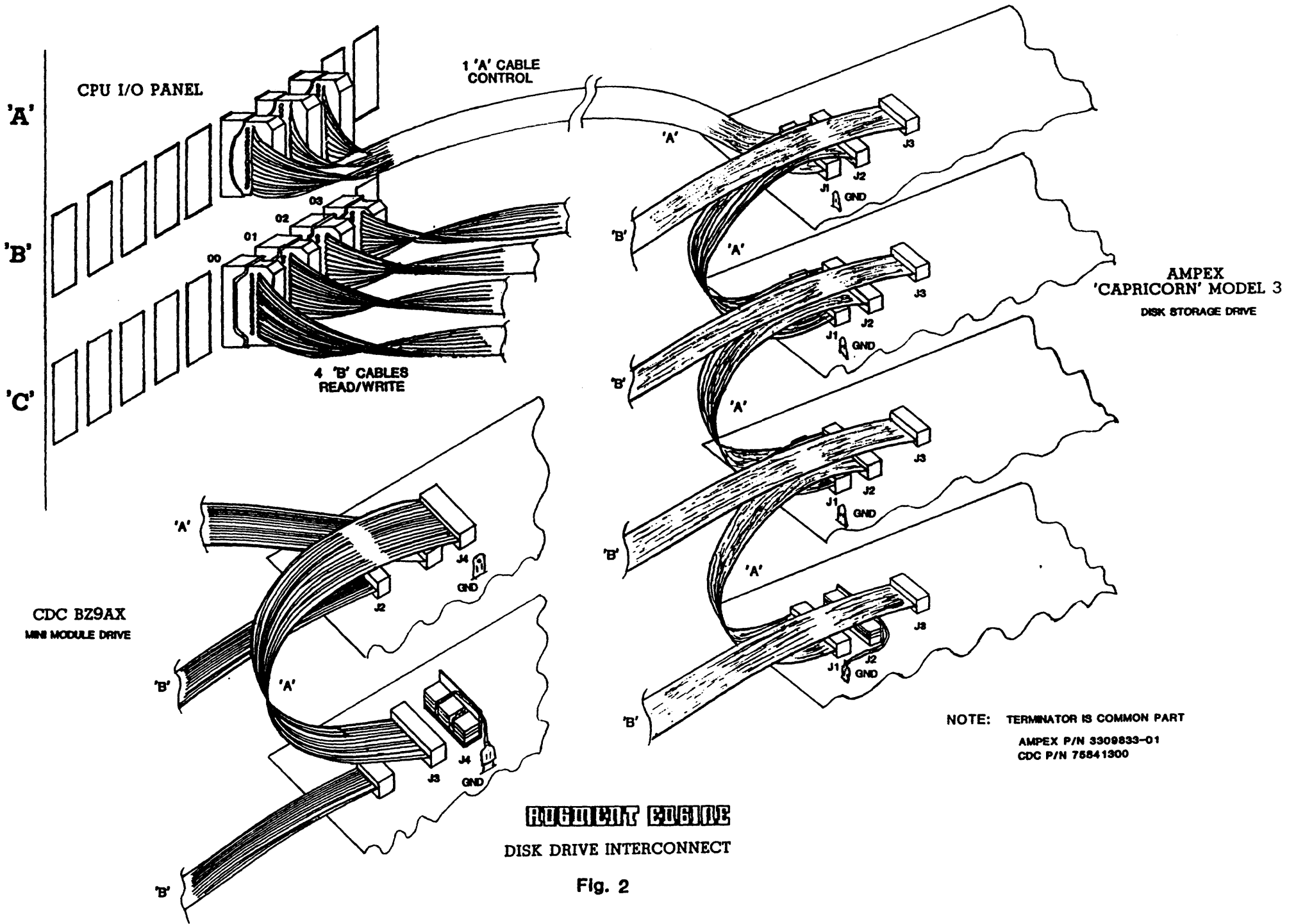



# CAPRICORN 330

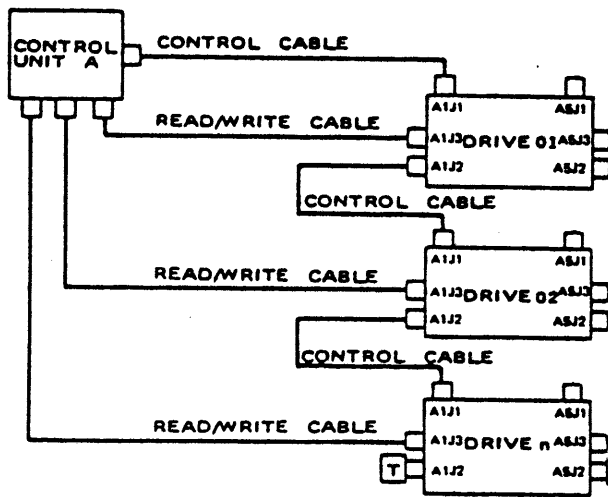

DAISY-CHAIN CONFIGURATION

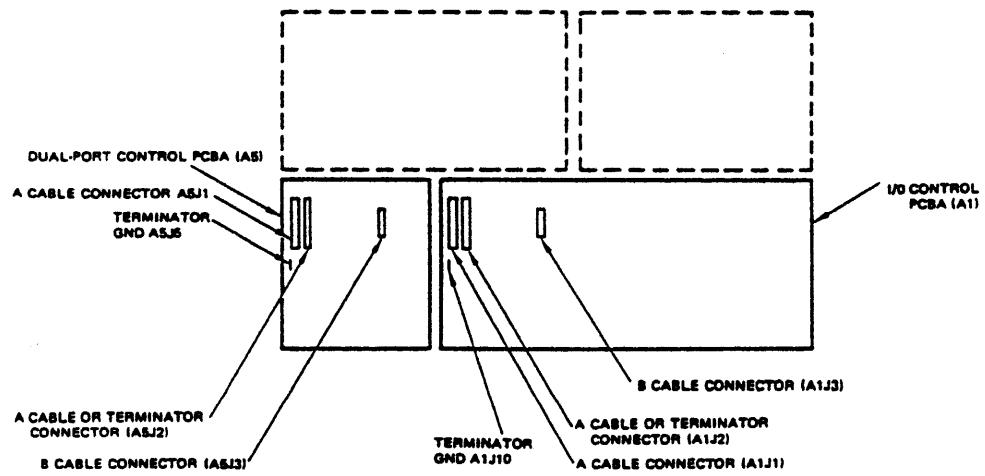

A. LOCATION OF I/O CONNECTORS

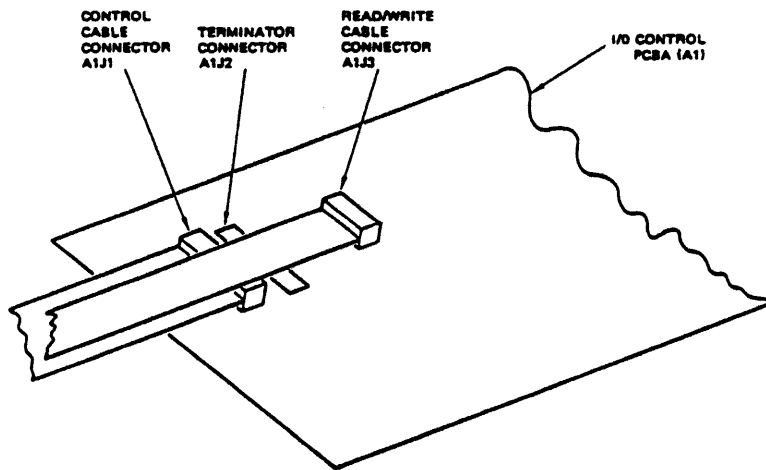

B. SINGLE-DRIVE SYSTEM I/O CONNECTIONS  
I/O Cable Attachment

# ROBOTIC POSING

## CONTROL CABLE "A" CABLE

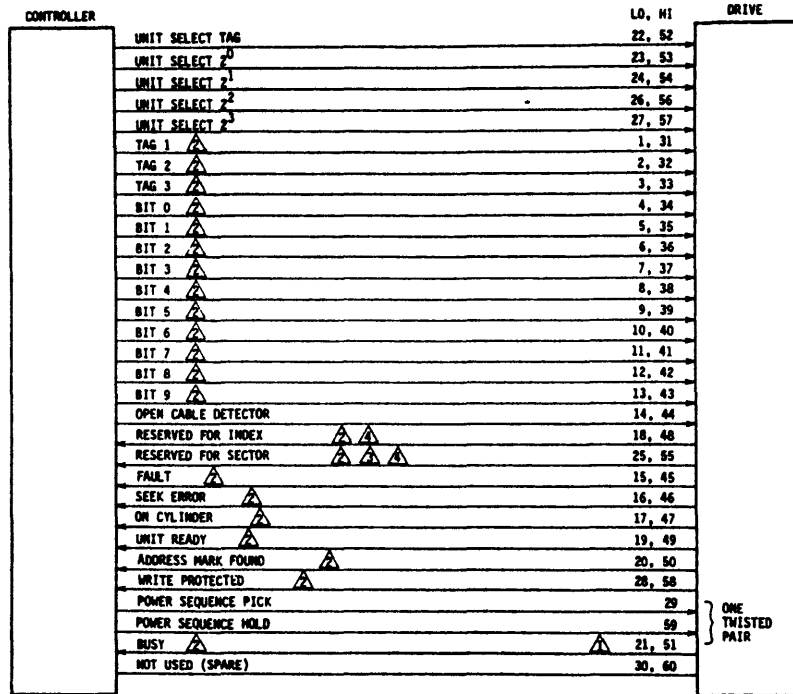

NOTES:

- △ DUAL CHANNEL UNITS ONLY
- △ GATED BY UNIT SELECT
- △ CALLED SECTOR MOD ON B2B1J/K/L/M AND B2B4E/F
- △ INDEX AND SECTOR MAY BE IN "A" CABLE AND/OR "B" CABLE.

## READ/WRITE CABLE "B" CABLE

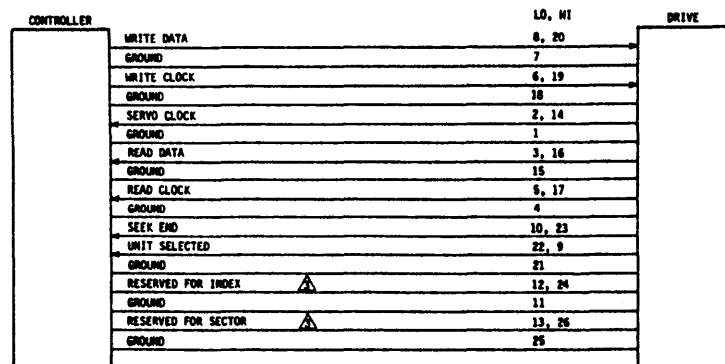

NOTES:

- 1 26 CONDUCTORS FLAT CABLE. MAXIMUM LENGTH - 50 FT.
- 2 NO SIGNALS GATED BY UNIT SELECTED.
- △ INDEX AND SECTOR MAY BE IN "A" CABLE AND/OR "B" CABLE.

## DISK INTERFACE CABLES

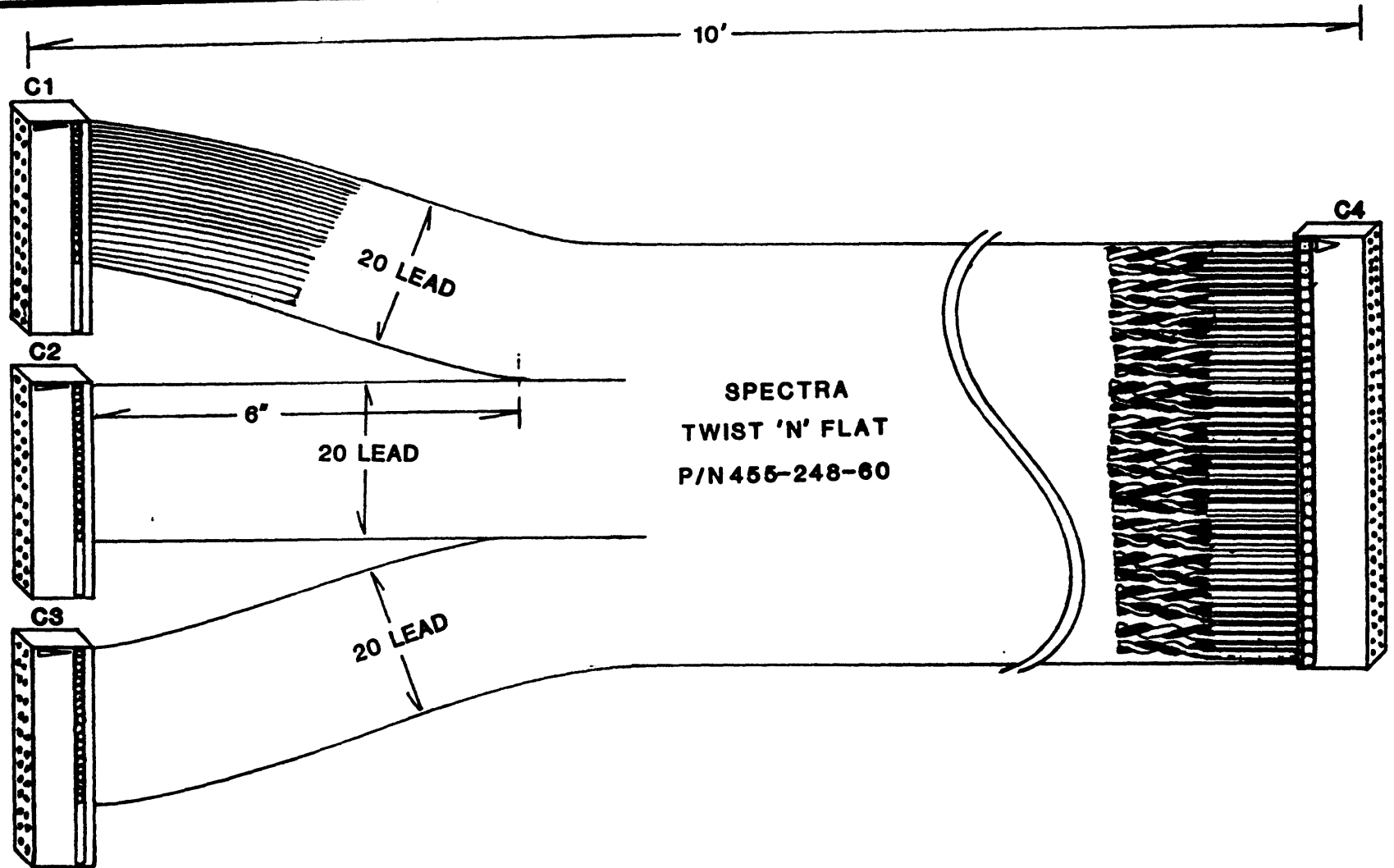

C1, C2, & C3 - P/N 802-126-002

C4 - P/N 802-160-002

ALL CONTACTS TIN

**CONNECTOR INSTALLATION**

- C1 PIN1 - C4 PIN1
- C2 PIN1 - C4 PIN 21
- C3 PIN1 - C4 PIN 41

<b>MACDONNELL DOUGLAS</b>		
DATE 12-01-82	DRAWN BY HRK	APPROVED BY
SCALE NOT TO SCALE	REVISED	
<b>ARGUMENT ENGINE A-1 CABLE</b>		
<b>I/O TO DISK DRIVE</b>		DRAWING NUMBER 9730-00

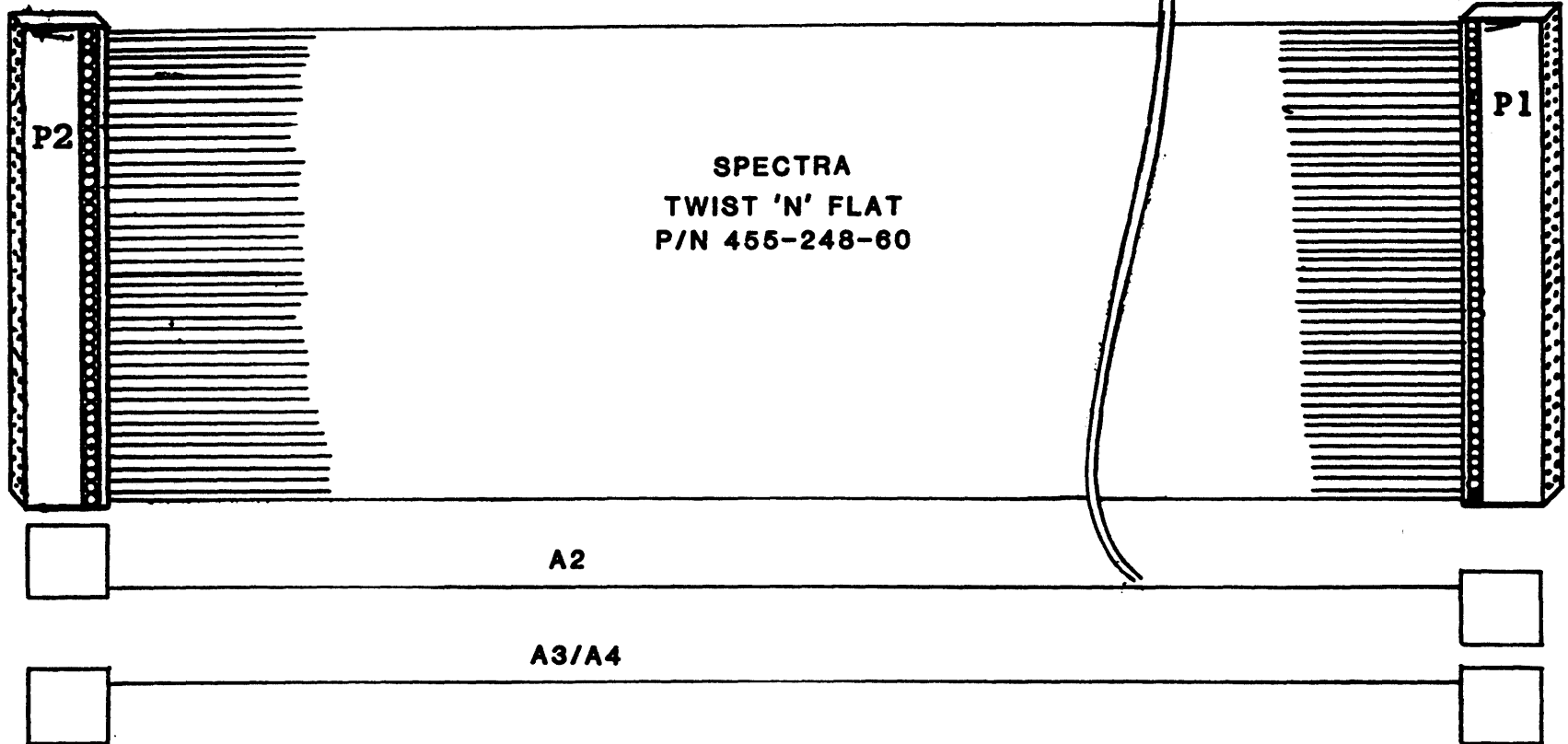

SPECTRA  
TWIST 'N' FLAT  
P/N 455-248-60

A2 P/N 9730-06  
A3 P/N 9730-15  
A4 P/N 9730-20  
P1/P2 P/N IDC 802-160-002

NOTE 1: DASH NO. INDICATES CABLE LENGTH  
NOTE 2: CABLE A2 HAS CONNECTORS REVERSED

<b>MACDONNELL DOUGLAS</b>		
DATE 12-06-82	DRAWN BY HRK	APPROVED BY
SCALE NOT TO SCALE	REVISED	
<b>AVIATION ENGINE A2-4 CABLES</b>		
<b>DISK INTERCONNECT</b>		DRAWING NUMBER 9730-XX

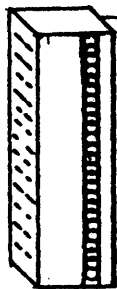

SPECTRA  
 PLANAR CABLE  
 P/N 455-240-26

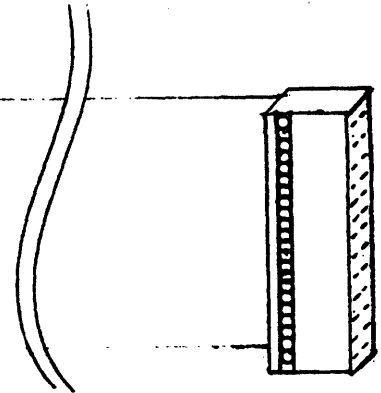

B1 P/N 9740-10  
 B2 P/N 9740-20  
 P1/P2 P/N 802-126-002

<b>MACDONNELL DOUGLAS</b>		
DATE	12-06-82	DRAWN BY HRK
SCALE	NOT TO SCALE	APPROVED BY
		REVISED
<b>REVISION B1-2 CABLES</b>		
<b>CPU TO DISK R/W</b>		DRAWING NUMBER
		<b>9740-XX</b>

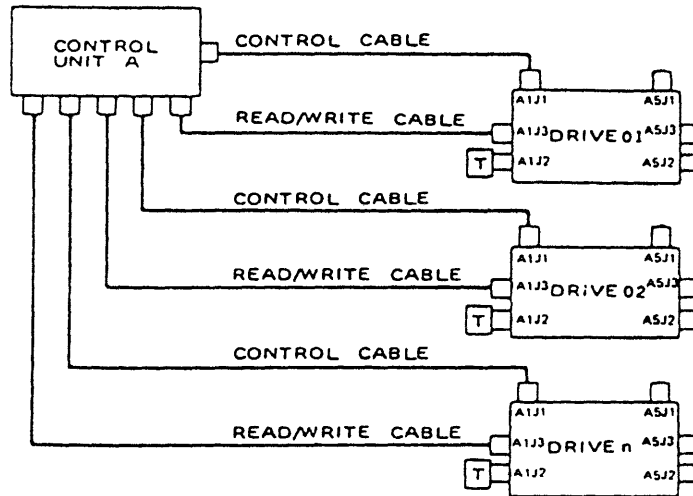

RADIAL CONFIGURATION

N/U

4

3

2 [3309833-01]

1 CODE:

REVISIONS			SIGNATURE AND DATE		
LTR	ECO	DESCRIPTION	DRAWN BY	CHK BY	ENGRG APPD
1	—	PROTOTYPE REL	<i>Walt</i> 1-19-81		

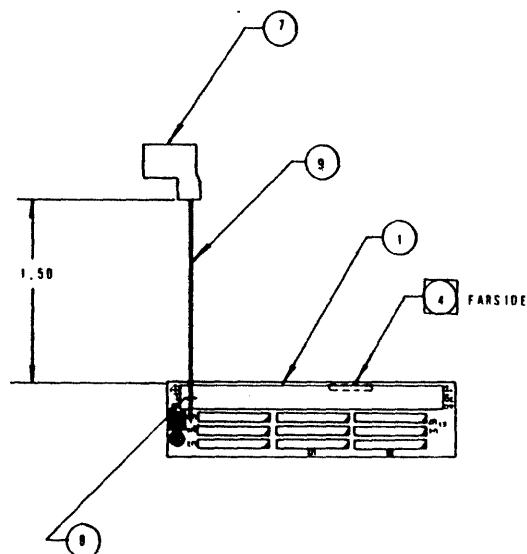

- 4 MARK ASSEMBLY REVISION LEVEL.  
 3. ASSEMBLE PER AMPEX STANDARDS.  
 2. REFERENCE SCHEMATIC 3309830-01.  
 1. LOCATE COMPONENTS BY MATCHING REFERENCE DESIGNATIONS IN P/L.

NOTES: UNLESS OTHERWISE SPECIFIED.

PARTS LIST ■

		NOTICE		UNLESS OTHERWISE SPECIFIED		SIGNATURE		DATE		AMPEX		MEMORY PRODUCTS DIVISION			
		THIS DRAWING SHALL NOT BE DUPLICATED FOR ANY PURPOSE OTHER THAN THAT FOR WHICH PROVIDED OR DISCLOSED IN WHOLE OR IN PART WITHOUT THE WRITTEN CONSENT OF AMPEX CORPORATION PROVIDED HOWEVER THAT IF THIS DRAWING IS SPECIFIED TO BE DELIVERED TO THE GOVERNMENT OR TO A GOVERNMENT CONTRACTOR PURSUANT TO A GOVERNMENT PRIME OR SUBCONTRACT THE GOVERNMENT MAY MAKE SUCH USE OF THIS DRAWING AS IS PERMITTED BY THE APPLICABLE "DATA" CLAUSE SET FORTH IN SUCH CONTRACT OR SUBCONTRACT		DIMENSIONS ARE IN INCHES AND INCLUDE CHEMICALLY APPLIED OR PLATED FINISHES		DRAWN BY <i>Walt</i>		DATE <i>1-19-81</i>		PRINTED WIRING BD ASSY CONT CABLE TERMINATION TERRC					
				TOL		2PLC 3PLC		ANG							
				NEXT ASSY		USED ON		REMOVE BURRS AND SHARP EDGES		DO NOT SCALE THIS PRINT		SIZE		CODE IDENT NO	
				APPLICATION				MATERIAL		FINISH		C 09150		3309833-01	
										SCALE 1/1		SHEET 1 OF 1			

4

3

2

1

FORM 200A

A-47

[3309833-01]

# P O W E R   D I S T R I B U T I O N

AUGMENT ENGINE Main Power Distribution panel (PDP) is located in the I/O cabinet.

Main power is supplied from two 30 amp single phase power cables. Main power is controlled by 4 circuit breakers at the back of the "PDP". Each breaker supplies a group of three single phase sockets on top of the "PDP". Each disk drive and the tape drive should be plugged into a separate group to balance the power load. Extra sockets are available for the console and Operator's terminals, tape formatter, micronode, and other small loads. All input power passes through a \*RFI filter in the "PDP".

Other local power breakers are one each device and in the CPU cabinet - see page #2

\* Radio Frequency Interference filter

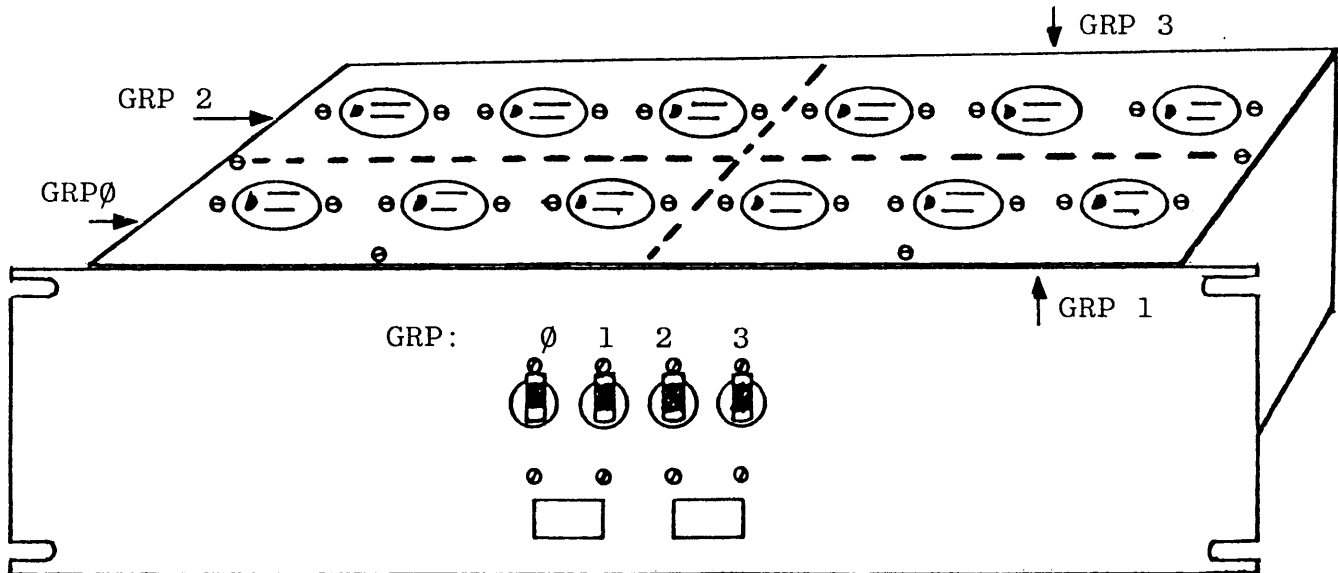

**POWER DISTRIBUTION PANEL**



# LOCAL CIRCUIT BREAKER DESCRIPTION

## CPU CABINET

\* bottom/ Backplane-Pin side (under false air intake)

\* 2 pole breaker

1. Separate Console power supply

\* SWITCH

1. Power supplys to backplane

## I/O CABINET

\* Disks

1. One breaker each at rear

\* Tape

1. On/Off Button on front

\* Tape Formatter

1. No local power switch

\* Micronode (PDP 11/23 or 11/02)

1. On/Off switch at rear

\* PDP

1. See Page #1

NOTES, UNLESS OTHERWISE SPECIFIED.

1. TERMINAL/PIN DESIGNATORS ARE SHOWN FOR REFERENCE AND WIRING PURPOSES AND MAY NOT APPEAR ON THE PARTS,

REVISIONS				
REV	DESCRIPTION	CHECK	DATE	APPROVED
A	FABRICATION RELEASE	<i>S.E.K.</i>	<i>12/14/53</i>	<i>John L. Beck</i>

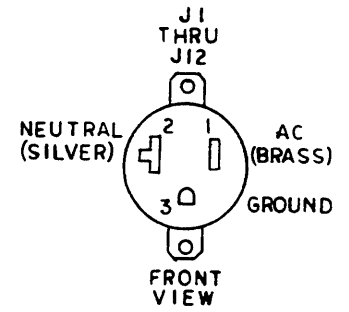
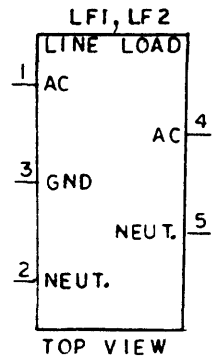
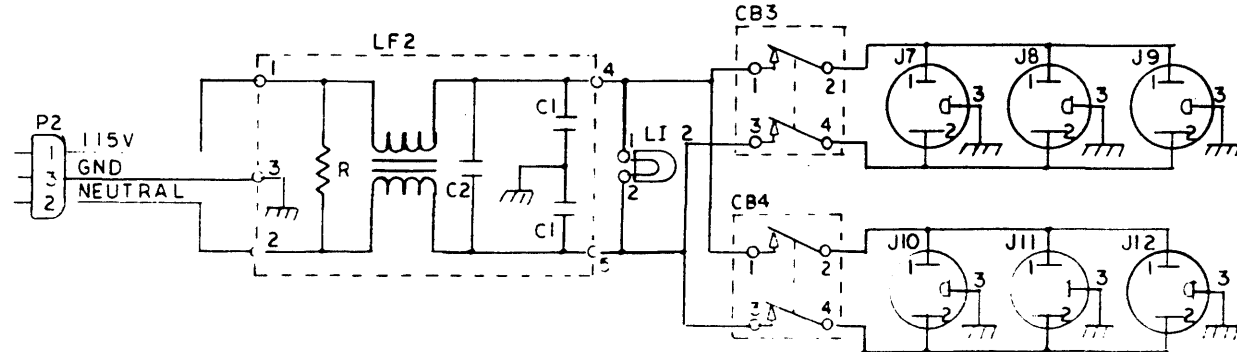
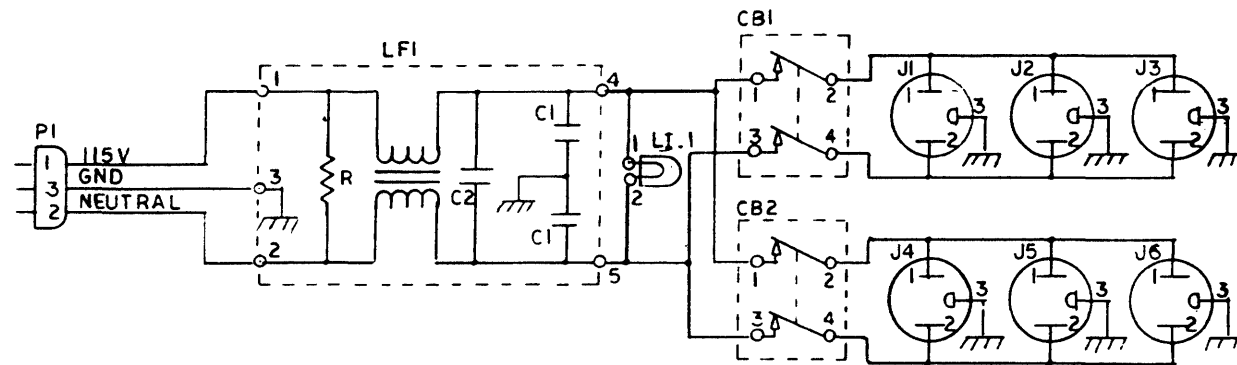
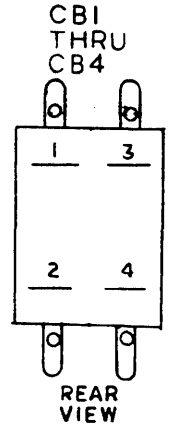
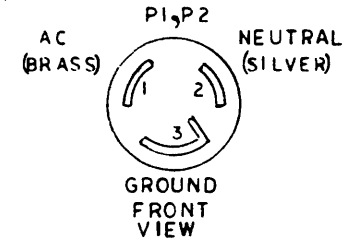
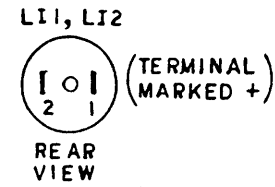

DRAWN	SAM	12/14/53
CHECK	<i>S.E.K.</i>	<i>12/14/53</i>
APPR	<i>John L. Beck</i>	12/14/53
NOTES, UNLESS SPECIFIED.		
1. TOLERANCES		
.XX	±.020	ANGULAR
.XXX	±.005	± 1/2°
2. BREAK ALL SHARP EDGES .010 APPROX.		
3. MACH SURFACES $\nabla$		
4. ALL DIM. IN INCHES		
MODEL NO.		
NEXT ASSY		

TITLE		
SCHEMATIC, POWER DISTRIBUTION UNIT		
SIZE	DWG NO.	CHANGE LETTER
B	V100227	A
SCALE NONE		SHT 1 OF 1

# POWER DISTRIBUTION PANEL

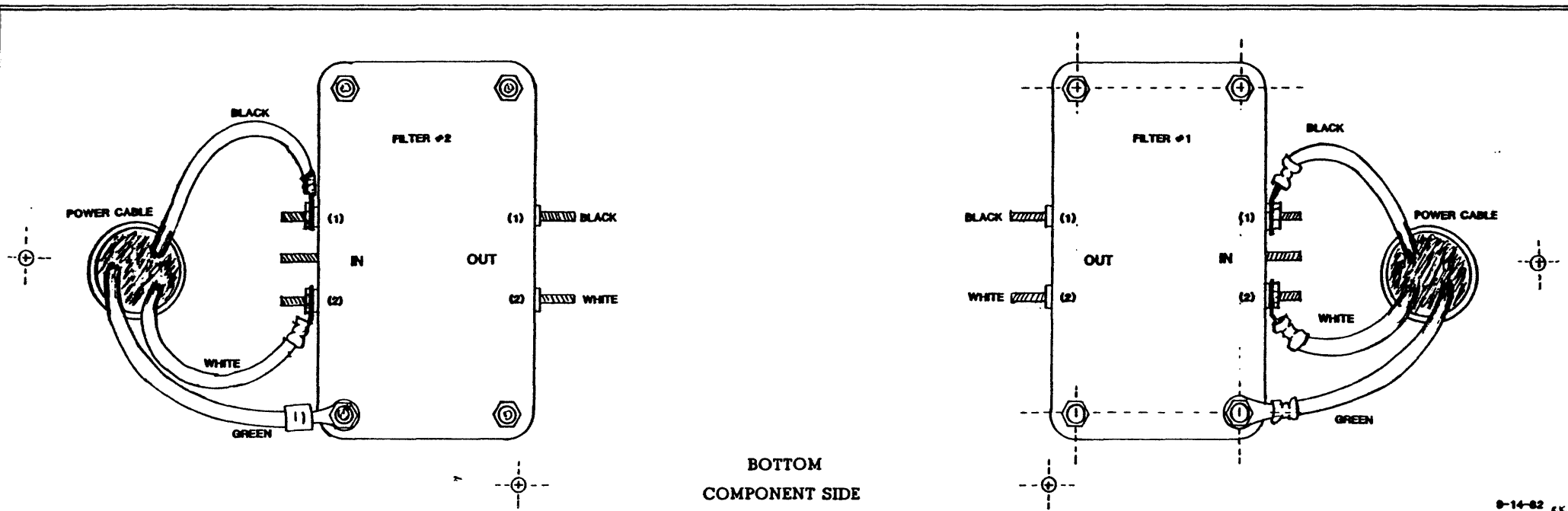

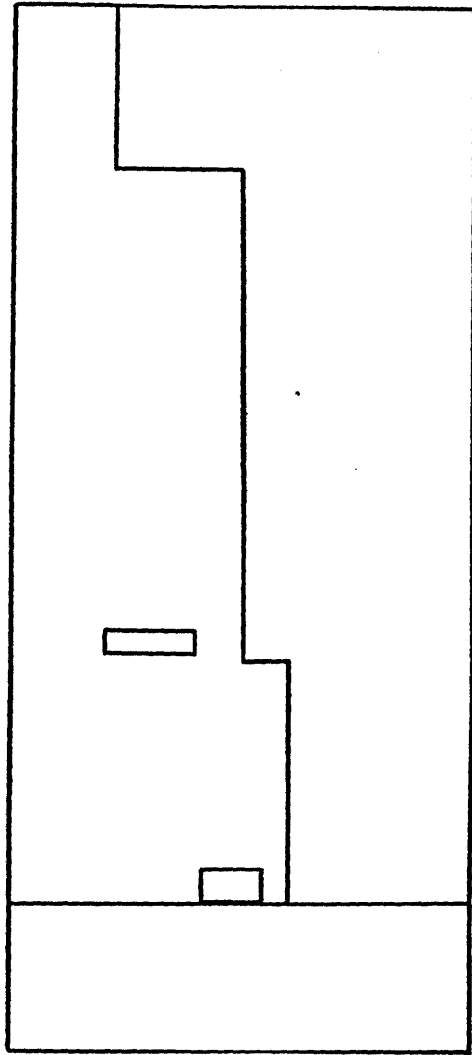

LEFT SIDE

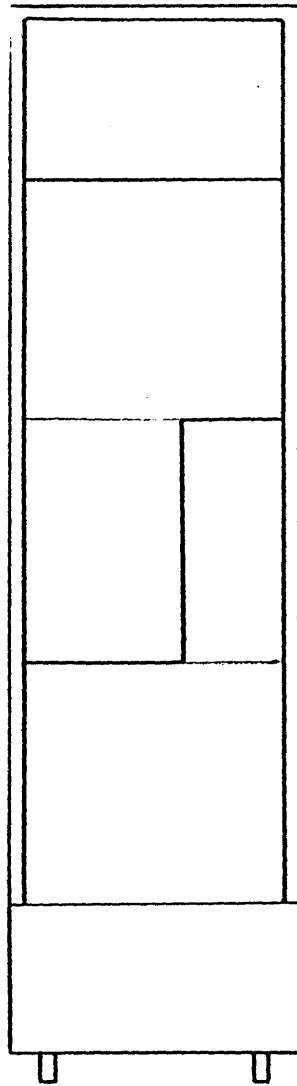

REAR VIEW  
(PANELS REMOVED)

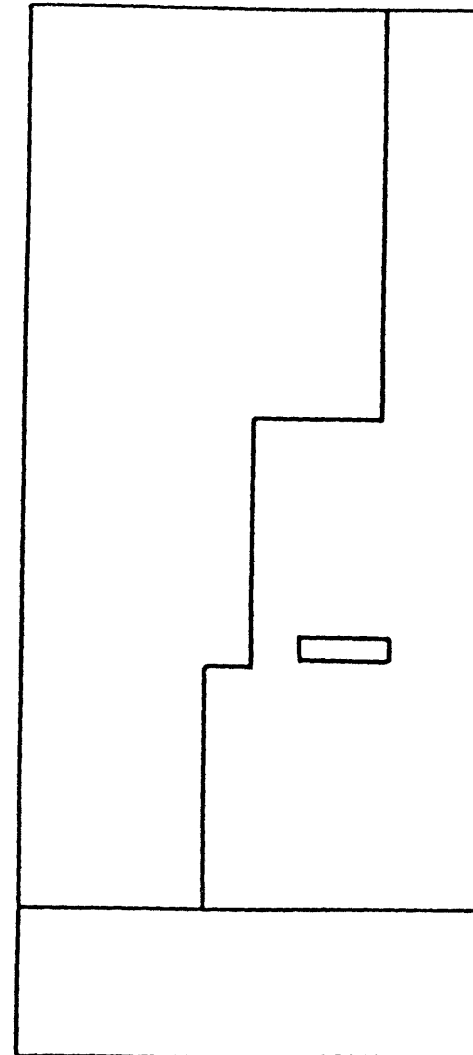

RIGHT SIDE

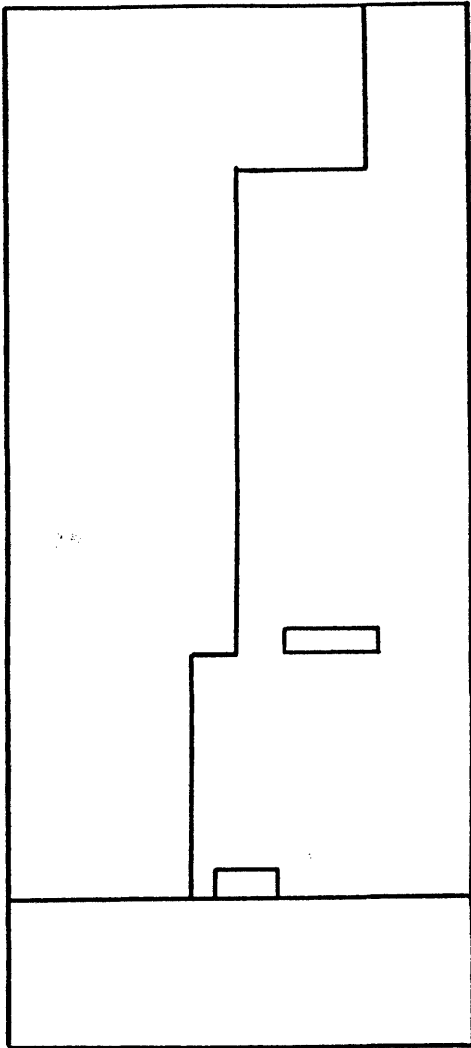

LEFT SIDE

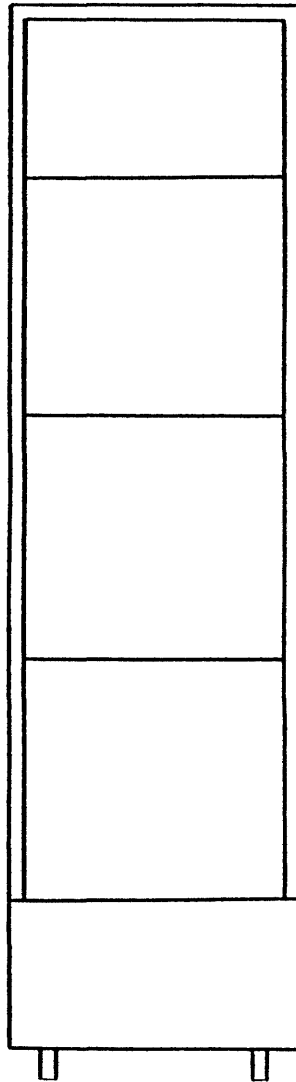

FRONT

(PANELS REMOVED)

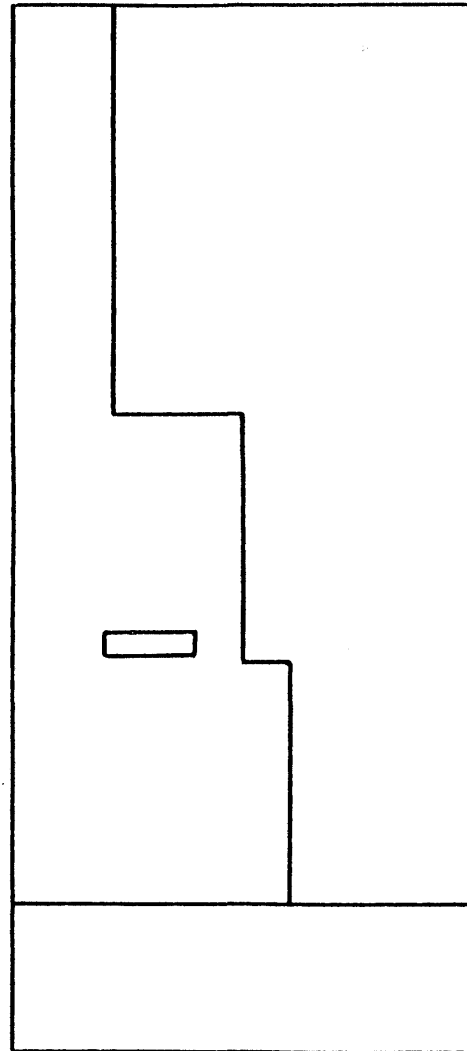

RIGHT SIDE

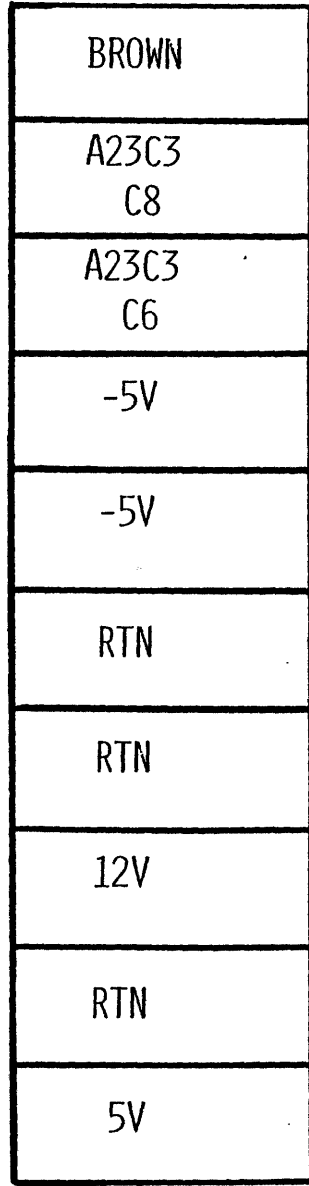
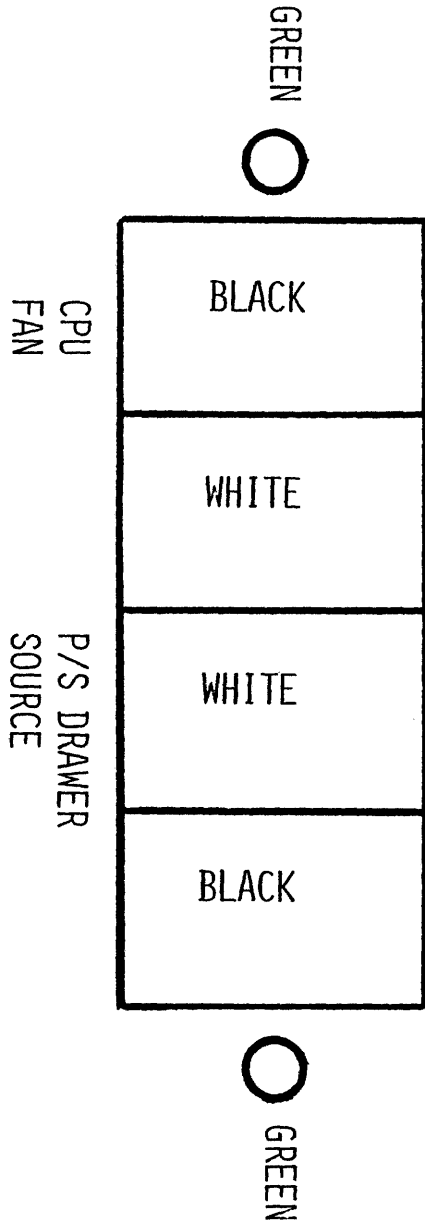

FRONT

LEFT

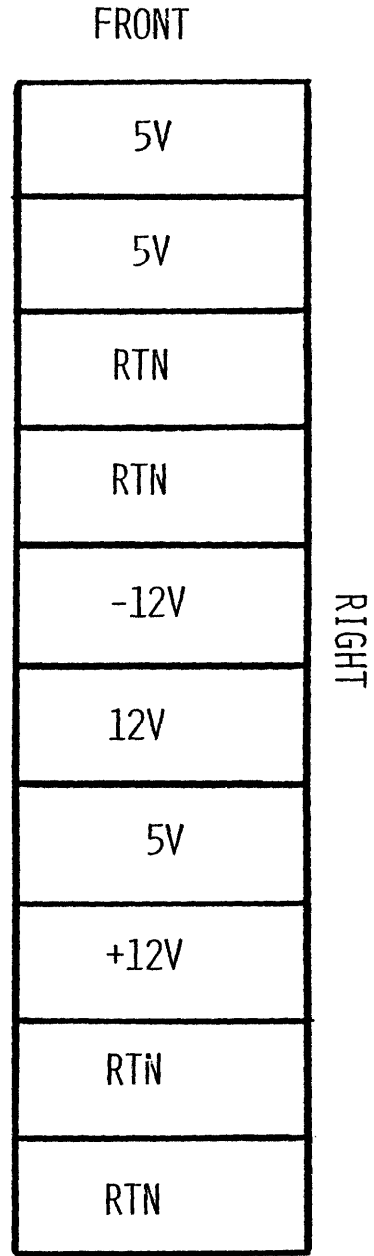

FRONT

RIGHT

(C3)

(toggle SW)

of pots  
of fuses

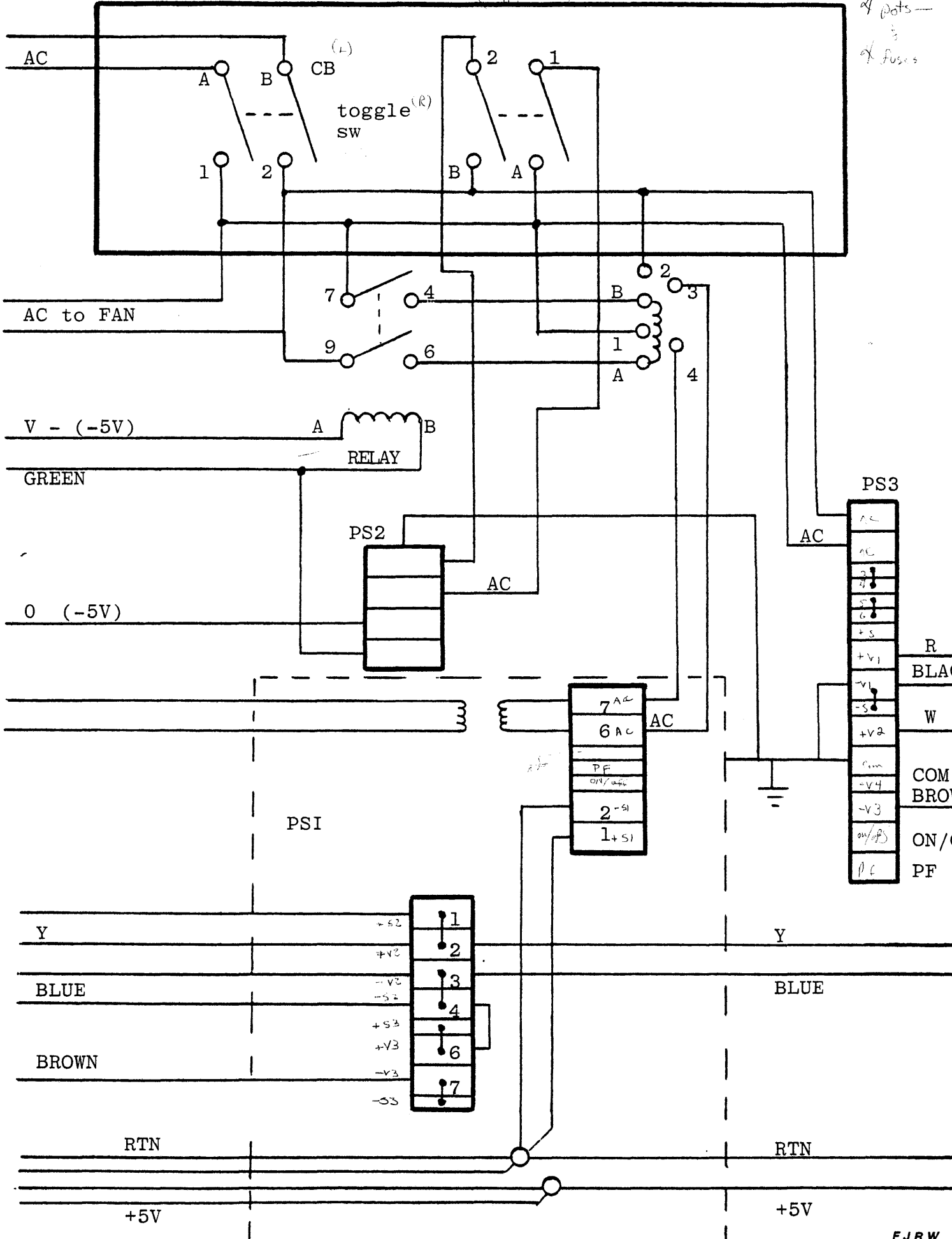

POWER DRAWER

PS1 --- P8310399AA  
PS2 --- A08411  
PS3 --- T8370639B

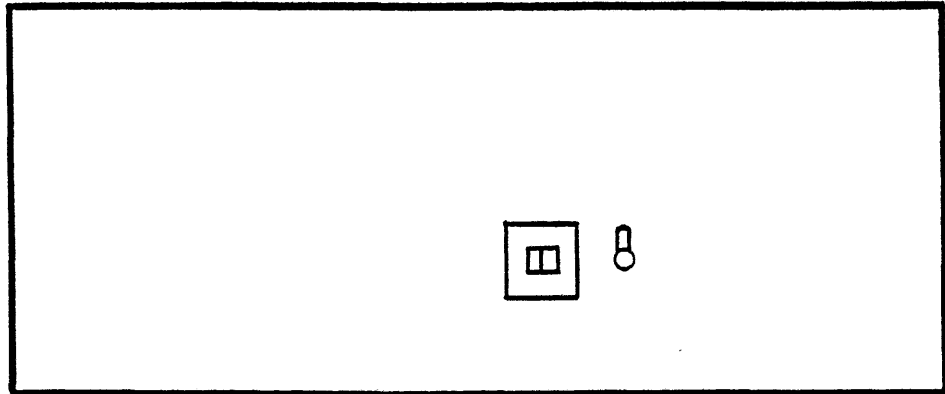

MERCURY DISPLACEMENT

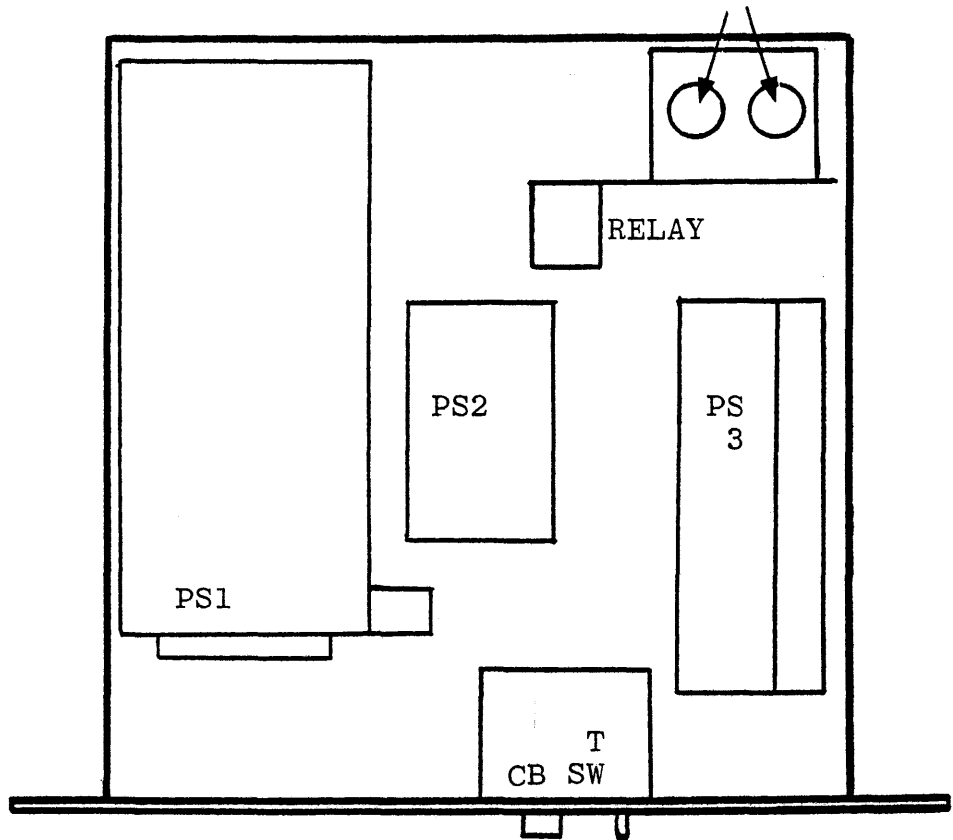



--POWER DRAWER PARTS--

- (1) Drawer (Chassis )
- (2) Slide Rail Grant 5705-16"
- (1) 5 Output Electroventure TTM35-12Y2Y15/115
- (1) 3 Output Electroventure MM43-12Y2Y/115
- (1) -5V Supply (Lambda) LNS-Y-5-OV
- (1) 6VDC Master Dist. W388CPX-5
- (1) 120VDC (Mercury Displacement) WM35AA-120A
- (1) Relay Socket P&B 27E067 (Quick disconnect type)
- (1) Circuit Breaker (15 AMP) P & B W92X11-2-15
- (1) Switch(15A DPST, Toggle) 12TS15-2
- (2) Trigger Latches Hartwell HTL-81
- (1) Transformer Triad #F-13X
- (2) Terminal Block, 10 Pos. Kulka 9-85-10
- (1) Terminal Strip, 4 Pos. Kulka 603-4
- (73) 35.2.1 (.27)QPAK 7" Lengths
- (30.2)Buss Strips 17" Lengths



# RUGMENT ENGINE

B

(backplane side)

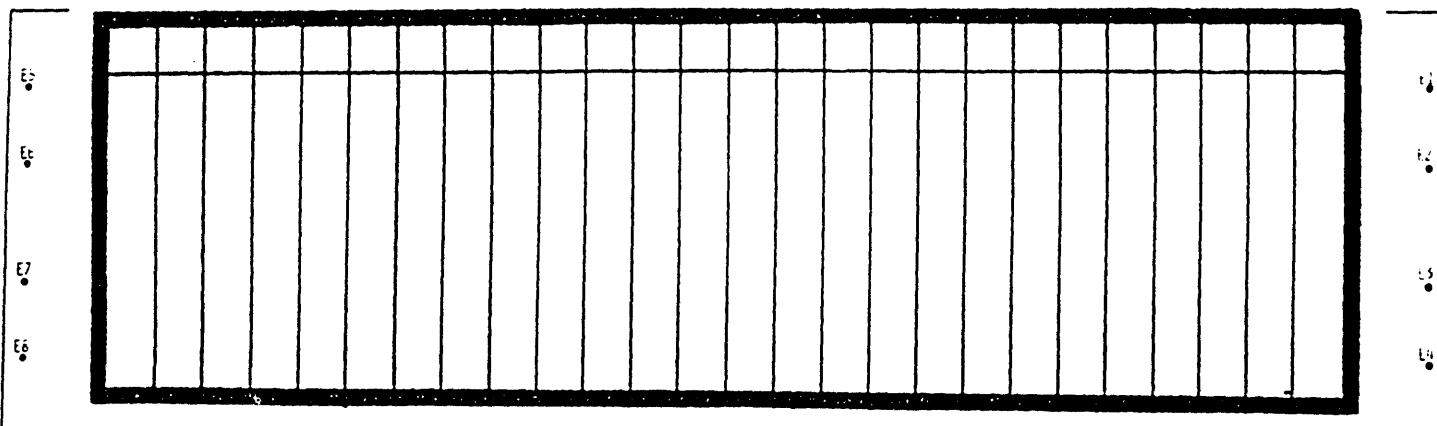
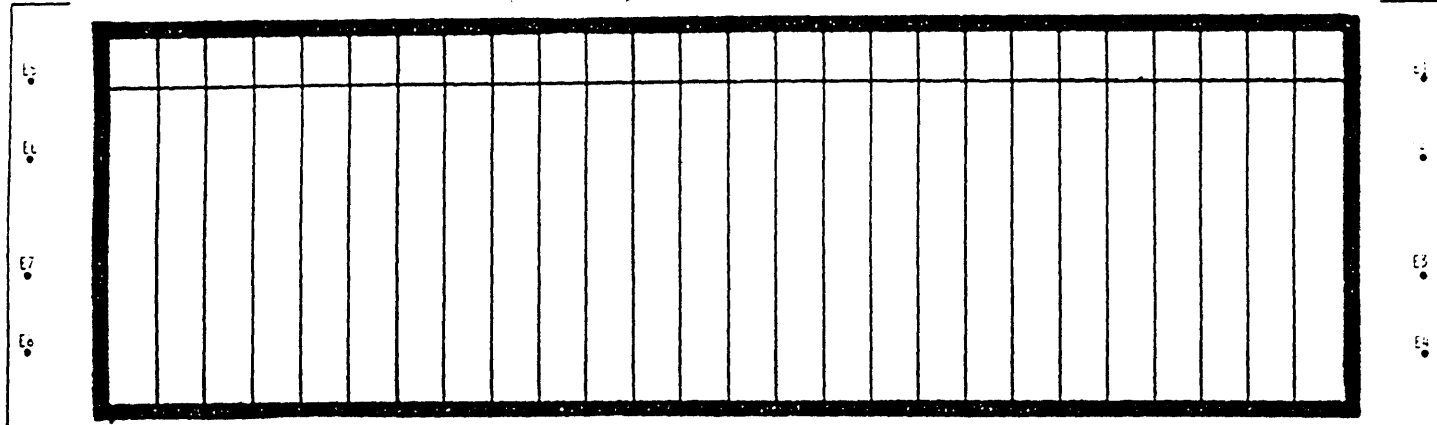
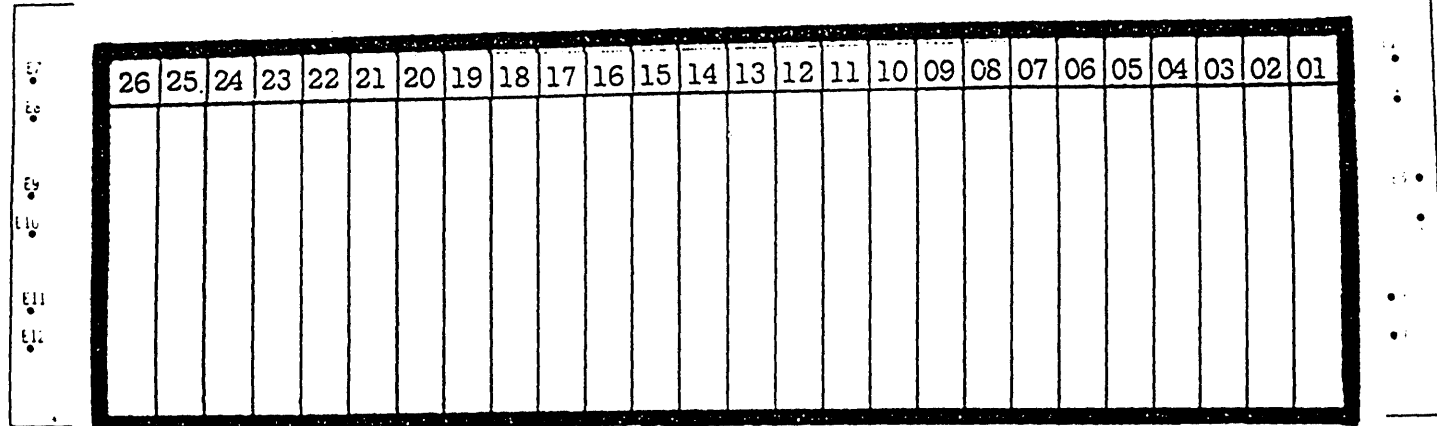
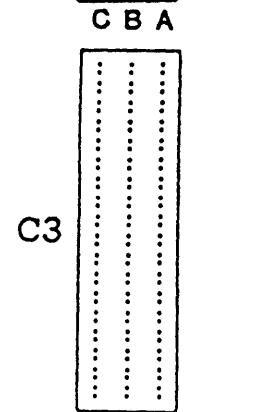
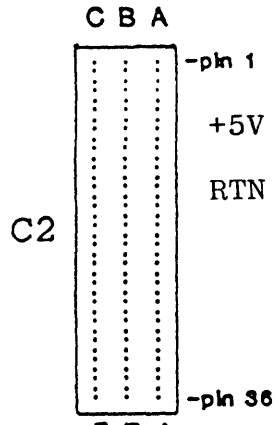
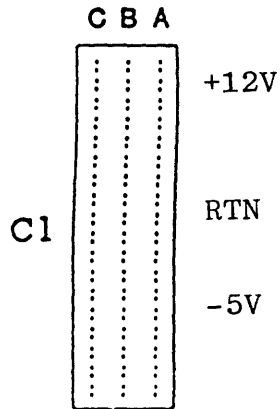

# ARGUMENT ENGINE

C

(backplane side)

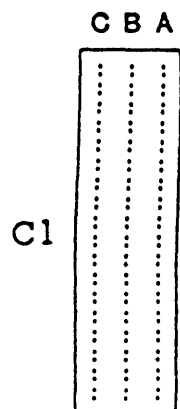

+12V

RTN

-5V

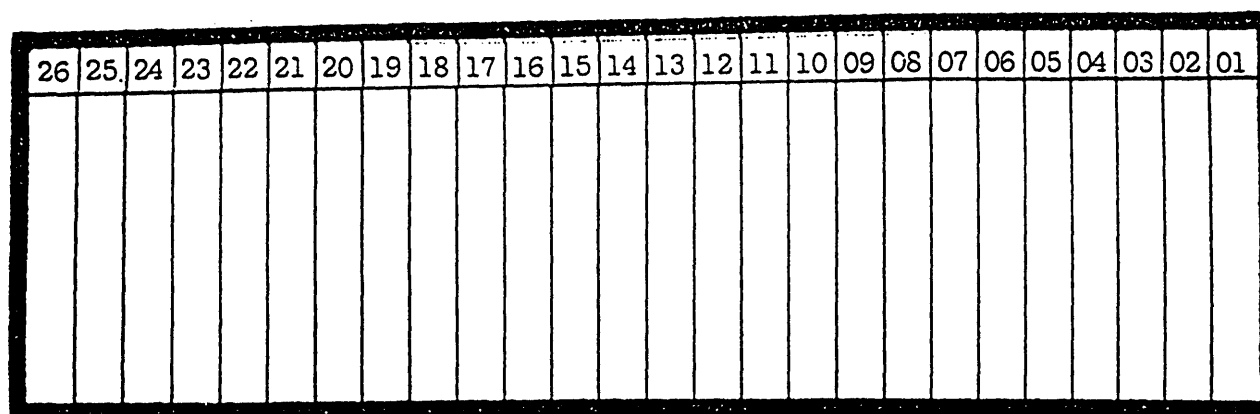

+12V

RTN

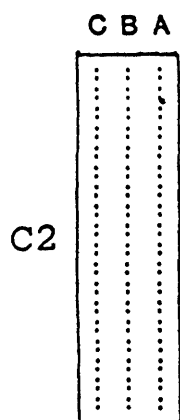

-pin 1

+5V

RTN

-pin 36

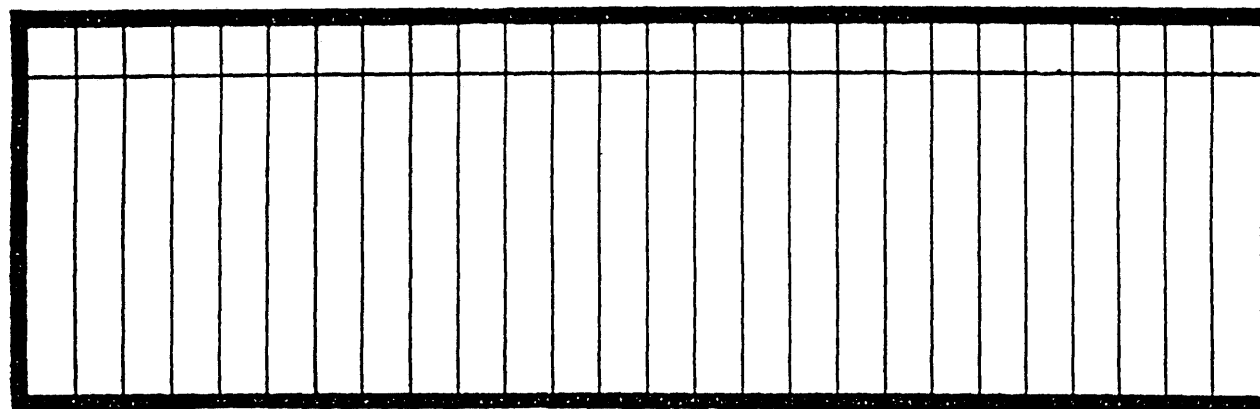

+5

RTN

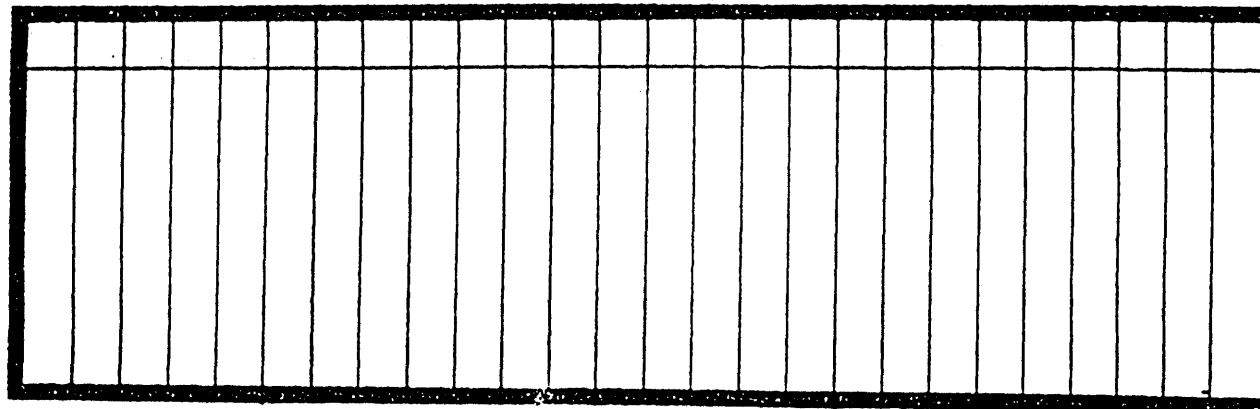
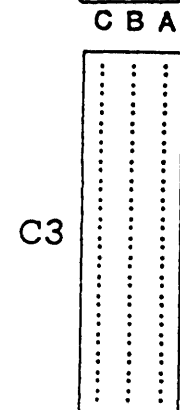

+5

RTN

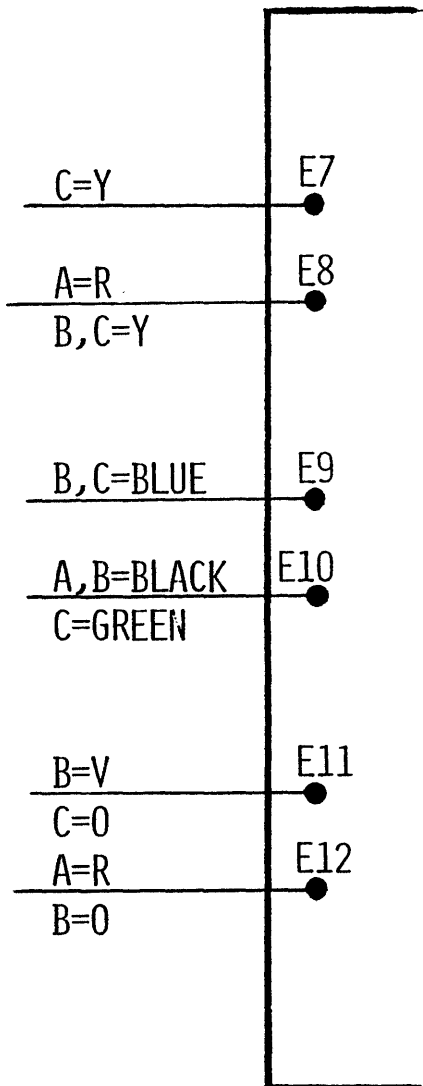

R = +5V  
 BLACK = RTN  
 Y = +12V  
 W = +12V  
 BROWN = -12V  
 BLUE = RTN  
 0 = -5V  
 GREEN = RTN  
 V = -5V

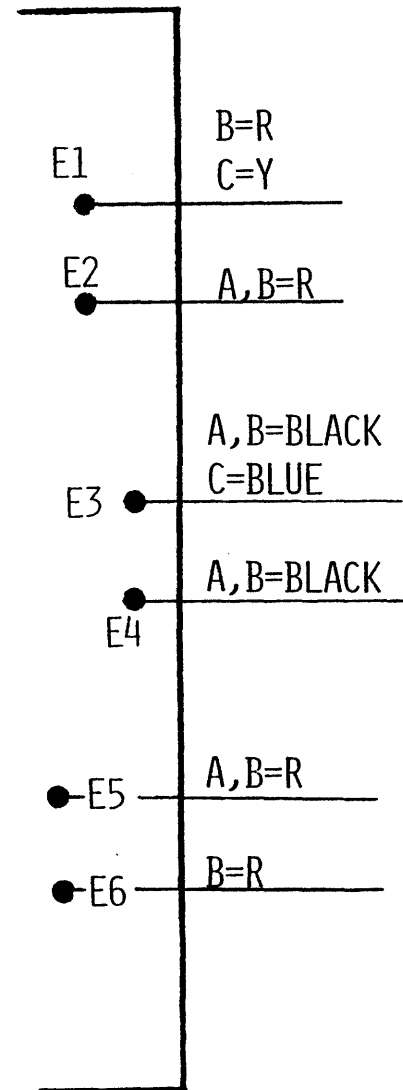

AXXC1  
 BXXC1  
 CXXC1

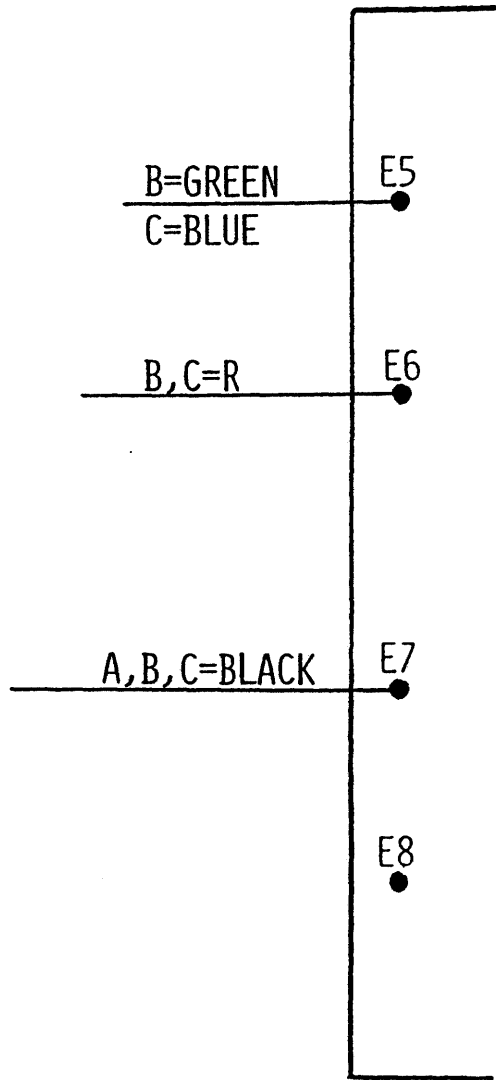

R = +5V  
 BLACK = RTN  
 Y = +12V  
 W = +12V  
 BROWN = -12V  
 BLUE = RTN  
 O = -5V  
 GREEN = RTN  
 V = -5V

AXXC2  
 BXXC2  
 CXXC2

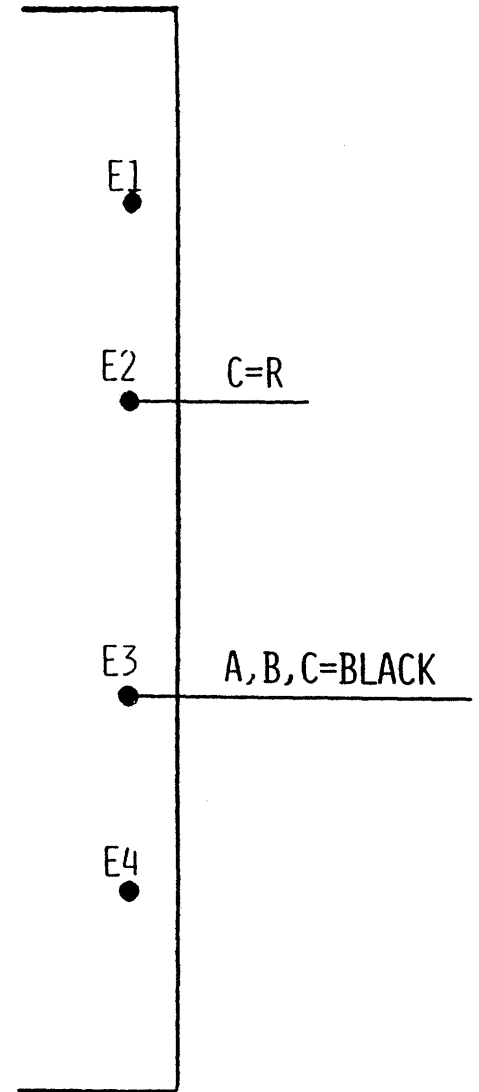

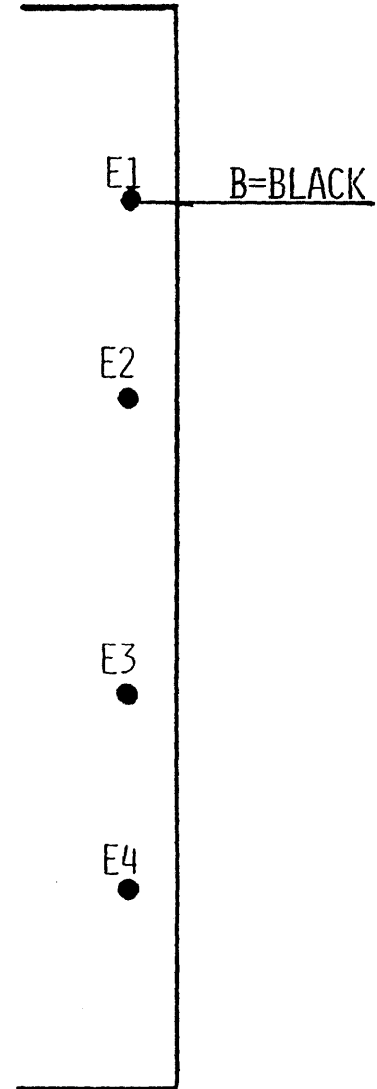
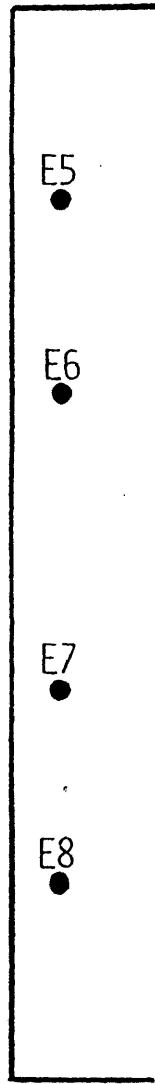

AXXC3  
BXXC3  
CXXC3

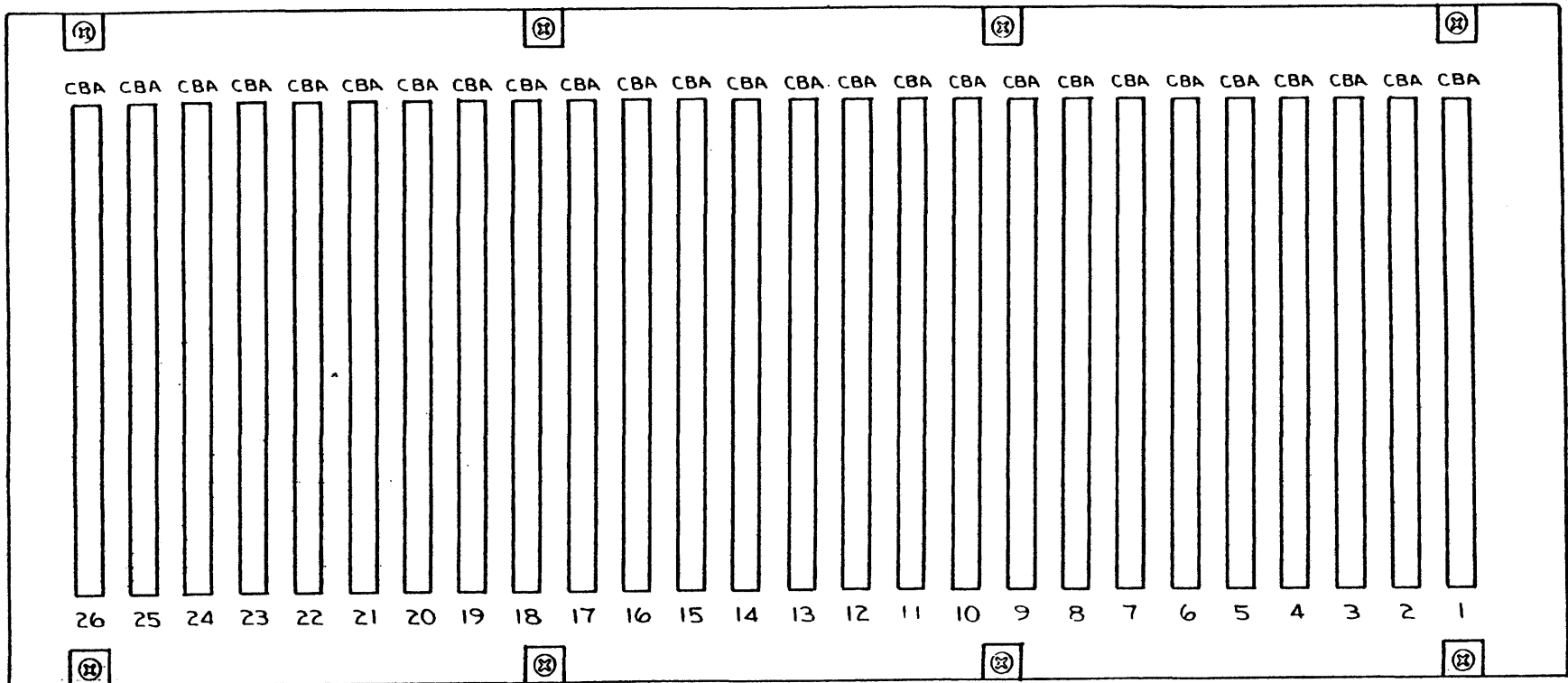

<b>SYSTEM XXVI</b>		
SCALE	APPROVED BY:	DRAWN BY
DATE		REVISED
		DRAWING NUMBER



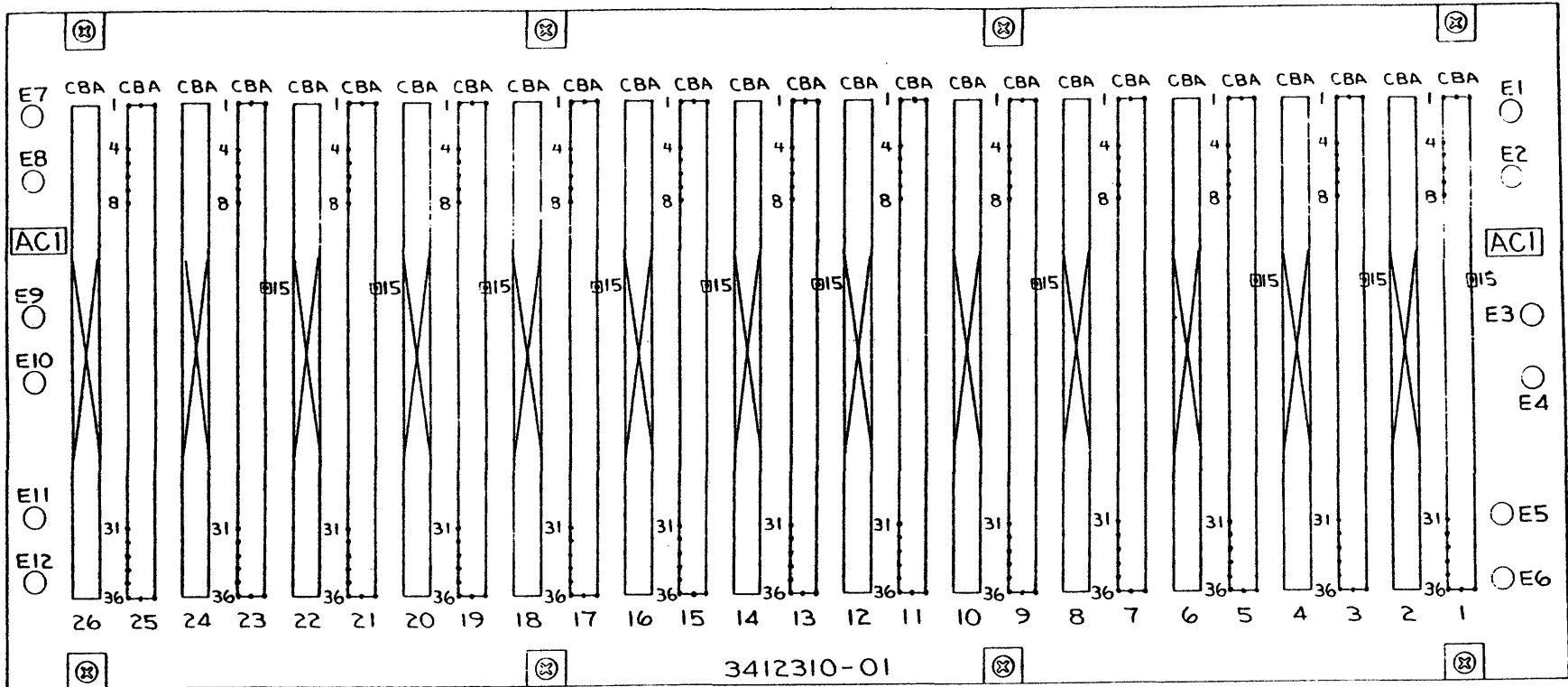

<b>SYSTEM XXVI</b>		
SCALE: NONE	APPROVED BY:	DRAWN BY
DATE:		REVISED
TITLE:		
		DRAWING NUMBER <b>AC1</b>

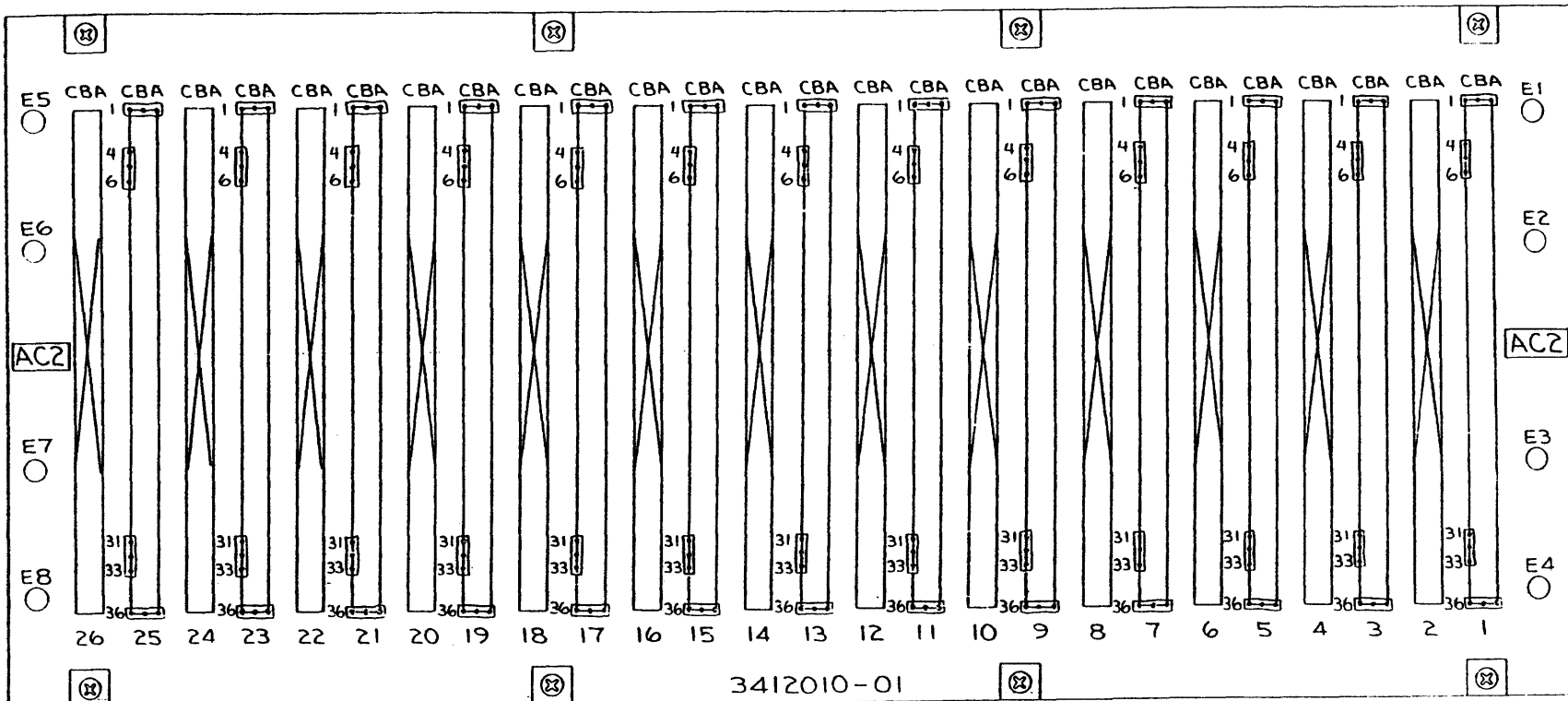

## SYSTEM XXVI

SCALE: NONE	APPROVED BY:	DRAWN BY
DATE:		REVISED
TITLE :		
		DRAWING NUMBER <b>AC2</b>

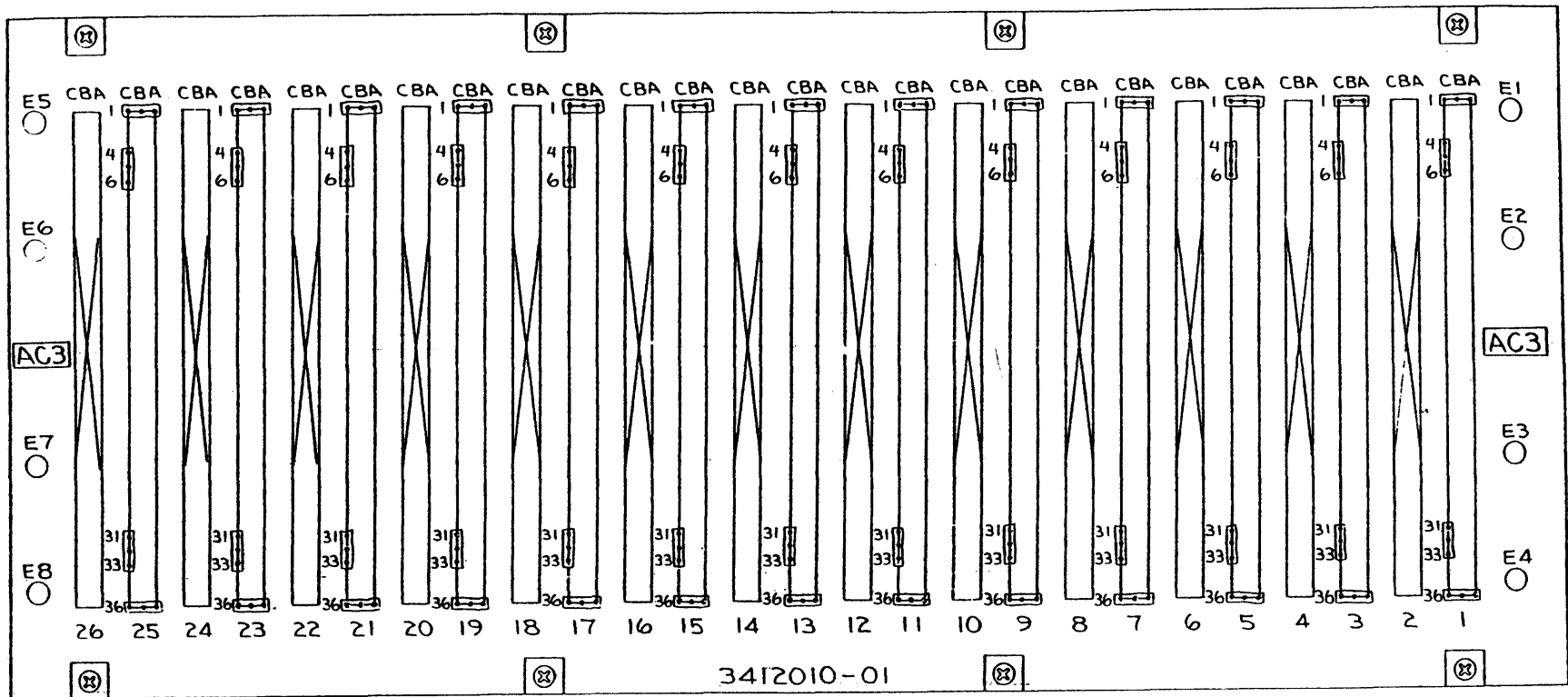

3412010-01

# SYSTEM XXVI

SCALE: NONE	APPROVED BY:	DRAWN BY:
DATE:		REVISED:
TITLE:		
		DRAWING NUMBER <b>AC3</b>

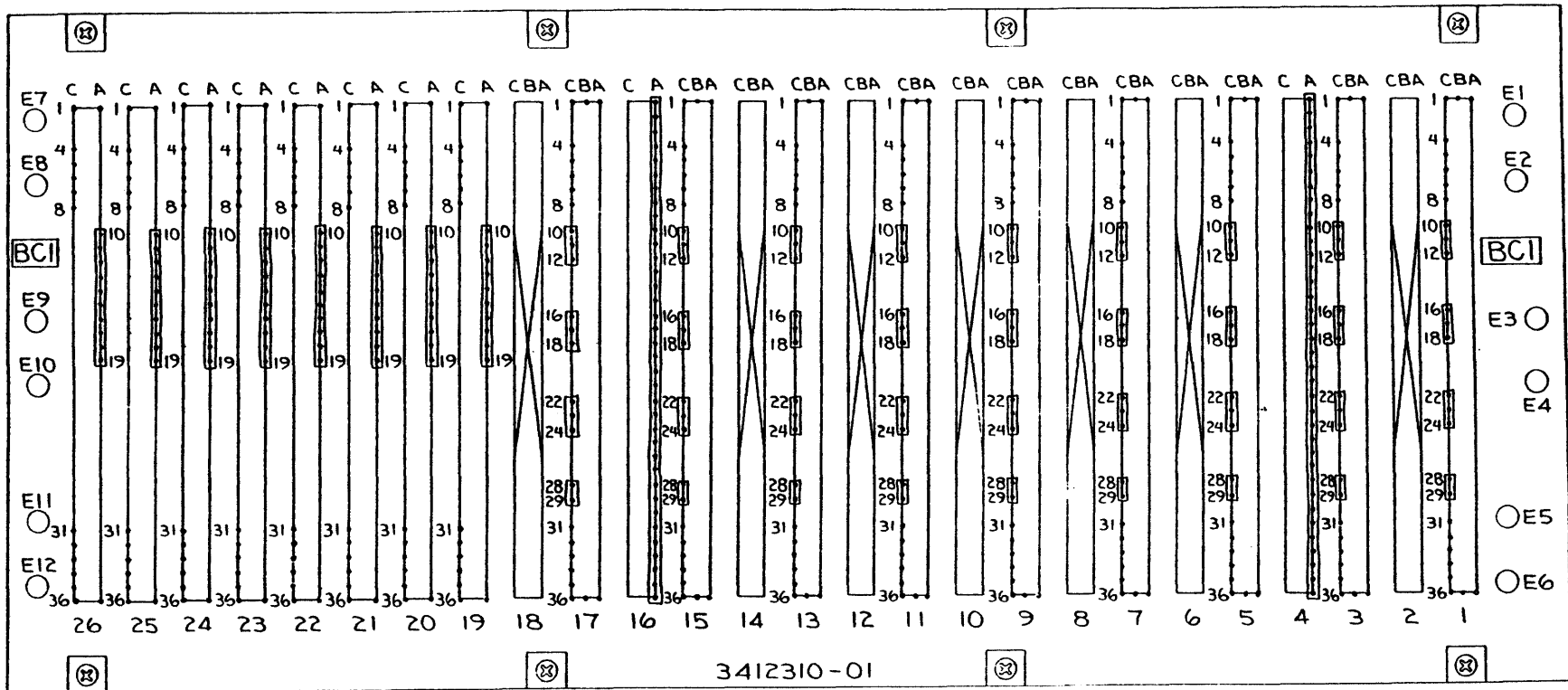

<b>SYSTEM XXVI</b>		
SCALE: NONE	APPROVED BY:	DRAWN BY:
DATE:		REVISED:
TITLE:		
		DRAWING NUMBER <b>BCI</b>

8 PLCS

1

2

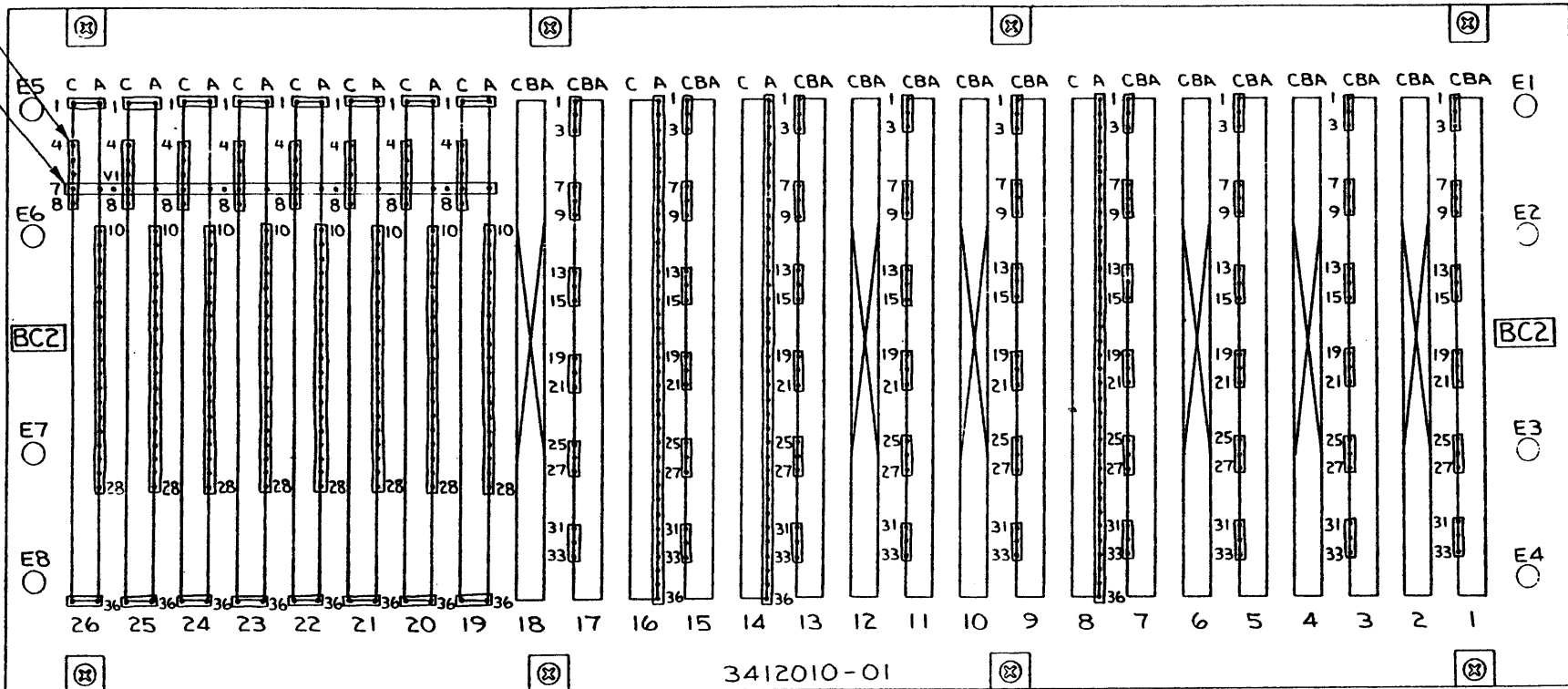

2 LAY BUS STRIP ON TOP OF BUS STRIP MENTIONED IN NOTE 1

1 MOUNT BUS STRIP ON TOP OF 1/8" SPACERS.

NOTES:

## SYSTEM XXVI

SCALE: NONE

APPROVED BY:

DRAWN BY

DATE:

REVISED

TITLE:

DRAWING NUMBER

BC2

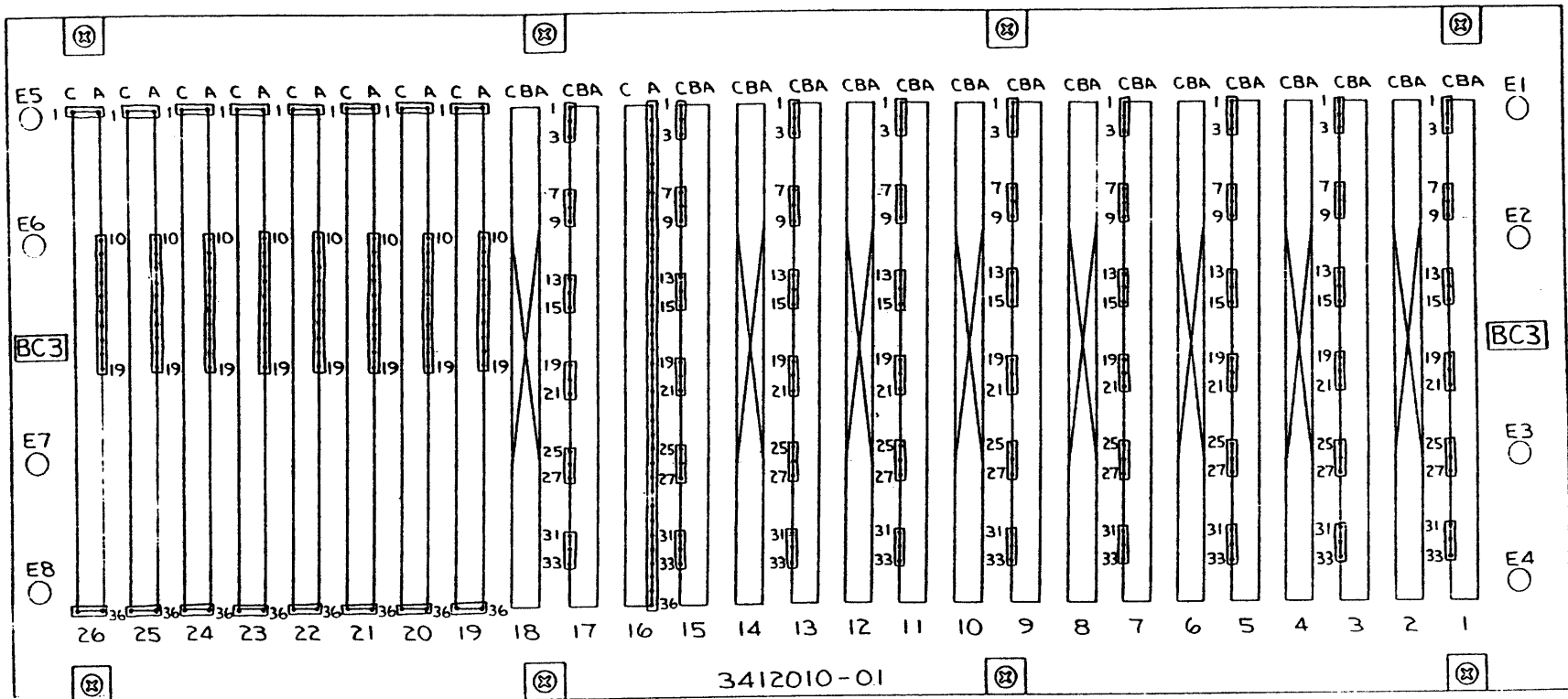

## SYSTEM XXVI

SCALE: NONE	APPROVED BY:	DRAWN BY
DATE:		REVISED
TITLE:		
		DRAWING NUMBER <b>BC3</b>

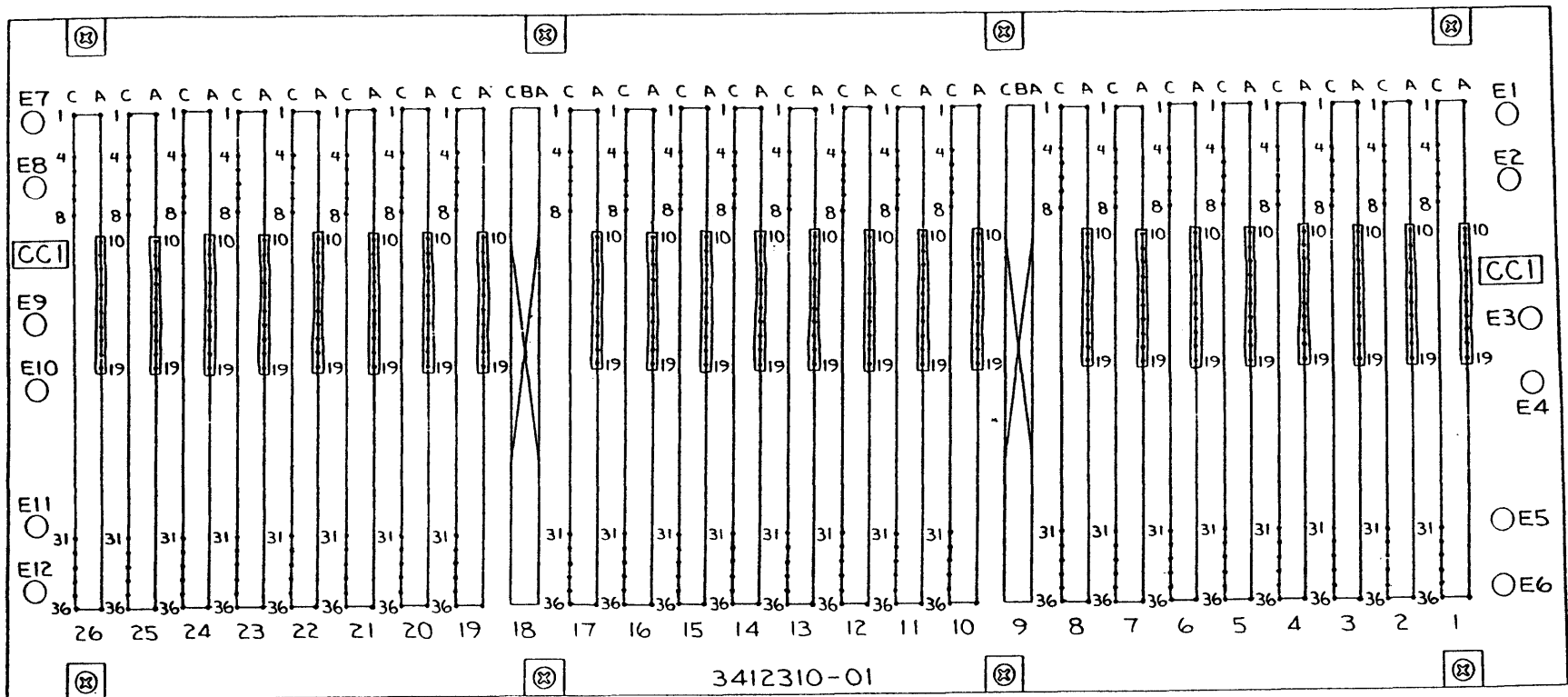

<b>SYSTEM XXVI</b>		
SCALE: NONE	APPROVED BY:	DRAWN BY
DATE:		REVISED
TITLE:		
		DRAWING NUMBER <b>CCA</b>

24 PLCS

3 PLCS

1

2

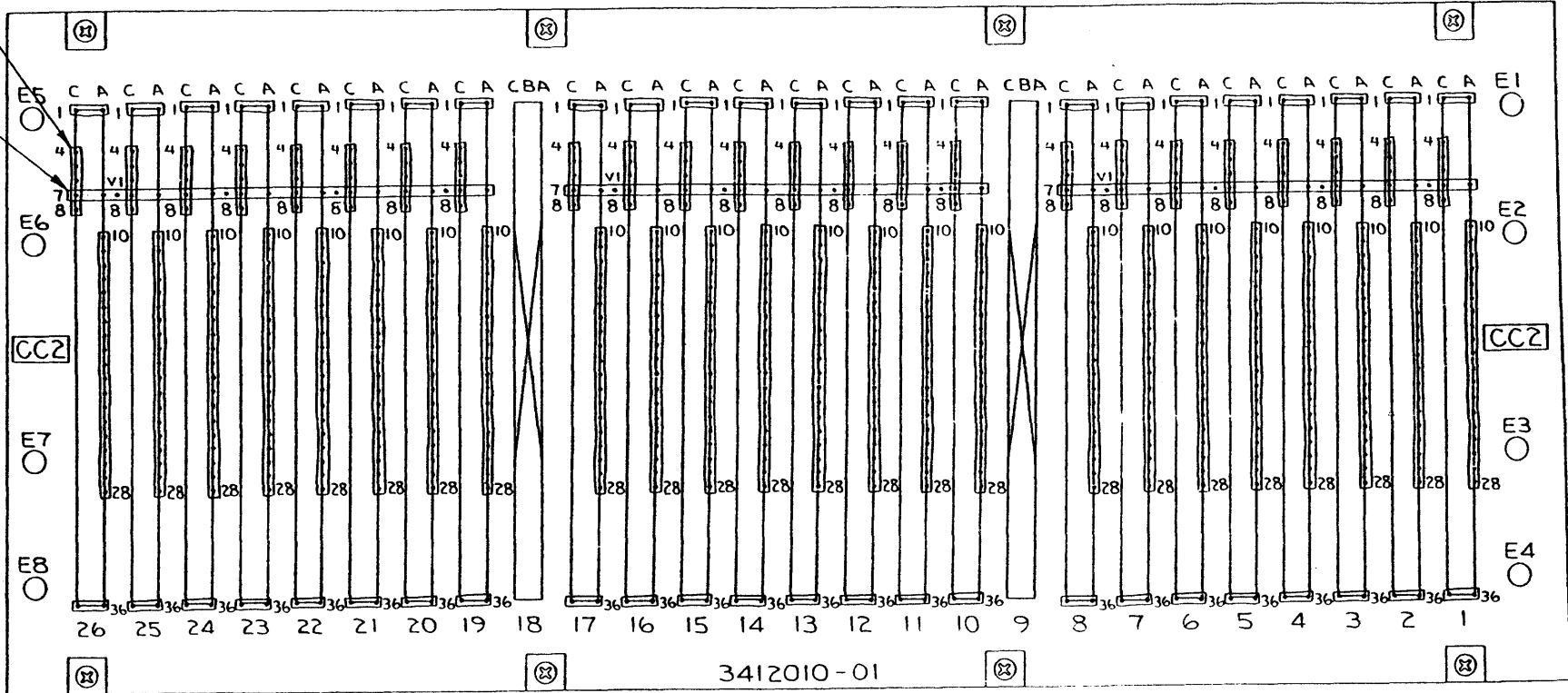

3412010-01

# SYSTEM XXVI

2 LAY BUS STRIP ON TOP OF BUS STRIP MENTIONED IN NOTE 1

1 MOUNT BUS STRIP ON TOP OF 1/8" SPACERS.

NOTES:

SCALE: NONE	APPROVED BY:	DRAWN BY:
DATE:		REVISED:
TITLE:		
		DRAWING NUMBER
		CC2



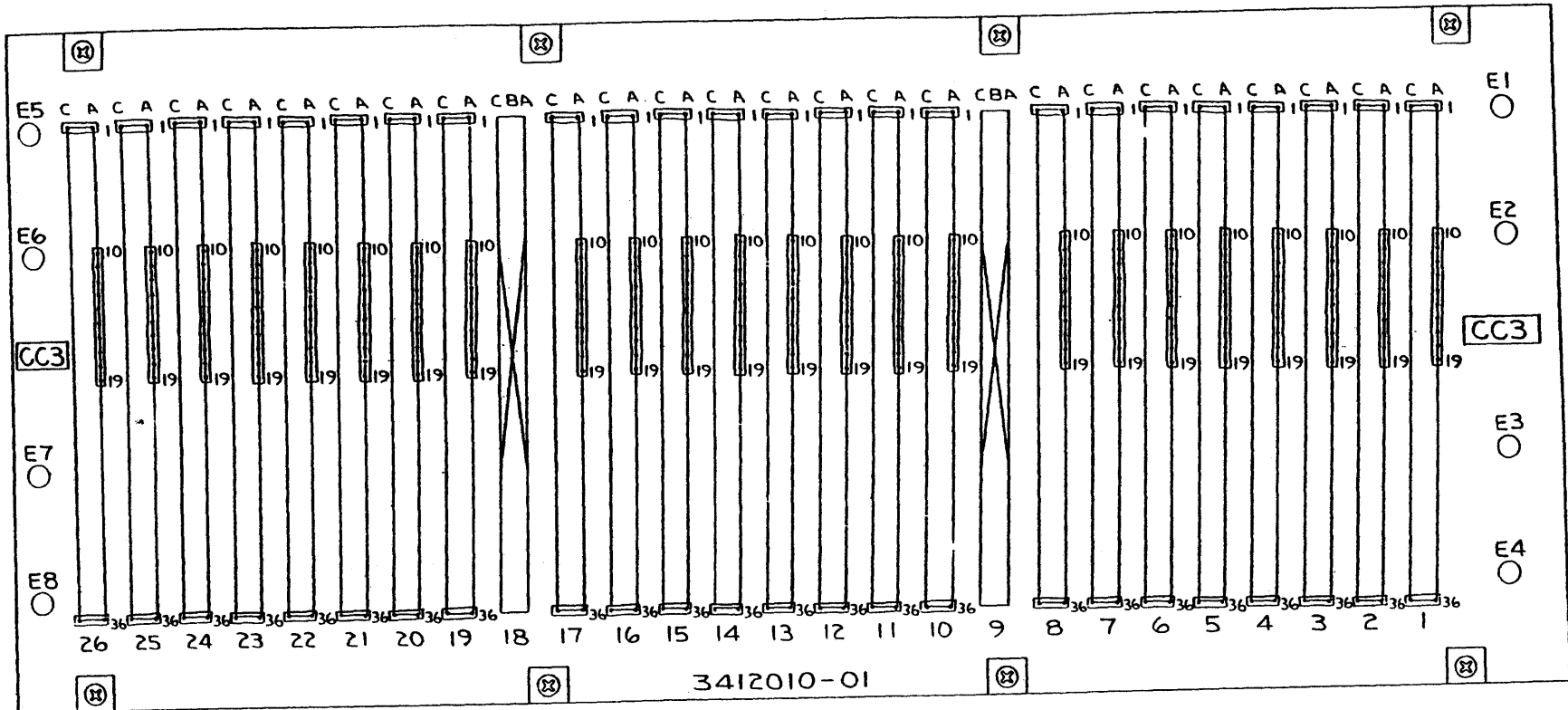

3412010-01

<b>SYSTEM XXVI</b>		
SCALE: NONE	APPROVED BY:	DRAWN BY
DATE:		REVISED
TITLE:		
		DRAWING NUMBER <b>CC3</b>

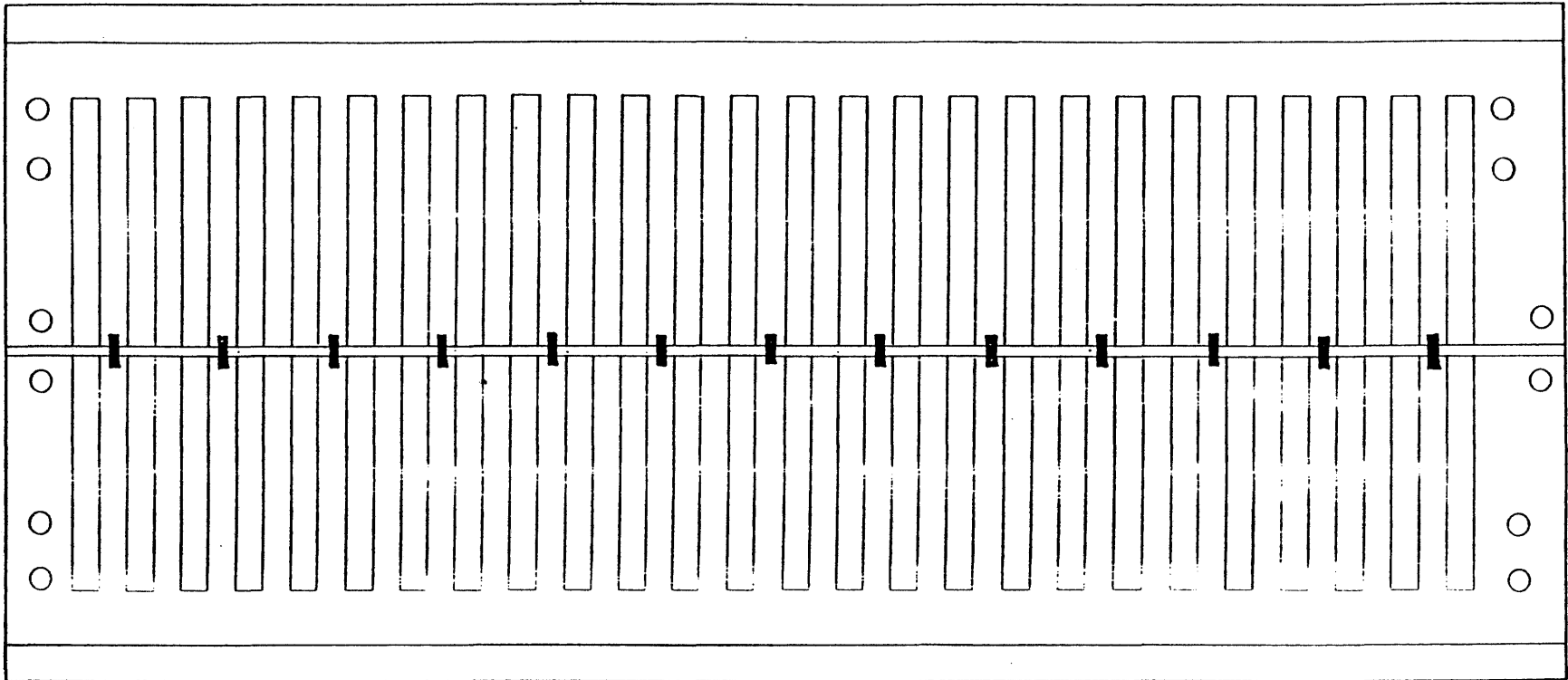

## SYSTEM XXVI

SCALE: <i>NONE</i>	APPROVED BY	DRAWN BY
DATE:		REVISED
TITLE: BACKSIDE OF <span style="border: 1px solid black; padding: 2px;">ACI</span>		
		DRAWING NUMBER

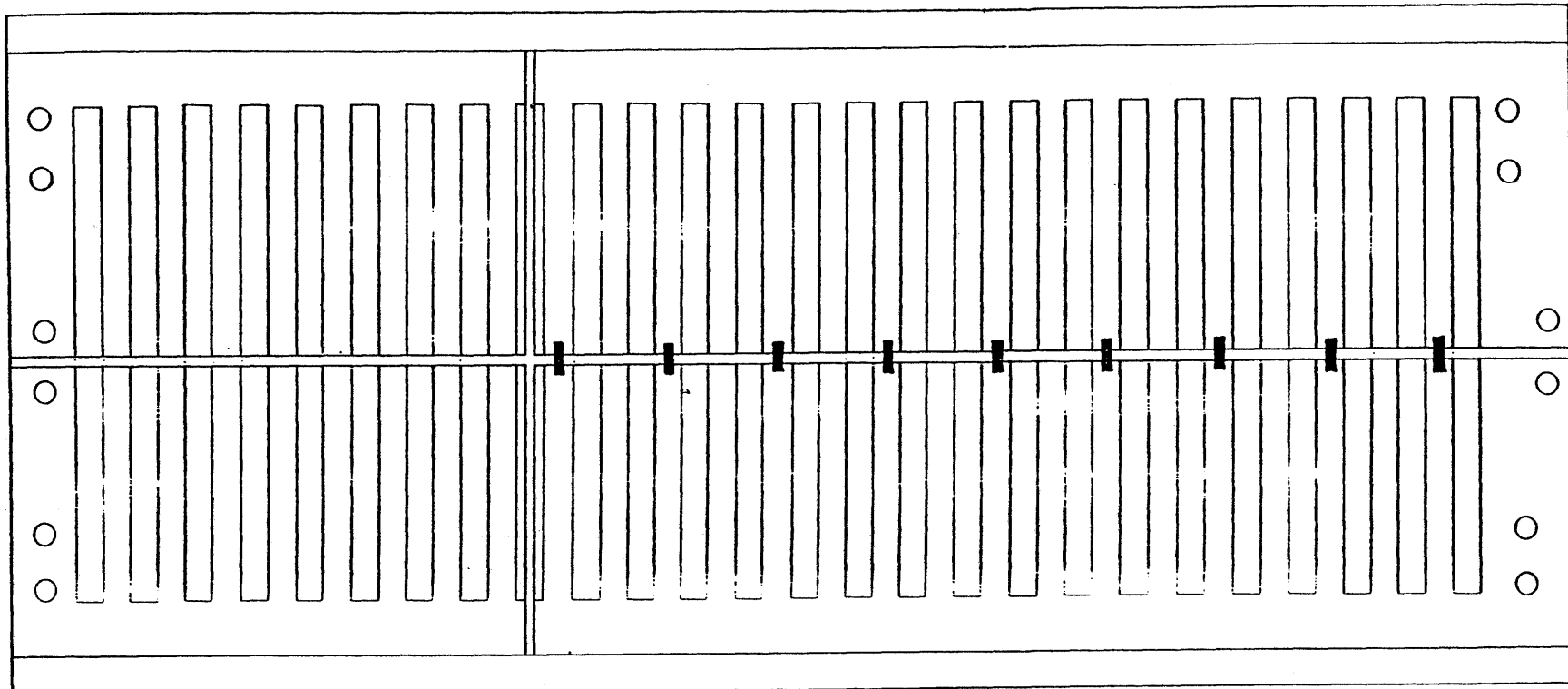

## SYSTEM XXVI

SCALE: <b>NDNE</b>	APPROVED BY:	DRAWN BY:
DATE:		REVISED:
TITLE: BACKSIDE OF <span style="border: 1px solid black; padding: 2px;">BCI</span>		
		DRAWING NUMBER

**ROBERTSON EQUIPMENT**

PRE-SHIPMENT CHECK LIST

PREPARATION DATE \_\_\_\_\_

SYSTEM S/N \_\_\_\_\_ SCHEDULED DELIVERY DATE \_\_\_/\_\_\_/\_\_\_ SHIP DATE \_\_\_/\_\_\_/\_\_\_

DESTINATION: CUSTOMER \_\_\_\_\_  
 ADDRESS \_\_\_\_\_

PERIPHERAL CABINET EQUIPMENT LIST	QTY	SERIAL NO	INSTALLED DATE	OPERATION CHECK DATE	INITIAL
DISK DRIVES					
AMPEX					
Capricorn 330	1				
	1				
	1				
Rack Mount Slides	pr				
KENNEDY TAPE SYSTEM					
9100 Tape Drive	1				
Rack mt. Slides	lpr				
Slide Extension	lpr				
9219 Formatter	1				
MICRONODE					
DIGITAL LSI 11/23					
BALLN MTG BOX	1				
MTG BRKTS	lpr				
KDF*11/M8186					
CPU	1				
DRV11/M7941					
PARA LN INT	1				
DUV11/M7951					
SYNC SER INT	1				
BDV11/M8012					
R/S LOADER	1				
DLV11*J/M8043					
4 ASYNC INT	1				
MSV11*D/M8044					
MOS MEMORY	2				
26 PWR DIST UNIT	1				
FORMATTING LSI	1				

## PRE-SHIPMENT CHECK LIST

SYSTEM NO. \_\_\_\_\_ SCHEDULED DELIVERY DATE \_\_\_/\_\_\_/\_\_\_ SHIP DATE \_\_\_/\_\_\_/\_\_\_

SYSTEM CABLE LISTING	QTY	INSTALL DATE	SOURCE PART NUMBER	INITIAL
Disk Drive Mod. 'A' Cable 10'	1sys		CETEC P/N IDC-3-96-3120 T/S P/N 97300-10	
Std 'A' Cable 6'	1 ea 2,3		CETEC P/N IDC-2-96-3727 T/S P/N 97310-06	
Std 'B' Cable 10'	1 ea drive		CETEC P/N IDC-2-96-3725 T/S P/N 97320-10	
Tape System Special I/O to Formatter 4-in-1	1sys		FOONLY P/N CETEC P/N IDC- T/S P/N 97330-XX	
Formatter to Tape Transport Asy	2			
KENDY Interface asy	1		KENDY P/N 190-4970-104	
Interface PC Board 2 50-PIN Data Cables 3'	1		KENDY P/N 190-4596-001 KENDY P/N 190-4999-104 CETEC P/N IDC- T/S P/N 97340-03	
MICRONODE PDP-11/23 Mod CPU to DRV-11 Para. Interface 10'	2		DEC P/N BC04Z-10 * CETEC P/N IDC-3-96-3122 T/S/ P/N 97350-10	
DLV11 ASYNC INT 25'	1-4		DEC P/N BC21B-05 INMAC 211-1E T/S 97350-25	
DUV11 SINGLE LINE COMM. INTERFACE 25'	1		DEC P/N BC05C-25 T/S P/N 97370-25	
CPU EXTERNAL CABLES CC TO VDT 26 PIN IDS CONN. TO 25 PIN IDD SOCKET CONN.	0-5		CETEC P/N T/S P/N 97380-25	
CC TO VDT 26 PIN IDS CONN. TO 25 PIN IDD PIN CONN.	0-5		CETEC P/N T/S/ P/N 97390-25	
CC TO TTY JUMPER 26 PIN IDS CONN TO 26 PIN IDS CONN	1		CETEC P/N T/S P/N 97395-02	

## AUGMENT ENGINE

## PRE-SHIPMENT DOCUMENTATION CHECK LIST

SYSTEM NO. \_\_\_\_\_ SCHEDULED DELIVERY DATE \_\_\_/\_\_\_/\_\_\_ SHIP DATE \_\_\_/\_\_\_/\_\_\_

EQUIPMENT LIST	QTY	P/N	DOCUMENT TITLE	REV	DATE
PERIPHERALS					
Capricorn 330 Disk Drive	1	3314369+01	Disk Storage Drive Op & Maint. Manual	D	5-82
KENNEDY 9100 TAPE DRIVE	1	192-9100- 003	MODEL 9100 OPER. & MAINT. MANUAL		
KENNEDY 9219 FORMATTER	1	192-9219- 277	MODEL 9219 OPER. & MAINT. MANUAL		
LSI 11/23	1	EK-FS003- 1N*002	PDP-11 FAMILY FIELD INSTALL & HDW ACPT REF. MANUAL	2	1978
	1	MP00740	PDP11/23 FLD MAINT PRINT SET	B	10-81
	1	EB-18451- 20/80 120 04 75	MICROCOMPUTERS & MEMORIES	→	1981
	1	EB-20175- 20/81 10A 04 30.0	MICROCOMPUTER INTERFACES HANDBK	→	1980
	1	EH 07043 53/79 05B 03 03	LSI-11, PDP-11/03 REFERENCE CARD		10-76

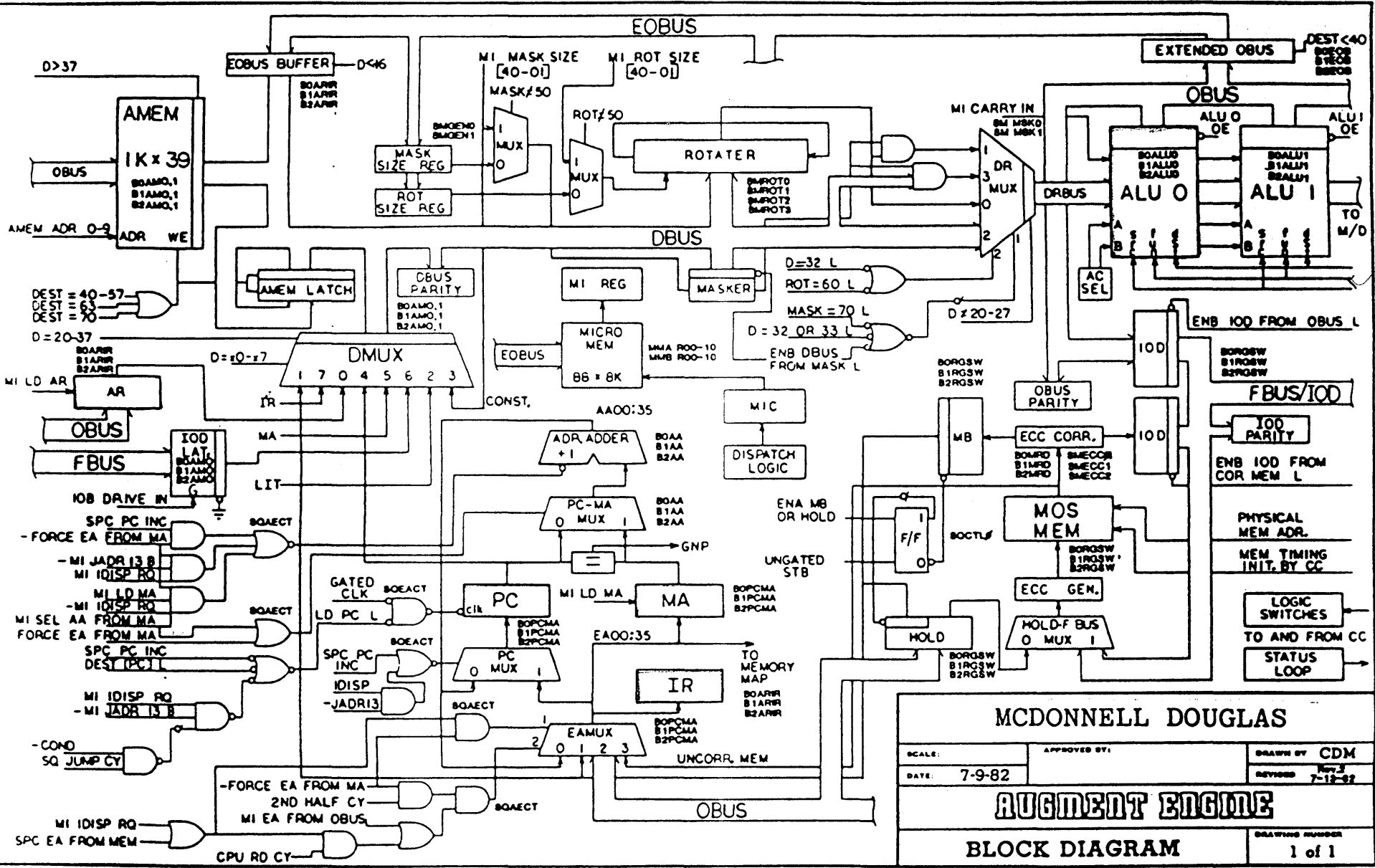

**MCDONNELL DOUGLAS**

SCALE:	APPROVED BY:	DRAWN BY CDM
DATE: 7-9-82		REVISED 7-12-82

AUGMENT ENGINE

BLOCK DIAGRAM

DRAWING NUMBER  
1 of 1