

STERRY PHILLIPS

TEXAS INSTRUMENTS

Improving Man's Effectiveness Through Electronics

Model 770 Intelligent Data Terminal Upgrade Instructions to DS990 System Model 1

FD-1000
DRIVE

MANUAL NO. 2262326-9701
ORIGINAL ISSUE 15 FEBRUARY 1979

Digital Systems Division



© Texas Instruments Incorporated 1977, 1979

All Rights Reserved, Printed in U.S.A.

The information and/or drawings set forth in this document and all rights in and to inventions disclosed herein and patents which might be granted thereon disclosing or employing the materials, methods, techniques or apparatus described herein, are the exclusive property of Texas Instruments Incorporated.

MANUAL REVISION HISTORY

Model 770 Intelligent Data Terminal Upgrade Instructions
to DS990 System Model 1 (2262326-9701)

Original Issue 15 February 1979

TABLE OF CONTENTS

<u>Paragraph</u>	<u>Title</u>	<u>Page</u>
1.1	General	1
1.2	Model 770 Disassembly	2
1.3	DS990/1 Assembly	13
1.4	DS990/1 Checkout	28
1.5	Upgrade Parts List	28

LIST OF ILLUSTRATIONS

<u>Figure</u>	<u>Title</u>	<u>Page</u>
1-1	DS990 Model 1 Intelligent Terminal System	iv
1-2	Rear View of Model 770 Intelligent Data Terminal	4
1-3	Terminal Cover Assembly Release	5
1-4	Circuit Board Locations in Model 770 Intelligent Data Terminal	7
1-5	Tape Transport Mounting Screw Removal on Model 770 Intelligent Data Terminal	8
1-6	Tape Transport Removal in Model 770 Intelligent Data Terminal	10
1-7	Transport Mounting Bracket Removal in Model 770 Intelligent Data Terminal	12
1-8	Keyboard Layout of the Model 770 Intelligent Data Terminal	14
1-9	DS990/1 Terminal Assembly with Cover Assembly Open	15
1-10	Internal View of DS990/1 Terminal Assembly	16
1-11	DS990/1 Terminal Assembly Keyboard	20
1-12	Rear View of DS990/1 System	22
1-13	Typical Terminal Configuration Chart Showing DS990/1 Upgrade	22
1-14	Typical Floor Plan Layout of the DS990/1 System with One FD1000 Assembly	24
1-15	Typical Floor Plan Layout of the DS990/1 System with Two FD1000 Assemblies	25
1-16	Typical Connection Diagram for the DS990/1 System with One FD1000 Assembly	26
1-17	Typical Connection Diagram for the DS990/1 System with Two FD1000 Assemblies	27

LIST OF TABLES

<u>Table</u>	<u>Title</u>	<u>Page</u>
1-1	Parts List Required to Upgrade Model 770 to DS990/1 System	28

TABLE OF CONTENTS (Continued)

APPENDIXES

<u>Appendix</u>	<u>Title</u>	<u>Page</u>
A	Option List for Shugart SA850 Drives	32
B	Option List for Qume DT/8 Drives	34
C	Configuration Comparison Chart	35

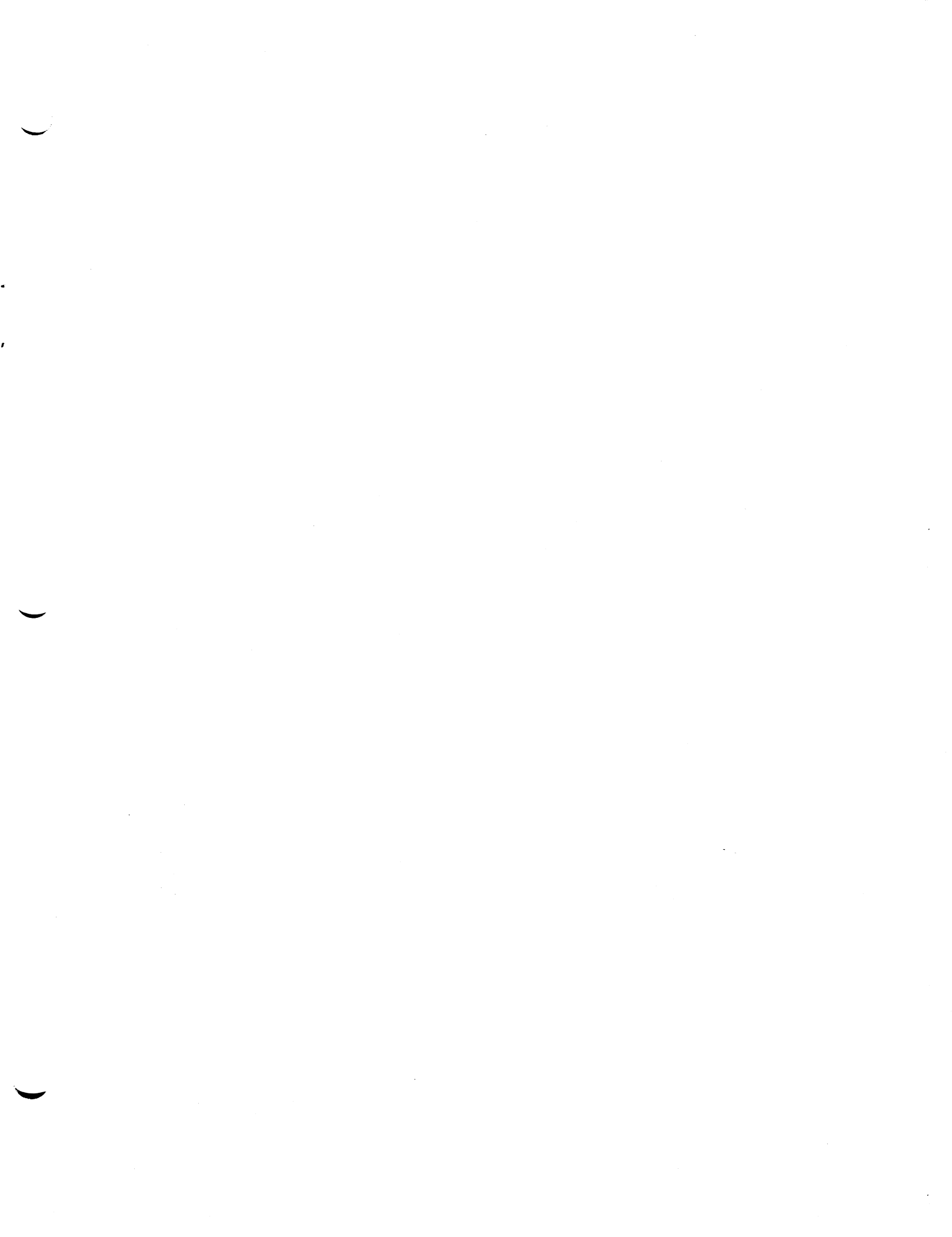

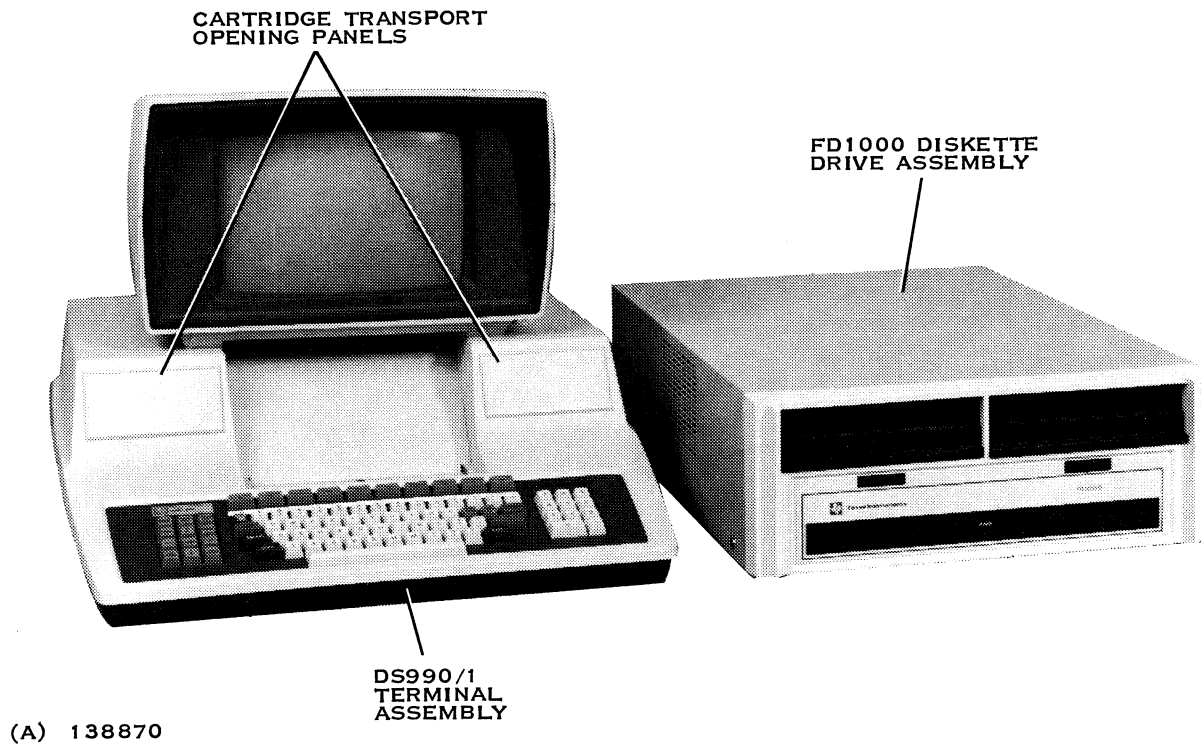

Figure 1-1. DS990 System, Model 1

MODEL 770 INTELLIGENT DATA TERMINAL
UPGRADE INSTRUCTIONS TO
DS990 SYSTEM MODEL 1

1.1 GENERAL

This manual contains instructions to upgrade a Model 770 Intelligent Data Terminal to a DS990 System Model 1 (DS990/1) (see figure 1-1). These instructions are presented under the following headings:

- Model 770 disassembly
- DS990/1 assembly
- DS990/1 checkout
- Upgrade parts list

From a hardware standpoint, the upgrade consists primarily of increasing the memory and mass-storage capacity of the terminal. This is done by replacing the two existing cartridge drives with one or two FD1000 diskette drive assemblies and replacing the existing memory system with the DS990/1 memory system. A summary of the major component changes is as follows:

<u>Model 770 Disassembly</u>	<u>DS990/1 Assembly</u>
Remove cartridge control board	Add LO 32K-byte RAM board and the HI 32K-byte RAM board or add the 64K-byte RAM board
Remove both cartridge transports	
Remove main memory board	Add diskette-drive I/O processor board

Model 770 Disassembly (Continued)

Remove optional expansion
memory board(s)

DS990/1 Assembly (Continued)

Add diskette-drive interface
board

Add one or two FD1000
tabletop diskette
drive assemblies

Complete step-by-step procedures for making the Model 770 to DS990/1 upgrade are included in the following paragraphs. Before proceeding, verify that the parts identified in the parts list, table 1-1, at the end of this manual are on hand.

NOTE

Before making the 770 to DS990/1 upgrade, keep in mind that the cartridge software used on the 770 is not interchangeable with the DS990/1 software.

1.2 MODEL 770 DISASSEMBLY

Perform the following procedure to disassemble the Model 770 terminal for conversion to the DS990/1 terminal:

WARNING

Dangerous ac voltages exist within the terminal when ac power is applied. Do not open the terminal cover assembly without first removing the ac power from the terminal.

1. Set the power switch on the rear of the terminal to OFF (see figure 1-2).
2. Disconnect the ac power cord at the wall plug.
3. Open the terminal cover assembly by performing the following steps (see figure 1-3):
 - a. On terminals with an internal printer, slide the paper-loading access door up to the open position.
 - b. Insert a flat-bladed screwdriver into the cover latch opening slot on one side of the terminal until it makes contact with the cover latch spring.

CAUTION

Do not apply excessive pressure to the screwdriver as the cover latch spring may be damaged.

- c. Gently apply horizontal pressure to the screwdriver until the side of the cover is released from the cover latch spring.
- d. Lift the released side of the cover and insert a small screwdriver between the cover and the base to keep the cover latch released.
- e. Repeat steps b, c, and d to release the cover latch on the opposite side of the terminal.

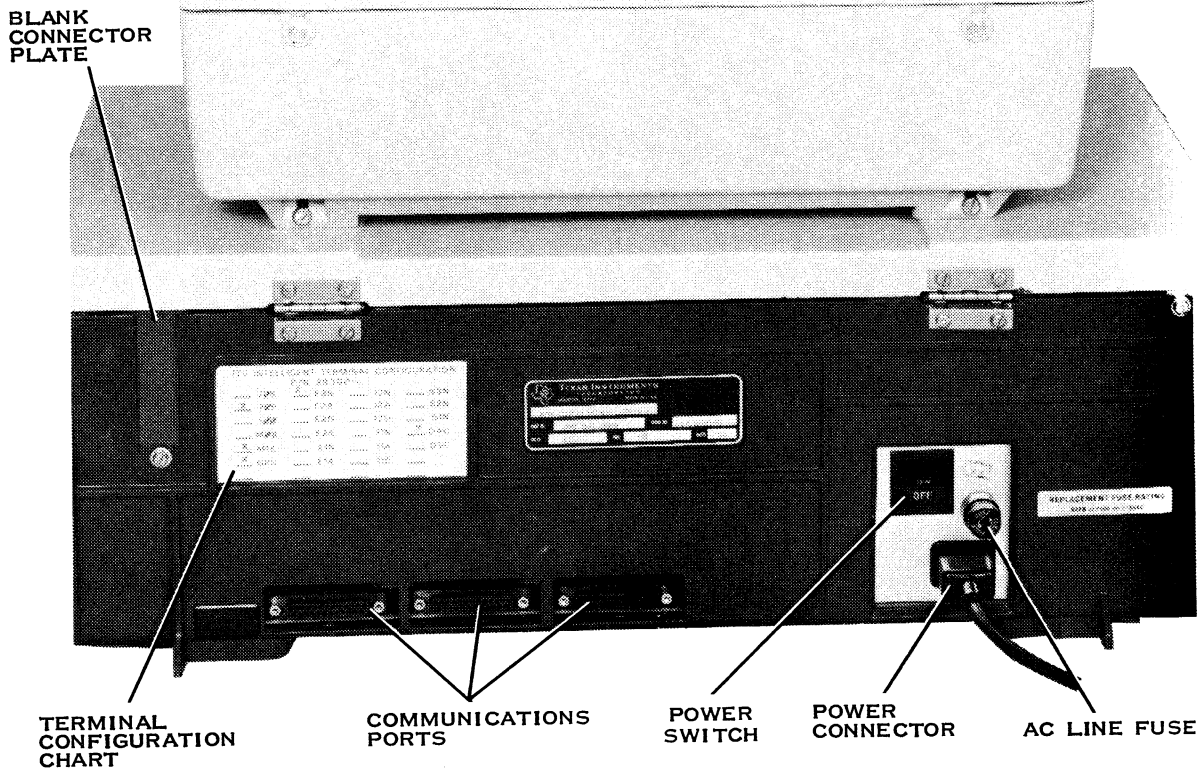

- POWER SWITCH TURNS TERMINAL ON AND OFF
- AC LINE FUSE PROTECTS TERMINAL FROM DAMAGE CAUSED BY DRAWING EXCESSIVE CURRENT
- COMMUNICATIONS PORTS TERMINAL CONNECTION POINT FOR PERIPHERAL DEVICES
- POWER CONNECTOR CONNECTION POINT FOR POWER CORD

(A) 138871

Figure 1-2. Rear View of Model 770 Intelligent Data Terminal

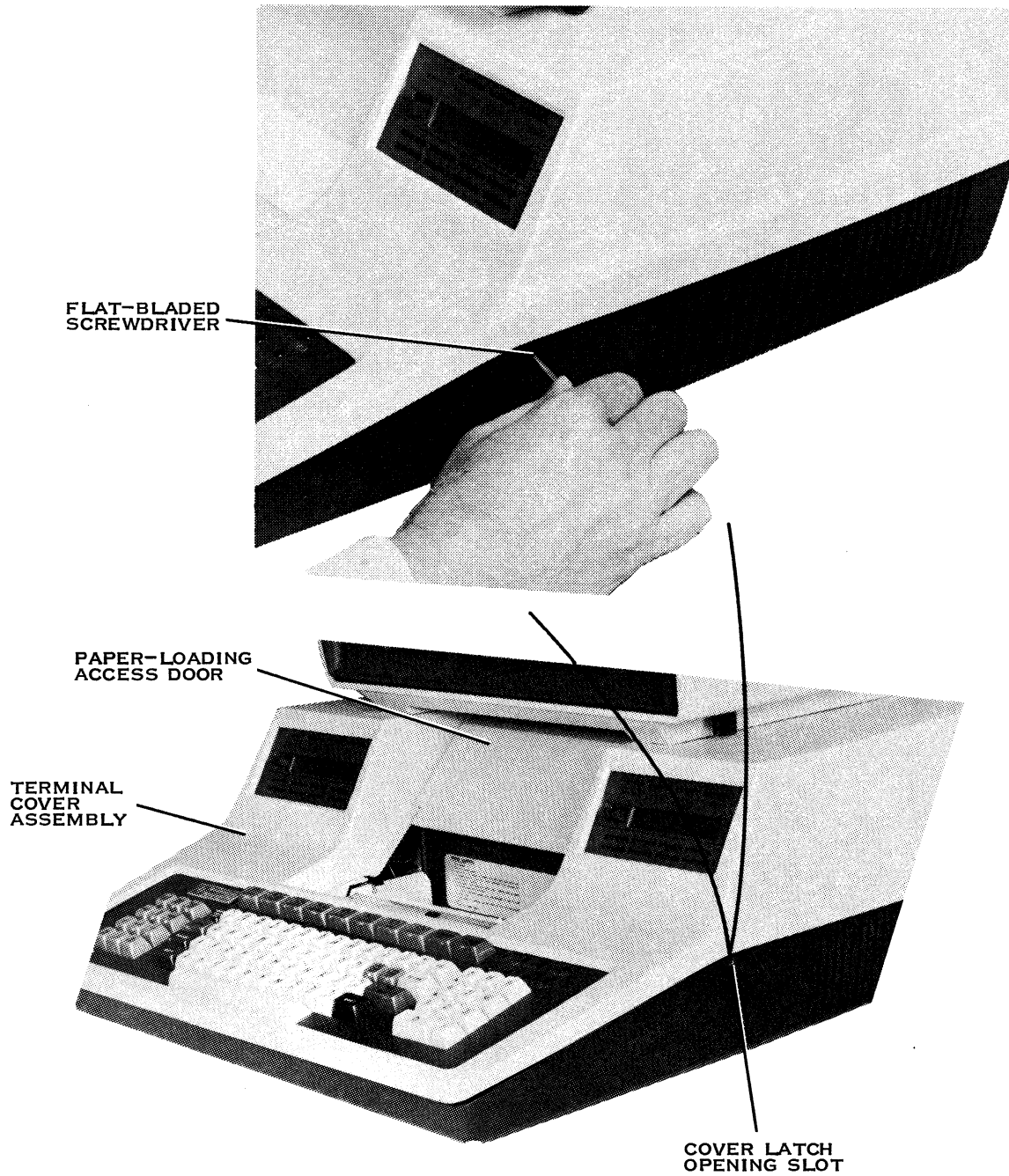

(A)

Figure 1-3. Terminal Cover Assembly Release

CAUTION

When opening the terminal cover assembly, ensure that it is in its full open position so that it will not drop closed.

- f. Lift the terminal cover assembly to its full open position (see figure 1-4).
4. Disconnect connectors P17 and P18 from cartridge control board in slot A3 at the orange mark (see figure 1-4).

NOTE

To remove any circuit board, first pull up on the circuit board ejector, and then lift the circuit board from its motherboard connector.

5. Remove cartridge control board, part number 0993070-0001, from slot A3 at the orange mark (see figure 1-4).
6. Remove the four transport mounting screws (two per cartridge transport assembly) that secure the cartridge transport assemblies to their mounting brackets, using a 1/4-inch hex head nut driver (see figure 1-5).

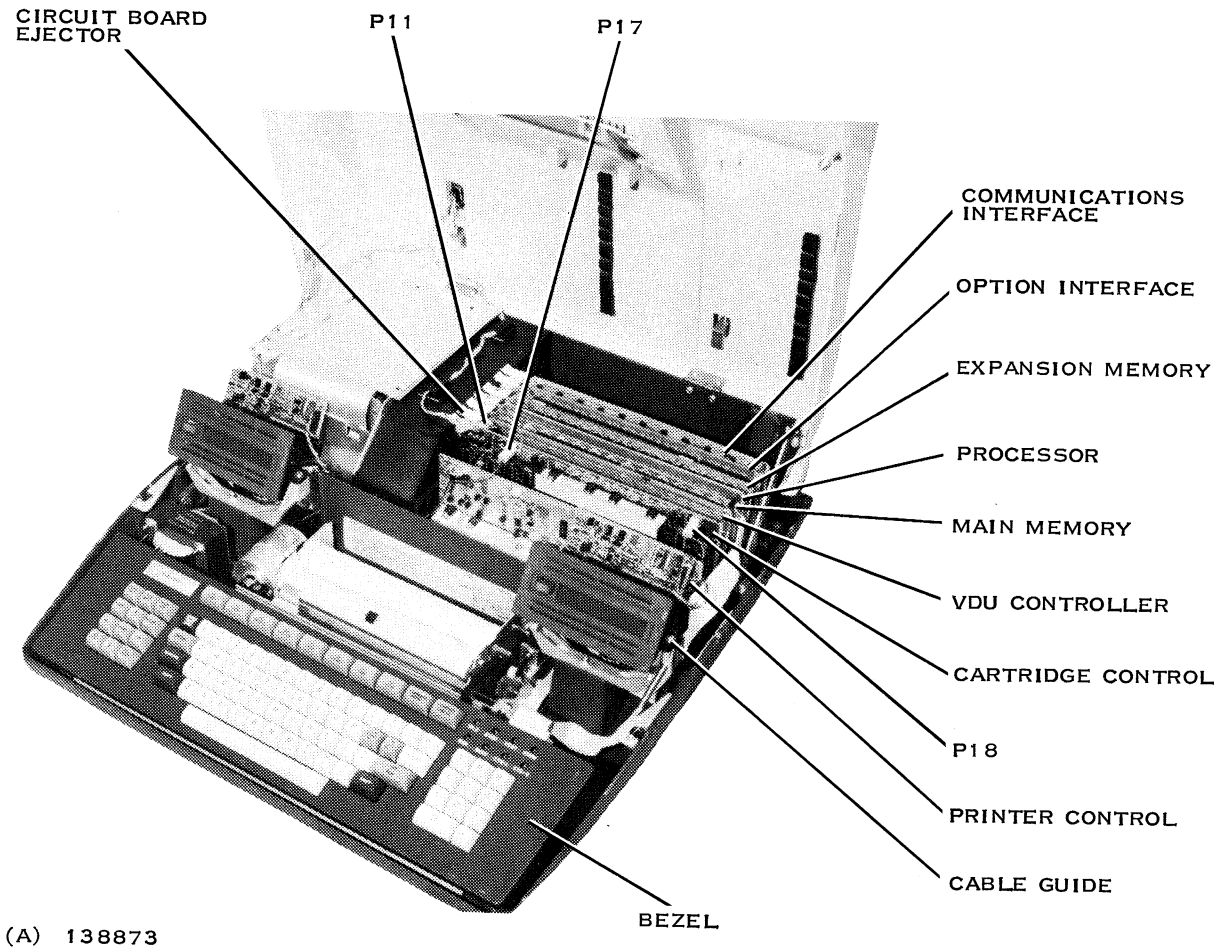

Figure 1-4. Circuit Board Locations in Model 770 Intelligent Data Terminal



Figure 1-5. Tape Transport Mounting Screw Removal on Model 771 Intelligent Terminal System

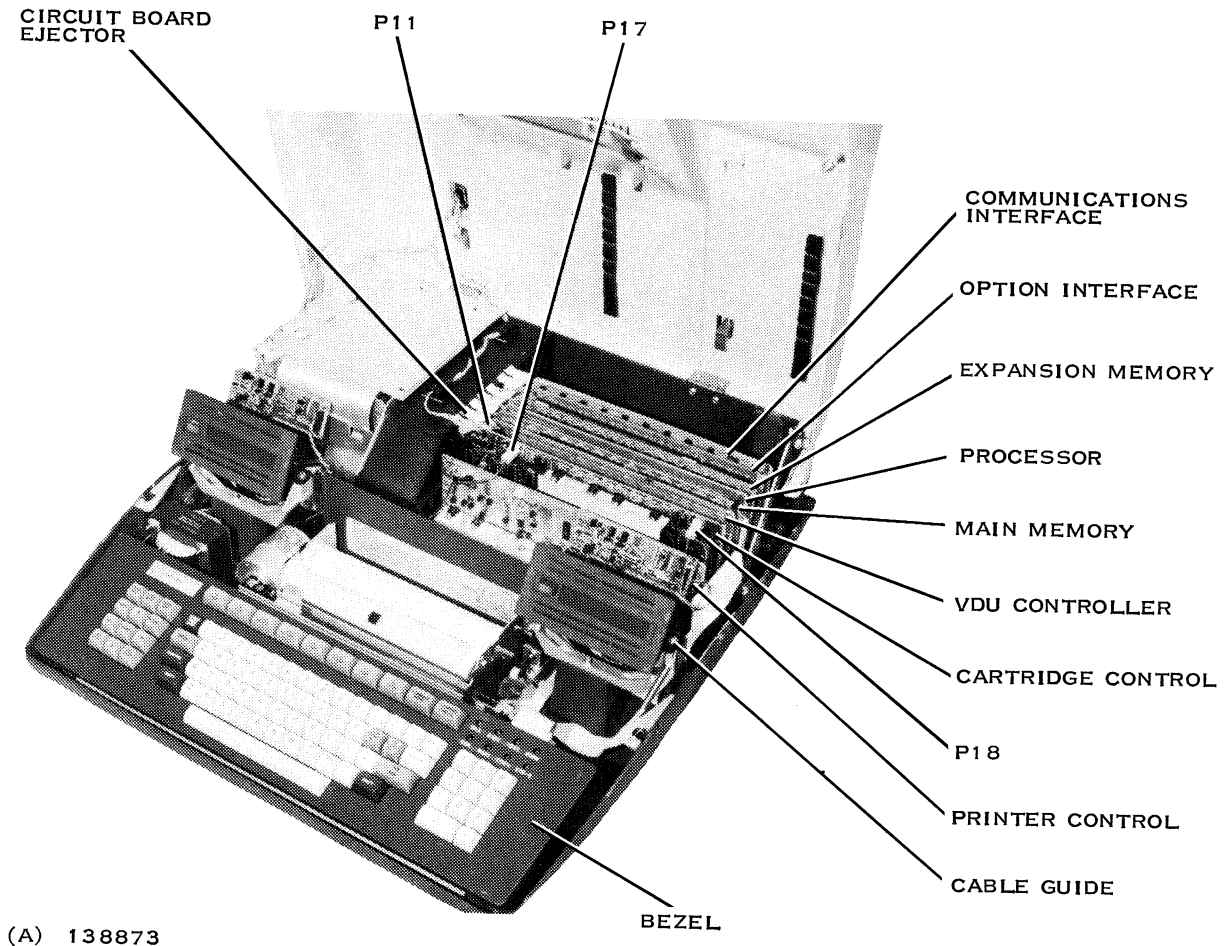

Figure 1-4. Circuit Board Locations in Model 770 Intelligent Data Terminal

7. Remove optional printer control board, part number 0993038-0001, from slot A1 in front of the red mark (see figure 1-4), if so equipped. This board will be reinserted during DS990/1 assembly.
8. Remove both cartridge transport assemblies (with ribbon cables attached), part number 0993002-0001 or -0002, by performing the following steps (see figure 1-6):

NOTE

The four transport mounting screws were removed in step 6.

- a. Disconnect the transport ribbon cable for each cartridge transport assembly from connectors J3 and J4 located on the motherboard near slot A1 in front of the red mark.
- b. Disconnect the transport ground wire from the motor mount on each cartridge transport assembly. These wires will be reconnected in the DS990/1 assembly procedure.
- c. Lift the right cartridge transport assembly (with ribbon cable attached) from its mounting bracket.

NOTE

To remove the left cartridge transport assembly it may be necessary to first remove the foam tape between the front of the plenum and the base that holds the ribbon cable in place.

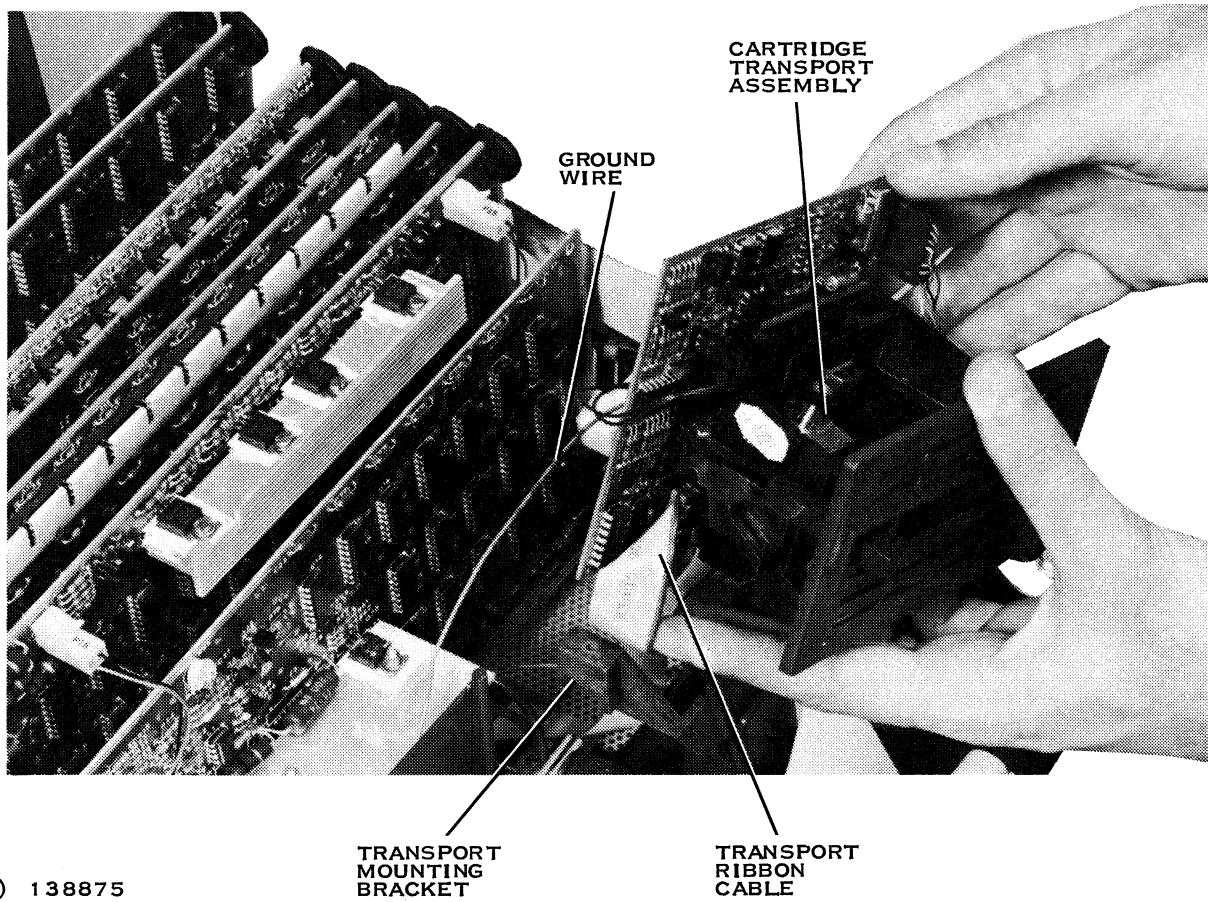
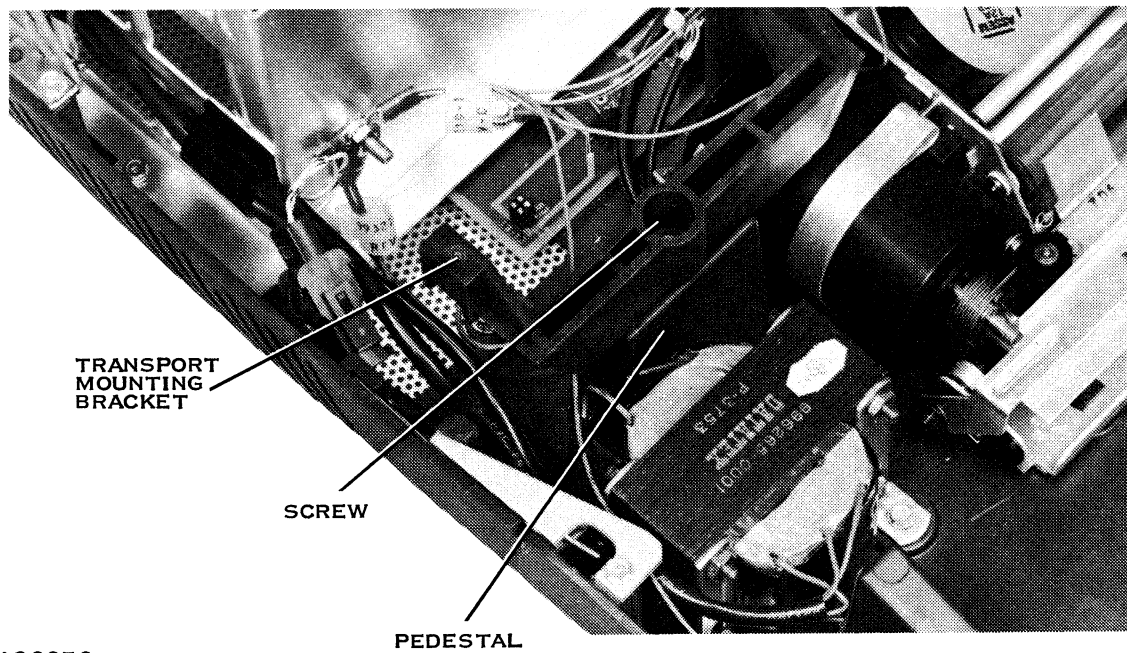

Figure 1-6. Tape Transport Removal in Model 770 Intelligent Data Terminal

- d. Lift the left cartridge transport assembly (with ribbon cable attached) from its mounting bracket.
 - e. Replace the foam tape between the front of the plenum and the base, if it was removed, to hold remaining wires in place.
 - f. Remove one screw that secures each transport mounting bracket, part number 0993188-0001, to its pedestal, using a 1/4-inch hex-head nut driver (see figure 1-7).
9. Remove main memory board from slot A5 at the green mark (see figure 1-4).
10. If present, remove expansion memory boards from slot A7 at the purple mark and from slot A8 at the gray mark (see figure 1-4).
11. Using a flat-bladed screwdriver, remove the screw, lockwasher, and flat washer holding the blank connector plate, part number 0993221-0001, to the rear of the chassis (see figure 1-2). Slide the blank connector plate out of its slot.
12. Lift the bezel from the keyboard (see figure 1-4).



(A) 138876

Figure 1-7. Transport Mounting Bracket Removal in Model 770 Intelligent Data Terminal

13. To complete the disassembly, lift the following keytops from their associated keys on the keyboard (see figure 1-8):

F1 START	F6 STATUS
F2 STOP	F7 TIME
F3 DELETE	F8 CLEAR
F4 RESTART	COMMAND MODE
F5 LOAD	COMMAND CANCEL
	RETURN

1.3 DS990/1 ASSEMBLY

Perform the following procedure to install the DS990/1 upgrade kit into a Model 770 terminal to develop a DS990 Model 1. Refer to table 1-1 for item number references.

NOTE

This procedure assumes that the disassembly procedure of paragraph 1.2 has been performed and that the terminal cover assembly is open as shown in figure 1-9.

1. Mount one connector tab (item 9), part number 0972172-0003, to each transport pedestal, securing the tab with screws (item 24) (see figure 1-10).
2. Connect the transport ground wires that were disconnected in paragraph 1.2, step 8.b. of Model 770 disassembly to the connector tabs installed in step 1 above (see figure 1-10). If necessary, cut the tie wrap on the wire bundle to allow the ground wires to reach the connector tabs.

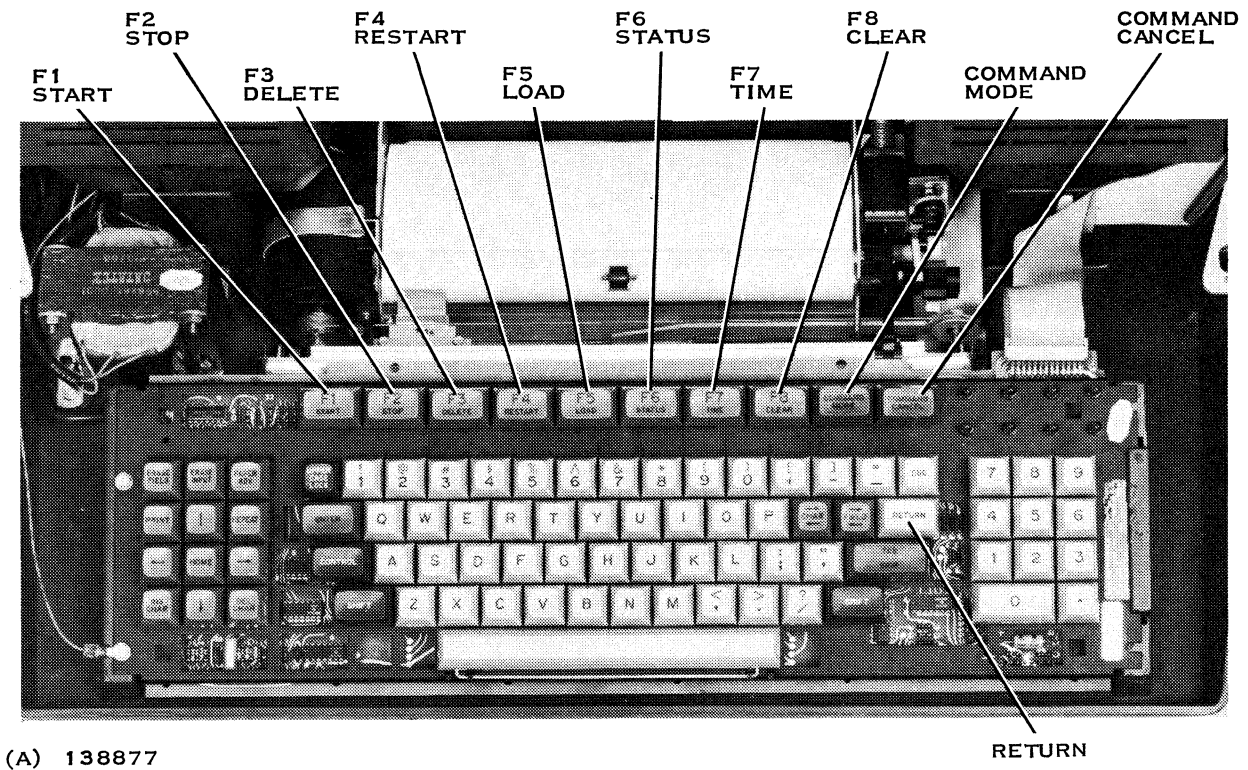

(A) 138877

Figure 1-8. Keyboard Layout of the Model 770 Intelligent Data Terminal

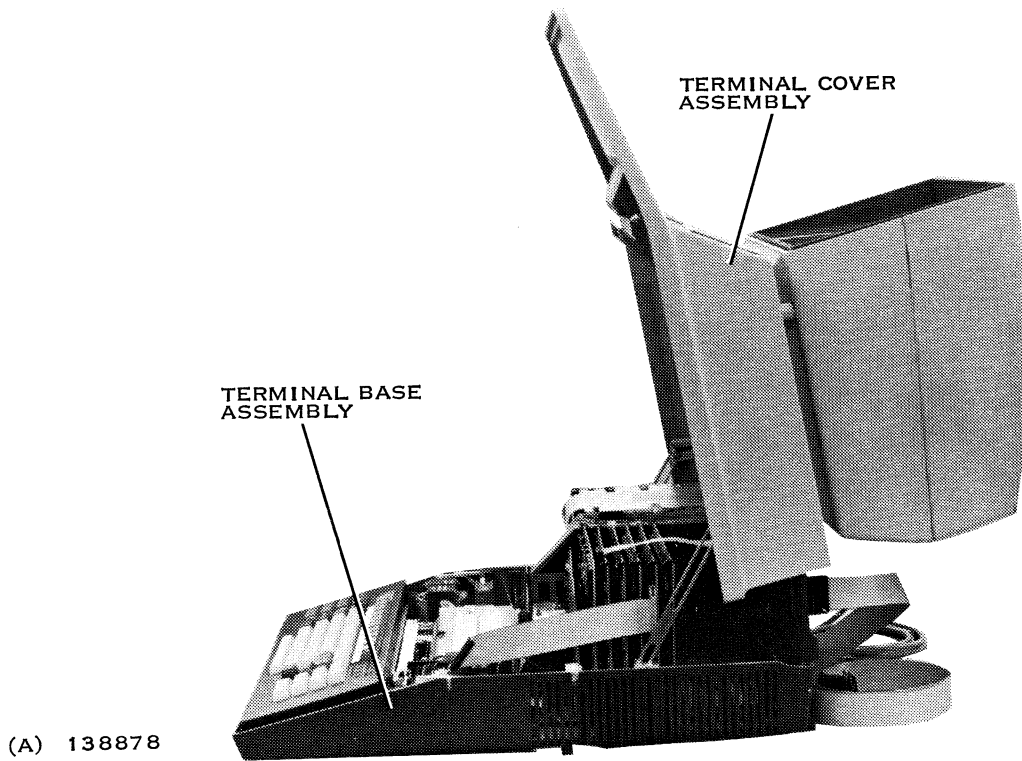

Figure 1-9. DS990/1 Terminal Assembly with Cover Assembly Open

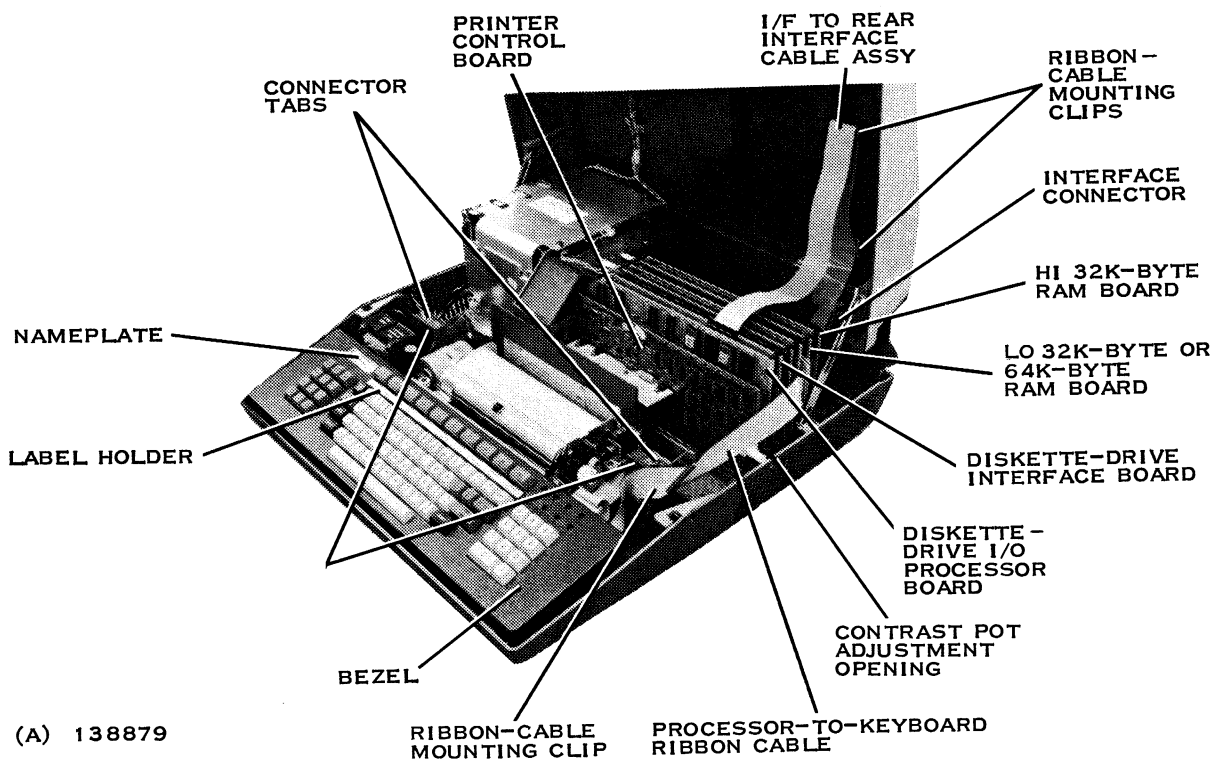

Figure 1-10. Internal View of DS990/1 Terminal Assembly

3. If not already installed, place one ribbon-cable-mounting clip (item 8), part number 0996086-0001, on the front side of the right transport pedestal. Position the clip in the center of the pedestal with the clip opening pointing upward. When the correct position for the clip is determined, peel the backing off the clip and firmly press the clip in place. Attach the processor-to-keyboard ribbon cable to the clip and route the cable so that it clears the contrast pot adjustment opening (see figure 1-10).
4. Clear the motherboard of all debris and install the following new circuit boards (see figure 1-10).

<u>ITEM</u>	<u>PART NUMBER</u>	<u>SLOT</u>	<u>DESCRIPTION</u>
1*	2263555-0002 and 2263555-0005	A5 A7	LO 32K byte RAM HI 32K byte RAM
	or		
2*	2267360-0002	A5	64K byte RAM
3	2263550-0001	A3	Diskette Drive I/O Processor
4	2263560-0001	A4	Diskette Drive Interface

*64K-bytes of RAM consists of two 32K-byte circuit boards or one 64K-byte circuit board.

5. Reinstall the printer control board that was removed in step 7 (paragraph 1.2) of Model 770 disassembly in slot A1 in front of the red mark (see figure 1-10).
6. Install the disk I/F to DS990/1 rear interface-cable assembly (item 5), part number 2263575-0001, by performing the following steps (see figure 1-10):

- a. With the screw hole down, slide the diskette-drive interface connector end of the interface cable assembly into the slot on the rear of the terminal where the blank connector plate was removed in step 11 of Model 770 disassembly. Use the screw, lockwasher, and flat washer, items 25, 26, and 27, respectively, to secure the interface connector.
- b. Connect the circuit-board connector end of the interface cable assembly to the diskette-drive interface board in slot A3 at the orange mark, so that the cable extends toward the back of the DS990/1 terminal assembly.
- c. Locate the proper positions for two ribbon-cable mounting clips (item 8), part number 996086-0001, on the underside of the terminal cover assembly. The clip positions must be placed so that the interface cable will have some slack when it is attached to the clips with the terminal cover assembly in the open position (refer to figure 1-10). The approximate locations for the clips are as follows:
 - o Bottom clip – $3/4$ inch from the bottom edge of the top cover and $1-1/8$ inch from the right circuit card retainer, with clip positioned so the ribbon cable enters the clip from the left.
 - o Top clip – $6-3/4$ inches from the bottom edge of the top cover and $1-3/4$ inches from the right circuit card retainer, with clip positioned so the ribbon cable enters the clip from the right.

Remove any dust, grease, or extraneous matter from the area where the two clips are to be mounted. Peel the backing off the clips and firmly press the clips into place.

- d. Attach the interface cable to the two clips installed in step 6.c. above.
7. Press the following keytops (items 10 through 20), part numbers 0993247-0164 through -0171, -0175, -0177, and -0178, on the correct keys of the keyboard as shown in figure 1-11. The keytops are all medium gray in color except for the RETURN keytop which is orange.

F1	F5	F9
F2	F6	F10
F3	F7	RETURN
F4	F8	

8. Place the supplied DS990/1 bezel (item 30) in position on the keyboard (see figure 1-10).
9. Peel the backing off the new nameplate (item 21), part number 2263584-0001. Align the new nameplate over the smooth area for the nameplate on the bezel as shown in figure 1-10 and firmly press the new nameplate into place.
10. Peel the backing off the label holder (item 30), part number 0993223-0002. Align the label holder over the smooth area on the bezel as shown in figure 1-10 and firmly press into place.

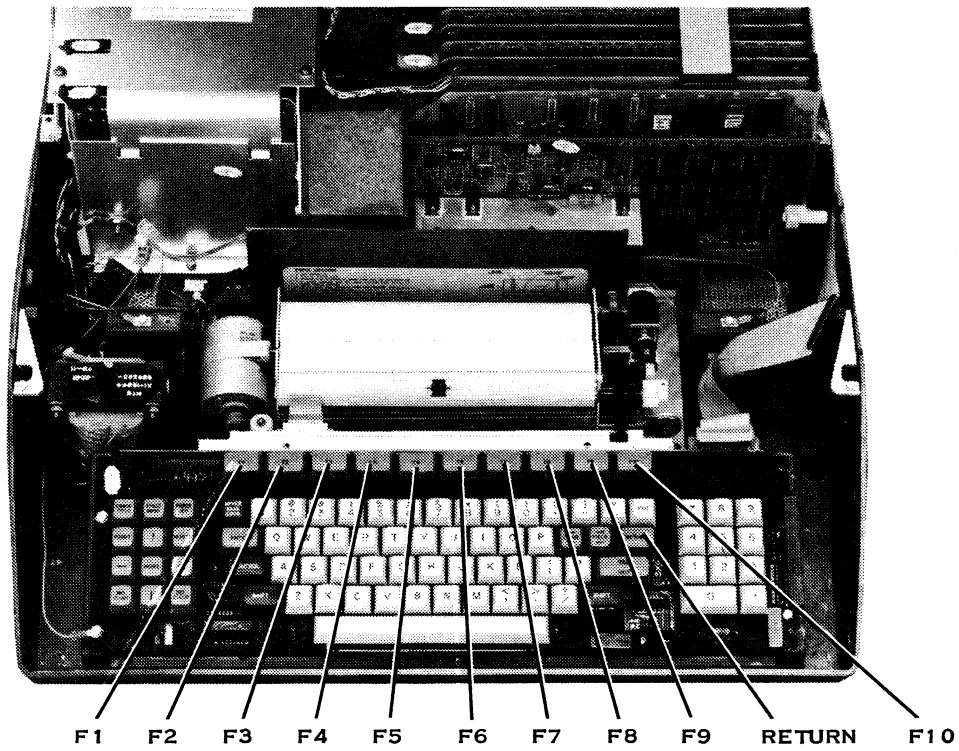

(A) 138880

Figure 1-11. DS990/1 Terminal Assembly Keyboard

11. Close the terminal cover assembly by carefully lowering the cover and pressing down on each side of the cover to engage the cover latches.
12. Place a transport opening panel in position over each transport opening hole and press the panels to snap them into position (see figure 1-1).
13. Replace the old terminal configuration chart on the back of the DS990/1 terminal assembly (figure 1-12) with item 31, part number 2263584-0003 (figure 1-13). Use the following procedure to fill in the DS990/1 configuration label:
 - a. Fill in the dash number on the part number with
 - a. P/N 2263582-4 if upgrading a domestic unit
 - b. P/N 2263583-4 if upgrading a foreign unit.
 - b. Fill in the 85__ option with the number of floppy drives on the upgraded unit.
 - c. Fill in the M__ option with 64.
 - d. Fill in the 7__S option with a 1 if the upgraded unit does not have an internal printer.

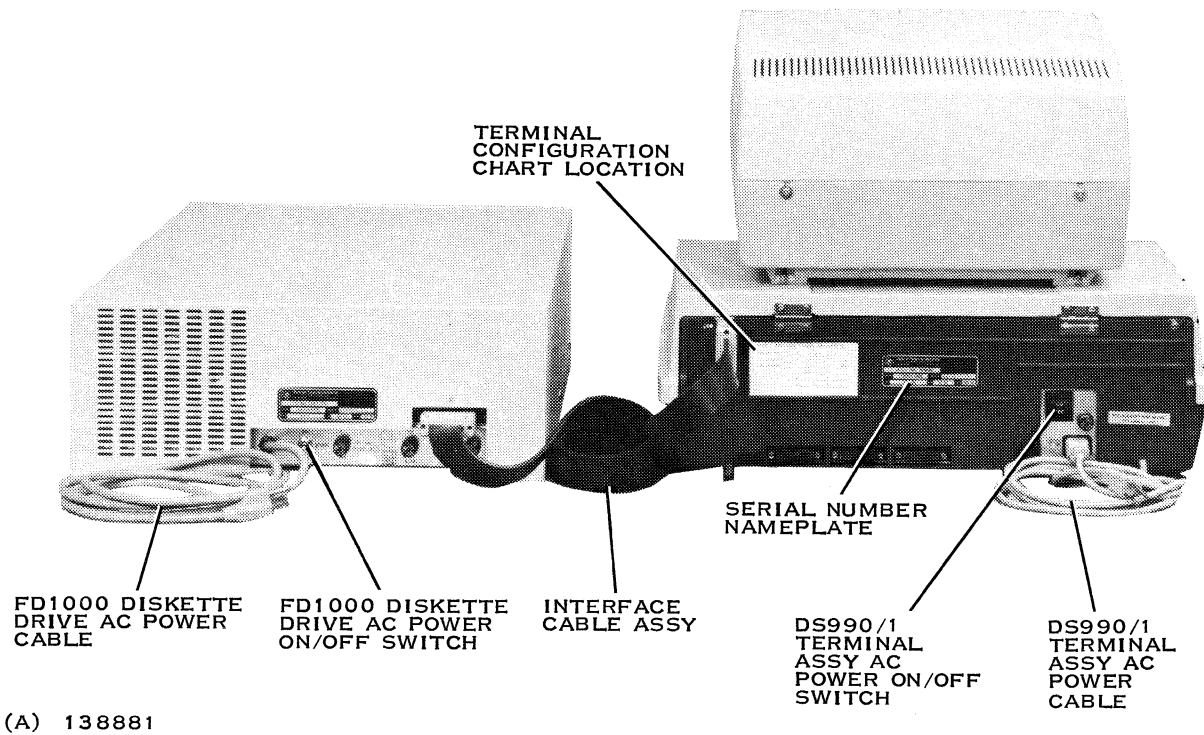

(A) 138881

Figure 1-12. Rear View of DS990/1 System

DS990/1 INTELLIGENT TERMINAL CONFIGURATION					
P/N 2267375	_____	7	_____	S E _____	MC _____
P/N 2263582	_____	7	_____	P E _____	A O _____
P/N 2263583	_____	_____	100	I _____	_____
		_____	200	I _____	_____
		M	_____	I _____	_____
		85	_____	S _____	_____
		_____	_____	_____	_____

(A) 140995

Figure 1-13. Typical Terminal Configuration Chart Showing DS990/1 Upgrade

- e. Fill in the 7__P option with a 1 if the upgraded unit has an internal printer.
 - f. Transfer all "write in" and "checked" options from the old configuration label to the new configuration label. Refer to appendix C for configuration comparison between labels.
14. Remove the old 770 serial number nameplate (figure 1-12) and replace with item 28 if the unit is a 110-volt model, or item 29 if the unit is a 230-volt model. Discard old serial number nameplate.
 15. Place the DS990/1 terminal assembly and one or two FD1000 diskette drive assembly(s) on a table or desk into position for operation (see figures 1-14 and 1-15).
 16. Connect the DS990/1 terminal assembly to dual diskette-drive assembly, using interface ribbon cable (item 6), part number 2267374-0001 (one FD1000 assembly) or part number 2267376-0001 (two FD1000 assemblies). The cable connects between the diskette-drive interface connector installed in step 6.a. on the rear of the terminal and connector J1 on the rear of the FD1000 diskette-drive assembly(s) (see figures 1-16 and 1-17).
 17. Reconnect the ac power cord associated with the DS990/1 terminal assembly between the ac power connector on the rear of the terminal and the selected ac power source (see figures 1-16 and 1-17).

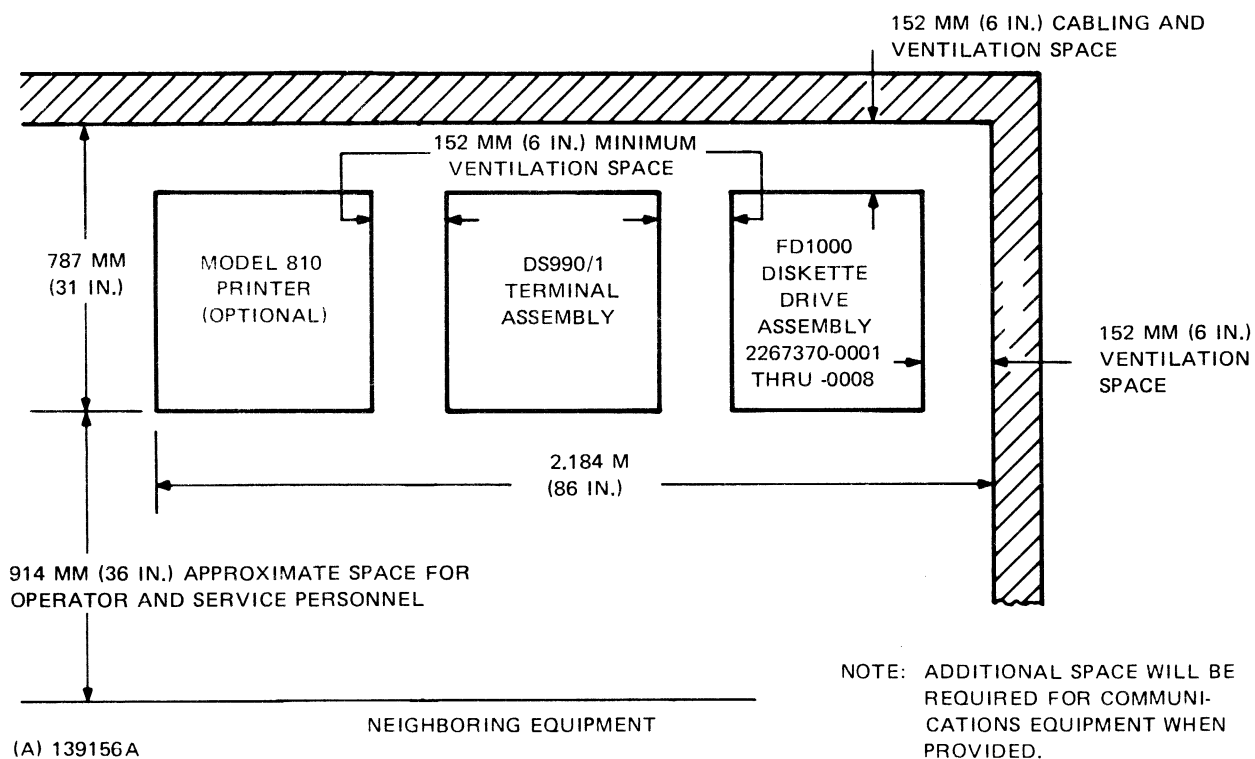
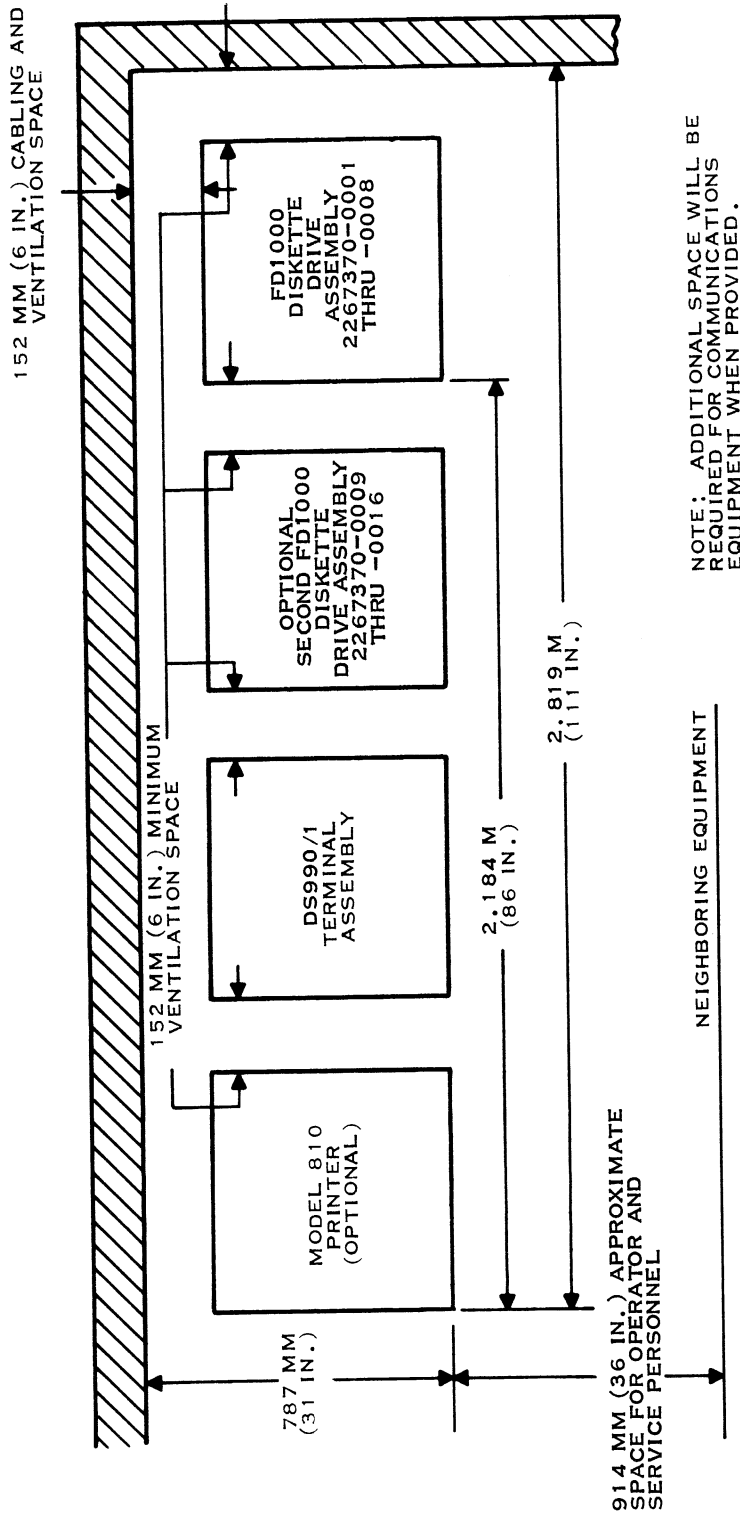
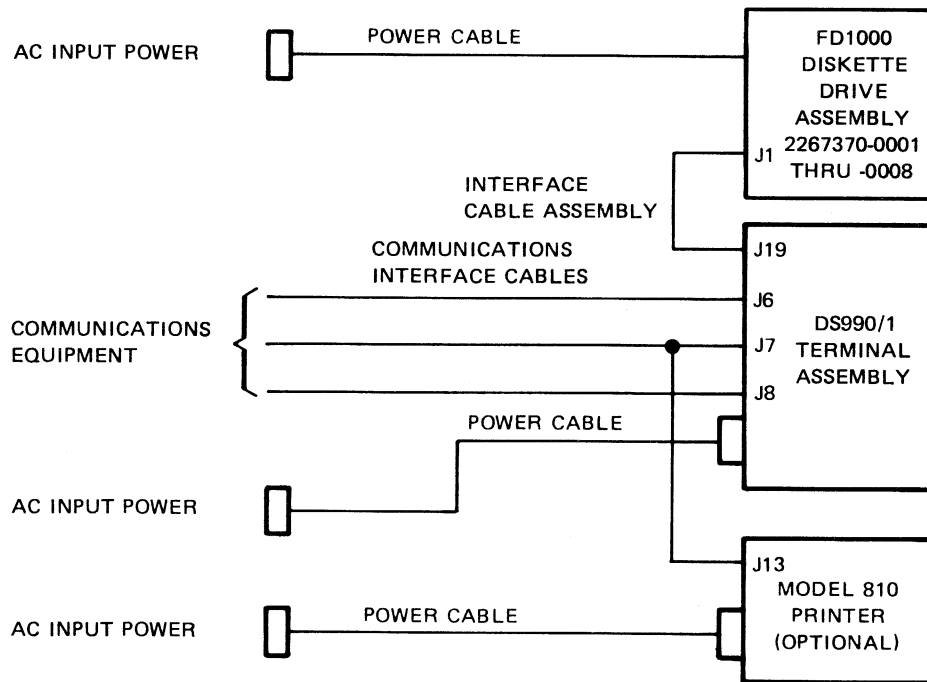

Figure 1-14. Typical Floor Plan Layout of the DS990/1 System With One FD1000 Assembly



(A) 139156A

Figure 1-15. Typical Floor Plan Layout of the DS990/1 System With Two FD1000 Assemblies



(A) 139162 A

Figure 1-16. Typical Connection Diagram for the DS990/1 System With One FD1000 Assembly

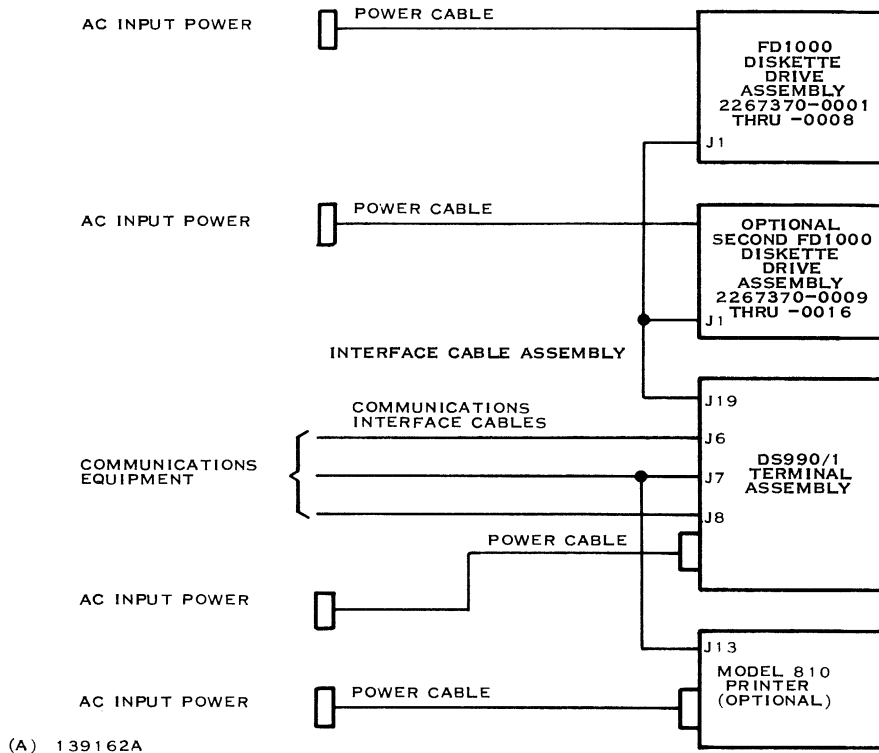

Figure 1-17. Typical Connection Diagram for the DS990/1 System With Two FD1000 Assemblies

18. To complete the DS990/1 assembly, connect the FD1000 diskette-drive assembly ac power cord to the same ac power source to which the DS990/1 terminal assembly is connected (see figures 1-16 and 1-17).

1.4 DS990/1 CHECKOUT

In order to verify that the Model 770 to DS990/1 upgrade procedure was successful, the field maintenance test (FMT) procedure, part number 2262570-9701, should be performed.

1.5 UPGRADE PARTS LIST

All the parts and assemblies required to upgrade a Model 770 terminal to a DS990/1 system are listed in table 1-1. This parts list is based on the following list of material (LMs) and product indexes:

<u>Geographic Location</u>	<u>List of Material</u>	<u>Product Indexes</u>
U.S.A.	2267378	2267380
European	2267373	2267381

Table 1-1. Parts List Required to Upgrade Model 770 to DS990/1 System

<u>Item</u>	<u>Quantity</u>	<u>Part Number</u>	<u>Description</u>
1*			64K-byte RAM memory systems as follows:
	1	2263555-0002	LO 32K-byte RAM circuit board (slot A5)
		and	
	1	2263555-0005	HI 32K-byte RAM circuit board (slot A7)
		or	
2*	1	2267360-0001	64-byte RAM circuit board (slot A5)
3	1	2267355-0001	Diskette-drive I/O processor circuit board

* Use part numbers 2263555-0002 and 2263555-0005 when 32K-byte RAM boards are available and part number 2267360-0001 when 64K-byte RAM boards are available.

Table 1-1. Parts List Required to Upgrade Model 770 to DS990/1 System
(Continued)

<u>Item</u>	<u>Quantity</u>	<u>Part Number</u>	<u>Description</u>
4	1	2267350-0001	Diskette-drive interface circuit board
5	1	2263575-0001	Disk I/F to DS990/1 rear ribbon-cable assembly
6			Ribbon-cable assembly as follows:
	1	2267374-0001	Terminal assembly to one FD1000 assembly
		or	
	1	2267376-0001	Terminal assembly to two FD1000 assemblies
7	2	2263565-0001	Cartridge transport opening panels
8	3	0996086-0001	Ribbon-cable mounting clips
9	2	0972172-0003	Connector tab terminals
10	1	0993247-0164	Keytop F1, medium gray
11	1	0993247-0165	Keytop F2, medium gray
12	1	0993247-0166	Keytop F3, medium gray
13	1	0993247-0167	Keytop F4, medium gray
14	1	0993247-0168	Keytop F5, medium gray
15	1	0993247-0169	Keytop F6, medium gray
16	1	0993247-0170	Keytop F7, medium gray
17	1	0993247-0171	Keytop F8, medium gray
18	1	0993247-0175	Keytop RETURN, orange
19	1	0993247-0177	Keytop F9, medium gray
20	1	0993247-0178	Keytop F10, medium gray
21	1	2263584-0001	Nameplate, DS990/1 Intelligent Terminal
22	1	2262516-0001	Operators' Maintenance Kit
23	1	2262326-9701	Model 770 Intelligent Data Terminal Upgrade Instructions to DS990 System, Model 1

Table 1-1. Parts List Required to Upgrade Model 770 to DS990/1 System
(Continued)

<u>Item</u>	<u>Quantity</u>	<u>Part Number</u>	<u>Description</u>
24	2	0972969-0006	Screw #6-20 x 1/2
25	1	0972988-0028	Screw #6-32 x 3/8
26	1	0411104-0136	Lockwasher #6
27	1	0411027-0806	Flat washer, .156 x .375 x .049
28	1	2267382-0003	I.D. Plate U.S.
29	1	2267383-0003	I.D. Plate Eur.
30	1	0993223-0002	Holder, keyboard label with adhesive tape backing
31	1	2263584-0003	Configuration label, DS990/1
32	1 or 2		Table-Top FD1000 diskette drive assembly(s) as follows:
		2267370-0001	115V, 60 Hz, drives 1 and 2
		2267370-0002	230V, 50 Hz, drives 1 and 2
		2267370-0003	100V, 50 Hz, drives 1 and 2
		2267370-0004	100V, 60 Hz, drives 1 and 2
		2267370-0005	115V, 60 Hz, drive 1
		2267370-0006	230V, 50 Hz, drive 1
		2267370-0007	100V, 50 Hz, drive 1
		2267370-0008	100V, 60 Hz, drive 1
		2267370-0009	115V, 60 Hz, drive 3
		2267370-0010	250V, 50 Hz, drive 3
		2267370-0011	100V, 50 Hz, drive 3
		2267370-0012	100V, 60 Hz, drive 3
		2267370-0013	115V, 60 Hz, drives 3 and 4

Table 1-1. Parts List Required to Upgrade Model 770 to DS990/1 System
(Continued)

<u>Item</u>	<u>Quantity</u>	<u>Part Number</u>	<u>Description</u>
		2267370-0014	230V, 50 Hz, drives 3 and 4
		2267370-0015	100V, 50 Hz, drives 3 and 4
		2267370-0016	100V, 60 Hz, drives 3 and 4
33			Not used in this kit
34			Bezel available as follows:
	1	0993141-0002	Standard bezel
		or	
	1	0993253-0002	Modified German bezel
		or	
	1	0993253-0004	Modified Japanese bezel

APPENDIX A

OPTION LIST FOR SHUGART SA850 DRIVES

Table A-1 lists the available jumper options for the Shugart SA850 drives, which may be part of the FD1000 diskette drive assembly. Under normal conditions the option jumpers will be installed correctly and no further changes will be needed. The list of jumper options is provided for reference only.

Table A-1. Option List for Shugart SA850 Drives

OPTION DESIGNATOR	DS01 (AS ONLY DRIVE)	DS01 (NOT ONLY DRIVE)	DS02	DS03	DS04
Terminator (3H)	X		X		
DS1	X	X			
DS2			X		
DS3				X	
DS4					X
A (SHUNT 4H)	X	X	X	X	X
B (SHUNT 4H)					
I (SHUNT 4H)	X	X	X	X	X
R (SHUNT 4H)	X	X	X	X	X
S (SHUNT 4H)	X	X	X	X	X
X (SHUNT 4H)	X	X	X	X	X
Z (SHUNT 4H)	X	X	X	X	X
HL(SHUNT 4H)					
2S	X	X	X	X	X
C					
D					
Y					
HI	X	X	X	X	X
DC	X	X	X	X	X
DL	X	X	X	X	X
DS					
HLL	X	X	X	X	X
S1	X	X	X	X	X
S2					

Table A-1. Option List for Shugart SA850 Drives (Continued)

OPTION DESIGNATOR	DS01 (AS ONLY DRIVE)	DS01 (NOT ONLY DRIVE)	DS02	DS03	DS04
S3					
IW					
IT					
RM	X	X	X	X	X
RS					
850/851	850	850	850	850	850
-5/-15v	-5	-5	-5	-5	-5

NOTE: X indicates jumper present.

APPENDIX B

OPTION LIST FOR QUME DT/8 DRIVES

Table B-1 lists the available jumper options for the Qume DT/8 drives which may be part of the FD1000 diskette drive assembly. Under normal conditions the option jumpers will be installed correctly and no further changes will be needed. The list of jumper options is provided for reference only.

Table B-1. Option List for Qume DT/8 Drives

OPTION DESIGNATOR	DS01 (AS ONLY DRIVE)	DS01 (NOT ONLY DRIVE)	DS02	DS03	DS04
Terminators (1TM, 2TM)	X		X		
DS1	X	X			
DS2			X		
DS3				X	
DS4					X
A (SHUNT PACK)	X	X	X	X	X
B (SHUNT PACK)					
I (SHUNT PACK)	X	X	X	X	X
R (SHUNT PACK)	X	X	X	X	X
S (SHUNT PACK)	X	X	X	X	X
X (SHUNT PACK)	X	X	X	X	X
Z (SHUNT PACK)	X	X	X	X	X
HL (SHUNT PACK)					
2S	X	X	X	X	X
Y					
DC	X	X	X	X	X
DL	X	X	X	X	X
DS					
S1	X	X	X	X	X
S2					
S3					
NP					
RR	X	X	X	X	X
RI	X	X	X	X	X
WP	X	X	X	X	X

NOTE: X indicates jumper present.

APPENDIX C
CONFIGURATION COMPARISON CHART

The following configuration comparison chart is provided to aid in transferring the markings from existing configuration labels to the new configuration labels.

OLD 770 LABEL	NEW 770 LABEL	DS990/1 LABEL
70S	7__S	7__S
70P	7__P	7__P
100	__100*	__100*
--	__200*	__200*
M08 M16	M__	M__
GPH	__GPH*	__GPH*
E3N E2N E1N	E__N	E__N
E3A E2A E1A	E__A	E__A
I2N I1N	I__N	I__N
I2A I1A	I__A	I__A
I1D	I__D	I__D

*Note: These options are "checked" instead of "filled in".

OLD 770 LABEL	NEW 770 LABEL	DS990/1 LABEL
S3N	S__N	S__N
S2N		
S1N		
OAC	O__C	O__C
OSC		
	MC__	MC__
	80__	
		85__

FOLD

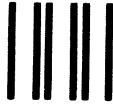

NO POSTAGE
NECESSARY
IF MAILED
IN THE
UNITED STATES

BUSINESS REPLY MAIL

FIRST CLASS PERMIT NO. 7284 DALLAS, TX

POSTAGE WILL BE PAID BY ADDRESSEE

TEXAS INSTRUMENTS INCORPORATED

DIGITAL SYSTEMS GROUP

ATTN: TECHNICAL PUBLICATIONS

P.O. Box 2909 M/S 2146

Austin, Texas 78769

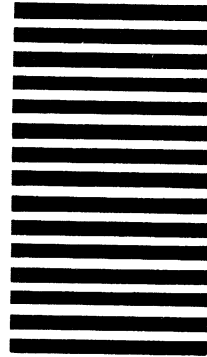

FOLD

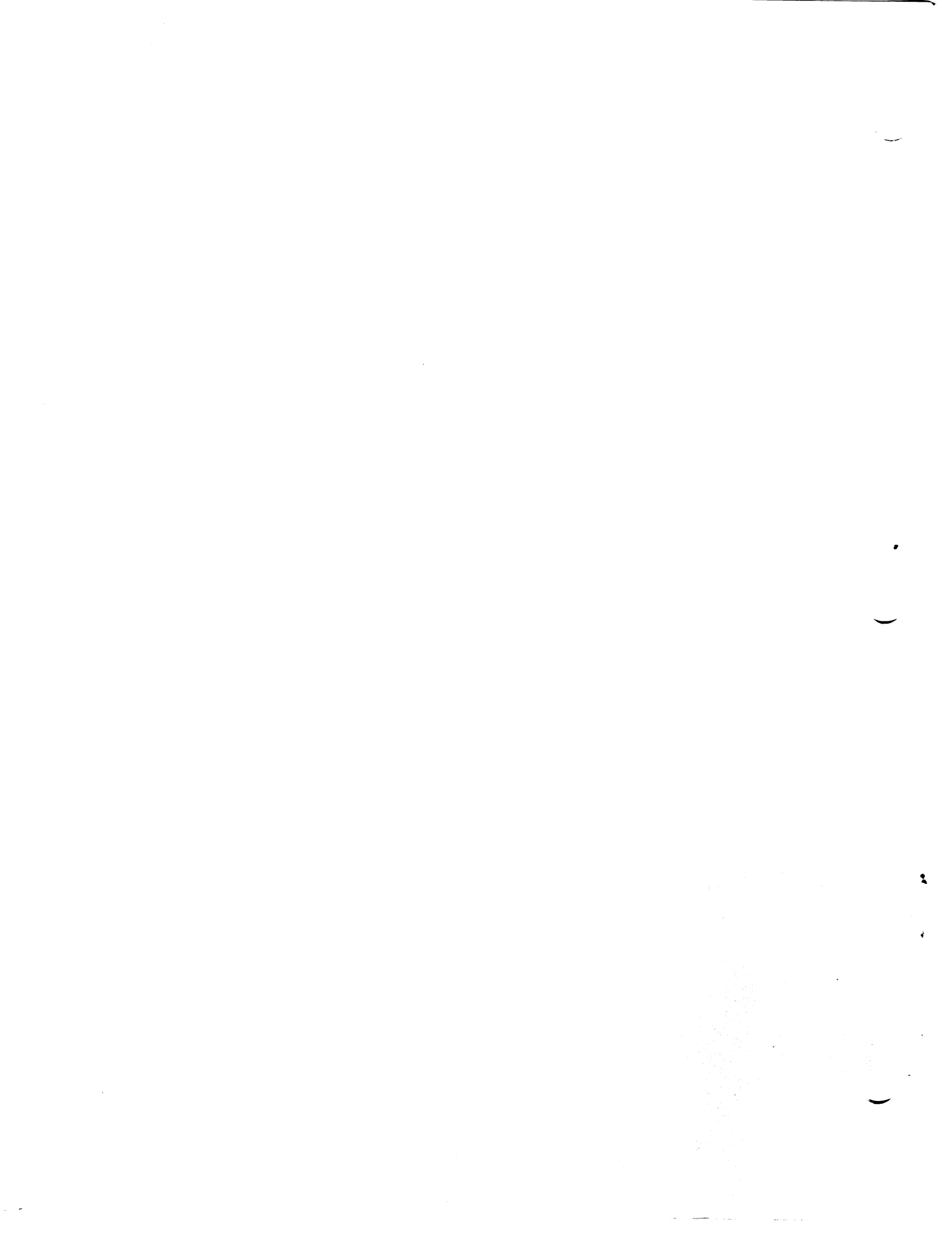

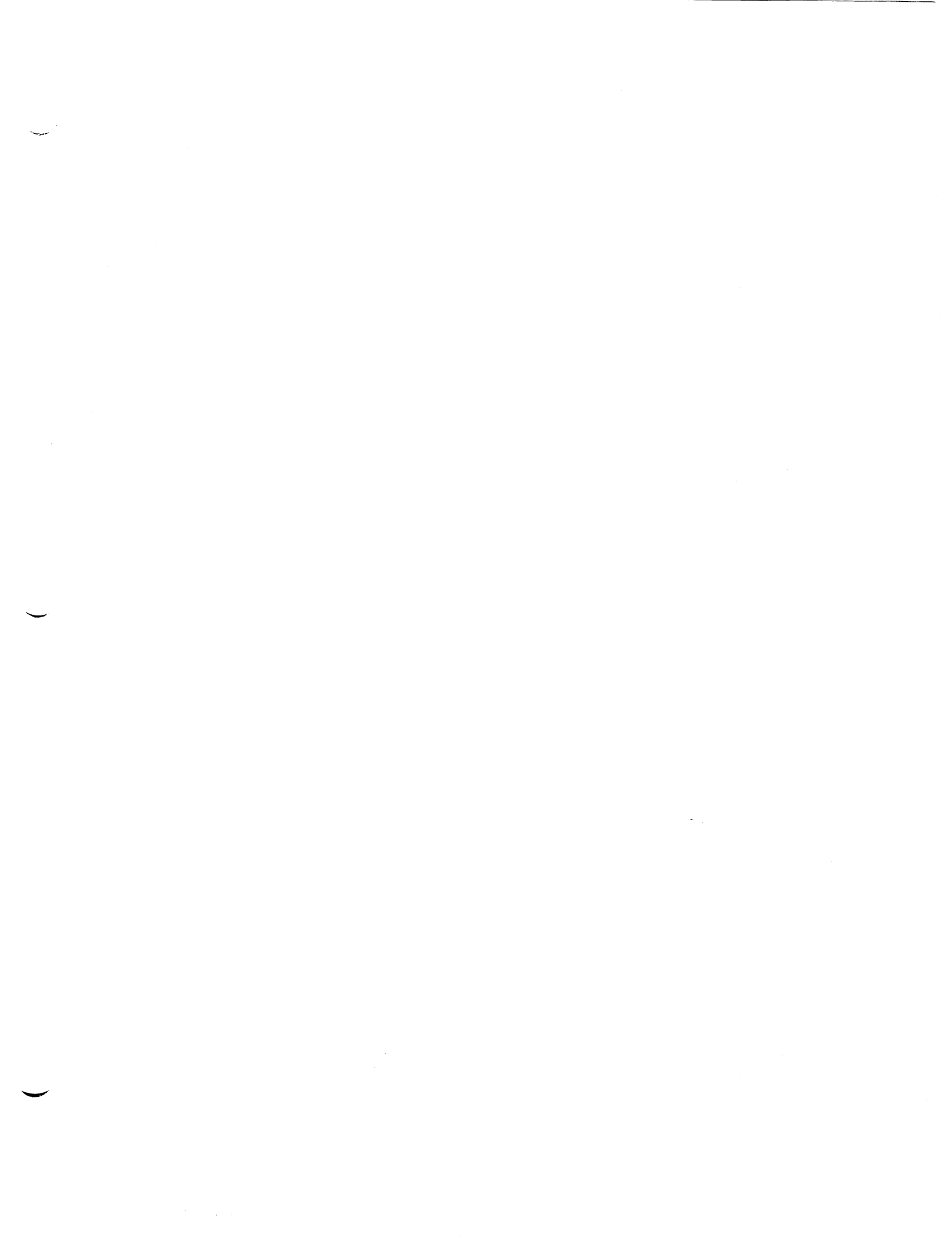

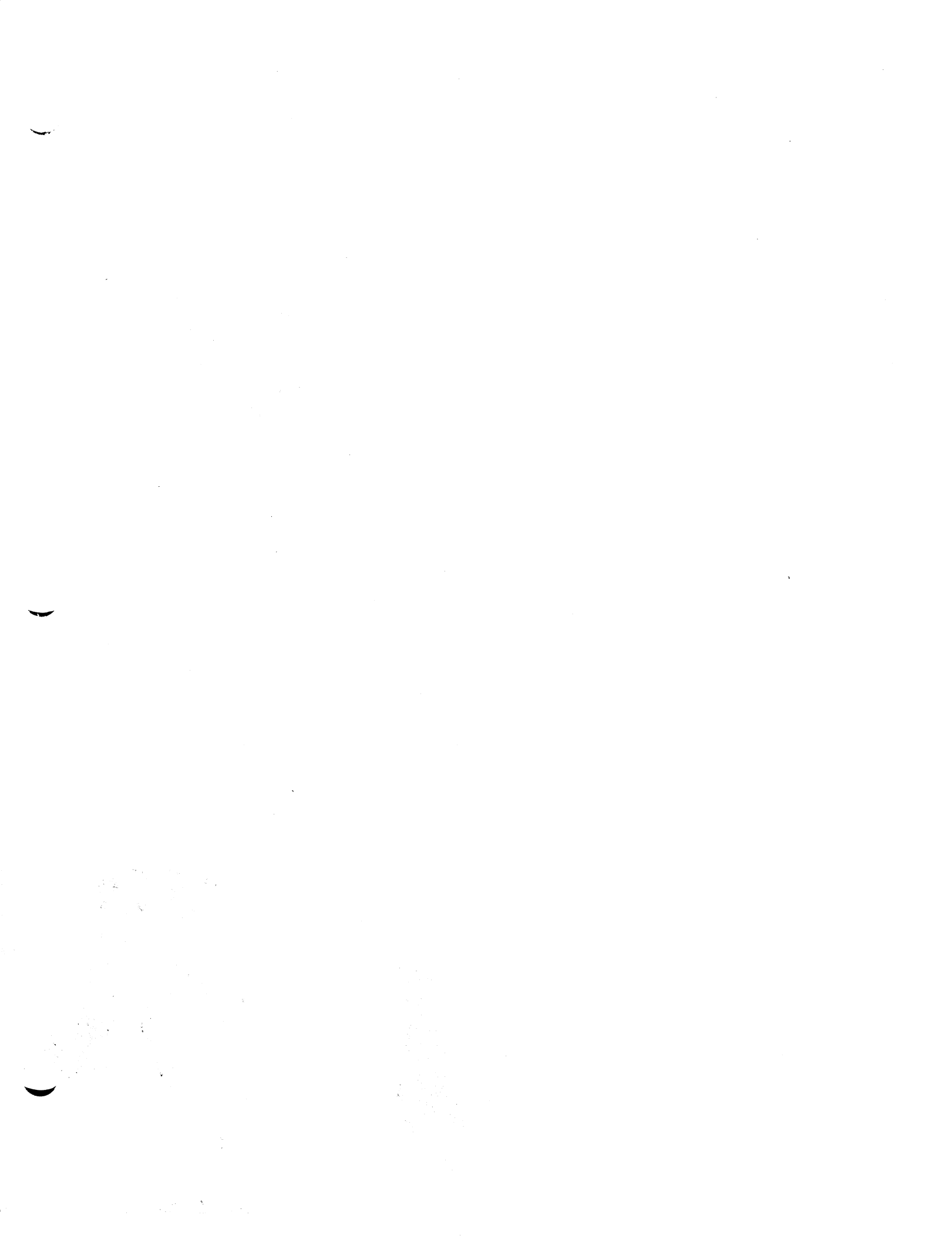



TEXAS INSTRUMENTS

INCORPORATED
DIGITAL SYSTEMS DIVISION

POST OFFICE BOX 2909 AUSTIN, TEXAS 78769