

SPERRY
UTS 30
Single Station
System Reference



This document contains the latest information available at the time of preparation. Therefore, it may contain descriptions of functions not implemented at manual distribution time. To ensure that you have the latest information regarding levels of implementation and functional availability, please consult the appropriate release documentation or contact your local Sperry representative.

Sperry reserves the right to modify or revise the content of this document. No contractual obligation by Sperry regarding level, scope, or timing of functional implementation is either expressed or implied in this document. It is further understood that in consideration of the receipt or purchase of this document, the recipient or purchaser agrees not to reproduce or copy it by any means whatsoever, nor to permit such action by others, for any purpose without prior written permission from Sperry.

FASTRAND, SPERRY, SPERRY UNIVAC, UNISCOPE, UNISERVO, and UNIVAC are registered trademarks of the Sperry Corporation. ESCORT, FLOW-MATIC, MAPPER, PAGEWRITER, PIXIE, SPERRYLINK, and UNIS are additional trademarks of the Sperry Corporation.



PUBLICATIONS REVISION	
UTS 30	
SPERRY® UTS 30 Single Station System Reference	
UP-9799 Rev. 1	

SPERRY 222 UAS
 6TH FLOOR
 8008 WESTPARK DRIVE U
 MCLEAN VA 22102

This library memo announces the release and availability of "SPERRY UTS 30 Single Station System Reference," UP-9799 Rev. 1. It is a Standard Library Item (SLI).

The UTS 30 is a low-cost display terminal available in two different versions for sending, receiving, manipulating, and displaying data. The programmable UTS 30 functional capabilities are loaded by diskette from a SPERRY 8439 Double-Sided Diskette Subsystem. A program cartridge provides the functional capabilities of the basic version of the UTS 30.

This manual contains instructions and programming information for programming the host processor for use with a UTS 30 operating in UNISCOPE mode. Programming information for associated equipment is also included.

Revision 1 adds graphics commands and protocol strings.

Additional copies of this manual may be ordered by your Sperry representative.

Destruction Notice: This book supersedes and replaces "SPERRY UTS 30 Single Station System Reference," UP-9799, released on library memo dated November 1983. Please destroy all copies of UP-9799 and its library memo.

LIBRARY MEMO ONLY	LIBRARY MEMO AND ATTACHMENTS	THIS SHEET IS
Lists MAC, MCZ, MMZ, 8, 9, 9U, 10, 11, 18, 19, 20, 21, 30, 31U, 37, 37U, 38, 60, 61, 62, 63, 63U, 64, 64U, 65, 66, 75, 76, 77, 78, 81, 81U, 83, 83U, 89, 89U	Lists MCS, MCT, MZZ, 82 (220 pages plus library memo)	Library Memo for UP-9799 Rev. 1 RELEASE DATE: August 1985

Preface

This manual contains information that is needed when a host system is programmed for use with the SPERRY Universal Terminal System 30 (UTS 30) Single Station operating in UNISCOPE mode.

There are five sections plus appendixes. The sections discuss:

- Hardware and associated software products (Section 1)
- Terminal operation (Section 2)
- Communications line protocol (Section 3)
- Text messages (Section 4)
- Graphics messages (Section 5)

The appendixes contain lists of rules, codes, operating characteristics, and compatibility criteria.

Detailed information concerning the UTS 30 can be found in current versions of the UTS 30 system description, UP-9796, the UTS 30 operator's reference, UP-9798, and the UTS 30 verification guide, UP-9804.

The UTS 30 is a random-access memory (RAM)-based display terminal available in two SPERRY Universal Terminal System 400 (UTS 400) compatible models: the basic version and the programmable version. On the basic version, the system control software is loaded from a program cartridge; on the programmable version, the system control software is loaded from a diskette in the SPERRY 8439 Double-Sided Diskette Subsystem. The two features can be installed by the customer.

Contents

PREFACE

CONTENTS

1. SYSTEM DESCRIPTION

1.1.	UNISCOPE MODE SYSTEM CONTROL SOFTWARE	1-1
1.2.	HOST INTERFACE	1-1
1.3.	PRINTER INTERFACE	1-2
1.4.	DISKETTE CONTROLLER INTERFACE	1-2
1.5.	DISKETTE STORAGE	1-2
1.6.	SCREEN	1-2
1.7.	ALTERNATE SCREEN	1-2
1.8.	CHARACTER SET MEMORY	1-3
1.9.	USER PROGRAMMABILITY	1-3
1.10.	PROGRAM PRODUCTS	1-3
1.10.1.	CP/M Plus™ Operating Mode	1-3
1.10.2.	Character Set Generator Utility	1-3
1.10.3.	Edit Processor Utility	1-3
1.10.4.	File Transfer Utility	1-4
1.10.5.	Diskette File Utility	1-4
1.11.	COMMUNICATION SYSTEMS	1-4
1.11.1.	System Configurations	1-4
1.11.2.	Modem	1-4
1.11.3.	Direct Connection Module (DCM)	1-4
1.11.4.	Terminal Multiplexer	1-7

2. FUNCTIONAL DESCRIPTION

2.1.	TERMINAL READINESS AND RELIABILITY	2-1
2.1.1.	Power-On Confidence (POC) Test	2-1
2.1.1.1.	Parameters Defaulted or Communication Parameter Invalid	2-2
2.1.1.2.	Program Load Failure	2-2
2.1.2.	Audible Alarm	2-2
2.1.3.	Error Log	2-2
2.1.4.	Line Monitor Function	2-2
2.1.5.	Error Recovery	2-3
2.1.6.	Loopback Diagnostic Tests	2-3
2.1.7.	Maintenance and Reliability Operations	2-3
2.2.	CONTROL PAGE	2-3
2.3.	CONFIGURATOR UTILITY	2-3

2.4.	SCREEN CONTROL	2-4
2.5.	PROGRAM ATTENTION KEYS	2-4
2.6.	COMMUNICATIONS ENVIRONMENT	2-5
2.6.1.	Transmission Characteristics	2-5
2.6.2.	Message Routing	2-5

3. COMMUNICATIONS PROTOCOL

3.1.	GENERAL	3-1
3.1.1.	Poll/Response Message Sequence	3-1
3.1.2.	Host Processor Text Message to UTS 30 — Message Sequence	3-2
3.2.	STATION AND PERIPHERAL ADDRESSING	3-2
3.2.1.	Operator Selection of Addresses	3-3
3.2.2.	Poll Groups	3-3
3.3.	PARITY CHECKING	3-5
3.3.1.	Character Parity	3-5
3.3.2.	Block Parity	3-5
3.4.	MESSAGE FORMATS	3-7
3.4.1.	Host Processor Poll Messages to the UTS 30	3-7
3.4.1.1.	Status Poll (ENQ or DLE 1 ENQ)	3-7
3.4.1.2.	Traffic Poll (DLE 1)	3-7
3.4.1.3.	Selection Poll	3-8
3.4.1.4.	Retransmission Request (DLE NAK)	3-8
3.4.2.	Host Processor Text Messages to the UTS 30	3-8
3.4.2.1.	Data Messages (STX — ETX)	3-8
3.4.2.2.	Message Waiting (BEL)	3-8
3.4.2.3.	Disconnection Message (DLE EOT)	3-9
3.4.2.4.	Dump Sequences to Interrupt UTS 30 Activity (DLE EOT)	3-9
3.4.3.	UTS 30 Messages to the Host Processor	3-9
3.4.3.1.	Reply Request (DLE ENQ)	3-9
3.4.3.2.	No Traffic (EOT)	3-10
3.4.3.3.	Acknowledgment (DLE 1 or DLE ?)	3-10
3.4.3.4.	Traffic	3-10
3.4.3.4.1.	Text as Traffic	3-10
3.4.3.4.2.	Program Attention Key Codes as Traffic	3-11
3.4.3.4.3.	Status as Traffic	3-11
3.4.3.4.4.	Disconnection Message as Traffic	3-11
3.5.	BASIC COMMUNICATIONS PROTOCOL FOR HOST PROCESSOR AND UTS 30	3-12
3.5.1.	Rules for Basic Communications Between Host Processor and UTS 30	3-12
3.5.2.	Examples of UTS 30 Text Message Sequences	3-13
3.5.3.	Example of Host Processor Text Message Sequence	3-15
3.6.	MULTIPLEXER FUNCTION	3-15
3.6.1.	Rules for Handling Messages Modified by the Multiplexer Function	3-16
3.6.2.	Examples of Message Sequences Involving the Multiplexer Function	3-17
3.7.	COMMUNICATIONS LINE ERROR RECOVERY	3-20
3.7.1.	Rules for Line Error Recovery	3-20
3.7.2.	Example of Line Error Message Sequence Involving Polls	3-21
3.7.3.	Examples of Line Error Message Sequences Involving UTS 30 Text	3-22
3.7.4.	Examples of Line Error Message Sequences Involving Host Processor Text	3-25
3.7.5.	Examples of Line Error Message Sequences Involving Passing the Acknowledgment	3-30

3.7.6.	Example of Line Error Message Sequence Involving Errors During Recovery	3-34
3.8.	PERIPHERAL OPERATION	3-36
3.8.1.	Peripheral Access Queue (PAQ)	3-36
3.8.2.	UTS 30 Notification to the Host Processor of PAQ Status	3-37
3.8.3.	DID Address Functions	3-37
3.8.4.	Rules for Host Processor/UTS 30 Peripheral Communication	3-37
3.8.5.	Example of Normal Selection Poll Message Sequence	3-40
3.8.6.	Examples of Line Errors During Selection Poll Message Sequences	3-41
3.8.7.	Example of TEXT/SD Message Sequence	3-43
3.8.8.	Example of TEXT/SD/PI Message Sequence	3-43
3.8.9.	Example of Peripheral Error on TEXT/SD/PI Message Sequence	3-45
3.8.10.	Example of Message-Queued Message Sequence	3-46
3.8.11.	Example of Peripheral-Selection-Delayed Message Sequence	3-48
3.8.12.	Example of Sustained-Busy Condition in a Message Sequence	3-49
3.8.13.	Example of Message-Queued Sequence with Potential Sustained-Busy Condition	3-50
3.8.14.	Example Message Sequence Involving Passing of the Acknowledgment and Busy (DLE 1 and DLE ?)	3-53
3.8.15.	Example of Discarding Duplicate Poll (Retransmission Request)	3-54
3.8.16.	Contention	3-57
3.9.	UTS 30 MESSAGE PRIORITIES	3-57
3.9.1.	Rules for UTS 30 Message-Sending Priorities	3-57
3.9.2.	Example of Program Attention Key Being Pressed During Host Processor Text Message	3-58
3.10.	DISCONNECTION OF THE TELEPHONE/MODEM COMMUNICATIONS LINE	3-59
3.10.1.	Disconnection at the UTS 30	3-59
3.10.2.	Disconnection at the Host Processor	3-59
3.11.	HOST PROCESSOR PROGRAMMING SUGGESTIONS	3-60
3.11.1.	Handling of Acknowledgment/Busy-Plus-Traffic Response	3-60
3.11.2.	Passing the Acknowledgment/Busy Response in TEXT/SD, TEXT/PI, or TEXT/SD/PI Messages	3-61
3.11.3.	Line Error Recovery	3-62
4.	UTS 30 AND HOST PROCESSOR TEXT MESSAGES	
4.1.	GENERAL	4-1
4.2.	TEXT MESSAGE FORMAT	4-1
4.2.1.	General Format	4-1
4.2.2.	Start-of-Entry (SOE) (RS)	4-2
4.2.3.	Text Message Transmission	4-2
4.2.3.1.	Transmit All Fields (ESC DC1)	4-2
4.2.3.2.	Transmit Variable Fields (DC1)	4-2
4.2.3.3.	Transmit Changed Fields (ESC t)	4-2
4.2.4.	Timing Considerations (NUL)	4-3
4.3.	TERMINAL CONTROL CODES	4-4
4.3.1.	Call Error Log (ESC P)	4-4
4.3.2.	Clear Error Log (ESC R)	4-4
4.3.3.	Initiate Power-On Confidence Test (ESC Q)	4-4
4.3.4.	Call Control Page (ESC o)	4-4
4.3.5.	Lock Keyboard (ESC DC4)	4-5
4.3.6.	Load Optional Character Set to UTS 30 (ESC SO)	4-5

4.3.7.	Request Character Set ID from UTS 30 (ESC U) and Terminal Response	4-5
4.3.8.	Load Optional Character Set to Diskette (DC3 DC3)	4-5
4.4.	SCREEN CONTROL	4-5
4.4.1.	Cursor Positioning	4-6
4.4.1.1.	Cursor Address Sequence (ESC VT Y X SI RS)	4-6
4.4.1.2.	Cursor to Home (ESC e)	4-6
4.4.1.3.	Request Cursor Address (ESC T) and UTS 30 Response	4-7
4.4.1.4.	Cursor Return (CR)	4-7
4.4.1.5.	Scan Up (ESC f)	4-7
4.4.1.6.	Scan Left (ESC g)	4-7
4.4.1.7.	Scan Right (ESC h)	4-7
4.4.1.8.	Scan Down (ESC i)	4-7
4.4.2.	Field Control Characters (FCCs)	4-8
4.4.2.1.	Primary FCC Characteristics	4-8
4.4.2.2.	Expanded FCC Characteristics	4-9
4.4.2.3.	FCC Codes	4-11
4.4.2.3.1.	FCC Sequence with Cursor Positioning (US Y X M N)	4-11
4.4.2.3.2.	Immediate FCC Sequence (EM M N)	4-11
4.4.2.3.3.	Clear Changed Fields (ESC u)	4-12
4.4.2.3.4.	Clear FCCs (ESC w)	4-12
4.4.2.3.5.	FCC Tab Stop (HT or ESC z)	4-12
4.4.3.	SO/SI-Protected Characters	4-12
4.4.3.1.	SO/SI-Protected Fields Used Alone	4-12
4.4.3.2.	SO/SI- and FCC-Protected Fields Used Together	4-13
4.4.4.	Special Emphasis Characters	4-14
4.4.4.1.	Code Sequence to Create or Replace Special Emphasis (ESC ZZ text ESC SP)	4-14
4.4.4.2.	Code Sequence to Add Special Emphasis (ESC Y ZZ text ESC SP)	4-15
4.4.4.3.	Code Sequence to Delete Special Emphasis (ESC Z ZZ text ESC SP)	4-15
4.4.4.4.	Multiple Special Emphasis Codes in One Text Message	4-15
4.4.5.	Editing Functions	4-15
4.4.5.1.	Erase to End of Display (ESC a)	4-15
4.4.5.2.	Erase to End of Line (ESC b)	4-15
4.4.5.3.	Erase to End of Field (ESC K)	4-15
4.4.5.4.	Erase Display (ESC M)	4-15
4.4.5.5.	Delete in Line (ESC c)	4-16
4.4.5.6.	Delete in Display (ESC C)	4-16
4.4.5.7.	Delete Line (ESC k)	4-16
4.4.5.8.	Insert in Line (ESC d)	4-16
4.4.5.9.	Insert in Display (ESC D)	4-16
4.4.5.10.	Insert Line (ESC j)	4-16
4.4.5.11.	Line Duplication (ESC y)	4-16
4.4.5.12.	Tab Forward (HT)	4-17
4.4.5.13.	Tab Stop (Set) (ESC HT)	4-17
4.4.5.14.	Tab Backward (ESC z)	4-17
4.4.6.	Displayable Characters	4-17
4.4.6.1.	Blank Space (SP)	4-17
4.4.6.2.	Start of Entry (SOE) (RS)	4-17
4.4.6.3.	Cursor Return (CR)	4-17
4.4.6.4.	Blinking Start Marker (FS)	4-17
4.4.6.5.	Blinking End Marker (GS)	4-17
4.4.6.6.	Display of Control Characters	4-18

4.5.	PERIPHERAL CONTROL	4-18
4.5.1.	Peripheral Initiation Codes	4-18
4.5.1.1.	Transfer All Fields (ESC G)	4-18
4.5.1.2.	Transfer Variable Fields (ESC F)	4-18
4.5.1.3.	Transfer Changed Fields (ESC E)	4-18
4.5.1.4.	Print (DC2)	4-18
4.5.1.5.	Print Form (ESC H)	4-19
4.5.1.6.	Print Transparent (ESC DC2)	4-19
4.5.2.	Control Codes for Printers	4-19
4.5.2.1.	Line Feed (LF)	4-19
4.5.2.2.	Form Feed (FF)	4-19
4.5.2.3.	Vertical Tab (VT)	4-19
4.5.2.4.	Carriage Return (CR)	4-19
4.5.2.5.	Search (CAN)	4-20
5.	UTS 30 GRAPHICS MESSAGES	
5.1.	GENERAL	5-1
5.2.	GRAPHICS MESSAGE FORMAT	5-1
5.2.1.	Graphics Protocol String	5-1
5.2.2.	Graphics Commands	5-2
5.2.3.	Protocol Errors	5-2
5.3.	HOST COMMANDS TO DEFINE GRAPHICS DISPLAY MODES	5-2
5.3.1.	Enter Graphics Mode (ESC Za)	5-2
5.3.2.	Enter Merged Mode (ESC Zc)	5-2
5.3.3.	Exit Graphics Mode; Replace Graphics Display (ESC Zb)	5-2
5.3.4.	Exit Graphics Mode; Retain Graphics Display (ETX)	5-2
5.3.5.	Partial Message (ETB ETX)	5-3
5.3.6.	Send Graphics to Printer (ESC DC2)	5-3
5.4.	GRAPHICS COMMANDS	5-3
5.4.1.	Initialize Graphics	5-3
5.4.2.	Initialize View Surface	5-3
5.4.3.	Select View Surface	5-4
5.4.4.	Terminate View Surface	5-4
5.4.5.	New Frame	5-4
5.4.6.	Terminate Graphics	5-5
5.4.7.	Move Absolute	5-5
5.4.8.	Move Relative	5-5
5.4.9.	Polymarker Absolute	5-5
5.4.10.	Polymarker Relative	5-6
5.4.11.	Polyline Absolute	5-6
5.4.12.	Polyline Relative	5-6
5.4.13.	Polygon Absolute	5-7
5.4.14.	Polygon Relative	5-7
5.4.15.	Rectangle Absolute	5-7
5.4.16.	Rectangle Relative	5-8
5.4.17.	Circle	5-8
5.4.18.	Arc	5-8
5.4.19.	Sector	5-9
5.4.20.	Text	5-9
5.4.21.	Set Marker Symbol	5-10
5.4.22.	Set Line Style	5-10
5.4.23.	Set Hatch Index	5-10
5.4.24.	Set Polygon Interior Style	5-11
5.4.25.	Set Character Path	5-11

5.4.26.	Set Character Justification	5-12
5.4.27.	Set Character Size	5-13
5.5.	FORMAT OF OPERANDS	5-13
5.5.1.	Delimiters	5-13
5.5.2.	Character Strings	5-13
5.5.3.	Unsigned Integers	5-14
5.5.4.	Signed Integers	5-14
5.5.5.	Coordinate Representation	5-14

APPENDIXES

A. LINE PROTOCOL RULES

A.1.	UTS 30 RULES	A-1
A.2.	HOST PROCESSOR RULES	A-4
A.3.	UTS 30 COMMUNICATIONS CONTROL SEQUENCES	A-7
A.4.	SYNCHRONOUS IDLE (SYN)	A-8

B. TEXT MESSAGE CODES

B.1.	ASCII CODE CONVERSIONS	B-1
B.2.	TEXT MESSAGE FORMAT CODES	B-3
B.3.	TERMINAL CONTROL CODES	B-4
B.4.	SCREEN CONTROL CODES	B-4
B.5.	PERIPHERAL CONTROL CODES	B-7
B.6.	PROGRAM ATTENTION KEY CODES	B-8
B.7.	UTS 30 CURSOR ADDRESSING	B-9

C. PROGRAMMING CONSIDERATIONS FOR MAGNETIC STRIPE READER

C.1.	GENERAL	C-1
C.2.	INPUT MODES	C-1
C.3.	READER OPERATION	C-2
C.4.	DATA FORMAT	C-2
C.4.1.	ABA-Coded Data Format	C-2
C.4.1.1.	Coded Character Set	C-2
C.4.1.2.	Information Format	C-4
C.4.1.3.	Code Conversion	C-4
C.4.1.4.	Longitudinal Redundancy Check (LRC)	C-4
C.4.2.	IATA-Coded Data Format	C-5
C.4.2.1.	Coded Character Set	C-5
C.4.2.2.	Information Format	C-5
C.4.2.3.	Code Conversion	C-7
C.4.2.4.	Longitudinal Redundancy Check (LRC)	C-7
C.5.	DATA FLOW TO THE UTS 30	C-8
C.6.	STATUS REPORTING	C-8

D. POC TEST AND TERMINAL READINESS MESSAGES

D.1.	GENERAL	D-1
D.2.	KEYLOCK STATUS REPORT	D-1
D.3.	INTENSITY DISPLAY	D-2
D.4.	RELEASE NUMBER	D-2
D.5.	LOADING THE UNISCOPE-MODE SYSTEM CONTROL SOFTWARE TO THE PROGRAMMABLE UTS 30	D-3

E. LINE MONITOR

E.1.	LINE MONITOR OPERATION	E-1
E.2.	LINE MONITOR DISPLAY	E-1

F. UTS 30 COMMUNICATION HANDLER COMPATIBILITY, RESTRICTIONS, AND LIMITATIONS

F.1.	UNISCOPE 100/200 AND UTS 30 COMMUNICATION HANDLER DIFFERENCES	F-1
F.2.	UTS 400 AND UTS 30 COMMUNICATION HANDLER DIFFERENCES	F-2
F.3.	UTS 40 AND UTS 30 COMMUNICATION HANDLER DIFFERENCES	F-3

G. TIMING CONSIDERATIONS

G.1.	NUL REQUIREMENTS	G-1
G.2.	EXECUTION TIMES	G-2
G.3.	DEFINITIONS	G-3

H. DEFAULT PARAMETERS**I. DEBUG MONITOR OPERATION**

I.1.	ACCESSING THE DEBUG MONITOR	I-1
I.2.	MONITOR DISPLAY	I-1
I.3.	MONITOR COMMANDS	I-2
I.4.	ERROR MESSAGES	I-4
I.4.1.	Error Descriptions	I-4
I.4.2.	Warning Descriptions	I-5

J. CONTROL PAGE

J.1.	CONTROL PAGE FORMAT	J-1
J.2.	INFORMATION FIELDS ON THE CONTROL PAGE	J-1
J.2.1.	The ADR— Field	J-1
J.2.2.	The SEARCH() Field	J-1
J.2.3.	The STA— Field	J-2
J.2.4.	The Special Code Field	J-3
J.2.5.	The MM Field	J-4
J.2.6.	Current Parameter Options Display	J-5
J.3.	OPERATIONAL CHARACTERISTICS: THE (PARAM) FIELD	J-5
J.4.	CONFIGURING PERIPHERAL DEVICES	J-10
J.5.	SPECIFYING PRINT AND TRANSFER OPERATIONS	J-11
J.5.1.	Peripheral Operations	J-11
J.5.2.	Format of Print and Transfer Operations	J-12
J.5.2.1.	PRNT() Field	J-12
J.5.2.2.	XFER() Field	J-13
J.5.2.3.	XMIT() Field	J-13

K. FIELD CONTROL CHARACTERS

K.1.	GENERATING FIELD CONTROL CHARACTERS	K-1
K.2.	FCC CODES	K-2
K.3.	TRANSMISSION OF EXPANDED FCCS	K-5

L. OPTIONAL CHARACTER SET

L.1. DEFINING THE DOT MATRIX L-1
 L.2. LOADING CHARACTERS FROM THE HOST
 TO THE UTS 30 L-1
 L.3. USING THE OPTIONAL CHARACTER SET L-5

M. ERROR LOG FORMAT

N. GRAPHICS

GLOSSARY

INDEX

USER COMMENT SHEET

FIGURES

1-1. UTS 30 System Configurations 1-5
 1-2. Typical UTS 30 System Configuration with Multiple Station Connections 1-7
 3-1. Example of UTS 30 Address Code Assignments 3-4
 3-2. Character Structure, Synchronous Transmission 3-5
 3-3. Example of BCC Parity Character Codes 3-6
 4-1. Text Message Format 4-1
 4-2. Cursor Address Sequence 4-6
 4-3. SO/SI-Protected Format — Screen Display 4-13
 4-4. SO/SI-Protected-Information Transfer from Host to UTS 30 4-13
 4-5. Format Using Both SO/SI-Protected and FCC Codes 4-13
 4-6. SO/SI-Protected and FCC Information Transfer 4-14
 5-1. Graphics Message Format 5-1
 5-2. Effects of Character Justification Operands 5-12
 B-1. ASCII-Based Code Conversion Chart B-2
 B-2. National Alphabet Selections — Character Locations on Code Charts B-3
 B-3. Special Emphasis Characters B-6
 B-4. Cursor Addressing for Screen Display B-10
 D-1. Power-On Confidence Test Display D-2
 E-1. Sample Display of Line Monitor Message Sequence E-3
 E-2. Explanation of Line Error Message Sequence E-4
 J-1. Control Page Format J-1
 J-2. Parameter Options Display J-5
 L-1. Example of Optional Character Definition and Addressing L-4
 M-1. Error Log Display M-1

TABLES

3-1.	Status Codes	3-11
4-1.	UTS 30 NUL Requirements	4-3
4-2.	Primary FCC M and N Bit Definitions	4-9
4-3.	Expanded FCC M and N Bit Definitions	4-10
5-1.	Valid Operands	5-13
A-1.	UTS 30 Peripheral Status Responses to Host Processor Messages	A-2
A-2.	UTS 30 Communication Control Sequences	A-7
B-1.	Text Message Format Codes	B-3
B-2.	Terminal Control Codes	B-4
B-3.	Cursor Position Codes	B-4
B-4.	FCC Codes	B-5
B-5.	Special Emphasis Sequence	B-5
B-6.	Special Emphasis ASCII Character Codes	B-5
B-7.	Editing Function Codes	B-6
B-8.	Displayable Character Codes	B-7
B-9.	Peripheral Control Codes	B-7
B-10.	Program Attention Key Codes	B-8
B-11.	Special User Program Attention Keys on the UTS 30 (Programmable Version)	B-9
B-12.	Cursor Addressing Codes for Screen Display	B-11
B-13.	Escape Code Summary	B-12
C-1.	ABA-Coded Character Set	C-3
C-2.	IATA-Coded Character Set	C-6
E-1.	Control Code Character Display	E-2
E-2.	Monitor Message Sequence Explanation	E-3
F-1.	UTS 30, UTS 40, and UTS 400 Error Log Formats	F-4
G-1.	UTS 30 NUL Fill Comparisons	G-1
G-2.	NUL Time-Fill Values	G-3
G-3.	UTS 30 Editing Function NUL Fill Formulas	G-4
H-1.	Default Parameters	H-1
I-1.	Debug Commands	I-3
J-1.	Peripheral Status Codes	J-2
J-2.	Maintenance Mode (MM) Field Entries	J-4
J-3.	Parameter Options	J-6
J-4.	Configuring Peripheral Devices — Entries in the First Subfield of the (PARAM) Field	J-10
J-5.	Entries in the "From" and "To" Subfields of the (**PRINT*) and (**XFER**) Fields	J-11
J-6.	Entries in the "Function" Subfield of the (**PRINT*) and (**XFER**) Fields	J-12
J-7.	Entries in the PRNT() Field	J-12
J-8.	Entries in the XFER() and XMIT() Fields	J-13

K-1.	UTS 30 Operator's Entries for Generating FCCs	K-1
K-2.	M in Primary FCC Sequence	K-2
K-3.	N in Primary FCC Sequence	K-3
K-4.	ASCII Characters Used as M in the Expanded FCC Sequence	K-3
K-5.	N in Expanded FCC Sequence	K-4
K-6.	Translation of Expanded FCCs to Primary FCCs	K-5
L-1.	Typical Use of the Character Dot Matrix	L-1
M-1.	Definition of Error Log Fields	M-2
N-1.	Host Commands to Define Graphics Display Modes	N-1
N-2.	Graphics Commands	N-2

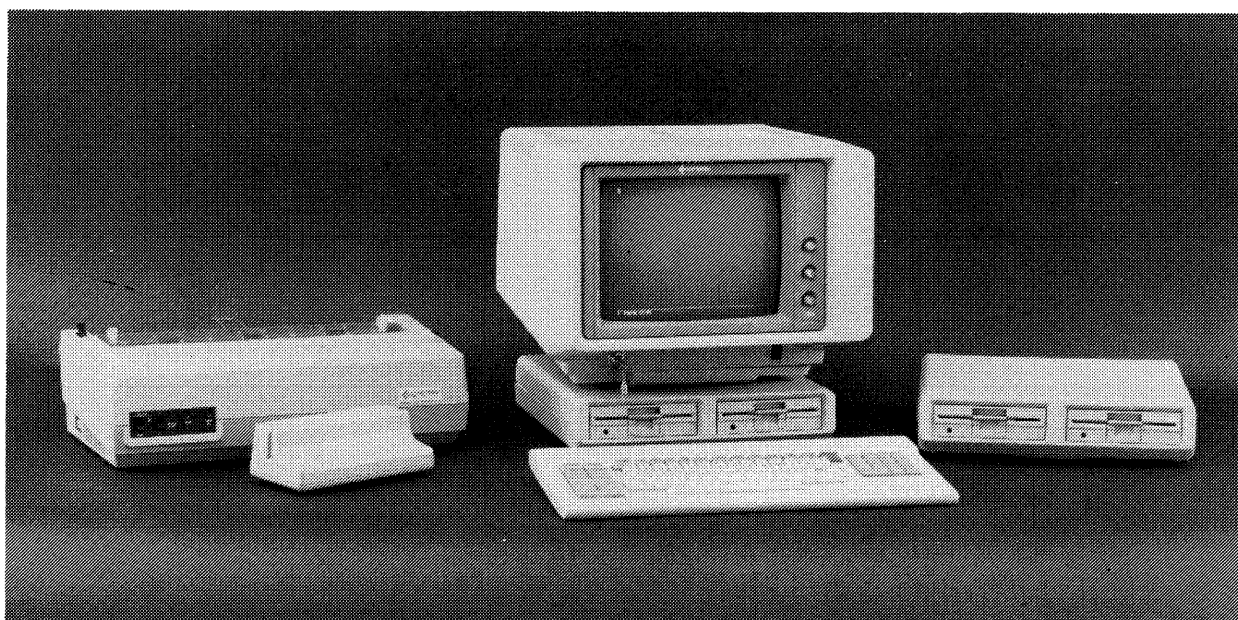

*SPERRY Universal Terminal System 30 (UTS 30)
(Programmable) and Peripheral Devices*

1. System Description

This section is an introduction to the UTS 30 and its components. More detailed information is available in the UTS 30 system description, UP-9796 (current version).

1.1. UNISCOPE MODE SYSTEM CONTROL SOFTWARE

The UNISCOPE-mode program for the basic UTS 30 is stored in a 64K-byte erasable, programmable, read-only memory (EPROM)-based cartridge that is inserted into the back of the terminal. The UNISCOPE-mode program for the programmable version is supplied on a system diskette and is accessible through a SPERRY 8439 Double-Sided Diskette Subsystem. The system control software is loaded into RAM when the terminal is turned on. The UNISCOPE-mode software enables the terminal to communicate with a host processor using the communications protocol of the SPERRY Universal Terminal System 4000 (UTS 4000). It also allows the UTS 30 to be used in a communication system with the SPERRY UTS 20 and UTS 40 Single Stations, and UNISCOPE 100 and 200 terminals.

The UTS 30 programmable version can operate offline using other system control software. The following software programs are supplied on diskettes and are accessible through the 8439 diskette subsystem:

- CP/M Plus™
- SPERRYLINK Office System

1.2. HOST INTERFACE

Interface to a host is through an EIA* RS-232-C or an X.21** synchronous communications interface that operates in half-duplex mode at line rates of up to 9600 bits per second (bps). The maximum distance for a direct connection between the host and a UTS 30 is 61.2 meters (200 feet).

CP/M Plus™ is a trademark of Digital Research, Inc.

** Electronic Industries Association*

***Specification of the International Telegraph and Telephone Consultative Committee (CCITT)*

1.3. PRINTER INTERFACE

On both versions, access to a printer is through an RS-232 asynchronous interface, which operates in simplex or full-duplex mode at line rates of up to 9600 bps. The UTS 30 supports the operation of the SPERRY Model 25B, Model 31, 0797, and 0798 Printer Subsystems.

1.4. DISKETTE CONTROLLER INTERFACE

The UTS 30 programmable version provides an SA 400 diskette controller interface to the diskette subsystem. The diskette feature and the UNISCOPE-mode program cartridge are mutually exclusive. When the diskette feature is installed, the UTS 30 is a totally programmable terminal. One or two 8439 diskette subsystems (a total of four diskette drives) can be connected to the UTS 30 at one time.

1.5. DISKETTE STORAGE

The 8439 diskette subsystem uses 5¼-inch, double-sided, double-density diskettes with a capacity of 737K bytes. The range of sector numbers is from 1 to 9 on each side. Data locations on double-sided diskettes and single-sided diskettes are not the same; therefore, single-sided diskette user programs cannot be used with double-sided media. The UTS 30 uses a sequential file format.

1.6. SCREEN

The screen size is variable: an operator or the host processor can change the screen format from a minimum of 1 character horizontally by 2 lines vertically to a maximum of 80 characters by 24 lines.

Characters entered by the host processor or from the keyboard are displayed at the cursor location. The cursor marks the position of the next character to be entered into display storage and also marks the last character of a message transmitted to the host processor or transferred to the printer. The UTS 30 has a 1024-character screen buffer.

1.7. ALTERNATE SCREEN

The UTS 30 has two screens; each is separately displayable and each has its own control page. (See Appendix J.) The host can call the contents of either screen memory by using its specific address. By sending data to the second screen, the host can communicate with peripherals without disturbing the operation of the displayed screen. Because the UTS 30 peripheral interfaces allow concurrent operation, the screen memory can be used to perform two simultaneous peripheral operations: an operator can initiate peripheral operation on one screen and return to the other to generate new data. See the UTS 30 operator's reference, UP-9798 (current version) for operating instructions.

1.8. CHARACTER SET MEMORY

The UTS 30 has a standard 256-character memory; space to store another 256 characters is an optional feature for the UTS 30 programmable version. Both memories are user definable.

The standard character set memory is loaded from the UNISCOPE mode system control software with the standard character set. The national variation is selected in the (PARAM) field on the control page (see Appendix J) or through the configuration utility. The optional character set memory is loaded from the host or from a diskette.

The standard character set memory is accessed through normal key operations; the optional character set memory is selected one character at a time by use of the FCTN and ; keys. Appendix L gives details of the dot matrix format, loading of characters to either the standard or the optional character memory, and using the optional characters.

1.9. USER PROGRAMMABILITY

The basic UTS 30 is designed to operate online to a host; its programmability is limited. The UTS 30 programmable version in UNISCOPE mode can operate online to a host or offline through the 8439 diskette subsystem. This version of the UTS 30 is completely programmable. An optional 128K RAM is also available for the programmable UTS 30. Program products are available on diskette to facilitate user programming.

1.10. PROGRAM PRODUCTS

These products are available on 5¼-inch diskettes. They are designed for the programmable UTS 30 equipped with at least one 8439 diskette subsystem. In addition to UNISCOPE mode, CP/M Plus and other program products are discussed in the following paragraphs.

1.10.1. CP/M Plus Operating Mode

CP/M Plus is a system control software program provided under license from Digital Research and modified for the special capabilities of the UTS 30. It provides a general environment for file construction and management, storage, and editing, together with assembly and program checkout facilities. The CP/M and UNISCOPE operating systems are mutually exclusive.

1.10.2. Character Set Generator Utility

This utility provides a way to create and modify character sets for the UTS 30. These character sets are stored on diskette and can be loaded into either the standard or optional character set memory on the programmable UTS 30. See Appendix L and the user guide for the character set generator, UP-9223 (current version).

1.10.3. Edit Processor Utility

This utility is a command-oriented facility for editing files. It allows optional access to three files that may or may not be on the same diskette — an input file, a work file, and an output file. The diskettes must first be file-formatted, using the diskette file utility (See 1.10.5 and the current version of the edit processor utility user guide, UP-8932.)

1.10.4. File Transfer Utility

This utility makes data transfer possible between a paired host application and a diskette or printer on the programmable UTS 30. The utility is transparent to the data being passed, but when it is used with the UNISCOPE mode host communication protocol, there are restrictions on the codes that may be passed. See the file transfer utility user guide, UP-9603 (current version).

1.10.5. Diskette File Utility

This utility provides diskette preparation, copying, and general diskette file maintenance functions for the UTS 30. See the diskette file utility user guide, UP-9826 (current version).

1.11. COMMUNICATION SYSTEMS

1.11.1. System Configurations

The UTS 30 can communicate with a host processor over the public telephone network, on a leased common-carrier voice grade line, or directly over a dedicated private communication line. As shown in Figure 1-1, communications can be used in point-to-point or multipoint configurations.

In a point-to-point configuration, a single UTS 30 operates over a direct connection to the host processor, or through a modem or a SPERRY 8610 Direct Connection Module (DCM) to the processor.

Several multipoint configurations are shown in Figure 1-1. For example, terminals can be connected to a communications line at a single interface point through a SPERRY 8609 Terminal Multiplexer, or they can be connected in a multidrop configuration (by means of modems or DCMs) on the same communications line. The maximum number of terminals that can be connected by means of a terminal multiplexer (or cascaded with several terminal multiplexers) depends on several factors, such as host processor software handling, requirements for high-speed communications, and message length.

As shown in Figure 1-2, a UTS 30 can also be intermixed with UNISCOPE 100/200, UTS 400, UTS 20, UTS 30, and UTS 40 terminals in a multidrop configuration on a single line.

1.11.2. Modem

A pair of synchronous modems can be connected between a single UTS 30 and the host processor or between multiplexed stations and the host processor. (See Figure 1-2.) A modem converts digital data to signals that can be transmitted over communication lines and vice versa.

1.11.3. Direct Connection Module (DCM)

The DCM provides a single connection between a UTS 30 (or a multiplexed terminal system) and the host processor. The maximum distance recommended for cabling is 1524 meters (5000 feet). As a limited-distance modem replacement, the DCM is designed for installations with a single power source and common power ground. See the terminal multiplexer and DCM general description, UP-9353 (current version), for information about the 8610 DCM.

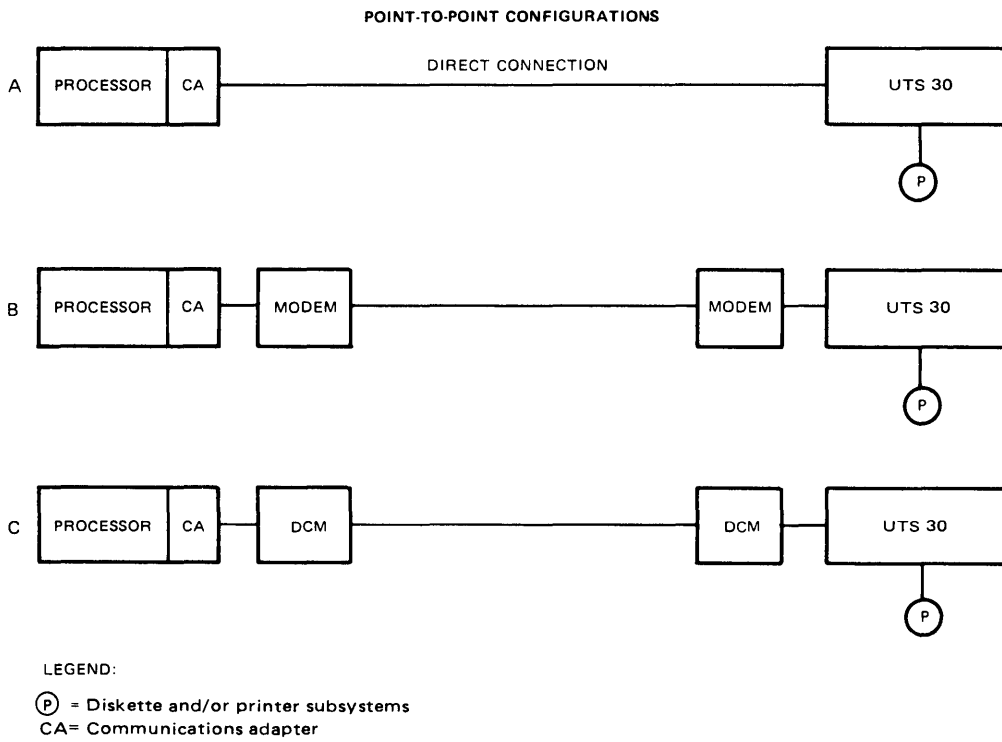

Figure 1-1. UTS 30 System Configuration (Part 1 of 2)

MULTIPOINT CONFIGURATIONS

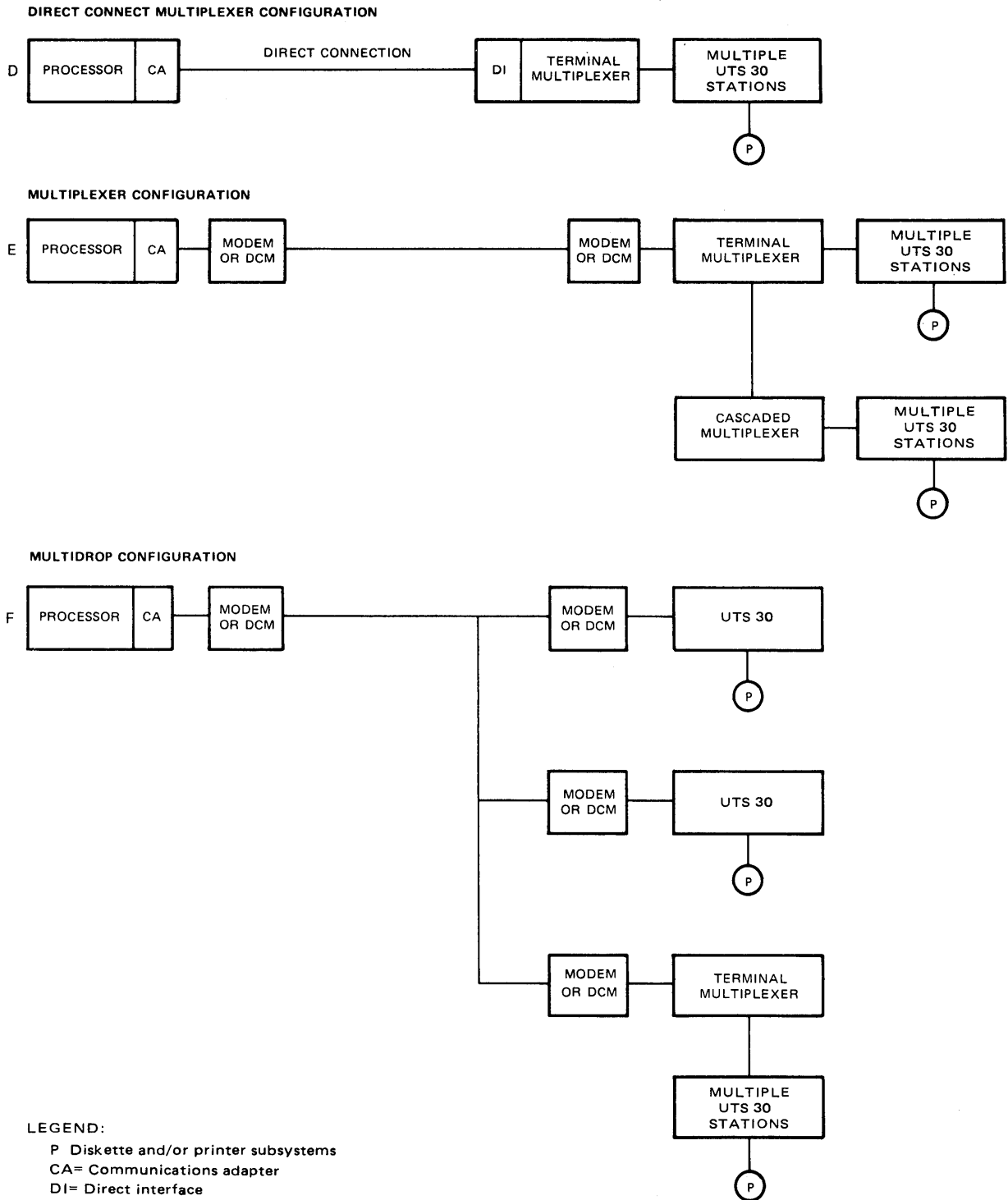

Figure 1-1. UTS 30 System Configurations (Part 2 of 2)

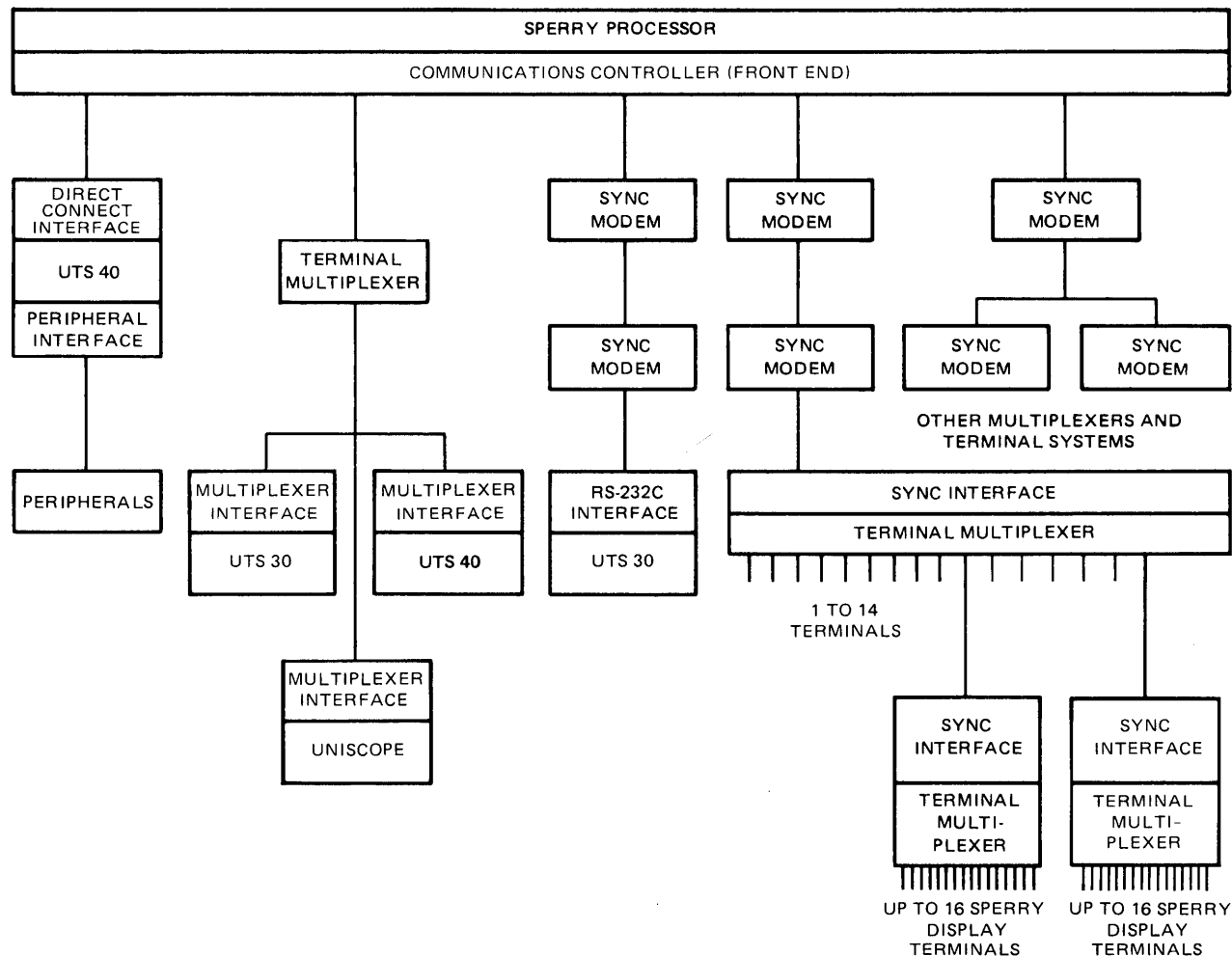

Figure 1-2. Typical UTS 30 System Configuration With Multiple Station Connections

1.11.4. Terminal Multiplexer

The 8609 terminal multiplexer provides connections for 16 terminals. When the system is cascaded, one connection is used for each terminal multiplexer.

The UTS 30 can be used with UTS 20, UTS 40, UTS 400, and UNISCOPE 100/200 terminals on the latest model terminal multiplexer (or earlier models updated to provide compatible timing characteristics).

Communication between a host processor and the terminal multiplexer can be by way of a direct-connection interface, a modem, or a DCM connection (Figure 1-2). The terminal multiplexer permits synchronous or asynchronous and half-duplex or full-duplex operation. See the terminal multiplexer and DCM general description, UP-9353 (current version), for information about the 8609 terminal multiplexer.

2. Functional Description

Functional characteristics of the UTS 30 are determined partly by instructions keyed into the control page and partly by user programs run on the terminal. This section is a brief description of UTS 30 terminal operating characteristics. More detailed information is available in the UTS 30 operator's reference, UP-9798 (current version).

2.1. TERMINAL READINESS AND RELIABILITY

Several functions built into the UTS 30 ensure the reliability of the equipment and assist in maintenance and failure analysis. These functions are explained in detail in the UTS 30 verification guide, UP-9804 (current version).

2.1.1. Power-On Confidence (POC) Test

The power-on confidence test is a series of internal diagnostic tests performed automatically when the unit is turned on. Only failed POC test results remain on the screen display. If the terminal passes all tests, the POC test display is erased. Refer to Appendix D for the POC test display.

If all POC tests are successful (and the terminal is unlocked), the terminal attempts to load the system control software, either from the program cartridge to the basic UTS 30, or from the diskette in the 8439 diskette subsystem to the programmable UTS 30.

If the system control software is successfully loaded, the alarm sounds once and the following message is displayed on screen line 23.

UNISCOPE MODE (FXXXX-XX)READY-RRRR-RR

where:

FXXXX-XX

is F3991-XX for the basic UTS 30 or F6708-XX for the programmable UTS 30, and -XX is the type number.

RRRR-RR

is the release number.

This message means the terminal is ready for operation.

If the graphics feature is not installed, the following message appears:

GRAPHICS INOPERATIVE

If loading was successful but the terminal is not configured, one of the following messages may be displayed in place of the READY message:

PARAMETERS DEFAULTED — CONFIGURE DEVICES & ENTER COMM. RI, SI, CM

COMMUNICATION RI OR SI PARAMETER IS INVALID

If loading was not successful, the following message will appear:

PROGRAM LOAD FAILURE — PRESS RESET

2.1.1.1. Parameters Defaulted or Communication Parameter Invalid

These messages indicate that the operating system is loaded but the terminal is unable to communicate with the host or peripherals and that configuration parameters must be checked. (See Appendix J.)

2.1.1.2. Program Load Failure

This message indicates the system control software is defective. If pressing the RESET PUSH button and reloading do not correct the problem, there may be a program cartridge, system diskette, or hardware failure.

2.1.2. Audible Alarm

The audible alarm signals both normal and error conditions. For conditions that activate the alarm, see the UTS 30 operator's reference, UP-9798.

2.1.3. Error Log

The error log is a record of errors related to communication messages, peripherals, and internal operations. Both the operator and host processor have access to this log. See Appendix M for the error log format and instructions on its use.

2.1.4. Line Monitor Function

The line monitor permits communications line activity to be displayed on the screen. The line monitor is useful for troubleshooting communications problems and analyzing communications protocol. Refer to Appendix E.

2.1.5. Error Recovery

Errors on the communications line result in retransmission of the data block. An error written to a peripheral results in a rewrite of the entire message in error, unless the peripheral is inoperable for some reason and the status indicates rewrite is not feasible. Memory parity errors are not retried.

2.1.6. Loopback Diagnostic Tests

The UTS 30 single station provides loopback diagnostic tests to test terminal multiplexer or data transfer lines. See the current version of the UTS 30 verification guide, UP-9804, for descriptions and operating instructions.

2.1.7. Maintenance and Reliability Operations

The following UTS 30 functions ensure reliability and maintainability of the system: cycle POC test, run POC test and load, dump RAM to diskette or printer, clear nonvolatile RAM, and screen display adjustment.

2.2. CONTROL PAGE

NOTE:

The control page and its functions are fully described in Appendix J.

The control page, a UNISCOPE mode characteristic, is a 2-line display used by the operator to control data transfer to and from the peripheral devices, to specify the type of transmission to the host, and to enter or change terminal characteristics. The selected parameters are stored in nonvolatile RAM in the terminal. See the UTS 30 operator's reference, UP-9798 (current version).

The host can call the control page to the screen and change the parameters (4.3.4). When the control page is displayed, the data on the two lines occupied by the control page is shifted to temporary storage, and then returned to display when the control page is removed from the screen.

2.3. CONFIGURATOR UTILITY

The configurator utility is a set of menus used to configure the system and to change operating characteristics (parameters). It is fully described in the UTS 30 operator's reference, UP-9798 (current version).

2.4. SCREEN CONTROL

The UTS 30 operator and host processor data exchange takes place by way of the UTS 30 display screen. Text characters from the host processor to the terminal are placed on the screen, and text characters from the terminal to the host processor are sent from the screen. Host processor text is also directed to or from a peripheral by way of the display screen. With the second screen capability, the host processor can send text to or receive text from a peripheral device without displaying the text. However, this text flow to and from the host processor is structured as though the text were going to and from a screen. Text to be sent from the UTS 30 to a peripheral device is also transferred by way of the display screen or the second screen.

Standard screen display formats used in UNISCOPE mode are:

<u>Total Lines (Rows)</u>	<u>Character Positions (Columns) Per Line</u>	<u>Total Character Positions</u>
12	80	960
16	64	1024
24	64	1526
24	80	1920

Characters received from the communications line, from the keyboard, or from the magnetic stripe reader or peripheral device are entered into UTS 30 display storage and then displayed on the screen. The character is placed on the screen at the cursor position and the cursor then advances one position. Each character position is uniquely addressable, as explained in 4.4.1.

The UTS 30 provides the host processor and the UTS 30 operator with five types of screen control:

- Field control characters (FCCs) — define fields on the screen and their display characteristics (4.4.2).
- SO/SI protection — provides an alternate way to prevent overwriting of selected data (4.4.3).
- Special emphasis characters — are nondestructive displayable characters (underscore, column separator, and strike-through) that can appear at the same screen address with a normal character (4.4.4).
- Editing functions — erase, insert, delete, line duplication and tabulation (4.4.5).
- Displayable control characters — the tab symbol (●), the start-of-entry symbol (▶), a blank space, and blinking start and end markers (◀ ▶). In addition, if the CC (control character) option in the (PARAM) field of the control page is selected, the cursor return (^CR), line feed (^LF), and form feed (^FF) control characters are displayed (4.4.6).

2.5. PROGRAM ATTENTION KEYS

Program attention keys are available for unique programming needs. Their functions are defined by the terminal programmer. On the basic UTS 30, these keys are MSG WAIT and the F1 through F22 keys; on the programmable UTS 30 there are seven additional keys. These keys and their codes are discussed in Appendix B.

2.6. COMMUNICATIONS ENVIRONMENT

2.6.1. Transmission Characteristics

Transmission between the UTS 30 and the host processor is bit-serial. The data transmission code used is based on standard 7-level American Standard Code for Information Interchange (ASCII) plus character parity. Communication operations are in synchronous mode only at speeds up to 9600 bits per second. The UTS 30 operates in half-duplex mode; however, a full-duplex communications line can be used.

2.6.2. Message Routing

Messages from the host processor are routed to a specific terminal by means of message addressing. The UTS 30 uses an identification system consisting of a remote identifier (RID), a station identifier (SID), and, for the diskette subsystem and printers, a device identifier (DID). The identification system codes use the hexadecimal representation of ASCII.

3. Communications Protocol

3.1. GENERAL

The UTS 30 communicates interactively with a host processor over a communications line. Interchange between the UTS 30 and the host consists of messages governed by a set of rules defining message sequence and format. The rules are summarized in Appendix A.

Throughout this section, message-exchange sequences are represented as follows:

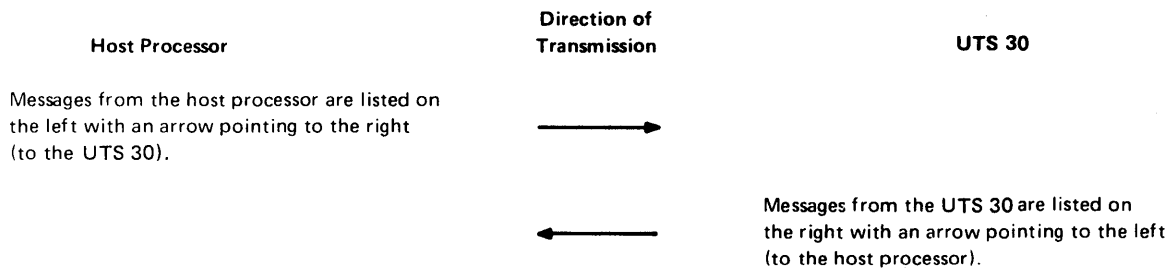

Required characters and acronyms appear in uppercase letters; terms representing variable information appear in lowercase letters.

3.1.1. Poll/Response Message Sequence

The basic element in the UTS 30 communications protocol is an error-free poll from the host processor. A poll is a message from the host that requests a response from the UTS 30. The UTS 30 can send a message to the host only when first polled by the host.

This is a simplified example of a complete communication message sequence between a host and the UTS 30.

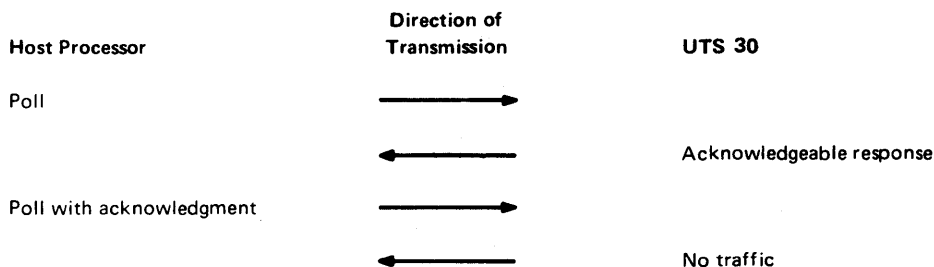

In this example, the poll solicits traffic from the UTS 30. The UTS 30 responds with a message conveying data, status, or a combination thereof. The host signifies proper receipt of the message from the station by including an acknowledgment in the next poll to that station. The station responds with a no-traffic message, indicating that it received the acknowledgment and has nothing further to send at this time.

3.1.2. Host Processor Text Message to UTS 30 — Message Sequence

After sending a text message to a UTS 30 single station, the host processor must always send a poll to verify that the station received the text message correctly. If the station response to the poll contains an acknowledgment, then the text message was received correctly by the station. If the station response to the poll does not contain an acknowledgment, then the station did not receive the host text message correctly.

The basic message sequence required to send text from the host processor to a UTS 30 station is as follows:

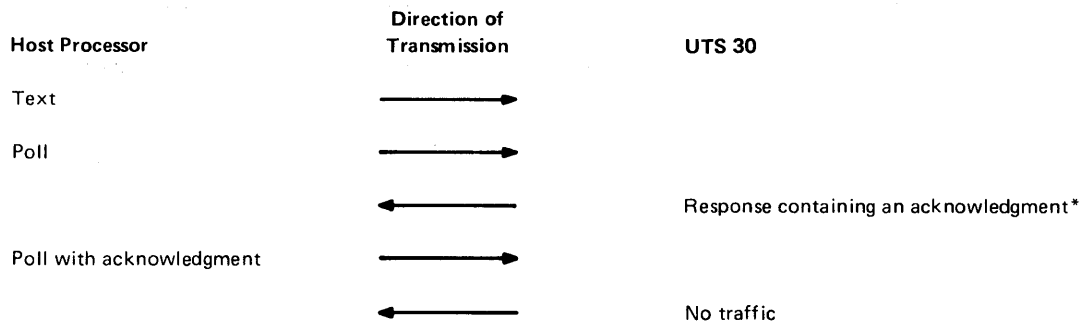

In the preceding message sequence, the host processor sends a text message to the UTS 30 single station and then polls to determine whether or not the text message was received correctly (that is, with good character and block parity). The station responds to the poll with an acknowledgment, indicating it received the text message correctly. The host processor then signifies proper receipt of the station acknowledgment in the next poll to that station. The station then responds with a no-traffic message, indicating that it received the acknowledgment and has nothing further to send.

3.2. STATION AND PERIPHERAL ADDRESSING

The host uses an addressing scheme to direct its messages to the proper UTS 30 or peripheral. This routing information uses a 3-number (hexadecimal) sequence consisting of a remote identifier (RID), a station identifier (SID), and a peripheral device identifier (DID). In addition, the host may address messages to all of the stations and peripherals on its communications line by using a general identifier (GID). The allowable address ranges are listed in 3.2.1.

Each communication line has a specific RID. Each display screen on each UTS 30 single station on a communications line has its own SID. Therefore, the address of a station is symbolized by a unique RID SID. (Note, however, that stations on different communications lines may have duplicate SIDs. It is the RID SID combination that must be unique.) Each peripheral assigned to a station has its own DID. Specific DIDs for peripheral selection are discussed in 3.8.

*Acknowledgments from the UTS 30 single station are defined in 3.4.3.

All messages (except no-traffic) contain the 3-hexadecimal number address, symbolized in the messages as RID SID DID, immediately following the start-of-header (SOH) character. (See 3.4 for communications control message formats.)

3.2.1. Operator Selection of Addresses

RID, SID, and DID addresses are selected by the operator through the control page or the configurator utility. See Appendix J and the operator's reference for the UTS 30, UP-9798 (current version). The address ranges are:

- RID — hexadecimal 21 through 7F
- SID — hexadecimal 21 through 7E
- DID — hexadecimal 20 through 7E

NOTES:

1. *Three numbers are reserved by the host for sending general messages. The GIDs are: SP (hexadecimal 20) is the general RID, P (hexadecimal 50) is the general SID, and p (hexadecimal 70) is the general DID.*
2. *The host may restrict the RID to 21 through 4F and the SID to 51 through 6F.*
3. *DIDs 70, 71, 72, and 7F should be avoided, as they have special host functions.*
4. *The number of DID selections in compatible UNISCOPE and UTS 400 display terminals is limited to 12: from hexadecimal 73 through 7E. To avoid confusion, the sample message sequences in this section will be restricted to DIDs in this range.*

3.2.2. Poll Groups

A poll group is defined as all stations on the communications line that recognize the RID and SID of a poll message. Each station in such a group will recognize a general RID as its own RID address and a general SID as its own SID address.

A poll containing a general RID, general SID, and general DID is called a general poll. Another form of a general poll is one containing a specific RID, general SID, and general DID. The general polls used in the examples in this section all contain a specific RID, general SID, and general DID. A poll containing a specific RID, specific SID, and general DID is called a specific poll.

Figure 3-1 illustrates two examples of poll groups that would respond to a general poll (specific RID, general SID, general DID) from the host. The terminal multiplexer group consisting of three UTS 30 stations defines a poll group with a common RID of "1." Note that the second screen associated with the UTS 30 has a SID designation of its own. A UTS 30 second screen with no other stations on the drop represents a poll group with a RID of "2." Each of these poll groups illustrated is connected on a multidrop line with each poll group representing a drop on the multidrop line.

All the stations in a poll group addressed by a general poll are candidates to furnish the response. A UTS 30 with a second screen behaves similarly to a terminal multiplexer (described in 3.6) in terms of determining priority of response between the station and the second screen memory.

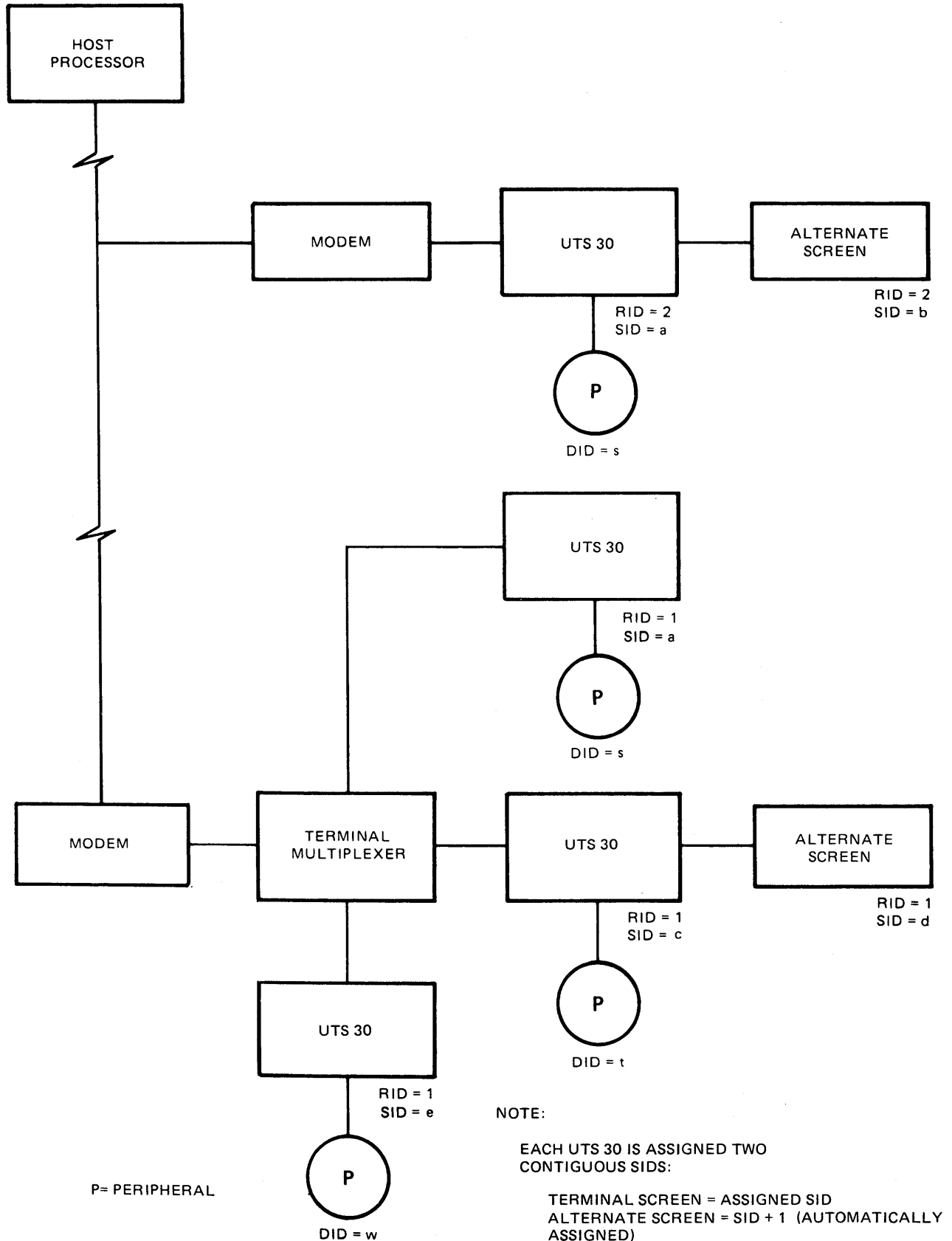

Figure 3-1. Example of UTS 30 Address Code Assignments

No two drops on a multidrop line can be members of the same poll group. Both drops would try to respond at once because there is no means to resolve the contention for the line. Note, however, that more than one poll group may be associated with a terminal multiplexer (if multiple RIDs are assigned), providing multiple poll groups at a physical drop.

3.3. PARITY CHECKING

The UTS 30 uses two forms of parity checking — character and block parity — to ensure data integrity on the communications line.

3.3.1. Character Parity

The character structure of data accepted by and sent from the UTS 30 conforms to American National Standard X3.16-1966.* Bit sequencing conforms to American National Standard X3.15-1966.** The character structure for synchronous data communication consists of eight bits: seven ASCII character bits plus one character parity bit, as shown in Figure 3-2.

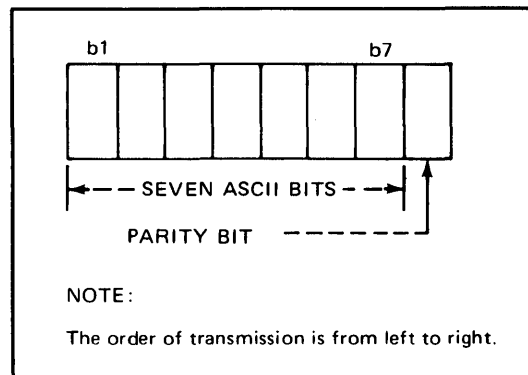

Figure 3-2. Character Structure, Synchronous Transmission

The bit sequence for transmission of an ASCII character is from the least significant bit (b1) to the most significant bit (b7), in terms of the ASCII** nomenclature, in ascending order.

When transmitting, the UTS 30 generates a parity bit and adds it to every 7-bit code transmitted. When receiving, the UTS 30 checks the character parity. The character parity for synchronous transmission is odd; that is, an odd number of 1 bits per character.

3.3.2. Block Parity

A longitudinal parity check, the block-check character (BCC), is sent at the end of every message, either from the host or from the UTS 40.

* Character Structure and Character Parity Sense for Serial-by-Bit Data Communications in the U.S.A. Standard Code for Information Interchange.

**Bit Sequencing of the U.S.A. Standard Code for Information Interchange in Serial-by-Bit Data Transmission

The UTS 40 accumulates a BCC on incoming messages from the host processor. To determine whether the message was transmitted correctly, the UTS 40 compares the BCC it generated with the BCC sent by the host at the end of its message. In like manner, the host compares the BCC at the end of an incoming UTS 40 message with the BCC it has generated on that message.

The BCC is accumulated on all characters from (but not including) SOH through (and including) ETX. All the intervening characters except SYN and NUL are included. The BCC always follows the ETX character; SYN characters must not be transmitted between ETX and BCC.

Generation of the BCC can be viewed in two ways. It is performed by taking the binary sum independently (without carry) on each of the seven levels (b1 through b7 in Figure 3-3) of the message. Alternatively, it is the result of performing exclusive-OR operations on each character of the message as it accumulates.

Message	b8 Character Parity	b7	b6	b5	b4	b3	b2	b1
SOH	0	0	0	0	0	0	0	1
5	1	0	1	1	0	1	0	1
h	0	1	1	0	1	0	0	0
p	0	1	1	1	0	0	0	0
STX	0	0	0	0	0	0	1	0
A	1	1	0	0	0	0	0	1
ETX	1	0	0	0	0	0	1	1
BCC	0	1	1	0	1	1	0	1

NOTES:

1. Counting for the BCC calculation begins after the SOH character.
2. The SYN character may be used as a time-fill character for synchronous transmission and must be excluded as part of the BCC calculation.
3. The character parity bit (b8) is added by hardware at the time of transmission, and is not included in BCC calculation.
4. This message is addressed to a terminal that has a RID of 5, a SID of h, and a DID of p.

9799.1-1

Figure 3-3. Example of BCC Parity Character Codes

Comparison of the incoming BCC and the receiver-generated BCC is performed the same way. Thus, since successful transmission results in identical BCCs, addition (without carry) or exclusive-OR operation forces the BCC check to be even.

The no-traffic response is a special case, as there is no SOH. For that response, the BCC accumulation corresponds to the ETX character, so that the format becomes:

EOT EOT ETX ETX

3.4. MESSAGE FORMATS

Except for the no-traffic poll response, all text and nontext messages, from the host or the UTS 30, begin with the start-of-header (SOH) character. The SOH marks the beginning of the address sequence.

On synchronous communications lines, the SOH character must be preceded by a minimum of four SYN characters. The SYN function is described in detail in Appendix A. SYN characters will not appear in the message examples in this section; their presence, if necessary, is understood.

All messages end with the end-of-text character (ETX) and then the block check character (BCC). The BCC character is described in 3.3.

3.4.1. Host Processor Poll Messages to the UTS 30

The host processor can send the following types of polls to the UTS 30:

- Status poll
- Traffic poll
- Selection poll
- Retransmission request

The format of a poll message is:

SOH RID SID DID control characters ETX BCC

NOTE:

The DLE control character changes the meaning of the control character immediately following it. DLE is therefore used to increase the number of available control characters; e.g., DLE ENQ and DLE EOT.

3.4.1.1. Status Poll (ENQ or DLE 1 ENQ)

A status poll solicits any nontext message the station has to send. ENQ is used to solicit status from a station without acknowledging a previous message. DLE 1 ENQ acknowledges a previous message and solicits status from the station. (DLE 1 ENQ can also be sent in reverse order: ENQ DLE 1.)

3.4.1.2. Traffic Poll (DLE 1)

A traffic poll solicits any message the station has to send, including text messages. The traffic poll can be specific or general. A specific traffic poll requests traffic from a particular station; a general traffic poll requests traffic from a poll group.

DLE 1 in the message indicates that the host is acknowledging a previous UTS 30 message. If there is no need for the host to acknowledge a response, no control characters are necessary.

3.4.1.3. Selection Poll

The selection poll has a specific RID, a specific SID, and a specific DID. Its primary purpose is to select a peripheral and obtain peripheral status. Peripheral selection is discussed in 3.8.3.

A selection poll that needs an acknowledgment will contain DLE 1; otherwise, a selection poll will not contain a control character.

3.4.1.4. Retransmission Request (DLE NAK)

The retransmission request has a specific RID, a specific SID, and a general DID. The retransmission request causes the UTS 30 to resend its last response and thus plays an important role in recovery from line errors. Line error recovery is discussed in 3.7.

The retransmission request from the host to the UTS 30 will contain the DLE NAK control character.

3.4.2. Host Processor Text Messages to the UTS 30

The host processor sends four kinds of messages to the UTS 30:

- Data messages
- Message waiting
- Disconnection
- Dump sequences

3.4.2.1. Data Messages (STX ---- ETX)

All text messages containing data are bracketed between the start-of-text (STX) and end-of-text characters. This is called the "message envelope." The content of data messages is the subject of Section 4.

The data message must be preceded by the addressing (routing) information discussed in 3.2. The format is:

SOH RID SID DID STX data ETX BCC

3.4.2.2. Message Waiting (BEL)

The BEL code turns on the MESSAGE WAITING message and the alarm of the UTS 30 identified by the RID and SID in the message.

SOH RID SID DID BEL STX (data) ETX BCC

3.4.2.3. Disconnection Message (DLE EOT)

SOH RID SID DID DLE EOT STX ETX BCC

Note that DLE used with EOT indicates line disconnection. The disconnection command is discussed in detail in 3.10.

3.4.2.4. Dump Sequences to Interrupt UTS 30 Activity

If the UTS 30 is in a pending transmit condition, the host can force the UTS 30 to accept an incoming host message by clearing the pending transmit condition and overwriting the data to be transmitted. Any host message containing STX will perform a dump transmit.

Similarly, the host can force the UTS 30 in a print condition to accept host text by clearing the print condition and overwriting the data to be printed. The dump print sequence is:

SOH RID SID DID NUL . (40 ms) . NUL STX

The specific DID in the dump print sequence must be either a "terminate" DID (ASCII q, hexadecimal 71) or a "deselect" DID (ASCII r, hexadecimal 72).

3.4.3. UTS 30 Messages to the Host Processor

All UTS 30 messages are sent in response to a poll and are categorized as follows:

- Reply request
- No traffic
- Acknowledgment
- Traffic (data)

The general format of the UTS 30-to-host message is:

SOH RID SID DID control characters STX ETX BCC

Note the difference in the use of the address. The host uses the address to correctly route its message to the UTS 30; the UTS 30 includes its address in a message to the host to identify the source of the message. Reply requests, no-traffic messages, and acknowledgments do not need an STX; only data messages need STX.

3.4.3.1. Reply Request (DLE ENQ)

The reply request is discussed in 3.7. Its format is:

SOH RID SID DID DLE ENQ ETX BCC

3.4.3.2. No Traffic (EOT)

If the UTS 30 has no other appropriate response to send, it will send a no-traffic response. (This is the only UTS 30 response that does not require an acknowledgment from the host processor.) The format is:

EOT EOT ETX BCC

In this case, the redundant form, EOT EOT, is used to increase reliability.

3.4.3.3. Acknowledgment (DLE 1 or DLE ?)

UNISCOPE mode protocol uses the DLE 1 code for acknowledgment. Note that it does not use the ASCII code ACK.

An acknowledgment from the UTS 30 will occur in one of two formats.

1. Text was received without error:

SOH RID SID DID DLE 1 ETX BCC

2. Text was received without error, but the requested peripheral device was busy:

SOH RID SID DID DLE ? ETX BCC

3.4.3.4. Traffic

The UTS 30 can respond to either general or specific polls with traffic. The traffic response may or may not carry a DLE 1 (acknowledge) or DLE? (busy) with it. The traffic response can be any one, but only one, of the following conditions:

- Text message (data) from a station screen when a transmit condition exists.
- Program attention key codes when one of the UTS 30 program attention keys has been pressed.
- Status of the station or of a peripheral sent as the result of a selection attempt.
- Disconnection message from a UTS 30 screen.

3.4.3.4.1. Text as Traffic

Text as traffic will be sent in one of two forms:

1. The standard UNISCOPE mode format that indicates acknowledgment (optional), start of text, text, and end of text. This format is used for all text messages less than 4096 bytes long.

SOH RID SID DID (DLE 1 or DLE?) STX data ETX BCC

2. A unique UTS 30 format that indicates acknowledgment (optional), start of text, text, and end-text-block (ETB) — more text is to come — before ETX. This format is used for consecutive text blocks where the message is longer than 4096 bytes. See 3.5.1 for more information concerning consecutive text sequences.

SOH RID SID DID (DLE 1 or DLE ?) STX data ETB ETX BCC

3.4.3.4.2. Program Attention Key Codes as Traffic

Program attention key codes are single ASCII characters. See Tables B-10 and B-11 for the ASCII codes and their hexadecimal equivalents. These messages are transmitted to the host when the operator presses the MSG WAIT key or one of the program attention keys. The format is:

SOH RID SID DID (DLE 1 or DL ?) key code ETX BCC

3.4.3.4.3. Status as Traffic

The status response is a pair of ASCII characters, the first character of which is always DLE. See Table 3-1 for the ASCII codes and their hexadecimal equivalents. Status responses are discussed in 3.8. The message format is:

SOH RID SID DID (DLE 1 or DLE ?) status ETX BCC

Table 3-1. Status Codes

Status	ASCII Characters	Hexadecimal Code
Peripheral status 1 (ready)	DLE >	10 3E
Peripheral status 2 (not ready)	DLE <	10 3C
Peripheral status 3 (error)	DLE :	10 3A
Peripheral status 4 (no response)	DLE =	10 3D
Message queued	DLE 4	10 34
Peripheral selection delayed	DLE 5	10 35
POC test completed	DLE 6	10 36
THRU (station through with peripheral interface)	DLE ,	10 3B
Text-available response to status poll	DLE 0	10 30

3.4.3.4.4. Disconnection Message as Traffic

The disconnection message is discussed in 3.10. The format is:

SOH RID SID DID DLE EOT ETX BCC

3.5. BASIC COMMUNICATIONS PROTOCOL FOR HOST PROCESSOR AND UTS 30

3.5.1. Rules for Basic Communications Between Host Processor and UTS 30

The following rules define the basic communications procedures between the host processor and the UTS 30. These rules are based on the assumption that no peripherals are involved, only one station in the poll group is being used, and the program attention keys are not being used.

■ **UTS 30 rule 1:**

The station responds only to error-free polls

■ **UTS 30 rule 2:**

The station expects an acknowledgment to any message it sends in response to a poll except the no-traffic message.

■ **UTS 30 rule 3:**

The station responds to a poll that includes an acknowledgment to a previous text message in one of two ways, depending on the message length:

1. When the total message length from the station exceeds 4096 bytes, a station will send consecutive text blocks until the transmission limit* of the screen is satisfied. Thus, the response to a poll with acknowledgment of the previous text block is to send a no-traffic message. (Except for the last text block in the sequence, the message format will include an ETB character indicating more data is to come.)
2. When the total message length from the station does not exceed 4096 bytes, a station will not send consecutive text blocks. Thus, the response to a poll with acknowledgment of the previous message is to send a no-traffic message.

■ **UTS 30 rule 4:**

The station acknowledges in its next poll response any error-free host processor message containing an STX (text message), message-wait, or disconnection command.

■ **Host processor rule 1:**

Upon sending a text message to a station, the host processor must poll to verify proper receipt of the text. This poll must occur before any other text is sent to that poll group. If the UTS 30 does not respond with an acknowledgment verifying proper receipt of the text, the host processor must resend the message.

■ **Host processor rule 2:**

The host processor must send a poll with acknowledgment to a station that has sent an acknowledgeable response before the host processor can send a text message to that station.

*Normally, a full-screen message will not exceed 4096 bytes; however, it is possible in UTS 30 operation, by use of each FCC position, to create a screen message that could be approximately 11,500 bytes in length and which would require consecutive block transmission to transmit the full screen.

3.5.2. Examples of UTS 30 Text Message Sequences

Example Sequence 1:

The following message sequence applies UTS 30 rules 1, 2, and 3 when the total message length is less than 4096 bytes.

In this sequence, it is assumed that the operator has pressed the transmit key on a station whose RID is "1" and SID is "a."

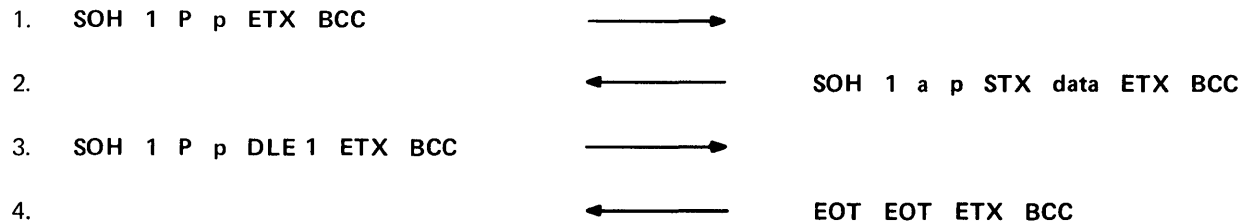

Explanation:

1. The host processor sends a general traffic poll to a poll group whose RID is "1."
2. The poll response is UTS 30 text from the station whose RID is "1" and SID is "a." (See UTS 30 rule 1.)
3. The host processor sends a general traffic poll with acknowledgment (DLE 1), signifying to the station that the host processor correctly received its text message; that is, the UTS 30 text message did not contain any characters with incorrect parity and the BCC in the UTS 30 text message matched the BCC accumulated by the host processor. (See UTS 30 rule 2.)
4. The station does not send consecutive message sequences when the message block is less than 4096 bytes; therefore, the response from the station must be a no-traffic message. (See UTS 30 rule 3.)

Example Sequence 2:

The following message sequence applies UTS 30 rules 1, 2, and 3 when the total message length is more than 4096 bytes.

In this sequence, it is assumed that the operator has pressed the transmit key on a station whose RID is "1" and SID is "a."

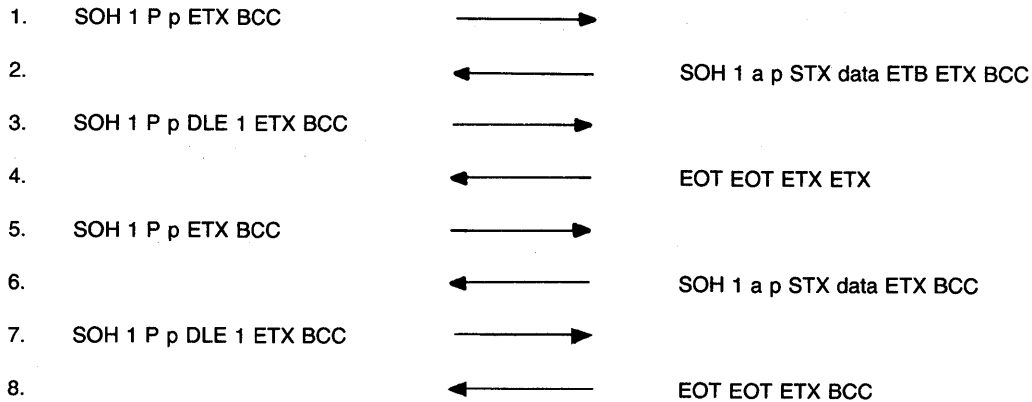

Explanation:

1. The host processor sends a general traffic poll to a poll group whose RID is "1."
2. The poll response is UTS 30 text (4096 bytes) from the station whose RID is "1" and SID is "a." The response from the station includes an ETB indicating more data is to come. (See UTS 30 rule 3.)
3. The host processor sends a general traffic poll with acknowledgment (DLE 1), signifying to the station that the host processor correctly received its text message; that is, the UTS 30 text message did not contain any characters with incorrect parity and the BCC in the UTS 30 text message matched the BCC accumulated by the host processor. (See UTS 30 rules 2 and 3.)
4. No traffic.
5. General traffic poll.
6. The UTS 30 whose RID is "1" and SID is "a" responds to the general traffic poll with acknowledgment by sending the remaining text in the message.
7. The host processor sends a general traffic poll with acknowledgment (DLE 1).
8. Since the message block is now complete, the response from the station must be a no-traffic message. (See UTS 30 rule 3.)

3.5.3. Example of Host Processor Text Message Sequence

The following message sequence applies UTS 30 rules 1, 2, and 4 and host processor rules 1 and 2.

- | | | | |
|----|----------------------------|--------|-------------------------|
| 1. | SOH 1 a p STX data ETX BCC | —————▶ | |
| 2. | SOH 1 P p ETX BCC | —————▶ | |
| 3. | | ◀————— | SOH 1 a p DLE 1 ETX BCC |
| 4. | SOH 1 a p DLE 1 ETX BCC | —————▶ | |
| 5. | | ◀————— | EOT EOT ETX BCC |

Explanation:

1. The host processor sends a text message to a station whose RID is "1" and SID is "a." This station must not be expecting an acknowledgment; that is, its previous poll response (assuming it is the only station being used in the poll group) would have been a no-traffic message.
2. The host processor sends a general traffic poll to verify that the station received the text message correctly. (See host processor rule 1.)
3. The acknowledgment (DLE 1) indicates that the station correctly received the text message from the host processor; that is, the text message contained no characters with incorrect parity and the BCC in the text message matched the BCC accumulated by the UTS 30. (See UTS 30 rule 4.)
4. The host processor must acknowledge any UTS 30 message other than a no-traffic message. (See host processor rule 2.)
5. The UTS 30 correctly received the poll-with-acknowledgment message from the host processor and responds with a no-traffic message.

3.6. MULTIPLEXER FUNCTION

A terminal multiplexer can determine which station in a poll group will respond to a poll. Similarly, a UTS 30 with second screen controls the response of the displayed screen and the second screen. (The second screen is considered a separately addressable station throughout this section.) The multiplexer function, therefore, refers to a multiplexer and UTS 30 control functions.

In a poll group, the UTS 30 multiplexer function can combine an acknowledgment from one station with any traffic response from another station. This process of combining responses is called "passing" the acknowledgment. See host processor rule 3.

The multiplexer function allows responses within the poll group to be sent in the following priority sequence:

1. A station that expected an acknowledgment but did not receive it is allowed to respond with a reply request.
2. If the priority 1 condition does not exist, a station with traffic is allowed to respond. The response may include an acknowledgment or busy response (DLE 1 or DLE ?) from that station, or a DLE 1/DLE ? passed from another station within that poll group, creating a composite message containing DLE 1 or DLE ? plus traffic.
3. If the priority 2 conditions do not exist, a station with an outstanding DLE 1 or DLE ? is allowed to respond.
4. If the priority 3 conditions do not exist, a station that has no traffic is allowed to respond to a host processor poll.

3.6.1. Rules for Handling Messages Modified by the Multiplexer Function

The following rules define the message flow for communication between the host processor and the UTS 30 as modified by the multiplexer function of a terminal multiplexer or a UTS 30 with a second screen.

■ Host processor rule 3:

When using general polls, the host processor must expect an acknowledgment (DLE 1 or DLE ?) from one station to be included with a response from another station in the poll group. The multiplexer function allows an acknowledgment to be passed from one station to another station that has a traffic response pending.

■ Host processor rule 4:

When using general polls, the host processor must expect successive traffic responses from stations within a poll group. However, UTS 30 rule 3 still applies. The multiplexer function allows a station with a message pending to send its response to any poll with an address it recognizes.

■ Host processor rule 5:

The host processor can send text to any station in the poll group that is not owed an acknowledgment, provided the last response from the poll group is not one of the following:

- DLE 1 only (SOH RID SID DID DLE 1 ETX BCC)
- DLE ? only (SOH RID SID DID DLE ? ETX BCC)
- DLE 1 plus text available (SOH RID SID DID DLE 1 DLE 0 ETX BCC)
- DLE ? plus text available (SOH RID SID DID DLE ? DLE 0 ETX BCC)

■ **Host processor rule 6:**

When the host processor owes an acknowledgment to a station in a poll group, the host processor may send a specific poll to the poll group only if the specific poll is addressed to the station that is owed the acknowledgment.

■ **Host processor rule 7:**

The host processor must not allow a given poll group to owe more than one acknowledgment to the host processor at any time.

3.6.2. Examples of Message Sequences Involving the Multiplexer Function

Example Sequence 1:

The following message sequence applies the multiplexer function definitions and host processor rules 3, 4, 5, and 7. Rule 6 is indirectly applied in the following sequence, because the host always sends an acknowledgment before text is solicited.

In this sequence, it is assumed that the poll group defined by the multiplexer group shown in Figure 3-1 is being used.

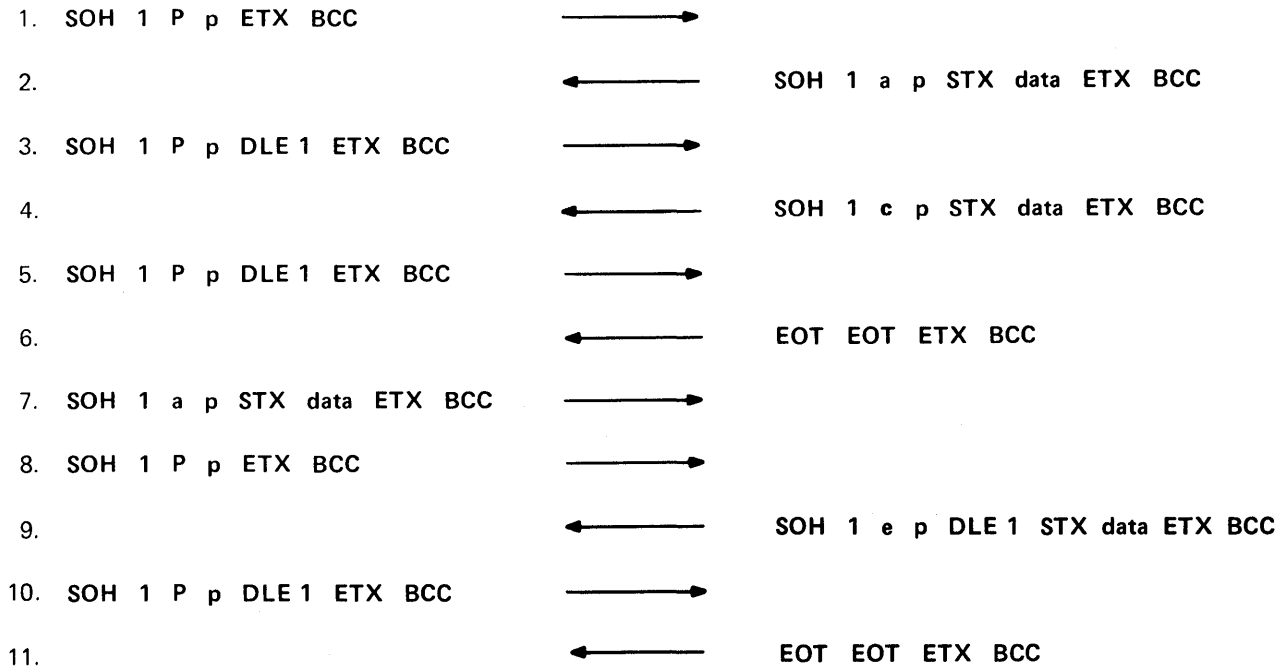

Explanation:

1. General traffic poll to the poll group whose RID is "1."
2. UTS 30 text from the station whose RID is "1" and SID is "a."
3. General traffic poll with acknowledgment.

4. UTS 30 text from the station whose RID is "1" and SID is "b." (See host processor rule 4.)
5. General traffic poll with acknowledgment.
6. No traffic.
7. Host processor text to the station whose RID is "1" and SID is "a."
8. General traffic poll.
9. Acknowledgment plus traffic where the traffic is text. The text is from the station whose RID is "1" and SID is "c." The acknowledgment was passed by the multiplexer from the station whose RID is "1" and SID is "a." (See host processor rule 3.)
10. General traffic poll with acknowledgment.
11. No traffic.

Example Sequence 2:

The following message sequence applies the multiplexer function definitions and host processor rules 3 through 7. In this sequence, it is assumed that the poll group used is the multiplexer group shown in Figure 3-1.

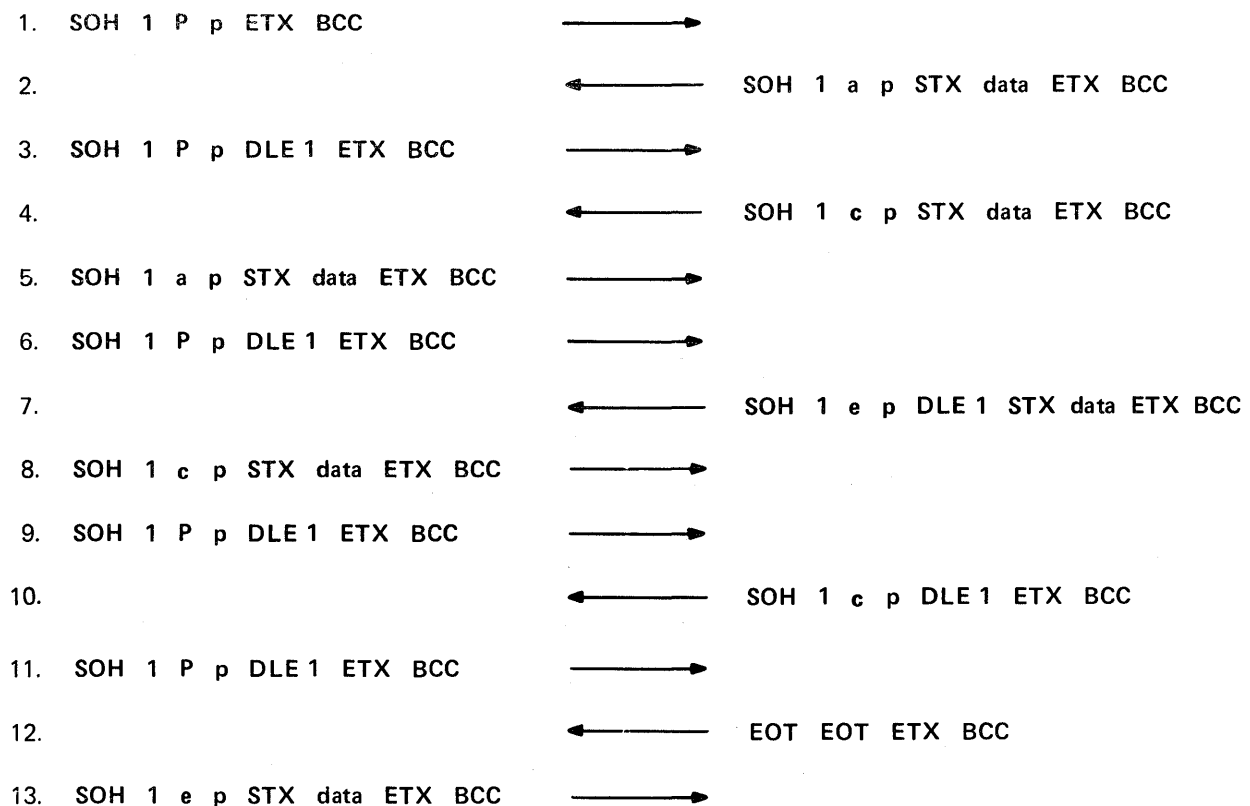

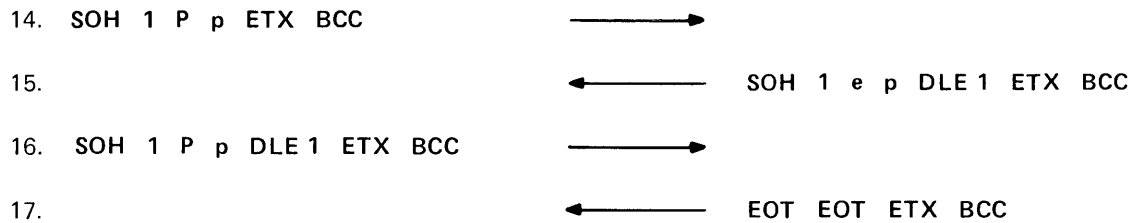

Explanation:

1. General traffic poll to the poll group whose RID is "1."
2. UTS 30 text from the station whose RID is "1" and SID is "b."
3. General traffic poll with acknowledgment.
4. UTS 30 text from the station whose RID is "1" and SID is "b."
5. Host processor text to the station whose RID is "1" and SID is "a." (See host processor rule 5.)
6. General traffic poll with acknowledgment.
7. Acknowledgment plus traffic where the traffic is text. The text is from the station whose RID is "1" and SID is "c." The acknowledgment was passed by the multiplexer from the station whose RID is "1" and SID is "a." (See host processor rule 3.)
8. Host processor text to the station whose RID is "1" and SID is "c." (See host processor rule 5.)
9. General traffic poll with acknowledgment.
10. Acknowledgment from the station whose RID is "1" and SID is "c."
11. General traffic poll with acknowledgment. Text cannot be sent to the poll group at this point because the last response from the poll group was acknowledgment (DLE 1). (See host processor rule 5.)
12. No traffic.
13. Host processor text to the station whose RID is "1" and SID is "e." (See host processor rule 5.)
14. General traffic poll.
15. Acknowledgment from the station whose RID is "1" and SID is "e."
16. General traffic poll with acknowledgment.
17. No traffic.

3.7. COMMUNICATIONS LINE ERROR RECOVERY

3.7.1. Rules for Line Error Recovery

Transmission errors may occur in messages to and from the UTS 30. The following rules define the line error recovery procedures to be followed in communication between the host processor and the UTS 30. Note that a text message received in error will be displayed on the UTS 30 screen, but the terminal will not respond to the text message.

■ **UTS 30 rule 5:**

If a station that is owed an acknowledgment does not receive an acknowledgment in the next good poll that it recognizes, the station sends a reply request (DLE ENQ) message.

■ **UTS 30 rule 6:**

A station will not send an acknowledgment (DLE 1 or DLE ?) with a reply request. A station having a reply request can be passed an acknowledgment because of the multiplexer function. However, that acknowledgment will not be reported until the reply request condition is satisfied.

■ **UTS 30 rule 7:**

The specific DID in any host processor message causes a selection attempt only if the message is error free.

■ **Host processor rule 8:**

The host processor must treat any error in a received message as a no-response condition and must repeat the poll that preceded the no-response condition. However, any acknowledgment included with the original poll must be eliminated and a general DID must be used when the poll is repeated. If the no-response condition results from a retransmission request (DLE NAK), the host processor must repeat the poll that created the reply request response.

■ **Host processor rule 9:**

The host processor response to a reply request (DLE ENQ) from a station must be a retransmission request (DLE NAK) if the last message correctly received from the station sending the reply request was one that did not contain text data. The retransmission request has the same specific SID address as that contained in the reply request. The retransmission request must contain a general DID.

■ **Host processor rule 10:**

The host processor response to a reply request (DLE ENQ) from a station must be a poll-with-acknowledgment message if the last message correctly received from the station that sent the reply request was a message whose traffic was text. The acknowledgment is for the message that preceded the reply request and not for the reply request message itself.

■ **Host processor rule 11:**

The host processor response to a reply request (DLE ENQ) from a station must be a retransmission request (DLE NAK) if the station sending the reply request is other than one to which an acknowledgment has just been sent.

■ **Host processor rule 12:**

If the response from a retransmission request is identical to the UTS 30 response sent just before the retransmission request and is from the same station, then the response to the retransmission request can be ignored except for sending the expected acknowledgment. However, the same UTS 30 response is to be ignored only once.

3.7.2. Example of Line Error Message Sequence Involving Polls

The following message sequence applies host processor rule 8.

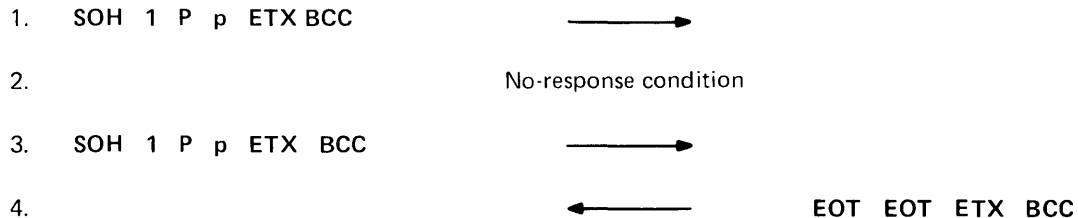

Explanation:

1. General traffic poll.
2. No-response condition indicates transmission error occurred on poll or response.
3. The general traffic poll sent in step 1 is repeated. (See host processor rule 8.)
4. No-traffic response. Error recovery was successful.

3.7.3. Examples of Line Error Message Sequences Involving UTS 30 Text

The following message applies UTS 30 rule 5 and host processor rules 8 and 9.

Example Sequence 1:

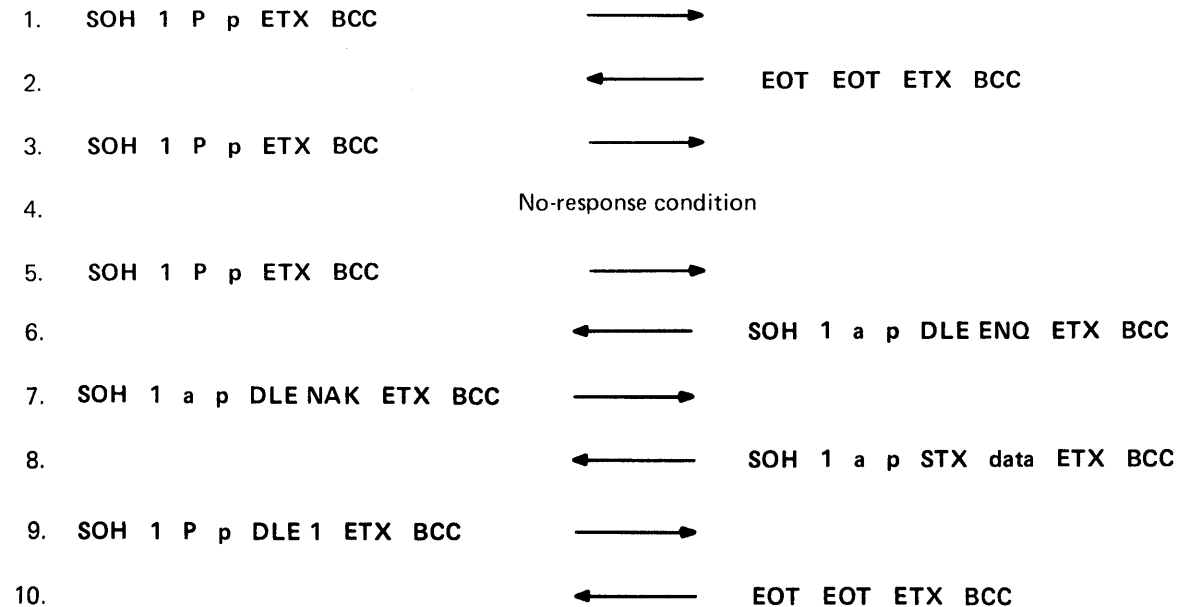

Explanation:

1. General traffic poll.
2. No-traffic response.
3. General traffic poll.
4. No-response condition indicates transmission error occurred on poll or response.
5. General traffic poll is repeated. (See host processor rule 8.)
6. Reply request from the station whose RID is "1" and SID is "a." (See UTS 30 rule 5.)
7. Retransmission request sent to the station that sent the reply request in step 6. Host processor rule 9 applies because the UTS 30 message (step 2) preceding the reply request did not contain text data.
8. UTS 30 text from the station whose RID is "1" and SID is "b."
9. General traffic poll with acknowledgment.
10. No traffic.

Example Sequence 2:

The following message sequence applies UTS 30 rule 5 and host processor rules 8, 9, and 10.

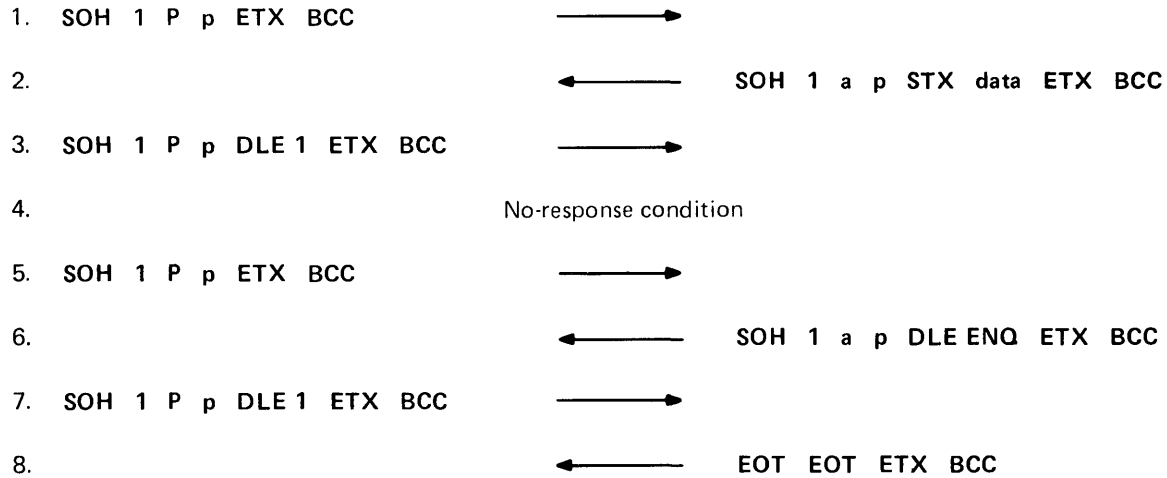

Explanation:

1. General traffic poll.
2. UTS 30 text from the station whose RID is "1" and SID is "a."
3. General traffic poll with acknowledgment.
4. No-response condition indicates transmission error occurred on poll or response.
5. General traffic poll is repeated. (See host processor rule 8.)
6. Reply request from the station whose RID is "1" and SID is "a." (See UTS 30 rule 5.)
7. A general traffic poll with acknowledgment is sent to the same station that just sent the reply request. (See host processor rules 9 and 10.)
8. No-traffic response. Error recovery was successful.

Example Sequence 3:

The following message sequence applies UTS 30 rule 5 and host processor rules 8 and 11.

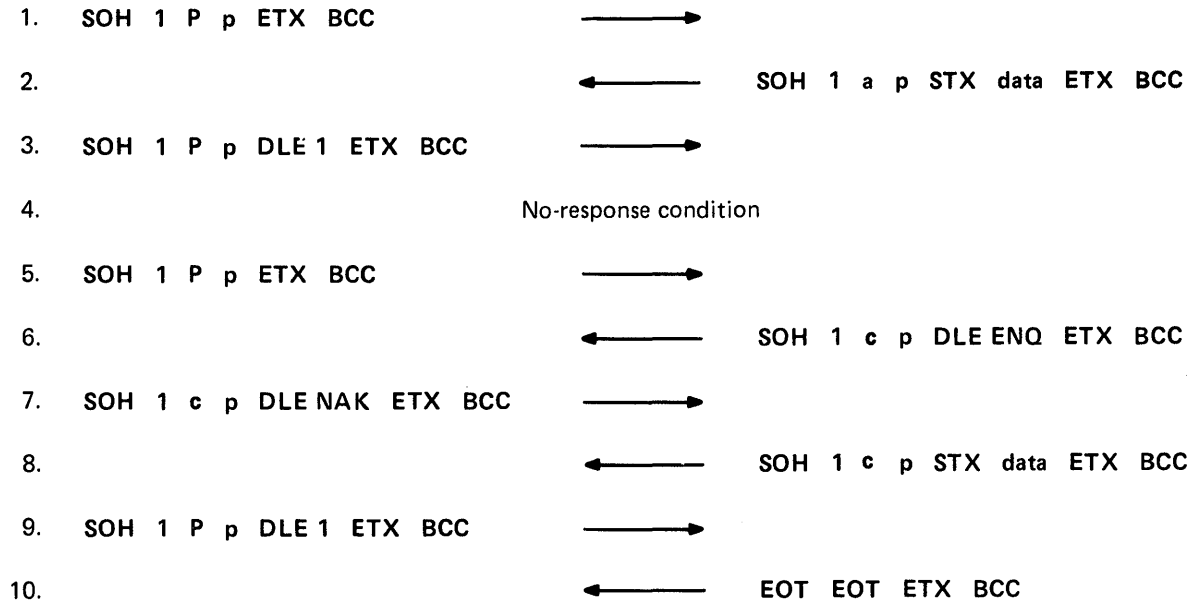

Explanation:

1. General traffic poll.
2. UTS 30 text from the station whose RID is "1" and SID is "a."
3. General traffic poll with acknowledgment.
4. No-response condition indicates transmission error occurred on the poll or response.
5. General traffic poll is repeated. (See host processor rule 8.)
6. Reply request from the station whose RID is "1" and SID is "c." (See UTS 30 rule 5.)
7. A retransmission request must be sent as described in host processor rule 11.
8. UTS 30 text from the station whose RID is "1" and SID is "c."
9. General traffic poll with acknowledgment.
10. No traffic.

3.7.4. Examples of Line Error Message Sequences Involving Host Processor Text

Example Sequence 1:

The following message sequence applies UTS 30 rule 4 and host processor rule 5.

- | | | | |
|----|----------------------------|---|-------------------------|
| 1. | SOH 1 a p STX data ETX BCC | → | |
| 2. | SOH 1 P p ETX BCC | → | |
| 3. | | ← | EOT EOT ETX BCC |
| 4. | SOH 1 a p STX data ETX BCC | → | |
| 5. | SOH 1 P p ETX BCC | → | |
| 6. | | ← | SOH 1 a p DLE 1 ETX BCC |
| 7. | SOH 1 P p DLE 1 ETX BCC | → | |
| 8. | | ← | EOT EOT ETX BCC |

Explanation:

1. Host processor text to the station whose RID is "1" and SID is "a."
2. General traffic poll.
3. The no-traffic response indicates either that the host processor text message sent in step 1 was not error free when it arrived at the UTS 30 or that the station was not connected and another station in the poll group furnished the no-traffic response. The host processor must resend this text message. (See UTS 30 rule 4.)
4. The host processor text message in step 1 is resent. (See host processor rule 5.)
5. General traffic poll.
6. The acknowledgment indicates that the host processor text sent in step 4 was received error free. (See UTS 30 rule 4.)
7. General traffic poll with acknowledgment.
8. No traffic.

Example Sequence 2:

The following message sequence applies UTS 30 rule 4 and host processor rules 1 and 5.

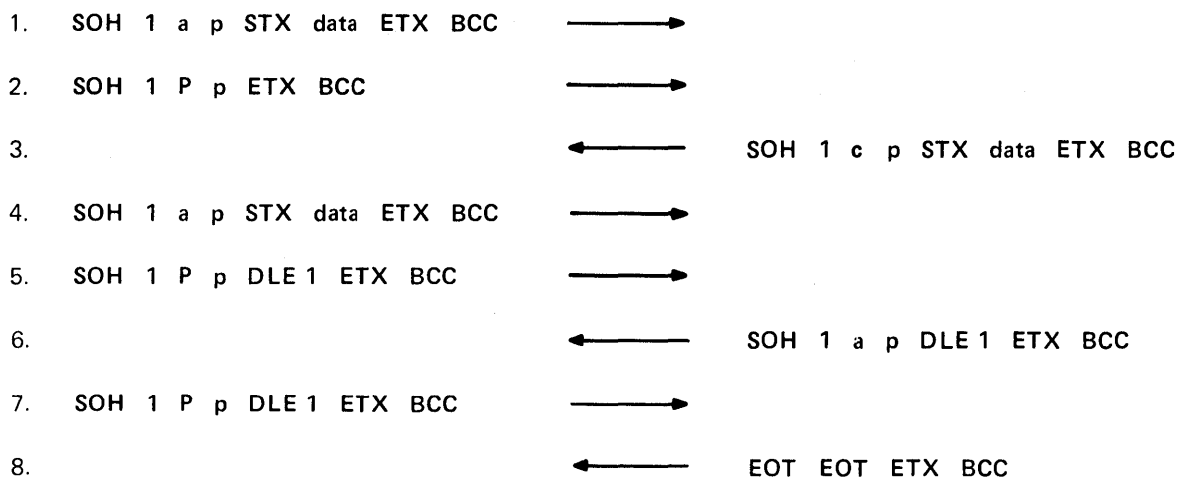

Explanation:

1. Host processor text to the station whose RID is "1" and SID is "a."
2. General traffic poll.
3. The absence of an acknowledgment in the station response indicates either that the host processor text message in step 1 was not error free when it arrived at the UTS 30 or that the station was not connected. (See UTS 30 rule 4.)
4. The host processor must resend the text message sent in step 1. (See host processor rule 1.) Because no acknowledgment was received for the text message in step 1, the host processor may retransmit the message to station "a." (See host processor rule 5.)
5. General traffic poll with acknowledgment.
6. The acknowledgment indicates that the host processor text sent in step 4 was received error free. (See UTS 30 rule 4.)
7. General traffic poll with acknowledgment.
8. No traffic.

Example Sequence 3:

The following message sequence applies UTS 30 rule 5 and host processor rules 8, 9, and 12.

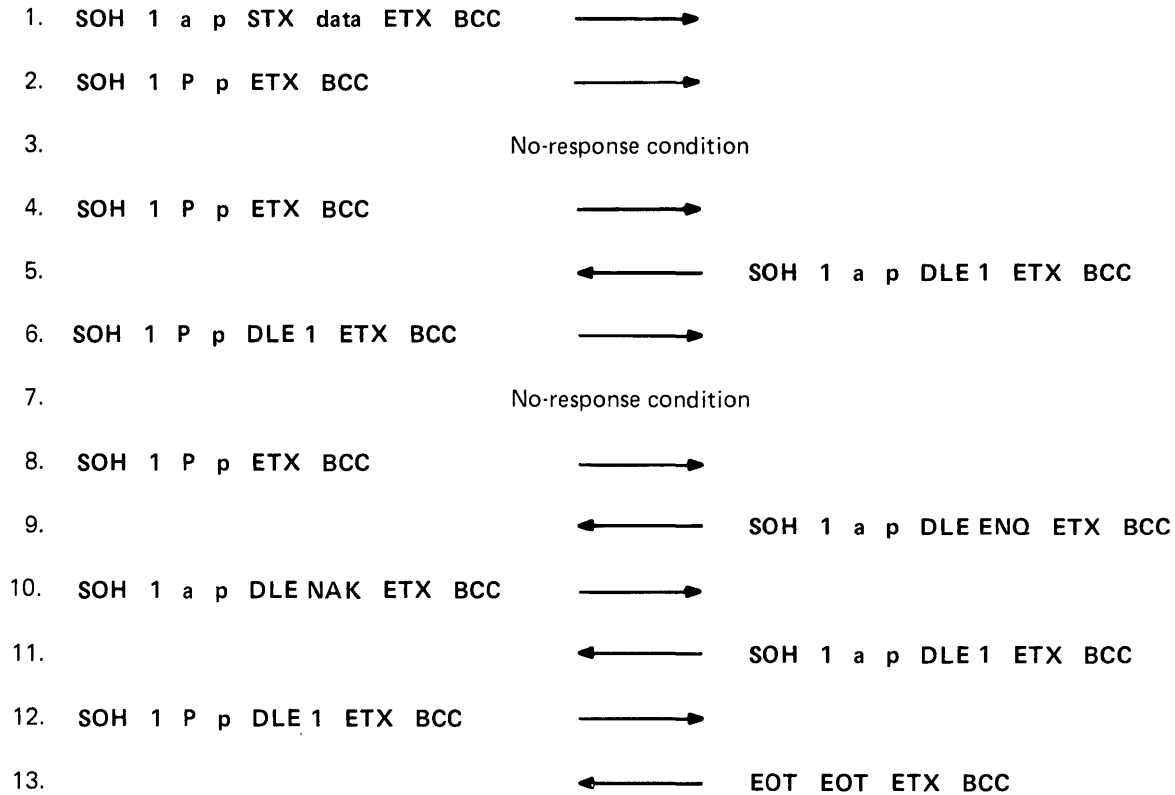

Explanation:

1. Host processor text to the station whose RID is "1" and SID is "a."
2. General traffic poll.
3. No-response condition indicates transmission error occurred on poll or response.
4. General traffic poll is repeated.
5. Acknowledgment from the station that was sent text in step 1.
6. General traffic poll with acknowledgment.
7. No-response condition indicates transmission error occurred on poll or response.
8. The poll in step 6 is repeated without the acknowledgment (DLE 1). (See host processor rule 8.)
9. Reply request (DLE ENQ) from the station whose RID is "1" and SID is "a."

10. Retransmission request (DLE NAK) to the station that sent the reply request in step 9. Host processor rule 9 applies because the UTS 30 message (step 5) sent before the reply request did not include text data.
11. This acknowledgment is extraneous, as described in host processor rule 12. It is a repeat of the acknowledgment successfully received in step 5.
12. General traffic poll with acknowledgment.
13. No traffic.

Example Sequence 4:

The following message sequence applies UTS 30 rule 5 and host processor rules 8 and 9.

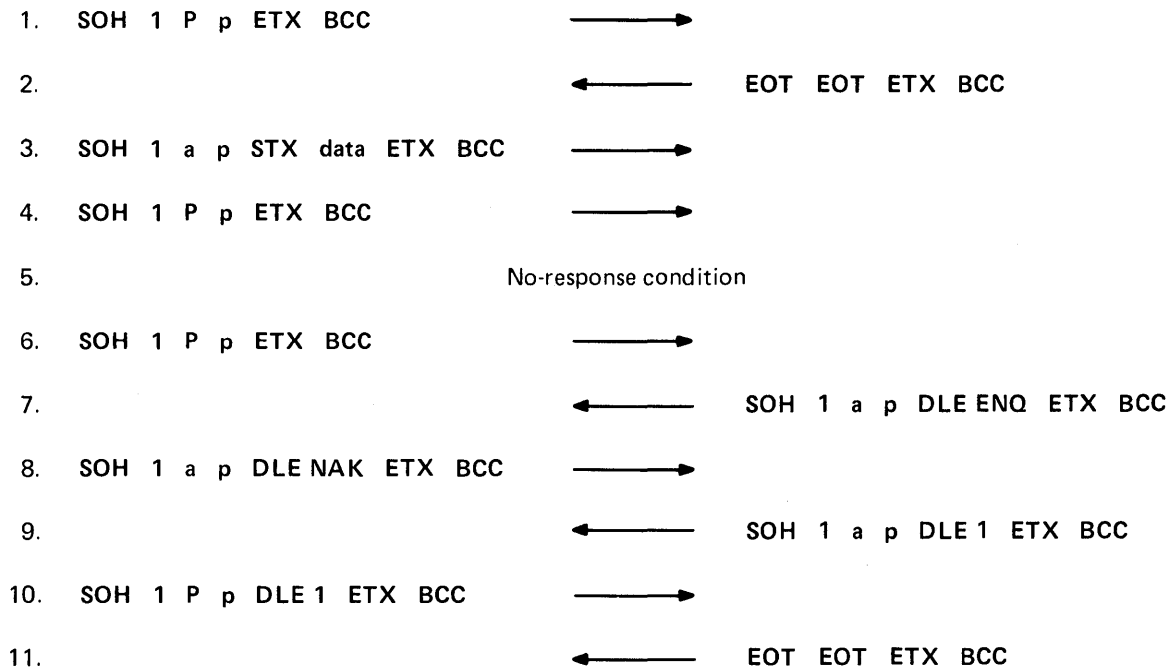

Explanation:

1. General traffic poll.
2. No-traffic response.
3. Host processor text to the station whose RID is "1" and SID is "a."
4. General traffic poll.
5. No-response condition indicates transmission error occurred on poll or response.
6. General traffic poll is repeated.
7. Reply request (DLE ENQ) from the station whose RID is "1" and SID is "a."

8. Retransmission request (DLE NAK) to the station that sent the reply request in step 7. Host processor rule 9 applies because the UTS 30 message (step 2) sent before the reply request did not include text data.
9. This acknowledgment is a retransmission of the UTS 30 message that was not error free in step 5.
10. General traffic poll with acknowledgment.
11. No traffic.

Example Sequence 5:

The following message sequence applies UTS 30 rule 5 and host processor rules 5, 8, and 11.

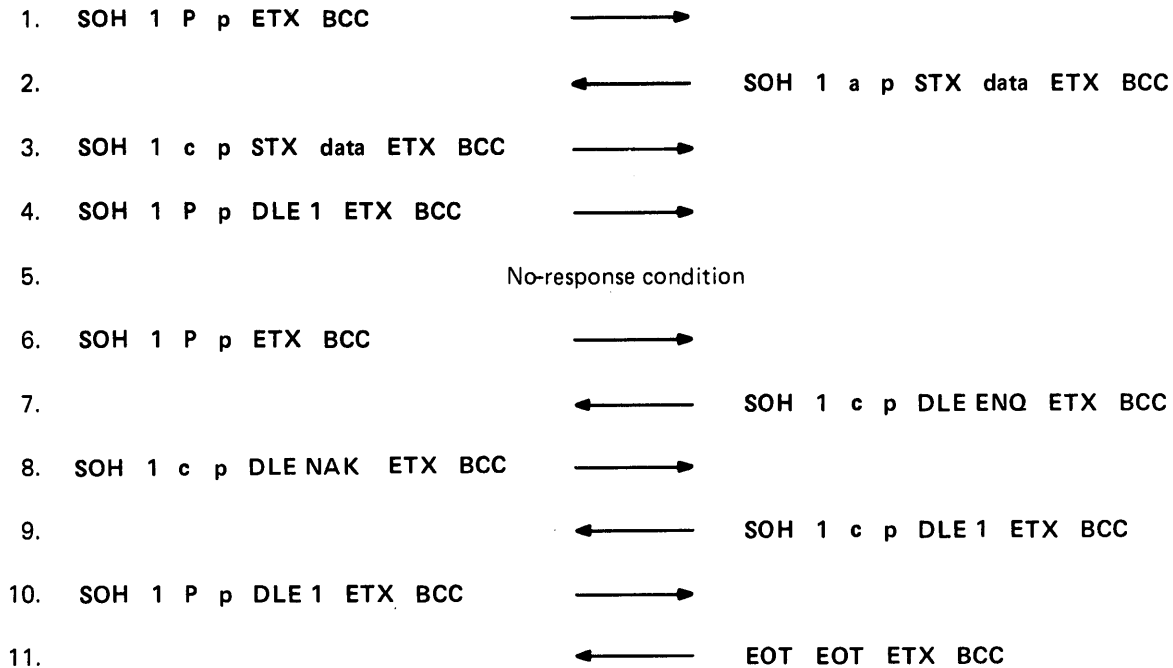

Explanation:

1. General traffic poll.
2. UTS 30 text message from the station whose RID is "1" and SID is "a."
3. Host processor text directed to the station whose RID is "1" and SID is "c." (See host processor rule 5.)
4. General traffic poll with acknowledgment.
5. No-response condition indicates transmission error occurred on poll or response.
6. General traffic poll is repeated. (See host processor rule 8.)
7. Reply request from the station whose RID is "1" and SID is "c." (See UTS 30 rule 5.)

8. Retransmission request to the station that sent the reply request in step 7. Host processor rule 11 applies because an acknowledgment was just sent for the station whose RID is "1" and SID is "a" (steps 2 and 4), but the reply request was from the station whose RID is "1" and SID is "c."
9. Acknowledgment for the text message in step 3.
10. General poll with acknowledgment.
11. No traffic.

3.7.5. Examples of Line Error Message Sequences Involving Passing the Acknowledgment

Example Sequence 1:

The following message sequence applies UTS 30 rule 5 and host processor rules 8 and 9.

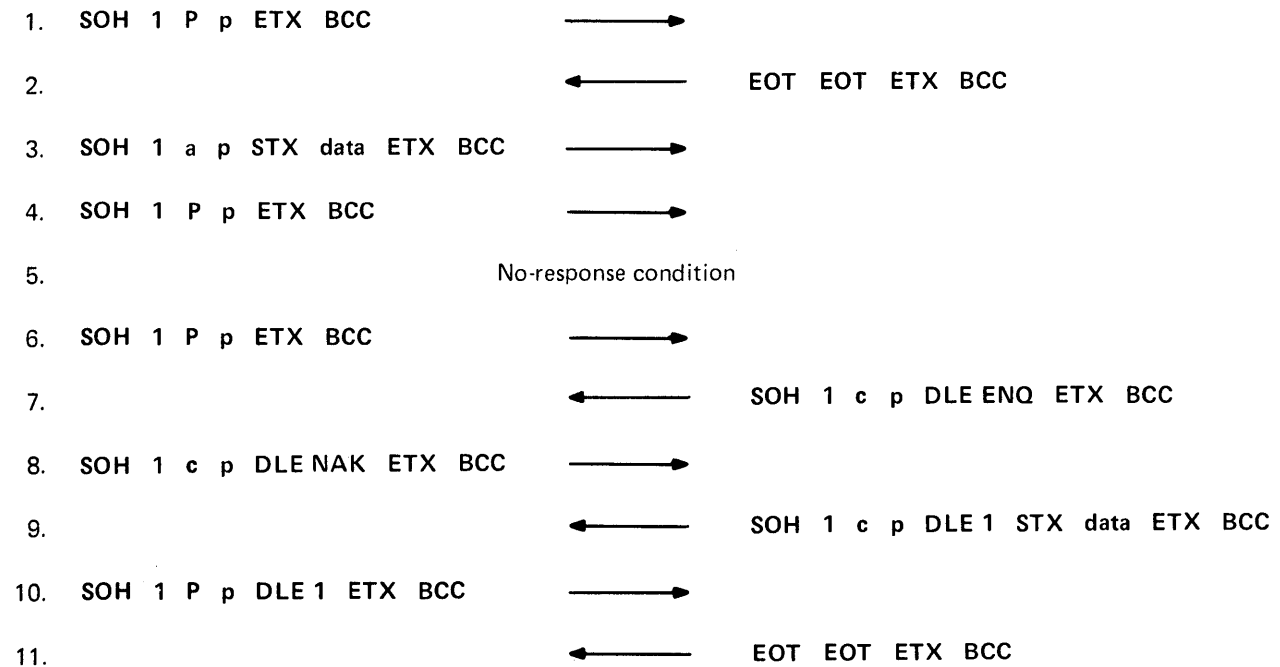

Explanation:

1. General traffic poll.
2. No traffic.
3. Host processor text message directed to the station whose RID "1" and SID is "a."

4. General traffic poll.
5. No-response condition indicates transmission error occurred on poll or response.
6. The general traffic poll must be repeated. (See host processor rule 8.)
7. Reply request (DLE ENQ) from the station whose RID is "1" and SID is "c." (See UTS 30 rule 5.)
8. Retransmission request (DLE NAK) to the station that sent the reply request in step 7. Host processor rule 9 applies because the UTS 30 message (step 2) sent before the reply request was a no-traffic message.
9. Acknowledgment-plus-traffic message, where the traffic is text. The station had sent this message in step 5, but it was in error. The acknowledgment (DLE 1) in the message was passed by the multiplexer function from the station whose RID is "1" and SID is "a" (the one to which text was sent in step 3).
10. General traffic poll with acknowledgment.
11. No traffic.

Example Sequence 2:

The following message sequence applies UTS 30 rules 5 and 6 and host processor rules 5, 8, and 10.

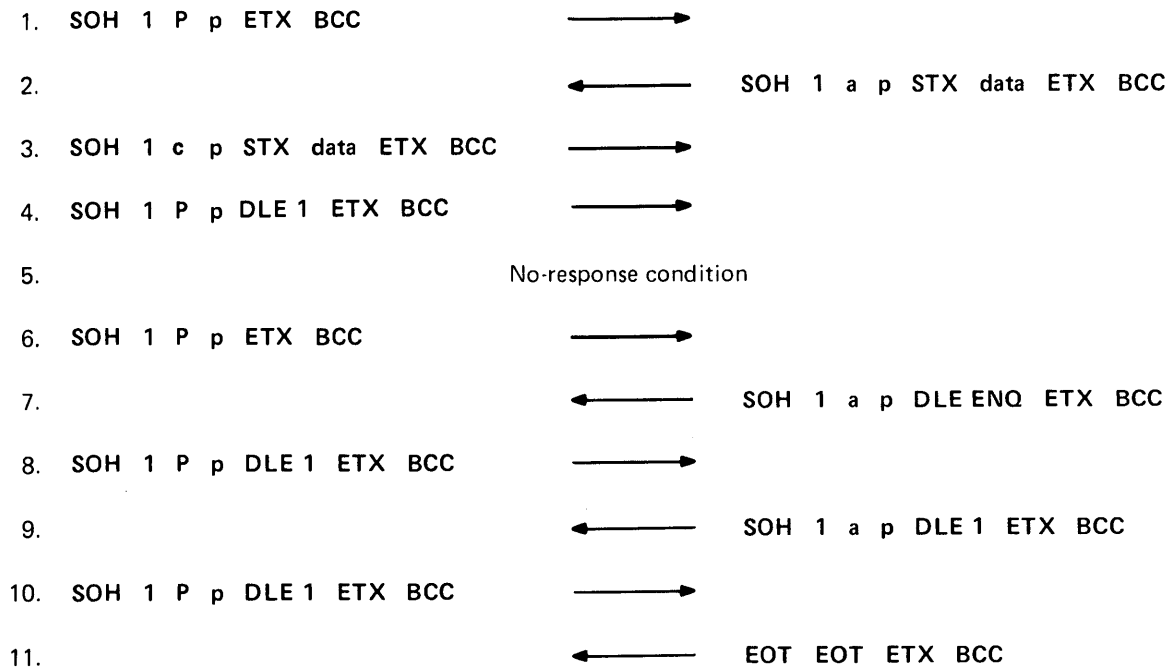

Explanation:

1. General traffic poll.
2. UTS 30 text from the station whose RID is "1" and SID is "a."
3. Host processor text to the station whose RID is "1" and SID is "c." (See host processor rule 5.)
4. General traffic poll with acknowledgment.
5. No-response condition indicates transmission error occurred on poll or response.
6. The general traffic poll must be repeated. (See host processor rule 8.)
7. Reply request (DLE ENQ) message from the station whose RID is "1" and SID is "a."
8. General traffic poll with acknowledgment. (See host processor rule 10.)
9. Acknowledgment for the text message in step 3. The acknowledgment (DLE 1) was passed by the multiplexer function (from the station whose RID is "1" and SID is "b" to the station whose RID is "1" and SID is "a") at the time the general traffic poll (step 6) was received by the UTS 30. However, this acknowledgment was not sent with the reply request in step 7 (UTS 30 rule 6).
10. General traffic poll with acknowledgment.
11. No traffic.

Example Sequence 3:

The following message sequence applies UTS 30 rules 5 and 6 and host processor rules 5, 8, and 10.

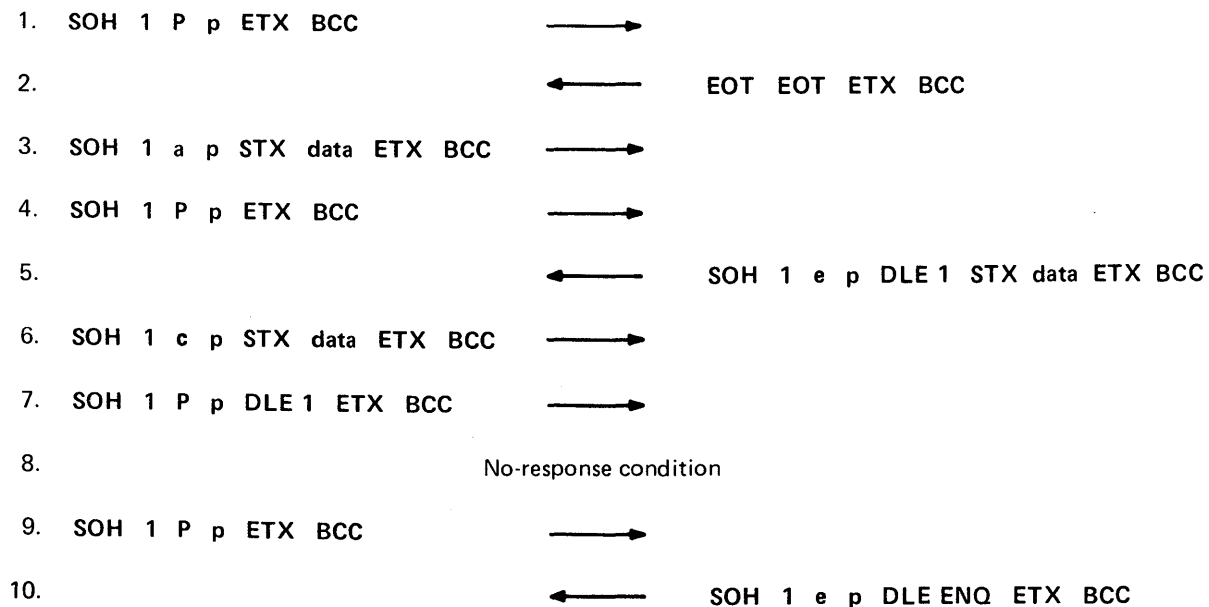

- | | | | |
|-----|-------------------------|---|-------------------------|
| 11. | SOH 1 P p DLE 1 ETX BCC | → | |
| 12. | | ← | SOH 1 e p DLE 1 ETX BCC |
| 13. | SOH 1 P p DLE 1 ETX BCC | → | |
| 14. | | ← | EOT EOT ETX BCC |

Explanation:

1. General traffic poll.
2. No traffic.
3. Host processor text to the station whose RID is "1" and SID is "a."
4. General traffic poll.
5. Acknowledgment plus traffic, where the traffic is text. The text is from the station whose RID is "1" and SID is "c." The acknowledgment was passed by the multiplexer function from the station whose RID is "1" and SID is "a."
6. Host processor text to the station whose RID is "1" and SID is "c." (See host processor rule 5.)
7. General traffic poll with acknowledgment.
8. No-response condition indicates transmission error occurred on poll or response.
9. General traffic poll is repeated. (See host processor rule 8.)
10. Reply request from the station whose RID is "1" and SID is "e." (See UTS 30 rule 5.)
11. General traffic poll with acknowledgment. Host processor rule applies because the last response (step 5) from the poll group contained text from the same station that sent the reply request in step 10.
12. Acknowledgment for the text message sent in step 6. The acknowledgment was passed by the multiplexer function (from the station whose RID is "1" and SID is "c" to the station whose RID is "1" and SID is "e") at the time the general traffic poll (step 9) was received by the UTS 30. However, this acknowledgment was not sent with the reply request in step 10 (UTS 30 rule 6).
13. General traffic poll with acknowledgment.
14. No traffic.

3.7.6. Example of Line Error Message Sequence Involving Errors During Recovery

The following message sequence applies UTS 30 rule 5 and host processor rules 8 and 9.

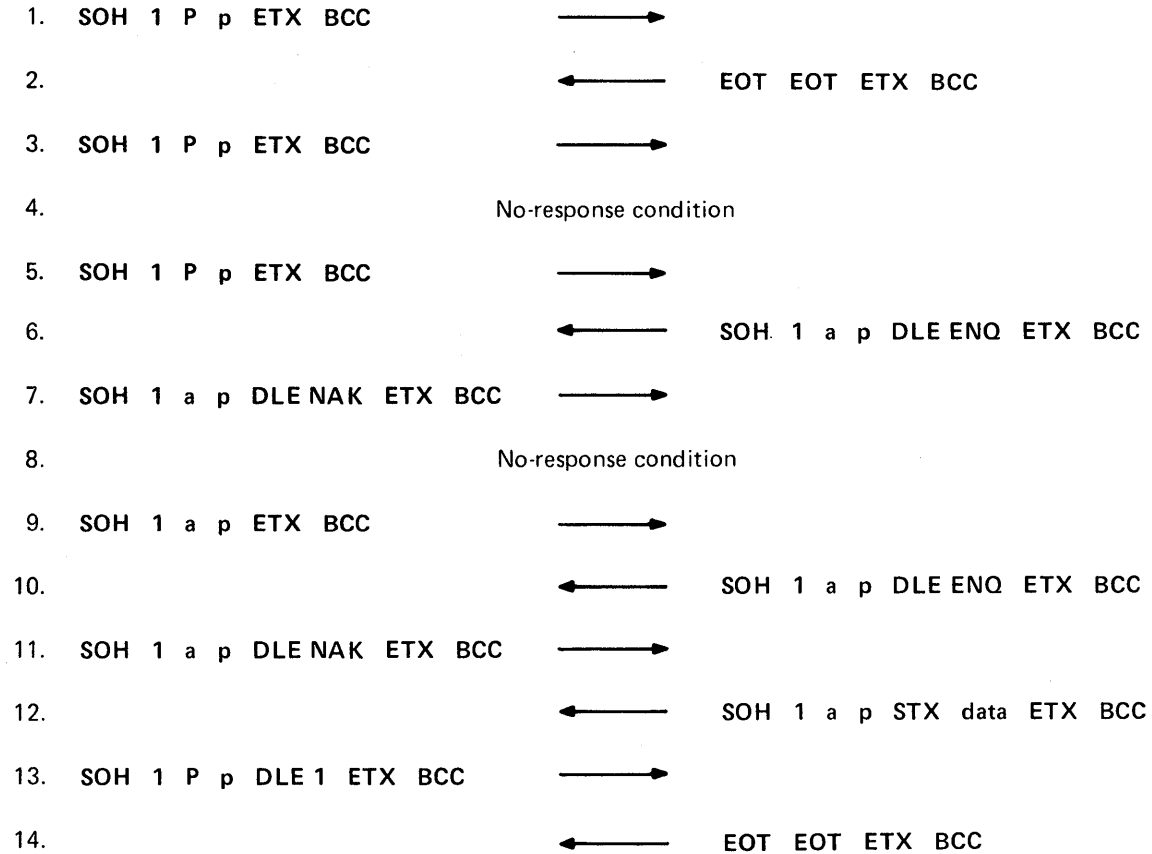

Explanation:

1. General traffic poll.
2. No traffic.
3. General traffic poll.
4. No-response condition indicates transmission error occurred on poll or response.
5. General traffic poll is repeated.
6. Reply request (DLE ENQ) from the station whose RID is "1" and SID is "a." (See UTS 30 rule 5.)
7. Retransmission request (DLE NAK) to the station that sent the reply request in step 6. Host processor rule 9 applies because the UTS 30 message (step 2) before the reply request did not include text data.
8. No-response condition indicates transmission error occurred on poll or response.
9. A specific traffic poll is sent to the same station to which retransmission request was sent in step 7. (See host processor rule 8.)
10. Repeat of the reply request from the station whose RID is "1" and SID is "a."
11. Retransmission request of step 7 is repeated.
12. This UTS 30 text message is the same as the one on which a line error occurred in step 4.
13. General traffic poll with acknowledgment.
14. No traffic.

3.8. PERIPHERAL OPERATION

The host processor can access the UTS 30 peripherals through the first screen or through the second screen of a UTS 30. Either screen must wait in a queue for access to the peripheral device.

The UTS 30 accepts several peripheral initiation commands, which are discussed in 4.5.1. In this section, the term "PI" represents any one of the peripheral initiation commands. Other representative terms used in this section are:

- **TEXT**

A host processor text message containing a general DID and no PI command.

- **TEXT/SD**

A host processor text message containing a specific DID (SD) and no PI command.

- **TEXT/PI**

A host processor text message containing a general DID and a PI command. The peripheral must have been previously selected by the host processor before the TEXT/PI message can be sent by the host processor.

- **TEXT/SD/PI**

A host processor text message containing a specific DID (SD) and a PI command.

3.8.1. Peripheral Access Queue (PAQ)

The UTS 30, using the second screen, can queue messages to peripheral devices. This queue is called the "peripheral access queue," or PAQ. The first screen or second screen message is at the "top of the PAQ" when it is next in line to use the peripheral interface.

The first screen or second screen message is placed in the PAQ when:

- A selection poll is received from the host processor
- A TEXT/SD message is received from the host processor
- A TEXT/PI message is received from the host processor
- A TEXT/SD/PI message is received from the host processor
- The UTS 30 operator presses the PRINT key, XFER key, SEARCH key, REP ADR key, BOB key, or STATUS key.

The data portion of any text message from the host processor is stored in the first screen refresh memory of the station or in the second screen memory, as specified by the SID, and is maintained there even if the transaction is placed in the PAQ.

3.8.2. UTS 30 Notification to the Host Processor of PAQ Status

The message from the second screen memory gains immediate access to the peripheral interface whenever the PAQ is empty. If the host processor message is a TEXT/PI or TEXT/SD/PI message, the normal poll response from the station is a message containing the busy (DLE ?) acknowledgment sequence. The DLE ? indicates that an error-free message was received by the UTS 30 and that the peripheral operation was initiated. A later poll response containing the THRU (DLE ;) sequence indicates completion of the peripheral operation. (The peripheral status message formats are shown in Table 3-1. The status messages are summarized in Table A-1.)

When a message sent from the host to the first screen or to the second screen causes either one to be placed in the PAQ, the UTS 30 returns one of the following station status messages in a poll response:

- Peripheral-selection-delayed status (DLE 5) if the host processor message is a selection poll.
- Acknowledge plus peripheral-selection-delayed status (DLE 1 DLE 5) if the host processor message is TEXT/SD.
- Acknowledge plus message-queued status (DLE 1 DLE 4) if the host processor message is TEXT/PI or TEXT/SD/PI.

3.8.3. DID Address Functions

The host processor selects a UTS 30 peripheral by sending a specific DID. The printer is addressed by a single DID, and the diskette subsystem is addressed by two DIDs per drive (one read DID and one write DID).

Peripheral selections are performed with the following types of host processor messages:

- Selection poll
- TEXT/SD message
- TEXT/SD/PI message

Once a specific SID DID establishes an association between a peripheral and a terminal, the peripheral remains associated with that terminal for subsequent host messages to the peripheral. Both the displayed screen and the second screen can use the same peripheral, but the UTS 30 user must maintain separation of files or forms when messages from both screens are sent to the peripheral.

The way in which a host processor message for a peripheral is handled by the UTS 30 is determined by the DID value in the message. DID values are interpreted by the UTS 30 as follows:

<u>Hexadecimal Value</u>	<u>Interpretation</u>
70	This is the general DID. It has no effect on the peripheral interface or on the peripherals.
20 through 7E	These are the DIDs available for use by the host processor as peripheral addresses. A total of 95 DIDs can be used; of these, 12 (73 through 7E hexadecimal) are the traditional DIDs used with the UTS 400.
71	This DID value is used to override (dump) peripheral activity. Any station receiving this DID will terminate both active and queued peripheral operations. No peripheral status will be sent; however, a THRU station status may be returned as a response to the next poll.
72	This is the deselection DID. It may also be used to terminate printer activity.
7F	This DID is included in UTS 30 poll response if the station PRINT or XFER key was pressed.

3.8.4. Rules for Host Processor/UTS 30 Peripheral Communication

■ **UTS 30 rule 7:**

The specific DID in any host processor message causes a selection attempt only if the message is error free.

■ **UTS 30 rule 8:**

The UTS 30 will respond to a selection poll or to the first poll following a TEXT/SD, TEXT/SD/PI, or TEXT/PI message with a peripheral status response. (Peripheral status responses are listed in Table A-1.)

■ **UTS 30 rule 9:**

When a peripheral operation (offline or online) is in progress, the station will not respond to a poll, text message, or TEXT/PI containing a general DID.

A selection poll, TEXT/SD, or TEXT/SD/PI to a station with a peripheral operation in progress causes the peripheral operation to be terminated and a peripheral status response to be sent, as described in UTS 30 rule 8. If the peripheral operation is terminated before the operation is complete, a timing error results, and the DLE : status is sent.

■ UTS 30 rule 10:

A selection poll requiring access to a peripheral interface already in use (by either the displayed screen or the second screen) will elicit the peripheral-selection-delayed (DLE 5) response. The displayed screen or second screen message is then added to the PAQ. When the displayed screen or second screen waiting to use the peripheral is placed on the top of the PAQ, the selection attempt is made and the next general poll or specific poll response from the displayed screen or second screen will be DLE >, DLE <, DLE :, or DLE =. (See Table A-1.) If a UTS 30 that does not have a peripheral interface receives a peripheral selection poll, its response is a no-response (DLE =).

■ UTS 30 rule 11:

A TEXT/PI message or a TEXT/SD/PI message requires access to the peripheral interface. If the peripheral interface is already in use on the second screen, the station response is acknowledge plus message queued (DLE 1 DLE 4). The UTS 30 response to subsequent general polls is no traffic, and the response to subsequent specific polls is message queued (DLE 4) until the message reaches the top of the PAQ. When the message is acted upon, the UTS 30 response to subsequent specific polls is busy (DLE ?) as long as the peripheral operation is in progress. A THRU (DLE ;) status is sent as a poll response upon completion of the peripheral operation.

■ UTS 30 rule 12:

Upon completion of a data transfer to or from a peripheral, the UTS 30 sends the THRU (DLE ;) status as a poll response. When automatic retry is enabled in a station, the THRU response means the peripheral operation was completed successfully.

■ Host processor rule 13:

If a no-response condition exists on a selection poll, then host processor rule 6 (which requires sending of a specific poll) must be followed. If the response to this specific poll is a reply request, then a retransmission request must be sent. If the response is no traffic, the selection poll must be resent.

■ Host processor rule 14:

A selection poll can contain an acknowledgment only if the selection is being performed on the station that is owed the acknowledgment.

■ Host processor rule 15:

The host processor must maintain peripheral operation timers at the screen level or at the UTS 30 level to provide an indication of excessive wait time or of a sustained busy condition. These timers must consider the time a station is on the PAQ before the operation is performed (that is, the wait time) and the time required to actually perform the operation. Wait time depends on the number of host-processor and operator-initiated operations already in the PAQ and the type of operations being performed.

The screen-level timer should be initiated for:

- A delayed status response to a selection poll
- An acknowledge plus delayed status response to the poll following a TEXT/SD message
- An acknowledge plus message-queued response to the poll following a TEXT/SD/PI message
- A busy response to the poll following a TEXT/PI or TEXT/SD/PI message

When general polls are being used, the screen-level peripheral timeouts can be used as a timing mechanism for periodically sending specific polls to determine when the peripheral operation is actually in progress. (See UTS 30 rule 11.)

The screen-level timer should be terminated upon notification of a peripheral completion (the THRU response if the first response was busy or acknowledge plus message queued, or the peripheral device status if the first response was delayed status).

3.8.5. Example of Normal Selection Poll Message Sequence

The following message sequence applies UTS 30 rule 8.

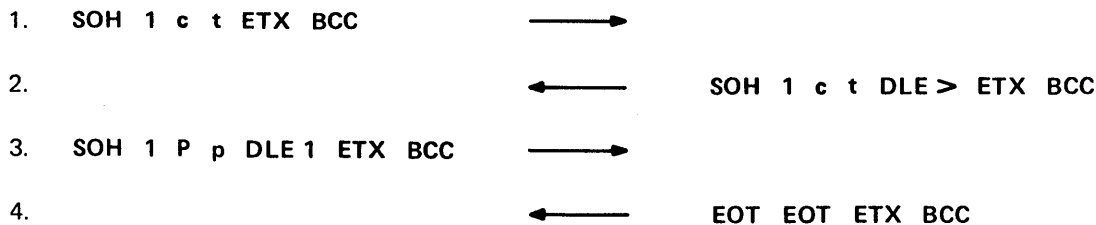

In this sequence, the printer has a DID of "t" and the UTS 30 has a RID of "1" and a SID of "c." (See Figure 3-1.)

Explanation:

1. Selection poll.
2. Peripheral-ready status (DLE >). (See UTS 30 rule 8.)
3. General traffic poll with acknowledgment.
4. No traffic.

3.8.6. Examples of Line Errors During Selection Poll Message Sequences

Example Sequence 1:

The following message sequence applies UTS 30 rule 8 and host processor rule 13. In this sequence, it is assumed that a printer with a DID of "s" is to be selected for the station whose RID is "1" and SID is "a."

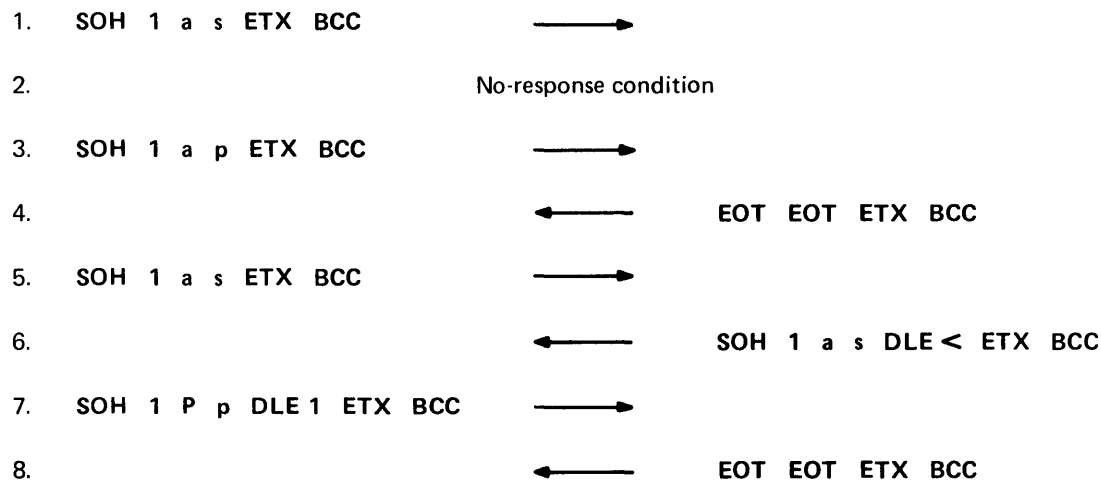

Explanation:

1. Selection poll.
2. No-response condition indicates transmission error occurred on poll or response.
3. Specific traffic poll. (See host processor rule 13.)
4. No traffic.
5. The selection poll sent in step 1 is repeated. (See host processor rule 13.)
6. Peripheral status 2 (DLE <). (See UTS 30 rule 8.)
7. General traffic poll with acknowledgment.
8. No traffic.

Example Sequence 2:

The following message sequence applies UTS 30 rules 5 and 8 and host processor rules 8 and 13.

It is assumed that a printer with a DID of "s" is to be selected for the station whose RID is "1" and SID is "a."

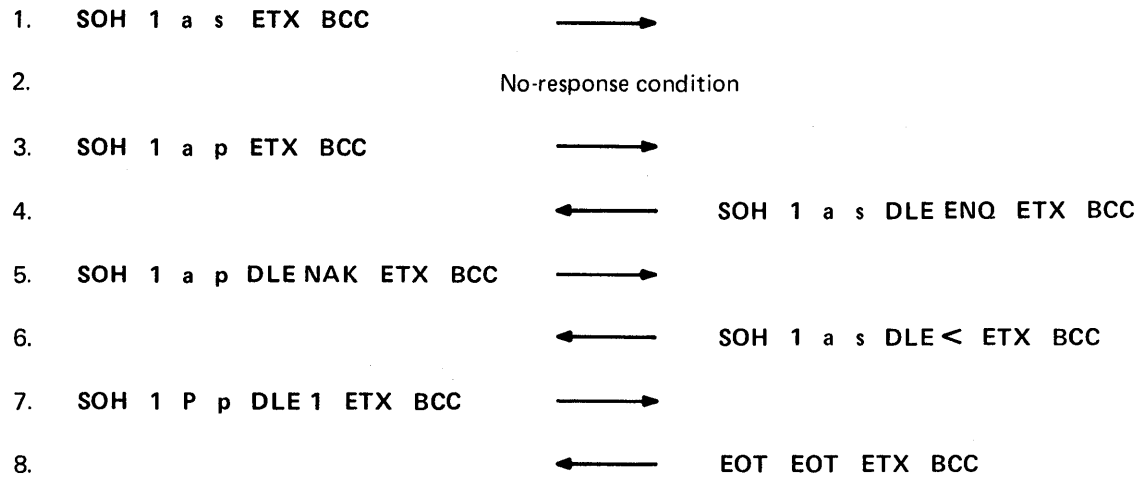

Explanation:

1. Selection poll.
2. No-response condition indicates transmission error occurred on poll or response.
3. Specific traffic poll. (See host processor rule 8.)
4. Reply request. (See UTS 30 rule 5.)
5. Retransmission request. (See host processor rule 13.)
6. Peripheral status 2 (DLE <). (See UTS 30 rule 8.)
7. General traffic poll with acknowledgment.
8. No traffic.

3.8.7. Example of TEXT/SD Message Sequence

The following message sequence applies UTS 30 rule 8. In this sequence, the printer has a DID of "s" and the UTS 30 has a RID of "1" and a SID of "a." (See Figure 3-1.)

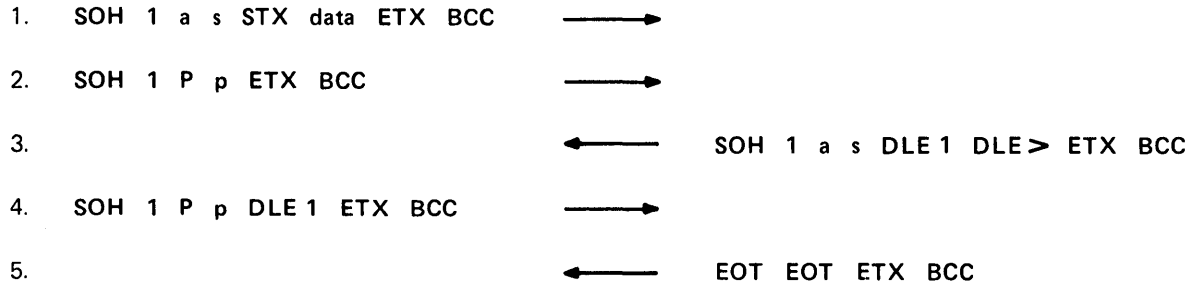

Explanation:

1. The TEXT/SD message (that is, a text message containing a specific DID) is directed to the UTS 30 screen.
2. General traffic poll.
3. The acknowledgment (DLE 1) in the poll response indicates that the TEXT/SD message in step 1 was received without error by the station. The selection attempt to the printer resulted in the peripheral-ready (DLE >) status. (See UTS 30 rule 8.) No data was sent across the peripheral interface because the TEXT/SD message does not contain a PI command.
4. General traffic poll with acknowledgment.
5. No traffic.

3.8.8. Example of TEXT/SD/PI Message Sequence

The following message sequence applies UTS 30 rules 7, 8, and 12 and host processor rule 15.

In this sequence, the printer has a DID of "s" and the UTS 30 has a RID of "1" and a SID of "a." (See Figure 3-1.) The peripheral initiation command to be sent is PRINT, which requires that the DC2 control character be included in the host processor text message.

- | | | | |
|-----|--------------------------------|---|-------------------------|
| 1. | SOH 1 a s STX data DC2 ETX BCC | → | |
| 2. | SOH 1 P p ETX BCC | → | |
| 3. | | ← | SOH 1 a s DLE ? ETX BCC |
| 4. | SOH 1 P p DLE 1 ETX BCC | → | |
| 5. | | ← | EOT EOT ETX BCC |
| 6. | SOH 1 P p ETX BCC | → | |
| 7. | | ← | EOT EOT ETX BCC |
| | | | . |
| 8. | | | . |
| | | | . |
| 9. | SOH 1 P p ETX BCC | → | |
| 10. | | ← | SOH 1 a s DLE ; ETX BCC |
| 11. | SOH 1 P p DLE 1 ETX BCC | → | |
| 12. | | ← | EOT EOT ETX BCC |

Explanation:

1. The TEXT/SD/PI message (that is, a text message containing a specific DID and a peripheral initiation command) is directed to the printer.
2. General traffic poll.
3. The busy (DLE ?) in the poll response indicates a successful peripheral selection, acknowledgment by the station for receiving error-free text, and notification that the peripheral operation was in progress when message 2 (the poll) was received. The station-level timer at the host processor is started for this peripheral operation. (See UTS 30 rules 7 and 8 and host processor rule 15.)
4. General traffic poll with acknowledgment.
5. No traffic. The peripheral operation is still in progress.
- 6,7, 8. General traffic polls continue to solicit no-traffic responses. The time allowed by the host processor for the peripheral operation to be completed has not elapsed.
9. General traffic poll.
10. The THRU (DLE ;) in the poll response indicates that the peripheral operation has been successfully completed. (See UTS 30 rule 12.)

11. General traffic poll with acknowledgment.
12. No traffic.

3.8.9. Example of Peripheral Error on TEXT/SD/PI Message Sequence

The following message sequence applies UTS 30 rule 8.

In this sequence, the printer has a DID of "s" and the UTS 30 has a RID of "1" and a SID of "a." (See Figure 3-1.) The peripheral initiation command to be sent is PRINT, which requires that the DC2 control character be included in the host processor text message.

1. SOH 1 a s STX data DC2 ETX BCC \longrightarrow
2. SOH 1 P p ETX BCC \longrightarrow
3. \longleftarrow SOH 1 a s DLE 1 DLE = ETX BCC
4. SOH 1 P p DLE 1 ETX BCC \longrightarrow
5. \longleftarrow EOT EOT ETX BCC

Explanation:

1. The TEXT/SD/PI message is directed to the printer.
2. General traffic poll.
3. The acknowledgment (DLE 1) in the poll response indicates that the TEXT/SD/PI message in step 1 was received without error by the station. The selection attempt to the printer resulted in the no-response (DLE =) peripheral status. (See UTS 30 rule 8.)
4. General traffic poll with acknowledgment.
5. No traffic.

3.8.10. Example of Message-Queued Message Sequence

The following message sequence applies UTS 30 rules 7, 8, 11, and 12 and host processor rule 15.

In this sequence, the printer has a DID of "s" and the UTS 30 has a RID of "2" and a SID of "a"; the second screen of the station is designated by a RID of "2" and a SID of "b." (See Figure 3-1.) The peripheral initiation command to be sent is PRINT, which requires that the DC2 control character be included in the host processor text message.

1. SOH 2 a s STX data DC2 ETX BCC →
2. SOH 2 P p ETX BCC →
3. ← SOH 2 a s DLE ? ETX BCC
4. SOH 2 P p DLE 1 ETX BCC →
5. ← EOT EOT ETX BCC
6. SOH 2 b s STX data DC2 ETX BCC →
7. SOH 2 P p ETX BCC →
8. ← SOH 2 b s DLE 1 DLE 4 ETX BCC
9. SOH 2 P p DLE 1 ETX BCC →
10. ← SOH 2 a s DLE ; ETX BCC
11. SOH 2 P p DLE 1 ETX BCC →
12. ← EOT EOT ETX BCC
13. SOH 2 P p ETX BCC →
14. ← EOT EOT ETX BCC
15. SOH 2 P p ETX BCC →
16. ← SOH 2 b s DLE ; ETX BCC
17. SOH 2 P p DLE 1 ETX BCC →
18. ← EOT EOT ETX BCC

Explanation:

1. The TEXT/SD/PI message is directed to the printer. The data is placed in the display screen memory of the UTS 30 which has a RID of "2" and appears on the screen of the UTS 30.
2. General traffic poll.
3. The busy (DLE ?) in the poll response indicates a successful peripheral selection, an acknowledgment by the station of receiving error-free text, and notification that the peripheral operation was in progress when message 2 (the poll) was received. The station-level timer at the host processor is started for this peripheral operation. (See UTS 30 rules 7 and 8 and host processor rule 15.)
4. General traffic poll with acknowledgment.
5. No traffic. (The time allowed by the host processor for the peripheral operation to be completed has not elapsed.)
6. The TEXT/SD/PI message is directed to the printer. The data is placed in the second screen memory of the UTS 30, which has a RID of "2" and a SID of "b." The message is queued while waiting for access to the peripheral interface.
7. General traffic poll.
8. Acknowledgment plus message-queued station status. The peripheral interface is busy with the UTS 30 which has a RID of "2" and SID of "a." The station-level timer at the host processor is started for this peripheral operation. (See UTS 30 rules 8 and 11 and host processor rule 15.)
9. General traffic poll with acknowledgment.
10. The peripheral operation for the master station has been completed successfully. (See UTS 30 rule 12.)
11. General traffic poll with acknowledgment.
12. No traffic.
13. General traffic poll.
14. No traffic.
15. General traffic poll.
16. The peripheral operation for the second screen has been completed successfully.
17. General traffic poll with acknowledgment.
18. No traffic.

3.8.11. Example of Peripheral-Selection-Delayed Message Sequence

The following message sequence applies UTS 30 rules 8 and 10.

This sequence is based on the UTS 30, printer, and second screen configuration with a modem connection. (See Figure 3-1.) The printer has a DID of "s," the UTS 30 has a RID of "2" and a SID of "a," and the second screen has a RID of "2" and a SID of "b."

1. The UTS 30 station operator presses the PRINT key.
2. SOH 2 b s ETX BCC →
3. ← SOH 2 b s DLE 5 ETX BCC
4. SOH 2 P p DLE 1 ETX BCC →
5. ← EOT EOT ETX BCC
6. SOH 2 P p ETX BCC →
7. ← EOT EOT ETX BCC
8. SOH 2 P p ETX BCC →
9. ← SOH 2 b s DLE > ETX BCC
10. SOH 2 P p DLE 1 ETX BCC →
11. ← EOT EOT ETX BCC

Explanation:

1. A print operation is initiated by the station operator.
2. Selection poll. The attempted selection of the printer is for second screen with a RID of "1" and a SID of "b."
3. The peripheral selection attempt is delayed because the peripheral interface is already in use. The second screen is put in the PAQ. (See UTS 30 rule 10.)
4. General traffic poll with acknowledgment.
5. No traffic.
6. General traffic poll.
7. No traffic. The second screen is still not at the top of the PAQ.
8. General traffic poll.
9. The second screen has reached the top of the PAQ, and the peripheral-ready status is returned. (See UTS 30 rule 11.)

10. General traffic poll with acknowledgment.
11. No traffic.

3.8.12. Example of Sustained-Busy Condition in a Message Sequence

The following message sequence applies UTS 30 rules 7, 8, and 10 and host processor rule 15.

In this sequence, the printer has a DID of "t" and the UTS 30 has a RID of "1" and a SID of "c." (See Figure 3-1.)

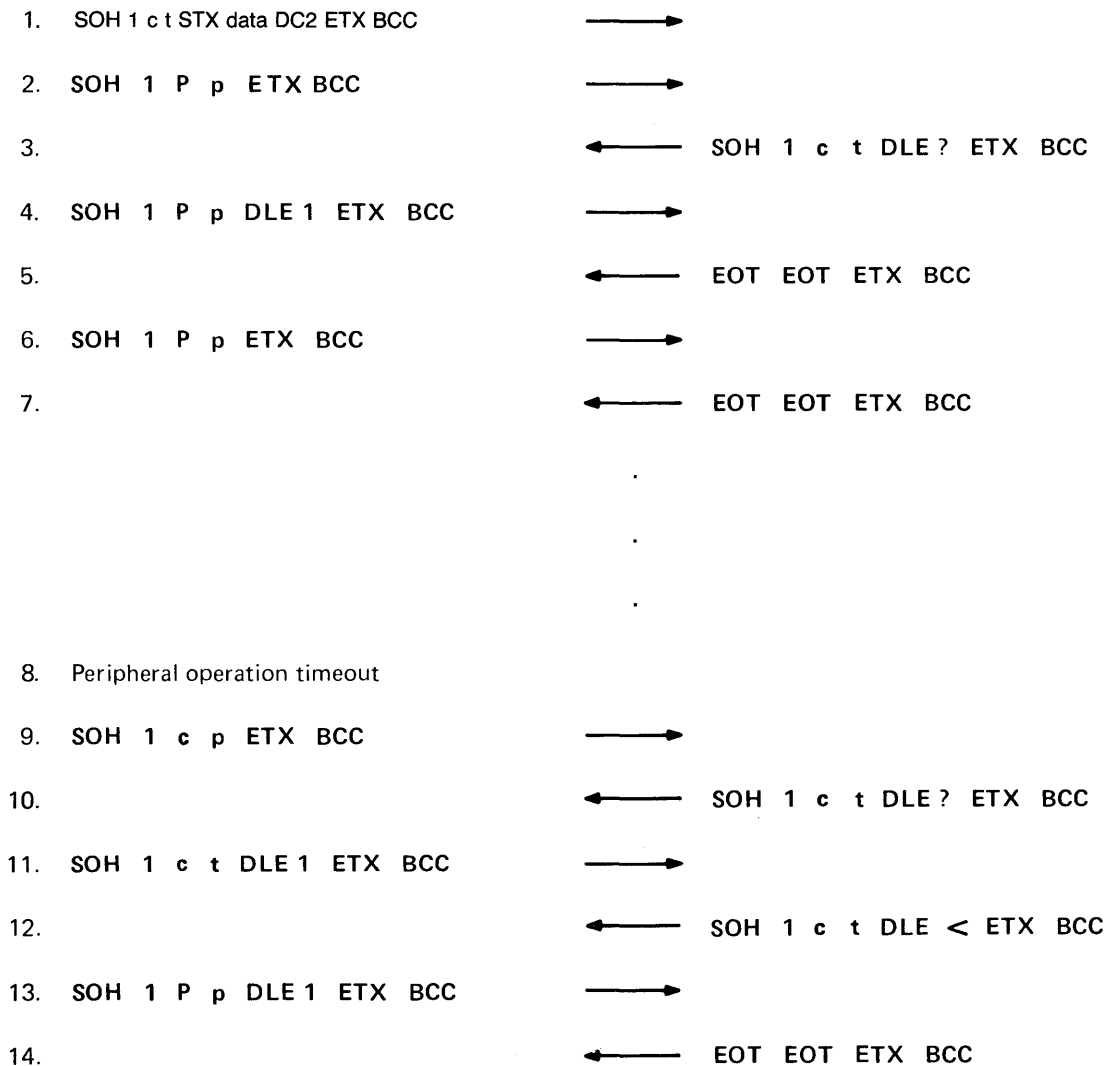

Explanation:

1. The TEXT/SD/PI message is directed to the printer.
2. General traffic poll.
3. The busy (DLE ?) in the poll response indicates a successful peripheral selection, acknowledgment by the station of receiving error-free text, and notification that the peripheral operation was in progress when message 2 (the poll) was received. The station-level timer at the host processor is started for this peripheral operation. (See UTS 30 rule 11 and host processor rule 15.)
4. General traffic poll with acknowledgment.
5. No traffic. The time allowed by the host processor for the peripheral operation to be completed has not elapsed.
6. General traffic poll.
7. No traffic.
8. The peripheral operation timeout value is the time allowed by the host processor for a peripheral operation to be completed. (See host processor rule 15.)
9. The host processor has determined a peripheral timeout and sends a specific poll.
10. The response to the specific poll is the busy (DLE ?) message, which indicates a sustained-busy condition. (See UTS 30 rule 11 and host processor rule 15.)
11. Selection poll with acknowledgment. (See host processor rule 14.)
12. The response to the selection poll is peripheral status 2 (DLE <). The printer may be out of paper. (See UTS 30 rule 8.)
13. General traffic poll with acknowledgment.
14. No traffic.

3.8.13. Example of Message-Queued Sequence With Potential Sustained-Busy Condition

The following message sequence applies UTS 30 rules 7, 8, 10, and 11 and host processor rule 15.

In this sequence, the printer has a DID of "t." A station in the multiplexer group (see Figure 3-1) has a RID of "1" and a SID of "c."

1. SOH 1 c t STX data DC2 ETX BCC →
2. SOH 1 P p ETX BCC →
3. ← SOH 1 c t DLE 1 DLE 4 ETX BCC

4.	SOH 1 P p DLE 1 ETX BCC	→	
5.		←	EOT EOT ETX BCC
6.	SOH 1 P p ETX BCC	→	
7.		←	EOT EOT ETX BCC
		.	
		.	
		.	
8.	Peripheral operation timeout		
9.	SOH 1 c p ETX BCC	→	
10.		←	SOH 1 c t DLE 4 ETX BCC
11.	SOH 1 P p DLE 1 ETX BCC	→	
12.		←	EOT EOT ETX BCC
13.	SOH 1 P p ETX BCC	→	
14.		←	EOT EOT ETX BCC
		.	
		.	
		.	
15.	Peripheral operation timeout		
16.	SOH 1 c p ETX BCC	→	
17.		←	SOH 1 c t DLE? ETX BCC
18.	SOH 1 P p DLE 1 ETX BCC	→	
19.		←	EOT EOT ETX BCC
20.	SOH 1 P p ETX BCC	→	
21.		←	SOH 1 c t DLE; ETX BCC
22.	SOH 1 P p DLE 1 ETX BCC	→	
23.		←	EOT EOT ETX BCC

Explanation:

1. TEXT/SD/PI message is directed to the printer.
2. General traffic poll.
3. Acknowledgment plus message-queued station status (DLE 1 DLE 4). The peripheral interface is being used by the second screen. The host processor starts the station-level timer for this peripheral operation and the message is placed in the PAQ. (See UTS 30 rules 8 and 11 and host processor rule 15.)
4. General traffic poll with acknowledgment.
5. No traffic.
6. General traffic poll.
7. No traffic.
8. The peripheral operation timeout is used by the host processor as a timing mechanism to periodically send specific polls to the station whose RID is "1" and SID is "b." This station did not have access to the peripheral interface when it first received the TEXT/SD/PI message. The response to the periodic specific polls, therefore, will be message queued (DLE 4) until the message reaches the top of the PAQ. (See UTS 30 rule 11.)
9. Specific traffic poll.
10. The response to the specific traffic poll is message queued (DLE 4). The host processor restarts the station-level timer for the peripheral operation (which has not yet been initiated) and continues sending general traffic polls.
11. General traffic poll with acknowledgment.
12. No traffic.
13. General traffic poll.
14. No traffic.
15. Peripheral operation timeout for the second time. A specific traffic poll must be sent as in step 9.
16. Specific traffic poll.
17. The response to the specific traffic poll is busy (DLE ?). The host processor restarts the station-level timer for the peripheral operation (which has now been initiated) for the last time.
18. General traffic poll with acknowledgment.
19. No traffic.
20. General traffic poll.

21. The THRU (DLE ;) response indicates successful completion of the peripheral operation initiated by the TEXT/SD/PI message in step 1. (See UTS 30 rule 12.)
22. General traffic poll with acknowledgment.
23. No traffic.

3.8.14. Example Message Sequence Involving Passing of the Acknowledgment and Busy (DLE 1 and DLE ?)

The following message sequence applies the multiplexer function definitions (3.6) and host processor rules 3, 4, and 5.

In this sequence, the poll group defined by the multiplexer group (shown in Figure 3-1) is being used. The peripherals in the sequence are the printers with DIDs of "s" and "t" in the multiplexer group. Host processor text is directed to the first printer whose DID is "s" through the station whose RID is "1" and SID is "a." Host processor text is directed to the second printer through the second screen whose RID is "1" and SID is "d." The peripheral initiation command to be sent is PRINT, which requires that the DC2 control character be included in the host processor text message. Text directed to the station whose RID is "1" and SID is "b" is for the screen only.

- | | | |
|-----|--------------------------------|-----------------------------------|
| 1. | SOH 1 a s STX data DC2 ETX BCC | → |
| 2. | SOH 1 P p ETX BCC | → |
| 3. | | ← SOH 1 c p DLE? STX data ETX BCC |
| 4. | SOH 1 d t STX data DC2 ETX BCC | → |
| 5. | SOH 1 P p DLE 1 ETX BCC | → |
| 6. | | ← SOH 1 a s DLE? DLE ; ETX BCC |
| 7. | SOH 1 c p STX data ETX BCC | → |
| 8. | SOH 1 P p DLE 1 ETX BCC | → |
| 9. | | ← SOH 1 d t DLE 1 DLE ; ETX BCC |
| 10. | SOH 1 P p DLE 1 ETX BCC | → |
| 11. | | ← EOT EOT ETX BCC |

Explanation:

1. The TEXT/SD/PI message is directed to the printer with a DID of "s." The data is placed in the display screen refresh memory for the UTS 30 whose RID is "1" and SID is "a."
2. General traffic poll.
3. Acknowledgment-plus-traffic where the traffic is text. The text is from the station whose RID is "1" and SID is "c." The acknowledgment was passed by the multiplexer from the station that was sent text in step 1, station "a." (See host processor rule 3.)
4. The TEXT/SD/PI message is directed to the printer whose DID is "t." The data is placed in the second screen which has a RID of "1" and a SID of "d." (See host processor rule 5.)
5. General traffic poll with acknowledgment.
6. Acknowledgment-plus-traffic where the traffic is a THRU response. The THRU is from the station whose RID is "1" and SID is "a" (the one sent text in step 1). The acknowledgment was passed by the multiplexer from the station (second screen) that was sent text in step 4. (See host processor rules 3 and 4.)
7. The host processor text message is directed to the station whose RID is "1" and SID is "c."
8. General traffic poll with acknowledgment.
9. Acknowledgment (DLE 1) plus traffic where the traffic is a THRU response. The THRU is from the second screen whose RID is "1" and SID is "d" (the one sent text in step 4). The acknowledgment was passed by the station that was sent text in step 7. (See host processor rules 3 and 4.)
10. General traffic poll with acknowledgment.
11. No traffic.

3.8.15. Example of Discarding Duplicate Poll (Retransmission Request)

The following message sequence applies the multiplexer function definitions (3.6), UTS 30 rules 5 and 6, and host processor rules 3, 5, 8, 9, and 12.

In this sequence, the printer has a DID of "w" and the UTS 30 has a SID of "e." (See Figure 3-1.) The peripheral initiation command to be sent is PRINT, which requires that the DC2 control character be included in the host processor text message.

NOTE:

The following example is only one of many possible message sequences to which host processor rule 12 applies.

- | | | | |
|-----|--------------------------------|---|-------------------------------|
| 1. | SOH 1 P p ETX BCC | → | |
| 2. | | ← | EOT EOT ETX BCC |
| 3. | SOH 1 e w STX data DC2 ETX BCC | → | |
| 4. | SOH 1 P p ETX BCC | → | |
| 5. | | ← | SOH 1 e w DLE ? ETX BCC |
| 6. | SOH 1 P p DLE 1 ETX BCC | → | |
| 7. | | ← | EOT EOT ETX BCC |
| 8. | SOH 1 a p STX data ETX BCC | → | |
| 9. | SOH 1 P p ETX BCC | → | |
| 10. | | ← | SOH 1 e w DLE 1 DLE ; ETX BCC |
| 11. | SOH 1 c p STX data ETX BCC | → | |
| 12. | SOH 1 P p DLE 1 ETX BCC | → | |
| 13. | | | No-response condition |
| 14. | SOH 1 P p ETX BCC | → | |
| 15. | | ← | SOH 1 e w DLE ENQ ETX BCC |
| 16. | SOH 1 e p DLE NAK ETX BCC | → | |
| 17. | | ← | SOH 1 e w DLE 1 DLE ; ETX BCC |
| 18. | SOH 1 P p DLE 1 ETX BCC | → | |
| 19. | | ← | EOT EOT ETX BCC |

Explanation:

1. General traffic poll.
2. No traffic.
3. The TEXT/SD/PI message is directed to the printer. The data is placed in the display screen memory for the UTS 30 whose RID is "1" and SID is "e", and the printer is started.
4. General traffic poll.
5. Busy message from the station that was sent text in step 3.
6. General traffic poll with acknowledgment.
7. No traffic.
8. Host processor text to the station whose RID is "1" and SID is "a." (See host processor rule 5.)
9. General traffic poll.
10. Acknowledgment (DLE 1) plus traffic where the traffic is a THRU response. The acknowledgment was passed by the multiplexer from the station (SID of "a") that was sent text in step 8. (See host processor rule 3.)
11. Host processor text to the station whose RID is "1" and SID is "c." (See host processor rule 5.)
12. General traffic poll with acknowledgment to station 1e.
13. No-response condition indicates transmission error on poll or response (station 1c did not see step 11 and/or step 12).
14. The general traffic poll is repeated without acknowledgment. (See host processor rule 8.)
15. Station 1e did not see the message in step 10 and is, therefore, requesting a reply. (See UTS 30 rule 5.)
16. Retransmission request (DLE NAK) to the station that sent the reply request in step 15. Host processor rule 9 applies because the UTS 30 message (step 10) sent before the reply request did not include text data. (The host processor cannot tell whether there is a transmission outstanding or an acknowledgment outstanding.)
17. This message is a retransmission (duplication) of the message in step 10. Host processor rule 12 applies because the message (step 10) sent before the reply request is of the same type. DLE 1 came from the station whose RID is "1" and SID is "c;" DLE ; came from the station whose RID is "1" and SID is "e." This acknowledgment was passed by the multiplexer (from the station whose RID is "1" and SID is "c" to the station whose RID is "1" and SID is "e") at the time the general traffic poll was received by the UTS 30 in step 14. However, this acknowledgment was not sent with the reply request in step 15. (See UTS 30 rule 6.)
18. General traffic poll with acknowledgment.
19. No traffic.

3.8.16. Contention

The UTS 30 method of sharing the peripheral between the display screen memory and the second screen memory can create contention between the host and another host (host/host) and between the host and an operator (host/operator).

Host/host contention is resolved through the host handling of the message-queued response, the delayed-status response, and the peripheral timeout considerations.

Host/operator contention between the displayed screen and the second screen is handled by the host software that handles host/host contention. Host/operator contention on the same screen can be resolved by several mechanisms. If operator initiations are to take priority, then the host alerts the operator of its requirement for access by way of the message-waiting indicator (using the BEL sequence). If the host has priority, host processor messages containing DIDs other than 70 (hexadecimal) will terminate an operator-initiated peripheral operation currently using the screen, thus freeing the screen to accommodate processor text.

The host software must resolve the contentions in a manner that allows reliable interleaving between operator and host, or between host and host-initiated peripheral operations. Note, however, that because of the peripheral-sharing aspects of the UTS 30, the responsibility for file and form control is placed on the user.

3.9. UTS 30 MESSAGE PRIORITIES

3.9.1. Rules for UTS 30 Message-Sending Priorities

The following rules define the priorities in which messages are transmitted when a UTS 30 station has more than one message to send.

■ **UTS 30 rule 13:**

A station will not respond with a message-waiting or program-attention key code message to a poll containing an acknowledgment if that station is owed an acknowledgment.

■ **UTS 30 rule 14:**

If a UTS 30 station or cluster has more than one response to send, the following priority sequence will be observed:

1. Any station or peripheral status responses are sent first. These responses include:
 - a. Message-queued response (DLE 4) due to receipt of a TEXT/PI or TEXT/SD/PI message when another message was already in the PAQ.
 - b. Peripheral-selection-delayed response (DLE 5) due to receipt of a selection poll or a TEXT/SD message when another message was already in the PAQ.
 - c. Peripheral-operation-THRU response (DLE ;) due to completion of the peripheral operation.

- d. Peripheral status response 1 (DLE >) due to receipt of a TEXT/SD message or a selection poll when no other message was in the PAQ.
 - e. Peripheral status response 2 (DLE <), 3 (DLE :) or 4 (DLE =) due to receipt of a selection poll, a TEXT/SD message, or a TEXT/SD/PI message when no other message was in the PAQ.
2. If no priority 1 conditions exist, then any text messages resulting from the XMIT key being pressed, or from a host processor transmit command, are sent.
 3. If no priority 2 conditions exist, then any message-waiting or program-attention-key code messages are sent.

3.9.2. Example of Program Attention Key Being Pressed During Host Processor Text Message

The following message sequence applies UTS 30 rule 14.

In this sequence, the station has a RID of "1" and a SID of "a."

1. SOH 1 a p STX data ETX BCC —————→
2. Program attention key F1 is pressed while the text message in step 1 is arriving at the station
3. SOH 1 P p ETX BCC —————→
4. ←———— SOH 1 a p DLE 1 7 ETX BCC
5. SOH 1 P p DLE 1 ETX BCC —————→
6. ←———— EOT EOT ETX BCC

Explanation:

1. Text is sent to station whose RID is "1" and SID is "a."
2. The function keys are not locked even though data is arriving at the station.
3. General traffic poll.
4. The acknowledge (DLE 1) response indicates that the text message in step 1 was received without error. The 7 indicates that program attention key F1 was pressed before the poll sent in step 3 had arrived. The station had no higher-priority message to send. (See UTS 30 rule 14.)
5. General traffic poll with acknowledgment.
6. No traffic.

3.10. DISCONNECTION OF THE TELEPHONE/MODEM COMMUNICATIONS LINE

A UTS 30 on a modem can automatically disconnect the communications line. (This is called the automatic hangup parameter. To use it, the CM and AA parameters in the (PARAM) field of the control page must be properly set. See Table J-3.) The UTS 30 alerts the host processor that the UTS 30 end of the line is going to be disconnected and, therefore, that the host processor end of the line should be disconnected. The host processor has an equivalent capability to initiate disconnection if the automatic hangup parameter is enabled in the UTS 30.

3.10.1. Disconnection at the UTS 30

At the UTS 30, the disconnection sequence is initiated only when the operator presses the HANG UP key on the keyboard. The UTS 30 then sends the following sequence to the host:

SOH RID SID DID DLE EOT STX ETX BCC

The host responds with the identical message. The UTS 30 then sends an acknowledgment (DLE 1). When the host responds with an acknowledgment, the UTS 30 disconnects (hangs up) the communications line.

The UTS 30 may disconnect automatically if a user-selectable timeout value has been set in the control page. When the timeout value is reached with no ring indicator or poll from the host, the UTS 30 disconnects (hangs up) the communications line. In this case, no disconnection sequence is sent to the host.

3.10.2. Disconnection at the Host Processor

Upon receipt of a disconnection message from the UTS 30, the host processor must acknowledge the message before disconnecting its end of the line.

3.11. HOST PROCESSOR PROGRAMMING SUGGESTIONS

3.11.1. Handling the Acknowledgment/Busy-Plus-Traffic Response

In a poll group, the UTS 30 multiplexer function can combine an acknowledgment from one station with any traffic response from another station.

When an acknowledgment/busy-plus-traffic response is returned by a station that just received host processor text, the acknowledgment/busy portion of the response is from that station and was not passed from another station by the multiplexer function. Possible acknowledgment/busy-plus-traffic poll responses from a station that just received host processor text are as follows:

- DLE 1 plus message-waiting or program-attention key code (3.9.2)
- DLE 1 plus peripheral selection delayed (UTS 30 rule 8)
- DLE 1 plus message-queued (UTS 30 rule 8)
- DLE 1 plus peripheral status (UTS 30 rule 8)
- DLE 1 plus text (poll response following host processor text containing a transmit function)
- DLE 1 plus THRU (UTS 30 rule 7)
- DLE ? plus message-waiting or program-attention key code (3.9.2)

Passing the acknowledgment/busy response by the multiplexer function does not take place, and all considerations concerning the passing of this response are eliminated, under the following conditions:

- When the host processor text to a station is followed by a specific poll to that station
- When each poll group has only one station and, therefore, a general poll is recognized only by that station

However, the use of general polls and the configuration of poll groups with more than one station produce the most efficient communications exchange (that is, the minimum number of messages).

The host processor may be programmed to handle acknowledgment/busy-plus-traffic responses resulting from general polls by retaining, at the line level, the address of the station from which the host processor expects polls an acknowledgment. If the station address contained in the response is that of the station from which an acknowledgment is expected, then both the acknowledgment/busy and the traffic portion of the response will be processed for that station. If, however, the station address contained in the response is different from the address of the station from which an acknowledgment is expected, then the acknowledgment/busy portion of the response will be processed for the station from which an acknowledgment is expected, and the traffic portion will be processed for the station whose address is in the response.

3.11.2. Passing the Acknowledgment/Busy Response in TEXT/SD, TEXT/PI, or TEXT/SD/PI Messages

Whenever TEXT/SD, TEXT/PI, or TEXT/SD/PI messages are being sent by the host processor, the acknowledgment in the response must not be interpreted as meaning a successful peripheral selection or successful completion of the peripheral operation. In the acknowledgment-plus-traffic combination shown in Table A-1 (peripheral status responses), it is possible for the acknowledgment portion of the response to be passed by the multiplexer function to another station; if the acknowledgment portion is passed to another station, the response to a general poll following the host processor text message will contain only the acknowledgment portion of the original acknowledgment-plus-traffic response. Therefore, the host processor must wait for a subsequent poll response containing the traffic portion of the original acknowledgment-plus-traffic response to determine the status of the peripheral selection and/or operation.

The following message sequence illustrates how the acknowledgment should be interpreted. In this sequence, the station whose RID is "1" and SID is "b" contains the UTS 30 second screen, whose SID is "c."

- | | | | |
|----|--------------------------------|---|----------------------------------|
| 1. | SOH 1 c t STX data DC2 ETX BCC | → | |
| 2. | SOH 1 P p ETX BCC | → | |
| 3. | | ← | SOH 1 e p DLE 1 STX data ETX BCC |
| 4. | SOH 1 P p DLE 1 ETX BCC | → | |
| 5. | | ← | SOH 1 c t DLE 4 ETX BCC |
| 6. | SOH 1 P p DLE 1 ETX BCC | → | |
| 7. | | ← | EOT EOT ETX BCC |

Explanation:

1. TEXT/SD/PI message directed to the printer through the station whose RID is "1" and SID is "b."
2. General traffic poll to the poll group whose RID is "1."
3. Acknowledgment-plus-traffic message where the traffic is text from the station whose RID is "1" and SID is "c." The acknowledgment was passed from the station that was sent the TEXT/SD/PI message in step 1 (station 1c).
4. General traffic poll with acknowledgment.
5. Message-queued (DLE 4) response. Originally, the station response was to contain acknowledgment plus message queued (DLE 1 DLE 4); however, the acknowledgment from the station was passed by the multiplexer function and had already been sent in step 3.
6. General traffic poll with acknowledgment.
7. No traffic.

3.11.3. Line Error Recovery

The UTS 30 is designed to allow recovery from communications line errors without loss or duplication of messages. The line error recovery rules discussed in 3.7 must be followed.

The host processor should follow these guidelines to facilitate line error recovery:

- The error recovery sequence should be completed when the line error occurs.
- The address of the station which was just sent host processor text and therefore owes the host processor an acknowledgment, should be retained.
- Not more than one station at a time should be put on the line in a state where it has an acknowledgment to send.
- The previous poll response type (such as UTS 30 text, acknowledgment, or acknowledgment-plus-THRU) should be retained.
- The address of the previous poll response should be retained.

4. UTS 30 and Host Processor Text Messages

4.1. GENERAL

The significant difference between the codes of Section 3 and Section 4 is that the communication codes of Section 3 operate outside the text message envelope.

The codes of Section 4 are host commands that occur within the text envelope; that is, between the STX and ETX characters.

This section defines the format for text messages and the text messages themselves. The host command is followed by the terminal response, if there is one. There are four major considerations:

- Text message format
- Terminal control codes
- Screen control codes
- Peripheral control codes

4.2. TEXT MESSAGE FORMAT

4.2.1. General Format

The general format for sending text messages from the host processor to a UTS 30 and from a UTS 30 to the host is shown in Figure 4-1. Note that the text message is bracketed between the STX and ETX characters.

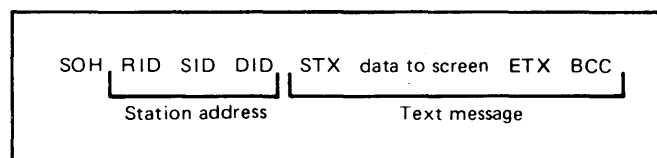

Figure 4-1. Text Message Format

4.2.2. Start-of-Entry (SOE) (RS)

The text message begins with the SOE (start-of-entry) position sequence (row and column) (or with the home position sequence, if no SOE character is used).

4.2.3. Text Message Transmission

The type of data sent in a message transmitted from the UTS 30 to the host processor depends on the code sent by the host or selected by the UTS 30 operator through the control page. Data sent begins with the SOE character and extends to and includes the character under the cursor. The nonsignificant spaces at the end of a field and at the end of a line (except the line containing the cursor) are suppressed and are not transmitted to the host.

The three transmission variations are described in the following paragraphs.

4.2.3.1. Transmit All Fields (ESC DC1)

This code requests transmission of all fields from the UTS 30. In this mode, all data from the SOE through the cursor position is sent; all characters outside FCC fields, all protected and unprotected FCC fields, and their associated FCC codes are transmitted. Protected characters designated by SO/SI codes are sent as normal characters not bracketed by SO and SI characters. (See 4.4.3.)

The ESC DC1 code must be sent as the last sequence before the ETX character in a text message from the host processor.

4.2.3.2. Transmit Variable Fields (DC1)

This code requests transmission from the UTS 30 of all unprotected data including data outside FCC fields, unprotected FCC fields, and their associated FCCs. All SO/SI-protected characters found outside a protected FCC field will be replaced by a SUB control character (1A hexadecimal). The location of protected FCC fields is sent, but the fields and any SO/SI-protected characters they may contain are suppressed.

The DC1 code must be sent as the last character before the ETX character in a text message from the host processor.

4.2.3.3. Transmit Changed Fields (ESC t)

The host uses this code to request transmission from the UTS 30 of only the fields that have been changed since the changed-field indicators were last cleared and their associated FCC codes. Characters protected by the SO/SI function within the changed fields are sent without being bracketed by the SO/SI codes.

4.2.4. Timing Considerations (NUL)

The use of screen editing functions embedded in a data message may cause the communications queue to overflow. The operator cannot press the keys fast enough to overload the queue when editing functions are entered from the keyboard. Overflow is possible, however, in long communication messages that contain multiple editing functions preceding the data, such as scrolling, which requires multiple delete and insert line functions. The recommended procedure to avoid queue overflow is insertion of sufficient NUL characters after each editing function to allow the UTS 30 adequate time to execute the command.

The NUL codes required to provide time-fill for each UTS 30 editing function are shown in Table 4-1. Values shown in the table reflect worst-case conditions, including communications line speed. All NUL values are calculated for a line speed of 9600 bits per second. The number of NULs required after each editing function to avoid queue overflow is determined as follows:

1. No NULs are required if the total message, including all editing functions and text, is less than 1024 bytes. (This assumes that the queue is emptied between messages.)
2. If the total message size is greater than 1024 bytes, each editing function must be followed by the number of NULs indicated in Table 4-1 for the specific editing function.

If NUL requirements for a UTS 400 are in effect, the number of NULs used after each editing function will usually be adequate for UTS 30 operation. A comparison of UTS 20, UTS 30, UTS 40, and UTS 400 NUL requirements is provided in Appendix G.

If calculation of the UTS 30 execution times is required to determine NUL requirements more precisely, refer to Appendix G.

Table 4-1. UTS 30 NUL Requirements

Function	Number of NULs Required for Editing Functions	Control Code
Backward tab	29	ESC z
Forward tab	34	HT
Delete in display	32	ESC C
Delete line	54	ESC k
Delete in line	10	ESC c
Erase unprotected data	55	ESC a
Erase display	32	ESC M
Erase to EOF	44	ESC K
Erase to EOL	11	ESC b
Insert in display	32	ESC D
Insert line	22	ESC j
Insert in line	10	ESC d
Duplicate line	39	ESC y
Cursor to home	9	ESC e
Position cursor	10	ESC VT YXSI
FCC generate	89	US YXMN
FCC clear	10	ESC w
Clear changed FCCs	51	ESC u

4.3. TERMINAL CONTROL CODES

This group of codes controls terminal functions that do not directly affect screen data.

4.3.1. Call Error Log (ESC P)

The host processor uses this code to request the UTS 30 error log. The text message containing the ESC P code must be addressed to the primary RID SID address of the UTS 30 (not the SID of the second screen memory).

After receiving the ESC P code from the host, the UTS 30 sends the error log within a text message. The error log has priority over any other text messages being sent from the UTS 30. For the error log format, see Appendix M.

4.3.2. Clear Error Log (ESC R)

This command resets the UTS 30 error log to zero. The error log is not cleared by pressing the power switch to the ON position or by pressing the RESET PUSH button.

4.3.3. Initiate Power-On Confidence Test (ESC Q)

The host uses this command to initiate the UTS 30 POC tests. These tests reside in the terminal and are normally activated by pressing the power switch to the ON position.

After receiving the ESC Q code from the host processor, the UTS 30 acknowledges the receipt of the code, waits for an acknowledgment from the host processor, and then initiates the POC test. The UTS 30 will perform the full POC test if the (PARAM) field setting is (HP/YS). The UTS 30 does not respond to polls during the POC test.

A discussion of the POC test is given in Appendix D.

4.3.4. Call Control Page (ESC o)

The following special message considerations must be observed when the host calls the control page.

- The station address in the message from the host processor must contain the SID for the specific terminal screen control page being requested. (Remember that the displayed screen and the second screen have separate SIDs and separate control pages. See the UTS 30 operator's reference, UP-9798, for more information.)
- The first occurrence of the ESC o code calls the control page to the screen with the cursor located in the first unprotected position of the PRNT field.
- NUL is used for time-fill to allow functions to be completed.
- HT is entered the appropriate number of times to tabulate the cursor through the unprotected fields of the control page to the field where the desired function is to be inserted.
- The second occurrence of the ESC o code sets the control page codes and returns the control page to storage.

NOTE:

The terminal keylock must be in the SET UP position for the host's entries in the (PARAM) and MM fields to be effective.

4.3.5. Lock Keyboard (ESC DC4)

This command makes all keyboard keys inoperative except for the program attention keys. The keyboard remains locked until a text message is received from the host processor or until the UTS 30 operator presses the keyboard UNLOCK key.

4.3.6. Load Optional Character Set to UTS 30 (ESC SO)

The sequence sent from the host to load an optional character set to UTS 30 memory is shown in the following. See Appendix L for definitions and operating instructions.

STX ESC SO 041? XXYYY XXYYY MH MV text ETX BCC

4.3.7. Request Character Set ID from UTS 30 (ESC U) and Terminal Response

The following command is used by the host processor to request the optional character set identification. See Appendix L for definitions and operating instructions.

STX ESC U ETX BCC

The UTS 30 response is:

STX ESC VT 20 20 00 SI ESC SO; 0 0 7 XX PP XX Q __ ETX BCC

4.3.8. Load Optional Character Set to Diskette (DC3 DC3)

The following sequence is sent from the host to cause the UTS 30 to load an optional character set to the 8439 diskette subsystem. See Appendix L for definitions and operating instructions.

STX DC3 DC3 041? XXYYY XXYYY MH MV text ETX BCC

4.4. SCREEN CONTROL

Screen control codes consist of the following six basic classes:

- Cursor positioning (4.4.1)
- Field control characters (FCCs) (4.4.2)
- SO/SI-protected characters (4.4.3)
- Special emphasis characters (4.4.4)
- Editing functions (4.4.5)
- Displayable characters (4.4.6)

4.4.1. Cursor Positioning

4.4.1.1. Cursor Address Sequence (ESC VT Y X SI RS)

Text transmitted from the host processor to the UTS 30 is placed on the screen, starting at the cursor address. The format for the cursor address in a text message is shown in Figure 4-2.

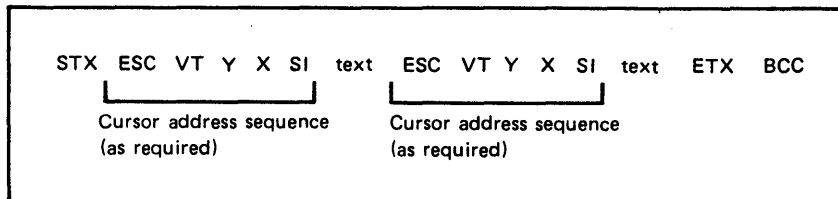

Figure 4-2. Cursor Address Sequence

The following defines the cursor address sequence:

- ESC indicates that the following character or characters are part of a control sequence.
- VT indicates the next two characters are the cursor address.
- Y is the horizontal (row) coordinate on the screen where the cursor is to be placed (Appendix B).
- X is the vertical (column) coordinate on the screen where the cursor is to be placed (Appendix B).

A text message sent from the UTS 30 to the host processor begins with a cursor address. It may be the start-of-entry character (SOE) or the home position. The SOE address is:

STX ESC VT Y X NUL SI RS text ETX BCC

The home position address is:

STX ESC VT SP SP NUL SI text ETX BCC

See Appendix G for appropriate NUL time-fill values.

4.4.1.2. Cursor to Home (ESC e)

This code causes the cursor to move to the first display position of the first line in the upper left corner of the screen (home position). This position is row 1, column 1 on the screen.

4.4.1.3. Request Cursor Address (ESC T) and UTS 30 Response

This code requests the UTS 30 terminal to send its cursor address. Only one ESC T code can be used in a single text message. In addition, the ESC T code should not be used in the same message with a peripheral initiation command or with any other special host processor command. After receiving the ESC T code from the host, the UTS 30 responds to the next traffic poll with a text message containing only the following sequence:

STX ESC VT Y X NUL SI ETX

VT, Y, and X are as defined in 4.4.1.1. These Y and X positions are the cursor coordinates after the text accompanying the ESC T code has been displayed on the screen. The UTS 30 keyboard is locked and remains locked until the host sends another STX...ETX message.

4.4.1.4. Cursor Return (CR)

This code causes the cursor to advance to the first display position on the next line. If the cursor is on the last line of the screen, it advances to the first display position of the first line (home position). This control code can be displayed (4.4.6.3) or printed (4.5.11).

4.4.1.5. Scan Up (ESC f)

This code causes the cursor to move up one line in the same column. If the cursor is in the first line at the top of the display, it moves to the same column in the last line of the display.

4.4.1.6. Scan Left (ESC g)

This code causes the cursor to move to the left one position. If the cursor is in the first character position of a line, it moves to the last character position of the preceding line. If the cursor is in the home position, it moves to the last character position of the last line.

4.4.1.7. Scan Right (ESC h)

This function causes the cursor to move to the right one character position. If the cursor is in the last character position of a line, it advances to the first character position of the following line. If the cursor is in the last character position of the last line, it moves to the first display position of the first line (home position).

4.4.1.8. Scan Down (ESC i)

This function causes the cursor to move down one line in the same column. If the cursor is in the last line of the display, it moves to the same column position in the first line.

4.4.2. Field Control Characters (FCCs)

Field control characters can define the format of data on the screen, establish the start and end of each field, and assign desired characteristics to each field. FCCs can be assigned by the host, by a user program, or by the operator. The UTS 30 operator's FCC key code is in Appendix K.

The UNISCOPE-mode system control software provides two types of FCCs: primary FCCs and expanded FCCs. The basic UTS 30 and programmable UTS 30 support both. However, when expanded FCCs are sent to the host or peripherals, they may be translated to primary FCCs if the "transmit expanded FCCs" parameter (TF/EF in the (PARAM) field in the control page) is set to disable expanded FCC transmission. In addition, the primary FCCs are affected by the TF parameter. If it is set to "enable," non-expanded FCCs are translated by hexadecimal 40; if TF is set to "disable", they are translated by hexadecimal 30. The translation table is in Appendix K.

4.4.2.1. Primary FCC Characteristics

These characteristics are defined in Table 4-2.

- Intensity variations: characters appear normal, low-intensity, blinking, off
- Tab stop
- Field entry variations: unrestricted data, alphabetic data only, numeric data only, or no data (field protected)
- Field justification

The bit sequences are detailed in Appendix K.

Table 4-2. Primary FCC M and N Bit Definitions

Bit	Designation	Definition										
M	1,0	Intensity Determine video intensity: <table border="0"> <tr> <td><u>Bits 1,0</u></td> <td><u>Display</u></td> </tr> <tr> <td>00</td> <td>Normal intensity</td> </tr> <tr> <td>01</td> <td>Off intensity</td> </tr> <tr> <td>10</td> <td>Low intensity/reverse video</td> </tr> <tr> <td>11</td> <td>Blinking</td> </tr> </table>	<u>Bits 1,0</u>	<u>Display</u>	00	Normal intensity	01	Off intensity	10	Low intensity/reverse video	11	Blinking
	<u>Bits 1,0</u>	<u>Display</u>										
	00	Normal intensity										
	01	Off intensity										
	10	Low intensity/reverse video										
	11	Blinking										
	2	Changed data	0 = Changed field; 1 = Unchanged field (See 4.4.2.3.3.)									
3	Tab stop	0 = tab stop; 1 = no tab stop										
4	Reserved	Always set to 1										
5	Reserved	Always set to 1										
6	Reserved	Always set to 0										
7	Reserved	Always set to 0										
N	1,0	Data entry type Determine type of data entry: <table border="0"> <tr> <td><u>Bit 1,0</u></td> <td><u>Display</u></td> </tr> <tr> <td>0 0</td> <td>Unrestricted entry</td> </tr> <tr> <td>0 1</td> <td>Alphabetic entry only</td> </tr> <tr> <td>1 0</td> <td>Numeric entry only</td> </tr> <tr> <td>1 1</td> <td>Protected; no data allowed</td> </tr> </table>	<u>Bit 1,0</u>	<u>Display</u>	0 0	Unrestricted entry	0 1	Alphabetic entry only	1 0	Numeric entry only	1 1	Protected; no data allowed
	<u>Bit 1,0</u>	<u>Display</u>										
	0 0	Unrestricted entry										
	0 1	Alphabetic entry only										
	1 0	Numeric entry only										
	1 1	Protected; no data allowed										
	2	Right-justification	0 = Not right-justified; 1 = right-justified. Bit 2 is ignored if the field is protected.									
3	Reserved	Always set to 0										
4	Reserved	Always set to 1										
5	Reserved	Always set to 1										
6	Reserved	Always set to 0										
7	Reserved	Always set to 0										

4.4.2.2. Expanded FCC Characteristics

These characteristics are defined in Table 4-3. All primary FCC characteristics are included, with the following additional characteristics:

- Additional intensity variations: high-intensity reverse-video background; low-intensity reverse-video background; background blinks from high-intensity reverse video to low-intensity reverse video; background blinks from low-intensity reverse video to off; characters blink from high to normal intensity against a reverse-video background.
- Protection of special emphasis characters: the underscore, vertical column separator, and strike-through characters defined in 4.4.4 are protected, but alphanumeric characters that occupy the same space can be changed.

The bit sequences are given in Appendix K.

Table 4-3. Expanded FCC M and N Bit Definitions

	Bit	Designation	Definition
M	0	Video	0 = On; 1 = Off
	1	Intensity	0 = Normal; 1 = Low
	2	Changed field	0 = Changed; 1 = Not changed
	3	Tab stop	0 = Tab stop; 1 = No tab stop
	4	Reserved	Used for Kanji
	5	Special emphasis	0 = Special emphasis not protected 1 = Special emphasis protected
	6	Reserved	Always set to 1
	7	Reserved	Always set to 0
N	0,1	Data type and protection function	00 = Unrestricted data entry 01 = Alphabetic only 10 = Numeric only 11 = Protected. No data allowed
	2*	Right justification	0 = Not right-justified; 1 = Right-justified
	3	Blink	0 = No blink; 1 = Blink
	4	Intensity	0 = Normal video; 1 = Reverse video
	5	Reserved	Always set to 1
	6	Reserved	Always set to 0
	7	Reserved	Always set to 0

*Bit 2 is always set to 0 if the field is protected.

A UTS 30 function is available to translate expanded FCCs to UTS 400-compatible FCCs. See Table K-6.

4.4.2.3. FCC Codes

Two specific sequences are available for generating the FCC functions in the UTS 30. They are the same for both primary and expanded FCCs. Both sequences are sent within the STX—ETX envelope.

4.4.2.3.1. FCC Sequence with Cursor Positioning (US Y X M N)

The sequence shown below generates an FCC at the location specified by Y and X. Its position in the text message is:

text US Y X M N text

where:

US

are the control characters that indicate an FCC field is to follow.

Y

is the number of the row in which the FCC is to be placed.

X

is the number of the column in which the FCC is to be placed. X and Y are independent of cursor position.

M

is an ASCII character defined in Tables 4-2 and 4-3.

N

is an ASCII character defined in Tables 4-2 and 4-3.

ASCII codes are given in Appendix K.

4.4.2.3.2. Immediate FCC Sequence (EM M N)

The immediate FCC sequence shown below generates an FCC at the current address of the cursor. Its position in the text message is:

text EM M N text

where:

EM

are the control characters that indicate that the next two characters are an FCC sequence.

M

is the same character used in the FCC sequence with cursor positioning.

N

is the same character used in the FCC sequence with cursor positioning.

4.4.2.3.3. Clear Changed Fields (ESC u)

The changed-field bit in the M byte (Tables 4-2 and 4-3) indicates whether the FCC field has been changed since it was generated, or since the changed-field bit was last cleared. This bit change is not visible to the operator.

When an FCC is generated by the host, the changed-field bit can be set to either 0 or 1. A change in the field sets the changed-field bit to 0. It remains set to 0 until it is cleared (reset to 1) by a command from the host or by the UTS 30 operator.

By sending an ESC u code, the host can clear the changed-field bits without regenerating each FCC or altering data within the field.

The changed-field indicators are used in conjunction with the transmit-changed-fields function (4.2.3).

4.4.2.3.4. Clear FCCs (ESC w)

This code erases the FCC located at the cursor position or the first FCC to the left of the cursor if the cursor is not on an FCC position.

4.4.2.3.5. FCC Tab Stop (HT or ESC z)

The tab forward (HT) or tab backward (ESC z) codes position the cursor either at the nearest tab character or at the first position of the nearest FCC field. An advantage of using an FCC as a tab stop is that it does not occupy a screen location; the conventional tab stop does.

4.4.3. SO/SI-Protected Characters

4.4.3.1. SO/SI-Protected Fields Used Alone

The shift-out (SO) character is a control character indicating that the data that follows cannot be changed or deleted by operator control (in other words, the characters are protected) until a shift-in (SI) character is reached. A screen display of such a transmission is shown in Figure 4-3. This example assumes that the SO/SI is not used with FCCs.

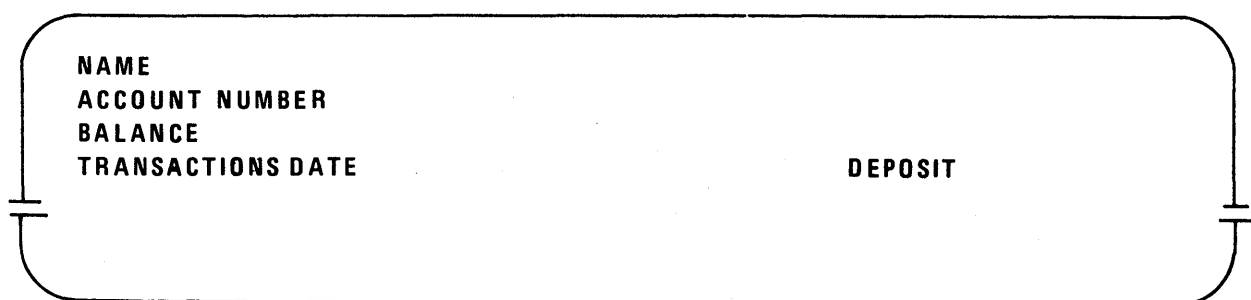

NOTE: Protected fields are displayed on the screen without any visible markers. Operator overwriting is not possible on these fields.

Figure 4-3. SO/SI-Protected Format — Screen Display

Figure 4-4 shows the information transfer. Italics represent protected fields which will be displayed on the screen without visible markers.

```

SOH RID SID DID STX ESC e SO NAME SI CR SO ACCOUNT SP NUMBER SI CR SO BALANCE SI CR
SO TRANSACTIONS SP SP DATE SI SP SP SP SP SP SP SP SP SP SP SO DEPOSIT SI ... ETX BCC
    
```

Figure 4-4. SO/SI-Protected-Information Transfer from Host to UTS 30

4.4.3.2. SO/SI- and FCC-Protected Fields Used Together

FCC and SO/SI fields may be intermixed in a text message with the restriction that an SO/SI character cannot override the FCC character. This means that if an SO coincides with the first character of an FCC-unprotected field, the character remains unprotected. Therefore, when an SO/SI is used within a FCC field (protected or unprotected), the first position of the FCC field cannot be SO/SI-protected; however, all other characters within that FCC field can be SO/SI-protected characters.

Note that, within an FCC-protected field, the SO/SI protection function will be ignored since the protection characteristic is already transmitted in the FCC sequence.

An example of SO/SI-protected data fields used in conjunction with an unprotected FCC is shown in Figure 4-5. As shown in the figure, the FCC designating a reverse-video field has been moved to the left to avoid conflict with the SO/SI field and still retain the protected SO/SI field.

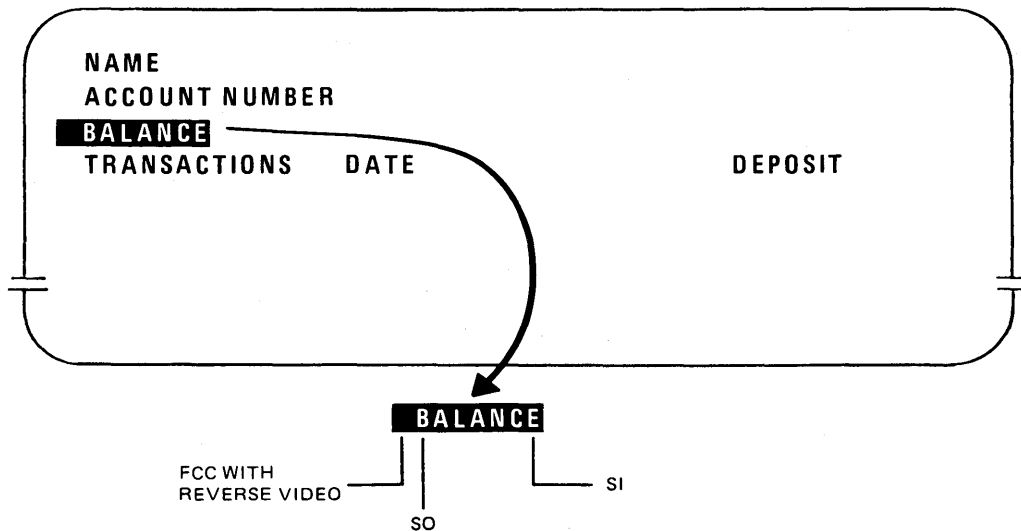

Figure 4-5. Format Using Both SO/SI-Protected and FCC Codes

Transmission of the unprotected data and the FCC character occurs as shown in Figure 4-6. In place of the protected data, a SUB control character (1A hexadecimal) is sent for each SO/SI-protected character string.

```
SOH RID SID DID STX ESC VT SP SP NUL SI SUB SP JOHN SP HENRY SP BROWN
CR SUB SP 1229AB23872 USYXMN SUB SP $1995.37 CR SUB SP 19JUN79 ... ETX BCC
```

Figure 4-6. SO/SI Protected and FCC Information Transfer

4.4.4. Special Emphasis Characters

Each screen location has special emphasis characters associated with it. These nondestructive display characters can occupy a screen position with a data character. The following special emphasis characters are available singly or in combination.

- Column separator — Places a vertical line to the left of the character. The line is the full length of the character cell, and connects with adjacent column separator characters.
- Underscore — Places an underline beneath the character. The line is the full width of the character cell and connects with adjacent underscore characters.
- Strike-through — Places a horizontal line through the middle of the displayed character. The line is the full width of the character cell and connects with adjacent strike-through characters.

FCCs can protect the special emphasis characters without protecting data characters. See the UTS 30 operator's reference, UP-9798.

On the programmable UTS 30, the strike-through character and the optional character set cannot be used together. The EM entry in the control page determines which function is enabled. (See the UTS 30 operator's reference, UP-9798.)

Special emphasis functions are generated by using an ESC code, a series of ASCII control characters to indicate the beginning of the special emphasis area, and an ASCII SP character to mark the end of the function. (See Appendix B for examples.)

4.4.4.1. Code Sequence to Create or Replace Special Emphasis (ESC ZZ text ESC SP)

The special emphasis codes are ESC sequences that are sent with the text they are to emphasize. This sequence generates the special emphasis characters. The emphasis generated depends on ZZ, an ASCII character (or hexadecimal code) chosen from Table B-6 (Appendix B). To replace emphasis on existing text, SUB characters equal to the number of text characters to be changed are sent instead of text.

4.4.4.2. Code Sequence to Add Special Emphasis (ESC Y ZZ text ESC SP)

This sequence adds a designated emphasis characteristic without changing those already in effect. Choose the appropriate ASCII code from Table B-6. SUB characters equal to the number of text characters are sent instead of text.

4.4.4.3. Code Sequence to Delete Special Emphasis (ESC Z ZZ text ESC SP)

This sequence deletes an emphasis characteristic without changing others already in effect. Designate the characteristic by choosing the appropriate ASCII character from Table B-6. SUB characters equal to the number of text characters are sent instead of text.

4.4.4.4. Multiple Special Emphasis Codes in One Text Message

Multiple special emphasis codes can be included in one text message, without being additive. The specified emphasis extends only to the next ESC, not to the ESC SP which terminates the function. See the last example in Figure B-3 (Appendix B).

4.4.5. Editing Functions

4.4.5.1. Erase to End of Display (ESC a)

This code erases all unprotected characters from the cursor position to the end of the display. FCCs and SO/SI-protected fields are not erased.

4.4.5.2. Erase to End of Line (ESC b)

This code erases all unprotected characters from the cursor position to the end of the field in which the cursor is located or to the end of the line, whichever occurs first. FCCs and SO/SI-protected fields are not erased. If the cursor is in a protected field, this function cannot be performed.

4.4.5.3. Erase to End of Field (ESC K)

This code erases all unprotected characters from the cursor position to the end of the field in which the cursor is located or to the end of the display, whichever occurs first. FCCs and SO/SI-protected fields are not erased. If the cursor is in a protected field, this function cannot be performed.

4.4.5.4. Erase Display (ESC M)

This function erases all characters and FCCs from the cursor position to the end of the display. Since FCCs are erased, any protected data in the display is also erased.

4.4.5.5. Delete in Line (ESC c)

This code causes the character at the cursor position to be deleted. All characters following the cursor position in that field, up to the end of the line, are backspaced one character location. A space appears at the end of the field or at the end of the line, whichever occurs first. The cursor does not move from its original position during this function.

4.4.5.6. Delete in Display (ESC C)

This code causes the character at the cursor position to be deleted. All characters following the cursor position in that field, up to the end of the display, are backspaced one character position. A space appears at the end of the field or at the end of the display, whichever occurs first. The cursor does not move from its original position during this function. If the cursor is in a protected field, this function cannot be performed.

4.4.5.7. Delete Line (ESC k)

This code causes the line in which the cursor is located to be deleted and replaced by the next line down. Any FCCs and protected data in the deleted line are also deleted. All following lines including FCCs and protected data are moved up one line, and a blank line (without FCCs) appears at the bottom of the screen. The cursor does not move from its original position during this function.

4.4.5.8. Insert in Line (ESC d)

If the cursor is located in an unprotected field, this code causes the character at the cursor position, and all following characters to the end of that field or the end of the line, whichever occurs first, to be advanced one character position. A space appears at the cursor position. The character (if any) in the last character position of the field or the line is deleted. If the cursor is in a protected field, this function cannot be performed.

4.4.5.9. Insert in Display (ESC D)

This code causes the character at the cursor position, and all following characters to the end of that field or the end of the display, whichever occurs first, to be advanced one character position. The character (if any) in the last character position of the field or the display is deleted. If the cursor is in a protected field, this function cannot be performed.

4.4.5.10. Insert Line (ESC j)

This code causes all data and FCCs in the line in which the cursor is located, and all following lines of the display including FCCs and protected data, to be moved down one line. A blank line (without FCCs) appears at the line occupied by the cursor.

4.4.5.11. Line Duplication (ESC y)

This code causes the contents of the line in which the cursor is located to be duplicated on the line directly below. The cursor is repositioned to the corresponding character position on the duplicated line. Any data originally on the line where the duplicated line appears is deleted.

4.4.5.12. Tab Forward (HT)

If the tab stop is an FCC tab stop, this function causes the cursor to be placed on the tab stop position. If the tab was set with the tab stop code (ESC HT), the cursor is placed in the first unprotected position to the right of the tab stop. If there are no tab stops, or if the entire remaining display is protected, the cursor moves to the home position or to the first unprotected position on the screen.

4.4.5.13. Tab Stop (Set) (ESC HT)

This code places a tab stop code in display storage at the cursor position and advances the cursor one position. The tab stop code appears as a space on the display screen.

4.4.5.14. Tab Backward (ESC z)

This code initiates a tab operation in the opposite direction from that of a normal (forward) tab operation. The cursor stops over the tab stop position if the stop is an FCC tab stop; if the stop was set by the tab stop code (ESC HT), the cursor stops at the first unprotected position to the right of the tab stop.

4.4.6. Displayable Characters

These codes have displayable attributes on the screen. If they have additional functions, these are referenced.

4.4.6.1. Blank Space (SP)

This code is placed in display storage; that is, it occupies an address in the screen memory, but appears as a blank space on the screen.

4.4.6.2. Start of Entry (SOE) (RS)

This code puts a triangular marker at the start of a text message on the screen. (See 4.2.2.)

4.4.6.3. Cursor Return (CR)

This code performs a cursor return on the screen. It can be displayed momentarily by entering the CC/ON option in the (PARAM) field. (See Appendix J.)

4.4.6.4. Blinking Start Marker (FS)

This code places a triangular blinking marker at the cursor position.

4.4.6.5. Blinking End Marker (GS)

This code places a triangular blinking marker at the cursor position. These start and end triangles are mirror images of each other.

4.4.6.6. Display of Control Characters

Entering CC/ON in the (PARAM) field on the control page causes control characters to be displayed on the screen. (See Appendix J.)

4.5. PERIPHERAL CONTROL

These codes are sent from the host to the UTS 30 for control of the printer and diskette subsystems. In data transfers to peripherals, the SOE character is always suppressed. The data to be sent starts with the first character to the right of the SOE character, or with the character in the home position if no SOE is present. These codes are sent as the last sequence before the ETX character in the text message.

4.5.1. Peripheral Initiation Codes

4.5.1.1. Transfer All Fields (ESC G)

This code causes the UTS 30 to send to peripherals all characters from SOE (or home position if there is no SOE) through the cursor position. FCC sequences are included. Spaces at the ends of fields are suppressed except in front of SO/SI-protected fields. Spaces at ends of lines are suppressed (except in the line containing the cursor). The DLE code is used in place of the CR code to indicate the ends of lines.

4.5.1.2. Transfer Variable Fields (ESC F)

This code causes the UTS 30 to send to peripherals only the unprotected fields between the SOE (or home position) through the cursor position. FCC sequences (of the unprotected fields) are transferred. Spaces at the ends of lines are suppressed, except in the line containing the cursor. The DLE code is used in place of the CR code to indicate the ends of lines.

4.5.1.3. Transfer Changed Fields (ESC E)

This code causes the UTS 30 to send to peripherals only the changed fields between SOE (or home position) through the cursor position. FCC sequences are included for each changed field transferred. Spaces at the ends of fields are suppressed except in the line containing the cursor. The DLE code is used in place of the CR code to indicate the end of a line.

4.5.1.4. Print (DC2)

This code causes the UTS 30 to send to the printer all characters from the SOE (or home position) through the cursor position. FCC sequences are not included. Spaces at ends of lines are suppressed except in the line containing the cursor. The CR code is used to indicate the ends of lines.

4.5.1.5. Print Form (ESC H)

This code causes the UTS 30 to send to the printer all characters from the SOE (or home position) through the cursor position. Protected characters are replaced by spaces (SP) in the data stream. FCC sequences are not included. Spaces at the ends of lines are suppressed, except in the line containing the cursor. The CR code is used to indicate the ends of lines.

4.5.1.6. Print Transparent (ESC DC2)

This code causes the UTS 30 to send to the printer all characters from the SOE (or home position) through the cursor position. Spaces are not suppressed. FCC sequences are not included. Cursor returns (CR) are suppressed.

4.5.2. Control Codes for Printers

The UTS 30 is transparent (passive) to these functions. However, these codes may be displayed on the screen if the CC/ON option in the (PARAM) field is chosen. (See Appendix J.) If the last character of a message is not a print initiation character (CR, VT, LF, FF), the terminal adds a line feed (LF) code to the message.

4.5.2.1. Line Feed (LF)

This code causes the printer to perform a line feed operation. The LF code is placed in display storage at the cursor position and appears as a blank on the screen.

4.5.2.2. Form Feed (FF)

When sent to a printer, this code causes the printer to perform a form feed operation. The FF code is placed in display storage at the cursor position and appears as a blank on the screen.

4.5.2.3. Vertical Tab (VT)

When sent to a printer, this code causes a vertical tab operation to be performed by the printer. The VT character should not be immediately preceded by an escape character unless a cursor-positioning sequence is intended. The VT code is placed in display storage at the cursor position and appears as a blank on the screen.

4.5.2.4. Carriage Return (CR)

The cursor return code, when sent to a printer, causes the printer to perform a carriage return (new line). This character is the same as the cursor return character discussed in 4.4.1.4 and 4.4.6.3.

4.5.2.5. Search (CAN)

This code, preceded by an SOE (RS) and followed by an appropriate command, specifies a search operation, opens a file, creates a file, or closes a file on a diskette.

The search operations are as follows:

- | | |
|---------------------------|--|
| RS CAN xxxx | Positions the read/write head at the screen block number designated by xxxx (0001-9999). |
| RS CAN xxxx/header | Searches for the screen block number designated by xxxx (0001-9999), then searches that block and subsequent blocks for the header. The header may contain up to 16 characters. Displays the screen block when a match is found. FCCs on the screen are ignored in the header. |

The file operations are as follows:

RS CAN filename.ext[/USER #]

where:

filename

1- to 8-character name of a file. It cannot include spaces, periods, or commas, and must end with a period.

ext

1- to 3-character optional extension of a filename.

/USER #

user number for the file. It is required to open an existing file. If the file is being created, it is assigned the specified user number, or the active user number of the terminal if no number is specified.

Opens or creates files. If the diskette specified in the (**XFER**) field contains the specified file name, the file is opened.

- | | |
|---------------------|---|
| RS CAN close | Closes the file on the diskette specified by the prior "open" command. There can be no period after the word "close". |
|---------------------|---|

5. UTS 30 Graphics Messages

5.1. GENERAL

Graphics messages are special cases of text messages. They are enclosed within the STX . . . ETX text envelope like the messages of Section 4.

This section defines the format and the contents of graphics messages.

A program must be loaded into the UTS 30 before graphics messages from the host can be accepted. Terminal microcode interprets graphics protocol strings and translates them into internal "primitives," which are then executed. There is not necessarily a one-to-one relationship between the protocol strings and the primitives.

5.2. GRAPHICS MESSAGE FORMAT

The general format for sending graphics messages from the host to the terminal is shown in Figure 5-1. Note that the graphics protocol string is bracketed between STX and ETX, just as alphanumeric messages are.

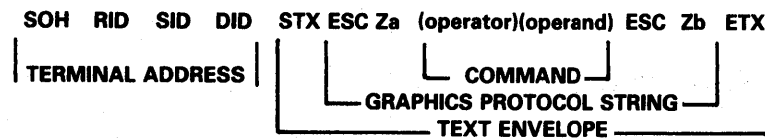

Figure 5-1. Graphics Message Format

NOTE:

ESC Z b is not required. A graphics protocol string may be terminated by ETX. See 5.3.4 and 5.3.5.

5.2.1. Graphics Protocol String

A text message can contain one or more protocol strings. Each graphics protocol string begins and ends with an ESC Z sequence. These are UNISCOPE host protocol commands which cause the UTS 30 screen handler to change display modes. These sequences are summarized in Table N-1.

5.2.2. Graphics Commands

Graphics protocol strings contain one or more graphics commands. Each command consists of an operator, and optionally, one or more operands.

An operator defines the function of the command, such as the command to draw a circle. Operators are defined in section 5.4.

The operand defines characteristics of the operator, for example the radius of the circle. The number and type of operands vary for each operator. An operand consists of a series of characters representing a signed or unsigned integer, or a character string. The series is terminated by a valid delimiter, the operator for the next command, or an ETX. Operand format is defined in section 5.5.

Table N-1 summarizes the kinds of operators, the type and number of operands each requires, the default designations for those that have defaults, and the paragraphs in the text where each can be found.

5.2.3. Protocol Errors

Invalid entries in a graphics command are not reported as errors; instead, they prematurely terminate the command. The entire command is discarded and must be reentered.

5.3. HOST COMMANDS TO DEFINE GRAPHICS DISPLAY MODES

5.3.1. Enter Graphics Mode (ESC Za)

Receiving this command causes the screen handler to disable the alphanumeric processor and enable the graphics processor. It also turns off the alphanumeric display and turns on the graphics display. If the graphics display is already on, it is not affected.

5.3.2. Enter Merged Mode (ESC Zc)

This command causes the screen handler to enable both the graphics processor and the alphanumeric processor. The graphics display is overlain by the alphanumeric display. This command occurs within a graphics sequence; it cannot begin or end the sequence.

5.3.3. Exit Graphics Mode; Replace Graphics Display (ESC Zb)

This command causes the screen handler to disable the graphics processor and reenables the alphanumeric processor. It also causes the graphics display to be replaced by the alphanumeric display.

5.3.4. Exit Graphics Mode; Retain Graphics Display (ETX)

If a graphics protocol string is terminated with ETX instead of with ESC Zb or ESC Zc, the graphics processor is disabled and the alphanumeric processor is enabled. However, the

5.3.5. Partial Message (ETB ETX)

There are two cases in which partial messages may be transmitted. If a message is more than one block long, the host automatically adds ETB ETX at the end of the block, indicating a partial message. This sequence is transparent to the terminal; it does not cause the terminal to leave graphics mode and does not affect the display. The remainder of the message is sent in the following block or blocks.

The other case is when the host arbitrarily breaks the message within an operand by sending ETX. The terminal leaves graphics mode, and the rest of the message must be preceded by an STX ESC Za.

5.3.6. Send Graphics to Printer (ESC DC2)

This sequence within a graphics protocol string causes the current graphics screen to be sent to a printer. Since ESC DC2 is a normal peripheral initiation command from the host (section 4.5.2.4), it must be accompanied by a device selection. This sequence does not cause a mode change or indicate the end of a graphics protocol string.

5.4. GRAPHICS COMMANDS

Operators consist of one or two ASCII characters between 20 and 7E. Operators are of four kinds, and must be entered in this order: control, moving, drawing, and attributes. The operators are defined in the following paragraphs. The format of the operands is defined in section 5.5.

5.4.1. Initialize Graphics

Operator:

ZI Initializes the graphics processing capability and prepares it to respond to line drawing commands. All graphics commands are set to their default values and internal system controls and processing facilities are reset to their original state.

Operands: Null operands are acceptable for this command. However, two operands (unsigned integers) representing the level and revision numbers of the protocol may be used.

5.4.2. Initialize View Surface

Operator:

ZO This command causes the system to perform whatever run-time functions are necessary to obtain access to and to select the view surface. Therefore, it must precede the "select view surface" command (5.4.3).

Operand: This command uses the same operand used in the "select view surface" command (5.4.3).

5.4.3. Select View Surface

Operator:

ZS This command specifies the view surface on which images will appear. The UTS 30 has three view surfaces: first screen, second screen, and an optional plotter. More than one view surface can be selected within a protocol string. Each command to select a view surface must be preceded by a command to initialize that view surface.

Operand: This command requires one operand (an unsigned integer) which designates the view surface as follows:

First screen — 0
Second screen — 2
Optional plotter — 1

NOTE:

Data sent to the second screen is not displayed; it may be transferred to a peripheral.

5.4.4. Terminate View Surface

Operator:

ZC This command terminates access to the view surface specified in the operand. Any pending graphic images are output to the view surface if appropriate. Graphic controls and attributes pertaining to that surface are no longer retained. This command will be regarded as a protocol error if it has not been preceded in the protocol string by a "select view surface" command. This command is not necessary to end every graphics string.

Operand: This command uses the same operand used to select the view surface (5.4.3).

5.4.5. New Frame

Operator:

ZN This command clears all selected view surfaces (5.4.3). If a selected view surface is a screen, it is erased; if a selected view surface is the plotter, the current paper is ejected.

Operand: No operand is required.

5.4.6. Terminate Graphics

Operator:

ZT This command terminates the system's ability to process graphics protocol commands. Any pending graphic images are output to their selected view surfaces. The only commands which may follow this command are "enter graphics mode" and "leave graphics mode." All other commands will be regarded as protocol errors and will be ignored. This command should only be entered after the picture you are constructing is complete. Until the picture is complete, end the protocol string with ETX (5.3.4).

Operand: No operands are required.

5.4.7. Move Absolute

Operator:

A This command resets the current position (CP) for the beginning of the next drawing action. The X,Y coordinates of the CP are defined in the operand.

Operands: The operands are the (X,Y) coordinates of the unit screen, expressed in NDCs (5.5.5). The point of reference (X,Y = 0,0) is the lower left corner of the screen. Because the point of reference allows no negative numbers, the operands are unsigned.

5.4.8. Move Relative

Operator:

B This command resets the current position (CP) for the beginning of the next drawing action. The X,Y coordinates of the CP are defined in the operand.

Operands: The operands are the X,Y coordinates of the point on the unit screen, expressed in NDCs (5.5.5). The point of reference (X,Y = 0,0) is the end point of the last drawing command. Because the CP may be moved in a negative direction (left or down) with respect to the end point of the last drawing command, the operands must be signed integers.

5.4.9. Polymarker Absolute

Operator:

E This command places the symbol defined by the marker symbol command (5.4.21) at a sequence of points expressed in the operand.

The related attribute commands line style (5.4.22) and marker symbol (5.4.21) must precede this command.

Operands: The operands are the (X,Y) coordinates of the point on the unit screen, expressed as ordered pairs of normalized device coordinates, from X1,Y1 to Xn,Yn (5.5.5). The point of reference (X,Y = 0,0) is the lower left corner of the screen. The first pair is considered the CP (current position), which is updated with each movement to Xn,Yn. Because the point of reference allows no negative numbers, the operands are unsigned integers.

5.4.10. Polymarker Relative

Operator:

F This command places the symbol defined by the marker symbol command (5.4.21) at a sequence of points expressed in the operand.

The related attribute commands are the same as for polymarker absolute (5.4.9).

Operand: The operands are the X, Y coordinates of each successive point on the screen, expressed as ordered pairs of normalized device coordinate values (5.5.5), from X1, Y1 to Xn, Yn. The point of reference is the CP (current position), which is updated at each succeeding point. Each succeeding point is obtained by adding the next coordinates to the CP. Because the CP may be moved in a negative direction (left or down) with respect to the end point of the last drawing command, the operands must be signed integers.

5.4.11. Polyline Absolute

Operator:

C This command describes a connected sequence of points, beginning at the current position (CP). Successive points are expressed in the operand. The CP is updated with each new point.

The related attribute which must precede this command is set line style (5.4.22).

Operands: The operands are the X,Y coordinates of each point on the unit screen, expressed as ordered pairs of normalized device coordinates, from X1,Y1 to Xn,Yn (5.5.5). The point of reference (X,Y = 0,0) is the lower left corner of the screen. Because the point of reference allows no negative numbers, the operands are unsigned integers.

5.4.12. Polyline Relative

Operator:

D This command describes a connected sequence of points, beginning at the current position (CP). The succeeding points are expressed in the operand.

The related attribute command which must precede this command is set line style (5.4.22).

Operands: The operands are the X,Y coordinates of each point on the screen, expressed as normalized device coordinates (5.5.5). They are obtained by adding the X and Y differences between current and succeeding points to the current point. The CP (current position) is updated with each movement from $\Delta X_1, \Delta Y_1$ to $\Delta X_n, \Delta Y_n$. Because successive points may be in a negative direction (left or down) with respect to the CP, the operands must be signed integers.

5.4.13. Polygon Absolute

Operator:

G The command describes a polygon beginning at the current position (CP). The vertices of the polygon are expressed as a series of X,Y coordinates. The command joins the successive vertices, then returns to the CP to close the polygon. The coordinates of the vertices are expressed in the operand.

The related attribute command which must precede this command is set polygon interior style (5.2.24). The line width command does not affect this command.

Operands: The operands are the X,Y coordinates of each point on the screen, expressed as ordered pairs of normalized device coordinates, from X_1, Y_1 to X_n, Y_n (5.5.5). The point of reference ($X, Y = 0, 0$) is the lower left corner of the screen. Because the point of reference allows no negative numbers, the operands are unsigned integers.

5.4.14. Polygon Relative

Operator:

D This command describes a polygon using a series of $\Delta X, \Delta Y$ coordinates representing the vertices. The starting point is the current position (CP), and succeeding points are expressed relative to it.

The related attribute commands are the same as those for polygon absolute.

Operands: Operands are expressed as normalized device coordinates of the unit screen (5.5.5). They are obtained by adding the X and Y differences between the current and each succeeding point to the current point. Because a vertex may be in a negative direction (left or down) with respect to the end point of the last drawing command, the operands must be signed integers.

5.4.15. Rectangle Absolute

Operator:

I This command describes a rectangle which has as its diagonal vertices the current position (CP) and X,Y. The boundary lines of the rectangle are parallel to the X and Y axes. The vertex diagonal to CP is specified in the operand. The CP is left unchanged by this command.

The related attribute command which must precede this command is set polygon interior style (5.4.24).

Operand: The X,Y coordinates of the vertex are expressed as normalized device coordinates on the unit screen (5.5.5). The point of reference (X,Y = 0,0) is the lower left corner of the screen. Because the point of reference allows no negative numbers, the operands are unsigned integers.

5.4.16. Rectangle Relative

Operator:

J This command describes a rectangle which has one vertex at the current position (CP) and the second diagonally from it at ΔX , ΔY , specified in the operand. The boundaries of the rectangle are parallel to the X and Y axes. The CP is left unchanged by this command.

Related attribute commands are the same as for rectangle absolute.

Operands: ΔX and ΔY are normalized device coordinate values which are added to the CP values. Because ΔX and ΔY may be moved in a negative direction (left or down) with respect to the CP, the operands must be signed integers.

5.4.17. Circle

Operator:

O This command describes a circle which has its center at the current position (CP) and its radius defined by the operand. The CP is left unchanged by this command.

The related attribute command which must precede this command is set polygon interior style (5.4.24).

Operand: The operand is the radius of the circle. It is expressed as a normalized device coordinate (5.5.5) and written as an unsigned integer.

5.4.18. Arc

Operator:

M This command describes an arc drawn in a counterclockwise direction from its starting angle SA to its ending angle EA, with a radius of curvature R. The CP is unchanged by this command.

The related attribute set line style (5.4.22) must precede this command.

Operands: The operands are entered in this order: R, SA, EA. The radius is an absolute value in the normalized device coordinate system (5.5.5) and is expressed as an unsigned integer between 0 and 32767. The angles are considered to be degrees of a circle, expressed as real numbers between 0.0 and 360.0. The angle 0.0 lies along the X axis in the first quadrant of a Cartesian coordinate system. If fewer than three operands are specified, it will be regarded as a protocol error. A null operand may be specified by consecutive delimiters.

5.4.19. Sector

Operator:

K This command describes a pie-shaped figure with its center of curvature at the current position (CP), with a radius of curvature R. It is drawn counterclockwise from a starting angle SA to an ending angle EA, defined in the operand. The CP is unchanged by this command.

The related attribute which must precede this command is set polygon interior style (5.4.24).

Operands: The operands are entered in this order: R, SA, EA. The radius is an absolute value in the normalized device coordinate system (5.5.5) and is expressed as an unsigned integer between 0 and 32767. The angles are considered to be degrees of a circle, expressed as real numbers between 0.0 and 360.0. The angle 0.0 lies parallel to the positive X axis of a Cartesian coordinate system; 90 degrees lies parallel to the positive Y axis. If fewer than three operands are specified, it will be regarded as a protocol error. A null operand may be specified by consecutive delimiters.

5.4.20. Text

Operator:

A string of text characters begins and ends with apostrophes. The placement of the text string on the screen is in the context of the normalized device coordinate system (5.5.5), and is determined by the current position (CP) and the current values of related attributes.

The related attribute commands which, if used, must precede this command are: set character path (5.4.25), set character justification (5.4.26), and set character size (5.4.27).

Operands: An apostrophe can be included in the text by entering two consecutive apostrophes. One operand is required for each text character. Each operand is an 8-bit binary integer whose value is from hexadecimal 20 to 7F on the ASCII chart. Values outside this range or no operand are regarded as protocol errors.

5.4.21. Set Marker Symbol

Operator:

S This is the visible image displayed in the "polymarker" commands (5.4.10 and 5.4.11). The default is a period. The symbols always appear at a standard orientation; that is, unrotated and centered at the current position.

This command sets the system-maintained attribute which determines the marker symbol.

Operand: One unsigned integer defined below:

<u>Symbol</u>	<u>Value</u>
. (period)	1
+ (plus)	2
* (asterisk)	3
O (capital O)	4
X (capital X)	5

5.4.22. Set Line Style

Operator:

LS This command sets the system-maintained attribute which specifies the line style.

Operand: The operand is an unsigned integer specified below. The actual patterns are device-dependent and may vary slightly from one device to another.

<u>Code</u>	<u>Description</u>
1	Solid line
2	Short dashed line, short interspaces
3	Dotted line, short interspaces
4	Dash-dot line, short interspaces
5	Very short dashed line, short interspaces
6	Medium dashed line, short interspaces
7	Long dashed line, short interspaces
8	Dash-2 dot line, short interspaces
9	Dotted line, long interspaces (used for grids)

5.4.23. Set Hatch Index

Operator:

PH This command sets the system-maintained attribute which controls the fill pattern to be used for a polygon, sector, circle, or rectangle. The attribute remains in effect until changed by another set hatch index command.

The hatch patterns have a standard appearance; they are never rotated or scaled.

Operand: The operand is an unsigned integer from the following list. The actual patterns generated are hardware-dependent and may vary slightly from one device to another. The standard orientation sets 0 degrees along the positive X axis and 90 degrees along the positive Y axis.

<u>Code</u>	<u>Description</u>
1	Diagonal lines at 135 degrees
2	Diagonal lines at 45 degrees
3	Vertical lines (90 degrees)
4	Horizontal lines (0 degrees)
5	Vertical and horizontal crosshatch
6	Diagonal crosshatch (45 and 135 degrees)
7 and greater	Defined by the device

5.4.24. Set Polygon Interior Style

Operator:

PI This command sets the system-maintained attribute which controls the fill method for a polygon, circle, sector, or rectangle. The attribute setting remains in effect until changed by another set polygon interior style command.

Operand: The operand is one unsigned integer whose action is specified below:

<u>Code</u>	<u>Name</u>	<u>Description</u>
0	Hollow	No fill.
1	Plain	Uses the color specified in the fill color index command (black or white) and fills the whole figure.
2		Reserved for future use.
3	Patterned	The pattern defined by the last pattern command is used to fill the interior of the figure.
4	Hatched	Uses the pattern specified in the set hatch index command and the color specified in the fill color index command (black or white).
5	Hatched	The hatched pattern is overlaid on a solid-filled background.

5.4.25. Set Character Path

Operator:

CP This command sets the system-maintained attribute which determines the writing direction to be used when creating a sequence of characters. The character path is based on the assumption that the "character up" vector is zero degrees. The attribute setting remains in effect until changed by another set character path command.

This command applies only to text strings.

Operand: The operand is an unsigned integer from the list below.

<u>Value</u>	<u>Direction</u>
p	Right (90 degrees clockwise from up (default))
1	Left (90 degrees counterclockwise from up)
2	Up (0 degrees)
3	Down (180 degrees from up)

5.4.26. Set Character Justification

Operator:

CJ This command sets the system-maintained attribute which specifies where a text string is located with respect to the current position (CP). The attribute setting remains in effect until changed by another set character justification command.

Operands: Two operands are required; the first determines the horizontal position and the second determines the vertical position. The alternatives are listed below and the effects of the combinations are illustrated in Figure 5-2.

<u>Code</u>	<u>Horizontal</u>	<u>Vertical</u>
0	Left	Top
1	Right	Bottom
2	Center	Center
3	Off	Off

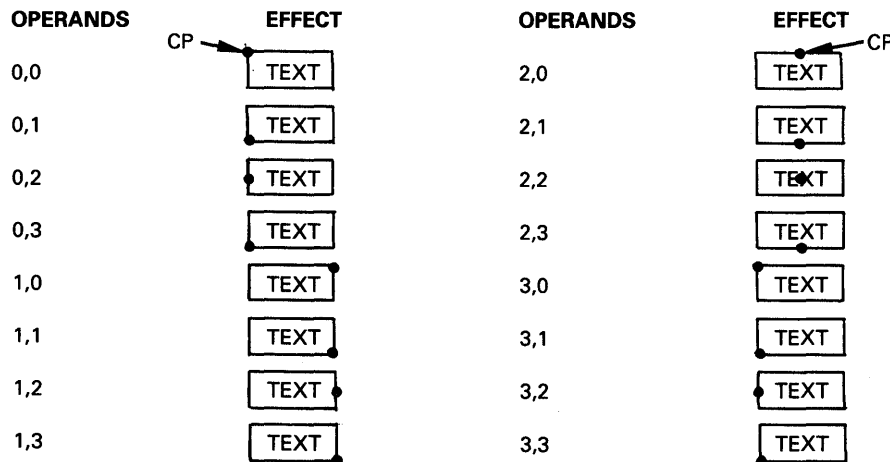

Figure 5-2. Effects of Character Justification Operands

5.4.27. Set Character Size

Operator:

CZ This command sets the system-maintained attribute which determines the size (and width-to-height ratio) of a character. The attribute remains in effect until changed by another set character size command.

Operands: The two operands control width and height, in that order. They are expressed in normalized device coordinate units (5.5.5), and entered as unsigned integers. Fewer than two operands or an operand value of zero (null) will be interpreted as a protocol error.

5.5. FORMAT OF OPERANDS

The number and type of operands allowed vary for each command. The valid operands and types are shown in Table 5-1 and defined in the paragraphs that follow.

Table 5-1. Valid Operands

Operand	Type
Absolute coordinate (x or y)	Unsigned integer
Relative coordinate (x or y)	Signed integer
Radius (R)	Unsigned integer
Angle (SA or EA)	Unsigned real number (0.0 – 360.0)
Attribute	Unsigned integer
Text string	Character string
Control	Unsigned integer
Null	Consecutive delimiters

5.5.1. Delimiters

Valid delimiters are:

- Another operator
- A comma — Separates operands where the operator requires multiple operands
- An apostrophe — Begins and ends character strings

Protocol errors are regarded as invalid delimiters. They cause the command to be terminated and discarded. The entire command, beginning with the operator, must be reentered.

5.5.2. Character Strings

A character string is an arbitrary number of characters taken from 20 to 7E of the ASCII chart. Character strings begin and end with an apostrophe. An apostrophe can be included in the character string by using two consecutive apostrophes.

5.5.3. Unsigned Integers

An unsigned integer is written as:

1. An optional string of one or more leading spaces (20 hexadecimal), immediately followed by:
2. An optional string of an arbitrary number of leading zeros (30 hexadecimal), immediately followed by:
3. One to five digits (30 to 39 hexadecimal).

5.5.4. Signed Integers

A signed integer is written as:

1. An optional string of one or more leading spaces (20 hexadecimal), immediately followed by:
2. A minus sign (2D hexadecimal) or an optional plus sign (2B hexadecimal), immediately followed by:
3. An optional string of one or more leading zeros (30 hexadecimal), immediately followed by:
4. One to five digits (30 to 39 hexadecimal).

NOTE:

No sign implies the integer is positive.

5.5.5. Coordinate Representation

Graphics coordinates are written as normalized device coordinates (NDCs) drawn on a unit screen (1x1). NDCs are device independent; that is, a drawing defined by NDCs can be displayed on any size unit screen (256x256, 512x512, etc.) without changing the graphics command. The unit screen is square (x equals y) so that each value entered in a command produces the same amount of movement in both the x and y directions. (Were this not so, a command to create a circle, for instance, would produce an ellipse.)

The x and y coordinates are each sent to the terminal in a 16-bit, fixed-point binary word, where the first bit (bit 15) is the sign bit (where 0 is positive and 1 is negative). In this format:

0111111111111111 = +32767

which is the upper NDC of the screen.

The NDC uses integers rather than decimal fractions to facilitate handling by the microprocessor. Thus, all graphics points must be converted to a scale of $x/32767$. For example, a Y coordinate of 48 plotted on a 100x100 grid would be converted as follows:

$$\begin{aligned}48/100 &= Y/32767 \\100Y &= 32767 (48) \\Y &= 15728.16\end{aligned}$$

and the NDC = 15728 because the NDC must be an integer.

Since only the lower 73 percent of the screen is visible, the maximum displayable Y NDC is $(0.73)(32767) = 23919.91 = 23919$. (In this case you cannot round upward because values larger than 32767 are undefined.) NDCs of Y between 23919 and 32767 are written to memory but not displayed on the screen. Out-of-range coordinates (beyond 32767) are regarded as protocol errors.

Appendix A. Line Protocol Rules

The line protocol rules listed in this appendix are discussed in detail in Section 3. The parenthetical paragraph reference located after each rule number indicates the paragraph in which a complete discussion of that rule can be found.

A.1. UTS 30 RULES

UTS 30 Rule 1 (refer to 3.5.1):

The station responds only to error-free polls.

UTS 30 Rule 2 (refer to 3.5.1):

The station expects an acknowledgment to any message it sends in response to a poll except the traffic response.

UTS 30 Rule 3 (refer to 3.5.1):

When the total message length from a station exceeds 4096 bytes, a station will send consecutive text blocks until the transmission limit of the screen is satisfied. Thus, the response to a poll with acknowledgment of the previous text block is to send a no-traffic message. When a message does not exceed 4096 bytes, a station responds with a no-traffic message to a poll plus acknowledgment.

UTS 30 Rule 4 (refer to 3.5.1):

The station acknowledges in its next poll response any error-free host processor message containing an STX (text message, message wait command, or disconnection command).

UTS 30 Rule 5 (refer to 3.7.1):

If a station that is owed an acknowledgment does not receive an acknowledgment in the next good poll that it recognizes, the station sends a reply request (DLE ENQ) message.

UTS 30 Rule 6 (refer to 3.7.1):

A station will not send an acknowledgment (DLE 1 or DLE ?) with a reply request. A station having a reply request can be passed an acknowledgment because of the multiplexer function. However, that acknowledgment will not be reported until the reply request condition is satisfied.

UTS 30 Rule 7 (refer to 3.8.4):

The specific DID in any host processor message causes a selection attempt only if the message is error free.

UTS 30 Rule 8 (refer to 3.8.4):

The UTS 30 will respond to a selection poll or the first poll following a TEXT/SD, TEXT/SD/PI, or TEXT/PI message with a peripheral status response. These peripheral status responses are listed in Table A-1.

Table A-1. UTS 30 Peripheral Status Responses to Host Processor Messages

Peripheral Condition	Selection Poll From Host Processor	TEXT/SD From Host Processor	TEXT/SD/PI From Host Processor	TEXT/PI From Host Processor (after previous selection)
No peripheral interface support within UTS 30	No traffic	DLE 1	DLE 1	DLE 1
Peripheral response 1 (ready)	DLE >	DLE 1 DLE >*	DLE ? or DLE 1 DLE :**	DLE ? or DLE 1 DLE :
Peripheral response 2	DLE <	DLE 1 DLE <	DLE 1 DLE < or DLE ?†	DLE ?
Peripheral response 3	DLE :	DLE 1 DLE :	DLE 1 DLE : or DLE ?†	DLE ?
No peripheral response	DLE =	DLE 1 DLE =	DLE 1 DLE =	DLE ?
Peripheral selection delayed (peripheral interface in use)	DLE 5	DLE 1 DLE 5	DLE 1 DLE 4	DLE 1 DLE 4

* With multiple stations, the DLE 1 portion of the message may be sent independently of the status portion when a DLE plus status condition exists.

**Slow polling rates or fast data transfers can create situations where DLE 1 plus DLE ; could be returned without DLE ? first being returned to the host processor.

† The response depends on the peripheral. An acknowledgment plus error status implies the peripheral initiation did not occur. The busy status implies the initiation was attempted. If the peripheral initiation was successful, the THRU status will not subsequently be reported; if unsuccessful, a sustained busy will result. For example, if an out-of-paper condition occurs during execution of a print sequence, then a sustained busy condition results.

UTS 30 Rule 9 (refer to 3.8.4):

During a peripheral operation (online or offline), the station will not respond to a poll, text message, or TEXT/PI containing a general DID.

A selection poll, TEXT/SD, or TEXT/SD/PI to a station with a peripheral operation in progress causes the peripheral operation to be terminated, and a peripheral status response is sent, as described in rule 8. If the peripheral operation is terminated before the operation is completed, a timing error results, and DLE : status is sent.

UTS 30 Rule 10 (refer to 3.8.4):

A selection poll requiring access to the peripheral interface already in use (by either the station or second screen memory) will solicit the peripheral-selection-delayed (DLE 5) response. The station or second screen memory is then added to the PAQ. When the station or second screen memory waiting to use the peripheral is placed on the top of the PAQ, the selection attempt is made and the next general poll or specific poll response from the station or second screen memory will be DLE > (peripheral ready), DLE <, DLE:, or DLE = (no response from the peripheral).

UTS 30 Rule 11 (refer to 3.8.4):

A TEXT/PI message or a TEXT/SD/PI message requires access to the peripheral interface. If the peripheral interface is already in use on the second screen, the station response is acknowledgment plus message queued (DLE 1 DLE 4). The station response to subsequent general polls is no traffic, and the response to subsequent specific polls is message queued (DLE 4) until the message reaches the top of the PAQ. When the message is acted upon, the station responds to subsequent specific polls with a busy (DLE ?) as long as the peripheral operation is in progress. The station response continues to be no traffic to general polls as long as the peripheral operation is in progress. A THRU (DLE ;) status is sent as a poll response upon completion of the peripheral operation.

UTS 30 Rule 12 (refer to 3.8.4):

Upon completion of a data transfer to or from a peripheral, the UTS 30 sends the THRU (DLE ;) status as a poll response. When automatic peripheral retry is enabled in a station, the THRU response means the peripheral operation was completed successfully.

UTS 30 Rule 13 (refer to 3.9.1):

A station will not respond with a message-waiting or program-attention-key code message to a poll containing an acknowledgment if that station is owed an acknowledgment.

UTS 30 Rule 14 (refer to 3.9.1):

If a UTS 30 station or cluster has more than one response to send, the following priority sequence will be observed:

1. Any station or peripheral status responses are sent first. These responses include:
 - a. Message-queued response (DLE 4) due to receipt of a TEXT/PI or TEXT/SD/PI message when another message was already in the PAQ.
 - b. Peripheral-selection-delayed response (DLE 5) due to receipt of a selection poll or a TEXT/SD message when another message was already in the PAQ.
 - c. Peripheral-operation-THRU response (DLE ;) due to completion of the peripheral operation.
 - d. Peripheral status response 1 (DLE >) due to receipt of a TEXT/SD message or a selection poll when no other message was in the PAQ.
 - e. Peripheral status response 2 (DLE <), 3 (DLE :), or 4 (DLE =) due to receipt of a selection poll, a TEXT/SD message, or a TEXT/SD/PI message when no other message was in the PAQ.
2. If no priority 1 conditions exist, then any text messages resulting from the XMIT key being pressed or from a host processor transmit command are sent.
3. If no priority 2 conditions exist, then any message-waiting or program-attention-key code messages are sent.

A.2. HOST PROCESSOR RULES**Host Processor Rule 1** (refer to 3.5.1):

Upon sending a text message to a station, the host processor must poll to verify proper receipt of the text. This poll must occur before any other text is sent to that poll group. If the UTS 30 does not respond with an acknowledgment verifying proper receipt of the text, the host processor must resend the text message.

Host Processor Rule 2 (refer to 3.5.1):

The host processor must send a poll with acknowledgment to a station that has sent an acknowledgeable response before the host processor can send a text message to that station.

Host Processor Rule 3 (refer to 3.6.1):

When using general polls, the host processor must expect an acknowledgment (or busy) from one station to be included with a response from another station in the poll group. The multiplexer function allows an acknowledgment to be passed from one station to another station that has a traffic response pending.

Host Processor Rule 4 (refer to 3.6.1):

When using general polls, the host processor must expect successive traffic responses from stations within a poll group. However, UTS 30 rule 3 still applies. The multiplexer function allows a station with a message pending to send its response to any poll whose address it recognizes.

Host Processor Rule 5 (refer to 3.6.1):

The host processor can send text to any station in the poll group that is not owed an acknowledgment, provided the last response from the poll group was not one of the following:

- DLE 1 only (SOH RID SID DID DLE 1 ETX BCC)
- DLE ? only (SOH RID SID DID DLE ? ETX BCC)
- DLE 1 plus text available (SOH RID SID DID DLE 1 DLE 0 ETX BCC)
- DLE ? plus text available (SOH RID SID DID DLE ? DLE 0 ETX BCC)

Host Processor Rule 6 (refer to 3.6.1):

When the host processor owes an acknowledgment to a station in a poll group, the host processor may send a specific poll to the poll group only if the specific poll is addressed to the station that is owed the acknowledgment.

Host Processor Rule 7 (refer to 3.6.1):

The host processor must not allow a given poll group to owe more than one acknowledgment to the host processor at any time.

Host Processor Rule 8 (refer to 3.7.1):

The host processor must treat any error in a received message as a no-response condition and must repeat the poll that preceded the no-response condition. However, any acknowledgment included with the original poll must be eliminated and a general DID must be used when the poll is repeated. If the no-response condition results from a retransmission request (DLE NAK), the host processor must repeat the poll that created the reply-request response.

Host Processor Rule 9 (refer to 3.7.1):

The host processor response to a reply request (DLE ENQ) from a station must be a retransmission request (DLE NAK) if the last message correctly received from the station sending the reply request did not contain text data. The retransmission request has the same specific RID and specific SID address as that contained in the reply request. The retransmission request must contain a general DID.

Host Processor Rule 10 (refer to 3.7.1):

The host processor response to a reply request (DLE ENQ) from a station must be a poll-with-acknowledgment message if the last message correctly received from the station sending the reply request was a message and not for the reply request message itself.

Host Processor Rule 11 (refer to 3.7.1):

The host processor response to a reply request (DLE ENQ) from a station must be a retransmission request (DLE NAK) if the station sending the reply request is other than one to which an acknowledgment has just been sent.

Host Processor Rule 12 (refer to 3.7.1):

If the response from a retransmission request is identical to the UTS 30 response sent just previous to the reply request and is from the same station, then the response to the retransmission request can be ignored except for sending the acknowledgment that the station expects. However, the same UTS 30 response is to be ignored only once.

Host Processor Rule 13 (refer to 3.8.4):

If a no-response condition exists on a selection poll, then host processor rule 6 (which requires sending of a specific poll) must be followed. If the response to this specific poll is a reply request, then a retransmission request must be sent. If the response is no traffic, the selection poll must be resent.

Host Processor Rule 14 (refer to 3.8.4):

A selection poll can contain an acknowledgment only if the selection is being performed on the station that is owed the acknowledgment.

Host Processor Rule 15 (refer to 3.8.4):

The host processor must maintain peripheral-operation timers at the station level or at the UTS 30 to provide an indication of excessive wait time or of a sustained busy condition. These timers must take into consideration the amount of time a station is on the PAQ prior to performance of the operation (the wait time) and the amount of time required to actually perform the operation. Wait time depends on the number of host-processor and operator-initiated operations already in the PAQ and the type of operations being performed.

The station-level timer should be initiated for:

- A delayed status response to a selection poll
- A DLE 1 plus delayed status response to the poll following a TEXT/SD message
- A DLE 1 plus message-queued response to the poll following a TEXT/SD/PI message
- A DLE ? response to the poll following a TEXT/PI or TEXT/SD/PI message

When general polls are being used, the station-level peripheral timeouts can be used as a timing mechanism for periodically sending specific polls to determine when the peripheral operation is actually in progress (refer to UTS 30 rule 11).

The station-level timer should be terminated upon notification of a peripheral completion (the THRU response if the first response was DLE ? or DLE 1 plus message queued, or the peripheral device status if the first response was delayed status).

A.3. UTS 30 COMMUNICATIONS CONTROL SEQUENCES

The communications control sequences used outside the text message are listed in Table A-2.

Table A-2. UTS 30 Communication Control Sequences (Part 1 of 2)

Definition	Code	Paragraph Reference
Host-to-UTS 30 and UTS 30-to-Host Codes		
Start of heading	SOH	3.4
Start text	STX	3.4.2
End text	ETX	3.4.3
More to come	ETB	3.4.3.4.1
Block check character	BCC	3.3.2
Audible alarm	BEL	3.4.2.2
Synchronous	SYN	3.4
Retransmission request	DLE NAK	3.4.1.4 3.7.1
Status poll (from host only)	ENQ or DLE 1 ENQ	3.4.1.1
UTS 30-to-Host Codes		
No traffic	EOT EOT	3.4.3.2
Reply request	DLE ENQ	3.4.3.1
Line disconnection	DLE EOT	3.4.3.4.4 3.10
Acknowledgment	DLE 1	3.4.3.3
TERMINAL STATUS:		
Busy	DLE ?	3.4.3.3 3.8.8
Text-available response to status poll	DLE 0	3.4.3.4.3
Through (THRU)	DLE ;	3.4.3.4.3 3.8.8
Message queued	DLE 4	3.4.3.4.3 3.8.2
Peripheral selection delayed	DLE 5	3.4.3.4.3 3.8.2
Power-on confidence test (POC)	DLE 6	3.4.3.4.3

Table A-2. UTS 30 Communication Control Sequences (Part 2 of 2)

Definition	Code	Paragraph Reference
PERIPHERAL STATUS:		
Device ready	DLE >	3.4.3.4.3 3.8.5, 3.8.7
Unable to proceed	DLE <	3.4.3.4.3 3.8.6
Peripheral error	DLE :	3.4.3.4.3
Peripheral error (no response)	DLE =	3.4.3.4.3 3.8.9

A.4. SYNCHRONOUS IDLE (SYN)

The SYN character is used in a synchronous transmission system to provide a signal from which synchronization may be achieved or retained.

- SYN is used to achieve and maintain character synchronization in synchronous communication systems.
- SYN can also be used as a communication time-fill character within a text message during periods in a transmission when no other characters are available to send.
- Conventions applying to use of the SYN character are as follows:
 - After a period in which no characters have been transmitted on a channel and prior to the transmission of any other character, at least four SYN characters must be transmitted.
 - Determination of synchronization, once achieved, and the recognition of character synchronization are the responsibility of the receiving station. No station is considered synchronized until two successive SYN characters have been received. All stations in a multipoint configuration remain in synchronization when not sending if data is present on the receive line.
 - When the SYN character is used as a communication time-fill character during a transmission, SYN may be arbitrarily added at any point in the transmission except in a control sequence following DLE, between ETX and the next BCC (see 3.3.2), and between the address identifiers in a heading.

The SYN character is not to be used for time-fill or media-fill functions that are to be conveyed through the system. The receiving station deletes all SYN characters.

Appendix B. Text Message Codes

The codes in this section all occur within the STX... ETX envelope. The code listing is followed by its text location.

B.1. ASCII CODE CONVERSIONS

The ASCII-based code conversion chart is presented in Figure B-1; Figure B-2 gives the national alphabet selections and the locations on the chart.

CONTROL CHARACTERS		DATA CHARACTERS										BINARY BIT NUMBER							
		64 CHARACTERS UPPERCASE					32 CHARACTERS LOWERCASE												
		0	1	0	1	0	1	0	1	0	1	0	1	7	6	5	4	3	2
00	NUL	10	DLE	20	☐	30	0	40	@	50	☐	60	`	70	☐	0	0	0	0
01	SOH	11	DC1	21	!	31	1	41	A	51	Q	61	a	71	q	0	0	0	1
02	STX	12	DC2	22	"	32	2	42	B	52	R	62	b	72	r	0	0	1	0
03	ETX	13	DC3	23	#	33	3	43	C	53	S	63	c	73	s	0	0	1	0
04	EOT	14	DC4	24	\$	34	4	44	D	54	T	64	d	74	t	0	1	1	0
05	ENQ	15	NAK	25	%	35	5	45	E	55	U	65	e	75	u	0	1	0	1
06	ACK	16	SYN	26	&	36	6	46	F	56	V	66	f	76	v	0	1	0	1
07	BEL	17	ETB	27	'	37	7	47	G	57	W	67	g	77	w	1	1	1	1
08	BS	18	CAN	28	(38	8	48	H	58	X	68	h	78	x	1	0	0	0
09	HT	19	EM	29)	39	9	49	I	59	Y	69	i	79	y	1	0	0	1
0A	LF	1A	SUB	2A	*	3A	:	4A	J	5A	Z	6A	j	7A	z	1	0	1	0
0B	VT	1B	ESC	2B	+	3B	;	4B	K	5B	[6B	k	7B	[1	0	1	1
0C	FF	1C	FS	2C	,	3C	<	4C	L	5C	\	6C	l	7C		1	1	0	0
0D	CR	1D	GS	2D	.	3D	=	4D	M	5D]	6D	m	7D]	1	1	0	1
0E	SO	1E	RS	2E	-	3E	>	4E	N	5E	^	6E	n	7E	~	1	1	1	0
0F	SI	1F	US	2F	/	3F	?	4F	O	5F	_	6F	o	7F	z	1	1	1	1

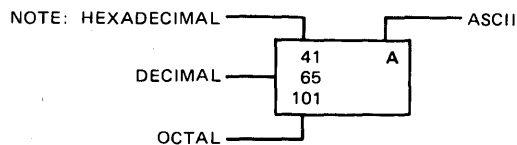

Note: GIDs (General Identifiers) are shaded

Figure B-1. ASCII-Based Code Conversion Chart

HEXADECIMAL AND DECIMAL LOCATIONS IN ASCII CODE CHART													
STANDARD CHARACTER SETS	HEX DECIMAL	23	24	40	5B	5C	5D	5E	60	7B	7C	7D	7E
		35	36	64	91	92	93	94	96	123	124	125	126
DOMESTIC (USA)		#	\$	@	[\]	^	`	{		}	~
SPAIN		Pts	\$	§	i	Ñ	¿	^		°	ñ		~
DENMARK/NORWAY		#	\$	@	Æ	Ø	Å	^	`	æ	ø	å	—
FRANCE		£	\$	à	°	ç	§	^	`	é	ù	è	·
GERMANY		#	\$	§	Ä	Ö	Ü	^	`	ä	ö	ü	ß
SWEDEN/FINLAND		#	☉	É	Ä	Ö	Å	Ü	é	ä	ö	å	ü
UNITED KINGDOM		£	\$	@	[\]	^	`	{		}	~
ITALY		£	\$	§	°	#	é	^	ù	à	ò	è	ì

Figure B-2. National Alphabet Selections — Character Locations on Code Charts

B.2. TEXT MESSAGE FORMAT CODES

Text message format codes are given in Table B-1.

Table B-1. Text Message Format Codes

Code	Function	Paragraph Reference
NUL	Time fill (within text)	4.2.4
SOE	Start-of-entry	4.2.2
DC1	Transmit variable fields	4.2.3.2.
ESC DC1	Transmit all fields	4.2.3.1
ESC t	Transmit changed fields	4.2.3.3

B.3. TERMINAL CONTROL CODES

Terminal control codes are given in Table B-2.

Table B-2. Terminal Control Codes

Code	Function	Paragraph Reference
ESC P	Call error log	4.3.1
ESC Q	Initiate POC	4.3.3
ESC R	Clear error log	4.3.2
ESC o	Call control page	4.3.4
ESC DC4	Lock keyboard	4.3.5
ESC SO	Load character set to UTS 30	4.3.6
ESC U	Request character set ID from UTS 30	4.3.7
DC3 DC3	Load character set to diskette	4.3.8

B.4. SCREEN CONTROL CODES

Screen control codes include codes for cursor positioning, FCCs, special emphasis, special character display, and editing. The codes are given in Tables B-3 through B-8 and Figure B-3.

Table B-3. Cursor Position Codes

Code	Function	Paragraph Reference
ESC VT Y X SI	Cursor address sequence	4.4.1.1
ESC e	Cursor to home	4.4.1.2
ESC T	Request cursor address	4.4.1.3
CR	Cursor return	4.4.1.4 4.4.6.3 4.5.2.4
ESC f	Scan up	4.4.1.5
ESC g	Scan left	4.4.1.6
ESC h	Scan right	4.4.1.7
ESC i	Scan down	4.4.1.8

Table B-4. FCC Codes

Code	Function	Paragraph Reference
US Y X M N	Long FCC sequence	4.4.2.3.1
EM M N	Immediate FCC sequence	4.4.2.3.2
ESC u	Clear changed fields	4.4.2.3.3
ESC w	Clear FCC	4.4.2.3.4
HT or ESC z	FCC tab stop	4.4.2.3.5

Table B-5. Special Emphasis Sequences

Code	Function	Paragraph Reference
ESC ZZ text ESC SP	Special emphasis character sequence	4.4.4
ESC ZZ	Create emphasis	4.4.4.1
ESC Y ZZ	Modify emphasis	4.4.4.2
ESC Z ZZ	Delete emphasis	4.4.4.3

Table B-6. Special Emphasis ASCII Character Codes

ASCII Characters	Hexadecimal Code	Special Emphasis
SP	20	No emphasis
!	21	Column separator
"	22	Optional character set
#	23	Optional character set and column separator
\$	24	Underscore
%	25	Optional character set and column separator
&	26	Optional character set and underscore
'	27	Optional character set, column separator, and underscore
(28	Strike-through
)	29	Column separator and strike-through
,	2C	Underscore and strike-through
-	2D	Column separator, strike-through, and underscore

ESC \$ text ESC SP	text is underscored
ESC \$ SUB SUB SUB SUB ESC SP	underscore only (4 spaces)
ESC ! text ESC SP	column separator precedes text
ESC ! ESC SP	column separator only
ESC (text ESC SP	text and strike-through
ESC ! cat ESC \$ dog ESC SP	column separator preceding each character of cat; underline only beneath dog.

9799-3

*Figure B-3. Special Emphasis Characters**Table B-7. Editing Function Codes*

Code	Function	Paragraph Reference
ESC a	Erase to end of display (unprotected)	4.4.5.1
ESC b	Erase to end of line	4.4.5.2
ESC K	Erase to end of field	4.4.5.3
ESC M	Erase display	4.4.5.4
ESC c	Delete in line	4.4.5.5
ESC C	Delete in display	4.4.5.6
ESC k	Delete line	4.4.5.7
ESC d	Insert in line	4.4.5.8
ESC D	Insert in display	4.4.5.9
ESC j	Insert line	4.4.5.10
ESC y	Line duplication	4.4.5.11
HT	Tab forward	4.4.5.12, 4.4.2.3.5
ESC HT	Tab stop (set)	4.4.5.13
ESC z	Tab backward	4.4.5.14, 4.4.2.3.5

Table B-8. Displayable Character Codes

Code	Function	Paragraph Reference
SP	Blank space	4.4.6.1
RS	Start of entry (SOE)	4.4.6.2
CR	Cursor return	4.4.6.3 4.4.1.4 4.5.2.4
FS	Blinking start marker	4.4.6.4
GS	Blinking end marker	4.4.6.5

B.5. PERIPHERAL CONTROL CODES

Codes for controlling print and transfer operations are given in Table B-9.

Table B-9. Peripheral Control Codes

Code	Function	Paragraph Reference
ESC G	Transfer all fields	4.5.1.1
ESC F	Transfer variable fields	4.5.1.2
ESC E	Transfer changed fields	4.5.1.3
ESC H	Print form	4.5.1.5
DC2	Print	4.5.1.4
ESC DC2	Print transparent	4.5.1.6
LF	Line feed	4.5.2.1
FF	Form feed	4.5.2.2
VT	Vertical tab	4.5.2.3
CR	Cursor return	4.5.2.4 4.4.1.4 4.4.6.3
CAN	Search diskette	4.5.2.5

B.6. PROGRAM ATTENTION KEY CODES

The control codes generated by the program attention keys are given in Table B-10. The function of these keys is discussed in 3.4.3.4.2. The keys and codes in Table B-11 are also available to the UTS 30 programmer for unique functions.

Table B-10. Program Attention Key Codes

Key Label	ASCII Character	Hexadecimal Code
MSG WAIT	BEL	07
F1	7	37
F2	G	47
F3	W	57
F4	g	67
F5	Space	20
F6	!	21
F7	"	22
F8	#	23
F9	\$	24
F10	%	25
F11	&	26
F12	'	27
F13	(28
F14)	29
F15	*	2A
F16	+	2B
F17	,	2C
F18	-	2D
F19	.	2E
F20	/	2F
F21	0	30
F22	1	31

*Table B-11. Special User Program Attention
Keys on the UTS 30 (Programmable Version)*

Key	Code
FCTN , (comma)	88
FCTN . (period)	89
FCTN Z	81
FCTN X	82
FCTN C	83
FCTN V	84
FCTN B	85

B.7. UTS 30 CURSOR ADDRESSING

The coding of the X (column code) and the Y (row code) coordinates is determined from the position assignments shown in Figure B-4. The codes are derived from columns 2 through 6 of the ASCII code chart, Figure B-1. Columns 0 and 1 of the ASCII code chart contain control codes and are not available for cursor address codes. Column 7 also is not used because no address greater than 80 is required with the UTS 30. The exact code characters specified are a function of the number of lines and columns in the particular terminal system being addressed and the desired cursor position on the screen. Refer to Table B-12 and Figure B-4.

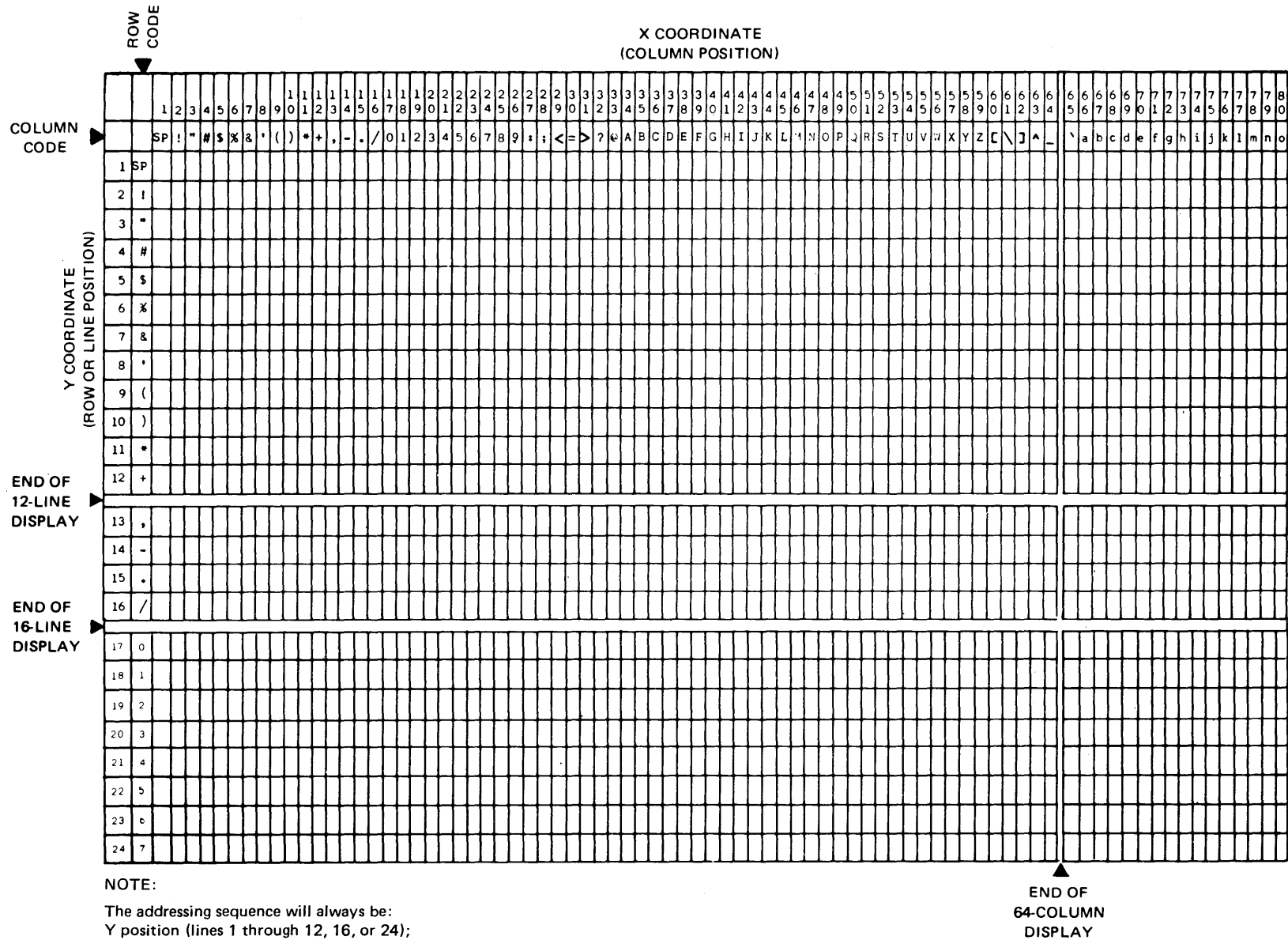

Figure B-4. Cursor Addressing for Screen Display

9136-25

Table B-12. Cursor Addressing Codes for Screen Display

Row and Column	Hexadecimal Address	Row and Column	Hexadecimal Address	Row and Column	Hexadecimal Address
1	20	28	3B	55	56
2	21	29	3C	56	57
3	22	30	3D	57	58
4	23	31	3E	58	59
5	24	32	3F	59	5A
6	25	33	40	60	5B
7	26	34	41	61	5C
8	27	35	42	62	5D
9	28	36	43	63	5E
10	29	37	44	64	5F
11	2A	38	45	65	60
12	2B	39	46	66	61
13	2C	40	47	67	62
14	2D	41	48	68	63
15	2E	42	49	69	64
16	2F	43	4A	70	65
17	30	44	4B	71	66
18	31	45	4C	72	67
19	32	46	4D	73	68
20	33	47	4E	74	69
21	34	48	4F	75	6A
22	35	49	50	76	6B
23	36	50	51	77	6C
24	37	51	52	78	6D
25	38	52	53	79	6E
26	39	53	54	80	6F
27	3A	54	55		

Table B-13. Escape Code Summary (Part 1 of 2)

Escape Code	Hex Code	Meaning
ESC HT	1B 09	Tab stop (set)
ESC VT	1B 0B	Next two characters are cursor address coordinates
ESC SO	1B 0E	Load optional character set to UTS 40
ESC DC1	1B 11	Transmit all fields
ESC DC2	1B 12	Print transparent
ESC DC4	1B 14	Lock keyboard
ESC SP	1B 20	Terminate string of special emphasis characters
ESC C	1B 43	Delete in display
ESC E	1B 45	Transfer changed fields
ESC F	1B 46	Transfer variable fields
ESC G	1B 47	Transfer all fields
ESC H	1B 48	Print form
ESC K	1B 4B	Erase to end of field
ESC M	1B 4D	Erase display
ESC P	1B 50	Call error log
ESC Q	1B 51	Initiate POC
ESC R	1B 52	Clear error log
ESC T	1B 54	Request cursor address
ESC U	1B 55	Request character set identification from UTS 40
ESC a	1B 61	Erase to end of display
ESC b	1B 62	Erase to end of line
ESC c	1B 63	Delete in line
ESC d	1B 64	Insert in line
ESC e	1B 65	Cursor to home
ESC f	1B 66	Scan up
ESC g	1B 67	Scan left
ESC h	1B 68	Scan right
ESC i	1B 69	Scan down
ESC j	1B 6A	Insert line
ESC k	1B 6B	Delete line

Table B-13. Escape Code Summary (Part 2 of 2)

Escape Code	Hex Code	Meaning
ESC o	1B 6F	Call control page, store control page
ESC t	1B 74	Transmit changed fields
ESC u	1B 75	Clear changed fields
ESC w	1B 77	Clear FCC
ESC y	1B 79	Line duplicate
ESC z	1B 7A	Tab backward
ESC ZZ	1B ZZ	Create or replace special emphasis character
ESC Y ZZ	1B 59 ZZ	Add special emphasis characters
ESC Z ZZ	1B 5A ZZ*	Delete special emphasis characters

**ZZ may be defined as one of the following:*

Hex Code	Meaning
20	No emphasis
21	Column separator
22	Optional character set
23	Column separator
24	Underscore
25	Column separator and optional character set
26	Optional character set and underscore
27	Optional character set, column separator, and underscore
28	Strike-through
29	Column separator and strike-through
2C	Underscore and strike-through
2D	Column separator, strike-through, and underscore

Appendix C. Programming Considerations for Magnetic Stripe Reader

C.1. GENERAL

The SPERRY Magnetic Stripe Reader is a read-only auxiliary device that reads data from the magnetic stripe on credit-card-type media and enters that data in the UTS 30. The card must be pushed through the device by the operator.

The interface from the magnetic stripe reader to the UTS 30 is through the UTS 30 keyboard interface cable. When the UTS 30 is turned on, both the keyboard and the reader are ready for use. However, the two types of input cannot be handled simultaneously; if the keyboard is in use, the reader cannot be used, and vice versa. Data read from the magnetic stripe reader is converted to 7-bit ASCII code by the UTS 30 and handled as though it were keyboard-originated data.

C.2. INPUT MODES

The magnetic stripe reader can be used in two modes of operation: security input mode and normal input mode. The mode of operation is selected by the autotransmit (AT) entry in the PARAM field of the control page (refer to the Table J-3) or in the configurator utility. The default condition is NO (normal input mode).

In the security input mode (parameter option YS), data read from the magnetic stripe is temporarily stored in nondisplayable storage and then automatically transmitted to the host processor. In addition, the current DID will be sent in the message to the host.

In the normal input mode (parameter option NO), data read from the magnetic stripe goes onto the display screen at the cursor position. The data appears to be keyboard-originated data, except that the first byte of data from the magnetic stripe reader is preceded by an ASCII DEL character (octal code 0177/hexadecimal code 7F). This format is also true for the security input mode, except that the data does not appear on the screen (refer to C.4).

C.3. READER OPERATION

The magnetic stripe reader is manually operated. The operator must insert the card into the slot in the reader in the direction indicated on the top of the reader. If the read is successful, the audible alarm sounds once and the RACK message in the indicator line is displayed. The keyboard is locked momentarily while data is transferred from the reader to the UTS 30. During this interval, the WAIT message is displayed.

If the read is not successful, the blinking RNAK message is displayed on the indicator line. No data is displayed or transmitted to the UTS 30 with an unsuccessful read operation. The RNAK message will continue to blink until the FCTN UNLOCK key is pressed or until a successful read operation is performed.

C.4. DATA FORMAT

In both the normal input mode and security input mode, data may be read in the International Air Transport Association (IATA) format or in the American Banking Association (ABA) format.* The reader can read in either format, but cannot read in both. The device must be set to read the selected user format.

C.4.1. ABA-Coded Data Format

C.4.1.1. Coded Character Set

A binary-coded-decimal 4-bit subset with odd parity is used to encode data on the magnetic stripe of ABA-formatted cards. This character code is numeric. Refer to Table C-1 for the coded character set.

**The magnetic stripe and the data stored on the magnetic stripe must comply with the American National Standard Institute (ANSI) X4.16-1976.*

Table C-1. ABA-Coded Character Set

Bits					Row	Character
P	b ₄	b ₃	b ₂	b ₁		
1	0	0	0	0	0	0
0	0	0	0	1	1	1
0	0	0	1	0	2	2
1	0	0	1	1	3	3
0	0	1	0	0	4	4
1	0	1	0	1	5	5
1	0	1	1	0	6	6
0	0	1	1	1	7	7
0	1	0	0	0	8	8
1	1	0	0	1	9	9
1	1	0	1	0	10	:
0	1	0	1	1	11	; [Ⓐ]
1	1	1	0	0	12	<
0	1	1	0	1	13	= [Ⓐ]
0	1	1	1	0	14	>
1	1	1	1	1	15	? [Ⓐ]

Legend:

- Ⓐ These characters have the following meanings for this application:
 - Row 11 ; represents "start sentinel"
 - Row 13 = represents "separator"
 - Row 15 ? represents "stop sentinel"

P = Odd parity

C.4.1.2. Information Format

The format of the information encoded on the magnetic stripe of an ABA-formatted card is as follows:

Start sentinel	1 character
Account number	Up to 19 characters
Separator	1 character
Discretionary data	The balance up to the maximum record length (40 characters)
Stop sentinel	1 character
Longitudinal redundancy check	1 character
Total	40 characters maximum

All the characters are displayable (including the start- and stop-sentinel characters) and are part of the maximum 40-character total.

C.4.1.3. Code Conversion

Because the UTS 30 uses a 7-bit ASCII code (parity is excluded) to process data and the ABA-formatted data on the card is 4-bit code (excluding the parity bit), the ABA 4-bit code must be converted to the 7-bit ASCII code. The reader accomplishes this code conversion by stripping the parity bit from each ABA character code and adding an octal value of 60 to that ABA character code to get the resultant 7-bit ASCII code.

C.4.1.4. Longitudinal Redundancy Check (LRC)

The magnetic stripe reader runs an LRC test on the ABA 4-bit code before it is converted to the 7-bit ASCII code. The LRC test contains the following steps:

1. The parity bit of each character code is stripped off.
2. All characters from the start sentinel to and including the stop sentinel are combined by an exclusive OR function.
3. The result of step 2 is compared to the LRC character (minus the parity bit) that was received from the magnetic stripe of the card read.

NOTE:

The LRC character is also converted to the 7-bit ASCII code and sent to the UTS 30. An LRC test can be performed on the ASCII code received by the UTS 30 without any additional code conversion.

C.4.2. IATA-Coded Data Format

C.4.2.1. Coded Character Set

A 6-bit-plus-odd-parity character code is used to encode data on the magnetic stripe of IATA-formatted cards. This character code is alphanumeric. Refer to Table C-2 for the coded character set.

C.4.2.2. Information Format

The information encoded on the magnetic stripe of an IATA-formatted card can be in either of two formats, format A or B. The content of each format is as follows:

<u>Format A</u>		<u>Format B</u>	
Start sentinel	1 character	Start sentinel	1 character
Format code = "A"	1 character	Format code = "B"	1 character
Surname	} 2 to 26 characters	Account number	Up to 19 characters
Surname separator = "/"		Separator	1 character
Initials or first name		Surname	} 2 to 26 characters
Separators (when required) = "space"		Surname separator = "/"	
Title (when used)		Initials or first name	
Separator (when required) = "space"		Separators (when required) = "space"	
Separator	Title (when used)		
Discretionary data	The balance up to the maximum record length (79 characters)	Separator (when required) = "space"	
Stop sentinel	1 character	Separator	1 character
Longitudinal redundancy check	1 character	Discretionary data	The balance up to the maximum record length (79 characters)
Total	79 characters maximum	Stop sentinel	1 character
		Longitudinal redundancy check	1 character
		Total	79 characters maximum

Table C-2. IATA-Coded Character Set

				b ₆	0	0	1	1
				b ₅	0	1	0	1
				COLUMN ROW	0	1	2	3
b ₄	b ₃	b ₂	b ₁		0	1	2	3
0	0	0	0	0	SP	0	@	P
0	0	0	1	1	!	1	A	Q
0	0	1	0	2	"	2	B	R
0	0	1	1	3	#	3	C	S
0	1	0	0	4	\$	4	D	T
0	1	0	1	5	% @	5	E	U
0	1	1	0	6	&	6	F	V
0	1	1	1	7	'	7	G	W
1	0	0	0	8	(8	H	X
1	0	0	1	9)	9	I	Y
1	0	1	0	10	*	:	J	Z
1	0	1	1	11	+	;	K	[
1	1	0	0	12	,	<	L	\
1	1	0	1	13	-	=	M]
1	1	1	0	14	.	>	N	^ @
1	1	1	1	15	/	? @	O	_

LEGEND:

- Ⓐ These characters have the following meanings for this application

Position:

- 0/5 % represents "start sentinel"
- 1/15? represents "end sentinel"
- 3/14 represents "separator"

All the characters are displayable (including the start- and stop-sentinel characters) and are part of the maximum 79-character total.

C.4.2.3. Code Conversion

Because the UTS 30 uses a 7-bit ASCII code (parity is excluded) to process data and the IATA-formatted data on the card is a 6-bit code (excluding the parity bit), the IATA 6-bit code must be converted to the 7-bit ASCII code. The reader accomplishes this code conversion by stripping the parity bit from the IATA code and adding an octal value of 40 to the IATA code to get the resultant 7-bit ASCII code.

C.4.2.4. Longitudinal Redundancy Check (LRC)

The magnetic stripe reader runs an LRC test on the IATA 6-bit code before it is converted to the 7-bit ASCII code. The LRC test contains the following steps:

1. The parity bit of each character code is stripped.
2. All characters from the start sentinel to and including the stop sentinel are combined by an Exclusive OR function.
3. The result of step 2 is compared to the LRC character (minus the parity bit) that was received from the magnetic stripe of the card read.

NOTE:

The LRC character is also converted to the 7-bit ASCII code and sent to the UTS 30. If an LRC test is to be performed on the data received by the UTS 30 (ASCII code), the 7-bit ASCII character codes must be converted back to their equivalent IATA character codes. This conversion can be accomplished by subtracting an octal value of 40 from each 7-bit ASCII character code. Then the LRC test can be performed again. Following the LRC test, the IATA character codes must be reconverted to their equivalent 7-bit ASCII character codes.

C.5. DATA FLOW TO THE UTS 30

The data read from the magnetic stripe of a card is stored in a working buffer of the reader, where character and LRC parity are checked. If the parity check is good, the data is then converted to ASCII code. Before data is passed to the UTS 30, a DEL character (ASCII code //, octal code 177; see Figure B-1) is inserted in front of the data to identify the data transmitted from the reader. The order of the data sent to the UTS 30 is as follows:

IATA Format (A and B)

DEL character (//)

Start sentinel (%)

Data characters as converted

Stop sentinel (?)

LRC character as converted

Total: 79 characters* maximum

ABA Format

DEL character (//)

Start sentinel (;)

Data characters as converted

Stop sentinel (?)

LRC character as converted

Total: 40 characters* maximum

Once data flow begins to the UTS 30, the UTS 30 will check parity on data sent from the MSR.

C.6. STATUS REPORTING

The UTS 30 has no provisions for obtaining status codes from the magnetic stripe reader.

*The DEL character is not considered as one of these characters.

Appendix D. POC Test and Terminal Readiness Messages

D.1. GENERAL

The power-on confidence (POC) test is a series of internal diagnostic tests performed when the terminal is turned on or when the RESET PUSH button is pressed. The POC tests are resident in the terminal rather than part of the system control software. If all tests are executed successfully, the UTS 30 is ready for operation. The screen display is shown in Figure D-1.

XXXX is "PASSED" or "FAILED." As the terminal passes each test, that POC test is displayed, and then immediately erased. The POC results stay on the screen only if an error occurs, or if the keylock is in the LOCKED position.

The "10. OPTIONAL CHARACTER SET" line displays the SPERISTAR (✦) if the test is passed; no emblem is displayed if the test fails or if the hardware feature is not installed. Tests 11 through 14 are displayed only if those hardware features are installed.

If nonvolatile RAM fails, the operating parameters are reset to the default values listed in Appendix H.

D.2. KEYLOCK STATUS REPORT

The keylock status report is immediately below the POC test results. The message displayed depends on the keylock position.

<u>Keylock Position</u>	<u>Message Displayed</u>
SET UP	TERMINAL ENABLED SET UP ENABLED
NORMAL	TERMINAL ENABLED SET UP LOCKED
LOCKED	TERMINAL LOCKED SET UP LOCKED

1. ROM CHECKSUM	XXXXXX				
2. MEMORY	XXXXXX				
3. MEMORY CONTROL	XXXXXX				
4. MEMORY PARITY DETECTION	XXXXXX				
5. NONVOLATILE RAM	XXXXXX				
6. TIMERS	XXXXXX				
7. COMMUNICATIONS CHANNEL	XXXXXX				
8. KEYBOARD CHANNEL	XXXXXX				
9. PERIPHERAL CHANNEL	XXXXXX				
10. OPTIONAL CHARACTER SET	✦				
11. GRAPHICS MEMORY	XXXXXX				
12. FEATURE MEMORY	XXXXXX				
13. DISKETTE CONTROLLER	XXXXXX**				
14. KEYBOARD EXTERNAL LOOPBACK	XXXXXX**				
TERMINAL LOCKED or ENABLED					
SET UP LOCKED or ENABLED					
<table border="1"> <tbody> <tr> <td>(OFF) BLINK</td> </tr> <tr> <td>LOW INTENSITY</td> </tr> <tr> <td>REVERSE VIDEO</td> </tr> <tr> <td>HIGHLIGHT</td> </tr> </tbody> </table>		(OFF) BLINK	LOW INTENSITY	REVERSE VIDEO	HIGHLIGHT
(OFF) BLINK					
LOW INTENSITY					
REVERSE VIDEO					
HIGHLIGHT					
RELEASE RR					

9799-4

Figure D-1. Power-On Confidence Test Display

D.3. INTENSITY DISPLAY

The four lines in the boxed area below the keylock status report illustrate the display intensities. The left half of the box is nonblinking; the right half is blinking (the dividing line is between the T and E of INTENSITY). Each line is displayed in the designated intensity. Therefore, if off intensity is working, the word "OFF" will not be displayed. Highlight intensity is reverse video and low intensity.

D.4. RELEASE NUMBER

RR identifies the release level for the POC test and terminal loader firmware.

D.5. LOADING THE UNISCOPE-MODE SYSTEM CONTROL SOFTWARE TO THE PROGRAMMABLE UTS 30

On the programmable UTS 30, the load attempt begins with D1 (drive 1), checking all drives in succession and loading the first system diskette encountered. This means that if two or more system diskettes are in the drives, the system control software to be loaded must be in the drive with the lowest device identifier (D1-D4).

Appendix E. Line Monitor

The UTS 30 line monitor function permits monitoring of the communications line activity to and from the host processor. The security keylock must be in the SET UP position.

E.1. LINE MONITOR OPERATION

Monitoring of communications line activity is initiated by entering LM (line monitor) into the MM field of the UTS 30 control page. Also, CC/ON must be entered in the (PARAM) field in the control page (see Appendix J). Entering MO (monitor off) in the MM field or pressing the keyboard UNLOCK key turns the line monitor off. The terminal is partially functional while the line monitor is displayed, including the control page, peripherals, and the second screen. (Only one screen at a time can display the line monitor, however.) The screen displaying the line monitor cannot receive incoming messages.

E.2. LINE MONITOR DISPLAY

The UTS 30 line monitor function displays line protocol sequences in readable graphic representations of the ASCII control codes. Table E-1 presents each ASCII control code, its code position in the ASCII chart, and the graphic representation of the code as it will appear on the terminal screen. Each representation occupies one character position, and is easily associated with the ASCII control character it represents.

A sample line monitor display is shown in Figure E-1. The display represents a message sequence that follows the format of the line error message sequence involving host processor text. As shown in Figure E-1, all received characters are displayed in normal intensity; all characters sent from the terminal are displayed in reverse video. Figure E-2 depicts the line protocol sequences of the message with each character defined. Each step in the message sequence is explained in Table E-2.

The data portions of messages sent to other terminals on the multiplexed line are deleted from the line monitor display for security reasons.

Table E-1. Control Code Character Display

Code Position	Character	Line Monitor Rep.
0/0	NUL	■
0/1	SOH	S H
0/2	STX	S X
0/3	ETX	E X
0/4	EOT	E T
0/5	ENQ	E Q
0/6	ACK	A K
0/7	BEL	B L
0/8	BS	B S
0/9	HT	●
0/10	LF	L F
0/11	VT	V T
0/12	FF	F F
0/13	CR	C R
0/14	SO	S O
0/15	SI	S I
1/0	DLE	D L
1/1	DC1	D 1
1/2	DC2	D 2
1/3	DC3	D 3
1/4	DC4	D 4
1/5	NAK	N K
1/6	SYN	S Y
1/7	ETB	E B
1/8	CAN	C N
1/9	EM	E M
1/10	SUB	S B
1/11	ESC	E C
1/12	FS	▼
1/13	GS	◀
1/14	RS	▶
1/15	US	□
2/0	SP	S P
7/15	DEL	⌘

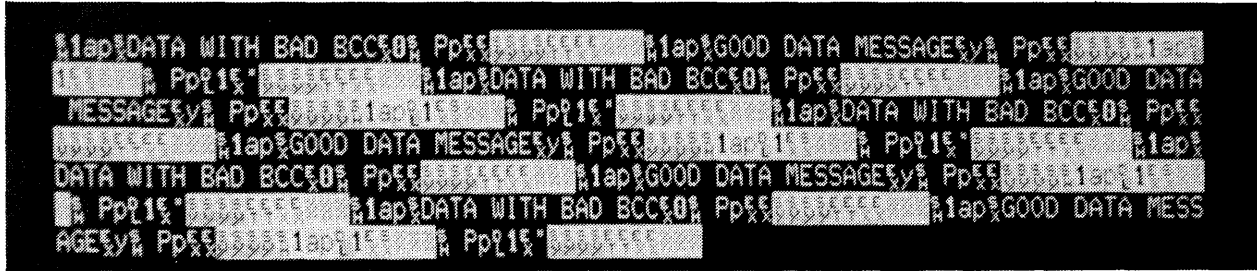
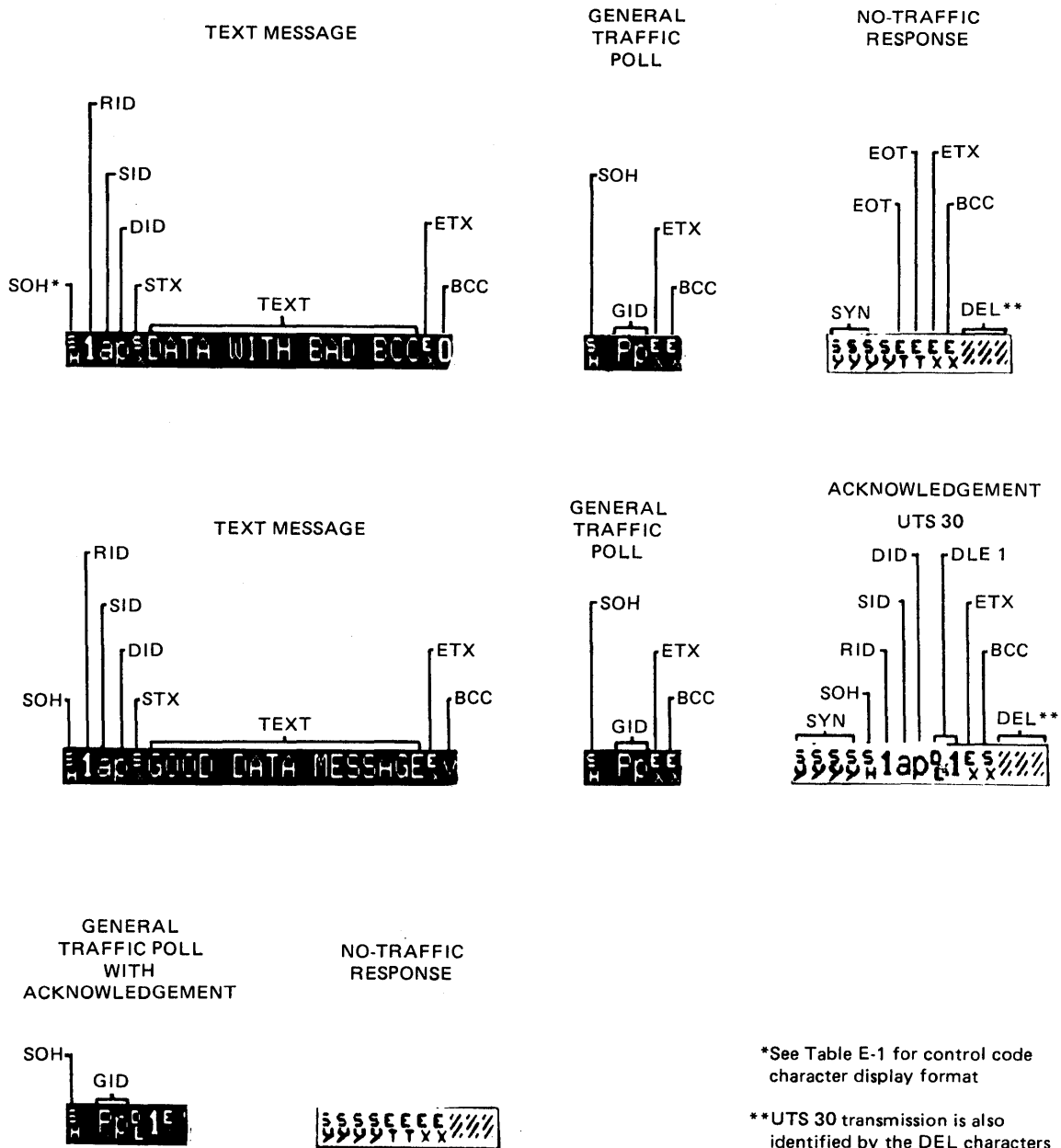

Figure E-1. Sample Display of Line Monitor Message Sequence

Table E-2. Monitor Message Sequence Explanation

Step	Explanation
1	Host processor text to the station whose RID is "1" and SID is "a" and has a general DID. Message contains bad BCC.
2	General traffic poll (GID,GID,GID).
3	No-traffic response from UTS 30. Indicates that the host processor text message sent in step 1 was not error free when it arrived at the UTS 30.
4	The host processor text message sent in step 1 is sent again.
5	General traffic poll (GID,GID,GID).
6	Acknowledgment from the UTS 30 indicating that the message in step 4 was received error free.
7	General traffic poll with acknowledgment.
8	No-traffic response from UTS 30.

HOST = NORMAL VIDEO
TERMINAL = REVERSE VIDEO (WHITE BACKGROUND)



*See Table E-1 for control code character display format

**UTS 30 transmission is also identified by the DEL characters

9143-21A

Figure E-2. Explanation of Line Error Message Sequence

Appendix F. UTS 30 Communication Handler Compatibility, Restrictions, and Limitations

F.1. UNISCOPE 100/200 AND UTS 30 COMMUNICATION HANDLER DIFFERENCES

1. The UTS 30 cannot replace UNISCOPE 100/200 terminals that use the following interfaces:
 - a. IBM* synchronous interface
 - b. IBM asynchronous interface
 - c. SPERRY asynchronous interface
 - d. MIL-STD-188 interface
 - e. Parallel (console) interface
2. If a UTS 30 is added to a multiplexed configuration containing UNISCOPE terminals, the multiplexer must be updated to provide the timing required by the UTS 30. Generally, the use of the latest multiplexer control board is required. Consult your Sperry representative for details.
3. Transmit operations on the UTS 30 are not sent directly from the keyboard; they are controlled through the (PARAM) field in the control page.
4. On the UTS 30, the US control character is not transmitted to the printer from the host.
5. Space suppression at the ends of lines does not occur during print transparent operation on the UTS 30.
6. UTS 30 timing considerations (NUL fill values) are different. See Appendix G.
7. The break-resume sequence is not supported on the UTS 30.
8. To prevent data loss, the UTS 30 keyboard is not unlocked on acknowledgment.
9. Communication timeout handlers must be lengthened to allow slower UTS 30 commit-time-on-transmit response. This is especially applicable to the host-initiated transmits DC1 and ESC DC1.

*Trademark of International Business Machines, Inc.

10. The UTS 30 always sends the DLE 6 code (power-on confidence test completed) when it completes the POC test.
11. The program attention keys (Appendix B) may affect the handler in some cases, but for the most part, the handler can ignore these functions.
12. Cursor positioning sequences not properly terminated with an SI character will not be invoked on the UTS 30. If host sequences are operating without an SI character in the cursor positioning sequences, they must be updated. See 4.4.1 for proper sequences.
13. ESC SO and ESC SI sequences are not valid for protected/unprotected field definition in the UTS 30. If host programs use these sequences, they must be updated to use SO and SI sequences only.
14. BEL sequences within text messages will not be invoked on the UTS 30.
15. The EM control character in a text message will not be recognized by the UTS 30 as an end-of-medium character. The UTS 30 uses the EM character in the immediate FCC sequence.
16. UNISCOPE 100/200 programs that input protected fields will show an apparent extra character per field if they are used with UTS 30 single stations because the UNISCOPE 100/200 terminals do not send the last character before a protected field; the UTS 30 does send that last character.
17. The UTS 30 can have a second screen. This second screen must be configured as a separate terminal on the host with its own SID address.

F.2. UTS 400 AND UTS 30 COMMUNICATION HANDLER DIFFERENCES

1. The UTS 30 cannot replace a UTS 400 which has an asynchronous interface.
2. The UTS 30 POC test response is always sent to the host, whereas the UTS 400 can omit the POC test response.
3. The UTS 30 sends a "no-traffic" response before disconnecting when the DLE EOT hangup sequence is received from the host.
4. By using all available FCC positions, the UTS 30 can generate a text message of more than 4096 bytes. When the message exceeds 4096 bytes, the UTS 30 uses the ETB code (3.5.1 and 3.5.2) to segment text messages and send them to the host in consecutive blocks.
5. The host should expect to handle throttling in the form of BUSY/THRU responses from a user program request.
6. The EM control character cannot be used in text as an end-of-medium character because the UTS 30 uses this character as part of an immediate FCC sequence (4.4.2).
7. An FCC code cannot be overwritten by an SO/SI character; an SO/SI-protected character cannot be the first character of an FCC-defined field.
8. The host must allow for differences in the error log format between UTS 400 and UTS 30 terminals (Table F-1).

9. Peripheral buffering is not available on the UTS 30.
10. On the UTS 30, the program attention keys listed in Appendix B are always available for transmission to the host.
11. The UTS 30 has an FCC location for each screen display location.
12. The FCC character-protect feature is always active on the UTS 30.
13. The UTS 30 has a second screen instead of screen bypass. Both the primary screen and the second screen are displayable. The host can use the second screen to send data to a peripheral device without displaying it on the first screen.
14. The second screen must be configured as a separate terminal on the host if it is to be used online (3.2). UTS 30 terminal addressing (SID) must allow a separate SID designation for the second screen.
15. UTS 30 timing considerations (NUL fill values) are different (Appendix G).
16. The UTS 30 can be connected to a cascaded terminal multiplexer; the UTS 400 can be connected only to a primary terminal multiplexer.

F.3. UTS 40 AND UTS 30 COMMUNICATION HANDLER DIFFERENCES

1. The UTS 30 is compatible with UTS COBOL applications written for the UTS 40 with the following constraints:
 - a. The basic UTS 30 does not support UTS 40 file management and segmentation of programs.
 - b. On the programmable UTS 30, the storage space on the 5¼-inch diskette (737 bytes) is not as large as on the 8-inch diskettes (1M byte). Program size may be restricted.
 - c. UTS COBOL programs are limited to 56K bytes of RAM memory including the interpreter, plus 8K bytes of RAM memory restricted to the UTS COBOL instructions area.
 - d. UTS 40 programs must be recompiled with the UTS 30-compatible COBOL compiler (release level 2R3) on the host.
2. The UTS 30 timing considerations (NUL fill values) are different (Appendix G).
3. Peripheral buffering does not exist on the UTS 30.

Table F-1. UTS 30, UTS 40, and UTS 400 Error Log Formats

Error Log Field	UTS 400 Contents	UTS 40 Contents	UTS 30 Contents
1	8K RAM "3" parity error count	Not used	Receive overrun errors
2	8K RAM "2" parity error count	Not used	Not used
3	8K RAM "1" parity error count	Not used	Not used
4	8-bit peripheral parity error count	Not used	Not used
5	7-bit peripheral parity error count	Not used	Not used
6	Communications parity error count	Not used	Not used
7	ROM/switch parity error count	Not used	Not used
8	CPU parity errors	Not used	Not used
9	7	Not used	Not used
10	6	Not used	Not used
11	5	Not used	Not used
12	4 parity errors per display control	Not used	Not used
13	3 (display control number)	Not used	Not used
14	2	Not used	Not used
15	1	Not used	Not used
16	Communications message received with bad character parity	Communications message received with bad character parity	Communications message received with bad character parity
17	Communications message with wrong BCC received	Communications message with wrong BCC received	Communications message with wrong BCC received
18	Communications reply request issued	Communications reply request issued	Communications reply request issued
19	Expansion (communications interface) log	Not used	Queue overflow error
20	7-bit peripheral interface retries required	Not used	Not used
21	Expansion (7-bit peripheral) log	Keyboard parity error	Keyboard parity error
22	8-bit peripheral interface retries	8-bit peripheral interface retries	8-bit peripheral interface retries
23	Expansion (8-bit peripheral) log	Not used	Not used

Appendix G. Timing Considerations

G.1. NUL REQUIREMENTS

When message-embedded screen editing functions are used, the UTS 30 timing considerations may require the use of NUL codes as time-fill to avoid communications line overflow (4.2.4).

Table G-1 compares NUL requirements for the UTS 20, UTS 30, UTS 40, and UTS 400 systems. These values assume a 9600-bps communications line. If the total message size for the UTS 30, including all editing functions and text, is less than 1024 bytes, no NULs are required.

Characters from the communications line pass through the buffer enroute to the screen. Ordinary characters are displayed shortly after they are received. The UTS 30 has a 1024-character buffer, compared with 512 characters on the UTS 20 and 256 characters on the UTS 40. Since NUL fills are necessary only after the UTS 30 buffer is full, consider carefully before assuming that any NUL fill characters are required.

The standards for deriving the nominal NUL fill examples of Table G-1 are as follows:

<u>Edit Function</u>	<u>Standard</u>
Delete in line	Distance to FCC or EOL is 20 characters
Delete line	Delete line 7; FCC at R16/CO1
Delete in display	Distance to FCC or EOD is 12 lines
Insert in line	Distance to FCC or EOL is 20 characters
Insert line	Insert line 7
Insert in display	Distance to FCC or EOD is 12 lines
Line duplicate	Concatenation distance is 8 lines
Erase to EOL	Distance to FCC or EOL is 40 characters
Erase to EOF	Distance to FCC or EOD is 12 lines
Erase unprotected to EOD	Erase from R13/CO1 (15 lines). Assume protect FCCs in C40 and release in C80
Erase display	Erase from RO9/CO1 (16 lines)
Forward tab	Distance to tab is 8 lines
Backward tab	Distance to tab is 8 lines
Cursor to home	Home from R13/CO1 (12 lines)
FCC clear	a. Distance to clear location is 8 lines b. Distance to downstream FCC location is 16 lines

*Table G-1. UTS 30 NUL Fill Comparisons
(Based on a 9600-bps Communications Line)*

Editing Function	NUL Characters Required per Editing Function			
	UTS 20	UTS 30	UTS 40	UTS 400
Delete in line	1	10	7	2
Delete line	61	54	54	72
Delete in display	28	32	33	76
Insert in line	1	10	7	2
Insert line	46	22	20	74
Insert in display	32	32	37	74
Line duplicate	18	39	47	4
Erase to EOL	2	11	9	5
Erase to EOF	41	44	50	62
Erase display	49	32	36	59
Erase to EOD (unprotected)	58	55	62	62
Forward tab	30	34	39	9
Backward tab	25	29	34	14
Cursor to home		9	7	
Position cursor		10	8	
FCC generate		89	112	
FCC clear		10	9	
Clear changed FCCs		51	64	

NOTE:

Edit/FCC operations not listed in the preceding table are constant values and require no interpretation.

G.2. EXECUTION TIMES

When determining whether NUL fill characters will be required to keep the communication queue from overflowing, the time-fill provided by each NUL character and the execution time per function must be considered. The time-fill provided by each character depends on data transmission speed. Table G-2 shows time-fill values for line speeds of 2400, 4800, and 9600 bps.

Table G-2. NUL Time-Fill Values

Line Speed	Characters per Second	Time-Fill Value Per NUL Character
2400	300	3.3 milliseconds
4800	600	1.67 milliseconds
9600	1200	0.833 milliseconds

If calculation of UTS 30 execution times is required to determine NUL requirements more precisely, refer to Table G-3. Note that, if FCCs already exist on the screen when the host data is sent, execution times are slightly slower for certain functions. These editing functions require the extension formula added to the basic formula.

G.3. DEFINITIONS

The only symbol defined in terms of characters is $D_{C/EOL}$:

$D_{C/EOL}$ = Distance, in characters, from the cursor position to the first FCC encountered or to the end of the line, whichever occurs first.

The following symbols are defined in lines or fractions of lines. These edit functions terminate at the first FCC encountered or, if there are no FCCs downstream, at the location described by the term:

EOL = End of the line

EOF = End of the field; defaults to EOD in the absence of FCCs

EOD = End of the display

HOME = Home position on the screen

TAB = Tab set location (FCCs do not apply)

FCC = First FCC location encountered

D_{FCC} applies to the "Clear FCC" editing function only.

LM denotes the number of whole lines moved in the insert line and delete line editing functions. Note that LM is an editing parameter; it has no connection to FCC locations.

Table G-3. UTS 30 Editing Function NUL Fill Formulas

Editing Function	Basic Formula* Without FCCs	Extension Formula* With FCCs
Delete in line	$9.4 + 0.02 D_{C/EOL}$	
Delete line	$15.2 + 0.47 LM$	$4.3 + 3.41 D_{FCC}$
Delete in display	$9.3 + 1.85 D_{EOD}$	
Insert in line	$9.6 + 0.02 D_{C/EOL}$	
Insert line	$15.9 + 0.38 LM$	
Insert in display	$9.6 + 1.87 D_{EOD}$	
Line duplicate	11	$3.5 D_{FCC}$
Erase to EOL	$9.3 + 0.04 D_{C/EOL}$	
Erase to EOF	$9.3 + 2.92 D_{EOF}$	
Erase to EOD (unprotected)	$11.8 + 2.77 D_{EOD}$	$1.5 + 0.69 D_{FCC}$
Erase display	$11.2 + 1.32 D_{EOD}$	
Forward tab	$10.0 + 3.00 D_{TAB}$	
Backward tab	$10.0 + 2.45 D_{TAB}$	
Cursor to home	$8.9 + 0.03 D_{HOME}$	
Position cursor	10	
FCC generate	89	
FCC clear	$9.3 + 2.01 D_{FCC}$	$0.3 + 3.19 D_{FCC}'$
Clear changed FCCs	51	

*Time in milliseconds

Appendix H. Default Parameters

UTS 30 operating parameters are entered by the operator into the parameter (PARAM) field of the control page and are stored in nonvolatile RAM. During the POC test, the nonvolatile RAM is tested for validity and operability. If the test fails, the nonvolatile RAM is reset to the parameters shown in Table H-1 and a message to the operator is displayed on the screen.

Table H-1. Default Parameters (Part 1 of 2)

Parameter Type	Default Option
Space bar	NS (nondestructive)
Screen lines	24
Characters per line	80
Control page	01 (first display line)
Keyboard click	ON (key clicks)
Autotransmit MSR data	NO (no autotransmit)
Video-off timer	04 (off after 4 minutes)
Printer speed	96 (9600 baud)
Automatic-answer hangup	NO (no automatic-answer hangup)
Communications mode	MX (multiplexer)
Channel A rate	96 (9600 baud)
Remote identifier	0*
Station identifier	0*
Device identifier	0*
Transmit expanded FCCs	DF (disable transmit)
Uppercase only**	NO (uppercase and lowercase allowed)
System response mode	OF (no system response mode)

* This is an invalid value and will cause validity check failure until a valid value is entered.

**The uppercase range will be automatically determined by the national character set selection.

Table H-1. Default Parameters (Part 2 of 2)

Parameter Type	Default Option
Control characters	OF (not displayed)
Indicator line intensity	LS (line separation)
Cycle speed	LO (low)
Load drive	D1
Screen video	NI (normal intensity)
Emphasis character	ST (strike-through)
Cursor return	CR (cursor return)
Blink markers	ON (blinking markers on line 25)
Screen control alarm	ON (alarm sounds)
Repetitive alarm	ON (alarm sounds)
Initiate full POC from host	NO (partial POC performed)
National character set	US (U.S.A. English)

Appendix I. Debug Monitor Operation

I.1. ACCESSING THE DEBUG MONITOR

Design of the UTS 30 provides a debug monitor for user program and maintenance purposes. The debug monitor is accessed by entering DB in the MM field of the control page, removing the control page, and pressing the FUNCTION and H keys. DO in the MM field on the control page disables the debug monitor. The keylock must be in the SET UP position to enable the debug monitor. Following system load, the debug monitor code occupies the address space from F000–FFFF in the user bank.

Consequently, a user program that does not use this space can be debugged with the debug monitor without any further modification. If the area above F000 is used, the debug monitor program must be assembled with the user program or mapped together with the user program. If mapped together (2), the debug monitor program can be located anywhere in user memory. The instruction CALL D\$INIT must be executed at the user program initial transfer address in order to inform the firmware of the location of the debug monitor entry point.

A third alternative is to locate the debug monitor in graphics or feature memory and use the user index subroutine 1 to inform the firmware of the debug monitor entry point.

I.2. MONITOR DISPLAY

The debug monitor displays three lines of information and allows the user to enter commands that cause the lines to be updated. A sample display is shown below.

```
A:30 F:51 B:00 C:0E D:FF E:80 H:43 L:27 X:60000 Y:B200 PC:4100 SP:CD00 SZXHPNC
BANK 1 ENTER:A,B,C,D,G,I,J,M,O,R,S,W▶
4100:0100 21 00 60 11 01 60 01 00 01 36 * 1! *BR:04EF 0792
```

The current contents of all registers are displayed on line 1. PC is the program counter. SP is the stack pointer. The F-register flags are expanded in the area to the right of SP. If a flag is underlined, it is set. The flags are:

S = sign flag
Z = zero flag
X = not used
H = half carry flag
P = parity/overflow flag
N = add/subtract flag
C = carry flag

The current bank is displayed on line 2, followed by a list of the command letters. The command, which consists of the command letter and one or two parameters (defined in the next section), is entered to the right of the SOE.

Line 3 contains the following information: current absolute address, current relative address, the contents of 10 consecutive locations in hexadecimal, these same contents in ASCII, and a list of breakpointed relative addresses. If a breakpointed address is underlined, the breakpoint is in bank 2; if it is not underlined, it is in bank 1.

Once the monitor display is on the screen, the only way to exit the debug monitor is to use the G command (Table I-1) with no breakpoint set.

I.3. MONITOR COMMANDS

The command is entered on line 2 in the 10 spaces following the SOE. The scan right and scan left keys can be used to move the cursor to correct an error in typing a command. Pressing ERASE EOL erases the command and places the cursor to the right of the SOE. The command letter can be entered in lowercase or uppercase; it is displayed only in uppercase. If a command has two parameters, a comma or a space must be used between the two.

Pressing the return key executes the command. Error messages, if necessary, are displayed in the area to the right of the command (error messages are defined in I.4). Pressing the return key when the command area is blank updates the current address to the next consecutive location. Pressing the backspace changes the current address to the previous location.

In the description of commands in Table I-1, # or \$ represents one hexadecimal digit (0 through F) of the parameter. The command shows the maximum number of hexadecimal digits allowed in each parameter; however, any parameter can be omitted, or any number up to the maximum can be entered. The letter Q in the command indicates that a selectable option can be included in the command; the options are given in the command description.

Some commands have a default for the parameter which is implemented if the command letter is not followed by a parameter. The defaults are specified in the description.

Table I-1. Debug Commands

Command	Description
A####	Set relocation base address to absolute address ####. Addresses supplied in other commands are added to the relocation base address to determine their corresponding absolute memory addresses. # default = the address currently displayed on line 3
B####,\$\$	Set breakpoint at address ####. Stop execution every \$\$th time the address is hit. # default = the address currently displayed on line 3 \$ default = 1 (every time)
C####,Q	Clear breakpoint at address #### and, optionally, clear all breakpoints (Q = A or space). # default = the address currently displayed on line 3 Q default = space
D####	On line 3, display 10 consecutive memory locations starting at address ####. # default = the address currently displayed on line 3
G####	Go execute code starting at address ####. # default = the current PC address
I####	Op step through all code, including interrupts, starting at address ####. # default = the current PC address
M##,Q or M####,Q	Modify memory or register, depending upon which letter option (Q) is selected. # default = none Q default = space Q option choices are: space = Replace the contents of the current address with ##; then update the current address to the next location. V = Replace the contents of the current address with ##. A, F, B, C, D, E, H, L = Replace the contents of the indicated register with ##. X, Y = Replace the contents of the indicated register with ####.
O####	Op step starting at address ####. Ignore interrupts. # default = the current PC address
R##	Read from port ##; display the port and its contents in the debugger message area. # default = none
S#	Select memory bank (# = 1 or 2 only). # default = none
W##,\$\$	Write contents (\$\$) as a hexadecimal value to port ##.

I.4. ERROR MESSAGES

The alarm sounds if the user attempts to move the cursor out of the command area on line 2 or presses an unacceptable key. The only keys allowed are: a through z, A through Z, 0 through 9, comma, space bar, return, backspace, ERASE EOL, scan left, and scan right.

The monitor displays an error or warning message if the command is incorrect. The invalid command is still displayed, allowing the error to be corrected.

I.4.1. Error Descriptions

ALL BREAKPOINTS ARE IN USE!

A maximum of four breakpoints may be set at one time.

BANK MUST BE 1 THROUGH 6!

The UTS 30 has six banks. This message appears if the user specifies any other number.

HEX DIGIT SHOULD BE 0 THROUGH 9, A THROUGH F!

The user entered one or more nonhexadecimal characters.

INVALID COMMAND LETTER!

The first character of the command entry is not one of those in Table I-1.

INVALID Z80 INSTRUCTION!

The user tried to execute an invalid instruction.

NO HEX NUMBER ENTERED!

A required number was omitted.

OPT NOT V, A, F, B, C, D, E, H, L, X, Y!

The letter entered for the option was not one of those on the option list.

TOO MANY HEX DIGITS!

The entry for at least one of the parameters exceeds the maximum number of digits allowed.

I.4.2. Warning Descriptions

ENTER COMMAND!

This warning is displayed when a blank command is executed. The next consecutive memory location is also displayed.

EXTRA CHARACTERS IGNORED!

This message appears if a multiple character option is entered or the user types other unexpected information. All letters in the option entry are ignored and the default option is implemented.

Appendix J. Control Page

J.1. CONTROL PAGE FORMAT

(**PRINT*)STA-	(**XFER**)PRNT()	XFER()	XMIT()	MM (PARAM)
(/ /)ADR-	(/ /)SEARCH()	(/)

9143-24A

Figure J-1. Control Page Format

Figure J-1 shows the control page format. For information on how the host can use the control page, see section 4.3.4.

NOTE:

See the UTS 30 operator's reference, UP-9798, for additional control page information.

J.2. INFORMATION FIELDS ON THE CONTROL PAGE

J.2.1. The ADR- Field

This field displays a screen block number between 0001 and 9999 within the current opened file on a specific diskette drive in the programmable UTS 30. This field is not used on the basic UTS 30.

J.2.2. The SEARCH() Field

This field has two functions on the programmable UTS 30. The SEARCH() field may identify searches to be performed on peripheral devices defined in the "from" subfield of the (**XFER**) field (see J.5), or it may alternatively specify the address termination of a CO (copy) function.

The search format is: (bbbb/hhhhhhhhhhhhhhhhh); bbbb is a screen block number between 0001 and 9999 within the current opened file. The slash separates the address and the header. The header may contain up to 16 characters. Entering bbbb only positions the read/write head at the beginning of that block; the block is not displayed. Entering bbbb/hhhhhhhhhhhhhhhhh positions the read/write head at the beginning of the block, then begins a search of that block and subsequent blocks to find a block header matching that specified by hhhhhhhhhhhhhhhhh. If a match is found, the screen block is displayed.

J.2.3. The STA- Field

The STA- field does not allow data entry. It is a 6-character field that reports the 2-character mnemonic and a 3-character status code of a specified peripheral device. The printer mnemonic may be P1 or PR for printer 1, P2 for printer 2; the diskette drive mnemonic may be D1, D2, D3, or D4. Printer or diskette status codes may be combined to form multiple-error codes. For instance, P1 100 and P1 200 may be combined as P1 300. The device-independent codes cannot be combined; each identifies a unique status condition.

Table J-1 lists printer codes for the basic and the programmable UTS 30, diskette codes for the programmable version, and device-independent codes for both basic and programmable versions.

Table J-1. Peripheral Status Codes (Part 1 of 2)

Status Codes		Meaning
PRINTER STATUS CODES		
P1 or PR; P2	000	Device ready
P1 or PR; P2	001	Data error
P1 or PR; P2	004	Printer parameter code error
P1 or PR; P2	010	Mechanical error
P1 or PR; P2	040	Device POC
P1 or PR; P2	100	Device not ready
P1 or PR; P2	200	Out of paper

Table J-1. Peripheral Status Codes (Part 2 of 2)

Status Codes		Meaning
DISKETTE STATUS CODES		
D1 to D4	000	Operation successful
D1 to D4	001	Data error
D1 to D4	002	End of diskette
D1 to D4	004	CRC error
D1 to D4	010	Diskette address error
D1 to D4	020	Error in prep
D1 to D4	040	Write-protected diskette
D1 to D4	100	Diskette subsystem not ready
D1 to D4	200	I/O not complete
DEVICE-INDEPENDENT CODES		
366		File not opened
367		File already exists
370		Read-only file
371		File not found
372		Device not configured
373		Keyboard unlocked, terminating operation
374		Invalid device, track, sector, records, or length (user program status)
375		No response from device
376		Device busy (user program status)
377		Invalid command (user program status)

J.2.4. The Special Code Field

The 3-character field below the protected MM label displays the ASCII representation of the RID, SID, and communications link to the host processor that were entered in the (PARAM) field. It does not allow operator entry.

An ASCII code conversion chart for the RID and SID is provided in Figure B-1. The communication mode codes are:

- X = Multiplexer
- M = Modem or DCM
- D = Direct connection

J.2.5. The MM Field

On the right of the protected MM label is a 2-space field for entry of maintenance codes or for displaying current parameter options (basic UTS 30 only). For more information, see the UTS 30 verification guide, UP-9804. A list of maintenance mode codes and their functions is provided in Table J-2.

Table J-2. Maintenance Mode (MM) Field Entries

Code	Function
CE	Clear error log. The error log is also cleared by failure of the nonvolatile RAM (default values assumed) or a clear error log command from the host.
EL	Error log. Displays a count of the errors that have occurred internally, on the communications line, and in peripherals. Both the terminal operator and the host processor have access to this log. (See Appendix M.)
DB	Enables the debug monitor routine for user program and maintenance functions. Enables the FCTN H key which is used to display the debug monitor. See Appendix I for detailed instructions.
DO	Disables the debug monitor routine and the FCTN H key.
DP	Display parameters (basic UTS 30 only). A list of parameter values is displayed on the screen with current values in reverse video. The screen is protected and the keyboard is locked. (See Figure J-2.)
CY	Cycle POC. Causes the power-on confidence (POC) test to be executed continuously until the RESET PUSH button is pressed or an error is encountered. CY acts like a power off and power on, clearing user memory.
IP	Invert polarity. Inverts the polarity of the "send data," "request to send," and "data terminal ready" lines. Pressing the RESET PUSH button clears the IP selection.
LL or LX	Starts a series of external loopback diagnostic tests on the basic UTS 30 only. The terminal is not functional while the loopback test is running. When LL or LX is entered, the screen is erased and any data on the screen is lost. See the UTS 30 verification guide, UP-9804, for descriptions and instructions.
LM	Line monitor. Displays the communications line traffic, including control sequences, on the display screen. (See Appendix E.)
MO	Monitor off. Stops the line monitor display.
RN	Record separator on. Turns the record separator function on and changes the protected letters MM to MO to indicate that the record separator function is on. The RN function translates certain keyboard-generated characters to control characters for recording and recalling.
RF	Record separator off. Turns the record separator function off. Changes MO back to MM.

J.2.6. Current Parameter Options Display

On the basic UTS 30 only, the MM field is also used to cause display of current parameter options. Parameter display for the programmable UTS 30 is available through a utility. Both displays allow the operator to change parameter options.

On the basic UTS 30, DP (display parameters) is entered in the MM field. When the control page is removed, the screen is cleared and the parameter options are displayed in reverse video in the format shown in Figure J-2. Pressing FCTN and F5 erases the parameter options display and places the cursor in home position on a blank screen. See the current version of the UTS 30 operator's guide, UP-9798.

J.3. OPERATIONAL CHARACTERISTICS: THE (PARAM) FIELD

Below the protected (PARAM) field label are two subfields into which the operator enters codes to determine operating characteristics or configure the peripheral devices. These choices are stored in nonvolatile RAM in the terminal. Table J-3 lists the options.

CURRENT OPTIONS APPEAR IN REVERSE VIDEO. TO CHANGE A PARAMETER, USE SCAN OR TAB KEYS TO MOVE CURSOR TO DESIRED OPTION, THEN PRESS XMIT. TO EXIT, PRESS F5.			
REMOTE IDENTIFIER*	XY	PRINTER DID*	XY
STATION IDENTIFIER*	XY	LINES PER SCREEN	XY
CONTROL PAGE LINE NUMBER	XY	COLUMNS PER LINE	XY
CHARACTER CYCLE SPEED	FAST/SLOW	VIDEO OFF TIMER	XY
DESTRUCTIVE SPACE BAR	YES/NO	KEYBOARD CLICK	ON/OFF
SCREEN CONTROL ALARM	ON/OFF	REPETITIVE ALARM	ON/OFF
DISPLAY CONTROL CHARACTERS	YES/NO	UPPERCASE ONLY	YES/NO
COMMUNICATIONS MODE*	MODEM/MUX/DC	DIRECT CONNECT RATE*	9600/4800/2400
TRANSMIT EXPANDED FCCs	YES/NO	BLINK MARKERS	ON/OFF
AUTO-TRANSMIT MSR DATA	YES/NO	AUTO HANGUP*	OFF/.5/1/3/5
SYSTEM RESPONSE MODE	ON/OFF	HOST POC	YES/NO
CURSOR RETURN	CURSOR RETURN/LINE FEED		
PRINTER SPEED	9600/4800/2400/1200/600/300		
EMPHASIS CHARACTER	STRIKE THROUGH/OPTIONAL CHARACTER SET		
INDICATOR LINE	LINE SEPARATOR/NORMAL/REVERSE VIDEO		
SCREEN VIDEO	NORMAL/REVERSE VIDEO		
NATIONAL CHARACTER SET*	US/UK/GE/FR/SP/DN/SF/IT		
PRINTER TYPE	DUPLEX/SIMPLEX		
* PUSH RESET TO IMPLEMENT CHANGE.			

9799-7

Figure J-2. Parameter Options Display

Table J-3. Parameter Options (Part 1 of 5)

Parameter Type (pt)	Parameter Options (po)	Meaning and Function
AA*	NO (default) Y1 Y2 Y3 Y4	Automatic hangup. Specifies the amount of time that can elapse during which no data is on the communications line before the connection is automatically terminated. NOTE: Automatic hangup is in effect only if the CM parameter is set to MD (modem). No automatic hangup. Terminates after 30 seconds. Terminates after 60 seconds. Terminates after 180 seconds. Terminates after 300 seconds.
AR*	96 (default) 48 24	Direct-connect rate. Specifies the speed at which characters are passed to and from the host when a direct connection from terminal to host is used. Used only if CM = DC. 9600 bits per second. 4800 bits per second. 2400 bits per second.
AT	NO (default) YS	Autotransmit. Specifies whether data read by the magnetic stripe reader will be automatically transmitted by the operator. Data read in autotransmit mode is not displayed; it is stored in nondisplayable storage before transmission. No autotransmit. Data is displayed on screen and must be transmitted by operator. Autotransmit. Security input mode.
BM	ON (default) J OF	Blinking markers or blanks may be displayed with certain indicator line messages. Blinking markers displayed. Blanks displayed.
CC	OF (default) ON	Control character display. Specifies whether control characters (including LF, FF, and tab stop) will be displayed. The line monitor always displays the control characters, regardless of the parameter. Control characters not displayed. Control characters displayed.
CL	Any numeric entry from 01 to 80	Characters per line. Specifies the number of characters per line on the display. Default is 80.

*Parameter is not changed until control page is removed from the screen and the RESET PUSH button is pressed.

Table J-3. Parameter Options (Part 2 of 5)

Parameter Type (pt)	Parameter Options (po)	Meaning and Function
CM*	MX (default) MD DC	Designates the type of communications link to the host. Multiplexer. Modem or DCM. Direct connection. If this option is selected, the AR parameter must be specified.
CP	Any numeric entry from 01 to 23	Control page. Specifies on which line of the screen the first line of the control page will be positioned. Default is 01.
CR	CR (default) LF	Cursor return determines whether, during an output to a printer, a cursor return is output as a cursor return or as a line feed. Cursor return is sent to printer. Line feed character is sent to printer.
CS	LO (default) HI	Cycle speed. Specifies the rate at which cycling keys cycle. Low cycle rate equals 12.5 characters per second. High cycle rate equals 25 characters per second.
EM	ST (default) LC	Emphasis character. Determines whether the strike-through emphasis character or the optional character set is enabled. (An audible alarm will sound if the unimplemented key is pressed.) Strike-through character (FCTN L key) is enabled. Loadable character set (FCTN ; key) is enabled.
HP	NO (default) YS	Host POC request. Specifies whether or not the terminal runs a POC test upon receipt of POC test command from the host. Host cannot institute a POC test . Host can institute a POC test.
IL	LS (default) RV NI	Indicator line intensity. Designates the intensity of the indicator line (line 25 at the bottom of the screen). Line appears separating indicator line and rest of screen. Indicator line appears in reverse video. Indicator line appears in normal intensity.

*Parameter is not changed until control page is removed from the screen and the RESET PUSH button is pressed.

Table J-3. Parameter Options (Part 3 of 5)

Parameter Type (pt)	Parameter Options (po)	Meaning and Function
KK	ON (default) OF	Keyboard click. Specifies whether an audible click occurs when a key is pressed. Key clicks. No key click.
LD	D1 to D4	Load drive. Specifies the default diskette drive used for system control software reload on the programmable UTS 30. Default is D1.
LN	Any numeric entry from 02 to 24.	Number of lines on the display. Default is 24.
NC*	US (default) UK GE FR SP DN SF IT	Selects the national character set, including uppercase characters. United States United Kingdom Germany France Spain Denmark/Norway Sweden/Finland Italy
PS	03 06 12 24 48 96 (default)	Printer speed. Sets data transfer rate from the terminal to the printer. Depends on the requirements of individual printers. 300 baud 600 baud 1200 baud 2400 baud 4800 baud 9600 baud

*This parameter is not changed until the control page is removed from the screen and the RESET PUSH button is pressed.

Table J-3. Parameter Options (Part 4 of 5)

Parameter Type (pt)	Parameter Options (po)	Meaning and Function
RI*	Any hexadecimal number from 21 to 7F.	Remote identifier. Identifies the transmission (communications) line (RID).
SI*	Any hexadecimal number from 20 to 7F	Station identifier. Identifies the terminal. The UTS 30 operator enters the SID for screen 1; the terminal automatically assigns screen 2 a SID one higher than that for screen 1. NOTE: Where two or more terminals are under the same RID, each terminal must have two unique SIDs, one for each screen.
RA	ON (default) OF	Determines whether or not the alarm sounds repeatedly for peripheral errors, and to signal a host message is waiting. The repeating alarm for RAM parity error is not affected by this parameter. Alarm sounds repeatedly. Alarm sounds only once.
SA	ON (default) OF	Screen control alarm. Alarm sounds once when cursor enters eighth position before end of line or when cursor enters last line of display. No alarm sounds under the above conditions.
SP	NS (default) DS	Space bar selection. Specifies whether pressing the space bar causes the character displayed under the cursor to be deleted. Nondestructive space bar. Space bar does not erase the character under the cursor. Destructive space bar. Erases the character under the cursor.
SR	OF (default) ON	System response mode. For use with SPERRY System 80 only. Specifies whether the terminal will operate in system response mode, in which system response lines can be displayed, and the SY MD and WS MD keys are enabled. No system response mode capability. System response mode operational.
SV	NI (default) RV	Screen video. Designates the intensity of the screen display background. Normal intensity. Reverse video.

*These parameters are not changed until the control page is removed from the screen and the RESET PUSH button is pressed.

Table J-3. Parameter Options (Part 5 of 5)

Parameter Type (pt)	Parameter Options (po)	Meaning and Function
TF		Transmit expanded FCCs. Specifies whether or not expanded FCCs are transmitted to the host processor and peripherals.
	EF	Enables transmission of expanded FCCs.
	DF (default)	Disables transmission of expanded FCCs.
UC		Uppercase only. Specifies whether all keyboard and magnetic stripe reader alphabetic characters will be uppercase only (SHIFT key position ignored) or be governed by the SHIFT key. The range of uppercase letters changes automatically to correspond to the national character set selection. (See Figure B-2.) Data from the host is not affected.
	NO (default)	Uppercase and lowercase alphabetic characters.
	YS	Only uppercase characters.
VO	01 to 99 04 (default)	Video-off timer. Defines the amount of time that elapses with no input to the CRT before the display turns off. Numeric entry specifies time in minutes. A power-on symbol is displayed below line 25 while the screen is blank.

J.4. CONFIGURING PERIPHERAL DEVICES

The basic UTS 30 may have two printers. The programmable UTS 30 peripheral devices may include two printers and one or two diskette subsystems, each with one or two diskette drives. The first diskette subsystem connected to the terminal is referred to as the primary subsystem; the second is referred to as the secondary subsystem. The host can reconfigure the terminal if the parameter controlling the host POC request (Table J-3) is set to HP/YS at the terminal.

The two subfields of the (PARAM) field are used to specify the type of peripheral device and to select the device identifier (DID). The first subfield specifies the type of peripheral device. See Table J-4.

Table J-4. Configuring Peripheral Devices —
Entries in the First Subfield of the (PARAM) Field

Entry	Meaning
1P:	Printer
1D:	A single-drive primary diskette subsystem
2D:	A dual-drive primary diskette subsystem
1S:	A single-diskette secondary subsystem
2S:	A dual-drive secondary diskette subsystem

The second subfield selects the DID of the printer or the lowest select DID of the diskette drive. Valid DIDs are 20 to 7E (hexadecimal). However, if the terminal is used for online operations with the host, the following DIDs should be avoided as they have special host functions:

70, 71, 72, and 7F

A printer requires only one DID. Each diskette drive requires two DIDs, a read DID and a write DID. The operator enters the write DID for the first drive and the system assigns the next higher DID as the read DID for the first drive. The system then automatically assigns successively higher write and read DIDs for the second drive in a dual-drive diskette subsystem. (Refer to Table J-5.)

J.5. SPECIFYING PRINT AND TRANSFER OPERATIONS

J.5.1. Peripheral Operations

The (**PRINT*) and (**XFER**) fields specify the peripheral operations to be performed on data when the PRINT or XFER key is pressed, and initiate transfer of this data. On the basic UTS 30, the data can only be transferred to the printer; on the programmable version, data can be transferred to either diskette subsystem or printer.

These fields are accessible to both the host and the terminal operator. The formats and functions of the two fields are similar; the significant difference is that when the (**XFER**) field is used, the FCCs are transmitted and can be printed.

Below the (**XFER**) protected labels are three subfields: (from/to/function). These subfields are used for peripheral device information, as follows:

The "from" subfield specifies the device from which data is to be obtained (for example, from D2).

The "to" subfield defines the peripheral device to which the data will be sent. In the case of the UTS 30 basic version, this is the printer; in the case of the UTS 30 programmable version, this may be the printer or diskette subsystems.

The "function" subfield specifies the type of activity to be performed (for example, write).

Entries allowed in the subfields are defined in Tables J-5 and J-6.

*Table J-5. Entries in the "From" and "To" Subfields of the (**PRINT*) and (**XFER**) Fields*

Entry	Meaning
P1 or PR	Designates the printer attached to the programmable UTS 30.
D1 to D4	Designates a specific diskette drive attached to the programmable UTS 30. Note: The identifiers for the primary diskette subsystem are D1 for the left drive and D2 for the right drive. Identifiers for the secondary diskette subsystem are D3 for the left drive and D4 for the right drive. If either diskette subsystem has only one drive, the identifiers are assigned consecutive numbers, ignoring the empty space. Thus, if the primary diskette subsystem has only one drive, it will be D1 and the two drives in the secondary subsystem will be D2 and D3.

Table J-6. Entries in the "Function" Subfield of the (**PRINT*) and (**XFER**) Fields

Entry	Meaning
Blank	Default condition. Designates the write function. Causes screen data to be written to the device specified in the "to" subfield when the PRINT or XFER key is pressed. (Only the WRITE function is available on the basic version of the UTS 30.)
AT	Designates the autotransmit function. Successive blocks of data are displayed and transferred without operator intervention. The transmit mode specified in the XMIT() field defines the format in which the data will be transmitted.
CO	Designates the copy function. This operation inputs data to the screen from the diskette specified in the "from" subfield, and then outputs through the screen to the device specified in the "to" subfield. This process continues until the input device reaches the address previously entered by the operator in the SEARCH() field, until the operation is manually terminated, or until the end of media occurs.
ED	Designates the edit function. This operation is similar to the copy function except that the operator first has the chance to change each screen of data before it is passed to the device identified in the "to" subfield. This process continues until the input device reaches the address previously entered by the operator in the SEARCH() field, until the operation is manually terminated, or until the end of media occurs.
HO	Designates the home function. The device specified in the "from" subfield will search to the starting address (home position) when the PRINT or XFER key is pressed.
RD	Designates the read function. The diskette drive specified in the "from" subfield reads and inputs one screen of data each time the operator presses the PRINT or XFER key, as applicable.
CD	Copy diskette. Designed for copying the system diskette. All information on the diskette designated in the "fr" field is copied to the diskette designated in the "to" field. No "file open" command is needed.

J.5.2. Format of Print and Transfer Operations

J.5.2.1. PRNT() Field

This 4-character field specifies the format of the print function to be performed when the PRINT key is pressed. Allowable entries are listed in Table J-7. These functions apply only to the write, copy, and edit entries in the (**PRINT*) field. All data from the home position or from the last SOE position through the cursor position is printed. FCCs are not included.

Table J-7. Entries in the PRNT() Field

Entry	Meaning
PRNT	Trailing spaces on each line are suppressed (except in the line containing the cursor), and the carriage return (CR) code is added at the end of each line. PRNT is the default condition.
FORM	Trailing spaces on each line are suppressed (except in the line containing the cursor), and spaces are printed instead of protected characters. The CR code is added at the end of each line.
XPAR	Causes a print transparent operation. All CR codes are suppressed, no FCCs are included, and no spaces are suppressed.

J.5.2.2. XFER() Field

The entry in this 4-character field specifies the format of the transfer function that will be performed by the UTS 30 when the XFER key is pressed. For each entry, data on the screen from the home position (or from the last SOE position) through the cursor location, plus any included FCCs, is transferred. Spaces at the ends of lines and cursor returns (CR) are suppressed. The entries are listed in Table J-8. This field applies only to the write, copy, and edit entries in the (**XFER**) field.

J.5.2.3. XMIT() Field

This 4-character field specifies the type of online transmission that will be performed when the XMIT key is pressed. These are the same entries and the same functions defined for the XFER() field. See Table J-8.

Table J-8. Entries in the XFER() and XMIT() Fields

Entry	Meaning
ALL	Causes all data and FCCs from home position or the last SOE through the cursor position to be transferred.
VAR	Causes only unprotected data and FCCs to be transferred. This is the default condition.
CHAN	Causes only FCC fields that have been changed, as indicated by the internal changed-field indicators, to be transferred.

Appendix K. Field Control Characters

K.1. GENERATING FIELD CONTROL CHARACTERS

Table K-1 lists the UTS 30 keyboard operator's entries for generating FCCs. They are listed in the order in which they are assigned. Note that it takes five entries (five keystrokes) to define an FCC.

NOTE:

See the UTS 30 operator's reference, UP-9798, for more information.

Table K-1. UTS 30 Operator's Entries for Generating FCCs (Part 1 of 2)

Sequence	Entry	Function
1. Intensity	Space or N	Normal display intensity
	L	Low display intensity
	B	Blink from normal to low intensity
	O (not zero)	Off intensity
	1*	Character displayed against a high-intensity, reverse-video background
	2*	Character displayed against a low-intensity, reverse-video background
	3*	Character displayed against a background that blinks from high-intensity reverse video to low-intensity reverse video
	4*	Character displayed against a background that blinks from low-intensity reverse video to off
2. Tab stop and special character protection	5*	Character blinks from high intensity to normal against a reverse-video background
	Space or S	No FCC-defined tab stop
	T	Tab stop
	6*	Tab stop — special characters protected
	7*	No tab stop — special characters protected

*These are expanded FCC entries; those without asterisks are primary FCC entries.

Table K-1. UTS 30 Operator's Entries for Generating FCCs (Part 2 of 2)

Sequence	Entry	Function
3. Data entry	Space or U	Unrestricted data entry
	P	Protected; no keyboard entry allowed
	A	Alphabetic key entries only
	N	Numeric key entries only
4. Field justification	Space	Normal justification
	R	Right-justification
5. Sequence complete	Space or any alphanumeric key	Completes the sequence

K.2. FCC CODES

FCC codes and the field characteristics that are defined are given in Tables K-2 through K-5.

Table K-2. M in Primary FCC Sequence

Tab Stop	Field Changed	Normal intensity	0 30
		Video off	1 31
		Low intensity	2 32
		Blinking	3 33
	Field Not Changed	Normal intensity	4 34
		Video off	5 35
		Low intensity	6 36
		Blinking	7 37
No Tab Stop	Field Changed	Normal intensity	8 38
		Video off	9 39
		Low intensity	: 3A
		Blinking	: 3B
	Field Not Changed	Normal intensity	< 3C
		Video off	= 3D
		Low intensity	> 3E
		Blinking	? 3F

Table K-3. N in Primary FCC Sequence

Normal Field	Any	0 30
	Alpha	1 31
	Numeric	2 32
	Protected	3 33
Right-Justified	Any	4 34
	Alpha	5 35
	Numeric	6 36
	Protected	7 37

Table K-4. ASCII Characters Used as M in the Expanded FCC Sequence

				Emphasis Not Protected		Emphasis Protected	
Tab Stop	Field Changed	Normal Intensity	Video on	@ 40	P 50	\ 60	P 70
			Video off	A 41	Q 51	a 61	q 71
		Low Intensity	Video on	B 42	R 52	b 62	r 72
			Video off	C 43	S 53	c 63	s 73
	Field Not Changed	Normal Intensity	Video on	D 44	T 54	d 64	t 74
			Video off	E 45	U 55	e 65	u 75
		Low Intensity	Video on	F 46	V 56	f 66	v 76
			Video off	G 47	W 57	g 67	w 77
No Tab Stop	Field Changed	Normal Intensity	Video on	H 48	X 58	h 68	x 78
			Video off	I 49	Y 59	i 69	y 79
		Low Intensity	Video on	J 4A	Z 5A	j 6A	z 7A
			Video off	K 4B] 5B	k 6B	{ 7B
	Field Not Changed	Normal Intensity	Video on	L 4C	\ 5C	l 6C	7C
			Video off	M 4D	[5D	m 6D	} 7D
		Low Intensity	Video on	N 4E	^ 5E	n 6E	~ 7E
			Video off	O 4F	_ 5F	o 6F	# 7F

Table K-5. N in Expanded FCC Sequence

			Normal Intensity	Reverse Video
No blink	Normal Field	Any	@ 40	P 50
		Alpha	A 41	Q 51
		Numeric	B 42	R 52
		Protected	C 43	S 53
	Right-Justified	Any	D 44	T 54
		Alpha	E 45	U 55
		Numeric	F 46	V 56
		Protected	G 47	W 57
Blinking	Normal Field	Any	H 48	X 58
		Alpha	I 49	Y 59
		Numeric	J 4A	Z 5A
		Protected	K 4B	 5B
	Right-Justified	Any	L 4C	\ 5C
		Alpha	M 4D] 5D
		Numeric	N 4E	^ 5E
		Protected	O 4F	— 5F

K.3. TRANSMISSION OF EXPANDED FCCS

The "transmit expanded FCCs" parameter (TF in the (PARAM) field on the control page) determines whether primary or expanded FCCs are transmitted to the host and transferred to diskette. Table K-6 shows how expanded FCCs are translated to primary FCCs.

Table K-6. Translation of Expanded FCCs to Primary FCCs

Entry*	FT = EF		TF = DF	
	M	N	M	N
L	4A	40	3A	30
B	48	48	3B	30
O	49	40	39	30
1	48	50	38	30
2	4A	50	3A	30
3	4A	48	3A	30
4	4A	58	3A	30
5	48	58	3B	30
6	60	40	30	30
7	68	40	38	30

*The "Entry" column shows the codes entered by the operator to define the intensity, FCC tab stop, and special character protection variations. See Table K-1.

where:

+
is normally blank, but can be programmed

A
is accent area

O
is normal character area

D
is descender area

The positions of the special emphasis characters are defined by hardware:

Row 8	Strike-through
Row 15	Underscore
Column 1	Column separator

A sequence of 15 ASCII character pairs defines each matrix. Each byte in the pair is biased by hexadecimal 40. Byte 1 represents the left side of the dot matrix and byte 2 represents the right side:

<u>Byte 1</u>	<u>Byte 2</u>
01BCXXSS	01SSSSSX

where:

X
is loadable defined dot of the 10-by-15 dot matrix, equivalent to D, A, and O in Table L-1

S
is standard loadable defined dot of the 10-column dot matrix, equivalent to O in Table L-1

B
blink dot

C
blank dot (used for nondisplayable control characters)

Thus, each pair provides a 10-dot row definition for the loadable cell which begins at the address defined by YYY in the loading sequence. Since 30 bytes are required to define a single character, 15,360 bytes are required to load a set of 512 bytes.

L.2. LOADING CHARACTERS FROM THE HOST TO THE UTS 30

The sequence sent from the host to load the character generator memory in the UTS 30 is:

STX ESC SO 041? XXYYY XXYYY MH MV text ETX BCC

where:

041?

are the four ASCII characters identifying this as a character set load.

XX

is the 2-character ASCII identifier of the set to be loaded.

YYY

is the address (hexadecimal) of the first character to be loaded consisting of three hexadecimal digits, each biased by bits 5 and 6 set. (A hexadecimal address of 07D biased by hexadecimal 60 becomes the three characters 060, 067, and 06D.) The standard character set memory addresses are hexadecimal 00 through FF; the optional character set memory addresses are hexadecimal 100 through 1FF.

The first XXYYY is the start address; the second is a duplicate check.

MH

is the character matrix identifier for the horizontal dots per character, biased by bit 6 set. The maximum is 12 horizontal dots per character. This total includes the blink and the blank bits. With bit 6 set, the code for this control character is the ASCII character L (04C hexadecimal).

MV

is the character matrix identifier for vertical dots per character, biased by bit 6 set. For the UTS 30, this matrix should be set for 15 (0F hexadecimal) vertical dots per character. With bit 6 set, the code for this control character is the ASCII character O (04F hexadecimal).

text

is a string of ASCII characters, biased by bit 6 set. Each character represents a string of dots and/or attributes (device-dependent) which defines each horizontal row of the character. The number of ASCII characters required to define a character font is MH divided by 6 (rounded up) times MV.

Figure L-1 is an example of defining one character which is to be sent to the optional character set memory at address 120 (hexadecimal). The identifier (XX) is SP (special). The text message is:

STX ESC SO 041? S P 61 62 60 SP 61 62 60 4C 4F (text hexadecimal values shown in the figure) ETX

40	40
40	40
40	40
41	7C	...00000..
42	42	..0....0.
42	40	..0.....
42	40	..0.....
41	7C	...00000..
40	420.
40	420.
42	42	..0....0.
41	7C	...00000..
40	40
40	40
40	40

Figure L-1. Example of Optional Character Definition and Addressing

When loading the UTS 30 character set memory from the host, multiple load blocks are required to load an entire set because of error recovery considerations. Each block must have its own header that includes the address of the first character to be loaded within that block. Several 30-byte sequences (15 pairs) can be included in one text block with no intervening address (XXYYY), provided that the subsequent sequences within the block load the next sequential characters.

The escape sequence ESC U sent by the host causes the UTS 30 to return the identification of the set which was loaded last. The host request must be by itself in a text message:

SOH ESC U ETX

The UTS 30 response to the message will be in a subsequent text message whose format is:

ESC VT 20 20 00 SI ESC SO ; 0 0 7 XX PP XXQ__ ETX

where XX is the ASCII character pair defined above. The XX of an empty character set is @@.

PP is a fixed value. It represents a font size of 00, biased by 50 (hexadecimal). Q__ represents the size of the font identified by XX. The range of Q__ is from 00 through 1FF (hexadecimal) biased by 50 (hexadecimal).

L.3. USING THE OPTIONAL CHARACTER SET

Characters loaded to the standard character space (hexadecimal 00 through FF addresses) will overwrite the standard set and remain in memory until the UTS 30 is reloaded from the UNISCOPE-mode system control software. Characters loaded into the optional character set memory can be selected by the host character-by-character using the special escape sequence ESC 22 to set a hardware-sensed bit in memory. Unless this sequence is used, all characters are displayed from the standard character set. The message containing the sequence can be any valid text message which contains the following string:

ESC 22 text ESC 20

The ESC 22 sequence begins the optional character set selection sequence. The text is spaces or ASCII code. The ESC 20 terminates the selection string. The terminal transmits the selection string for all strings which have the optional character set selection bit set.

From the keyboard, the optional character set is selected by pressing the FCTN and ; (semicolon) keys. Setting the optional character set bit either through the UTS 30 keyboard or by using the host ESC 22 sequence causes the character displayed in that position to come from the optional character set. If the emphasis-protect bit is set by a host or terminal-resident application program, the operator cannot make the position revert to a character from the standard character set.

Appendix M. Error Log Format

The error log consists of 23 fields, each containing two characters. Figure M-1 shows the error log format. Zeros in each field indicate no error; any other number indicates how many errors of that type have occurred.

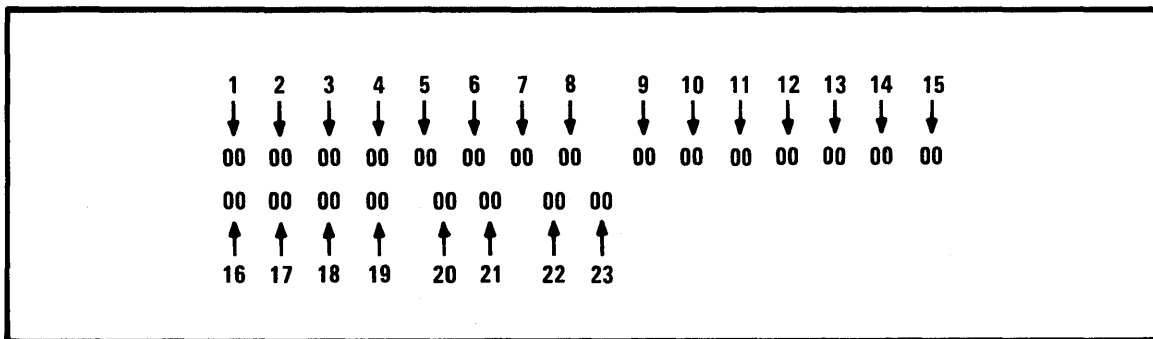

9182-13B

Figure M-1. Error Log Display

Table M-1 defines each error log field and gives the order in which the fields are sent. The error count is truncated at 99 for each field.

Table M-1. Definition of Error Log Fields

Error Log Field	Contents
1 through 15	Not used
16	Communications message with bad character parity received
17	Communications message with wrong BCC received
18	Communications reply request issued
19	Queue overflow error
20	Not used
21	Keyboard parity error
22	Peripheral retries
23	Not used

NOTE:

Because the error log is kept in nonvolatile RAM, errors can be recorded in the error log only when the keylock is in the SETUP or LOCKED position.

Appendix N. Graphics

Table N-1. Host Commands to Define Graphics Display Modes

Command	Description	Para. Ref.
ESC Za	Enter graphics mode	5.3.1.
ESC Zc	Enter merged mode	5.3.2.
ESC Zb	Exit graphics mode	5.3.3.
ETX	Exit graphics; retain display	5.3.4.
ETB ETX	Partial message	5.3.5.
ESC DC2	Send graphics to printer	5.3.6.

Table N-2. Graphics Commands

OPERATOR		OPERAND		
Title	ASCII Char.	Type	Default	Para. Ref.
Control:				
Initialize Graphics	ZI	2 unsigned integers		5.4.1.
Initialize View Surface	ZO	1 unsigned integer		5.4.2.
Select View Surface	ZA	Same as ZO		5.4.3.
Terminate View Surface	ZC	Same as ZO		5.4.4.
New Frame	ZN	None required		5.4.5.
Terminate Graphics	ZT	None required		5.4.6.
Moving:				
Move Absolute	A	unsigned integers		5.4.7.
Move Relative	B	signed integers		5.4.8.
Drawing:				
Polymarker Absolute	E	* unsigned integers		5.4.9.
Polymarker Relative	F	* signed integers		5.4.10.
Polyline Absolute	C	* unsigned integers		5.4.11.
Polyline Relative	D	* signed integers		5.4.12.
Polygon Absolute	G	* unsigned integers		5.4.13.
Polygon Relative	H	* signed integers		5.4.14.
Rectangle Absolute	I	1 unsigned integer		5.4.15.
Rectangle Relative	J	1 signed integer		5.4.16.
Circle	O	1 unsigned integer		5.4.17.
Arc	M	3 unsigned integers		5.4.18.
Sector	K	3 unsigned integers		5.4.19.
Text (apostrophe)	'	** unsigned integers from hex 20 through 7F on the ASCII chart		5.4.20.
Attributes:				
Set Marker Symbol	S	1 unsigned integer	Period	5.4.21.
Set Line Style	LS	1 unsigned integer	Solid	5.4.22.
Set Hatch Index	PH	1 unsigned integer	45° diag.	5.4.23.
Set Polygon Interior Style	PI	1 unsigned integer	45° diag.	5.4.24.
Set Character Path	CP	1 unsigned integer	Right	5.4.25.
Set Character Justification	CJ	2 unsigned integers	Left, bottom	5.4.26.
Set Character Size	CZ	2 unsigned integers	128, 128	5.4.27.
	LW	(Reserved for future use)		
	SZ	(Reserved for future use)		

*One ordered X,Y pair for each point

**One for each text character

Glossary

The terms listed in this glossary are defined as they apply to data communications, particularly to the UTS 30 single stations, their peripherals, and their communications protocol.

A

ABA

American Banking Association. In this application, refers to a format standard for magnetic data on plastic cards.

accessing

Data or control-signal transfer from the terminal to an input/output device (peripheral or host processor).

acknowledge

Refers to the communications control sequence DLE 1 used by both the host processor and the display terminal to acknowledge the correct reception of a message.

addressable location

A place on the screen at which the cursor may be positioned by designating (in hexadecimal code) the vertical and horizontal coordinates (column and row, respectively).

addressing

A communications protocol method of identifying a communications line and a specific terminal system at that location. Also, the same method used to identify a specific peripheral device associated with the addressed terminal system.

ASCII

American Standard Code for Information Interchange. This standard code is used extensively for data transmission. Each character is encoded as a 7-bit binary number, allowing the use of 96 uppercase and lowercase letters, numbers, and punctuation marks while maintaining room for 32 special function control codes.

B

bit

Contraction of "binary digit;" the smallest quantity of digital information that can be stored. A bit is either a binary 1 or 0.

bps

Bits per second.

buffer

A place, usually in RAM, or function for the temporary holding of data. Also, a device (or software routine) used to compensate for a difference in rate of data flow, or in timing of events, when data is being transmitted from one device to another.

byte

A set of eight contiguous bits that is operated on as a unit. Communication is byte-oriented, using seven ASCII bits to define a character and adding one parity bit. A byte can also be a subset of a computer word.

C

cascading

The technique of expanding the number of terminal systems at one communications interface point by connecting a terminal multiplexer to a terminal port of the primary multiplexer and then connecting single terminals to the cascaded multiplexer.

cathode-ray tube

The element used as a display screen in a display terminal, abbreviated CRT.

changed-field indicator

An internal marker (bit) that is set in an FCC field whenever data is entered initially or existing data is changed. This marker identifies the field as changed and allows the transmission of changed fields only.

character

A series of 1 and 0 bits of fixed length and pattern. Specific bit patterns are assigned unique meanings.

character protection

The terminal function that prohibits the operator from altering or destroying data already in memory. More specifically, the term refers to the way in which the UNISCOPE mode system control software provides character protection through the FCC and SO/SI codes.

character set

A portion of memory that determines how the CRT hardware will form a character or characters on the screen.

code

A system of symbols that a computer can understand for representing data or instructions. Code can be in the form of alphanumeric characters (e.g., hexadecimal code) or binary data.

command mode

A UNISCOPE operating system function for file management, system configuration, and control of operating characteristics.

communications control procedures

The means used to control the orderly communication of information between data communications terminals and a host processor or another terminal over a data communications link. (Also called protocol, line protocol, or communications line protocol.)

communications control sequences

A sequence of characters used by the host processor and the terminal to define specific elements of line protocol. For example, a no-traffic indication is provided by the code sequence EOT EOT.

communications line

The physical connection between hardware units. Examples are coaxial cable or telephone lines. Different kinds of lines can send and receive signals differently. See also *full-duplex*, *half-duplex*, *simplex*, and *switched line*.

compatibility

The quality that enables hardware and software to be used together in different computer systems.

configuration

The hardware and software elements that together make up a functional system. Also, the process of making physical connections between hardware units plus assigning communications lines and addresses to all the components of a system.

control character

A character used in a control code.

control code

A character, or sequence of characters, used to initiate, modify, or stop a control operation (for instance, the ESC y sequence, which orders line duplication).

control page

A 2-line display that is shown on the screen to provide the operator with a means of specifying or changing operating parameters and controlling data transfer.

CRT

See *cathode-ray tube*.

cursor

A symbol (▣) used to mark the position of the next character to be entered into a screen display. Also, marks the last character of a message transmitted to a host processor or a peripheral device.

D

DCM

See *direct connection module*.

default

A predetermined alternative selected by the system control software, in lieu of a choice made by the operator, to define a functional characteristic.

DID

Device identifier. A transmission code assigned to a peripheral device to identify it for the terminal, controller, or host. This is the third level of host processor addressing (RID, SID, and DID).

direct connection

A communications line interface that can be used instead of a modem or DCM, if the terminal is located no more than 200 feet from the host processor.

direct connection module

A SPERRY modem replacement connecting a terminal directly to a host processor.

disable

To prevent a function or device from performing an operation.

diskette

A flexible, circular mass storage device.

display

The visual presentation of information either being prepared for entry into processor storage or retrieved from processor storage.

downline load

In a downline load, the files containing a user program or user-generated character set are sent down the communications lines from the host processor or cluster controller and placed in terminal random-access (RAM) memory.

dump

To transfer all or part of the contents of a memory into another storage area, or to output the contents of a memory to a printer or diskette. Usually done for error analysis.

duplex

See *full-duplex*.

E

EIA

Electronic Industries Association.

emphasis characters

Special effects that can occupy a screen position concurrently with the usually displayed characters. Some are created by FCC codes (e.g., reverse video, high intensity); others are special emphasis characters such as the underscore character.

enable

To make it possible for a device or function to carry out an operation, as in enabling or activating an FCC.

EPROM

Erasable programmable read-only memory. Information is stored semipermanently and read without alteration, but the bit patterns may be erased either electrically or by ultraviolet light and the area can be reprogrammed.

execution

The performance of a series of prescribed steps or routines, as in the execution of a user program.

expanded FCCs

Also called extended FCCs. An enlarged set of field control characters available to the UTS 40 and UTS 30 terminals. Expanded FCCs are translated to primary FCCs before transmission to the host unless a special command is entered in the control page.

F**FCC**

See *field control character*.

FCC sequence with cursor positioning

A control code sequence used by the host processor or the terminal to identify the position of the FCC. The code sequence contains row and column locations to position the FCC independently of the cursor location.

field

An addressable segment of the display screen designated for a particular purpose. It may have FCC characters associated with it.

field control character

A code sent from the keyboard or from the host and used to define display characteristics in operator-specified regions of the display screen.

file

A group of related data blocks (on diskette) which may be accessed by a single name.

firmware

A program permanently resident in ROM that provides basic machine instructions through the use of microprogramming techniques.

full-duplex

A mode of transmission in which communication takes place in two directions simultaneously, each direction independent of the other.

G

general poll

A poll containing a general RID, general SID, and general DID or a poll containing a specific RID, general SID, and general DID. All stations in a poll group are candidates to furnish a response to a general poll.

GID

General identifier. A transmission code consisting of a general RID, general SID, and general DID. All stations in a poll group are addressed by a GID.

H

half-duplex

A mode of transmission in which communication takes place in one direction at a time.

handler

A software routine to control input and output between the components of the processor and terminals or other communication devices.

hardware

Computer and data processing equipment and electronic devices.

host or host processor

The data processing system controlling the communication environment in which the terminal operates. See also *processor*.

I

IATA

International Air Transport Association. In this application, a format standard for magnetic data on plastic cards used in the magnetic stripe reader (MSR).

immediate FCC sequence

A control code sequence used by the host processor to define an FCC location at the current position of the cursor.

indicator line

The 25th row of the display screen, where various messages concerning the terminal and its associated peripherals appear on a reverse-video background.

interactive

The process of communication between two stations in which each station responds alternately to procedural formalities. (Also called "conversational.")

interface

Points of interconnection between two units having different functions.

I/O

Input and output.

L

list

To print or otherwise produce a permanent representation of data.

loadable character set utility

A software feature that allows the user to create or modify a set of characters for each terminal or number of terminals.

logic flow trace

A line-by-line display of the UTS COBOL program currently being executed on the terminal.

M

microcode

A set of control functions performed by instruction decoding and execution logic of a computer. Microcode is not generally accessible to the customer or user programmer.

mnemonic

An acronym or abbreviation used to help remember something. The 2-character codes entered into subfields on the control page are such mnemonics.

modem

Contraction of modulator-demodulator. A device that modulates and demodulates signals transmitted over telephone lines.

multidrop

A communication link where two or more data communication stations share a communication line by means of a separate DCM or modem for each connection.

multiplexer

A unit used to connect multiple terminal stations with the host processor, using a single communications line.

multipoint

A communications link connecting three or more data communications stations in a network.

N

nonvolatile RAM

Random-access memory that retains data when power is removed.

O

offline

Terminal system activity performed without access to a host processor or communications line.

Also, SPERRY cluster controller activity that excludes all but one terminal (the master workstation) from system activity.

online

Terminal system activity performed between two or more terminals, or between terminals and host processor linked on a communications line or joined in a direct communications link, or between terminals and an associated SPERRY cluster controller.

optional character set

A set of characters stored in the optional character set memory on the UTS 30. They may have been created or modified through the loadable character set utility, or may be downline loaded from the host. They are brought to the screen using the FCTN and ; (semicolon) keys.

optional character set memory

Random access memory space in the terminal where optional characters are temporarily stored.

P

parameter

Variable functional characteristic of a terminal. (Examples are the uppercase range and the video-off timer.)

parity bit

An element added to the basic message or character for checking correctness of data transmission.

peripheral device

A device that operates from a terminal system and need not be under continuous control of the host processor, but may depend on the terminal for overall control. Principally refers to printer and storage devices.

peripheral interface

Interfaces in the terminal designed for printers and diskettes.

POC

See *power-on confidence test*.

point-to-point

A data communications link connecting only two data communications stations.

poll

A communications protocol technique for inviting a data communications terminal to transmit status or messages.

poll loop

All stations on the communications line that recognize the RID and SID of a poll message.

power-on confidence test

A series of internal diagnostic tests that examine crucial elements in terminal operating hardware.

processor

A device or group of devices, using supporting software, capable of executing a systematic sequence of operations upon data.

program

A complete sequence of computer instructions used to solve a problem, perform an action, or respond to external stimuli in a prescribed manner. As a verb, to develop a program.

program cartridge

A module containing read-only memory (ROM) that defines the functional characteristics (system control software) of the terminal.

program product

A SPERRY software package.

programmable

Capable of accepting and operating a variety of programs.

protected character

See *character protection*.

protected field

A field defined by FCCs to prevent entry or change by normal keyboard use. Data in such a field is called protected data.

protocol

A set of conventions between communicating processes. Protocol defines message format, message content, and speed. See also *communications control procedures*.

R

RAM

Random-access memory. Memory that can be written to or read from without sequentially accessing any memory locations located before the addressed locations.

real time

A computation or other data processing sequence that occurs during the actual time the related process is occurring so that the results are available for modifying or guiding the addressed locations.

refresh rate

The number of times per second that the screen's dot matrix pattern for character generation is repainted to eliminate flicker in the display.

reverse video

A screen display option in which the background is lighter than the characters.

RID

Remote identifier. A transmission code assigned to the location of a terminal or number of terminals. RID is the first level of host processor addressing (RID, SID, and DID).

right-justification

In this application, an FCC function that allows character entry on the display from the right side to the left.

ROM

Read-only memory. Memory that is preprogrammed and cannot be altered by normal terminal use.

S**second screen**

A SPERRY terminal feature that allows UTS 30 and UTS 40 terminals to perform two operations simultaneously. The terminal contains two screens, each separately addressable and separately displayable. Each screen has its own control page and indicator line. If the operator is using one screen, the host may use the second screen for a host-initiated operation without interrupting operator use. Similarly, the operator may set up a peripheral operation on one screen and switch to the second screen to perform another operation.

sector

A portion of a track on a diskette.

selection

The sequence by which a particular peripheral device attached to an interface is designated as the source or the destination of data.

SID

Station identifier. A transmission code assigned to an individual terminal (or to each screen, if the terminal has both display screen and second screen). This is the second level of host processor addressing (RID, SID, and DID).

simplex

A communication circuit limited to 1-way transmission.

software

The control systems, programs, and routines used in the operation of data processing systems, such as assemblers, compilers, and handlers.

SOE

See *start-of-entry character*.

SO/SI

The shift-out (SO) and shift-in (SI) control codes. SO is a control character used by the host to mark the beginning of a protected field. The SO character indicates that the code combinations that follow are to be interpreted as outside the standard code table until an SI character is reached. The SI character is used by the host to mark the end of the protected field. Codes that follow the SI character are interpreted according to the standard code table. (Note that FCCs also provide character protection.)

special emphasis characters

Nondestructive display characters that can occupy a single screen position with a standard character. Examples are the underscore and the column separator.

start-of-entry character

A character that defines the beginning position of data to be sent to the host processor or peripheral device. The SOE (▶) allows the operator to send a block of data that does not begin at home position.

status

The condition of a communications line (e.g., receive, transmit) or the poll response of a peripheral device (e.g., busy).

storage

A device into which data can be entered, held, and retrieved at a later time. Loosely, any device that can store data.

switched line

A type of communication that requires the dialing of a telephone number each time communication is established between the terminal and the host processor. Also called dialed line or dial-up communications.

synchronous

A method of timing or pacing data transmission by equally spaced clock signals or current pulses.

system control software

Codes that control the basic operating characteristics of a terminal. Examples are UNISCOPE mode and CP/M Plus™.

T**track**

A circular information recording path on a diskette.

transfer

To convey data between a terminal and one of its peripheral devices via a peripheral interface.

transmission

See *transmit*.

transmit

To convey data and procedural messages between a host processor and a remote terminal across a communications line.

U

unprotected field

A field available for entry by normal keyboard usage. Usually, used to distinguish an unprotected field from a protected field. Data in this type of field is called unprotected. See also *protected field*.

utility

A SPERRY program product designed to work under a specific system control software.

W

word

A set of binary bits handled by a computer as the primary unit of information. The length of a computer word is determined by the hardware design. Typically, each system memory location contains one word.

Index

Term	Reference	Page	Term	Reference	Page
0797 printer	1.3.	1-2			
0798 printer	1.3.	1-2			
8439 diskette subsystem	1.1.	1-1			
See also <i>diskette subsystem</i> .					
A			C		
ABA coding	C.4.1.	C-2	Call control page	4.3.4.	4-4
Acknowledgment	3.4.3.3.	3-10	Call error log	4.3.1.	4-4
Acknowledgment/busy response	3.11.2.	3-61	Carriage return	4.5.2.4.	4-19
Acknowledgment/busy-plus-traffic response	3.11.1.	3-60	See also <i>cursor return</i> .		
Address code assignments	Figure 3-1	3-4	Changing parameters		
Address field	J.2.1.	J-1	through configurator utility	2.3.	2-3
Address selection	3.2.1.	3-3	through control page	2.2.	2-3
Addressing	3.2.	3-2	Character justification	5.4.26.	5-12
Adjusting screen display	2.1.7.	2-3	Character parity	3.3.1.	3-5
ADR- field	J.2.1.	J-1	Character path	5.4.25.	5-11
Alarm	2.1.2.	2-2	Character set generator utility	1.10.2.	1-3
with POC test	2.1.1.	2-1	Character set memory	1.8.	1-3
Alternate screen	1.7.	1-2	Character size	5.4.27.	5-13
Arc	5.4.18.	5-8	Character strings	5.5.2.	5-13
ASCII	2.6.1.	2-5	Circle	5.4.17.	5-8
code conversion	Figure B-1	B-2	Clear changed fields	4.4.2.3.3.	4-12
Audible alarm			Clear error log	4.3.2.	4-4
See <i>alarm</i> .			Clear nonvolatile RAM	2.1.7.	2-3
			Communication handler	F	F-1
			COMMUNICATION PARAMETER INVALID		
			message	2.1.1.	2-2
				2.1.1.1.	2-2
			Communications control sequences	A.3.	A-7
			Communications line		
			disconnecting	3.10.	3-59
			error recovery	3.7.1.	3-20
			Communications protocol	3.1.	3-1
				3.5.	3-12
			Communications rules	3.1.	3-1
				3.5.1.	3-12
			Configurator utility	2.3.	2-3
Blank space	4.4.6.1.	4-17	Configuring peripheral devices	J.4.	J-10
Blinking end marker	4.4.6.5.	4-17	Configuring the system	2.3.	2-3
Blinking start marker	4.4.6.4.	4-17	Contention	3.8.16.	3-57
Block check character	3.3.2.	3-5	Control characters	2.4.	2-4
Block parity	3.3.2.	3-5	displaying	4.4.6.6.	4-18
Busy condition, example	3.8.1.4.	3-53			
Busy-plus-traffic response	3.11.1.	3-60			

Term	Reference	Page	Term	Reference	Page
F			H		
F1 through F22 keys	2.5.	2-4	Hatch index	5.4.23.	5-10
FCC codes	Table B-4	B-5	Host data transmission	2.2.	2-3
FCC sequences			Host interface	1.2.	1-1
immediate	4.4.2.3.2.	4-11	Host processor		
with cursor positioning	4.4.2.3.1.	4-11	message sequence	3.1.2.	3-2
Field control characters	2.4.	2-4	programming	3.11.	3-60
	4.4.2.	4-8	rules	A.2.	A-4
clear	4.4.2.3.4.	4-12	basic communications	3.5.1.	3-12
codes	4.4.2.3.	4-11	line error recovery	3.7.1.	3-20
	Table B-4	B-5	multiplexer function	3.6.1.	3-16
	K.2.	K-2	peripheral communications	3.8.4.	3-39
expanded	4.4.2.2.	4-10	transmission	2.6.1.	2-5
	K.3.	K-5			
generating	K.1.	K-1	I		
primary	4.4.2.1.	4-8	IATA coding	C.4.2.	C-5
translating	Table K-6	K-5	Initialize graphics	5.4.1.	5-3
File maintenance			Initialize view surface	5.4.2.	5-3
diskette file utility	1.10.5.	1-4	Initiate power-on confidence test	4.3.3.	4-4
File transfer utility	1.10.4.	1-4	Insert in display	4.4.5.9.	4-16
Form feed	4.5.2.2.	4-19	Insert in line	4.4.5.8.	4-16
	4.5.3.	4-19	Insert line	4.4.5.10.	4-16
control character	2.4.	2-4	Integers		
Format codes			signed	5.5.4.	5-14
text message	B.2.	B-3	unsigned	5.5.3.	5-14
Format of operands, graphics	5.5.	5-13	Intensity display	D.3.	D-2
G			Interfaces		
General identifier	3.2.	3-2	diskette controller	1.4.	1-2
General poll			host	1.2.	1-1
definition	3.2.2.	3-3	printer	1.3.	1-2
Graphics	N	N-1	K		
commands	5.2.2.	5-2	Keyboard lock	4.3.5.	4-5
	5.4.	5-3	Keylock status	D.2.	D-1
	Table N-2	N-2			
host commands	5.3.	5-2			
	Table N-1	N-1			
GRAPHICS INOPERATIVE message	2.1.1.	2-2			
Graphics message format	5.2.	5-1			
Graphics protocol string	5.2.1.	5-1			
errors	5.2.3.	5-2			

Term	Reference	Page	Term	Reference	Page
L					
Line duplication	4.4.5.11.	4-16	Messages		
Line error message sequence			host to UTS 30	3.4.2.	3-8
examples	3.7.2.	3-21	UTS 30 to host	3.4.3.	3-9
errors during recovery	3.7.6.	3-34	MM field	J.2.5.	J-4
host processor text	3.7.4.	3-25	Model 25B printer	1.3.	1-2
passing the acknowledgment	3.7.5.	3-30	Model 31 printer	1.3.	1-2
polls	3.7.2.	3-21	Modem	1.11.1.	1-4
UTS 30 text	3.7.3.	3-22		1.11.2.	1-4
Line error recovery	3.11.3.	3-62	Move absolute	5.4.7.	5-5
rules	3.7.1.	3-20	Move relative	5.4.8.	5-5
Line errors			MSG WAIT key	2.5.	2-4
during selection poll message	3.8.6.	3-41	Multiplexer function	3.6.	3-15
Line feed	4.5.2.1.	4-19	examples	3.6.2.	3-17
control character	2.4.	2-4	rules	3.6.1.	3-16
Line monitor	E	E-1	Multipoint configurations	1.11.1.	1-4
	2.1.4.	2-2		Figure 1-1	1-6
display	E.2.	E-1	N		
operation	E.1.	E-1	National alphabet selection	Figure B-2	B-3
Line style	5.4.22.	5-10	NDCs		
Load optional character set			See <i>normalized device coordinates</i> .		
to diskette	4.3.8.	4-5	New frame	5.4.5.	5-4
to UTS 30	4.3.6.	4-5	No traffic	3.4.3.2.	3-10
Lock keyboard	4.3.5.	4-5	Normalized device coordinates	5.5.5.	5-14
Longitudinal redundancy check			NUL requirements	Table 4-1	4-3
ABA format	C.4.1.4.	C-4		G.1.	G-1
IATA format	C.4.2.4.	C-7	NUL time fill	4.2.4.	4-3
Loopback diagnostic test	2.1.6.	2-3	O		
M					
Magnetic stripe reader	C	C-1	Operands, graphics	5.5.	5-13
format	C.4.	C-2	Operating characteristics	J.3.	J-5
input	C.2.	C-1	See also <i>parameters</i> .		
operation	C.3.	C-2	Optional character set		
Maintenance	2.1.7.	2-3	defining dot matrix	L.1.	L-1
Maintenance mode field	J.2.5.	J-4	loading		
Marker symbol	5.4.21.	5-10	to diskette	4.3.8.	4-5
Message envelope	3.4.2.1.	3-8	to UTS 30	4.3.6.	4-5
Message formats	3.4.	3-7		L.2.	L-3
Message priorities	3.9.1.	3-57	memory	1.8.	1-3
Message routing	2.6.2.	2-5	request ID	4.3.7.	4-5
Message waiting	3.4.2.2.	3-8	using	L.3.	L-5
example	3.8.10.	3-46	with generator utility	1.10.2.	1-3
with sustained busy condition	3.8.13.	3-50	Other publications	Preface	

Term	Reference	Page	Term	Reference	Page
P					
PAQ					
<i>See peripheral access queue.</i>					
PARAM field	J.3.	J-5	Polyline absolute	5.4.11.	5-6
Parameter field	J.3.	J-5	Polyline relative	5.4.12.	5-6
Parameter options	Table J-3	J-6	Polymarker absolute	5.4.9.	5-5
Parameter options display	Figure J-2	J-5	Polymarker relative	5.4.10.	5-6
Parameter/configurator utility			Power-on confidence test	2.1.1.	2-1
<i>See configurator utility.</i>			initiate	4.3.3.	4-4
Parameters			Print	4.5.1.4.	4-18
changing through configurator utility	2.3.	2-3	(**PRINT*) field	J.5.1.	J-11
default	H	H-1	Print form	4.5.1.5.	4-19
changing through control page	2.2.	2-3	Print transparent	4.5.1.6.	4-19
	J.3.	J-5	Printer control codes	4.5.2.	4-19
PARAMETERS DEFAULTED message	2.1.1.	2-2	Printer interface	1.3.	1-2
	2.1.1.1.	2-2	Printer status codes	Table J-1	J-2
Parity bit	3.3.1.	3-5	Printers	1.3.	1-2
Parity checking	3.3.	3-5	configuring through control page	J.4.	J-10
Partial message	5.3.5.	5-2	PRNT() field	J.5.2.1.	J-12
Passing the acknowledgment	3.8.14.	3-53	Program attention keys	2.5.	2-4
in TEXT/SD/PI messages	3.11.2.	3-61	as traffic	3.4.3.4.2.	3-11
Peripheral access queue	3.8.1.	3-36	example	3.9.2.	3-58
status	3.8.2.	3-37	Program attention key codes	B.6.	B-8
Peripheral addressing	3.2.	3-2		Table B-10	B-8
Peripheral communication	3.8.4.	3-38	programmable UTS 30	Table B-11	B-9
Peripheral control codes	4.5.	4-18	Program cartridge	1.1.	1-1
	Table B-9	B-7	PROGRAM LOAD FAILURE message	2.1.1.	2-2
	B.5.	B-7		2.1.1.2.	2-2
initiation	4.5.1.	4-18	Program loading	2.1.1.	2-1
printer	4.5.2.	4-19	programmable UTS 30	D.5.	D-3
Peripheral devices, configuring	J.4.	J-10	Program products	1.10.	1-3
Peripheral interface	1.7.	1-2	Programming the host processor	3.11.	3-60
diskette	1.4.	1-2			
printer	1.3.	1-2	R		
Peripheral operations	3.8.	3-36	READY message	2.1.1.	2-1
format of	J.5.2.	J-12	Rectangle absolute	5.4.15.	5-7
specifying	J.5.	J-11	Rectangle relative	5.4.16.	5-8
Peripheral status codes	Table J-1	J-2	Release level	D.4.	D-2
Peripheral-selection-delayed message sequence	3.8.11.	3-48	Remote identifier	2.6.2.	2-5
POC test	D	D-1		3.2.	3-2
<i>See also power-on confidence test.</i>			Reply request	3.4.3.1.	3-9
Point-to-point configurations	1.11.1.	1-4	Request character set ID	4.3.7.	4-5
	Figure 1-1	1-5	Request cursor address	4.4.1.3.	4-7
Poll groups	3.2.2.	3-3	RESET PUSH button	2.1.1.2.	2-2
Poll message	3.4.1.	3-7	Retransmission request	3.4.1.4.	3-8
Poll/response message sequence	3.1.1.	3-1	example	3.8.15.	3-54
Polls, types of	3.4.1.	3-7	RID	2.6.2.	2-5
Polygon absolute	5.4.13.	5-7		3.2.	3-2
Polygon interior style	5.4.24.	5-11	RS-232 asynchronous interface	1.3.	1-2
Polygon relative	5.4.14.	5-7	RS-232-C interface	1.2.	1-1
			Run POC test and load	2.1.7.	2-3

Term	Reference	Page	Term	Reference	Page
S					
SA 400 interface	1.4.	1-2	Special emphasis codes		
Scan down	4.4.1.8.	4-7	ASCII characters	Table B-6	B-5
Scan left	4.4.1.6.	4-7	multiple	4.4.4.4.	4-15
Scan right	4.4.1.7.	4-7	Specific poll	3.2.2.	3-3
Scan up	4.4.1.5.	4-7	Specifying peripheral operations	J.5.	J-11
Screen, alternate	1.7.	1-2	Specifying transmission to host		
Screen buffer	1.6.	1-2	through control page	2.2.	2-3
Screen bypass			STA- field	J.2.3.	J-2
See <i>alternate screen</i> .			Start-of-entry	4.2.2.	4-2
Screen control	2.4.	2-4	Start-of-entry control code	4.4.6.2.	4-17
	4.4.	4-5	Start-of-entry symbol	2.4.	2-4
Screen control codes	B.4.	B-4	Station addressing	3.2.	3-2
Screen display adjustment	2.1.7.	2-3	Station identifier	2.6.2.	2-5
Screen format	2.4.	2-4		3.2.	3-2
Screen size	1.6.	1-2	Status as traffic	3.4.3.4.3.	3-11
Search	4.5.2.5.	4-19	Status codes	Table 3-1	3-11
SEARCH field	J.2.2.	J-1	peripheral	Table J-1	J-2
Second screen			Status field	J.2.3.	J-2
See <i>alternate screen</i> .			Status poll	3.4.1.1.	3-7
Sector	5.4.19.	5-9	Sustained-busy condition		
Select view surface	5.4.3.	5-4	example	3.8.12.	3-49
Selection poll	3.4.1.3.	3-8	in message-queued sequence	3.8.13.	3-50
Selection poll message sequence			Synchronous idle	A.4.	A-8
example	3.8.5.	3-40	System configuration	Figure 1-1	1-5
line errors	3.8.6.	3-41		Figure 1-2	1-7
Send graphics to printer	5.3.6.	5-3		1.11.1.	1-4
Sequential file format	1.5.	1-2	System control software		
Set character justification	5.4.26.	5-12	CP/M Plus	1.1.	1-1
Set character path	5.4.25.	5-11	SPERRYLINK Office System	1.1.	1-1
Set character size	5.4.27.	5-13	UNISCOPE mode	1.1.	1-1
Set hatch index	5.4.23.	5-10	System diskette	1.1.	1-1
Set line style	5.4.22.	5-10			
Set marker symbol	5.4.21.	5-10	T		
Set polygon interior style	5.4.24.	5-11	Tab backward	4.4.5.14.	4-17
SID	2.6.2.	2-5	Tab forward	4.4.5.12.	4-17
	3.2.	3-2	Tab stop		
Signed integers	5.5.4.	5-14	control code	4.4.5.13.	4-17
SO/SI protection	2.4.	2-4	FCC	4.4.2.3.5.	4-12
SO/SI-protected characters	4.4.3.	4-12	Terminal addressing	2.6.2.	2-5
alone	4.4.3.1.	4-12	Terminal control codes	4.3.	4-4
with FCCs	4.4.3.2.	4-13		B.3.	B-4
Special code field	J.2.4.	J-3	Terminal multiplexer	1.11.1.	1-4
Special emphasis characters	2.4.	2-4		1.11.4.	1-7
control codes	4.4.4.	4-14	terminals used with	1.11.4.	1-7
	Table B-5	B-5	Terminal parameters		
add	4.4.4.2.	4-15	entering or changing	2.2.	2-3
create or replace	4.4.4.1.	4-14	Terminals	1.1.	1-1
delete	4.4.4.3.	4-15		F.2.	F-2

PLEASE SEND US YOUR COMMENTS!

We feel that this manual is an essential part of our equipment. We want to be sure it is the best, most usable manual possible. Your comments will help us achieve this goal. When you have become familiar with the manual, please fill in the other side of this form and mail the form to us. Your reply will be carefully reviewed by the persons responsible for writing and publishing this manual.

FOLD

FIRST CLASS
PERMIT NO. 2540
SALT LAKE CITY,
UTAH

BUSINESS REPLY MAIL NO POSTAGE STAMP NECESSARY IF MAILED IN THE UNITED STATES

POSTAGE WILL BE PAID BY



SPERRY

322 NORTH 2200 WEST
SALT LAKE CITY, UTAH 84116

ATTN: MANAGER, GSD PUBLICATIONS

FOLD

NOTE:

Requests for copies of this manual and other Sperry publications and for assistance in getting the most use out of your Sperry equipment should be directed to your local Sperry representative.

READER'S COMMENT SHEET

Your comments on this manual will help us improve it. Please fill in the requested information.

Name of manual: _____

Manual number: UP-_____ revision number _____, including update numbers _____

Name of your company: _____

Address of company: _____

What is your position? _____

Your level of experience: Professional _____ Knowledgeable _____ Novice _____

With what system is the equipment used? _____

How do you use this manual?

As a reference source

As a self-instructional text

As a classroom text

As _____

Please rate this manual

As a reference source: Good Adequate Not adequate

As a text: Good Adequate Not adequate

For other uses: Good Adequate Not adequate

Add your specific comments. Give page and paragraph references where appropriate.

Thank you for your cooperation.