

FeelTech

FY6600 Series Fully Numerical Control
Dual Channel Function/Arbitrary Waveform Generator

User's Manual

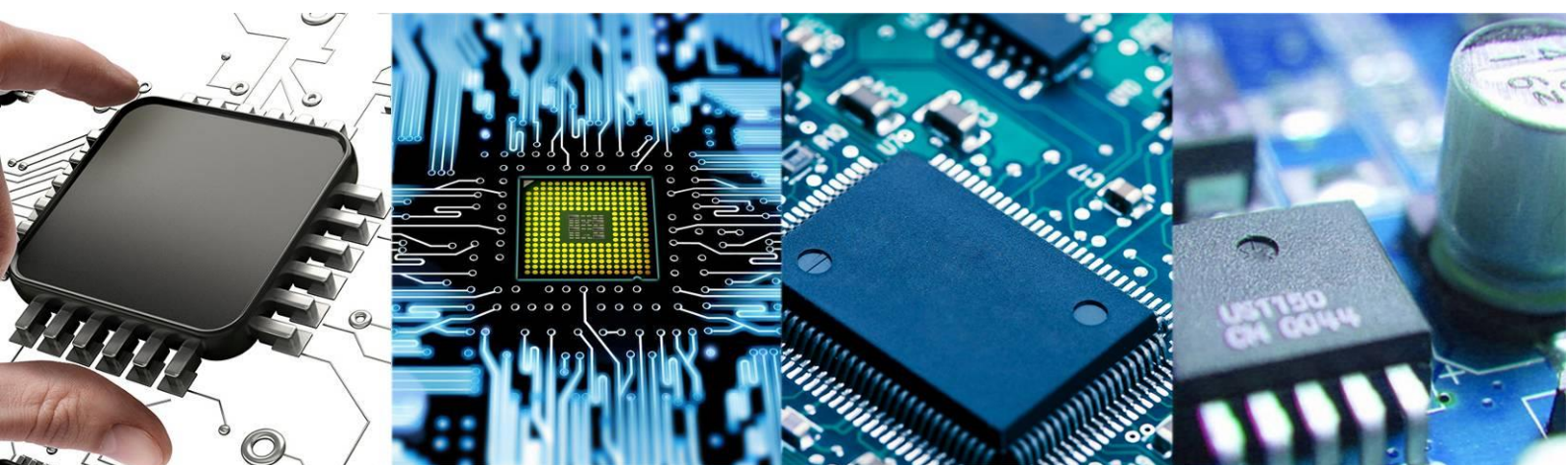

Rev2. 2

July, 2017

Guaranty and Declaration

Copyright

© 2017 FeelTech Technology Co. Ltd. All Rights Reserved.

Trademark Information

FeelTech is a registered trademark of FeelTech Technology Co. Ltd.

Declaration

FeelTech reserves the right to modify or change parts of or all the specifications and pricing policies at company's sole decision.

Information in this publication replaces all previously corresponding material.

FeelTech shall not be liable for losses caused by either incidental or consequential in connection with the furnishing, use or performance of this manual as well as any information contained.

Any part of this document is forbidden to be copied or photocopied or rearranged without prior written approval of **FeelTech**.

Contact Us

If you have any problem or requirement when using our products or this manual, please contact **FeelTech**.

Tel: 0086 371 68997005 E-mail: feeltech@126.com

Website: www.feeltech.net

Contents

Guaranty and Declaration	1
Product Introduction	1
Quick Start	5
General Inspection.....	5
Front Panel Overview	6
Back Panel Overview.....	9
Power On and Inspection	11
User Interface	12
Appearance and Dimensions.....	14
Front Panel Operations	15
Waveform Output.....	15
Select Output Channel	15
Select Waveform	16
Set Frequency	17
Set Amplitude	18
Set Offset.....	19
Set Duty Cycle (Square)&Set pulse wave pulse width (Adj-Pulse)	20
Set Phase.....	21
Enable Output	22
Example: Output Sine Waveform	23
Burst	25
Frequency Meter/Counter	27
Enable the Counter	27
Set the Counter	28
Sweep.....	29
Sweep Object	29
Sweep Start Position	30
Sweep End Position	31
Sweep Time.....	32
VCO (Voltage Control Output) Sweep	32
Sweep Type.....	33
Enable Sweep Function	34
System Configuration and Auxiliary Functions.....	35
Save and Load	36
Configuration	37
Uplink.....	38
Synchronization.....	39
Troubleshooting	40
Technical Specification	41
Appendix	45

Product Introduction

This manual applies to each model of FY6600 series Function/Arbitrary Waveform Signal Generator. The last three characters of the model indicate the up limit output of Sine Wave (MHz). For example, the “**60M**” of the Model Number “**FY6600-60M**” indicates the Sine wave maximum output frequency is up to 60MHz.

FY6600 series Dual Channel Function/Arbitrary Waveform Generator is a multifunctional signal generator product integrating Function Signal Generator, Arbitrary Waveform Generator, Pulse Signal Generator, Noise Signal Generator, Counter and Frequency Meter with excellent cost performance. This instrument adopts large scale CMOS integrated circuit and high speed MCU microprocessor. The internal circuit uses SPXO as the basic standard to guarantee the stability of signals. Surface mounting technology improves interference immunity and operational life span.

This instrument has double channels can output 31 presetted DDS signals including Sine, Square, Triangle(Ramp), Rise Sawtooth, Fall Sawtooth, Lorenz Pulse, Multitone, Noise, Cardiogram, Trapezoidal Pulse, Sinc Pulse, Narrow Pulse, Gauss White Noise, AM, FM, Step and 64 group user-defined waveform. It can also output TTL electric level. Both channels are completely independent.

It has friendly human-machine mutual interface. 2.4 inch TFT Color LCD with 320×240 resolution can display all the parameters of both channels and current functions of all buttons . Shortcut keys simplify all complicated operations and save time. Users can be proficient after several minutes practice.

The advantages of this instrument in signal generating, waveform sweeping, parameter measurement and other fields, make it to be the ideal equipment for electronic engineers, laboratories, industry producing line, university, R&D institutes and so on.

Main Features:

- ◆ Adopt DDS technology to generate accurate, stable signal with low distortion.
- ◆ Adopt ABS plastic shell with table type design. Use 100-240V (AC) wide range voltage power supply.
- ◆ 2.4 inch TFT Color LCD with 320 × 240 resolution can display all the parameters of both channels and current functions of all buttons .
- ◆ Frequency output of Sine wave can be up to 60MHz. 250MSa/s sampling rate. 14 bits vertical resolution.
- ◆ Use the process, long press the parameter adjustment knob (OK button), you can quickly save the instrument output parameters, the next boot, automatically load the saved parameters.
- ◆ Complete independent dual channels can work at same time and phase difference is adjustable.
- ◆ Following function allows users to synchronize all or partial parameters of CH2 to CH1.
- ◆ Two instruments or more can be synchronized by SYNC interface.
- ◆ Various Waveform:
 - Sine
 - Square
 - Triangle/Ramp
 - Rise Sawtooth
 - Fall Sawtooth
 - Lorenz Pulse
 - Multitone
 - Noise
 - Electrocardiogram (ECG)
 - Trapezoidal Pulse
 - Sinc Pulse
 - Narrow Pulse
 - Gauss White Noise
 - Step Triangle
 - Positive Step
 - Inverse Step
 - Positive Exponent
 - Inverse Exponent
 - Positive Falling Exponent
 - Inverse Falling Exponent
 - Positive Logarithm
 - Inverse Logarithm
 - Positive Falling Logarithm
 - Inverse Falling Logarithm
 - Linear FM
 - AM
 - FM
 - Positive Half Wave
 - Negative Half Wave
 - User-defined waveform

- ◆ It has 64 positions for saving user-defined waveform. Waveform Length of each one is $8192 * 14$ bits.
- ◆ High frequency precision up to 10^{-6} orders of magnitude.
- ◆ Full range of $1\mu\text{Hz}$ (0.000001Hz) frequency resolution.
- ◆ Minimum amplitude resolution can be up to 1 mV (0.001V) .
- ◆ $-10\text{V}\sim+10\text{V}$ DC Offset function ($<20\text{MHz}$) . Resolution 1mV .
- ◆ Duty cycle of each channel can be adjusted separately. Precision can be 0.1% .
- ◆ Pulse wave pulse width and pulse frequency can be adjusted continuously, the range of adjustment is $20\text{ns}\text{-}1\text{S}$. The pulse amplitude can be continuously adjusted between $0\text{-}10\text{V}$, adjustment accuracy of 0.001V .
- ◆ Phase of two channels adjustable during $0\sim359.9^\circ$. Accuracy can be 0.1° .
- ◆ Direct digital Setting covering full range of frequency without grading.
- ◆ Sweep Function: It can sweep 4 properties of signals including frequency, amplitude, offset and duty cycle. It has Linear and Logarithm two sweep types. Sweep time can be up to 999.99S . Sweep starting point and end point can be set arbitrarily.
- ◆ It has pulse train burst output function. There has Manual Trigger, internal CH2 Trigger, and External Trigger for your options. It can output $1\sim1048575$ pulse trains.
- ◆ Digital signal output function can output any $0\sim10\text{V}$ CMOS electric level.
- ◆ VCO voltage controls parameters of signal output available (for example: voltage controlled oscillator).
- ◆ Save function: It can save 20 sets user-set parameters and can be loaded at anytime.
- ◆ 100M Frequency meter function: It can measure frequency, period, pulse width and duty cycle. Max. frequency workable is 100MHz and Min. frequency workable is 0.01 Hz .
- ◆ Counter Function: It has 2 coupling measure modes including DC coupling and AC coupling. This design can solve inaccuracy problem of AC coupling.
- ◆ All parameters can be calibrated by internal program.
- ◆ Powerful arbitrary waveform edit function: Users can download arbitrary waveform to this instrument after edit through PC program which is included in user CD.
- ◆ Powerful communicating function. All functions can be controlled by PC

program and the communication protocol is open for secondary development.

- ◆ Output short-circuit protection: All channels can work more than 60 seconds when the load is short-circuited.
- ◆ Can choose our FYV2000 series or FPA1000 series power amplifier to output 20W or higher signals in DC-10MHz width without any distortion. The highest power can be up to 100W with our FPA101A amplifier.

Quick Start

General Inspection

Please follow the items below when you receive a new FY6600 series Function/Arbitrary Waveform Generator.

1. Inspect the shipping container for damage

Keep the damaged shipping container or cushioning material until the contents of the shipment have been checked for completeness and the instrument has passed both electrical and mechanical tests. The consigner or carrier shall be liable for the damage to instrument resulting from shipment.

2. Inspect the instrument

In case of any damage, or defect, or failure, notify your **FeelTech** sales representative.

3. Check the accessories





Please check the accessories according to the Appendix C (packing lists). If the accessories are incomplete or damaged, please contact your **FeelTech** sales representative.

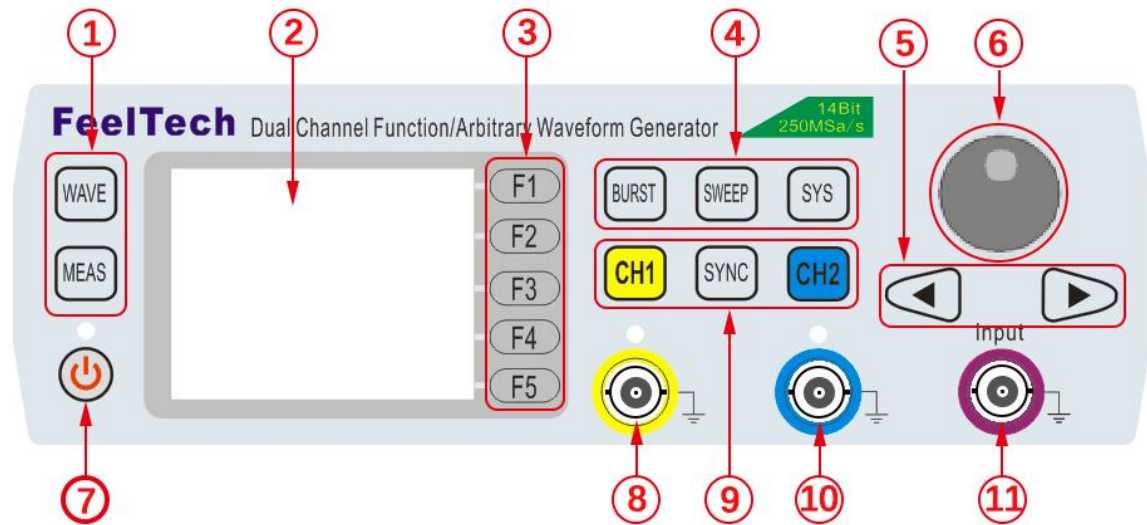



Front Panel Overview

The front panel is divided into several function areas for easy operation.



Front Panel

Item	Function	Description
1&	Function Buttons Area	 <p>Press this buttons to switch waveforms among Sine, Square, Triangle and so on.</p>
		 <p>Press this button to switch between frequency meter and counter to measure frequency, period, duty cycle and pulse width of external signal output.</p> <ul style="list-style-type: none"> — Both DC and AC are workable. — Gate Time can be 1S, 10S or 100S. — Dual channels output and measurement function can work together at same time.
		 <p>Can sweep Sine, Square, Arbitrary and so on.</p> <ul style="list-style-type: none"> — Can sweep frequency, amplitude, offset and phase. — 2 sweep types: Linear, Logarithm. — VCO voltage controls parameters of signal output available (for example: voltage controlled oscillator).
		 <p>Auxiliary functions and system configuration setting.</p> <ul style="list-style-type: none"> — Can save 20 sets waveform parameters including frequency, amplitude, offset, phase and so on. — System Language has English and Chinese for user' s option. — Buzzer can be turned on/off in this manu. — Set multimachine uplink.

		<ul style="list-style-type: none"> — Switch Master-Slave status — Set default status of dual channels at start-up.
		 <p>Trigger and modulation function button Set definite amount of pulse string to output. Set modulation mode: ASK, FSK, PSK</p>
2	LCD	2.4 inch TFT (320×240) color LCD. Operation instruction please check chapter “ User Interface ” .
3	Manu Buttons	F1~F5 buttons are matched with Manu displayed on the LCD. Press corresponding button to activate submenu represented.
5	Arrows	 <p>Press Arrow buttons to select figure which you want to edit when setting values of each parameter.</p>
6	ADJ Knob	<p>Press the knob as confirmation (OK button).</p> <ul style="list-style-type: none"> — Rotate the ADJ Knob to increase or reduce the current value indicated by the cursor. — Frequency unit can be changed by Press ADJ Knob under Frequency value setting status. — Press ADJ Knob to Start/Stop sweep under Sweep interface.
7	Power Button	<p>The power indicator keeps illuminating when power on.</p> <p>Press the power button and the indicator change to notify light status and the signal output terminates.</p>
8	CH1 channel output connector	<p>CH1 connector, output impedance is 50 Ω .</p> <p>When CH1 channel activates (indicator illuminates), CH1 outputs signal with parameters set.</p>
9	Output Channels	 <p>Control CH1 output. Press it to switch to CH1 parameter setting interface.</p> <ul style="list-style-type: none"> — Press it to turn on CH1 output with current configuration. The indicator will illuminate. — Press it again to turn off CH1 output and the indicator will extinguish.
		 <p>Control CH2 output. Press it to switch to CH2 parameter setting interface.</p> <ul style="list-style-type: none"> — Press it to turn on CH2 output with current configuration. The indicator will illuminate. — Press it again to turn off CH2 output and the indicator will extinguish.
		 <p>Synchronization function button. Can set synchronization of CH1 and CH2 (Frequency, Amplitude, Offset and so on).</p>

10	CH2 channel output connector	CH2 connector, output impedance is 50 Ω . When CH2 channel activates (indicator illuminates), CH2 outputs signal with parameters set.
11	AC coupling measuring terminal	BNC connector, input impedance 100 Ω . For inputting signal of meter or counter.

Back Panel Overview

The back panel of FY6600 is as picture 1-2 below. 4 BNC terminals on the left are DC coupling measuring terminals Trig/FSK/ASK/PSK IN, external sweep input VCO IN, Synchronization output connector SYNC OUT, and Synchronization input connector SYNC IN. Then follows TTL output terminal, USB terminal, power switch and power input socket.

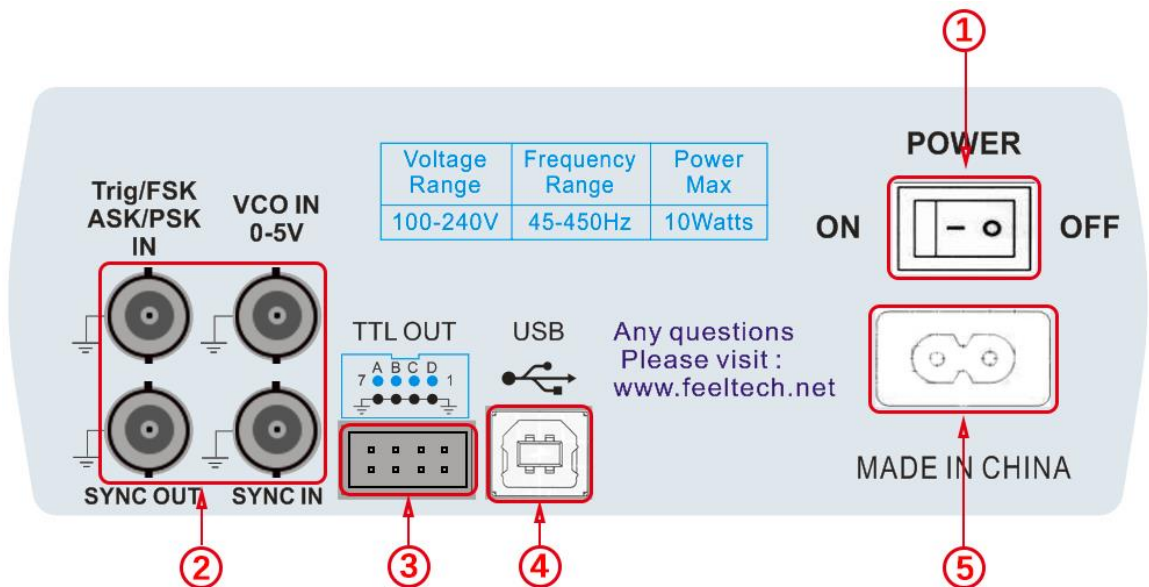

1. Power switch
2. BNC connector

Trig/FSK/ASK/PSK IN: DC coupling measuring terminal and ASK/PSK/FSK modulation trigger input terminal.

VCO IN: External signal sweep input terminal can realize voltage controlling frequency, voltage controlling amplitude, voltage controlling offset, voltage controlling duty cycle and so on. Frequency of external signal input should be lower than 500 Hz.

SYNC OUT: Synchronization signal output terminal.

SYNC IN: Synchronization signal input terminal.

3. TTL signal output

Frequency of Port A is same with frequency of CH1 output. Frequency of Port B is same with frequency of Port A but with reverse phase (180°). Frequency of Port C is same with frequency of CH2. Frequency of Port D is same with Port C but with reverse phase (180°).

4. USB Device interface

It's for communication with PC (This is a USB-TTL serial port and driver is needed). Can programming by host computer.

5. Power input socket(voltage range AC100V-AC240V).



Warning

To avoid instrument damage, voltage of signal input from EXT.IN CANNOT exceed $\pm 20\text{Vac} + \text{dc}$. Voltage of signal input from Trig/FSK/ASK/PSK IN CANNOT exceed DC5V.



Note

To ensure the normal work, please use 100-240V AC power supply.

Power On and Inspection

Connect to Power

Please connect the generator to AC power supply using the Power cable supplied in the accessories. The power supply use 100-240V AC power. The power of this instrument is less than 5W.

Power On

Turn on the power switch after the power cord is connected. The generator will execute self-inspection. The LCD will show welcome interface after the inspection is over. If the generator cannot work normally, please check the Chapter “Troubleshooting” for solution.

Set the System Language

FY6600 series Function/Arbitrary Waveform Generator supports Chinese and English system languages. You can press **SYS**→**CONF** to switch the system language.



User Interface

The user interface of FY6600 provides four types of display modes: Dual Channels Parameters (default), Single Channel Extension, Auxiliary Functions and System Interface.

Dual Channels Parameters (default)

The upper half of LCD displays the channel selected currently and the parameters can be set. Press **CH1** or **CH2** to change current channel selected.

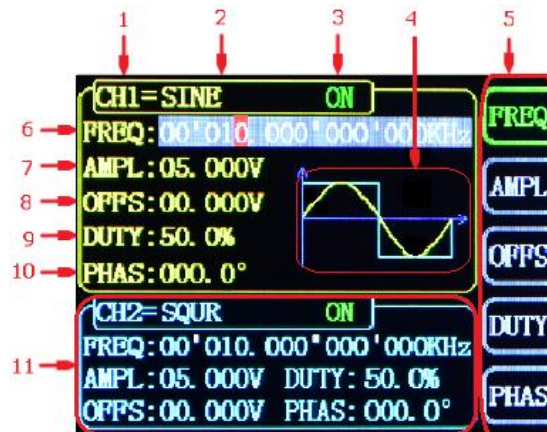

1-4 User Interface (CH1 selected)

Item	Description
1	Current channel selected. Display current channel selected for operation.
2	Current waveform selected. Display the name of current waveform selected. For example, “CH1=Sine” means current waveform selected of CH1 is Sine Wave. It can be changed by press WAVE button. Meanwhile, waveform can be changed quickly by rotating ADJ Knob when waveform switch function is activated.
3	Output status of current channel. Display On/Off status of current channel. It can be switched by Press CH1 or CH2 .
4	Waveform Display diagram of current waveform (Including Arbitrary) . Yellow indicates CH1 and blue indicates CH2.
5	Manu Bar Display current operable options .

6	Frequency	Display frequency value of current channel. Press FREQ button to highlight it and use ADJ Knob and Arrows to change the value.
7	Amplitude	Display amplitude value of current channel. Press AMPL button to highlight it and use ADJ Knob and Arrows to change the value.
8	Offset	Display DC Offset value of current channel. Press OFFS button to highlight it and use ADJ Knob and Arrows to change the value.
9	Duty Cycle	Display Duty Cycle value of current channel. Press DUTY button to highlight it and use ADJ Knob and Arrows to change the value.
10	Phase	Display Phase value of current channel. Press PHAS to highlight it and use ADJ Knob and Arrows to change the value.
11	Parameters of the channel unselected.	Display parameters of the channel unselected including frequency, amplitude, offset, phase, duty cycle and output status. These Parameters cannot be changed directly in this interface. If you need to change them, Please switch the channel to be selected.

Appearance and Dimensions



Front Panel Operations

Waveform Output

FY6600 series can output waveforms (Sine, Square, Triangle/Ramp, Pulse and Noise etc.) from one of the channels separately or from the two channels at the same time. At start-up, the dual channels are configured to output a sine waveform with 10kHz frequency and 5Vpp amplitude by default. Two channels use default setting saved at Position 1 when power on. Users can configure the instrument to output various waveforms.

Select Output Channel

CH1 and **CH2** buttons are used to change current channel selected. At start-up, CH1 is displayed on the top with yellow color and CH2 is displayed on the bottom with blue color. Press **CH1** or **CH2** to select channel needed. When selecting CH2 as output channel, CH2 parameters displays on the top for configuration.

KEY POINT:

CH1 and CH2 can not be selected at the same time. Users can first select CH1 and then select CH2 after configuring the waveform and parameters of CH1. If you need to change the parameters of two channel at same time, please refer to Chapter “**Synchronization**”.

Select Waveform

FY6600 can output Function/Arbitrary Waveform including:

- Sine
 - Square
 - Triangle/Ramp
 - Rise Sawtooth
 - Fall Sawtooth
 - Lorenz Pulse
 - Multitone
 - Noise
 - Electrocardiogram (ECG)
 - Trapezoidal Pulse
 - Sinc Pulse
 - Narrow Pulse
 - Gauss White Noise
 - Step Triangle
 - Positive Step
 - Inverse Step
 - Positive Exponent
 - Inverse Exponent
 - Positive Falling Exponent
 - Inverse Falling Exponent
 - Positive Logarithm
 - Inverse Logarithm
 - Positive Falling Logarithm
 - Inverse Falling Logarithm
 - Linear FM
 - AM
 - FM
 - Positive Half Wave
 - Negative Half Wave
 - Positive Half Wave
- Rectification
- Negative Half Wave
- Rectification
- User-defined waveform

Press **WAVE** to change waveform selected. Or rotate ADJ Knob under waveform switching status to change waveform. The waveform diagram displays on the screen. Pressing the knob can change to arbitrary waveform directly when choosing waveform. At start-up Sine is selected by default. (Users can also configure start-up waveform. Please check Chapter “Save and Load”.

Waveforms		Sine	Square	Triangle	Sawtooth	Arbitrary
Function Name		SINE	SQUR	TRGL	Ramp	Arb
Parameters	Frequency	✓	✓	✓	✓	✓
	Amplitude	✓	✓	✓	✓	✓
	Offset	✓	✓	✓	✓	✓
	Phase	✓	✓	✓	✓	✓
	Duty Cycle		✓			

Note: Arbitrary waveforms can be edited and downloaded from PC software provided by **FeelTech**. The relevant software and driver can be downloaded from our website: www.feeltech.net.

Set Frequency

Frequency is one of the most important parameters of waveforms. For different instrument models and waveforms, the setting ranges of frequency are different. For detailed information, please refer to “**Frequency**” in “**Specifications**”. The default frequency is 10kHz.

Press **FREQ** button to highlight value of Frequency. Then use Arrow buttons and ADJ Knob to set the value. Press Arrows button to move the cursor and rotate ADJ Knob to set the value.

Under setting frequency status, press ADJ Knob to change frequency units among MHz, KHz, Hz, mHz, μ Hz.

Set Amplitude

The amplitude setting range is limited by the “Attenuation” and “Frequency” settings. Please refer to “**Output Characteristics**” in “**Specifications**”. The default value is 5Vpp.

Press **AMPL** button to highlight amplitude value. Then use Arrows button and ADJ Knob to set the value. Press Arrows button to move the cursor and rotate ADJ Knob to set the value.

Key Points:

1. What's the difference of amplitude in Vpp and the corresponding value in Vrms?

Answer:

Vpp is the unit for signal peak-peak value and Vrms is the unit for signal effective value. The default unit is Vpp.

Note:

For different waveforms, the relation between Vpp and Vrms is different. The relation of the two units is as shown in the figure below (take sine waveform as an example).

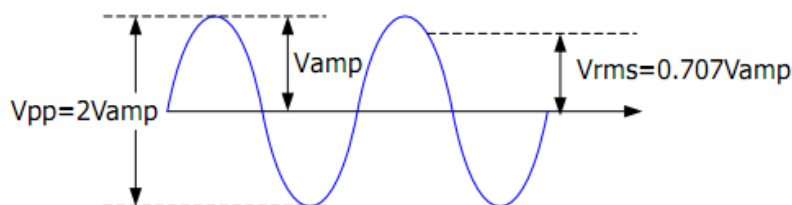

According to the figure above, the conversion relation between Vpp and Vrms fulfills the following equation:

$$V_{pp} = 2\sqrt{2} V_{rms}$$

For example, if the current amplitude is 5Vpp, For sine waveform, the converted value is 1.768Vrms.

Set Offset

Press **OFFS** button to highlight offset value. Then use Arrows button and ADJ Knob to set the value. Press Arrows button to move the cursor and rotate ADJ Knob to set the value.

The offset accuracy is 1mV. i.e. 0.001V.

When frequency output is lower than 20MHz, the offset can be adjusted during -10V~+10V.

When frequency output is higher than 20MHz, the offset can be adjusted during -2.5V~+2.5V.

Set Duty Cycle (Square)

Duty cycle is defined as the percentage that the high level takes up in the whole period (as shown in the figure below). This parameter is only available when square is selected.

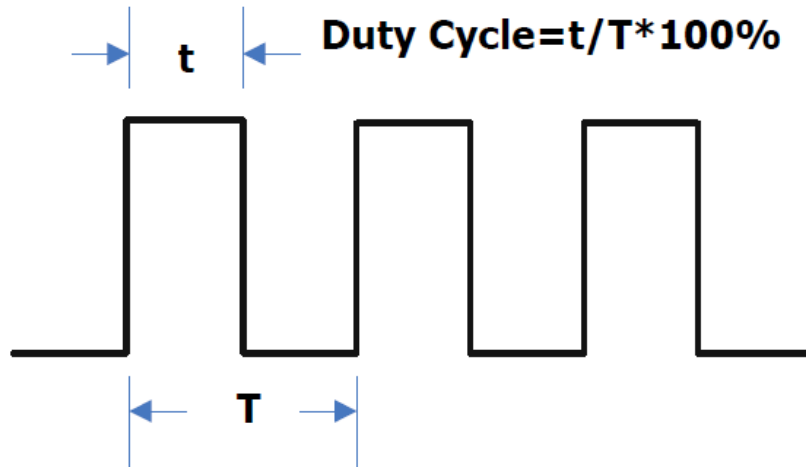

The setting range of duty cycle is limited by the “FREQ” setting. Please refer to “**Waveform Characteristics**” in “**Specifications**”. The default value is 50%.

1. Press **DUTY** button to highlight duty cycle value. Then use Arrows button and ADJ Knob to set the value. Press Arrows button to move the cursor and rotate ADJ Knob to set the value.

- The setting range of duty cycle is 0.1%-99.9%;
- Press ADJ Knob under duty cycle setting status will initial the value to 50%.

Set pulse wave pulse width (‘Adj-Pulse’ wave)

Adjustable pulse wave refers to the square wave that can hold the fixed pulse width at any frequency, that is, the pulse width set by the user does not change with the frequency.

Pulse width setting method: in the adjustable pulse wave is selected, press **PULS** button key to adjust the pulse wave pulse width time (Unit ns).The pulse width can be set by the arrow button and the knob. Use the arrow button to move the cursor to select the bit you want to edit, and then turn the knob to modify the value. (Note: Do not set the length of the positive pulse width greater than or equal to the cycle time of the output waveform).

Set Phase

The setting range of phase is from 0° to 359.9°. The phase resolution is 0.1°. The default phase value is 0°

The start phase displayed on the screen is the default value or the phase previously set.

Then press **PHAS** button to highlight phase value. Then use Arrows button and ADJ Knob to set the value. Press Arrows button to move the cursor and rotate ADJ Knob to set the value.

Enable Output

After configuring the parameters of the waveform selected, waveform output could be enabled.

At start-up output of CH1 and CH2 are both turned on as default. At this time indicator lights of dual channels illuminate.

The default status can be modified. Press **【SYS】** button and then press **【MORE】** button to set the output status of dual channels.

For CH1 there are two status:

- 1) Generator is in parameter setting status and current channel selected is CH1, then press **CH1** to switch between output ON/OFF.
- 2) Generator is in other working status or current channel selected is not CH1, then press **CH1** to make CH1 as channel selected and press **CH1** again to switch between output ON/OFF.

For CH2 there are two status:

- 3) Generator is in parameter setting status and current channel selected is CH2, then press **CH2** to switch between output ON/OFF.
- 4) Generator is in other working status or current channel selected is not CH2, then press **CH2** to make CH2 as channel selected and press **CH2** again to switch between output ON/OFF.

Example: Output Sine Waveform

This section mainly introduces how to output a sine waveform (Frequency: 20kHz, Amplitude:2.5Vpp, DC Offset: 1.6VDC, Start Phase: 90.9°) from the [CH1] channel.

1. Select output channel

Press **CH1** to select CH1. Now all characters and border of the channel is displayed in yellow.

2. Select the Sine

Press **WAVE** button to select Sine. Then the diagram of Sine displays on the screen.

3. Set the frequency

Press **FREQ** button to highlight the frequency value. Press Arrow buttons to move the cursor to the position "2" below. Then rotate the ADJ Knob to get "2".

FREQ: 00'020.000'000'000kHz

4. Set the Amplitude

Press **AMPL** to highlight the amplitude value. Press Arrow buttons to move the cursor and rotate the ADJ Knob to get the figures below.

AMPL: 02.500V

5. Set Offset

Press **OFFS** to highlight the offset value. Press Arrow buttons to move the cursor and rotate the ADJ Knob to get the figures below.

OFFS: 01.600V

6. Set Phase

Press **▼** button to page down and press **PHAS** button to highlight phase value. Then Press Arrow buttons to move the cursor and rotate the ADJ Knob to get the figures below.

PHAS: 090.9°

7. Enable the output

Press **CH1** button to turn CH1 output on. The [CH1] connector outputs the configured waveform.

8. Observe the output waveform

Connect the [CH1] connector to the oscilloscope with BNC cable. The waveform is as shown below.

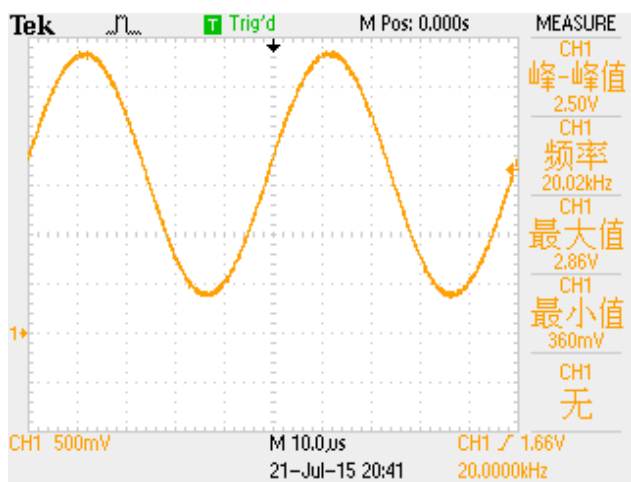

Burst

FY6600 can output waveform with specified number of cycles (called Burst) from the CH1 channel. FY6600 supports control of burst output by CH2(internal), manual or external trigger source; The signal generator can generate burst using Sine wave, Square wave, Ramp wave, Pulse, Noise wave or arbitrary waveform (except DC).

The instrument supports [CH2], [external] and [manual] three trigger output modes, which can be selected by the corresponding keys.

Enable Burst Function

Press the front panel **BURST** button, then press **BURS** button to enter burst function. The instrument supports [CH2], [external] and [manual] , three trigger output modes, which can be selected by the corresponding button. When the burst function is enabled, press **No.** button to set the cycles of burst. Use arrow buttons and ADJ Knob to set the numbers from 1 to 1048575. Then the generator will output burst waveform according to current configuration.

- NORMAL: The Burst function is disabled.
- CH2 Trigger: CH1 will generate a burst when CH2 generates a pulse.
- Ext. Trigger: CH1 will generate a burst when EXT.IN connector was inputted a pulse.
- MANU Trigger: User can trigger a burst by pressing ADJ Knob (OK button).

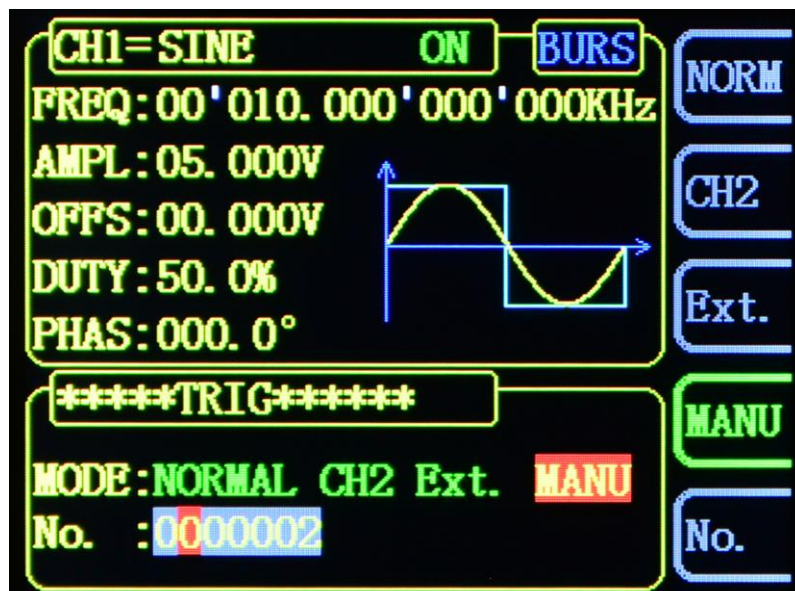

Numerical Modulation

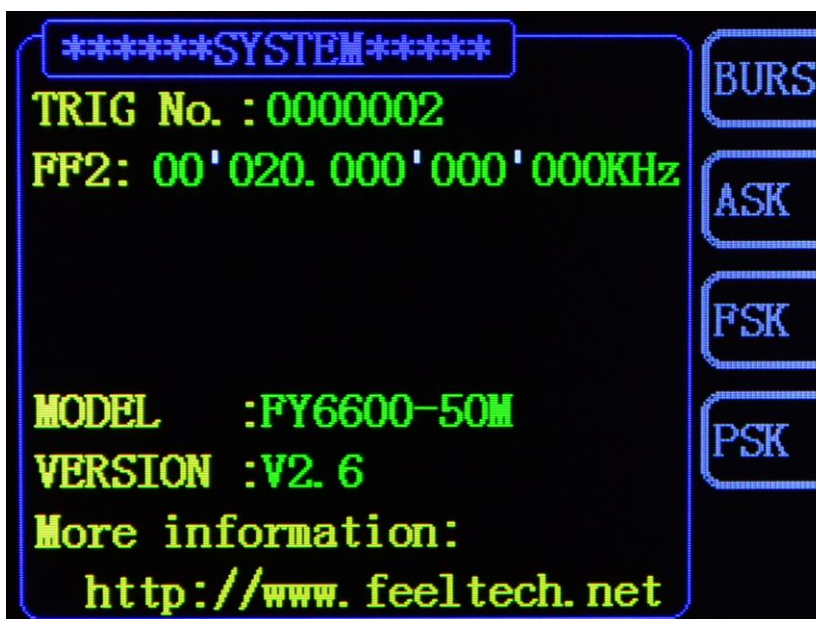

Press **BURST** button to enter numerical and trigger function, then press the relevant button to enter relevant modulation function. Modulation mode can be external modulation and manual modulation. Modulation signal can be input from Trig/FSK/ASK/PSK IN on the back.

Frequency Meter/Counter

FY6600 provides a counter which can measure various parameters of external input signal such as frequency, period, duty cycle, positive pulse width and negative pulse width. Dual channels output can work together with counter.

Enable the Counter

Press **MEAS** button of the front panel to enable the counter and measurement Manu. External signal for measurement can be inputted by Input connector(AC coupling) or Trig IN(DC coupling). The result will be displayed on the screen in real time. The lowest frequency workable is 0.01 Hz. (GATE TIME:100S)。

Press **COUN** button to enter external pulse counter function. At this time **COUN** button is turned into **FREQ** button. Repeat pressing this button to switch between **FREQ** and **COUN**.

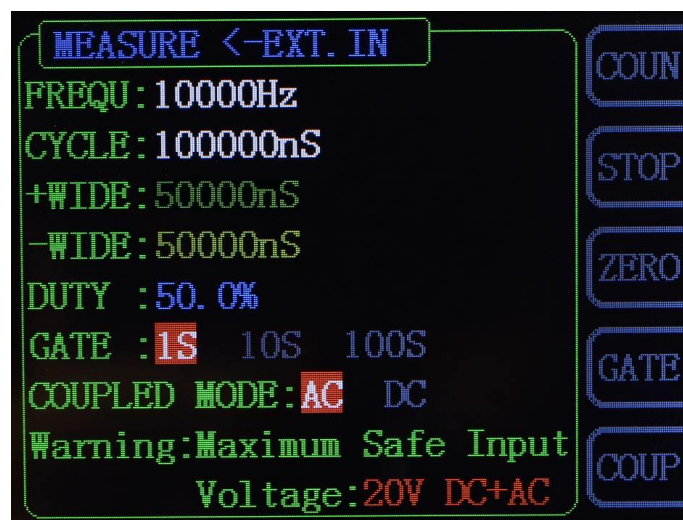

2-1 Frequency Meter/Counter Interface

When the Frequency Meter/Counter is turned on, press **STOP** button to pause and press **ZERO** button to reset.

Key Point:

Amplitude of signal inputted should be bigger than 1.5V. Maximum safe voltage inputted from Input and Trig IN is 5V. The Uplink function need to be turned off when using Counter/Meter.

Set the Counter

Gate Time

Press **GATE** button to select gate time. The default is “1S”. It’s better to use “10S” or “100S” as gate time for low frequency signal.

Gate Time	Frequency Resolution
1S	1Hz
10S	0.1Hz
100S	0.01Hz

Coupling

Set the coupling mode of the input signal to “AC” or “DC” and the default is “AC”.

When the AC coupling mode is selected, signal should be inputted from Input terminal.

When the DC coupling mode is selected, signal should be inputted from Trig IN terminal.

Sweep

Press **SWEEP** button of front panel to enable sweep function. FY6600 can output sweep from CH1. In sweep mode, the generator outputs signal variably from the start frequency to stop frequency within the specified sweep time. It can generate sweep output for Sine, Square, Triangle/Ramp and arbitrary waveform.

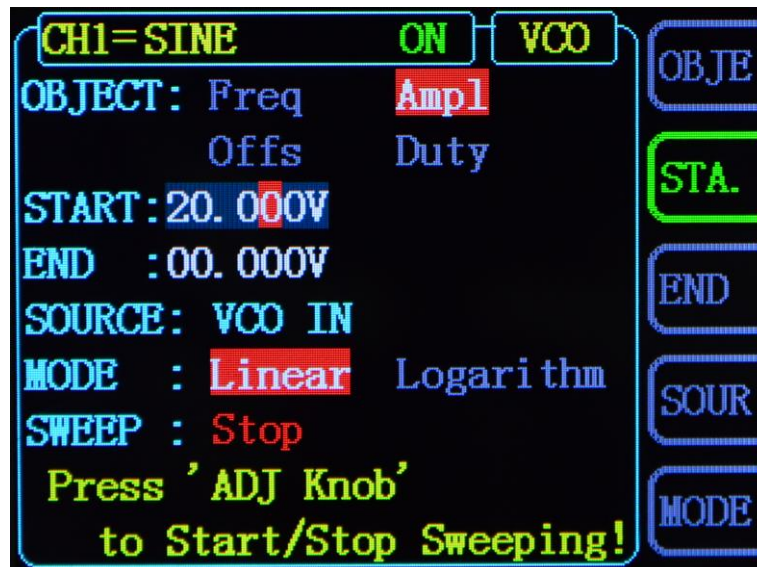

2-2 Sweep setting interface

Sweep Object

FY6600 Can output sweep from CH1. The sweep objects include frequency, amplitude, offset, duty cycle. It can be selected by pressing **OBJE** button.

- In Frequency Sweep Mode, the generator will output signal variably from start frequency to end frequency within the specified sweep time.
- In Amplitude Sweep Mode, the generator will output signal variably from start amplitude to end amplitude within the specified sweep time.
- In Offset Sweep Mode, the generator will output signal variably from start offset to end offset within the specified sweep time.
- In Duty Cycle Sweep Mode, the generator will output signal variably from start duty cycle to end duty cycle within the specified sweep time.

Sweep Start Position

When Sweep function is enabled. Sweep start position need to be set according to sweep objects.

- Frequency Sweep: Press **STAR** button to highlight start frequency parameter. Press the Arrow buttons and rotate the ADJ Knob to set the specified value. For example:

START: 00'010.000'000'000kHz

- Amplitude Sweep: Press **STAR** button to highlight start amplitude parameter. Press the Arrow buttons and rotate the ADJ Knob to set the specified value. For example:

START: 10.00V

- Offset Sweep: Press **STAR** button to highlight start offset parameter. Press the Arrow buttons and rotate the ADJ Knob to set the specified value. For example:

START: 00.00V

- Duty Cycle Sweep: Press **STAR** button to highlight start duty cycle parameter. Press the Arrow buttons and rotate the ADJ Knob to set the specified value. For example:

START: 50.0%

Sweep End Position

When Sweep function is enabled. Sweep end position need to be set according to sweep objects.

- Frequency Sweep: Press **END** button to highlight end frequency parameter. Press the Arrow buttons and rotate the ADJ Knob to set the specified value. For example:

END: 00'020.000'000'000kHz

- Amplitude Sweep: Press **END** button to highlight end amplitude parameter. Press the Arrow buttons and rotate the ADJ Knob to set the specified value. For example:

END: 20.00V

- Offset Sweep: Press **END** button to highlight end offset parameter. Press the Arrow buttons and rotate the ADJ Knob to set the specified value. For example:

END: 10.00V

- Duty Cycle Sweep: Press **END** button to highlight end duty cycle parameter. Press the Arrow buttons and rotate the ADJ Knob to set the specified value. For example:

END: 80.0%

Sweep Time

When Sweep function is enabled, press **SOUR** button to select it and press it again to change between **TIME** and external sweep (VCO Sweep). Press the Arrow buttons and rotate the ADJ Knob to set the specified value of sweep time. The default is "10S". The work range is 10mS~999.99S. For Example:

SOUR: TIME 999.99S

VCO (Voltage Control Output) Sweep

Function instruction: External voltage can control signal output by External Sweep (VCO) function. It can realize voltage controlling frequency (VCF), voltage controlling amplitude (VCA), voltage controlling offset, voltage controlling duty cycle and so on.

Operation method: Press **[SWEEP]** button to enter sweep function interface. Then press **[F4 SOUR]** button to switch the source to VCO IN. After Sweep Object, Start, End and Sweep Mode being set, connect the external signal from VCO IN terminal on the back panel. Then press the ADJ knob (OK button) to enable VCO sweep function. Press ADJ knob (OK button) again to disable it.

Note: Signal input for External Sweep (VCO) need to be input from VCO IN port of back panel. Its frequency need to be less than 500 Hz and its voltage amplitude need to be among 0~5V.

Sweep Type

FY6600 provides Linear, Logarithm sweep types. The default is Linear sweep. The sweep type can be switched by pressing “MODE” button.

Linear Sweep

In linear sweep type, the signal parameter varies linearly. For example, in the frequency sweep the output frequency of the instrument varies linearly in the way of “Changing several Hertz per second”. The variation is controlled by “Start Frequency”, “End Frequency” and “Sweep Time”.

The step value of linear sweep object is computed by the generator, the formula is as follows:

$$\text{Step value} = (\text{End value} - \text{Start value}) / (\text{Sweep time} * 100)$$

Logarithm Sweep

In linear sweep type, the signal parameter varies logarithmically.

For example, in the frequency sweep the output frequency changes in the way of “octave per second” or “decade per second”. The variation is controlled by “Start Frequency”, “End Frequency” and “Sweep Time”.

When Logarithm Sweep is enabled, users can set the following parameters: Start Frequency (F_{start}), Stop Frequency (F_{end}) and Sweep Time (T_{sweep}).

The function prototype of Logarithm Sweep:

$$F_{current} = P^T$$

$F_{current}$ is the instantaneous frequency of the current output. P and T could be expressed as shown below by the above-mentioned parameters:

$$P = 10^{\lg(F_{stop}/F_{end})/T_{sweep}}$$

$$T = t + \lg(F_{start})/\lg(P)$$

Wherein, t is the time from the start of the sweep and its range is from 0 to T_{sweep} .

Enable Sweep Function

Press **SWEEP** button of front panel to enable sweep function. Then press ADJ Knob to start sweep process. Press ADJ Knob again to stop sweep.

Start value and End value

Start value and stop value are the upper and lower limits of sweep for specified parameter. sweep. The generator always sweeps from the start value to the end value and then returns back to the start value and continues indefinitely.

For example, in Frequency Sweep function:

- Start Frequency < End Frequency: the generator sweeps from low frequency to high frequency.
- Start Frequency > End Frequency: the generator sweeps from high frequency to low frequency.
- Start Frequency = Stop Frequency: the generator outputs with a fixed frequency.

When Sweep function is enabled, press **STAR** button to highlight start value. Use arrow buttons and ADJ Knob to set the specified value. Different frequency sweep corresponds to different start frequency and end frequency range.

Sine: 10mHz to 25MHz~60MHZ (Varies according to different model)
Square: 10mHz to 25MHz
Ramp: 10mHz to 10MHz
Arbitrary: 10mHz to 10MHz

The generator will restart sweep (according to the current new configuration) from the specified “start frequency” after start or end frequency is changed.

System Configuration and Auxiliary Functions

Press **SYS** button of front panel to enter System interface. The interface displays the instrument parameter storage [SAVE] , parameter loading [LOAD] , configuration [CONF] and other functional [MORE] information.

SAVE: To save current parameters of waveform to save positions (20 sets).

LOAD: To load parameters to current working status from save positions.

CONF: To set system language, turn on/off Buzzer and Uplink mode.

MORE: To set default output status of dual channels.

CH1 BOOT: ON

The default CH1 channel is on to turn on the output state, can press the [F1] button to set the default output status of the CH1 channel.

CH2 BOOT: ON

The default CH2 channel is on to turn on the output state, can press the [F2] button to set the default output status of the CH2 channel.

Save and Load

Press **SAVE** button in System interface to save parameters of current waveform to specified position. Press **LOAD** button to load parameters of waveforms previously set to current system status.

Select **S xx** on the right to save current parameters to corresponding position.

Select **L xx** on the right to load parameters from corresponding position to current system status.

- FY6600 provides 20 positions for saving.
- The generator will load default parameters from Position 01 automatically after start-up.

Configuration

Press **SYS** button to enter system interface. Then press **CONF** button to enter system configuration interface. Press corresponding buttons to select system work mode.

- Press **中文** button to select Chinese as system language.
- Press **Eng** button to select English as system language.
- Press **BUZZ** button to turn on/off buzzer. On is the default.
- Press **M/S** button to set uplink mode: Master/Slave. Master is the default.
- Press **UPLI** button to turn on/off uplink function. Off is the default.

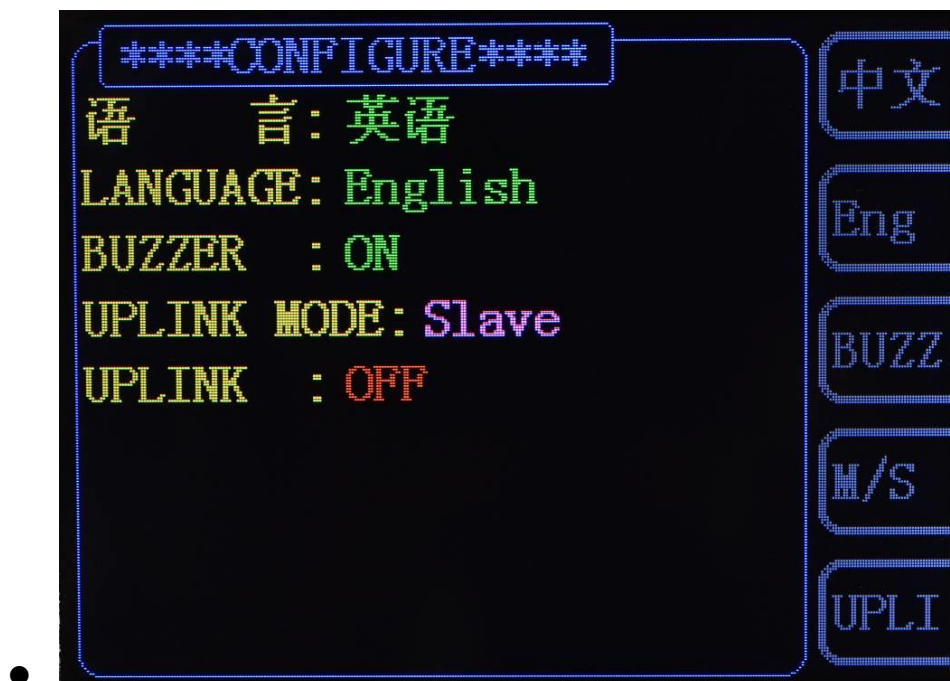

Uplink

FY6600 supports multi-machine uplink, which can provide users more channels for output. In uplink network, only one master machine can exist. Others must be set as slave machine. The setting method is as follows:

- Select on FY6600 as master machine. Press **SYS** -> **CONF** -> **M/S**, to set the UPLINK MODE to be "Master". Press **UPLI**, to set the UPLINK to be "ON".
- Set all other machines to be slave machines. Press **SYS** -> **CONF** -> **M/S**, to set the UPLINK MODE to be "Slave". Press **UPLI**, to set the UPLINK to be "ON". Repeat this step to set all slave machines.
- Connect all FY6600 in parallel by SYNC connector.
- The uplink machines cannot exceed 8 because the driving ability.

When the setting above has been finished, all machines in network will work synchronously according to the start phase of master machine. When outputting signal with same frequency, multi channels output can be executed with phase adjustable.

Synchronization

Press the [SYNC] button to enter the synchronization function setting interface. Press corresponding buttons on the right to highlight or cancel selecting status.

When the synchronization of corresponding parameters are activated, the corresponding parameters of CH2 will vary according to variation of CH1 automatically. The parameters workable for synchronization include waveform, frequency, amplitude, offset, and duty cycle, which can be set separately.

When **WAVE** is highlighted, the waveform of CH2 will vary according to variation of CH1.

When **FREQ** is highlighted, the frequency of CH2 will vary according to variation of CH1.

When **AMPL** is highlighted, the amplitude of CH2 will vary according to variation of CH1.

When **OFFS** is highlighted, the offset of CH2 will vary according to variation of CH1.

When **DUTY** is highlighted, the duty cycle of CH2 will vary according to variation of CH1.

Troubleshooting

This chapter lists the commonly encountered failures of FY6600 and their solutions. When you encounter these problems, please solve them following the corresponding steps below. If the problem remains still, please contact **FeelTech** and provide the device information (Press **SYS** to get it).

Failure Phenomena	Solutions
The screen of the generator is still dark (no display) after switch on.	<ol style="list-style-type: none"> 1) Check whether the power is correctly connected. 2) Check whether the power switch has been pulled in place. 3) Restart the instrument after finishing the above inspections. 4) If it still does not work correctly, please contact FeelTech.
CH2 is locked.	<ol style="list-style-type: none"> 1) Check that the signal generator is operating in synchronous state. Press the SYNC button to enter the synchronization settings interface to cancel all synchronization parameters. 2) If the problem is still, please restart the generator.
Set correctly, but no waveform output	<ol style="list-style-type: none"> 1) Check whether the BNC cable is connected tightly with CH1 or CH2 connector. 2) Check whether the BNC cable has internal damage. 3) Check whether the BNC cable is connected tightly with the test instrument. 4) Check whether the indicators of CH1 or CH2 is turned on. If not press corresponding button to turn it on. 5) If the problem is still, please contact FeelTech.

Technical Specification

Unless specified, all specifications can be guaranteed if the following two conditions are met.

- The generator has passed self-inspection.
- The generator has been working continuously for at least 30 minutes under the specified temperature (18°C~28°C).

All the specifications are guaranteed unless those marked with “typical”

Frequency				
Model	FY6600-15M	FY6600-30M	FY6600-50M	FY6600-60M
Sine	0~15MHz	0~30MHz	0~50MHz	0~60MHz
Square	0~15MHz	0~25MHz	0~25MHz	0~25MHz
Ramp/Triangle	0~10MHz	0~10MHz	0~10MHz	0~10MHz
Pulse	0~10MHz	0~10MHz	0~10MHz	0~10MHz
TTL/CMOS	0~10MHz	0~10MHz	0~10MHz	0~10MHz
Random	0~10MHz	0~10MHz	0~10MHz	0~10MHz
Minimum pulse width	20ns(All models of pulse wave minimum width can reach 20ns)			
Min. Resolution on all frequency range	1μHz (Min. resolution can reach 1μHz on all frequency range to ensure adjusting accuracy under high frequency. For example, it can output 10.000000000001MHz signal).			
Accuracy	±20ppm			
Stability	±1ppm/ 3hours			
Waveform Characteristics				
Waveforms	Sine, Square (Duty Cycle adjustable), Pulse (Pulse width and cycle time can be set accurately), Triangle/Ramp, Sawtooth Wave, CMOS, Four channels TTL, DC, Half wave, Full wave, Positive Step, Inverse Step, Positive Exponent, Inverse Exponent, Lorenz Pulse, Multitone, Noise, ECG, Trapezoidal Pulse, Sinc Pulse, Narrow Pulse, Gauss White Noise, AM, FM, and other 64 sets customer-defined waveform.			
Arbitrary Wave Nonvolatile Storage	Can store 64 user-defined arbitrary waveform			
Waveform Length	8192 Dots * 14Bit			
Sampling Rate	250MSa/s			
Vertical Resolution	14 Bits			
Sine	Harmonic Suppression	≥45dBc(<1MHz);≥40dBc(1MHz~20MHz);		

	Total Harmonic Distortion	<0.8% (20Hz~20kHz,0dBm)
Square	Rise/Fall Time	≤7ns(VPP<5v)
	Overshoot	≤5%
	Duty Cycle	0.1%~99.9%
Sawtooth	Linearity	≥98% (0.01Hz~10kHz)

Output characteristics

Amplitude (VPP)	Frequency≤10MHz: 1mVpp~20Vpp ; 10MHz<Frequency≤20MHz: 1mVpp~10Vpp, Frequency>20MHz: 1mVpp~5Vpp
Amplitude Resolution	1mV
Amplitude Stability	±0.5%/ 5 Hours
Amplitude flatness	±5%(<10MHz) ; ±10%(>10MHz);

Waveform Output

Impedance	50Ω±10% (Typical)
Protection	All channels can work more than 60 seconds when the load is short-circuited.

Dc Offset

Offset Range	Frequency≤20MHz: ±10V ; Frequency>20MHz: ±2.5V
Offset Resolution	1mV

Phase

Feature

Phase range	0~359.9°
Phase resolution	0.1°

TTL Output

Electrical Level Amplitude	>3Vpp
Fan-out	>8 TTL LOAD
Rise/Fall Time	≤10ns

CMOS Output

Low Electric Level	<0.3V
--------------------	-------

High Electric Level	1V~10V
Rise/Fall Time	≤20ns

External Measurement

Frequency Meter	Range	0.01Hz~100MHz
	Sensitivity	Gate Time 3 grades(1S, 10S, 100S) adjustable
Counter	Range	0-4294967295
	Coupling	DC , AC
	Working Mode	Manual
Voltage Input Range	2Vpp~20Vpp	
Pulse Width measurement	Resolution 5 nS. Max. 20S	
Period Measurement	Resolution 5ns, Max. Limit 20s	

Sweep

Sweep Type	Linear or Logarithm
Sweep Objects	Frequency, Amplitude, Offset, Duty Cycle
Sweep Time	0.01S~999.99S/Step
Parameters Range	Starting position and Finishing position can be set arbitrarily.
Sweep Range	Decided by Parameters setting.

VCO (Voltage Control Output)

Modulation signal range to input	0~5V
VCO signal frequency range	0-1000Hz
VCO control object	voltage controlling frequency (VCF), voltage controlling amplitude (VCA), voltage controlling offset, voltage controlling duty cycle.
VCO special function	Can Amplitude Modulate (AM) or Frequency Modulate (FM) by external analog signal.

Digital Modulation (Modulate analog signal by digit)

Modulation Mode	ASK, FSK, PSK
Signal Carrier	Sine, Square, Triangle/Ramp, Sawtooth, Random (DC excluded)
Source	CH2, External, Manual
Modulation wave	Square with 50% duty cycle (1μHz~10MHz).

Burst Function

Pulse Quantity	1-1048575
Burst Mode	Manual, CH2, External

General Specifications

Display	Mode	2.4 inch TFT Color Lcd.
Save & Load	Amount	20
	Position	01 to20 (01 for start default value)
Interface	Type	USB to Serial interface.
	Communicating Speed	9600bps (Industrial standard)
	Protocol	Command line mode, protocol complete open.
Power	Voltage Range	AC100V~240V
Technic	SMD, LSI, Reliable and durable	
Buzzer	Can be turned on/off by setting.	
Operation	Buttons and knob continuously.	
Environment	Temp.: 0~40℃ Humidity: < 80%	
Dimension	200mm (Length) ×190mm (Width) ×90mm (Height)	
Weight	Machine (700 g) , Accessories (150 g)	

Appendix

Appendix A: Safety Notes

1. Before using this instrument, please check if the power supply is normal, to ensure the normal use and personal safety.
2. This instrument must be used in the technical index range.
3. Please do not change the instrument circuit arbitrarily, so as to avoid damaging equipment or endangering the safety.

Appendix B: Warning and personal injury

Do not apply the product in the safety protection device or emergency stop device, or any other applications that the product failure could result in personal injury, unless there is special purpose or use authorization. Before the installation and use, each parameter of the technical indexes in this manual should be referred to. If this suggestion is not obeyed, death or serious personal injury could be caused. In this condition the company will not be responsible for any compensation of personal injury or death, and all the company managers and employees and auxiliary agents, distributors, other personnel concerned will be released from any claim (including all the costs, expenses, attorney fees etc.) that may result in.

Appendix C: Accessories and Options

	Description	Quantity
Model	FY6600-15M (15MHz, Dual-channel)	1
	FY6600-30M (30MHz, Dual-channel)	
	FY6600-50M (50MHz, Dual-channel)	
	FY6600-60M (60MHz, Dual-channel)	
Standard Accessories	Power Cable	1
	USB Data Cable	1
	BNC-Clip Cable	2
	BNC-BNC Cable	1
	Warranty Card	1
Options	FYA2000 Series Amplifier	
	FPA1000 Series Amplifier	

Note: Options can be ordered from local **FeelTech** distributors.

Appendix D: Warranty

FeelTech warrants that its products mainframe and accessories will be free from defects in materials and workmanship within the warranty period. If a product is proven to be defective within the respective period, **FeelTech** guarantees the free replacement or repair of products which are approved defective. This product enjoy 1 year warranty since its delivery. Damages caused by misuse, vandalism, improper maintenance or force majeure are not covered by the warranty. Any disassembly or amendment without permission will be deemed giving up warranty rights consciously.