



## Network Server 500 and 700 Series

---

Network Server 500/132, Network Server 700/150,  
and Network Server 700/200





## Basics

---

Network Server 500 and  
700 Series





## Overview

The Network Server 500 Series and Network Server 700 Series are a family of high-performance servers based on the PowerPC 604 or 604e Reduced Instruction Set Computer (RISC) microprocessor. Designed around an innovative architecture, the servers provide high performance and scalability for medium to large workgroups running AIX-based applications.





## Network Server 500 Series Features

Features of the Network Server 500 Series include the following:

- 132-MHz PowerPC 604 microprocessor
- 32K on-chip cache
- 512K Level 2 cache
- 32 MB main DRAM memory, expandable to 512 MB
- Six PCI expansion slots
- Seven drive bays for internal, redundant drives that are hot-swappable with RAID
- Total disk capacity with RAID: 368 GB
- Built-in Ethernet interface using the Apple Ethernet Cable System (AAUI)
- One SCSI-1 channel with external port
- Two Fast/Wide SCSI-2 channels for internal devices





- Built-in 1024 x 768, 800 x 600, 640 x 480 video support for 14-inch, 15-inch, 17-inch, and 20-inch multi-sync monitors
- CD, floppy bays (DAT is optional)
- An LCD display that monitors server activity and can be used for diagnostic tests

## **Network Server 700 Series Features**

Features of the Network Server 700 Series include the following:

- 150-MHz PowerPC 604 microprocessor (Network Server 700/150) or 200-MHz PowerPC 604e microprocessor (Network Server 700/200) or two 200-MHz PowerPC 604e microprocessors (Network Server 700/200SMP)
- 32K on-chip cache (Network Server 700/150) or 64K on-chip cache (Network Server 700/200)





- 1 MB Level 2 cache
- 48 MB main DRAM memory, expandable to 512 MB
- Six PCI expansion slots
- Seven drive bays in the front for internal, redundant drives that are hot-swappable with RAID
- Two drive bays in the rear for internal fixed drives
- Total disk capacity with RAID: 368 GB
- Built-in Ethernet interface using the Apple Ethernet Cable System (AAUI)
- One SCSI-1 channel with external port
- Two Fast/Wide SCSI-2 channels for internal devices
- Redundant, hot-swappable power supplies
- Built-in 1024 x 768, 800 x 600, 640 x 480 video support for 14-inch, 15-inch, 17-inch, and 20-inch multi-sync monitors
- CD, floppy bays (DAT or 8 mm tape drive is optional)
- An LCD display that monitors server activity and can be used for diagnostic tests





## Configurations

At product introduction, the following was the standard configuration for the Network Server 500/132:

- 132-MHz PowerPC 604 processor card
- 512 KB Level 2 cache
- 32 MB parity DRAM minimum
- 2 GB Fast/Wide hard drive
- DAT2 tape drive
- AppleCD 600i CD-ROM drive
- Floppy disk drive
- AppleTalk administration utilities
- 325 watt power supply

At product introduction, the standard configuration for the Network Server 700/150 was

- 150-MHz PowerPC 604 processor card
- 1 MB Level 2 cache





- 48 MB parity DRAM minimum
- 4 GB Fast/Wide hard drive
- DAT2 tape drive
- AppleCD 600i CD-ROM drive
- Floppy disk drive
- AppleTalk administration utilities
- 425 watt power supply

At product introduction, the standard configuration for the Network Server 700/200 was

- 200-MHz PowerPC 604e processor card
- 1 MB Level 2 cache
- 48 MB parity DRAM minimum
- Two 4 GB Fast/Wide hard drives
- AppleCD 1200i CD-ROM drive
- Floppy disk drive
- AppleTalk administration utilities
- 425 watt power supply







**Note:** AIX software does not come preinstalled in standard configurations of the Network Server 500 and 700 Series. The AIX software must be purchased separately.





## Options and Upgrades

Apple offers the following options and upgrades to enhance the operation and performance of the Network Server 500 and 700 Series.

- Processor Upgrade

Card with One 200-MHz 604e PowerPC Processor  
M5177Z/A

- Main Memory

16 MB Parity Memory Kit M4017Z/A

32 MB Parity Memory Kit M4018Z/A

64 MB Parity Memory Kit M4019Z/A





- Hard Drives
  - 2 GB Fast/Wide SCSI Hard Drive w/ Tray M4022Z/A
  - 4 GB Fast/Wide SCSI Hard Drive w/ Tray M4023Z/A
  - 9 GB Fast/Wide SCSI Hard Drive w/ Tray M5178Z/A
  
- Rear Hard Drives and Bracket
  - 2 GB Fast/Wide SCSI Hard Drive & Bracket M4818Z/A
  - Two 4 GB Fast/Wide SCSI Hard Drives & Bracket M4819Z/A
  
- CD-ROM and Tape Drives
  - 4-X CD-ROM Drive w/ Tray M4024Z/A
  - DAT-2 SCSI Tape Drive w/ Tray M4025Z/A
  - 8 mm Tape Drive (20/40 GB) w/ Tray M4026Z/A





- Storage Bay Accessories
  - SCSI Drive Adapter Kit (68 and 50-Pin) M4028Z/A
  - SCSI Front Drive Bezel Kit M4029Z/A
- Redundant Power Supply (NS 700 Series Only)
  - 425 W Hot-swappable Power Supply M4035Z/A
- PCI Expansion Cards
  - PCI RAID Disk Array Card M4030Z/A
  - RAID External SCSI Cable (68-Pin to 68-Pin) M4031Z/A
  - PCI Fast Ethernet Card (100Base-TX) M3906Z/A
  - PCI Ethernet Card (10Base2/10Base-T/AAUI) M4709Z/A
- 19-inch Rack Mount Accessory Kit M4036Z/A





- AIX Accessory Kit

AIX Accessory Kit, Version 4.1.4 M4525Z/A

AIX Accessory Kit, Version 4.1.4.1 M4525Z/B

AIX Accessory Kit, Version 4.1.5 M4525Z/C

AIX Update Kit, Version 4.1.4 to Version 4.1.4.1  
M5494Z/A

AIX Upgrade Kit, Unlimited User M4891Z/A

**Note:** Third-party manufacturers also offer a wide variety of products that can be installed to enhance the server.





## Service Strategy

Service the Network Server 500 and 700 Series through module exchange and parts replacement. Customers can request on-site service from an Apple Authorized Service Provider Plus (AASP+) or carry-in service from an AASP, or they can choose service from the Apple Assurance program.

### Ordering

Apple service providers planning to support the Network Server 500 and 700 Series may purchase Service modules and parts to develop servicing capability. To order parts, use the AppleOrder system or refer to the “Service Price Pages.”

Large businesses, universities, and K-12 accounts must





provide a purchase order on all transactions, including orders placed through the AppleOrder system. Service providers not enrolled in AppleOrder may fax their orders to Service Provider Support (512-908-8125) or mail them to

Apple Computer, Inc.  
Service Provider Support  
MS 212-SPS  
Austin, TX 78714-9125

If you have further questions, please call Service Provider Support at 800-919-2775 and select option #1.





## Warranty and AppleCare

Both the Network Server 500 Series and Network Server 700 Series are covered under the Apple One-Year Limited Warranty. The AppleCare Service Plan is also available for these systems. For part number and pricing information, refer to the AppleCare CPU “Service Price Pages.” Service providers are reimbursed for warranty and AppleCare repairs made to these systems.

## Diagnostics

Use the Network Server Diagnostic Utility on the Service Source companion disc (or on its own floppy disk) to test the new servers. Refer to the Troubleshooting chapter for more information on the Network Server Diagnostic Utility.







## Safety Issues

See Bulletins/Safety for general safety information.

## Skills and Tools

Knowledge of the AIX operating system and RAID technology is helpful. Familiarity with the Network Server Diagnostics Utility is a plus.

No additional tools are required for the Network Server 500 and 700 Series above and beyond what the service technician already has.





## Compatibility Issues

The following are compatibility issues associated with upgrading memory or installing PCI expansion cards for video, graphics applications, and networking and communications:

- The Network Server uses 72-bit-wide, 168-pin parity DRAM Dual Inline Memory Modules (DIMMs), which should be installed in matched pairs (for example, two 8 MB DIMMs). Your server's DIMMs are fast-paged mode, parity DRAM, with an access time of 60-nanoseconds or faster. Nonparity DIMMs with 70-nanosecond or faster access time DRAM will work; however, if there is any nonparity DRAM installed, all server parity checking is disabled.





- Some DIMMs and all Single Inline Memory Modules (SIMMs) from older Macintosh computers are not compatible. For more detailed information, see “Appendix B: DRAM Configurations” of “Setting up the Network Server.”
- The Network Server uses cards designed according to the Peripheral Component Interconnect (PCI) standard. Your server cannot accommodate NuBus cards, which were designed for older Macintosh computers.
- The combined power consumption of PCI expansion cards must not exceed the limits specified for the Network Server 500 and 700 Series.
- The Network Servers support only multisynchronous displays.
- The 8 mm tape drive can read from but not write to standard metal particle tapes. The tape heads must be cleaned after reading from a standard metal particle tape before an AME tape can be used.





## Setup and Operation

Refer to “Chapter 5: Starting Up Your Server” of “Setting up the Network Server” and “Chapter 3: System Startup, Logging In, Shutting Down, and Rebooting” of “Using AIX, AppleTalk Services and Macintosh OS Utilities on the Network Server” for information on how to

- Install AIX on the server
- Start up, log in, shut down, and restart the server
- Use AIX Windows and the Common Desktop Environment
- Use InfoExplorer
- Use system administration tools
- Set up AppleTalk and AppleTalk Services
- Use Disk Management Utility
- Access the server remotely with CommandShell

**Note:** You can find these manuals on the Service Source Companion CD.





## Turning the Server On

To turn on the server you must perform the following steps:

- Turn on the monitor.
- Turn on all the external devices.
- Turn the key in the rear drawer lock to the locked position.
- Turn the front lock key to the unlocked or locked position.
- Turn the server on by pressing the Power On button (next to the floppy drive).

The server will run the power-on self test and then clear the LCD display and display the ROM version and power supply status. During the startup process, messages will appear on the third line of the LCD display. Under normal circumstances, these messages will clear quickly, but if there is a startup problem, one of the messages may be displayed continuously.





## Shutting Down the Server

**Note:** You must have root privileges to shut down the server.

To shut down the server always use the Shutdown command as it is the safest and most thorough way to halt the server.

Log in to the server as root and enter `shutdown -F`

You can notify the users that the system is about to stop operations, terminate all existing processes, and unmount all filesystems by using the appropriate options provided in the Shutdown command. By default, the system waits one minute before stopping the user processes and the init process.





## Restarting the Server

You must have root privileges to restart the server. Use the command `shutdown -r` instead of the Reboot command when the system is running and other users are logged in.





## Front View

The following figure illustrates the front view of the Network Server 500 and 700 Series. Note that the monitor and keyboard must be purchased separately.





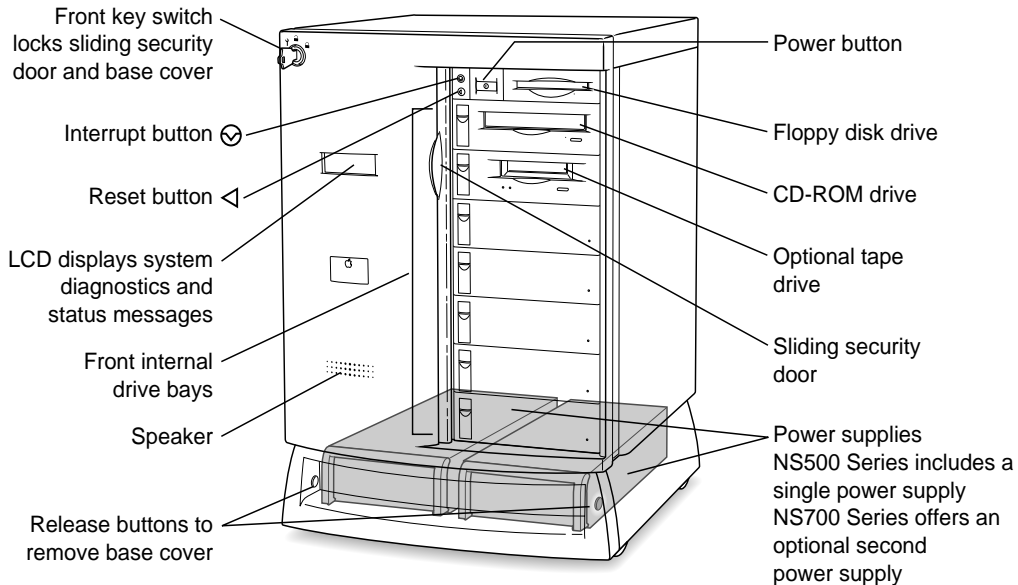

**Figure: Network Server 500 and 700 Series Front View**





## Back View

The Network Server 500 Series and Network Server 700 Series offer the following external ports: SCSI, AAUI Ethernet, serial printer, serial modem, Apple Desktop Bus (ADB), sound input, and sound output.

The figures on the next pages illustrate the rear panel of the Network Server 500 and 700 Series.



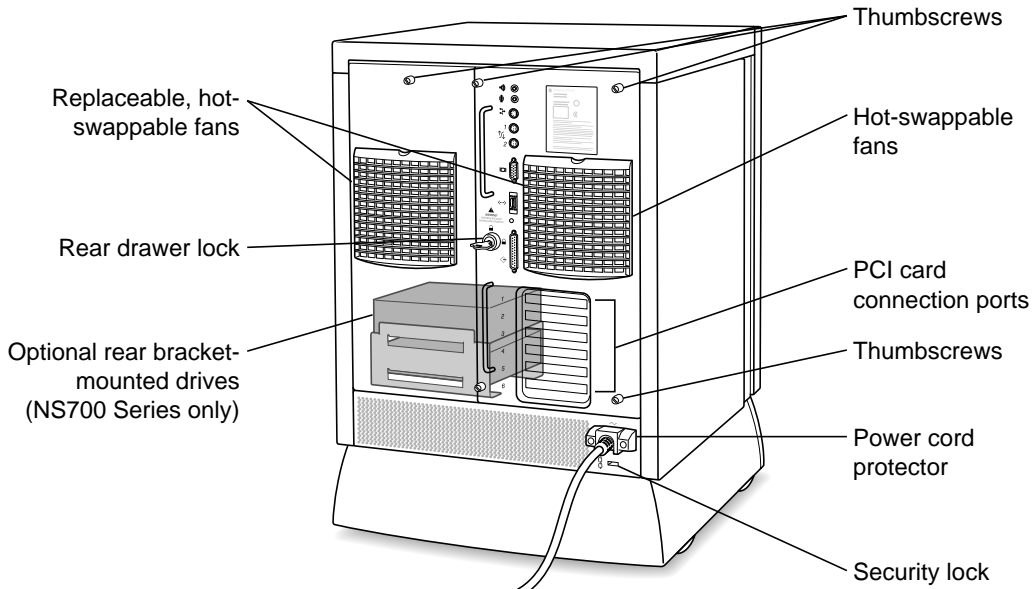

**Figure: Network Server 500 and 700 Series Back View**



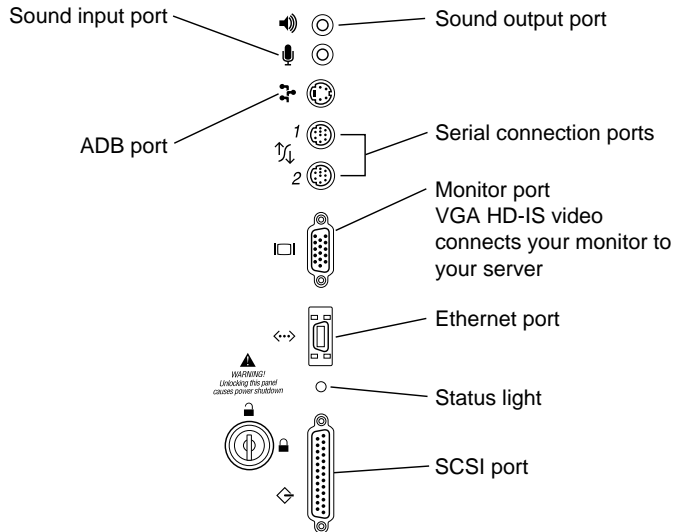

Figure: Network Server 500 and 700 Series Ports





## Logic Board

The following figure illustrates the connectors, battery holder, cache and DRAM DIMM sockets, PCI slots, processor card slot, Cuda reset button, and the power on/off button on the Network Server 500 and 700 Series logic board.



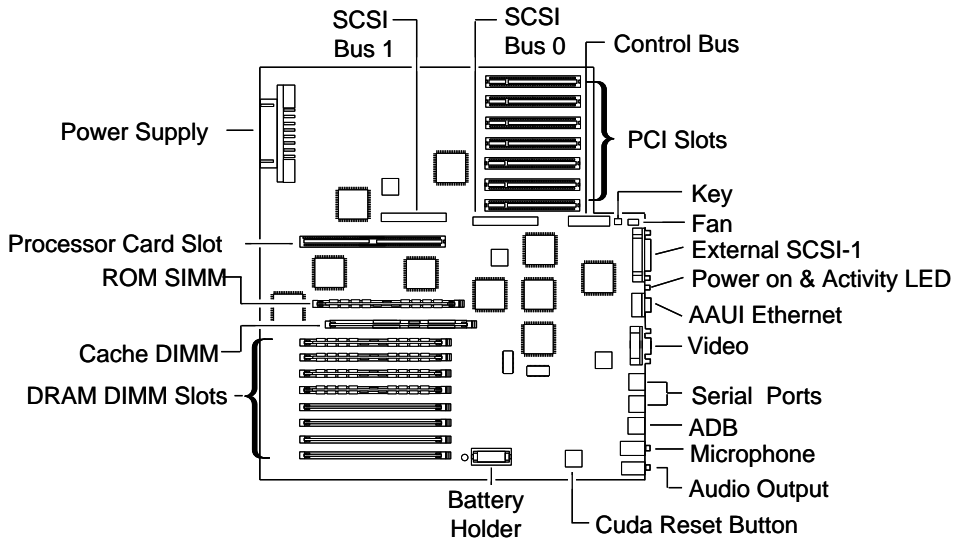

Figure: Network Server 500 and 700 Series Logic Board Connectors





## Overview of Core Technologies

This section provides information on core technologies built into the Network Server 500 and 700 Series.

### **PowerPC 604 and 604e Microprocessor**

The Network Server 500 Series and Network Server 700 Series are powered by a PowerPC 604 or 604e microprocessor. An implementation of the PowerPC family of RISC microprocessors, the PowerPC 604 or 604e uses RISC technology to deliver high performance at the lowest possible cost. Features include the following:

- Full RISC processing architecture
- 64-bit external data bus and a 32-bit address bus





- Five execution units that can operate in parallel (one load-store unit, three integer units, and one three-stage floating-point unit)
- Separate built-in caches for data and instructions, 16K each for the 604 and 32K each for the 604e
- Advanced branching techniques for improved throughput
- Advanced 3.3-volt CMOS process technology (fully compatible with TTL)
- Bus multiplier up to 3:1 for the 604 and up to 5:1 for the 604e

The PowerPC 604 and 604e microprocessor is installed by way of a processor card that plugs into the logic board, allowing for maximum flexibility for future upgrades. The Network Server 500 Series uses the 132-MHz version of the PowerPC 604 microprocessor and the Network Server 700 Series uses the 150 MHz or 200 MHz version.







## Memory Configurations

The Network Server 500 Series and Network Server 700 Series provide parity memory protection by using DRAM Dual Inline Memory Modules (DIMMs) with parity instead of DRAM Single Inline Memory Modules (SIMMs).

The server logic board has eight DRAM DIMM slots (each with a 64-bit wide data bus) that allow a maximum of 512 MB of main memory.

Although single DIMMs may be added, to take advantage of memory interleaving, the DIMMs should be installed in matched pairs (for example, two 16 MB DIMMs).

Memory interleaving allows the computer to read or write to its memory while other memory reads or writes are occurring, thus providing maximum performance.





**Important:** The parity DIMMs should be 72-bit-wide 168-pin fast-paged mode, 60-nanosecond (ns) RAM access time or faster. DRAM must support byte writes. SIMMs and some DIMMs from older Macintosh computers will not work in the Network Server. The parity DIMMS should be installed in matched pairs (for example, two 16 MB DIMMs, one in slot 1A, the other in slot 1B). Nonparity DRAM with 70-nanosecond DRAM access time or faster will work, however if there is any nonparity DRAM installed, all server parity checking is disabled.

**Important:** The SIMMs used in previous Macintosh models are NOT compatible with the Network Server 500 and 700 Series.



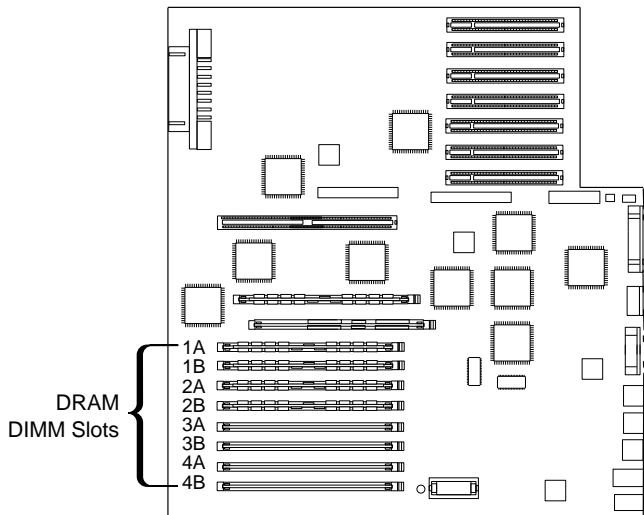

**Figure: Network Server 500 and 700 Series Memory Locations**





## Ethernet Support

The Network Server 500 Series and Network Server 700 Series come with a built-in Ethernet port (AAUI) for connecting to a high-speed Ethernet network. The AAUI connector supports the Apple Ethernet Network Cable System (which supports thicknet, thinnet, or 10BaseT cable systems). To connect the server to an Ethernet network, you must have one of the following Ethernet Media adapters (depending on the type of network cabling used):

- Apple Ethernet Thin Coax Transceiver
- Apple Ethernet Twisted-Pair Transceiver
- Apple Ethernet AUI Adapter

With the appropriate communications card and software, the server also can be connected to other network types.





## Peripheral Component Interconnect (PCI)

PCI (Peripheral Component Interconnect) is a high-performance architectural standard designed to eliminate bottlenecks between a computer's processor and its high bandwidth peripherals (such as video graphics and network components). The PCI Local Bus is a high-performance, 32-bit or 64-bit bus with multiplexed address and data lines. It is intended for use as an interconnect mechanism between highly integrated peripheral controller components, peripheral add-in boards, and the processor/memory systems.

The Network Server 500 Series and Network Server 700 Series provide six 64-bit, universal (5 volt + 3.3 volt) PCI expansion slots that are compliant with PCI 2.0 specifications.





The expansion slots can be used to install cards for video and graphics applications and for networking and communications purposes.

## The Cuda Chip

The Cuda is a microcontroller chip. Its function is to

- Turn on and off system power
- Manage system resets from various commands
- Maintain PRAM
- Manage the ADB
- Manage the real-time clock

Many system problems can be resolved by resetting the Cuda chip (see the Troubleshooting chapter for examples). Press the Cuda reset button on the logic board to reset the Cuda chip. (See the Logic Board Diagram earlier in this chapter to locate the Cuda reset button.)





If you continue to experience system problems after resetting the Cuda chip, refer to the following section “Resetting the Logic Board.”

## **Resetting the Logic Board**

Resetting the logic board can resolve many system problems (refer to the Troubleshooting chapter in this manual for examples).

Whenever you have a unit that fails to power up, you should follow this procedure before replacing any modules:

- 1 Unplug the computer.
- 2 Slide the rear drawer out. (Refer to the Take Apart chapter for more instructions.)





- 3 Using a small, flat-blade screwdriver, pry open the latch at the end of the battery holder, and lift off the battery holder cover.
- 4 Remove the battery from its holder.
- 5 Make sure that the unit is not connected to any external devices such as SCSI or serial port devices.
- 6 Wait at least 10 minutes before replacing the battery. Be sure the battery is installed in the correct positive/negative (+/-) direction.
- 7 Reassemble the computer and test the unit.

**Note:** This procedure resets the computer's parameter RAM (PRAM). Be sure to check the computer's time/date and other system parameter settings afterwards.







## Overview of New Technologies

This section discusses new technologies being introduced with the Network Server 500 and 700 Series.

### **AIX**

The Network Server 500 Series and Network Server 700 Series are designed to run IBM AIX. The Network Servers are shipped with the following software:

- AIX version 4.1.4 or 4.1.4.1 operating system
- AppleTalk and AppleTalk administration utilities.  
AppleTalk allows remotely connected Macintosh computers to access the AIX server without using TCP/IP or other networking protocols.





- Two symbiotic applications, Discus and CommandShell, created by Apple Computer, Inc., and engineered for use with AIX on the Network Server 500 and 700 Series. CommandShell is a terminal emulator that runs multiple windows on a system, while Discus is a disk-management system that allows users to manage all aspects of disk storage. Discus provides a graphical user interface and offers various views of disk-storage structure, as well as management commands.

**Note:** Applications that use a Macintosh interface for handling UNIX tasks are called “symbiotic applications.”





## SCSI IDs and Drive Termination

The Network Server 500 Series and Network Server 700 Series each include three separate SCSI buses: two internal SCSI buses and one external bus. The buses accommodate four, five, and seven SCSI devices, respectively. Thus, a total of 16 SCSI devices can be connected to the server without adding PCI cards. The internal buses handle the built-in startup hard drive, CD-ROM drive, tape drive, and up to four additional SCSI drives on the Network Server 500 Series and six on the Network Server 700 Series. The external bus accommodates up to seven external SCSI devices in a chain (such as hard drives, CD-ROM drives, scanners, printers, and tape-backup drives).





To make installing SCSI devices as straightforward as possible, and to reduce the potential for SCSI bus problems, the internal SCSI cable has built-in termination. Before installing a SCSI device, make sure that SCSI termination is disabled on the device. To disable the SCSI termination, refer to the installation manual of that device.

**Note:** The Fast/Wide SCSI-2 channels support only internal drives used in the Network Server 500 and 700 Series.

**Note:** The server automatically assigns SCSI ID numbers to internal drives as shown in the diagram on the next page.



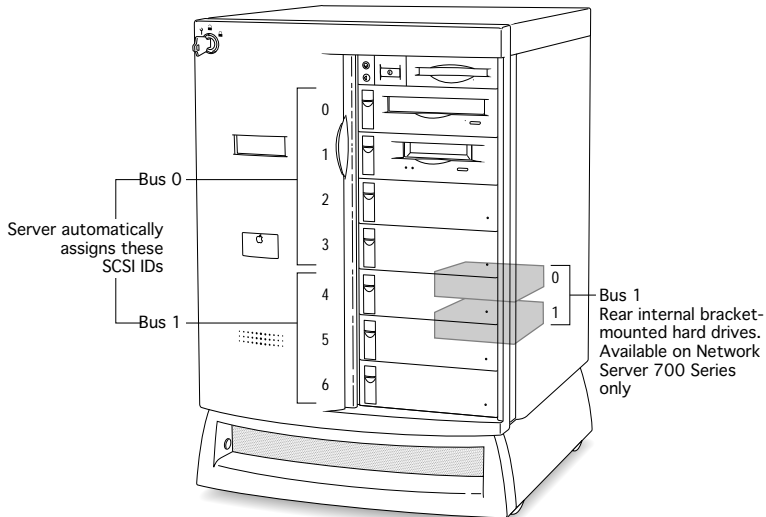

**Figure: Network Server 500 and 700 Series SCSI IDs**





## Fast/Wide SCSI

Designed to be I/O intensive, the Network Server 500 Series and Network Server 700 Series achieve enhanced data throughput by providing two Fast/Wide SCSI-2 channels that support internal devices. The internal SCSI buses on the Network Servers support transfer rates up to 40 MB/sec.

**Note:** The Fast/Wide SCSI-2 channels support only internal drives used in the Network Server 500 and 700 Series.





## Network Server PCI RAID Card

The Network Server 500 Series and Network Server 700 Series offer six PCI expansion slots each, but due to a limitation in the PCI Redundant Array of Independent Disks (RAID) implementation, only four Network Server PCI RAID cards can be installed in a single Network Server 500 or 700 Series computer.

The first or a single PCI RAID card is designed to be connected to the server's two internal SCSI-2 buses. In that case, the two SCSI-2 controller chips on the logic board are disabled and all internal SCSI devices (for example, hard drives, CD-ROM, DAT tapes, and so on) are controlled by the controller on the PCI RAID card.

Any other RAID card(s) in the system will provide external Fast/Wide SCSI-2 connectors for connection of external SCSI disk arrays.





## Hot-Swappable Drives

The Network Server 500 and Network Server 700 contain a flexible SCSI backplane that allows the physical hot-swapping and hot-removal of SCSI wide and narrow devices. This ability to gracefully handle the logical addition and removal of drives is operating-system dependent. The optional Network Server PCI RAID Card allows the AIX operating system to be buffered from the logical consequences of drive addition and removal when setup in a RAID configuration. Hence, hot plug and removal is only recommended for RAID configurations.

**Note:** An optional PCI RAID card must be installed to ensure that data will not be lost when drives are hot-swapped.







## Hot-Swappable, Redundant Power Supplies

The Network Server 700 Series has two bays for two power supplies. Although the server is shipped with only one power supply installed in the left bay, when a second power supply is installed in the other bay (right), the server power supplies become hot-swappable. When one of the installed power supplies fails, its LED will turn off. The failed power supply can then be replaced without shutting down the server. (A message will display on the LCD indicating that it is safe to shutdown the server.)

**Note:** Hot-swappable, redundant power supplies are not available for the Network Server 500 Series.





## Display and Diagnostics

On startup, the server executes the power-on self test, and then displays the ROM version and copyright information on the LCD. It then starts a series of tests, during which the ROM version and the parity DRAM size remain on the display.

During the test phase of the startup process, the server displays startup progress messages on the LCD display. Table 1 lists the progress messages along with the system module(s) in use.



**Table 1: Progress Messages**

<b>Message</b>	<b>LCD Line</b>	<b>System Module(s) in Use</b>
DRAM test #1 Begins	3	DIMMs, logic board
ROM SIMM Test Begins	3	ROM SIMM, logic board, processor card
DRAM test #2 Begins	3	DIMMS, logic board, processor card
LONG DRAM test Begins	3	DIMMS, logic board, processor card



**Table 1: Progress Messages (Continued)**

<b>Message</b>	<b>LCD Line</b>	<b>System Module(s) in Use</b>
Turning on Caches	3	Cache DIMM, processor card, logic board
Jumping to RAM Prog	3	DIMMS, logic board
Testing Parity DIMMs	3	DIMMs, logic board
MainLBU Enet Setup	3	Logic board
Sounding Boot Beep	3	Logic board
Sizing RAM DIMMs	3	DIMMs
ROM SIMM Data Access	3	ROM SIMM



**Table 1: Progress Messages (Continued)**

<b>Message</b>	<b>LCD Line</b>	<b>System Module(s) in Use</b>
Allocating RAM DIMMs	3	DIMMS, logic board, processor card
MainLBUNVRAM Setup	3	Processor card, logic board
CPU Card Info Setup	3	Processor card, logic board
L2 Cache SIMM Setup	3	L2Cache SIMM, processor card, logic board
Testing L2 Cache SIMM	3	L2Cache SIMM, processor card, logic board



**Table 1: Progress Messages (Continued)**

<b>Message</b>	<b>LCD Line</b>	<b>System Module(s) in Use</b>
RAM/ROM/NVRAM: PASSED	3	

If the server stops (“freezes” or “hangs”) with one of the progress messages displayed, the information indicated may be used to identify the module(s) in use. The module(s) might have failed, be incorrectly installed, or be incompatible.





After all the tests are complete, the LCD will display something similar to this:

```
ROM ver.1.1.20.1  
0048 MB Parity DRAM  
150 MHz 604, 50 MHz Bus  
1024 KB Level 2 Cache
```

If the server is unable to load the operating system from a CD or hard drive, a problem may have been found during startup. Problem messages displayed by the server are listed in Table 2.

**Note:** The module(s) identified in the problem message might have failed, be incorrectly installed, or be incompatible.



**Table 2: Problem Messages**

<b>Message</b>	<b>LCD Line</b>	<b>Module(s)</b>
L2 Cache SIMM Failed	1	
ROM SIMM Failed	1	
MainLBUNVRAM Failed	1	Located on logic board.
RAM DIMM 1A failed at Address xxxxxxxx	1	RAM DIMMS identified as 1A-4A and 1B-4B. Addresses are in hexadecimal.





**Table 2: Problem Messages (Continued)**

<b>Message</b>	<b>LCD Line</b>	<b>Module(s)</b>
MainLBUVideo ID Bad	1	Video subsystem is located on logic board.
MainLBU825#1 Failed	1	SCSI controller #1 is located on logic board.
MainLBU825#2 Failed	1	SCSI controller #2 is located on logic board.
Drive Fan Failed!	1	Fan on right when facing rear of server unit.



**Table 2: Problem Messages (Continued)**

<b>Message</b>	<b>LCD Line</b>	<b>Module(s)</b>
Processor Fan Failed	1	Fan on left when facing server unit.
Temperature Too Hot!	1	Internal cabinet is unsafe. Shut down system immediately.
Temperature Warning!	1	Internal cabinet temperature is becoming unsafe.
Left Power Fail!	1	Power supply on left when facing front of server unit.



**Table 2: Problem Messages (Continued)**

<b>Message</b>	<b>LCD Line</b>	<b>Module(s)</b>
Right Power Fail!	1	Power supply on right when facing front of server unit (Network Server 700 Series only).
Left Power Hot!	1	Power supply on left when facing front of server unit.
Right Power Hot!	1	Power supply on right when facing front of server unit (Network Server 700 Series only).
CudaNotResponding!!!	1	Logic board.



**Table 2: Problem Messages (Continued)**

<b>Message</b>	<b>LCD Line</b>	<b>Module(s)</b>
ParityAddrAtAddrFail	1	Logic board.

During long memory test, the server provides additional information by placing consecutive dashes on line 4 of the LCD display. Should the system freeze during the long memory test, use the dash count to identify the DIMM last tested. Table 3 lists the dash count and the DIMM slot tested.



**Table 3: DIMM Slot Testing**

<b>Number of Dashes Displayed</b>	<b>DIMM Slot</b>
1	Main board logic unit DRAM (reserved for future use)
2	Main board logic unit DRAM (reserved for future use)
3	1A
4	1B
5	1A
6	1B
7	2A



**Table 3: DIMM Slot Testing (Continued)**

<b>Number of Dashes Displayed</b>	<b>DIMM Slot</b>
8	2B
9	2A
10	2B
11	3A
12	3B
13	3A
14	3B
15	4A
16	4B



**Table 3: DIMM Slot Testing (Continued)**

<b>Number of Dashes Displayed</b>	<b>DIMM Slot</b>
17	4A
18	4B





## Configuring the SCSI ID Cable

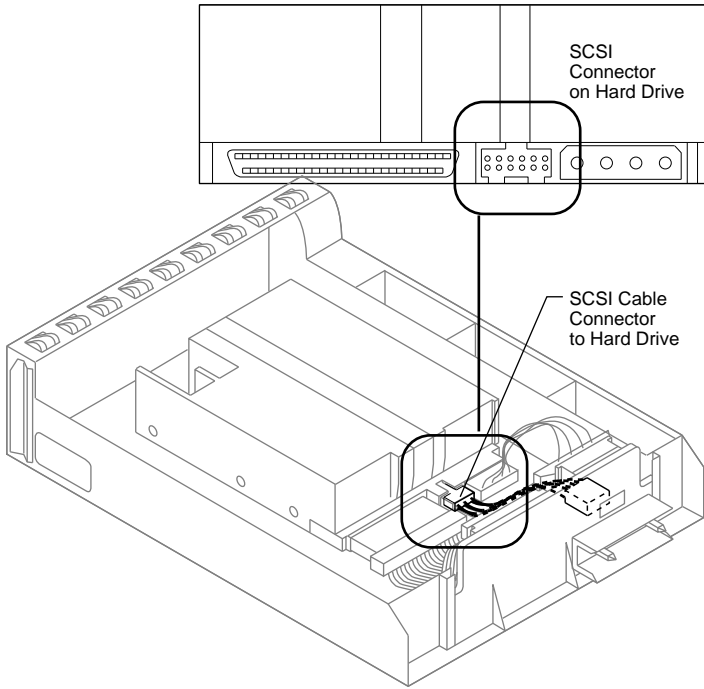

When you install a drive in a drive carrier, the way you connect the SCSI ID cable to the drive depends on which type of drive you're installing. This section describes how to connect the SCSI ID cable for the 2 gigabyte (GB) and 4 GB IBM and Seagate hard drives, which are provided by Apple for the Network Server 500 and 700 Series. If you install a Quantum drive or other drive with an active high LED signal, you need to rewire the SCSI cable as described later in this section.

The figure on this page shows the location of the SCSI ID cable.







## Connecting IBM and Seagate Drives (2, 4, and 9 GB)

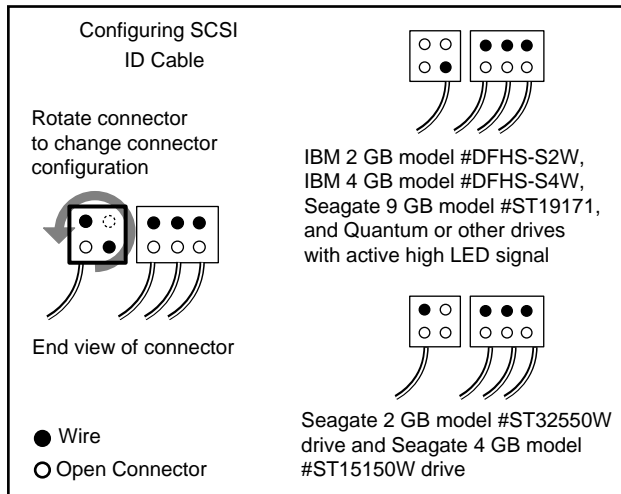

The IBM and Seagate drives (2, 4, and 9 GB) use a Type 1 cable. This cable connects to the drive board at the back of the drive tray and to the SCSI connector on the hard drive. The Type 1 SCSI cable includes a six-pin connector and a four-pin connector. Check which kind of drive you have, then connect the cable to the drive according to the figure on this page.





## Rewiring Quantum Drives and Drives with Active High LEDs

To install a Quantum drive or other drive with an active high LED, you must remove the wire that connects to pin 3 on the drive tray connector, then insert the wire at pin 1. After you rewire the SCSI ID cable, connect the cable to the drive.

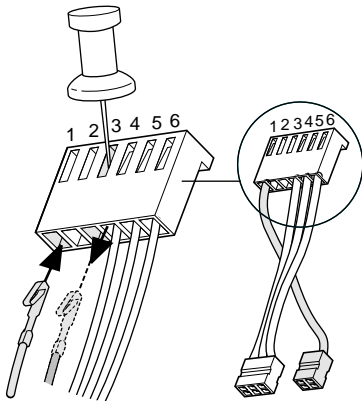



# SCSI ID Cable Connector Matrix

The SCSI ID Cable Matrix on this page shows the different kinds of SCSI ID connectors used in the Network Server 500 and 700 Series. You must use the correct “type” cable with each drive listed.

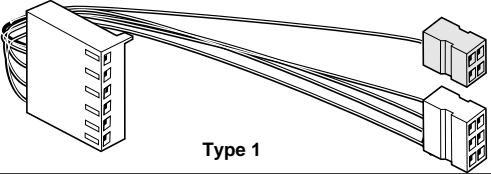
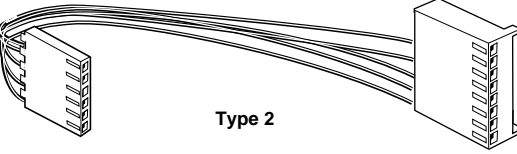
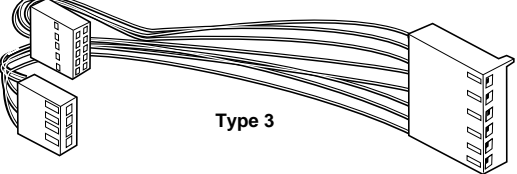
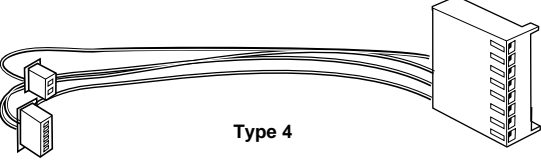
SCSI Drive Cables Connectors	Drives
 <p data-bbox="280 421 342 446">Type 1</p>	2, 4, and 9 GB Hard Drives and 8mm Tape Drive
 <p data-bbox="280 581 342 606">Type 2</p>	DAT Drive
 <p data-bbox="280 755 342 780">Type 3</p>	CD-ROM Drives
 <p data-bbox="280 962 342 987">Type 4</p>	1.2 GB Hard Drive





## Keylock Positions

The figure on this page shows the three different keylock positions (service, unlocked, and locked) used in the Network Server 500 and 700 Series. It also indicates the modules that may be accessed from each position.

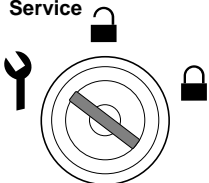
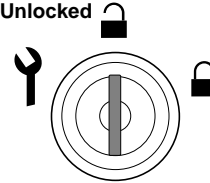
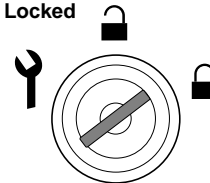
<b>Left Position: Service</b> 	<b>Upright Position: Unlocked</b> 	<b>Right Position: Locked</b> 
<b>Access Available:</b>		
<ul style="list-style-type: none"><li>• Front Door</li><li>• Base Door</li><li>• Power Supply</li><li>• Top Shelf</li><li>• Bottom Shelf</li></ul>	<ul style="list-style-type: none"><li>• Front Door</li><li>• Base Door</li><li>• Rear Drawer</li><li>• Power Supply</li><li>• Front Bezel Assembly</li><li>• Top Shelf</li><li>• Bottom Shelf</li></ul>	<ul style="list-style-type: none"><li>• Drive Trays ( If the front door is positioned properly)</li></ul>





## Specifications

---

Network Server 500 and  
700 Series



# Processor

## CPU

**Network Server 500/  
132**

PowerPC 604 RISC microprocessor running at 132 MHz  
Built-in FPU  
32 KB of on-chip cache  
Requires AIX version 4.1.4 or higher

**Network Server 700/  
150**

PowerPC 604 RISC microprocessor running at 150 MHz  
Built-in FPU  
32 KB of on-chip cache  
Requires AIX version 4.1.4 or higher

**Network Server 700/  
200**

PowerPC 604e RISC microprocessor running at 200 MHz  
Built-in FPU  
64 KB of on-chip cache  
Requires AIX version 4.1.4.1 or higher recommended





## Memory

<b>DRAM</b>	Uses 168-pin, 72-bit, 60 ns (parity) or 70ns (non-parity) DRAM DIMMs
<b>Network Server 500/132</b>	32 MB standard expandable to 512 MB
<b>Network Server 700 Series</b>	48 MB standard expandable to 512 MB
<b>ROM</b>	4 MB ROM
<b>Clock/Calendar</b>	CMOS custom circuitry with long-life lithium battery





# Memory

## Cache

<b>Network Server 500/ 132</b>	512 KB of Level 2 cache
<b>Network Server 700 Series</b>	1 MB of Level 2 cache







## I/O Interfaces

### SCSI

**Network Server 500/  
132**

Two Fast/Wide SCSI-2 channels (which support internal devices) and one SCSI-1 channel (which supports external devices).

A total of 14 SCSI devices (seven internal and seven external) can be connected to the server without adding additional PCI cards.

**Network Server 700  
Series**

A total of 16 SCSI devices (nine internal and seven external) can be connected to the server without adding additional PCI cards.

### Serial

Two RS-232/RS-422 serial ports compatible with LocalTalk and GeoPort cables; mini DIN-8 connectors

### ADB

One Apple Desktop Bus port for a keyboard, mouse, or a three-button mouse.



## I/O Interfaces

### **Ethernet**

Built-in Ethernet (AAUI port)

### **Video**

SuperVGA (SVGA) port requires an HDI-15 cable.

### **PCI**

Six PCI expansion slots, compatible with all PCI 2.0 specifications-compliant cards (not NuBus-compatible)





## Sound and Video

### Sound

16-bit stereo sound input and output ports.

### Video

Built-in 1024 x 768, 800 x 600, 640 x 480 video support for 14-inch, 15-inch, 17-inch, and 20-inch monitors.

The following table shows the image size for monitors connected to the monitor port, along with the number of colors or grays supported:



**Video**

<b>Hz</b>	<b>Resolution</b>	<b>Colors or Grays</b>
60	640 x 480	256
70	640 x 480	256
72	640 x 480	256
60	800 x 600	256
72	800 x 600	256
75	800 x 600	256
60	1024 x 768	256
72	1024 x 768	256
75	1024 x 768	256



## I/O Devices

### **Keyboard**

Supports Apple ADB keyboards (AIX requires an extended keyboard for installation)

### **Mouse**

Supports all models of the Apple ADB





## Disk Storage

<b>Hard Drive</b>	1.2, 2, 4, or 9 GB Fast/Wide SCSI internal hard drives
<b>Floppy Drive</b>	One Apple SuperDrive 1.4 MB floppy drive
<b>CD-ROM Drive</b>	
<b>Network Server 500/ 700 Series</b>	One internal AppleCD 600i 4X-speed CD-ROM drive
<b>Network Server 700 Series</b>	One internal AppleCD 1200i 8X-speed CD-ROM drive
<b>DDS-2 DAT Drive</b>	Optional 3.5-inch DDS-2 DAT drive





## **8 mm Tape Drive**

### **Data capacity**

Optional 8 mm tape drive

22 meter tape: 5 GB compressed, 2.5 GB uncompressed

170 meter tape: 40 GB compressed, 20 GB uncompressed

### **Maximum data transfer rate**

6 MB/sec compressed, 3 MB/sec uncompressed

### **Tape compatibility**

Advanced metal evaporated (AME) tapes

Note: The 8 mm tape drive can read from but not write to standard metal particle tapes. The tape heads must be cleaned after reading from a standard metal particle tape before an AME tape can be used.





## Electrical

<b>Line Voltage</b>	100–240 V AC, RMS single phase (automatically configured)
<b>Frequency</b>	50–60 Hz, single phase
<b>Maximum Power</b>	AC Power: 708W maximum (not including monitor)
<b>Power Supply</b>	
<b>Network Server 500/132</b>	Single, 325 W
<b>Network Server 700 Series</b>	One or two 425 W, hot-swappable, supply(ies)







<b>Current Type</b>	<b>Network Server 500 Series</b>	<b>Network Server 700 Series</b>
+3.3 V*	25.0 A	50.0 A
+5 V*	28.0 A	44.0 A
	+12 V	2.0 A
+12 V (normal)	11.0 A	13.0 A
+12 V (start up)	18.0 A (12 seconds maximum)	
-12 V	100 mA	100 mA

\*+3.3 and +5.5 power outputs are traded off; total power for both not to exceed 180 watts for the LE, 260 watts for the HE





## Power Requirements

### Apple Desktop Bus

Maximum power draw for all ADB devices: 500 milliamperere (mA)

Apple mouse draws up to 10 mA

Keyboard draws 25–80 mA (varies with keyboard model used)

**Note:** It is recommended that you connect no more than three ADB devices to the Network Server.

### Expansion Cards and Devices

If you add a PCI expansion card, or an internal SCSI device to your server, make sure the component doesn't exceed its maximum power allowance from the different voltage sources. Note that no single PCI card should exceed the 25 watt limit of the PCI Revision 2.1 specification. Follow the guidelines outlined in the following table:





<b>Network Server Model</b>	<b>Voltage</b>	<b>Current</b>	<b>Total Power</b>
Network Server 500/132	+3.3 V	10.0 A	Not to exceed 50.0 +5 V10.0 A watts in any combination
	+5 V	10.0 A	
	+12 V	2.0 A	
Network Server 700 Series	+3.3 V	18.0 A	Not to exceed 90.0 watts in any combination
	+5 V	18.0 A	
	+12 V	2.0 A	

For SCSI devices, the average (thermal) power consumption per





drive bay is 1.1 amps at +5 volts and 1.3 amps at +12 volts. Apple recommends that drives be configured for spin-up on command.



## Physical

### **Dimensions**

Height: 24.5 inch

Width: 16.5 inch

Depth: 18 inch

### **Weight**

84–92 lb. (exact weight varies depending on number and type of internal SCSI devices installed)



## Environmental

**Operating  
Temperature**

50° to 95° F (10° to 35° C)

**Storage  
Temperature**

-40° to 116.6° F (-40° to 47° C)

**Relative Humidity**

20% to 80% noncondensing

**Maximum Altitude**

10,000 ft. (3,048 meters)





## Troubleshooting

---

Network Server 500 and  
700 Series





## General

The Symptom Charts included in this chapter will help you diagnose specific symptoms related to your product. Because cures are listed on the charts in the order of most likely solution, try the first cure first. Verify whether or not the product continues to exhibit the symptom. If the symptom persists, try the next cure. (Note: If you have replaced a module, reinstall the original module before you proceed to the next cure.)

If you are not sure what the problem is, or if the Symptom Charts do not resolve the problem, refer to the Flowchart for the product family.

For additional assistance, contact Apple Technical Support.







## Cleaning Procedure for Card Connectors

A small number of cards for the Network Server may contain residue on the gold edge connector pins, which may cause a variety of intermittent symptoms.

To correct the problem, inspect the connector pins with a magnifying glass. If you find residue, use a pencil eraser to gently clean the pins.





# Symptom Charts

## Power

System does not power up, screen is blank, fan is not running, power LED is not lit

- 1 Verify that system is properly connected to a power source:
  - Check for the presence of power cable.
  - If the server is plugged into a power strip, verify that the power strip is turned on.
  - Check power cable connection. It should be firmly connected to the server and the power source.
  - Plug the monitor directly into wall socket and then verify that the monitor has power.
- 2 Verify that key in rear drawer is in horizontal (locked) position.
- 3 Verify that power supply is installed and properly seated.
- 4 Verify that power LED is on.
- 5 Verify that rear drawer is properly installed.
- 6 Verify that toggle bolts on rear of logic board are fully





- tightened.
- 7 Check to see if server frame is bent slightly, preventing micro switch in rear of server from making contact. (Note: When facing rear of network server, micro switch is located near lower left edge of logic board face plate. There is a plastic protrusion that inserts into a slot in the chassis. The micro switch is visible through the grill.)
  - 8 Verify that metal ground strip is properly installed on logic board.
  - 9 Reseat processor card.
  - 10 Reseat other PCI cards.
  - 11 Reseat cache DIMM.
  - 12 Verify that all DRAM DIMMs are properly installed. Remove all DRAM DIMMs and replace them one at a time to test. Replace any bad DIMMs.
  - 13 Plug in keyboard and press power-on switch on keyboard. If system does not power on, replace power supply. If system does power on, try turning off system from front panel





- switch. If machine does not power down, replace NMI reset switch cable.
- 14 Reset Cuda chip. (Refer to “The Cuda Chip” in Basics chapter for instructions.)
  - 15 Reseat logic board and make sure logic board interconnect is making fully connection.
  - 16 Reset logic board. (Refer to “Resetting the Logic Board” in Basics chapter for instructions.)
  - 17 Replace power cord.
  - 18 Replace rear micro switch.
  - 19 Replace power supply.
  - 20 Replace on/off switch.
  - 21 Replace front keyswitch.
  - 22 Replace powerplane interconnect board.
  - 23 Replace logic board. Retain customer’s DIMMs.





## Startup

Cannot boot system  
from hard drive

- 1 Verify system software is installed on the hard drive. If not, refer to “Using AIX, AppleTalk Services, and Mac OS Utilities on the Network Server” for information about installing and using the operating system.
- 2 Verify that the server successfully booted from this hard drive before. If not, refer to “Using AIX, AppleTalk Services, and Mac OS Utilities on the Network Server” for information about installing and using the operating system.
- 3 Using Open Firmware, verify system startup path is configured for the correct hard drive.
- 4 If a problem message is displayed on the LCD during the startup process, refer to “LCD Panel and Diagnostics” in Basics chapter to determine the problem component.





- 5 If a three-digit error code is displayed on the LCD, refer to “Chapter 10: Troubleshooting” of “Using AIX, AppleTalk Services, and Mac OS Utilities on the Network Server” for information on error codes and recommended action.
- 6 Run Network Server Diagnostic Utility and follow the instructions provided with the utility to verify core system operations.
- 7 If the internal rear hard drive is the boot drive (Network Server 700 Series only), verify that the hard drives are properly connected and terminated. If the server does not boot,
  - Replace the rear drives SCSI cable
  - Replace the rear drives SCSI ID Cable
  - Replace the rear drives power cable
  - Replace the power backplane-to-SCSI backplane cable
  - Replace SCSI backplane
  - Replace power backplane
  - Replace hard drive





- 8 If the boot drive is in the front drive bay, move the hard drive to another front drive bay slot and try starting up the server. **Note:** You may have to reconfigure the system startup path using Open Firmware. If the server does not boot,
  - Replace the 68-pin SCSI hard drive cable
  - Replace SCSI ID cable
  - Replace hard drive power cable
  - Replace SCSI backplane
  - Replace hard drive
- 9 Replace logic board. Retain customer's DIMMs.
- 10 Replace processor card.

Long DRAM test never completes

Verify that each DRAM DIMM is properly seated.





System will not boot and a memory failure is indicated on lines 1 and 2 of the LCD with ECCBEBAD as the failed address

Verify DIMM specifications. ECC memory DIMMs with non-quad CAS logic are not supported.

Server does not beep at startup or when “beep” command is issued in AIX

Disable ROM checksum in Power-On-Self-Test (POST).

**Note:** For details, see Technical Information Library, article number 19814, “Network Server 500 or 700 No Sound at Startup or in AIX.”







## System

Clicking, chirping,  
or thumping

**Note:** Noises may not necessarily require a replacement of component. For example, a noisy fan may be more annoying than a cause of concern.

- 1 Verify that fan unit(s) is not loose. Replace if necessary. Fan unit(s) is hot-swappable and can be replaced without shutting down server.
- 2 Verify that power supply is properly seated. Replace if necessary. Network Server 700 Series power supply is hot-swappable and may be replaced without shutting down server.
- 3 Verify that all front drive trays are completely inserted.
- 4 Check hard drive(s). Replace if necessary.
- 5 Check DAT drive. Replace if necessary.
- 6 Check floppy drive. Replace if necessary.
- 7 Replace logic board. Retain customer's DIMMs.
- 8 Replace processor card.





System shuts down  
intermittently

- 1 Verify that power cord is firmly plugged in.
- 2 Verify that fans are working. Replace if necessary.
- 3 Verify that all front drive trays are completely inserted. Improper installation may disrupt air flow.
- 4 Verify that air vents are clear. Thermal-protection circuit may shut down system. After 30 – 40 minutes, system should be OK.
- 5 Run Network Server Diagnostic Utility and follow the instructions provided with the utility to verify core system operations.
- 6 Check battery.
- 7 Reset Cuda chip. (Refer to “The Cuda Chip” in Basics chapter for instructions.)
- 8 Reset logic board. (Refer to “Resetting the Logic Board” in Basics chapter for instructions.)
- 9 Replace power cord.
- 10 Replace power supply.
- 11 Replace powerplane interconnect board.





System  
intermittently  
crashes or hangs

- 12 Replace logic board. Retain customer's DIMMs.
  - 13 Replace processor card.
- 
- 1 Verify that power cord is firmly connected.
  - 2 Verify that power supply is properly seated.
  - 3 Verify that rear drawer is properly seated.
  - 4 Verify that all front drive trays are properly seated.
  - 5 Verify system software is version 4.1.4 or later. (Refer to "Using AIX, AppleTalk Services, and Mac OS Utilities on the Network Server" for information on installing and using the operating system).
  - 6 Run Network Server Diagnostic Utility and follow the instructions provided with the utility to verify core system operations.
  - 7 Verify that system is using fast-paged mode, 60ns or faster RAM access time DIMMs.
  - 8 Reseat processor card.
  - 9 Reseat cache DIMM.





- 10 Remove all DRAM DIMMs and replace them one at a time to test. Replace any bad DIMMs.
- 11 Remove all PCI cards and test unit. If problem does not occur with cards removed, replace them one at a time to determine which card is causing the problem. Replace problem card with known-good card.
- 12 Replace logic board. Retain customer's DIMMs.
- 13 Replace processor card.

#### System is inactive

- 1 Verify that power LED is on.
- 2 Check for three-digit error code on LCD panel. If display is not blank, refer to "Chapter 10: Troubleshooting" in "Using AIX, AppleTalk Services, and Mac OS Utilities on the Network Server" for possible error codes and recommended actions.
- 3 Verify that all cables are properly connected and secure.
- 4 Adjust brightness on monitor.
- 5 Use Control-D or Control-C to cancel any stalled processes.





- 6 Verify that key in rear drawer is in horizontal (locked) position.
- 7 Restart system.
- 8 Run Network Server Diagnostic Utility and follow the instructions provided with the utility to verify core system operations.

Three-digit error code is displayed on LCD panel during startup process

For possible error codes and recommended actions, refer to “Chapter 10: Troubleshooting” of “Using AIX, AppleTalk Services, and Mac OS Utilities on the Network Server.”





## Video

Screen is black,  
drive operates, and  
fan is running

- 1 Verify that the monitor is a SVGA or Multiple Scan model.
- 2 If the system is using a video extender cable, verify that it is rated for use with Multiple Scan monitors.
- 3 Adjust brightness on monitor.
- 4 Verify that monitor cable is firmly attached to both the monitor and server.
- 5 Verify that the system is configured to connect to a serial terminal. (For information on how to connect the Network Server to a serial terminal refer to “Connecting a serial terminal” in Chapter 3 of “Setting Up the Network Server.”)
- 6 Run Network Server Diagnostic Utility and follow the instructions provided with the utility to verify core system operations.
- 7 Reset Cuda chip. (Refer to “The Cuda Chip” in Basics chapter for instructions.)





- 8 Reset logic board. (Refer to “Resetting the Logic Board” in Basics chapter for instructions.)
- 9 Test with known-good monitor. Replace monitor if necessary. Refer to appropriate monitor manual to troubleshoot defective monitor.
- 10 Replace monitor cable.
- 11 Replace logic board. Retain customer’s DIMMs.
- 12 Replace processor card.

Screen lights up, but nothing is displayed on screen

- 1 Verify that the monitor is a SVGA or Multiple Scan model.
- 2 If the system is using a video extender cable, verify that it is rated for use with Multiple Scan monitors.
- 3 Reset Cuda chip. (Refer to “The Cuda Chip” in Basics chapter for instructions.)
- 4 Reset logic board. (Refer to “Resetting the Logic Board” in Basics chapter for instructions.)





- 5 Test with known-good monitor. Replace monitor if necessary. Refer to appropriate monitor manual to troubleshoot defective monitor.
- 6 Run Network Server Diagnostic Utility and follow the instructions provided with the utility to verify core system operations.
- 7 Replace monitor cable.
- 8 Replace logic board. Retain customer's DIMMs.
- 9 Replace processor card.

Screen has white area with blotches of color

- 1 Move unit to another location.
- 2 Degauss display with manual degaussing coil. (Degaussing coil can be purchased at most major electronic parts stores.)

Size of text/graphics differs at top, bottom, or sides of screen

- 1 Replace monitor cable.
- 2 Replace monitor.







Out of focus	<ol style="list-style-type: none"><li>1 Perform focus adjustment.</li><li>2 Replace monitor.</li></ol>
Black screen spots	Replace monitor.
Screen jitters or flashes	<ol style="list-style-type: none"><li>1 Verify that the monitor is a SVGA or Multiple Scan model.</li><li>2 If the system is using a video extender cable, verify that it is rated for use with Multiple Scan monitors.</li><li>3 Verify that monitor cable is firmly attached to both monitor and server.</li><li>4 Check for external interference.</li><li>5 Replace monitor.</li></ol>
Objects on screen appear too large or distorted	Adjust display resolution. (Refer to “Chapter 10: Troubleshooting” in “Using AIX, AppleTalk Services, and Mac OS Utilities on the Network Server.”)





## SCSI Devices General

Server does not recognize SCSI device(s)

**Note:** When troubleshooting SCSI devices, use this procedure to display information regarding which SCSI devices are currently recognized by the server.

**Note:** You may either use the Network Server Diagnostic Utility or Open Firmware to determine which SCSI devices are installed.

- 1 Turn the front key to the upright (unlocked) position.
- 2 Turn on the server. If the server is already powered on, press the reset button. If AIX is running, shut down the system by executing the `shutdown -r` command.
- 3 While the system is resetting (or starting up), hold down the Command-Option-OF keys until the `O>` prompt appears.
- 4 To use Network Server Diagnostic Utility insert the utility disk into the floppy drive and enter the command `boot fd:diags`. Follow the instructions provided with the utility for verifying SCSI devices are installed.





- 5 To use Open Firmware enter the login command at the 0> prompt and then enter password at the OF Password prompt. Enter the appropriate probe-scsi command. For example,
  - `probe-scsi0` to display the devices on the built-in external SCSI bus
  - `probe-scsi1` to display devices on the first internal SCSI bus
  - `probe-scsi2` to display devices on the second internal SCSI bus
- 6 System displays the SCSI ID, logical unit, device type, manufacturer, model, and firmware version of SCSI devices it recognizes on the SCSI bus.
- 7 If you do not see SCSI ID of problem device, check device for proper SCSI termination, SCSI ID, and cable connection. (Refer to “Setting Up Your Server and Connecting External Devices” chapter in “Setting Up the Network Server” for more information.)





## Hard Drive

Single internal hard drive in front drive bay doesn't operate; drive doesn't spin

- 1 Verify that hard drive tray is completely inserted in the front drive bay.
- 2 Verify that server is recognizing the drive on SCSI bus. (Refer to the section “SCSI Devices General” previously in this chapter.)
- 3 Verify that installed SCSI devices and PCI cards are not exceeding maximum power allowance. This may affect operation of installed devices.
- 4 Run Network Server Diagnostic Utility and follow the instructions provided with the utility to verify core system operations.
- 5 Move the hard drive to another front drive bay slot.
- 6 Verify that hard drive SCSI cable, SCSI ID cable, LED cable, and power cable are properly connected.
- 7 Replace hard drive power cable.
- 8 Replace hard drive SCSI cable.





- 9 Replace hard drive SCSI ID cable.
- 10 Replace hard drive. (Refer to “Setting Up the Network Server” for information on installing disk drives.)
- 11 Replace SCSI backplane interconnect board.

Single internal hard drive in the rear drive bracket doesn't operate; drive doesn't spin

**Note:** This procedure applies only to Network Server 700 Series.

- 1 Verify that server is recognizing the internal rear hard drive on SCSI bus. (Refer to the section “SCSI Devices General” previously in this chapter.)
- 2 Verify that installed SCSI devices and PCI cards are not exceeding maximum power allowance. This may affect operation of installed devices.
- 3 Run Network Server Diagnostic Utility and follow the instructions provided with the utility to verify core system operations.





- 4 Verify that internal rear hard drive SCSI cable, SCSI ID cable, and power cable are properly connected.
- 5 Verify that the last bracket-mounted drive on the SCSI cable has termination enabled.
- 6 If the rear drive bracket contains just one hard drive, verify that it is connected to the last connector on the SCSI cable.
- 7 If the rear drive bracket contains two hard drives, verify that the SCSI ID cable and the last connector on the SCSI cable are both connected to the bottom hard drive.
- 8 Verify that power backplane-to-SCSI backplane cable is properly connected.
- 9 Verify that 10-inch and 20-inch mezzanine-to-SCSI backplane cables are properly connected.
- 10 Replace rear drive power cable.
- 11 Replace rear drive SCSI cable.
- 12 Replace rear drive SCSI ID cable.
- 13 Replace 10-inch and 20-inch mezzanine-to-SCSI backplane cables.





- 14 Replace SCSI backplane interconnect board.
- 15 Replace hard drive. (Refer to “Setting Up the Network Server” for information on installing disk drives.)

No internal hard drive in front drive bay operates

- 1 Verify that all hard drive trays are completely inserted in their respective front drive bay.
- 2 Verify that server is recognizing the hard drives in the front drive bays on SCSI bus. (Refer to the “SCSI Devices General” previously in this chapter.)
- 3 Verify that installed SCSI devices and PCI cards are not exceeding maximum power allowance. This may affect operation of installed devices.
- 4 Run Network Server Diagnostic Utility and follow the instructions provided with the utility to verify core system operations.
- 5 Verify that power backplane-to-SCSI backplane cable is properly connected.





- 6 Verify that 10-inch and 20-inch mezzanine-to-SCSI backplane cables are properly connected.
- 7 Replace 10-inch and 20-inch mezzanine-to-SCSI backplane cables.
- 8 Replace power backplane-to-SCSI backplane power cable.
- 9 Replace SCSI backplane interconnect board.
- 10 Replace powerplane interconnect board.
- 11 Replace logic board. Retain customer's DIMMs.
- 12 Replace processor card.

No internal hard drives in the rear drive bracket operate

**Note:** This procedure applies only to Network Server 700 Series.

- 1 Verify that internal hard drives in the rear drive bracket do not have duplicate SCSI device addresses.
- 2 Verify that server is recognizing the internal rear hard drives on SCSI bus. (Refer to the "SCSI Devices General" previously in this chapter.)







- 3 Verify that installed SCSI devices and PCI cards are not exceeding maximum power allowance. This may affect operation of installed devices.
- 4 Run Network Server Diagnostic Utility and follow the instructions provided with the utility to verify core system operations.
- 5 Verify that rear drives SCSI cable, SCSI ID cable, and power cable are properly connected.
- 6 Verify that the last bracket-mounted drive on the SCSI cable has termination enabled.
- 7 Verify that the SCSI ID cable and the last connector on the SCSI cable are both connected to the bottom hard drive.
- 8 Verify that power backplane-to-SCSI backplane cable is properly connected.
- 9 Verify that 10-inch and 20-inch mezzanine-to-SCSI backplane cables are properly connected.
- 10 Replace rear drives SCSI cable.
- 11 Replace rear drives SCSI ID cable.





- 12 Replace rear drives power cable.
- 13 Replace 10-inch and 20-inch mezzanine-to-SCSI backplane cables.
- 14 Replace SCSI backplane interconnect board.
- 15 Replace power backplane-to-SCSI backplane power cable.
- 16 Replace powerplane interconnect board.
- 17 Replace logic board. Retain customer's DIMMs.
- 18 Replace processor card.





## Floppy Drive

Internal floppy drive does not operate

- 1 Use a known-good floppy disk.
- 2 Verify that mezzanine-to-floppy drive cable is properly connected.
- 3 Verify that rear drawer is properly installed.
- 4 Replace floppy drive.
- 5 Replace mezzanine-to-floppy drive cable.
- 6 Replace mezzanine interconnect board.
- 7 Replace logic board. Retain customer's DIMMs.

Does not eject disk

- 1 To eject a previously inserted disk, insert an opened paper clip into hole beneath floppy drive.
- 2 Reseat floppy drive bezel and floppy drive so that bezel slot aligns correctly with floppy drive.
- 3 Verify that rear drawer is properly installed.
- 4 Replace floppy drive.
- 5 Replace mezzanine-to-floppy drive cable.





- 6 Replace mezzanine interconnect board.
- 7 Replace logic board. Retain customer's DIMMs.





## CD-ROM Drive

CD-ROM drive does not work

- 1 Use a known-good compact disc.
- 2 Reseat CD-ROM drive.
- 3 Move CD-ROM drive to another front drive bay slot.
- 4 Verify that server is recognizing CD-ROM drive on SCSI bus. (Refer to “SCSI Devices General” in this chapter.)
- 5 Verify that installed SCSI devices and PCI cards are not exceeding maximum power allowance. This may effect operation of installed devices.
- 6 Run Network Server Diagnostic Utility and follow the instructions provided with the utility to verify core system operations.
- 7 Verify that CD-ROM drive SCSI cable, SCSI ID cable, and power cable are properly connected.
- 8 Replace CD-ROM drive.
- 9 Replace SCSI backplane board.
- 10 Replace logic board. Retain customer’s DIMMs.





Volume control does not operate correctly

- 1 Reseat CD-ROM drive.
- 2 Move CD-ROM drive to another front drive bay slot.
- 3 Verify that CD-ROM drive SCSI cable, SCSI ID cable, and power cable are properly connected.
- 4 Replace CD-ROM drive.
- 5 Replace SCSI backplane board.
- 6 Replace logic board. Retain customer's DIMMs.





## DAT Drive

DAT drive does not work

- 1 Verify that DAT tape conforms to DDS-2 standards.
- 2 Use a known-good tape.
- 3 Move the DAT drive to another front drive bay slot.
- 4 Verify that server is recognizing DAT drive on SCSI bus. (Refer to “SCSI Devices General” in this chapter.)
- 5 Verify that installed SCSI devices and PCI cards are not exceeding maximum power allowance. This may affect operation of installed devices.
- 6 Run Network Server Diagnostic Utility and follow the instructions provided with the utility to verify core system operations.
- 7 Verify that DAT drive SCSI cable, SCSI ID cable, and power cable are properly connected.
- 8 Replace DAT drive.
- 9 Replace SCSI backplane board.
- 10 Replace logic board. Retain customer’s DIMMs.





Self-test fails and right light flashes amber

Clean tape drive head. (Refer to “Cleaning the Tape Drive Heads” in “Setting Up the Network Server.”)

Amber light flashes when tape is loaded in tape drive

Copy data to new tape and discard old tape, as it is worn out.

Self-test fails and right light is solid amber

- 1 Move DAT drive to another front drive bay slot.
- 2 Replace DAT drive.
- 3 Replace SCSI backplane board.
- 4 Replace logic board. Retain customer’s DIMMs.







## Peripherals

Cursor does not move

- 1 Check mouse connection.
- 2 Inspect inside of mouse for buildup of dirt or other contaminants. Clean mouse if necessary.
- 3 If mouse was connected to keyboard, connect mouse to computer ADB port instead. If mouse works, replace keyboard.
- 4 Replace ADB cable.
- 5 If mouse does not work in any ADB port on computer, replace mouse.
- 6 Replace logic board. Retain customer's DIMMs.
- 7 Replace processor card.





Cursor moves, but clicking mouse button has no effect

- 1 If mouse was connected to keyboard, connect mouse to computer ADB port instead. If mouse works, replace keyboard.
- 2 If mouse does not work in any ADB port on computer, replace mouse.
- 3 Replace logic board. Retain customer's DIMMs.

No response to any key on keyboard

- 1 Verify that server is properly configured to connect to a serial terminal. (Refer to "Setting Up the Network Server" for information on how to connect the server to a serial terminal.)
- 2 Verify that keyboard is an ADB-compatible extended keyboard.
- 3 Check keyboard connection to ADB port.
- 4 Replace keyboard cable.
- 5 Replace keyboard.
- 6 Replace logic board. Retain customer's DIMMs.





## Take Apart

---

Network Server 500 and  
700 Series





## Base Door

No preliminary steps are required before you begin this procedure.

**Note:** Turn the front lock key to the upright (unlocked) or left (service) position otherwise the lock shaft may be damaged.





- 1 Press the two buttons, located on the left and right inside edge of the base door.



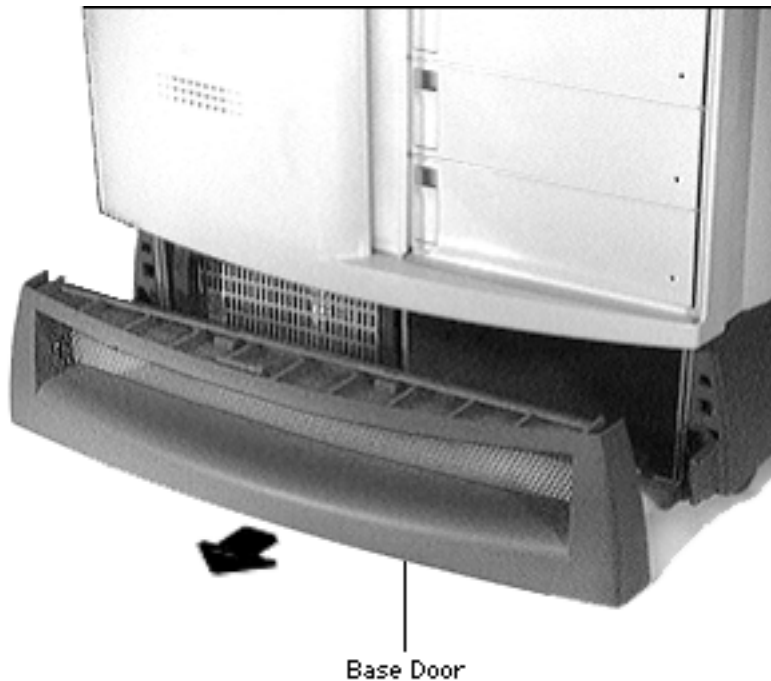

2 Pull the base door out.





## Fan Assembly

No preliminary steps are required before you begin this procedure.

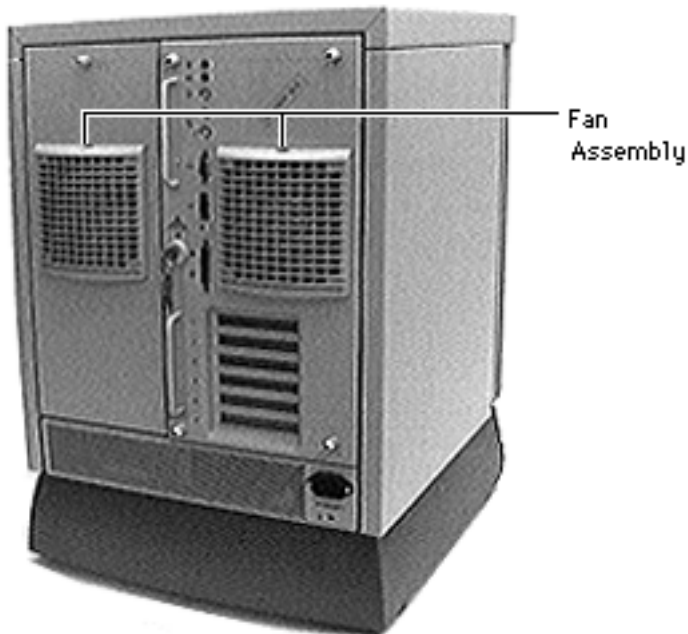

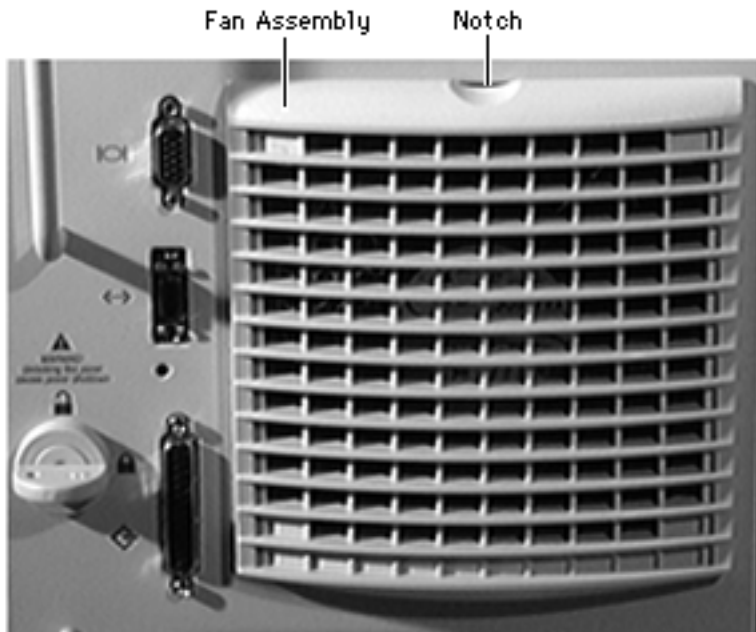

**Note:** Because the fan assembly is hot-swappable, you do not need to shut down the server before replacing the fan assembly. (A message will display on the LCD panel indicating that it is safe to replace the assembly.)

- 1 With the back of the computer facing you, place your fingers on the notch located on the fan assembly.
- 2 Press the fan assembly down and away from the unit.





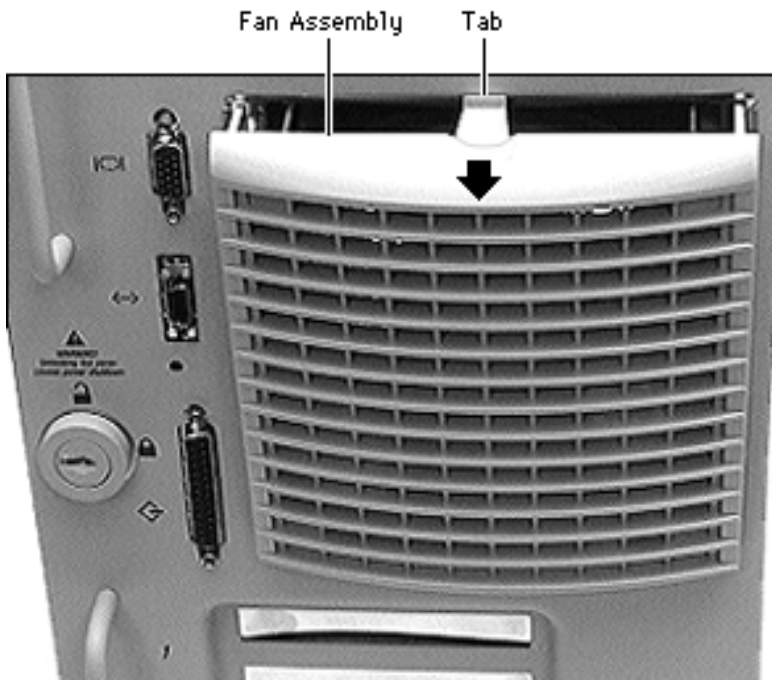

**Replacement Note:** With the fan assembly at a right angle to the unit, install the fan assembly by first inserting the tab, and then pushing the assembly up and into its enclosure. Make sure that the bottom contacts of the fan are inserted correctly.





## Rear Drawer

The rear drawer consists of the following parts:

- Fan assembly
- Rear I/O panel
- Rear keyswitch cable
- Logic board w/cards
- Logic board carrier
- Processor card guides

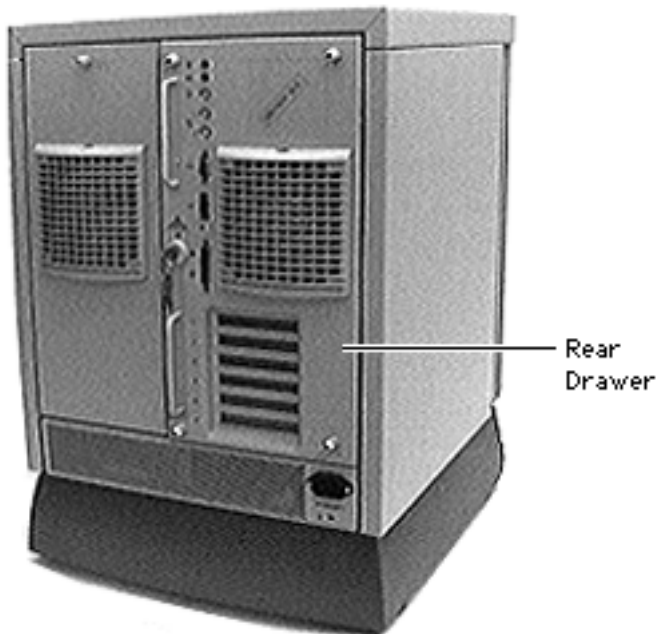

Before you begin, disconnect the power cord.

**Caution:** Always support the rear drawer when removing it or it may fall off the unit.





Rear Drawer Lock

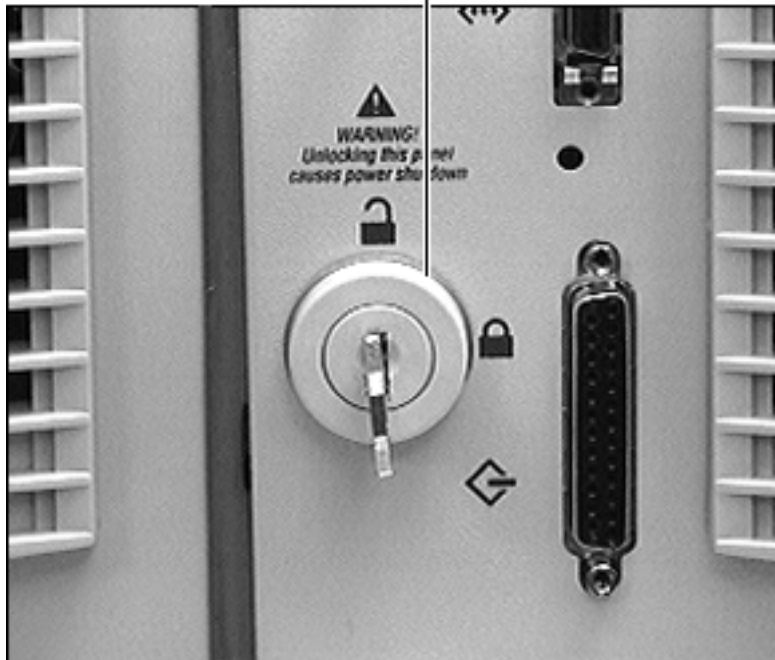

**Caution:** Review the ESD precautions in Bulletins/ Safety.

- 1 With the back of the computer facing you, turn the key in the rear drawer lock to the upright (unlocked) position.



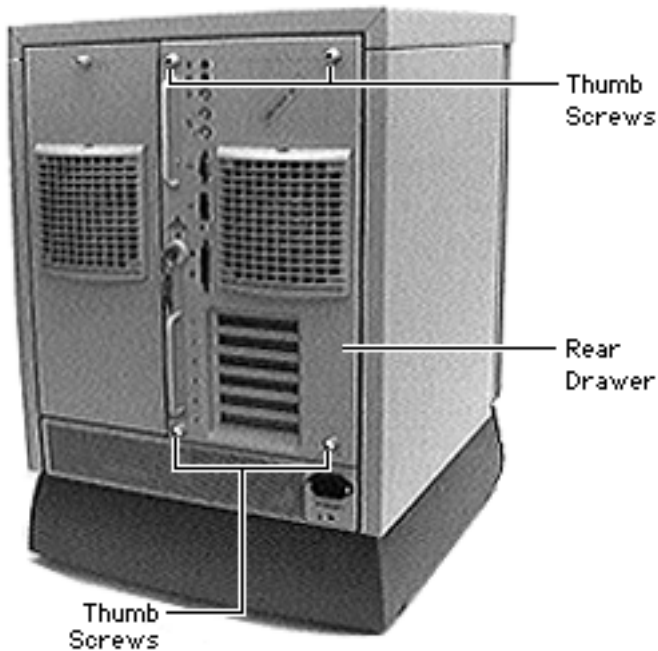

- 2 Loosen the four thumb screws.

**Caution:** The following procedure releases the drawer from its drawer slides. Be sure to support the drawer at all times so that it does not fall off the unit.



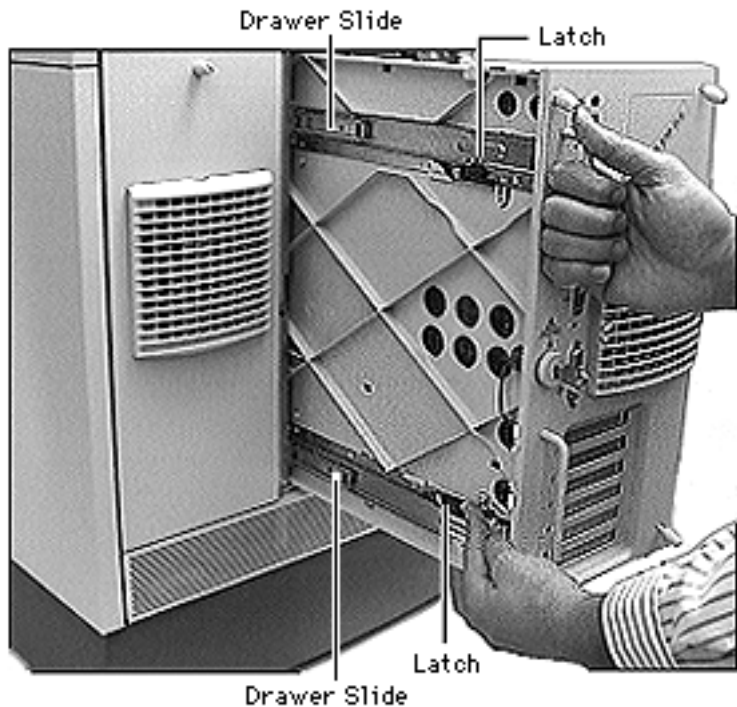

- 3 Slide the drawer out a few inches. With the right hand holding the drawer by the top handle, use the left hand to release the bottom black latch and move the drawer slide 1 inch to the left. Repeat for the top latch and slide.



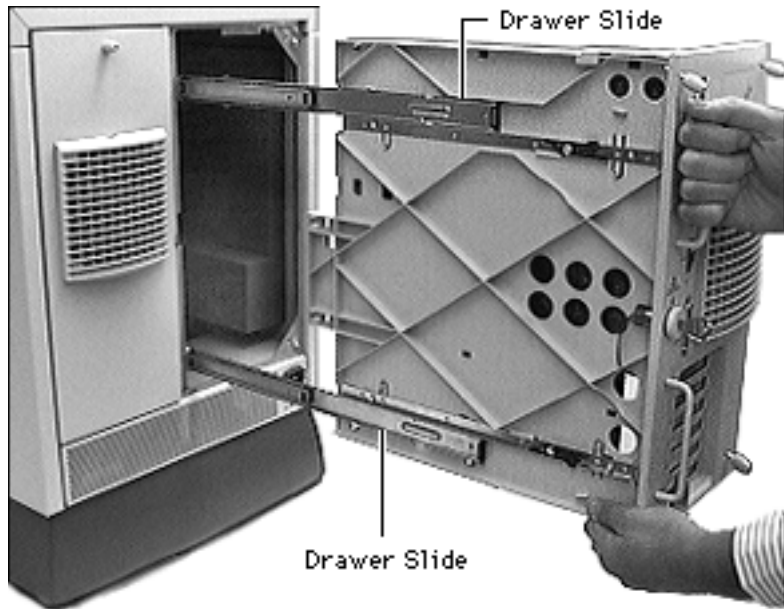

- 4 Detach the rear drawer from the drawer slides and remove it from the unit.

**Note:** Always place the rear drawer on an antistatic mat.

**Replacement Caution:** In the following procedure, be sure to support the drawer at all times so that it does not fall off the unit.



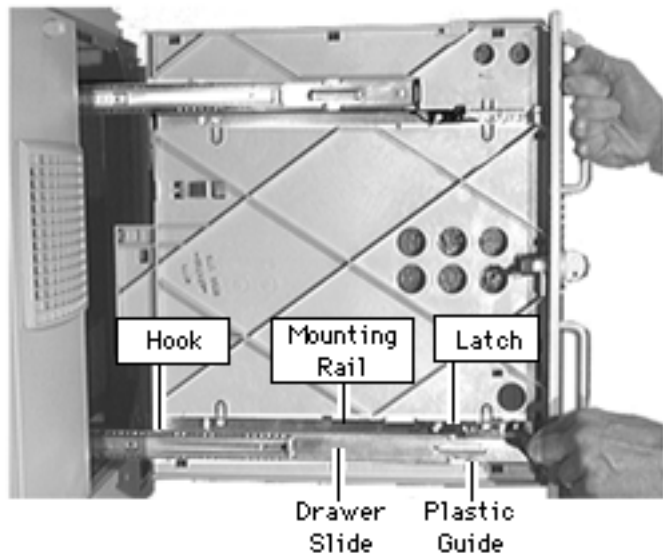

**Replacement Note:** With your right hand holding the drawer by the top handle, use your left hand to align the bottom drawer slide between the drawer's mounting rail and the plastic guide. Make sure the hook at the far left end of the drawer slide engages with the notch in the mounting rail. Then move the slide all the way to the right until you hear a click and the black latch locks into place.



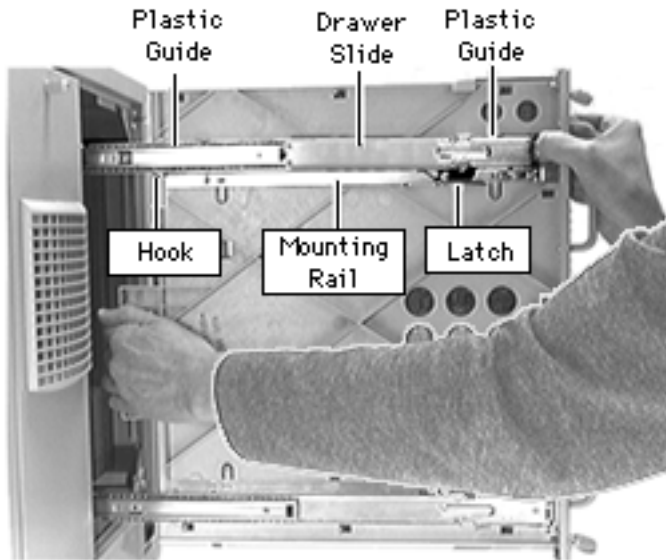

With your right hand still holding the drawer's top handle, move your left hand to the left edge of the drawer carrier and press the carrier against the slides. Align the top slide between the drawer's mounting rail and the plastic guides. Make sure the hook at the far left end of the drawer slide engages with the notch in the mounting rail. Then use your right thumb to move the slide all the way to the right until you hear a click and the black latch locks into place.





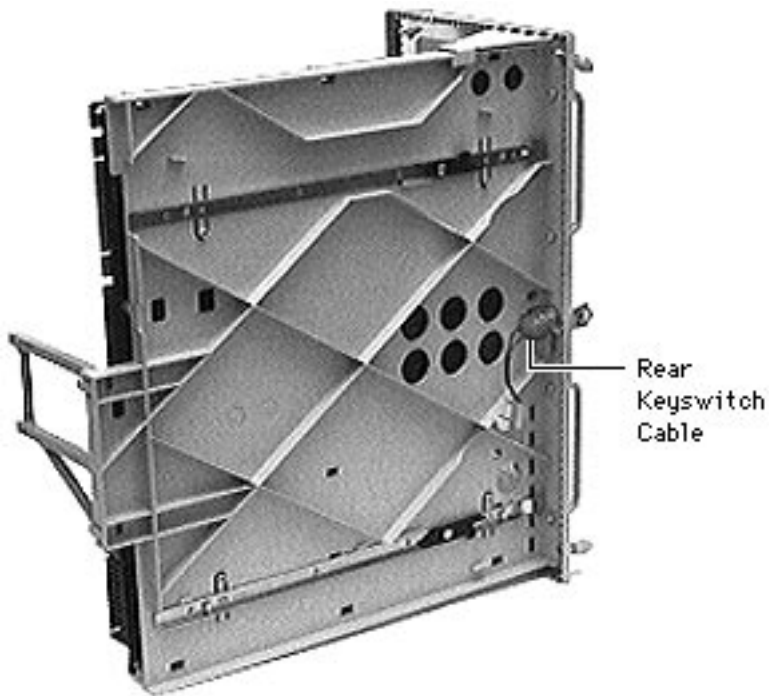

## Rear Keyswitch Cable

Before you begin, disconnect the power cord and remove the rear drawer.

**Caution:** Review the ESD precautions in Bulletins/Safety.

- 1 Disconnect the rear keyswitch cable from the logic board.



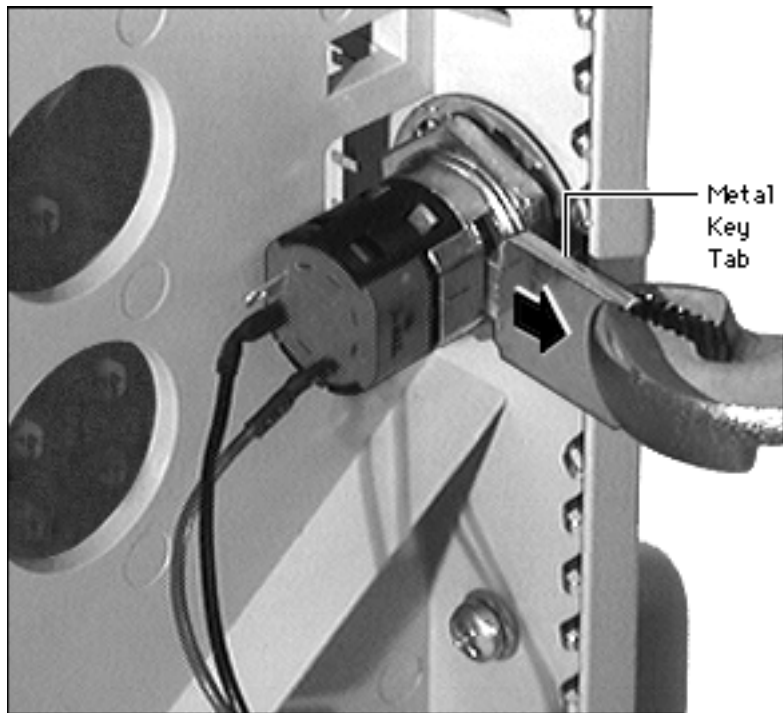

- 2 Using pliers, pull out the metal key tab.





- 3 Unscrew the rear keyswitch cable from the rear I/O panel by turning the nut counterclockwise.



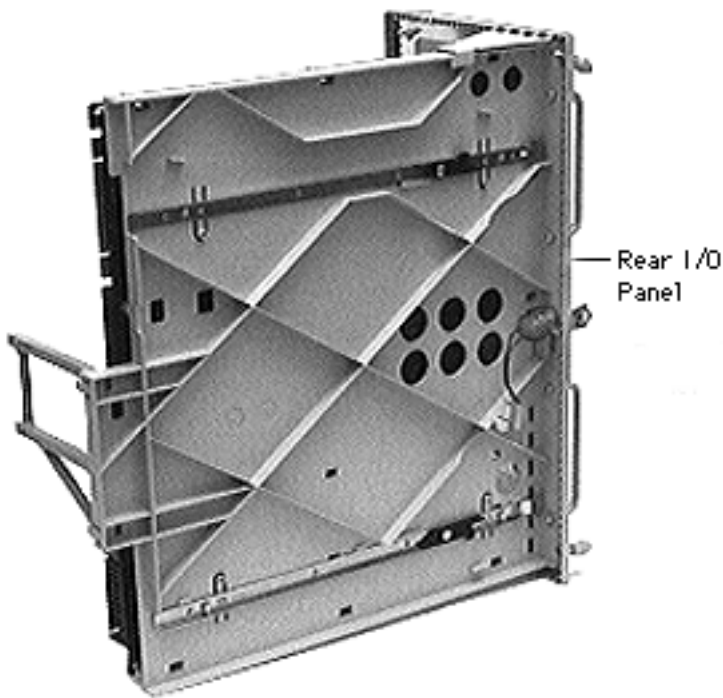

## Rear I/O Panel

Before you begin, disconnect the power cord and remove the following:

- Rear drawer
- Fan assembly
- Rear keyswitch cable

**Caution:** Review the ESD precautions in Bulletins/Safety.



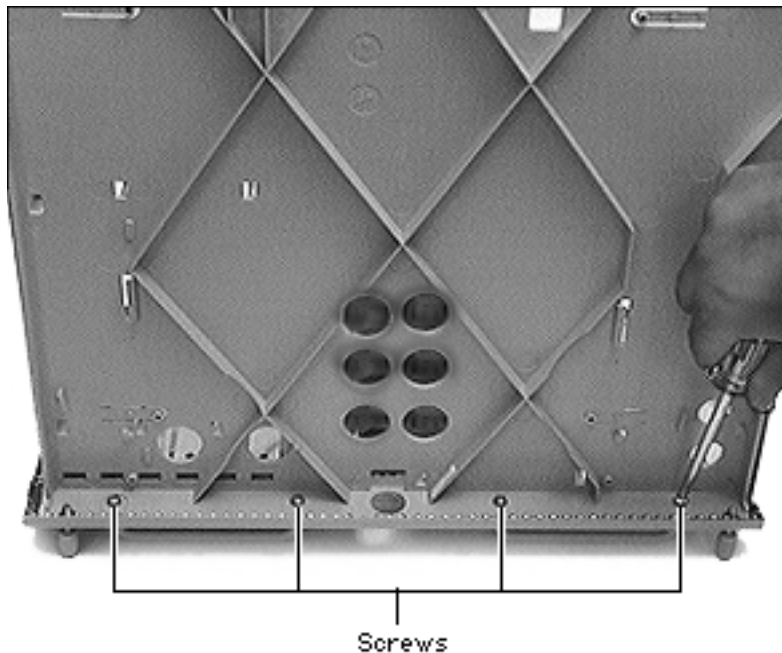

Remove the four screws that attach the logic board carrier and the rear drawer handles with the rear I/O panel.

**Replacement Note:** When replacing the rear I/O panel, you may need to remove the fan cage. Simply push the cage out from the rear I/O panel.



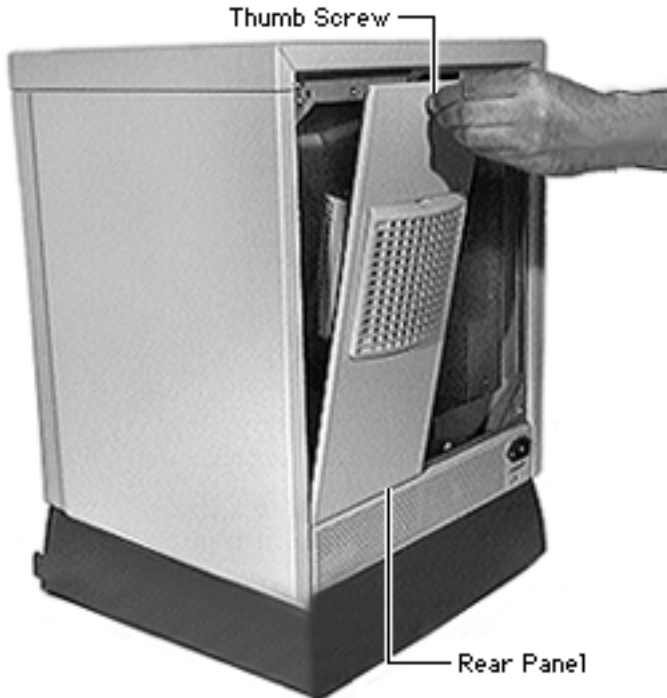

## Rear Panel

Before you begin, disconnect the power cord and slide the rear drawer open.

**Caution:** Review the ESD precautions in Bulletins/ Safety.

- 1 Loosen the thumb screw.



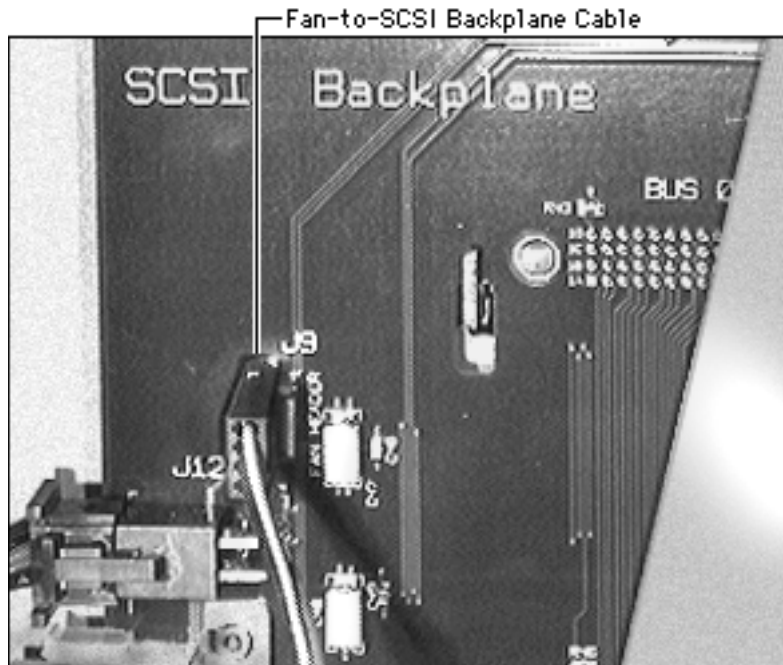

- 2 Remove the fan-to-SCSI-backplane cable.

**Replacement Note:** Make sure to reconnect the fan-to-SCSI backplane cable to the correct connector on the backplane. The rear drives' power connector is similar, and if the fan-to-SCSI backplane cable is incorrectly connected to it, the server will not power on.





## Top Cover

Before you begin, do the following:

- Disconnect the power cord
- Slide the rear drawer open
- Remove the rear panel

**Caution:** Review the ESD precautions in Bulletins/Safety.





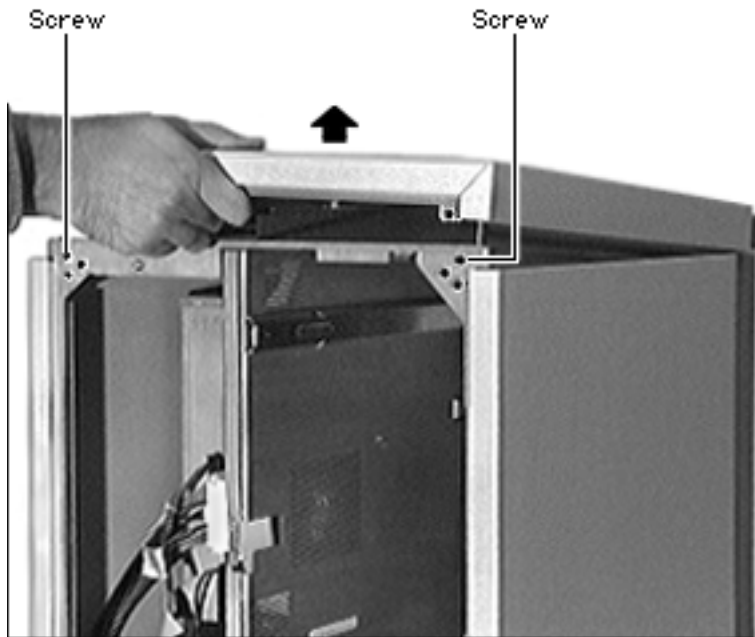

- 1 Remove the two screws from the rear edge of the top cover.
- 2 Pull the top cover up and away from the main unit.



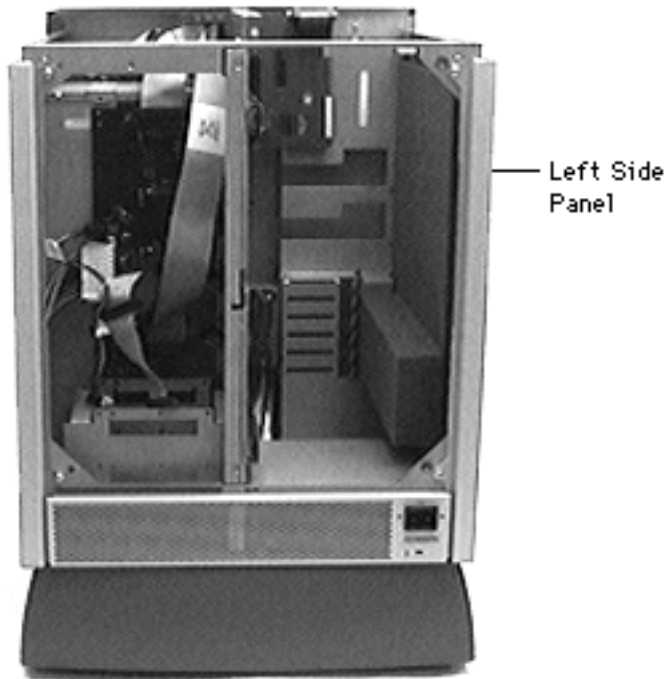

## Left Side Panel

Before you begin, do the following:

- Disconnect the power cord
- Slide the rear drawer open
- Remove the rear panel

**Caution:** Review the ESD precautions in Bulletins/Safety.



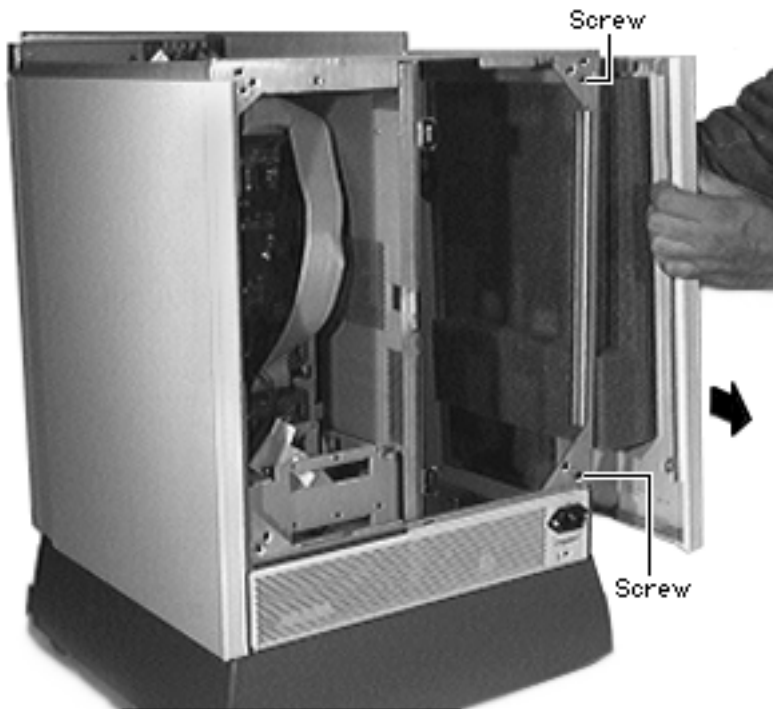

- 1 Remove the two screws from the rear edge of the left side panel.
- 2 Slide the left side panel out.

**Replacement Note:** The left side panel can be installed only on the left side of the server.

**Replacement Note:** First latch the left side panel on the top and then on the bottom.





## Right Side Panel

Before you begin, disconnect the power cord, slide the rear drawer open, and remove the rear panel.

**Caution:** Review the ESD precautions in Bulletins/Safety.

Right Side  
Panel

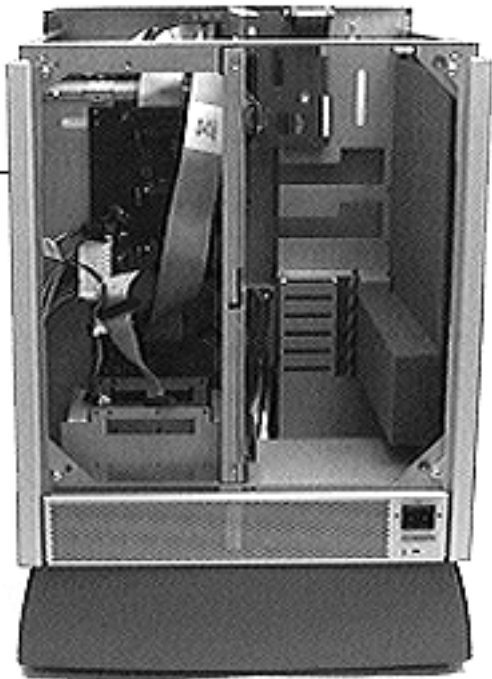

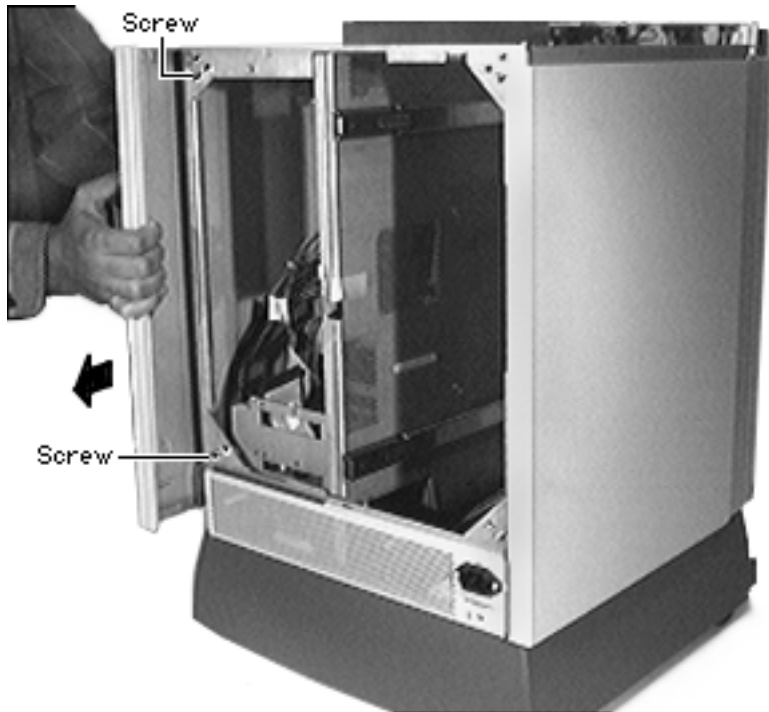

- 1 Remove the two screws from the rear edge of right side panel.
- 2 Slide the right side panel out.

**Replacement Note:** The right side panel can be installed only on the right side of the server.

**Replacement Note:** First latch the right side panel on the top and then on the bottom.





## Drawer Slides

Before you begin, disconnect the power cord and remove the following:

- Rear drawer
- Left side panel

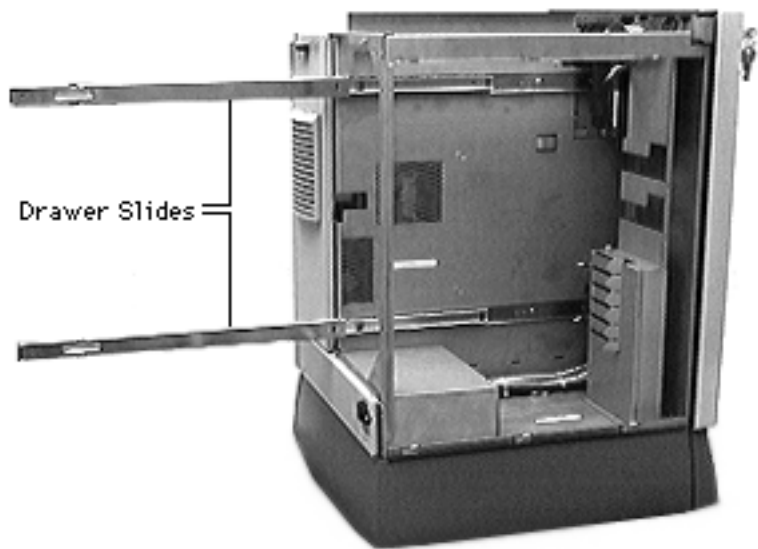



- 1 Pull the slides all the way to the rear.

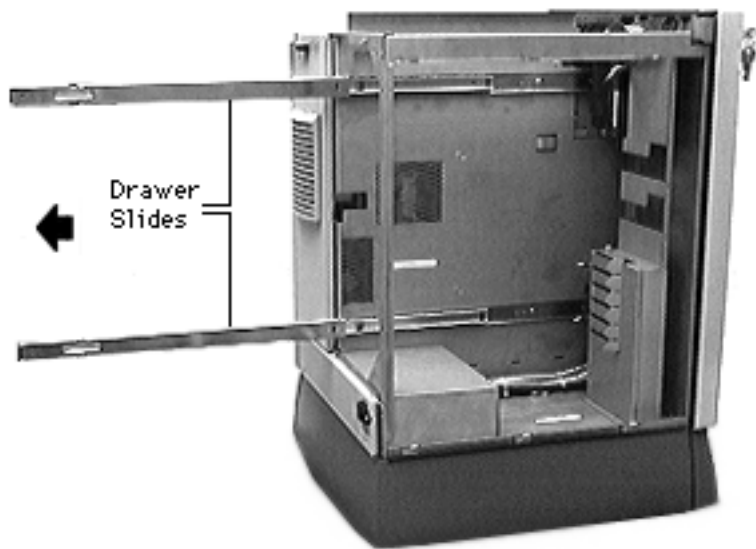

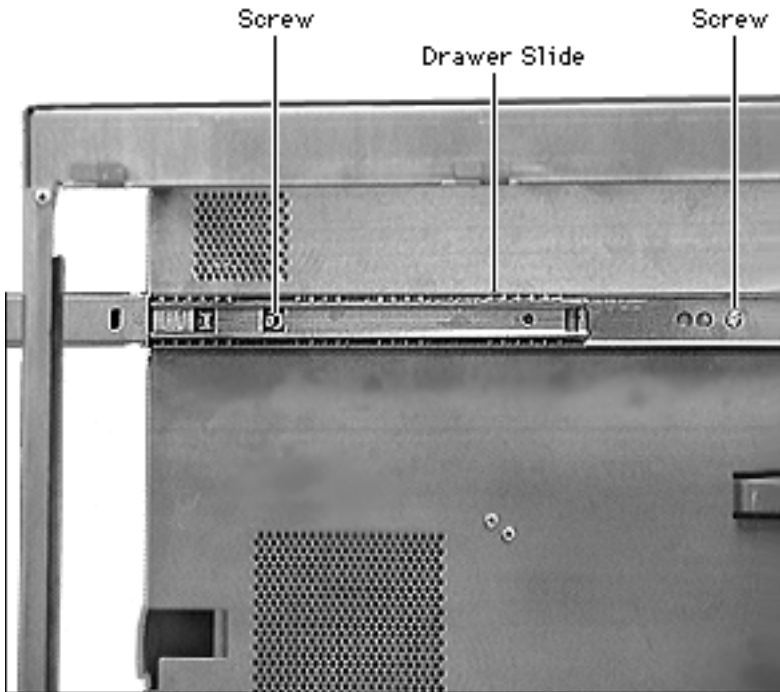

- 2 Remove the two screws on each slide and remove the slides.







## Left Duct

Before you begin, disconnect the power cord and remove the following:

- Rear drawer
- Left side panel



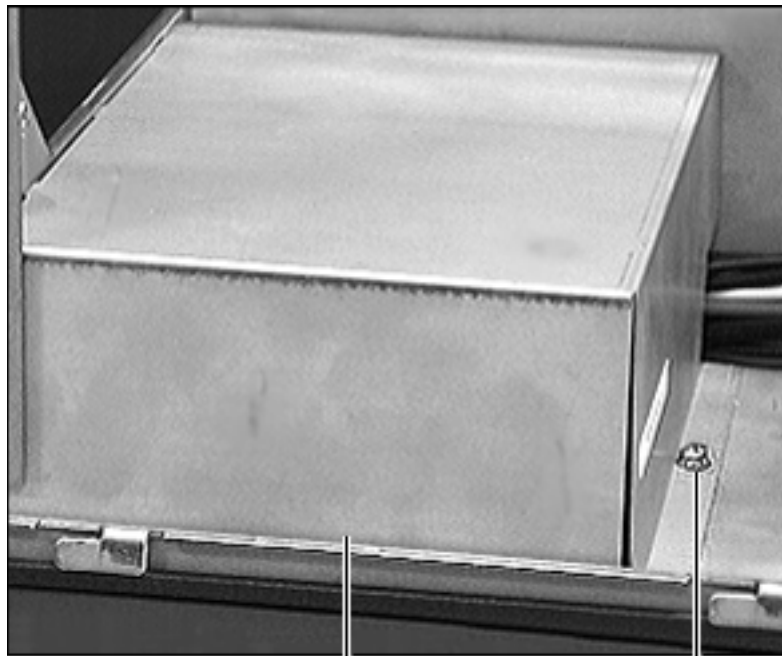

Left Duct

Screw

Remove the left duct mounting screw and remove the left duct.





AC Interlock  
Receptacle  
Ground Cable

## AC Interlock Receptacle Ground Cable

Before you begin,  
disconnect the power cord  
and remove the following:

- Rear drawer
- Rear panel
- Top cover
- Left side panel
- Left duct



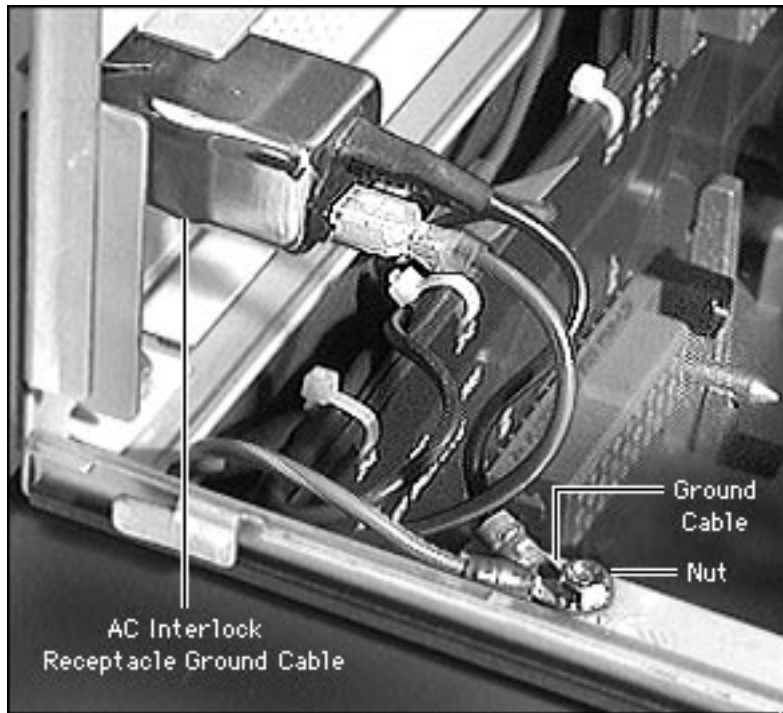

**Caution:** Review the ESD precautions in Bulletins/ Safety.

- 1 Remove the nut holding the AC interlock receptacle ground cable.
- 2 Unscrew the AC interlock receptacle ground cable.





## Power Supply (NS 500 Series)

Before you begin,  
disconnect the power cord  
and remove the following:

- Base door
- Rear drawer
- Rear panel
- Top cover
- Left side panel
- Right side panel
- Left duct
- AC interlock receptacle  
ground cable



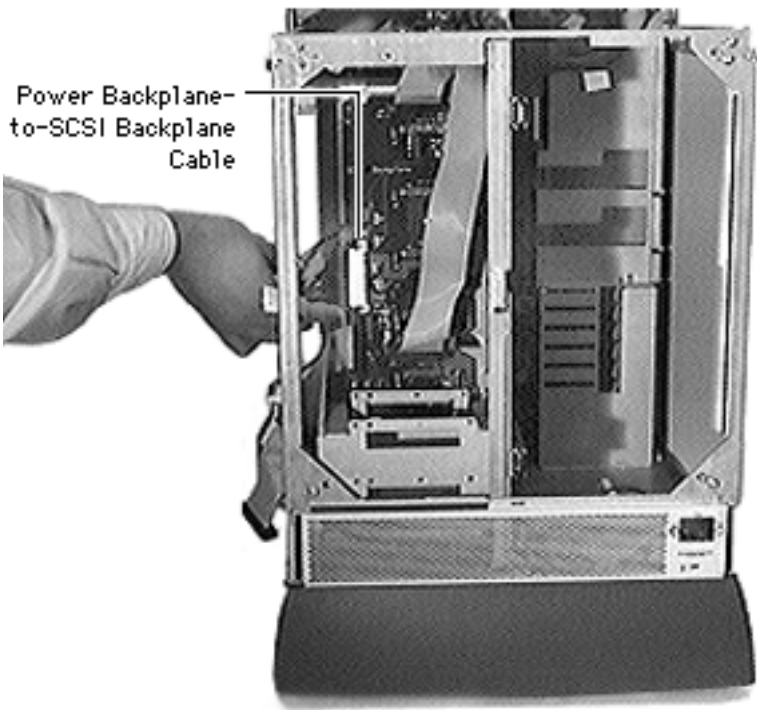

**Caution:** Review the ESD precautions in Bulletins/ Safety.

- 1 Disconnect the Power backplane-to-SCSI backplane cable from the power backplane by depressing the security tabs on the connector.





- 2 Disconnect the ground cables from to the main chassis.

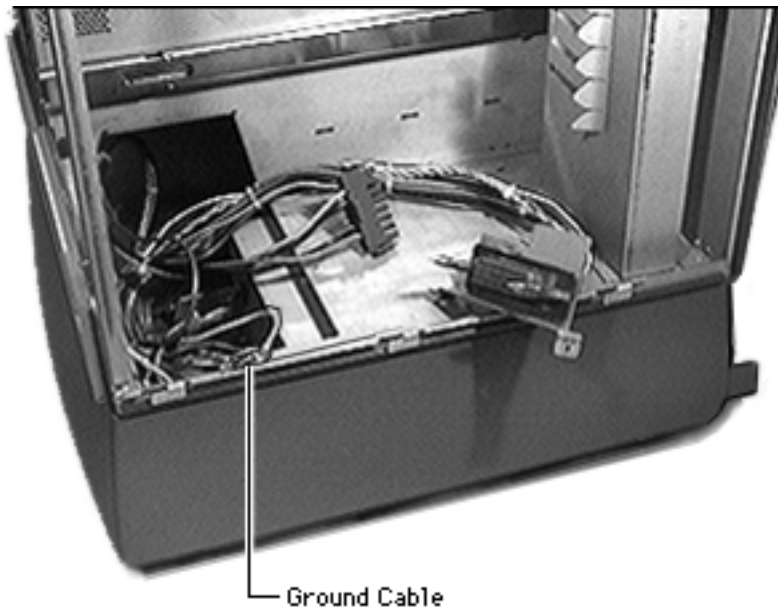

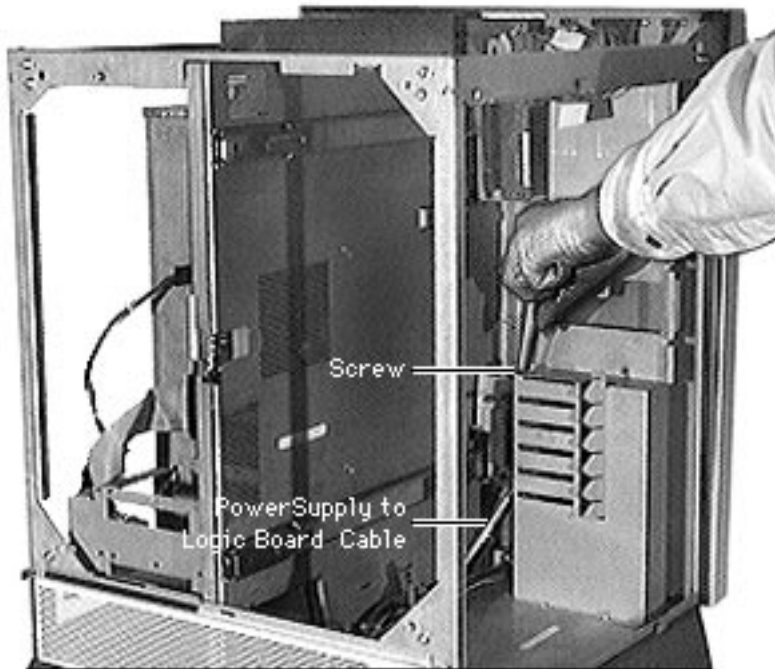

- 3 Disconnect the power supply-to-logic board cable from the power supply.
- 4 Remove the screw and slide the power supply out of the main unit.







## Power Supply (NS 700 Series)

Before you begin, turn the front lock key to the upright (unlocked) or left (service) position and remove the base door.

**Caution:** Review the ESD precautions in Bulletins/ Safety.





ANS 700/150  
Power Supply

**Note:** Because the power supply is hot-swappable, you do not need to shut down the server before replacing the power supply provided that there are two power supplies installed. (A message will display on the LCD panel indicating that it is safe to replace the power supply.)

Grasp the power supply handle and pull the power supply out of the unit.





**Replacement Note:** The server includes two bays for two power supplies.

Although the server is shipped with only one power supply installed in the left bay, the power supply can be installed in either bay. Always slide the power supply all the way down into the bay, and push the power supply with enough force so that you hear it snap into place.



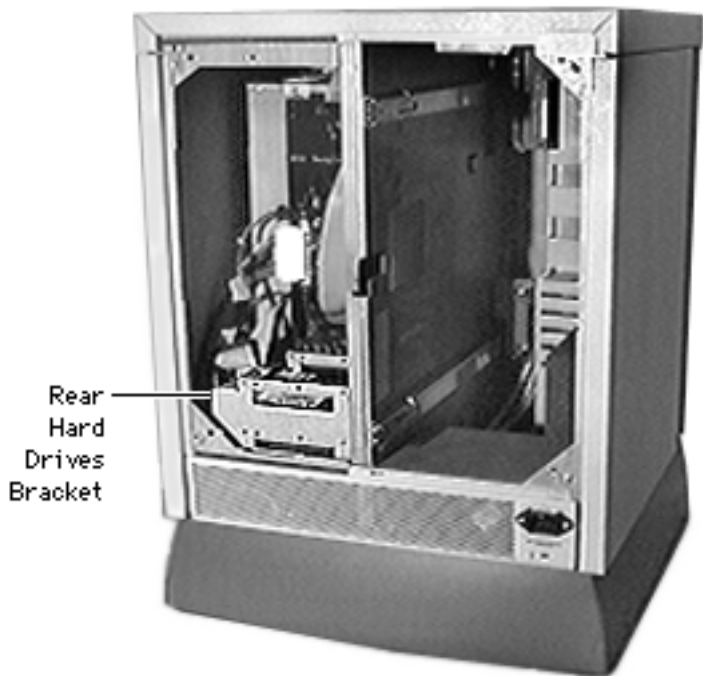

Rear  
Hard  
Drives  
Bracket

## Rear Hard Drives Bracket (NS 700 Series)

Before you begin,  
disconnect the power cord  
and remove the following:

- Rear drawer
- Rear panel

**Caution:** Review the ESD  
precautions in Bulletins/  
Safety.





SCSI Cable

SCSI ID Cable

Power Cable

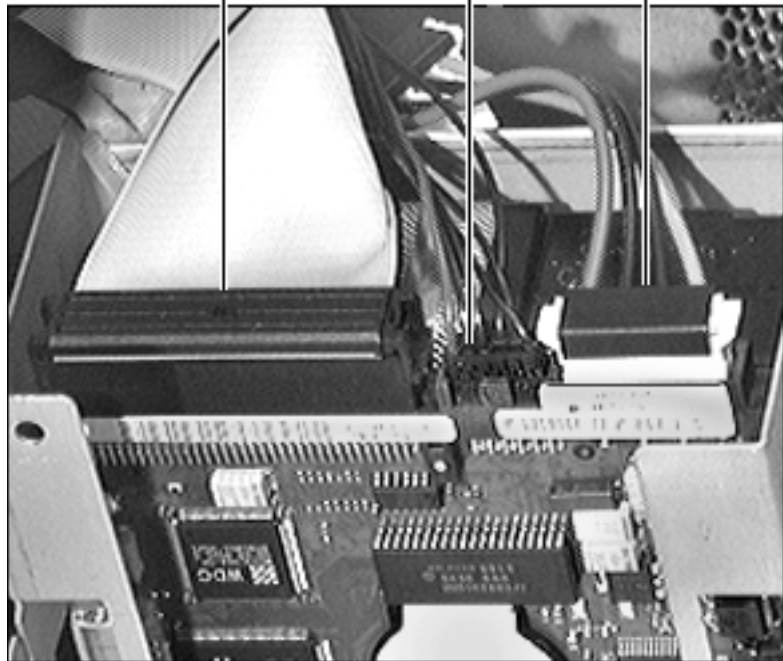

1 Disconnect the following:

- Rear hard drives power cable
- SCSI cable
- SCSI ID cable





Screw      Rear Hard Drive      Bracket

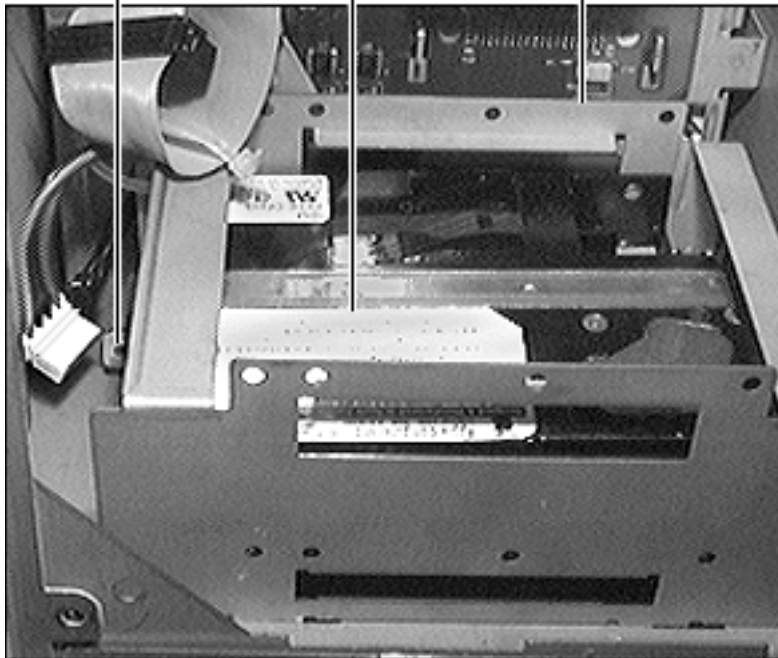

- 2 Remove the screw that attaches the rear hard drives bracket to the server enclosure and slide the rear hard drives bracket out.





## Processor Card

Before you begin,  
disconnect the power cord.

**Caution:** Review the ESD  
precautions in Bulletins/  
Safety.

**Caution:** Hold the processor  
card by the edges. Never hold  
the card by the heat sink.

**Caution:** Be sure to support  
the rear drawer with one  
hand while the other hand  
pulls the processor card out  
or puts it back in.

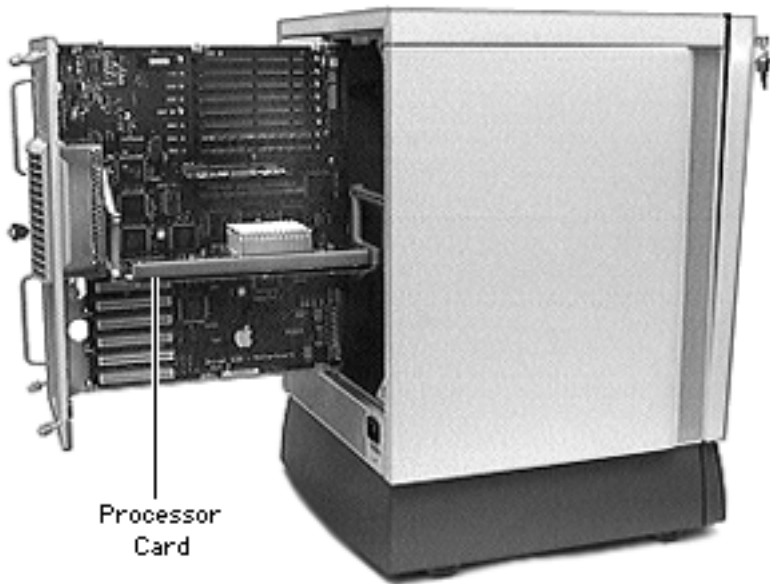

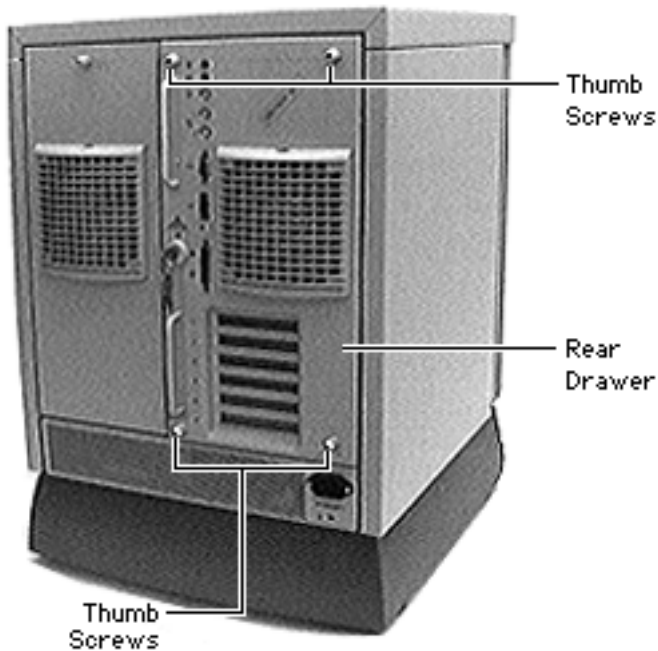

- 1 With the back of the computer facing you, turn the key in the rear drawer lock to the upright (unlocked) position.
- 2 Loosen the four thumb screws and slide the rear drawer out.





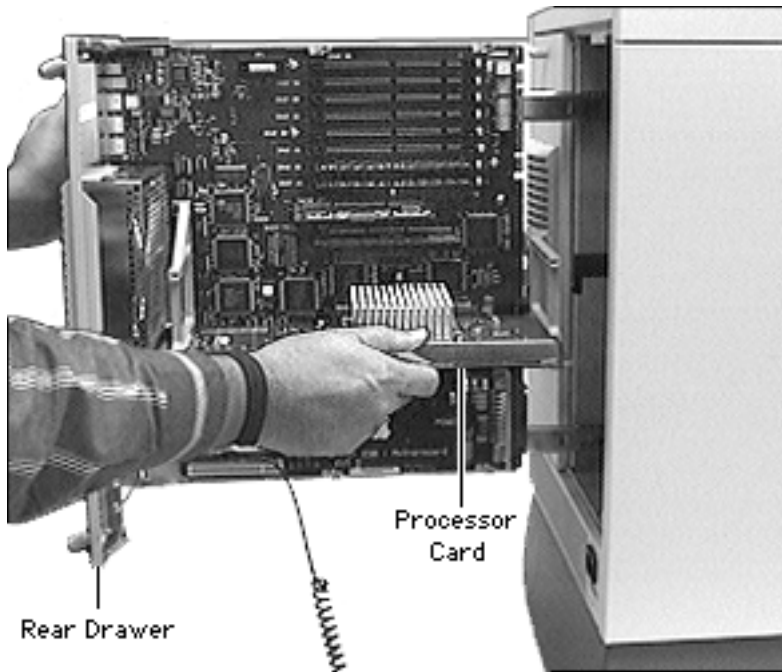

- 3 Holding the processor card by the edges, pull it out while supporting the rear drawer.

**Note:** You may need to use some force to pull the processor card out.



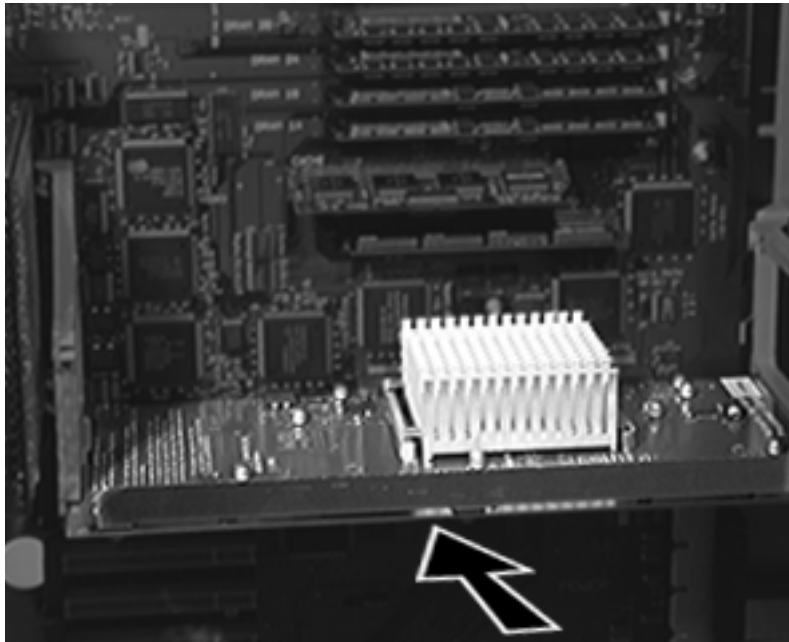

**Replacement Note:** When installing the processor card, position the bottom edges of the card in the processor card guides, and slide the card in until it touches the connector. Then press in on the card so that it is seated firmly into the connector. Do not force the card or you may damage it. Be sure that the card is completely seated, or else the server will not start up.





DRAM DIMM

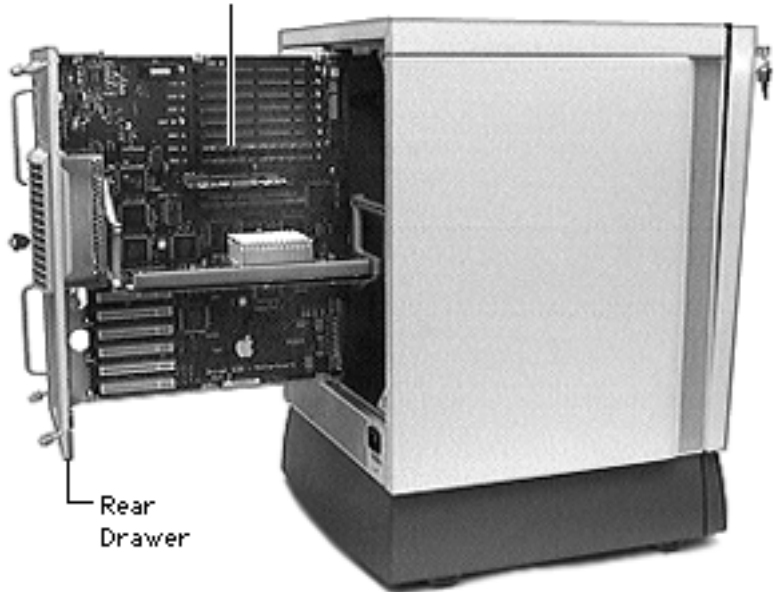

Rear  
Drawer

## DRAM DIMMs

Before you begin,  
disconnect the power cord.

**Caution:** Review the ESD  
precautions in Bulletins/  
Safety.



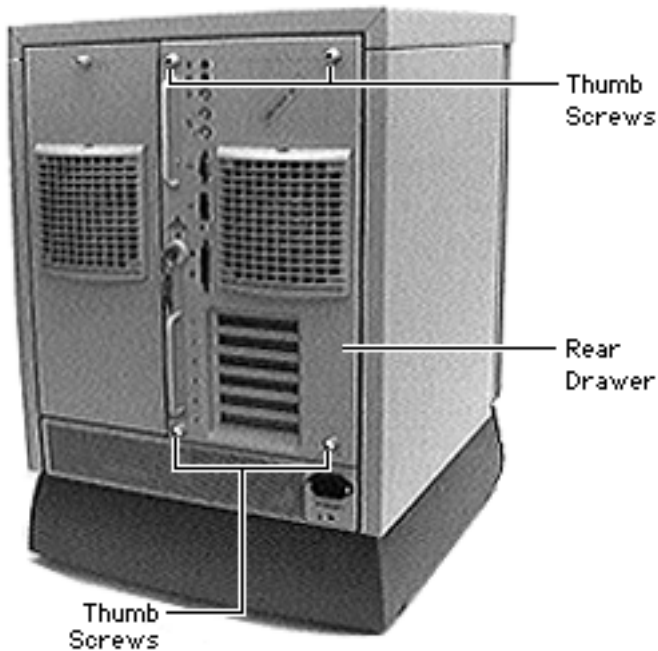

**Caution:** Be sure to support the rear drawer with one hand while the other hand pulls the DIMM out or puts it back in.

- 1 With the back of the computer facing you, turn the key in the rear drawer lock to the upright (unlocked) position.
- 2 Loosen the four thumb screws and slide the rear drawer out.



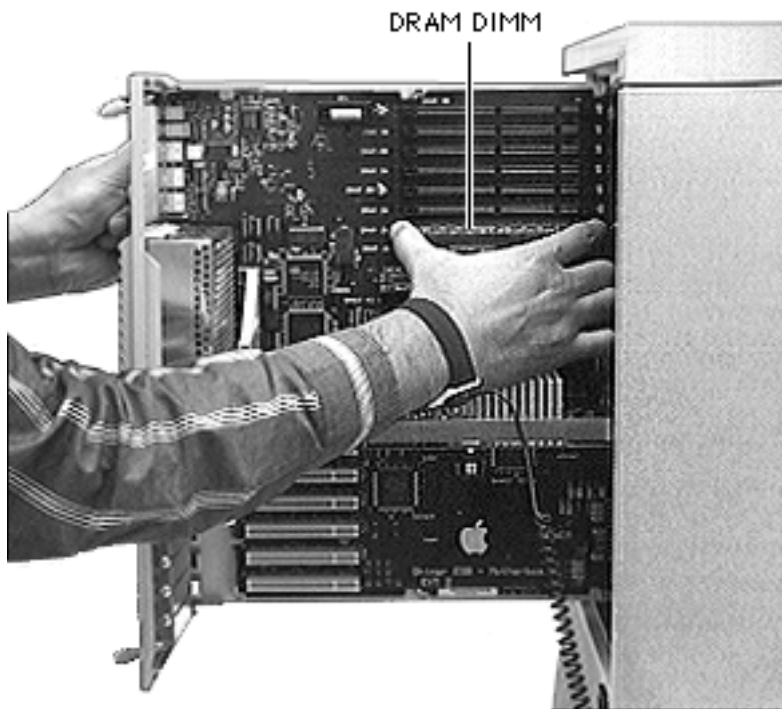

- 3 Push the ejector tab (next to the DIMM socket) outward and down, and pull out the DIMM.

**Note:** Your Network Server may have two ejector tabs adjacent to each DIMM socket.



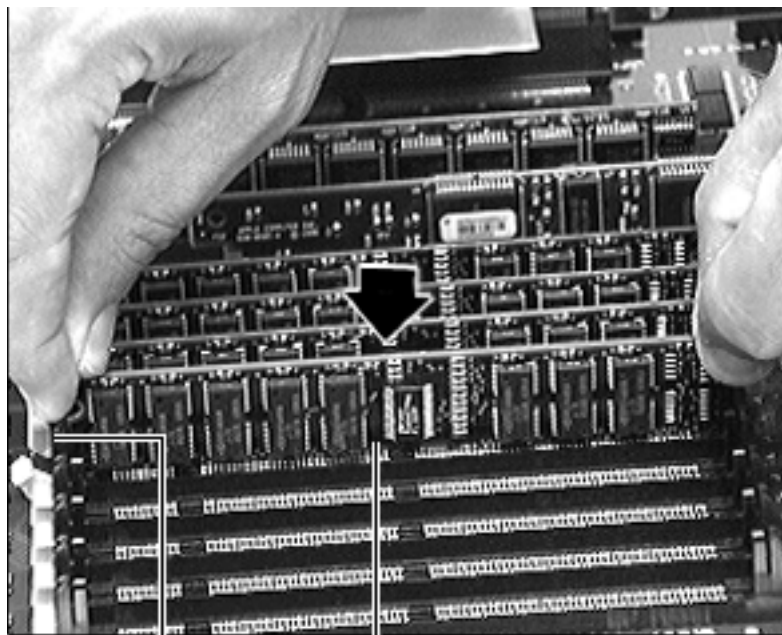

Ejector Tab

DRAM DIMM

**Replacement Note:** Be sure the ejector tab next to the DIMM socket is in the down position. Align the DIMM so that the connector is in line with the socket, and then slide the DIMM down. Do not force the DIMM, or you may damage it. If you encounter resistance, first be sure you have the DIMM lined up properly, and then try again.





## Cache DIMM

Before you begin,  
disconnect the power cord.

**Caution:** Review the ESD  
precautions in Bulletins/  
Safety.

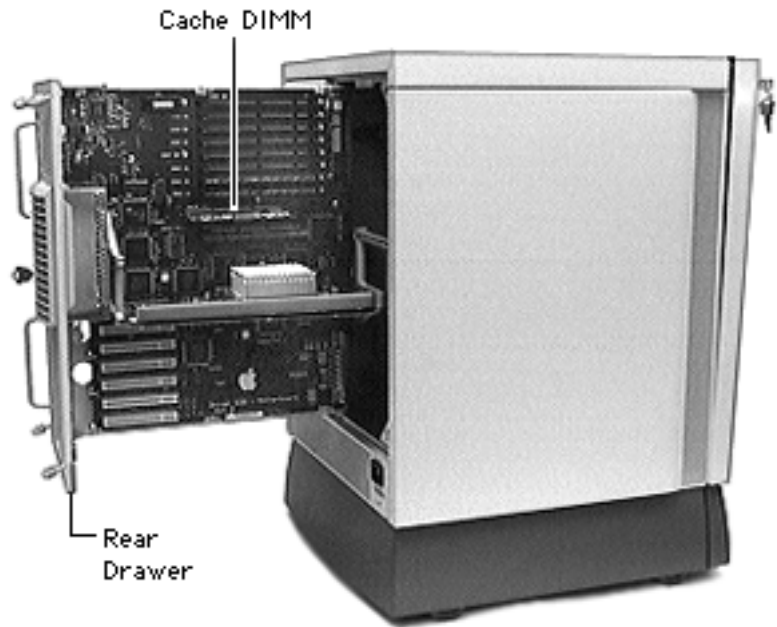

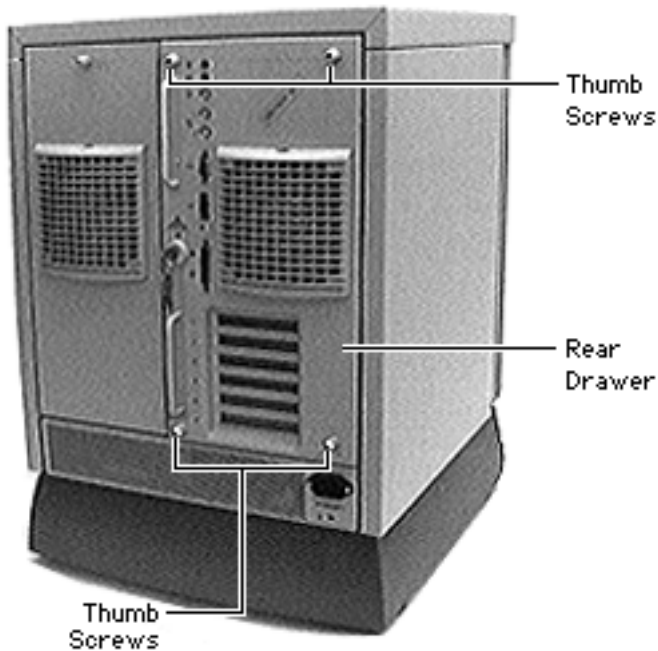

**Caution:** Be sure to support the rear drawer with one hand while the other hand pulls the cache DIMM out or puts it back in.

- 1 With the back of the computer facing you, turn the key in the rear drawer lock to the upright (unlocked) position.
- 2 Loosen the four thumb screws and slide the rear drawer out.







Cache DIMM

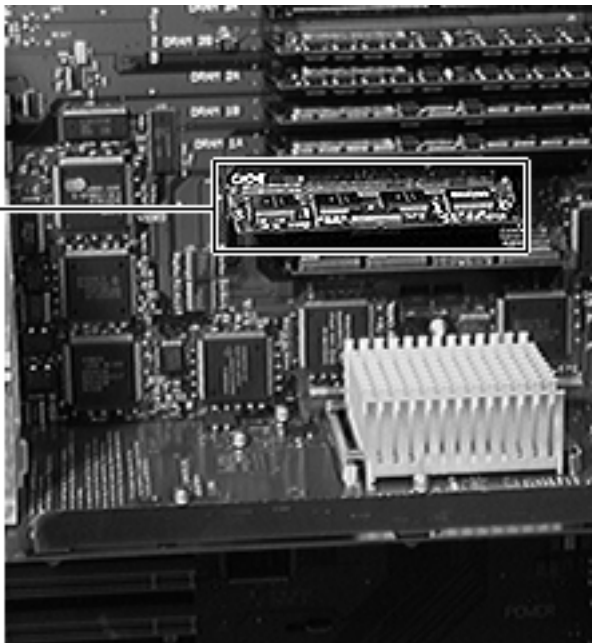

- 3 Grasp the cache DIMM by the edges and pull it out of the slot.



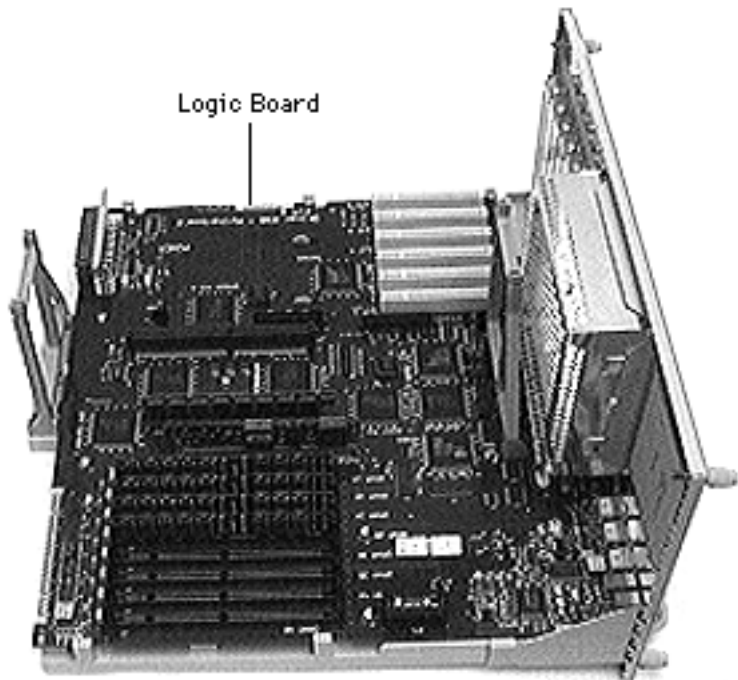

## Logic Board

Before you begin, disconnect the power cord and remove the following:

- Rear drawer
- Fan assembly
- Processor card

**Caution:** Review the ESD precautions in Bulletins/Safety.



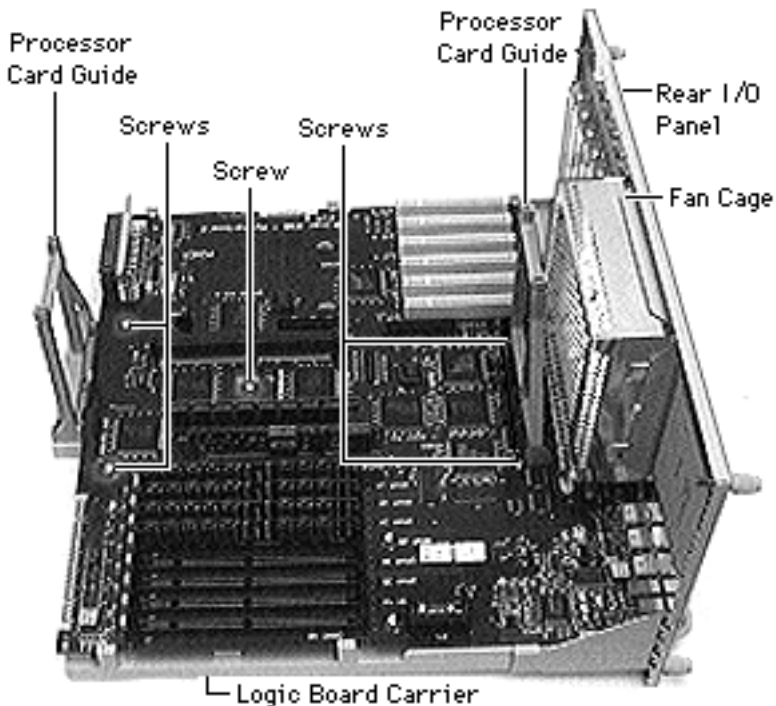

- 1 Remove the two screws holding the processor card guides.
- 2 Remove the two processor card guides.
- 3 Remove the three screws on the logic board.



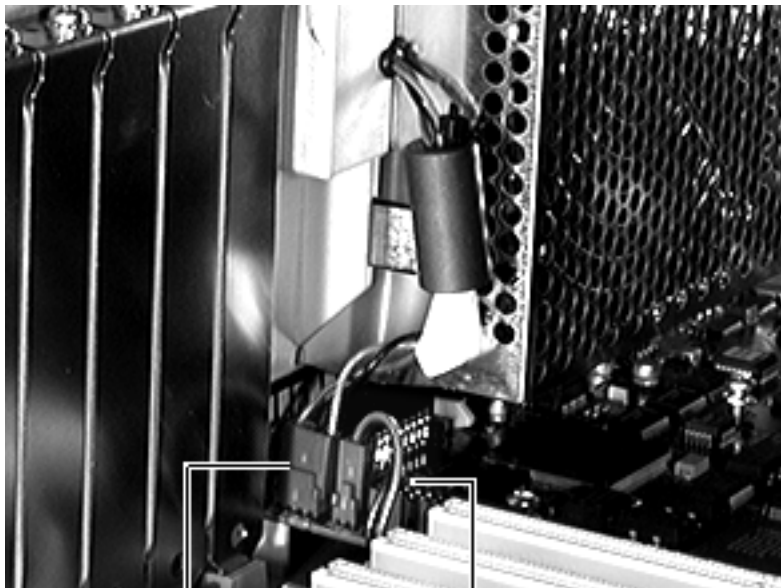

Fan Cable

Rear Keyswitch Cable

- 4 Disconnect the fan cable and the rear keyswitch cable (located between the fan cage and the PCI expansion slots).

**Note:** If you are returning the logic board, be sure to remove the processor card, processor card guides, cache DIMM, DRAM DIMMS, and all other PCI cards except for the ROM SIMM.



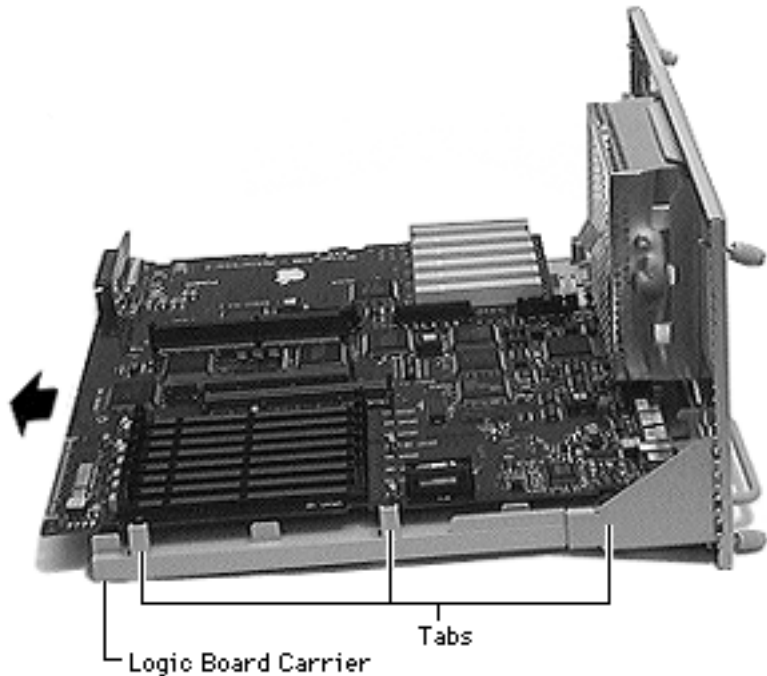

- 5 Lift the tabs on the logic board carrier, slide the logic board to the left, and lift the board up and out of the logic board carrier.





## Mezzanine Interconnect Board

Before you begin, disconnect the power cord, slide the rear drawer out and remove the following:

- Rear panel
- Top cover

**Caution:** Review the ESD precautions in Bulletins/ Safety.



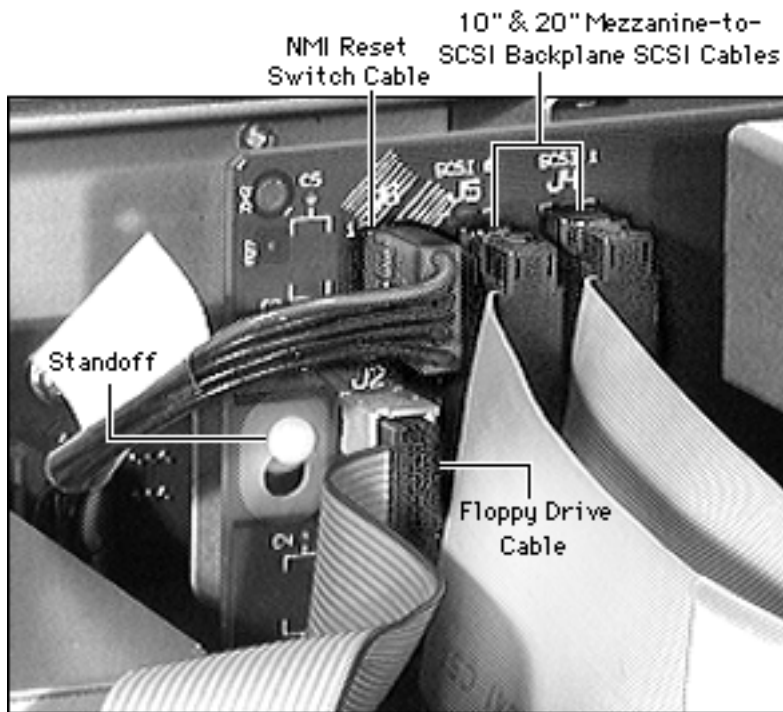

- 1 Disconnect the following from the mezzanine interconnect board:
  - Mezzanine-to-floppy drive cable
  - The 10-inch and 20-inch mezzanine-to-SCSI backplane SCSI cables
  - NMI reset switch cable





Standoff Screw Mezzanine-to-Front Panel Cable Screw

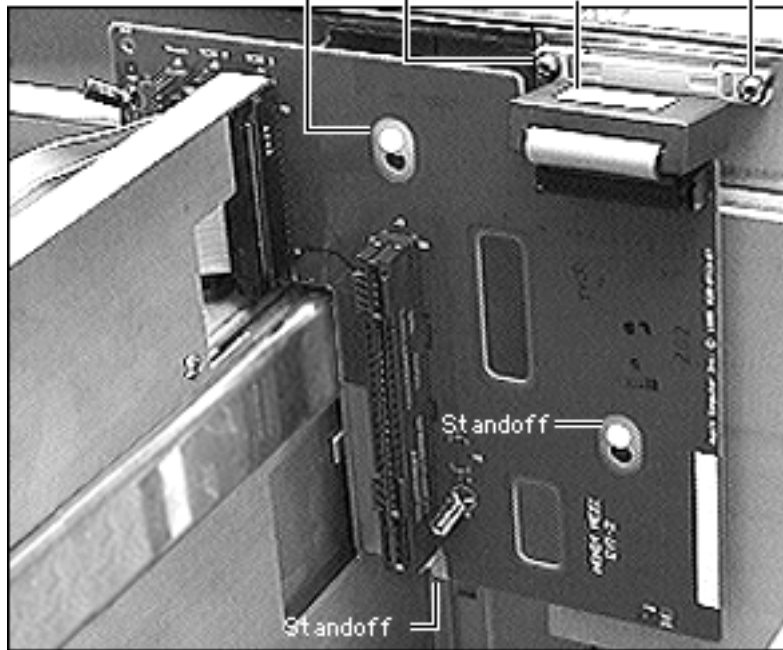

- 2 Remove the mezzanine interconnect board by pulling it up and away from the standoffs holding it.
- 3 Rotate the mezzanine interconnect board and disconnect the mezzanine-to-front panel cable.







## Mezzanine-to-Front Panel Cable

Before you begin slide the rear drawer out and remove the following:

- Rear panel
- Top cover
- LCD, speaker, keylock cable

**Caution:** Review the ESD precautions in Bulletins/ Safety.



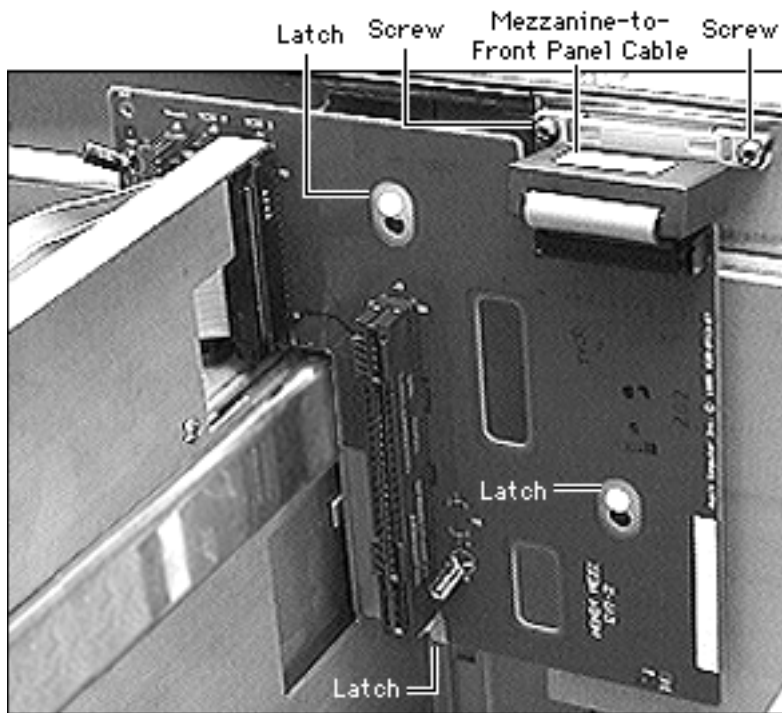

Remove the two screws that attach the mezzanine-to-front panel cable to the server chassis.



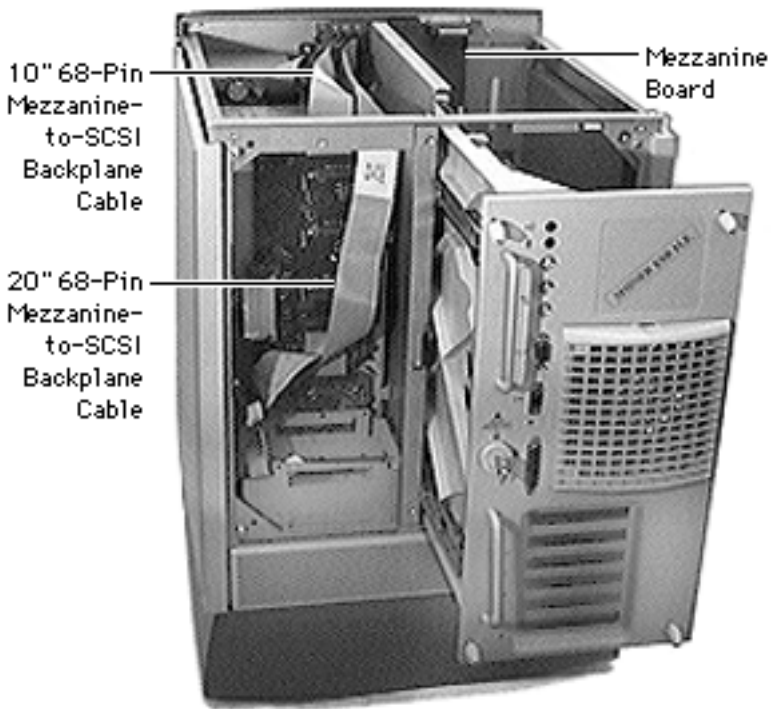

## Mezzanine-to-SCSI Backplane Cables

Before you begin disconnect the power cord and slide the rear drawer out and remove the following:

- Rear panel
- Top cover

**Caution:** Review the ESD precautions in Bulletins/ Safety.



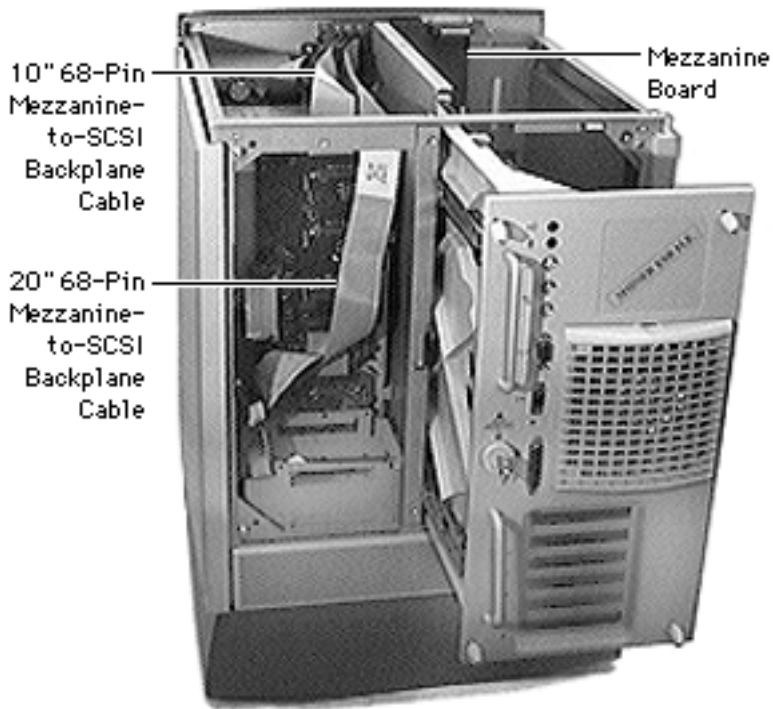

Disconnect the 10-inch and 20-inch 68-pin mezzanine-to-SCSI backplane cables from the mezzanine interconnect board and from the SCSI backplane board.



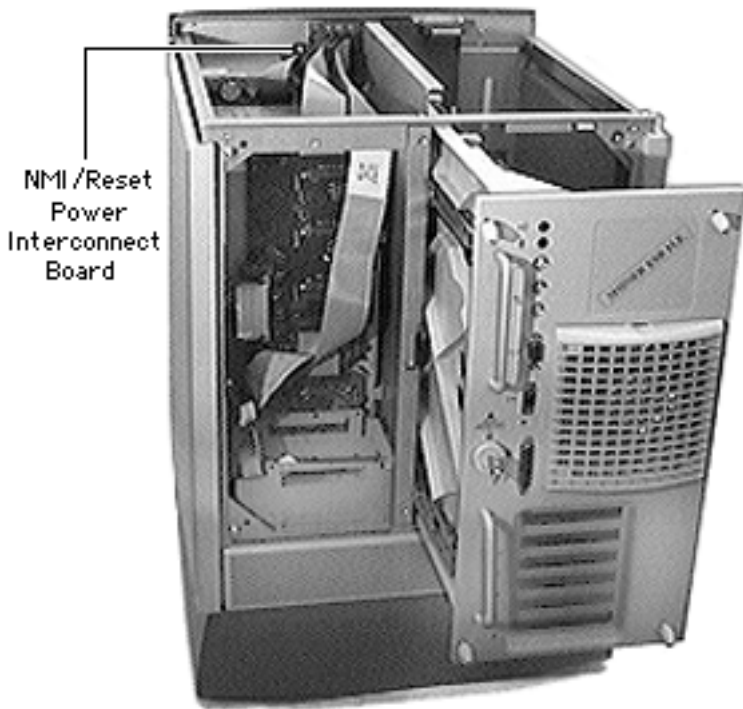

## NMI / Reset Power Interconnect Board

Before you begin, disconnect the power cord and slide the rear drawer out and remove the following:

- Rear panel
- Top cover

**Caution:** Review the ESD precautions in Bulletins/ Safety.





NMI/Reset Power Interconnect Board

NMI/Reset Switch Cable

- 1 Disconnect the NMI reset switch cable.
- 2 Rotate the mezzanine interconnect board and disconnect the mezzanine-to-front panel cable shown previously.



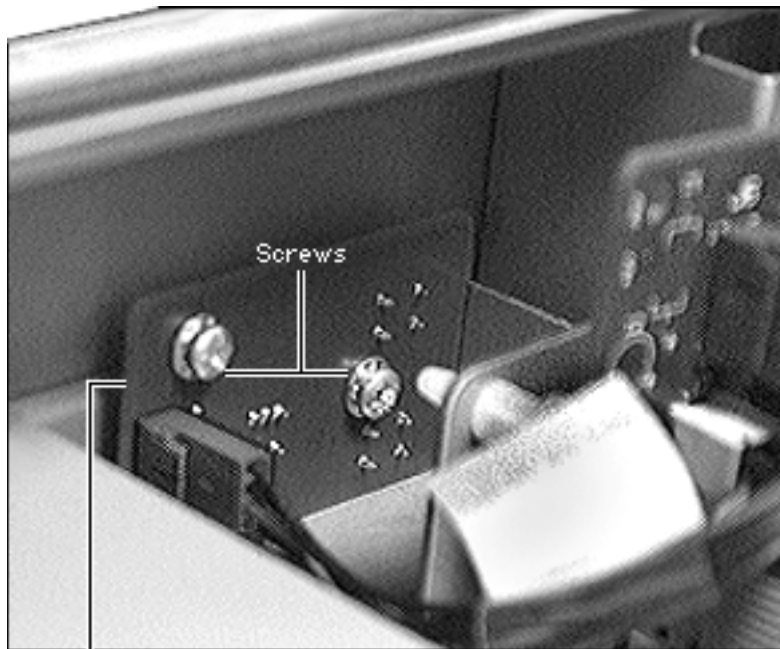

NMI/Reset Power  
Interconnect Board

- 3 Pull the mezzanine interconnect board up to move it out of the way.
- 4 Remove the two screws holding the NMI/reset power interconnect board and remove the board.



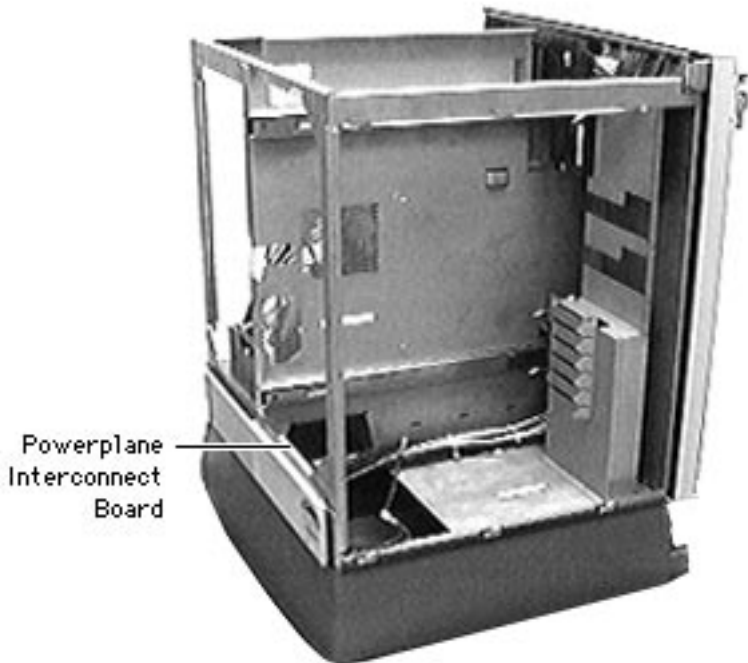

## Powerplane Interconnect Board (NS 700 Series)

Before you begin, disconnect the power cord and remove the following:

- Rear drawer
- Rear panel
- Top cover
- Left side panel
- Left duct
- Base door
- Power supply







Power Backplane-to-  
Logic Board Cable

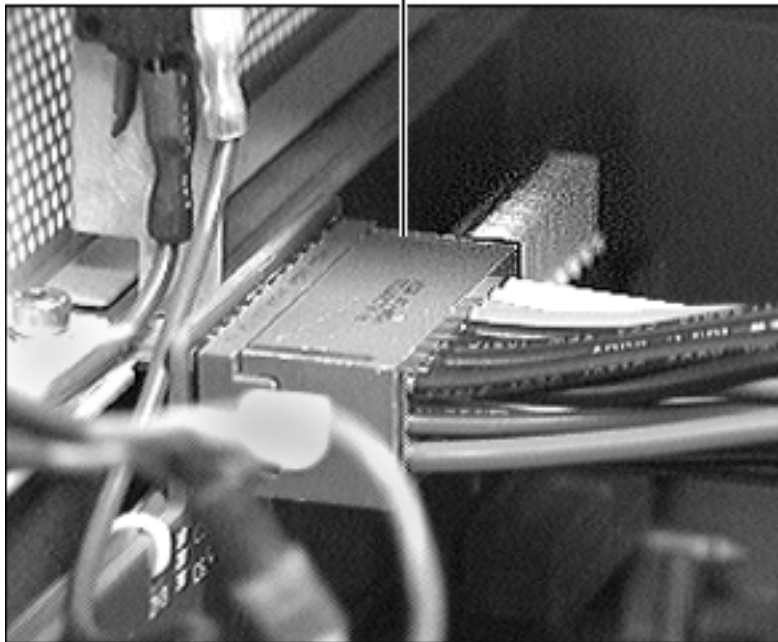

- AC interlock receptacle ground cable

**Caution:** Review the ESD precautions in Bulletins/ Safety.

**Note:** Depress the security tabs on the Power backplane-to-logic board cable connector.

- 1 Disconnect the power backplane-to-logic board cable from the powerplane interconnect board.





Power Backplane-to-SCSI Backplane Cable

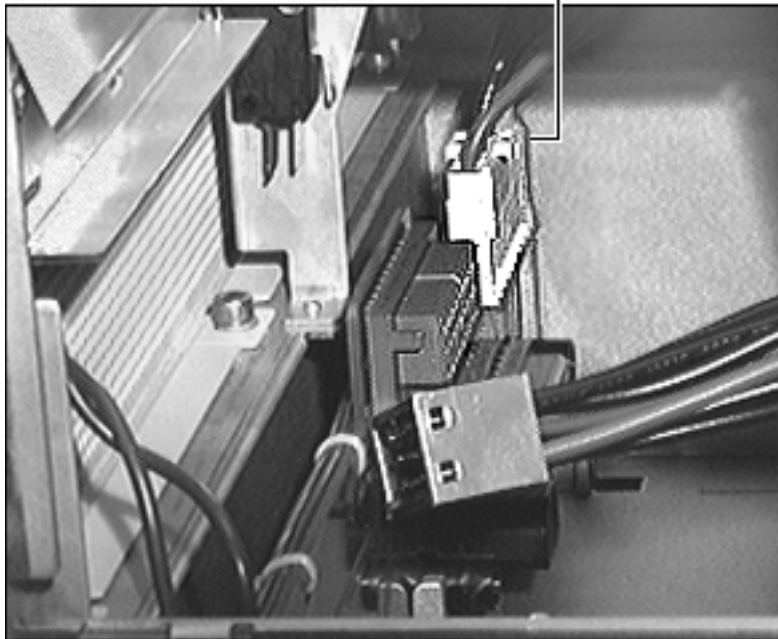

- 2 **Note:** Depress the security tabs on the Power backplane-to-SCSI backplane cable connector.

Disconnect the power backplane-to-SCSI backplane cable from the powerplane interconnect board.



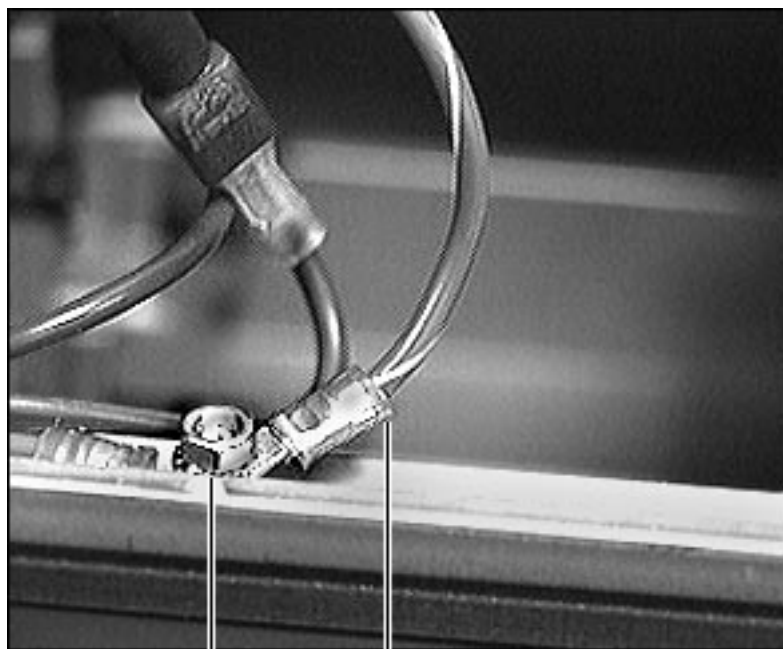

Nut

Ground Cables

- 3 Disconnect the ground cables from the main chassis by removing the nut.



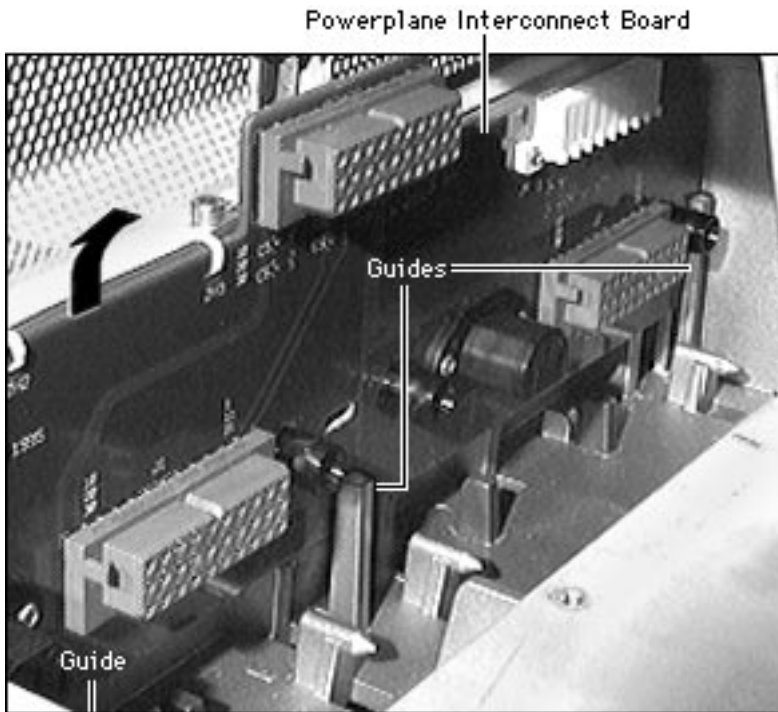

- 4 Lift up and slide the powerplane interconnect board out of the main unit.

**Replacement Note:** When replacing the powerplane interconnect board, slide the board into the guides and then drop it down.





## Power Backplane-to-Logic Board Cable (NS 700 Series)

Before you begin, disconnect the power cord and remove the following:

- Rear drawer
- Left panel
- Left duct



Power Backplane-to-Logic Board Cable





Power Backplane-to-  
Logic Board Cable

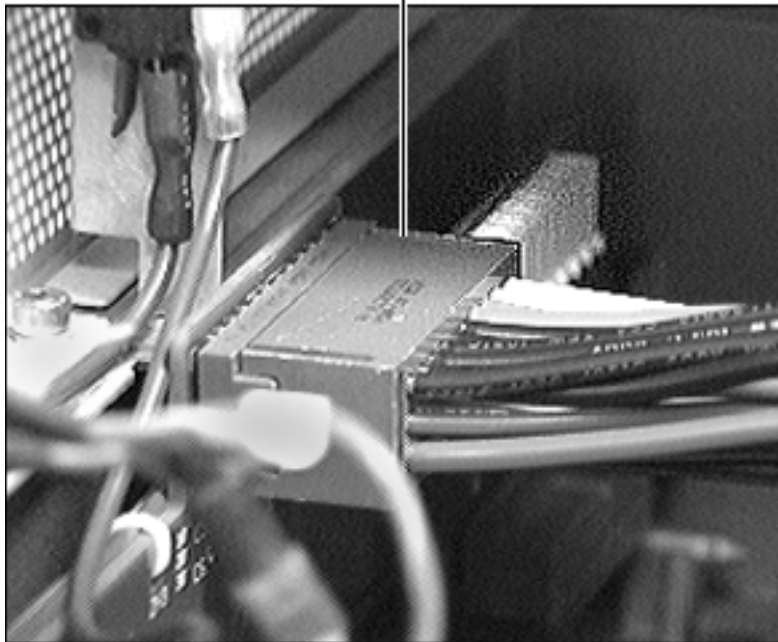

- 1 Disconnect the power backplane-to-logic board cable from the powerplane interconnect board.



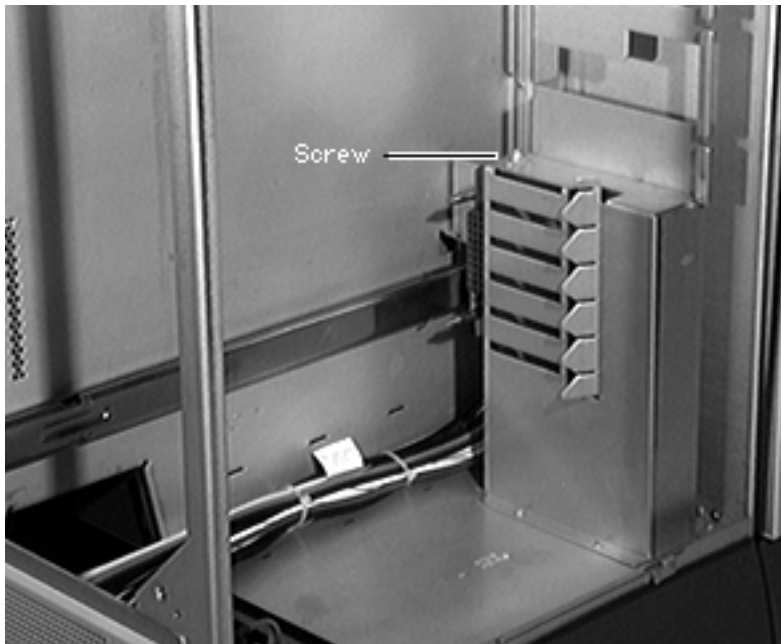

- 2 Detach the power backplane-to-logic board cable from the main chassis by removing the screw.





## SCSI Backplane Interconnect Board

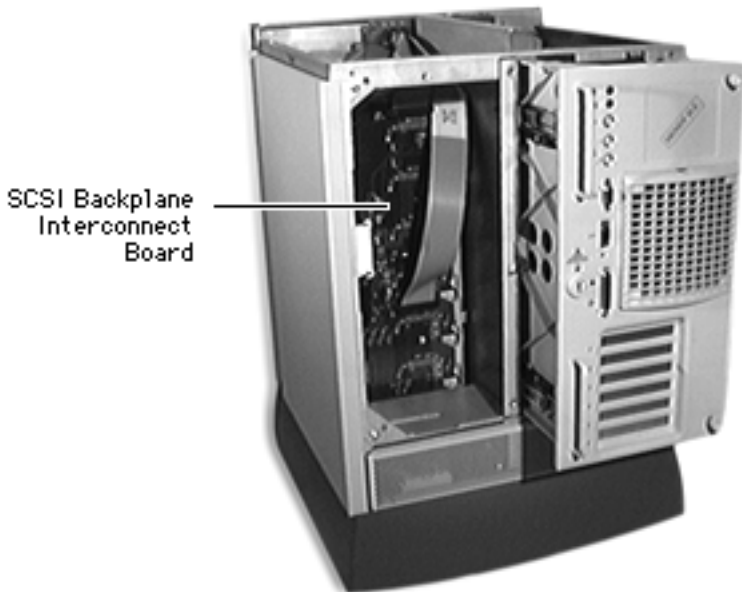

Before you begin, disconnect the power cord, slide the rear drawer out and remove the following:

- Rear panel
- Top cover
- Rear hard drives bracket (NS 700 Series only)

**Caution:** Review the ESD precautions in Bulletins/ Safety.

**Note:** Remove all SCSI devices.





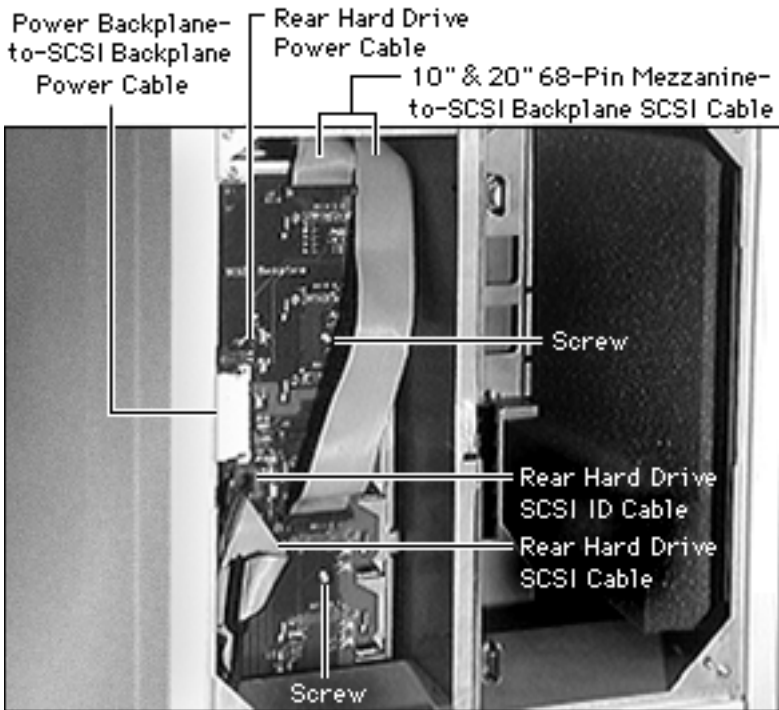

- 1 Disconnect the following from the SCSI backplane interconnect board:
  - Power backplane-to-SCSI backplane power cable
  - 10-inch and 20-inch 68-pin mezzanine to-SCSI backplane cables
  - Rear hard drives SCSI cable (if installed)
  - Rear hard drives SCSI ID cable (if installed)
  - Rear hard drive power cable (if installed)



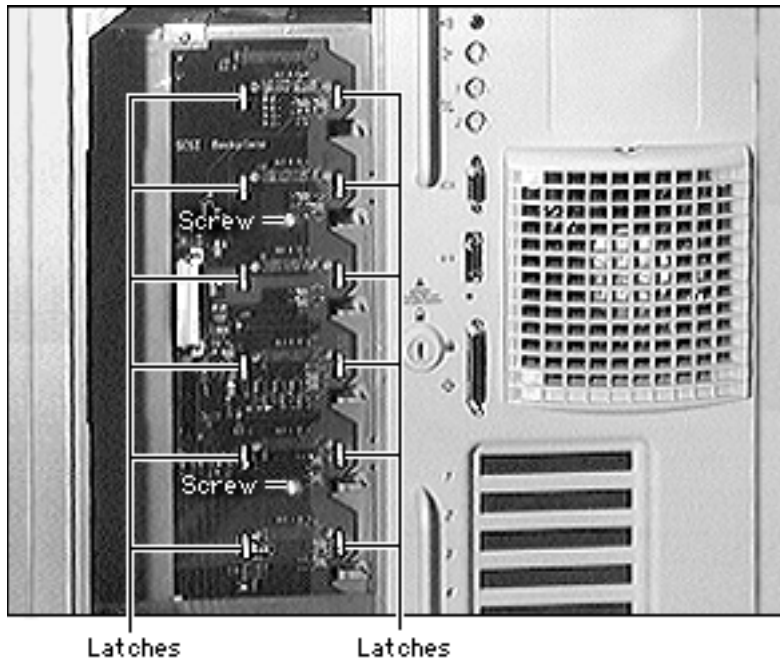

- 2 Remove the two screws located on the SCSI backplane interconnect board.
- 3 Remove the SCSI backplane interconnect board by sliding it out from the latches towards you.



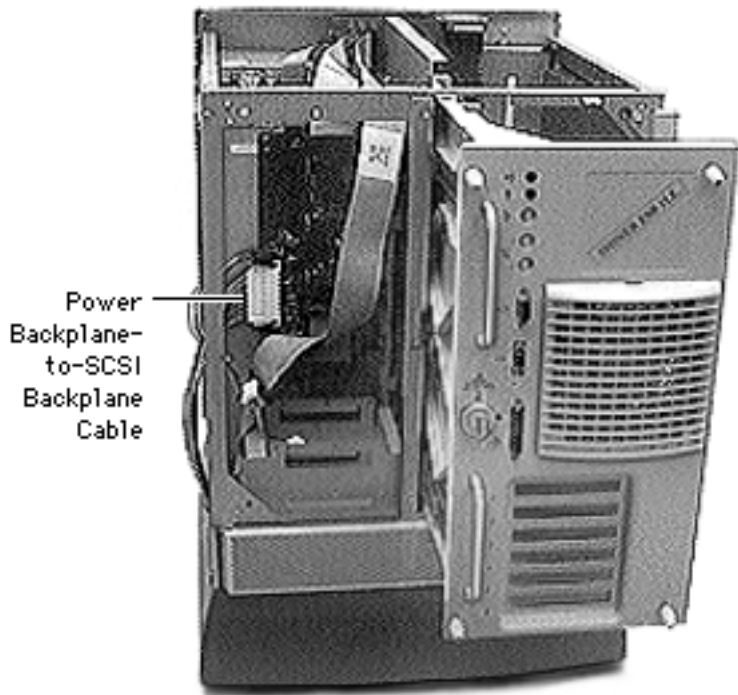

## Power Backplane-to-SCSI Backplane Cable

Before you begin, disconnect the power cord, slide the rear drawer out and remove the following:

- Rear panel
- Top cover
- Right side panel

**Caution:** Review the ESD precautions in Bulletins/ Safety.





Power Backplane-to-SCSI Backplane Cable

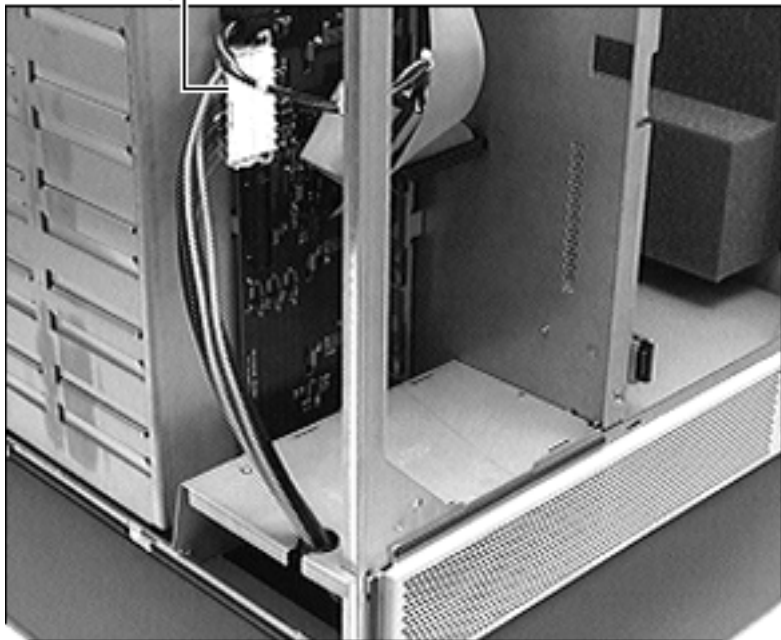

Remove the power backplane-to-SCSI backplane cable.





## Battery

Before you begin,  
disconnect the power cord.

**Caution:** Review the ESD  
precautions in Bulletins/  
Safety.



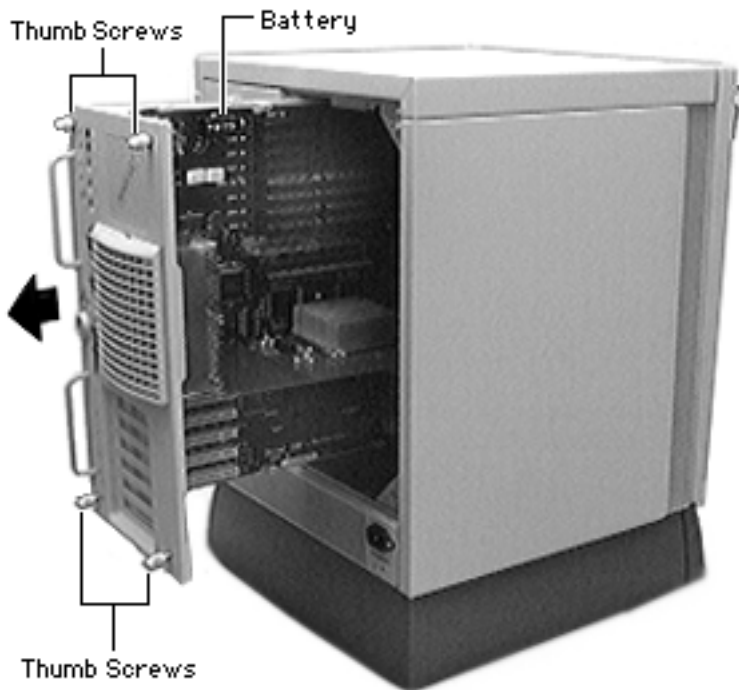

- 1 With the back of the server facing you, turn the key in the rear drawer lock to the upright (unlocked) position.
- 2 Loosen the four thumb screws on the rear drawer and slide the rear drawer out.

**Note:** Do not detach the rear drawer from the drawer slides.



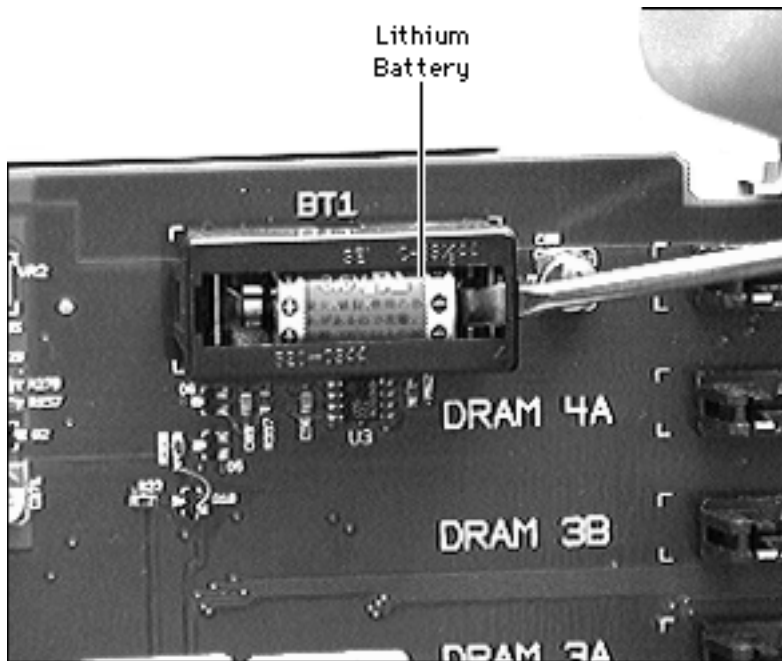

- 3 Using a small screwdriver, lift off the battery cover.
- 4 Carefully remove the battery from its holder.



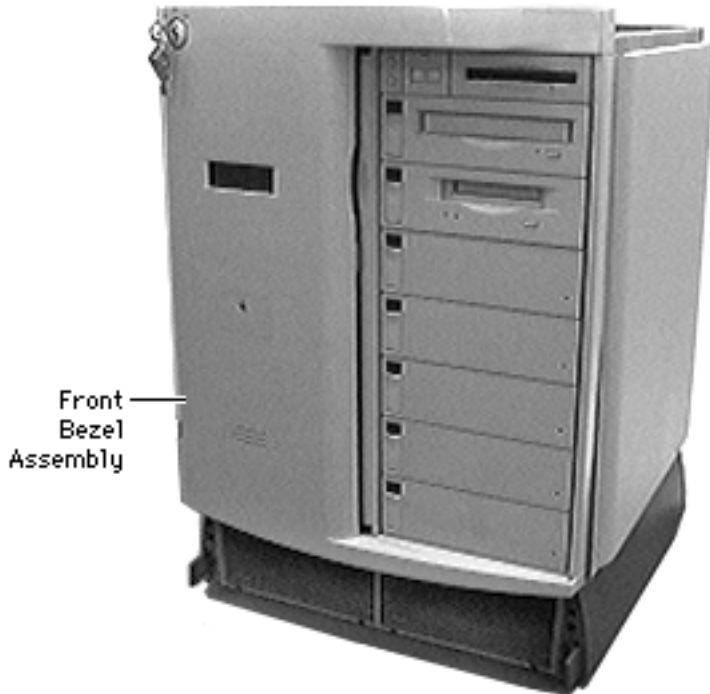

Front Bezel Assembly

## Front Bezel Assembly

Before you begin, disconnect the power cord and slide the rear drawer out and remove the following:

- Rear panel
- Top cover
- Base door

**Note:** Turn the front lock key to the left (service) position.







**Caution:** Review the ESD precautions in Bulletins/ Safety.

- 1 Slide the front door to the fully open position.



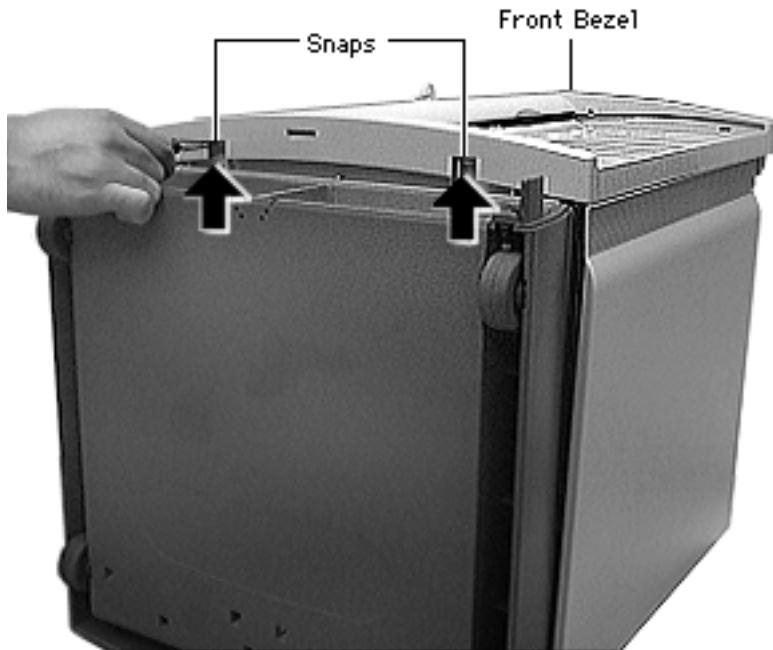

- 2 Using a screwdriver or your hands, push in the two snaps at the bottom of the front bezel and pull out to unlatch it.

**Note:** This procedure frees the lower side of the front bezel.



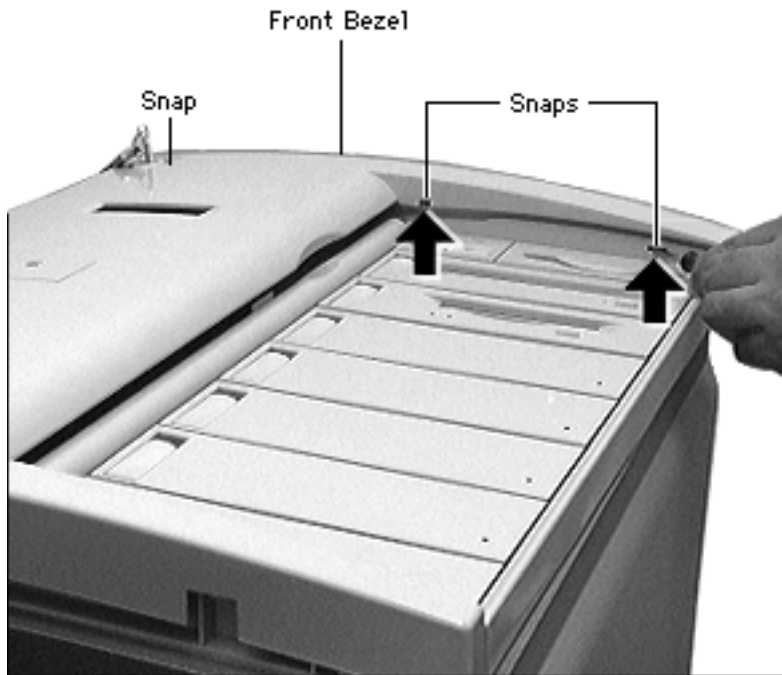

**Caution:** Be careful when pulling the front bezel out, as excessive force may damage the bezel.

- 3 Using a screwdriver, push in the three snaps on the top of the front bezel.



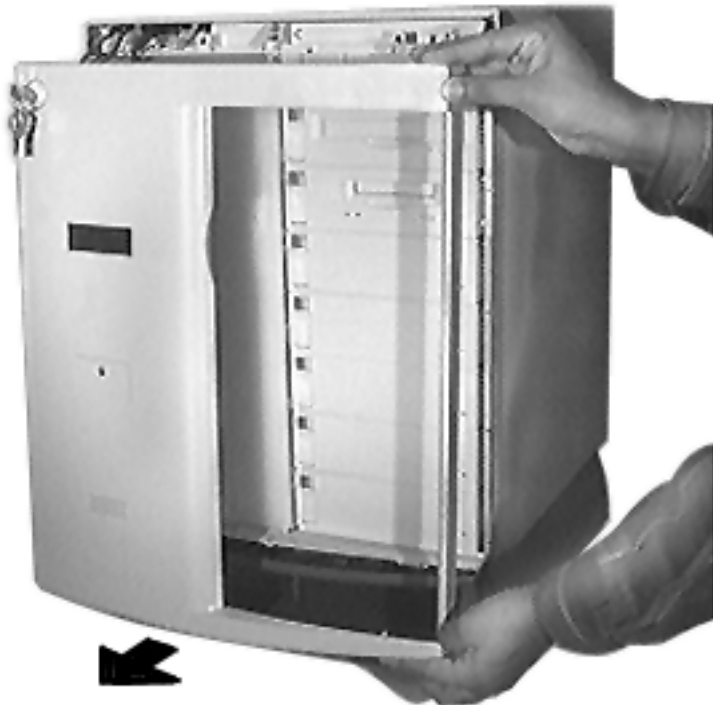

- 4 Carefully pull the bezel out and away from the unit.



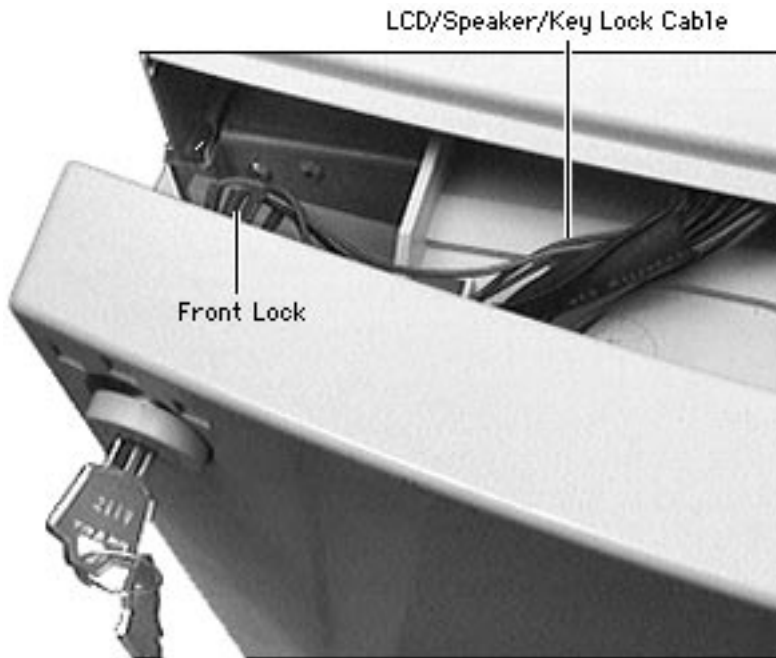

- 5 Disconnect the LCD/speaker/keylock cable.
- 6 If you are replacing the front bezel, remove the following from the front panel:
  - LCD/speaker/keylock cable
  - LCD display
  - Torsion spring
  - Lock link and lock shaft

**Note:** Be careful when removing the LCD/speaker/keylock cable because it is very fragile.



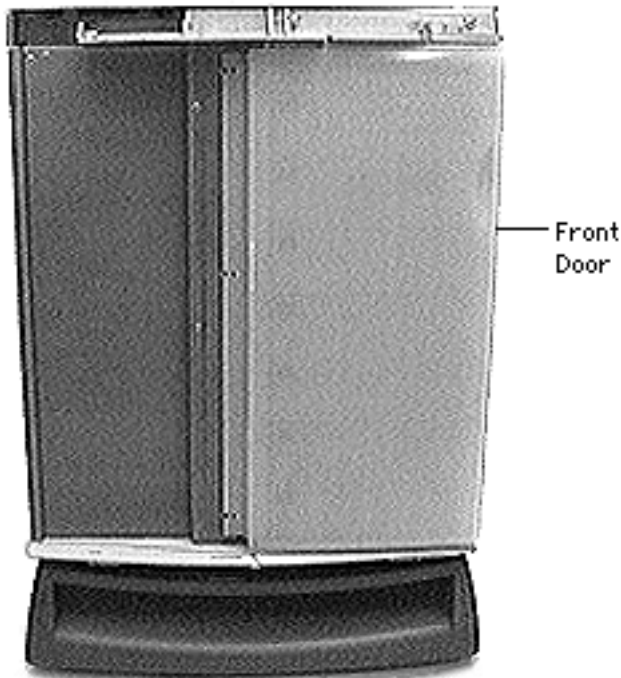

## Front Door

Before you begin, disconnect the power cord and remove the following:

- Rear panel
- Top cover
- Base door
- Front bezel assembly

**Note:** Turn the front lock key to the upright (unlocked) or left (service) position.



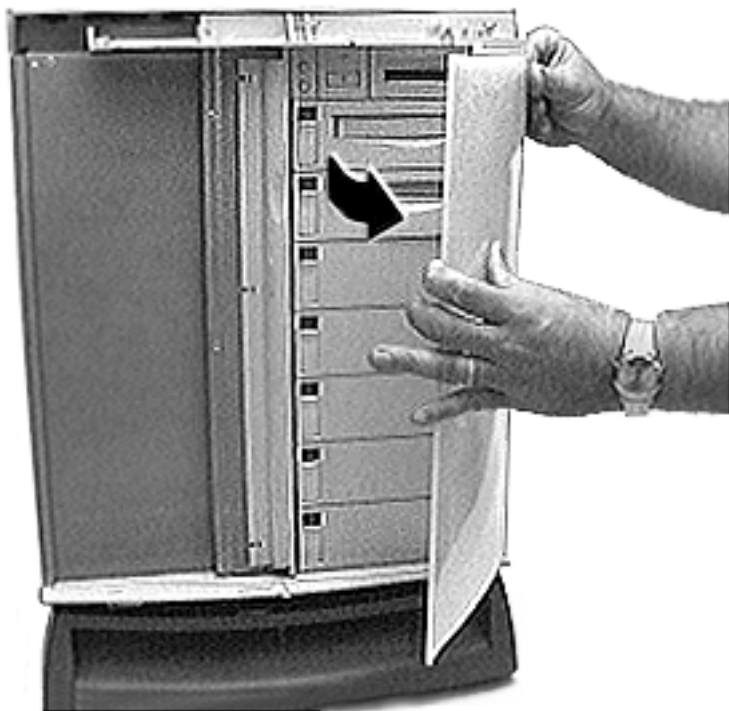

Slide the front door all the way to the right and remove it.





## Top Shelf

Before you begin, disconnect the power cord, slide the rear drawer out and remove the following:

- Rear panel
- Top cover
- Base door
- Front bezel assembly
- Front door

**Note:** Turn the front lock key to the upright (unlocked) or left (service) position.





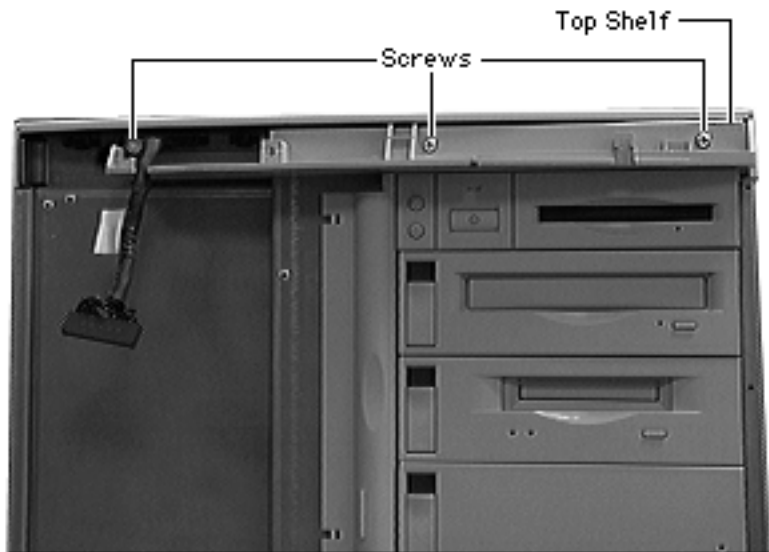

**Caution:** Review the ESD precautions in Bulletins/ Safety.

Remove the three screws and remove the top shelf.





## Bottom Shelf

Before you begin, disconnect the power cord, slide the rear drawer out and remove the following:

- Rear panel
- Top cover
- Base door
- Front bezel assembly
- Front door

**Note:** Turn the front lock key to the upright (unlocked) or left (service) position.



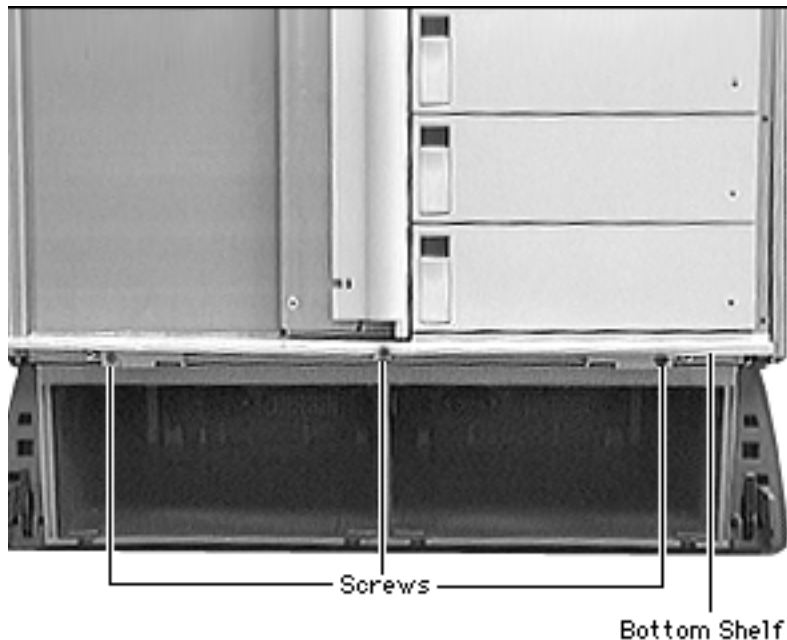

**Caution:** Review the ESD precautions in Bulletins/ Safety.

Remove the three screws and remove the bottom shelf.



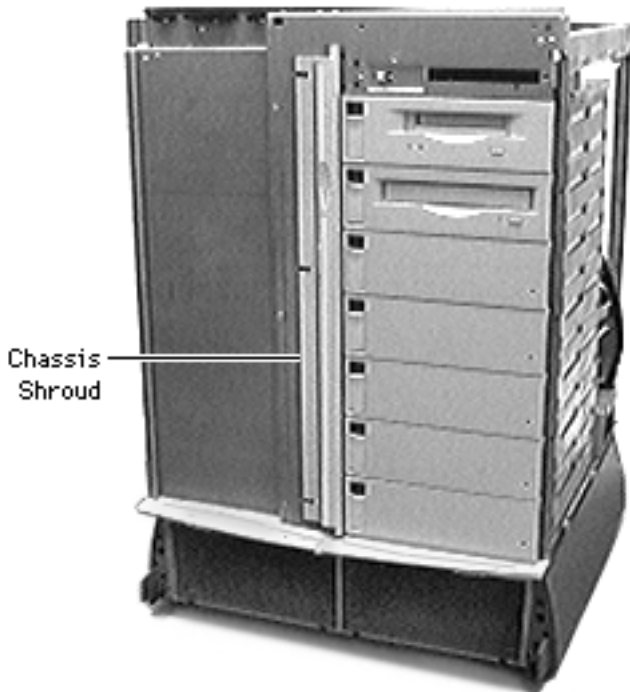

## Chassis Shroud

Before you begin, disconnect the power cord and slide the rear drawer out and remove the following:

- Rear panel
- Top cover
- Base door
- Front bezel assembly
- Front door
- Top shelf

**Note:** Turn the front lock key to the upright (unlocked) or left (service) position.



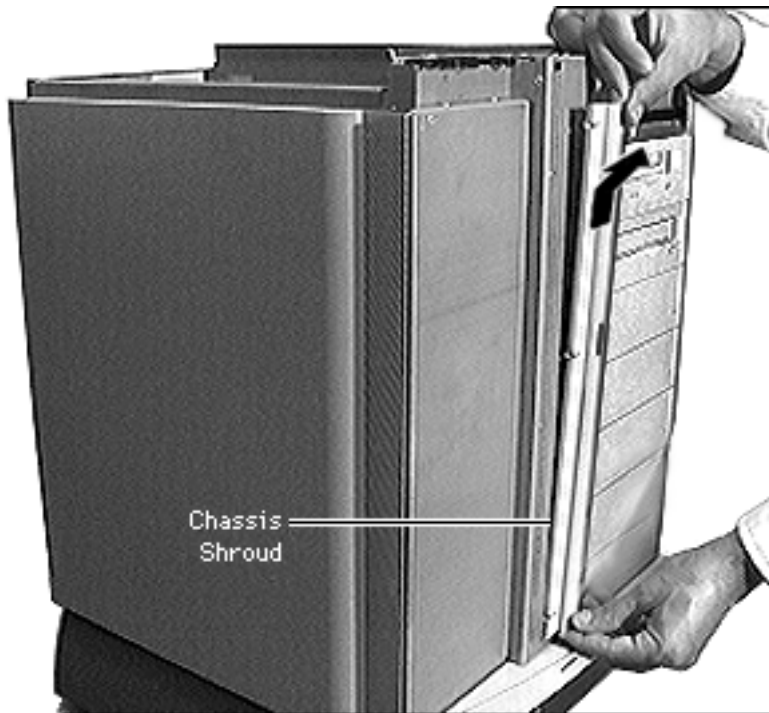

**Caution:** Review the ESD precautions in Bulletins/ Safety.

Slide the chassis shroud all the way up and pull it out.



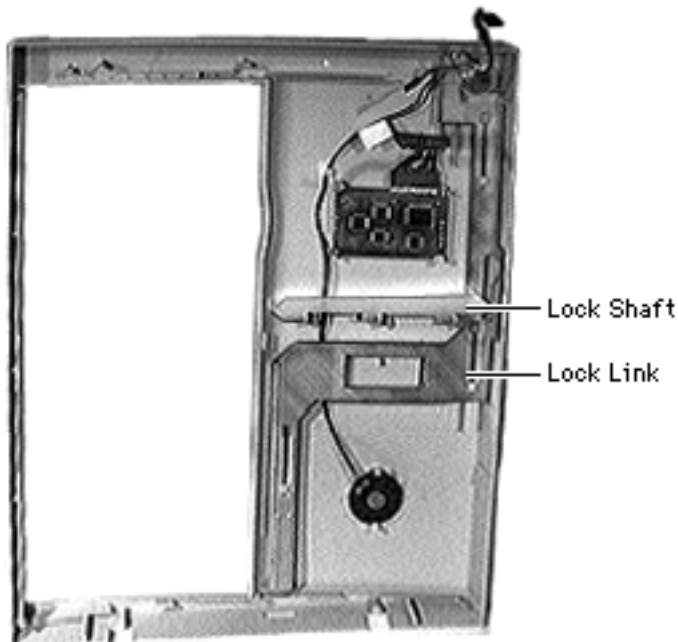

## Lock Link and Lock Shaft

Before you begin, disconnect the power cord and slide the rear drawer out and remove the following:

- Rear panel
- Top cover
- Base door
- Front bezel assembly

**Note:** Turn the front lock key to the upright (unlocked) position.





Lock Shaft

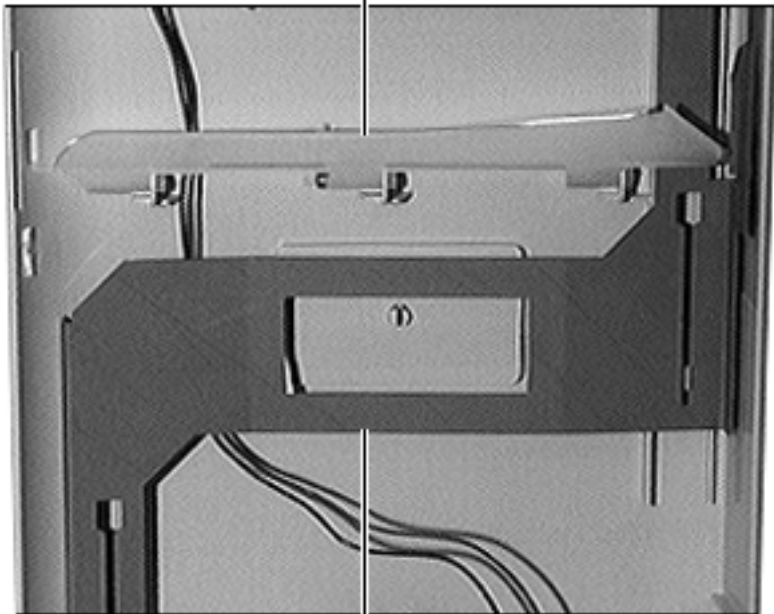

Lock Link

**Caution:** Review the ESD precautions in Bulletins/ Safety.

- 1 Remove the lock shaft.
- 2 Remove the lock link.



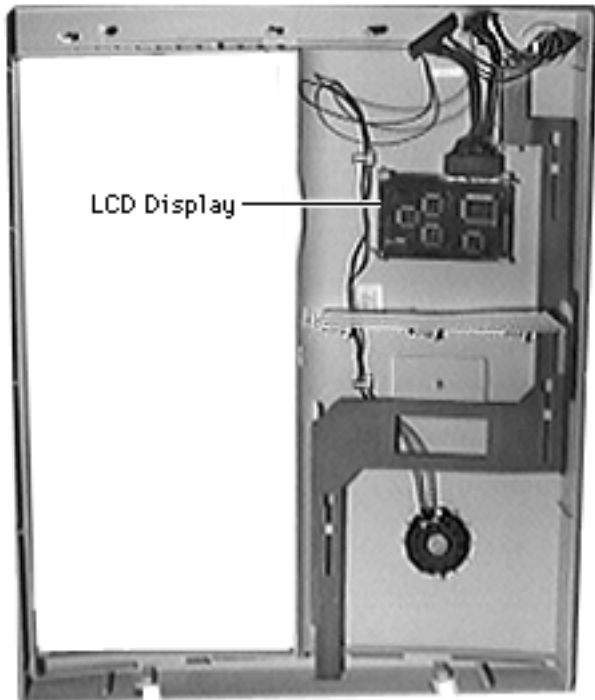

## LCD Display

Before you begin, disconnect the power cord, slide the rear drawer out and remove the following:

- Rear panel
- Top cover
- Base door
- Front bezel assembly

**Note:** Turn the front lock key to the upright (unlocked) or left (service) position.





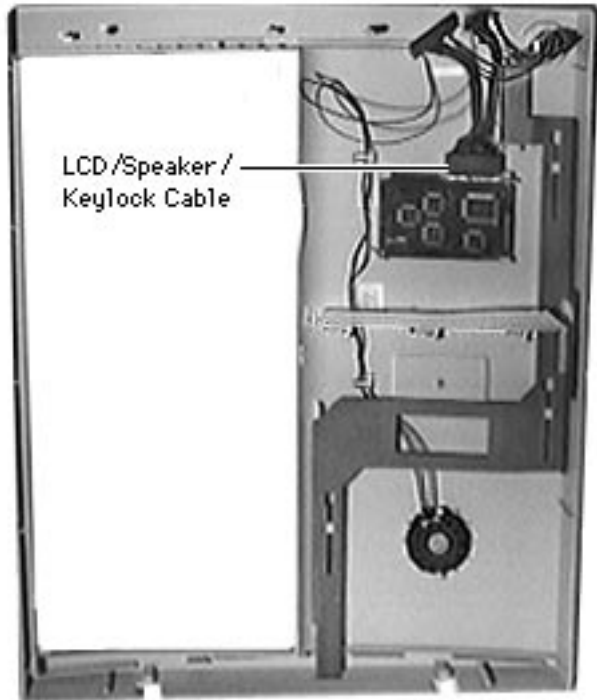

**Caution:** Review the ESD precautions in Bulletins/ Safety.

**Caution:** Always hold the LCD display by the sides and never touch any components on the board.

**Note:** The LCD display is located at the back of the front bezel assembly.

- 1 Remove the LCD/ speaker/keylock cable.



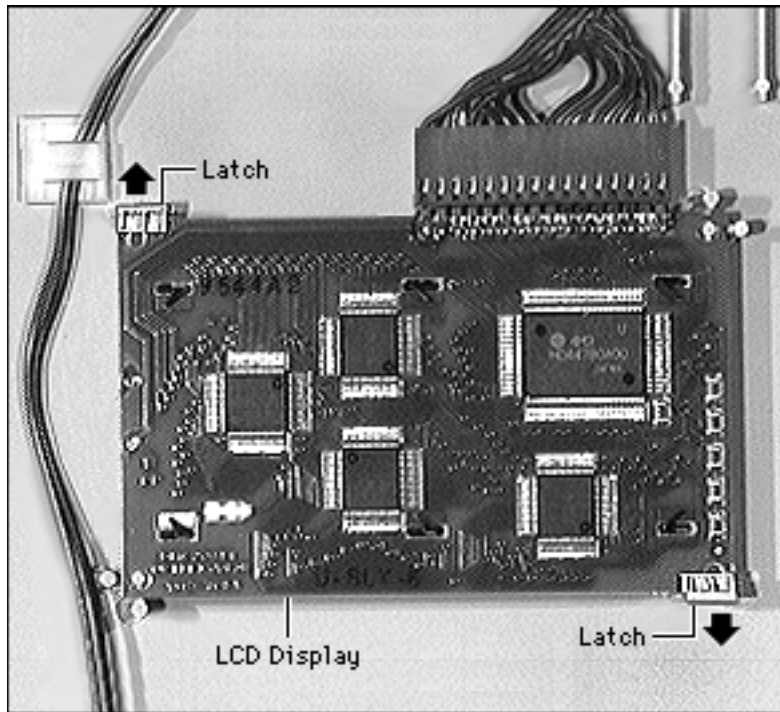

- 2 Push one of the two latches holding the LCD display and release the display.

**Replacement Note:** When you replace the LCD display, be sure that the display is facing toward the front. Align the display board so that it is inside the two latches, and then slowly push it down until it snaps.



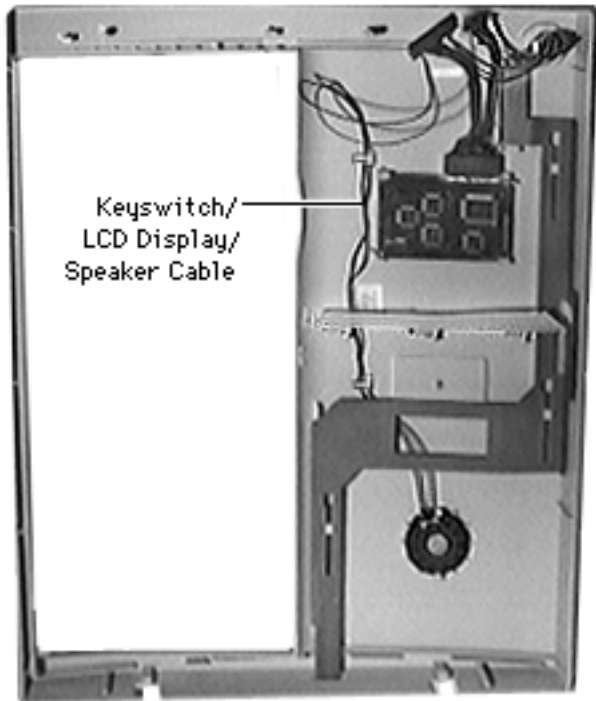

Keyswitch/  
LCD Display/  
Speaker Cable

## LCD/Speaker/ Keylock Cable

Before you begin, disconnect the power cord and slide the rear drawer out and remove the following:

- Rear panel
- Top cover
- Base door
- Front bezel assembly

**Note:** Turn the front lock key to the upright (unlocked) or left (service) position.



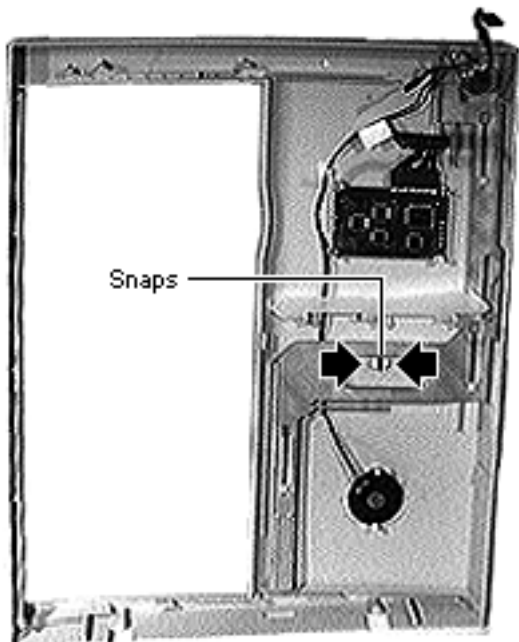

**Caution:** Review the ESD precautions in Bulletins/ Safety.

**Caution:** Do not exert force on the snaps as they may break.

- 1 Push the two snaps away from the speaker and slightly push the speaker up.
- 2 Disconnect the LCD/ speaker/keylock cable from the LCD display.



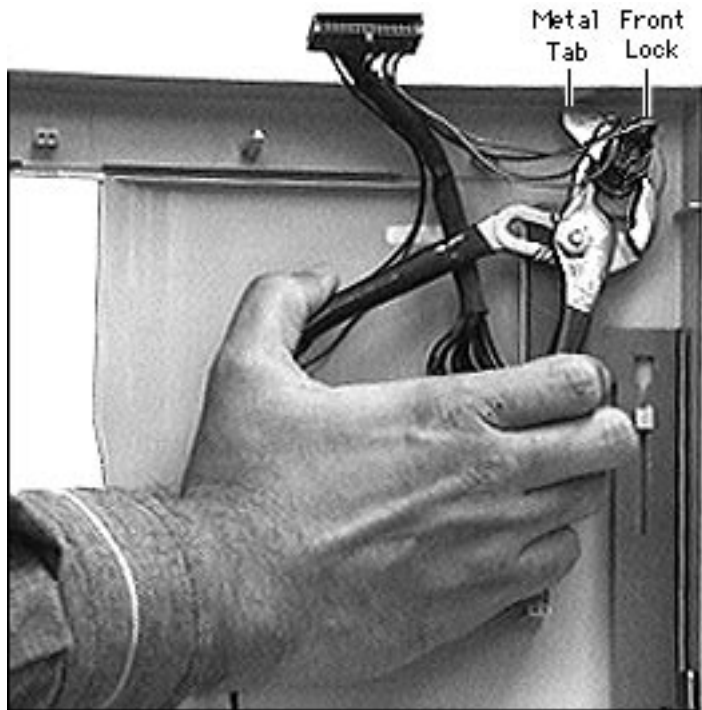

- 3 Using pliers remove the metal tab from the front lock.
- 4 Remove the front lock with the LCD/ speaker/ keylock cable.

**Replacement Note:** Make sure that the speaker gasket (located between the speaker and the front bezel assembly) is properly seated when you replace the LCD, speaker, keylock cable.



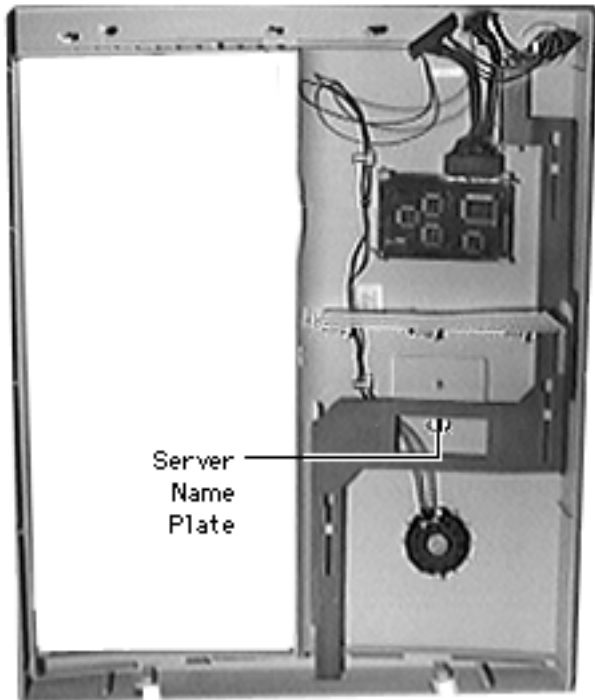

## Server Name Plate

Before you begin, disconnect the power cord and slide the rear drawer out and remove the following:

- Rear panel
- Top cover
- Base door
- Front bezel assembly

**Note:** Turn the front lock key to the upright (unlocked) or left (service) position.



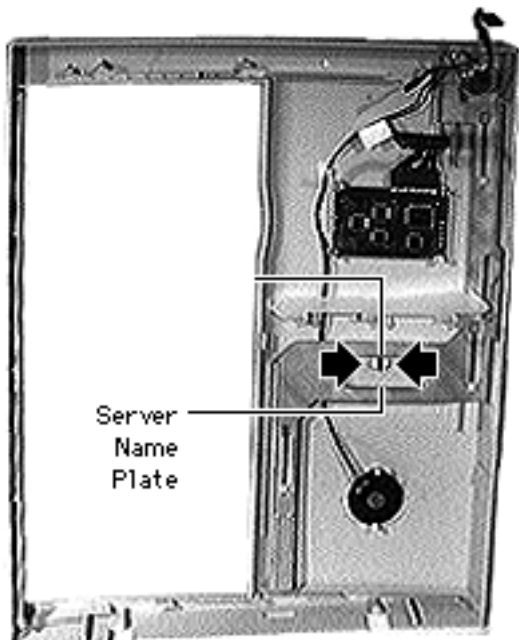

Server  
Name  
Plate

**Caution:** Review the ESD precautions in Bulletins/ Safety.

Press together the two snaps and push the server name plate down and out of the front bezel assembly.





## CD-ROM Drive

Before you begin,  
disconnect the power cord.

**Caution:** Review the ESD  
precautions in Bulletins/  
Safety.





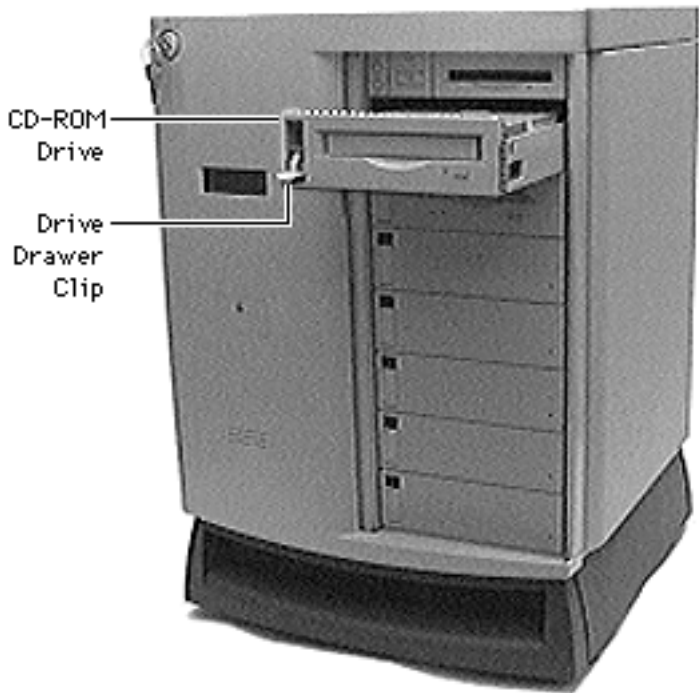

- 1 With the front lock key in the upright (unlocked) position, slide the front door to the fully open position.
- 2 Release the drive drawer clip and slide out the CD-ROM drive.

**Note:** Perform the following steps only if you are replacing the SCSI device.



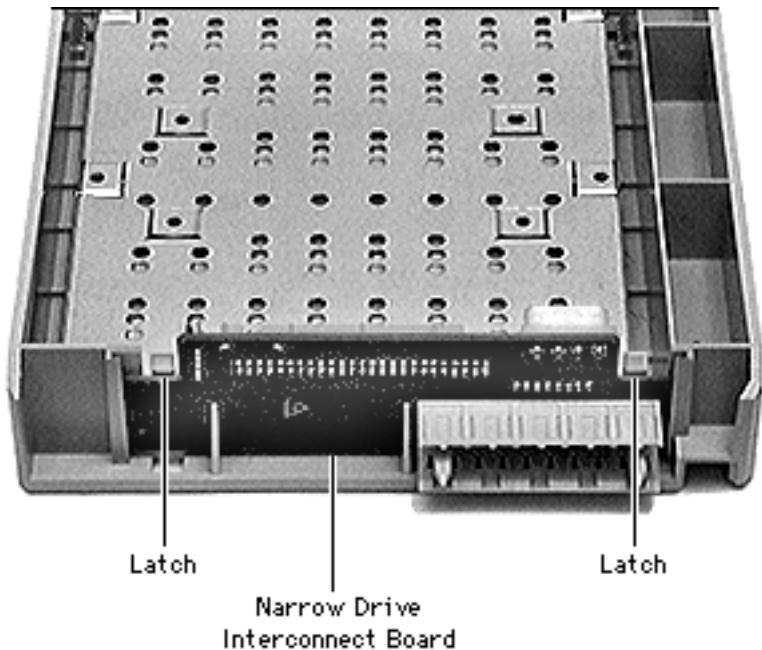

- 3 Push out the latches holding the narrow drive interconnect board and pull up the board.



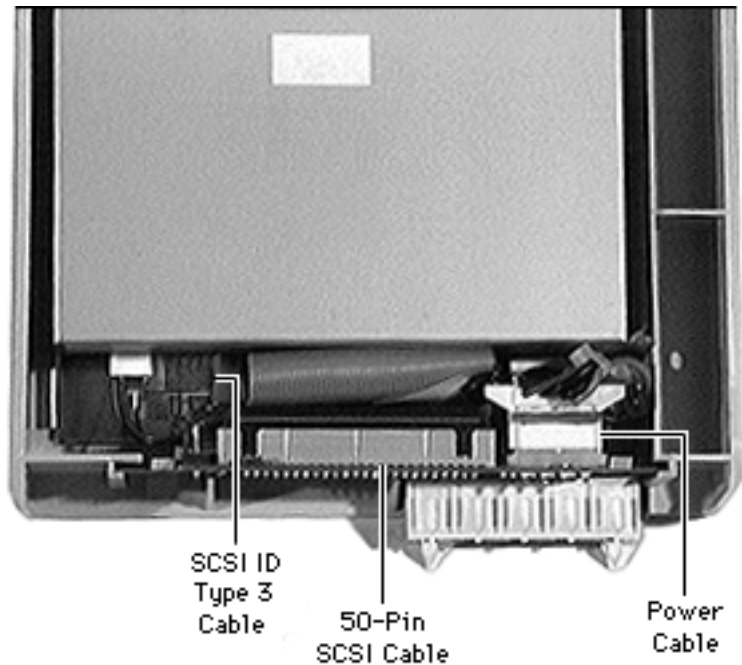

- 4 Remove the following from the CD-ROM drive:
- 50-pin SCSI cable
  - SCSI ID type 3 cable
  - Power cable



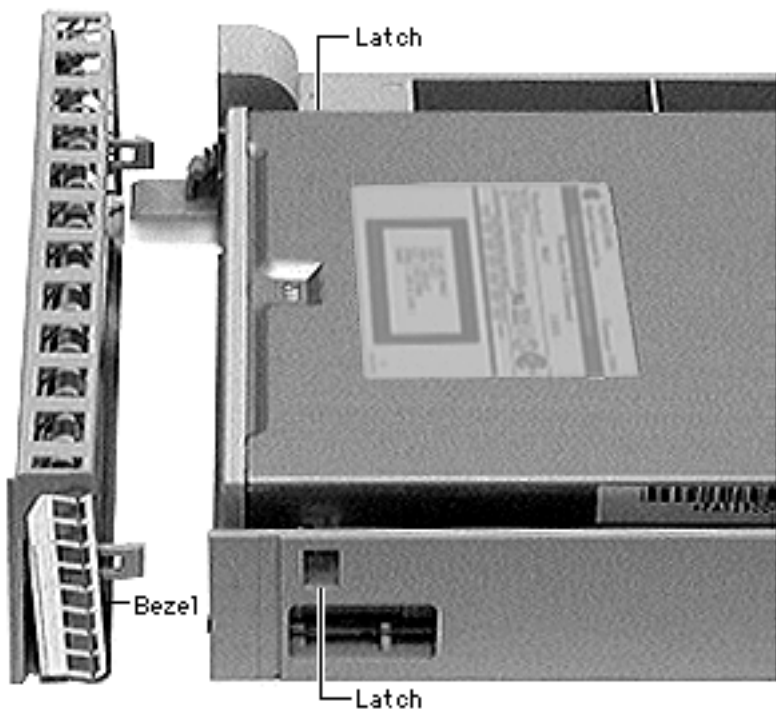

- 5 Push in the two latches located on the inside of the CD-ROM drive bezel and remove the bezel.





- 6 Remove the four CD-ROM drive mounting screws and remove the CD-ROM drive from the drive carrier.

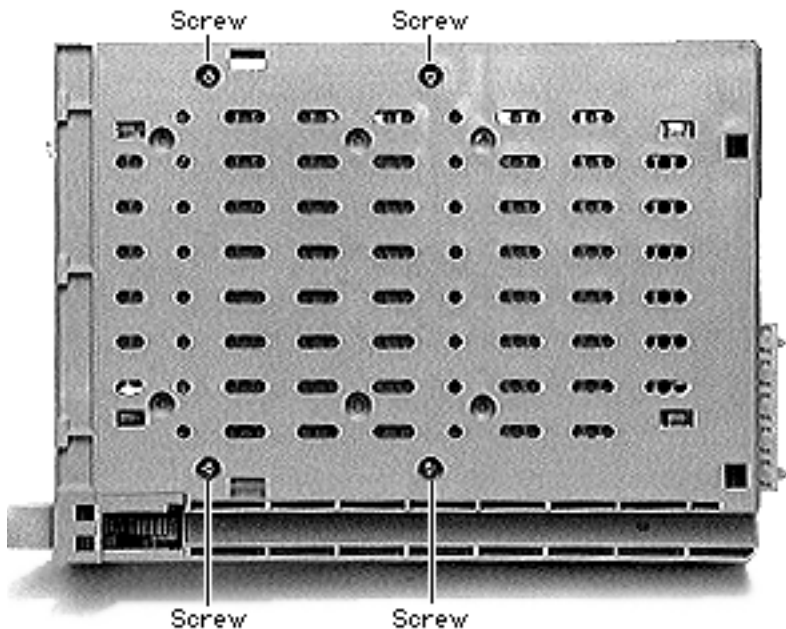



Floppy  
Drive



## Floppy Drive

Before you begin, disconnect the power cord and slide the rear drawer out and remove the following:

- Rear panel
- Top cover

**Caution:** Review the ESD precautions in Bulletins/ Safety.



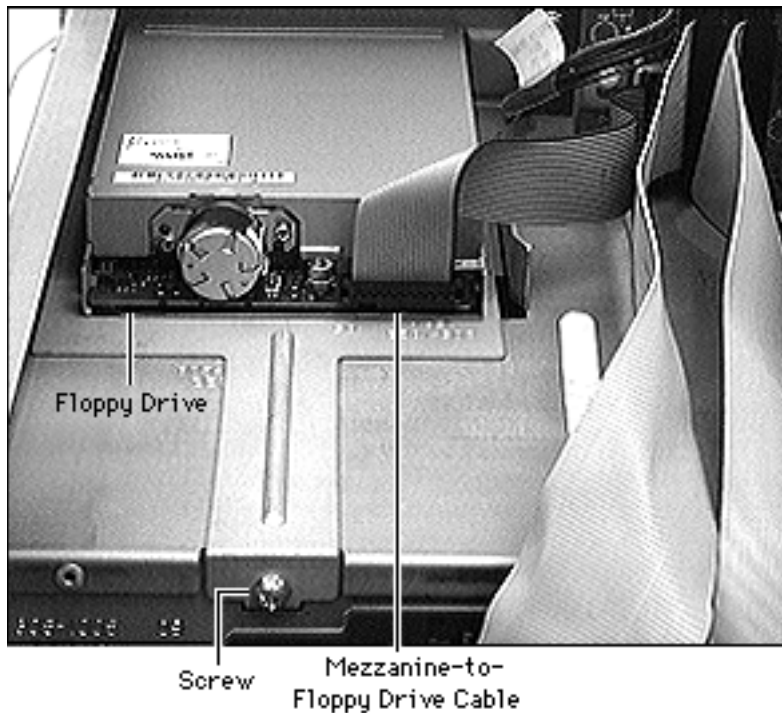

- 1 Remove the screw holding the floppy drive bracket.
- 2 Disconnect the mezzanine-to-floppy drive cable from the floppy drive.



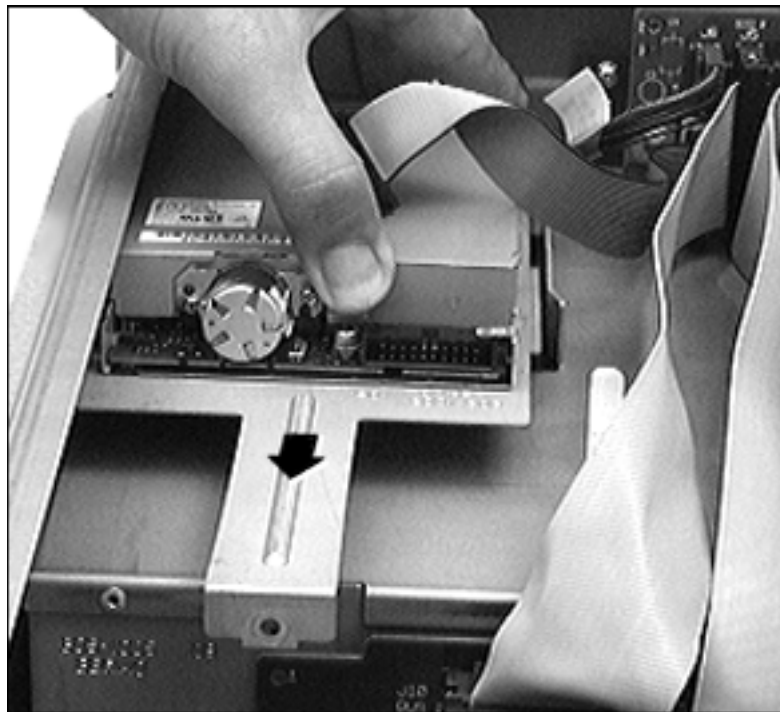

- 3 Pull out the floppy drive and bracket.







- 4 Remove the four mounting screws and remove the floppy drive from its bracket.

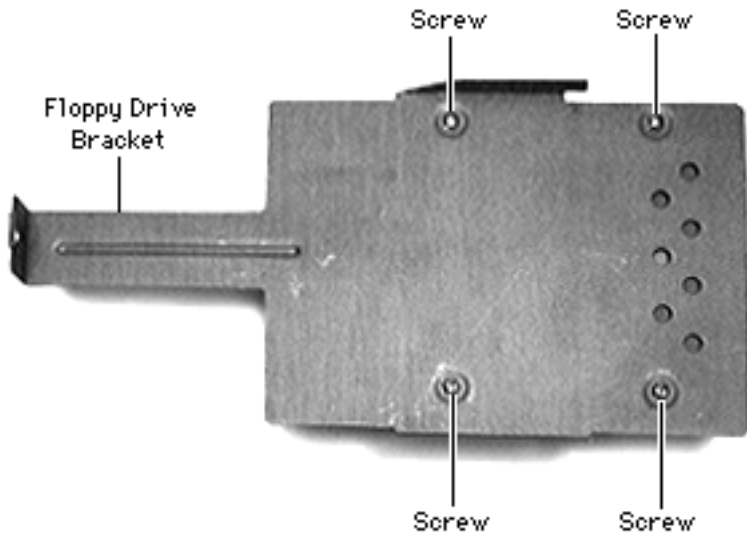

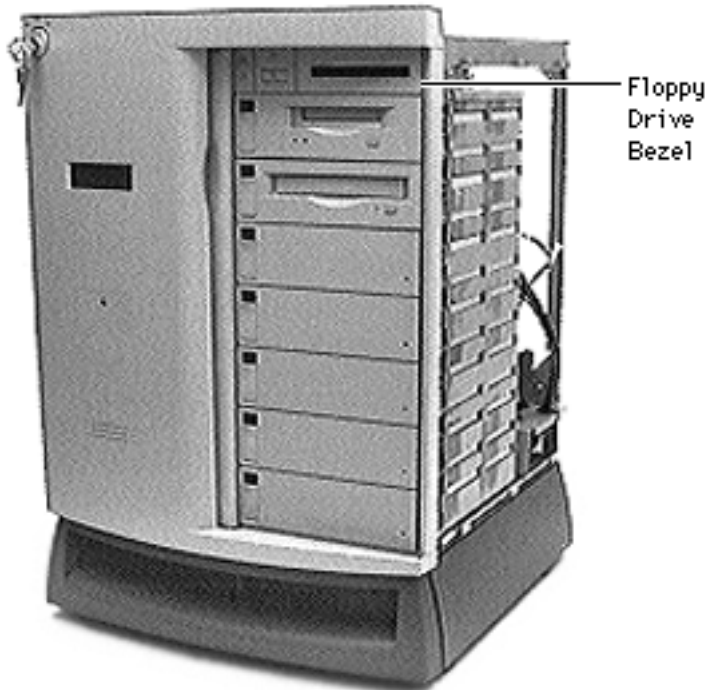

## Floppy Drive Bezel

Before you begin, disconnect the power cord and slide the rear drawer out and remove the following:

- Rear panel
- Top cover
- Right side panel

**Caution:** Review the ESD precautions in Bulletins/ Safety.





Floppy Drive Bezel

Latches

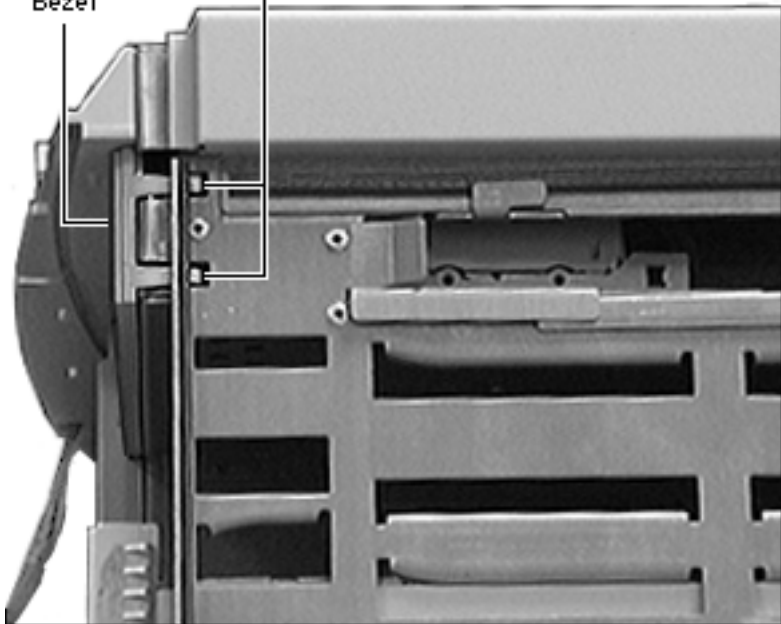

- 1 With the front lock key in the upright (unlocked) position, slide the front door to the fully open position.
- 2 Using a screwdriver, push in the two latches, and pull out the bezel.





## Tape Drive

Before you begin,  
disconnect the power cord.

**Caution:** Review the ESD  
precautions in Bulletins/  
Safety.

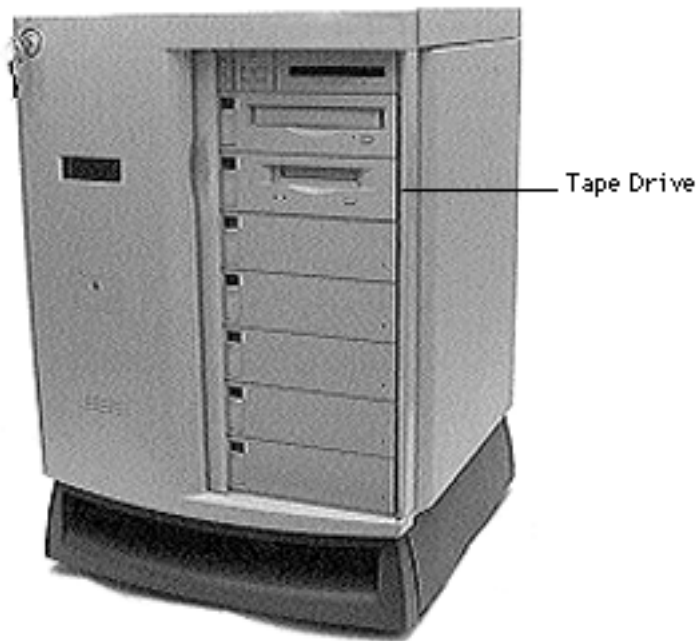

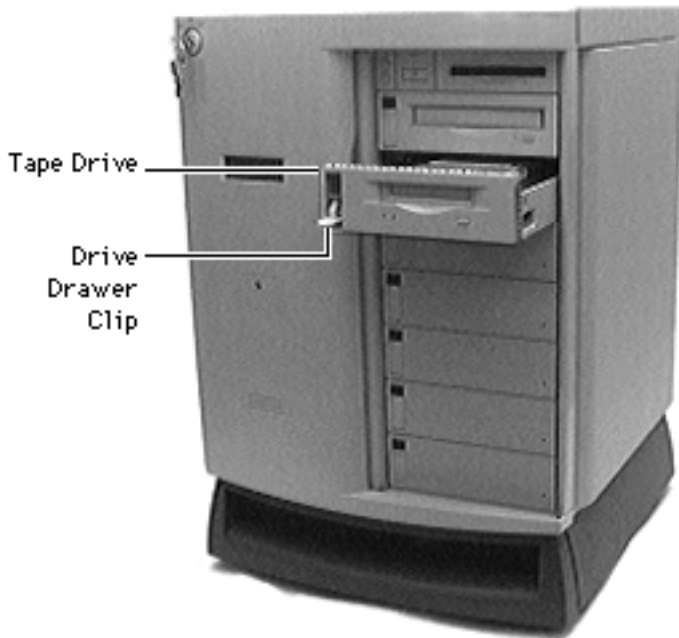

- 1 With the front lock key in the upright (unlocked) position, slide the front door to the fully open position.
- 2 Release the drive drawer clip and slide out the tape drive.

**Note:** Perform the following steps only if you are replacing the drive.



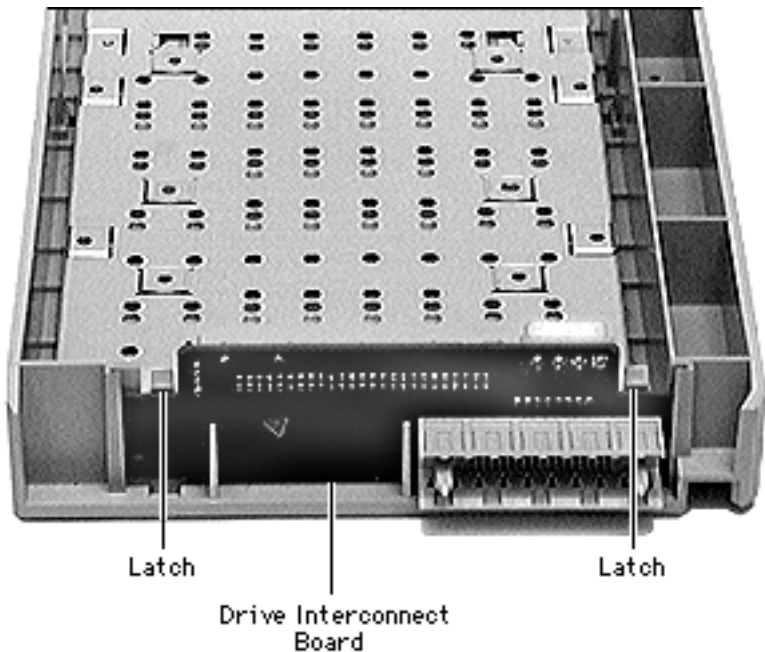

- 3 Push out the latches holding the drive interconnect board and pull up the board.



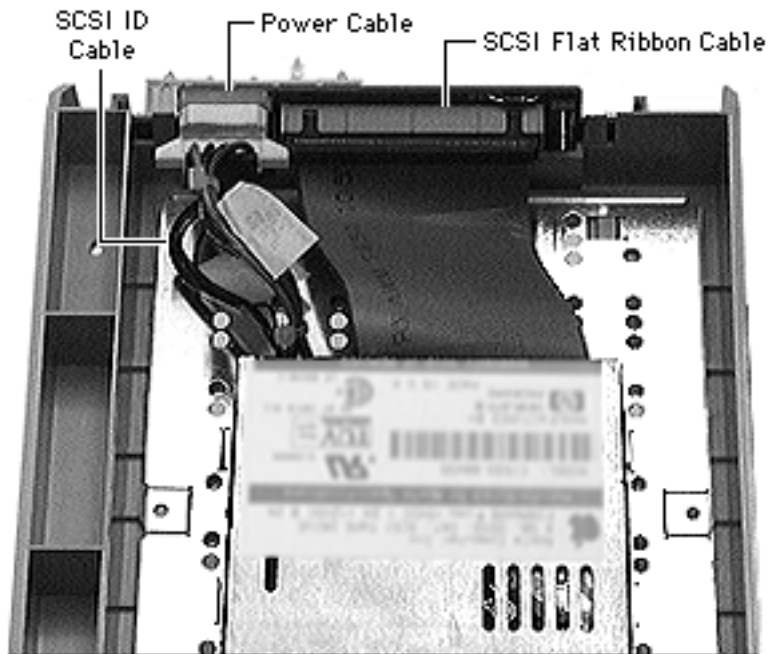

- 4 Remove the following from the tape drive:
- SCSI flat ribbon cable
  - SCSI ID cable
  - Power cable



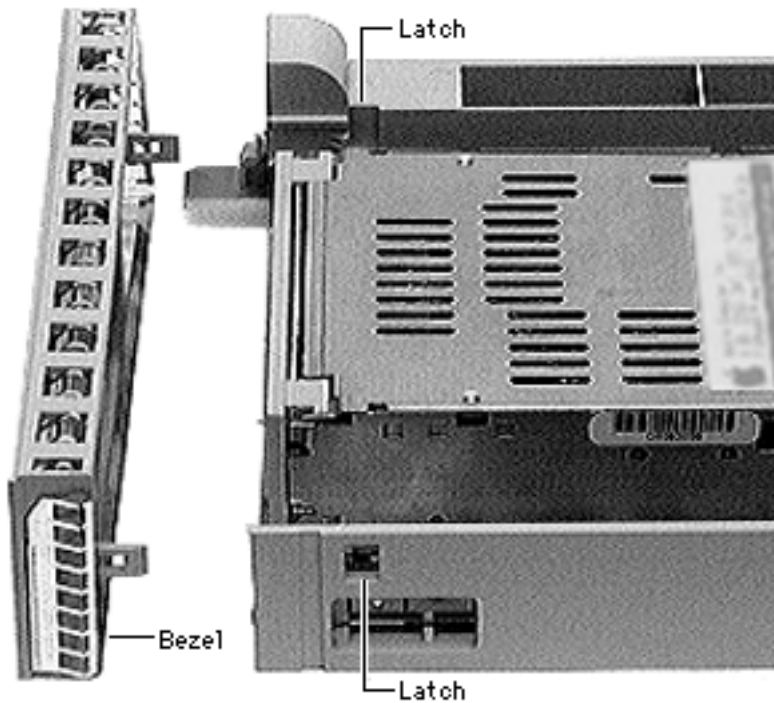

- 5 Release the two latches located on the inside of the tape drive bezel and remove the bezel.







- 6 Remove the four drive mounting screws and remove the tape drive from the carrier.

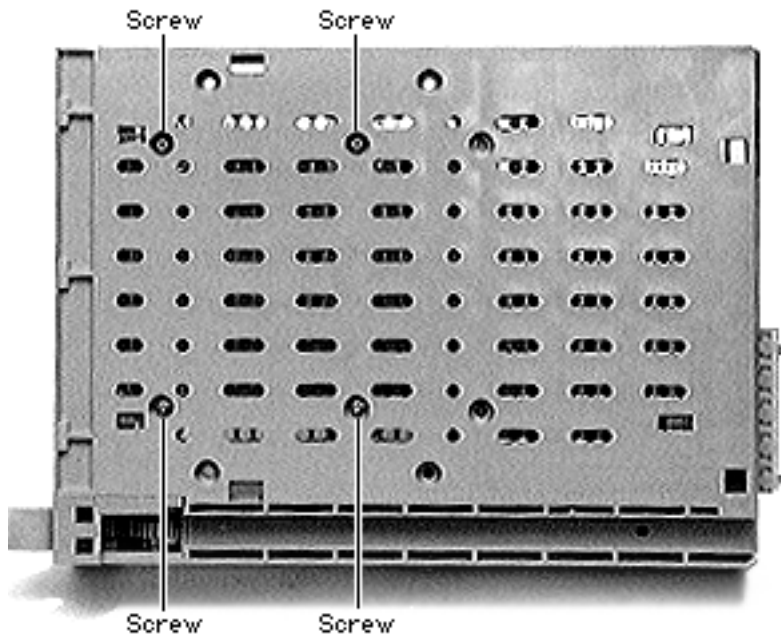

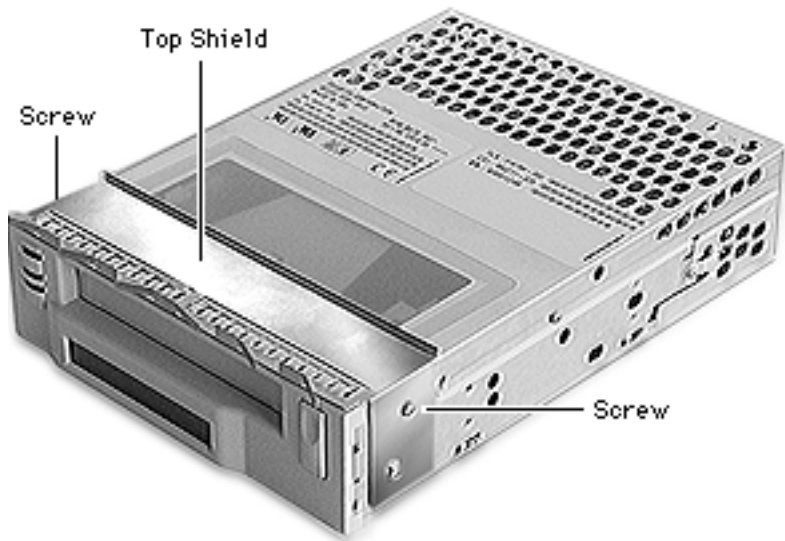

**Note:** Perform the following two steps only if you are replacing an 8 mm tape drive.

- 7 Using a T-6 torx driver, remove the two mounting screws and remove the top shield.
- 8 Replace the two torx screws in the drive.



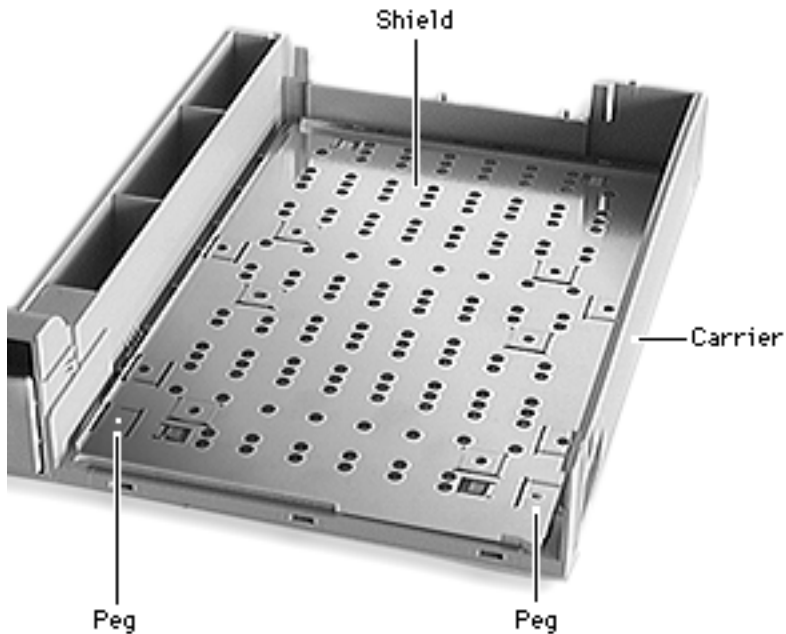

**Note:** New drive carriers come with a metal shield, which must be removed to accommodate an 8 mm tape drive.

Perform the following three steps only if you installing an 8 mm tape drive in a new carrier.

- 9 Using a flat-blade screwdriver, pry up the front corners of the drive carrier shield and release it from the carrier's two small plastic pegs.



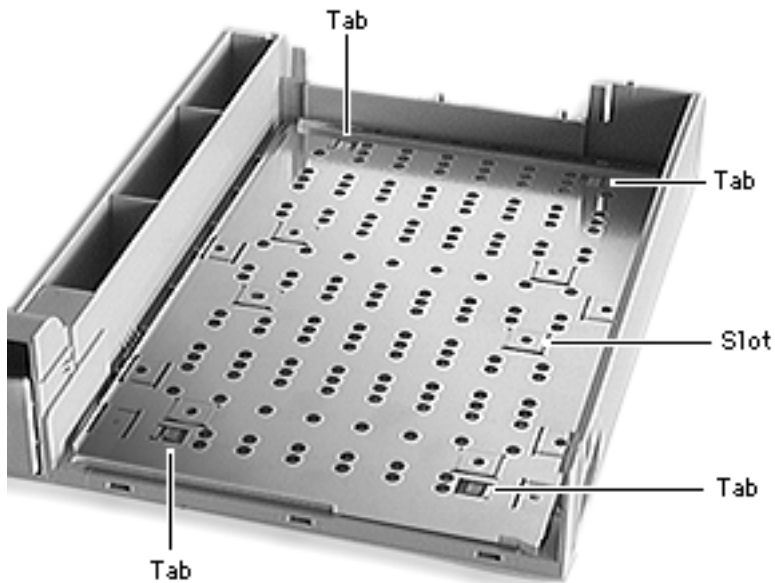

10 Slide the shield forward slightly and disengage the shield's four metal tabs from the carrier's plastic tabs.

**Note:** You may have to use the screwdriver to guide the slots in the shield over the raised screw holes in the carrier.

11 Remove the shield from the carrier.





## Hard Drive

Before you begin,  
disconnect the power cord.

**Caution:** Review the ESD  
precautions in Bulletins/  
Safety.



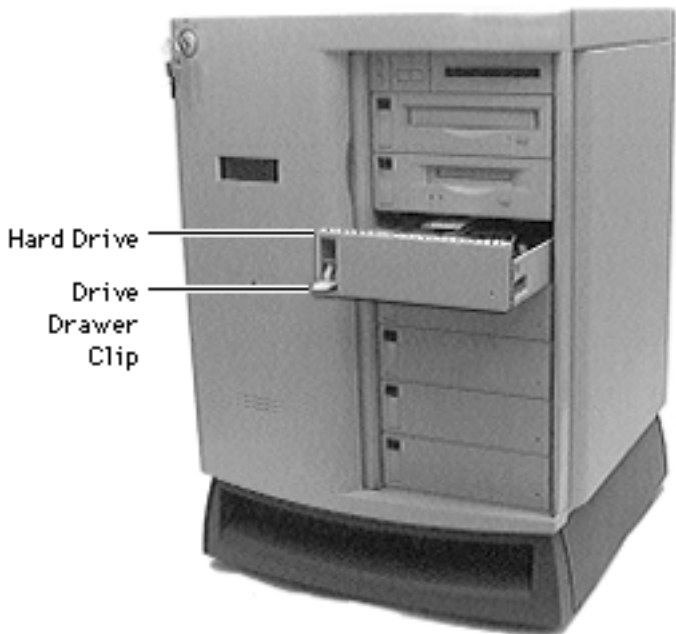

- 1 With the front lock key in the upright (unlocked) position, slide the front door to the fully open position.
- 2 Release the drive drawer clip and slide the hard drive out.

**Note:** Perform the following steps only if you are replacing the SCSI device.



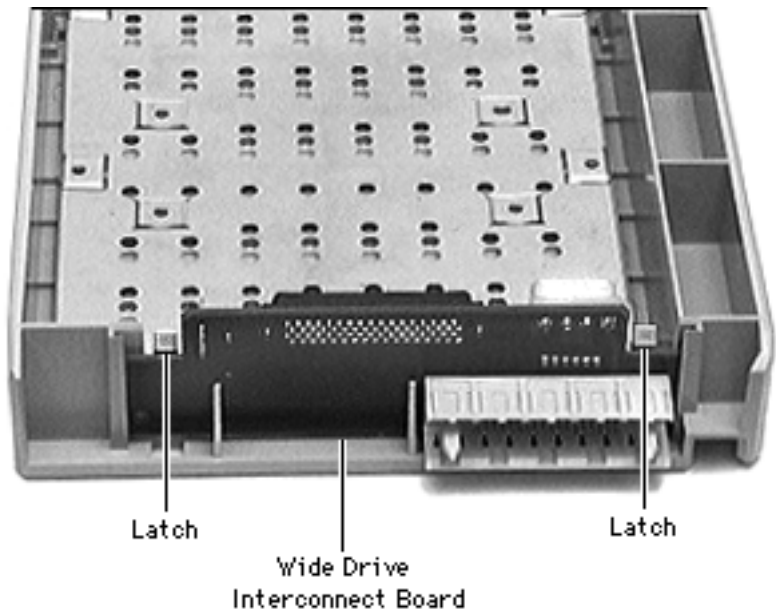

- 3 Push out the latches holding the wide drive interconnect board and pull up the board.





SCSI ID Type 1 Cable  
or Type 4 Cable

Power Cable

50-Pin or  
68-Pin SCSI Cable

Hard Drive  
LED Cable

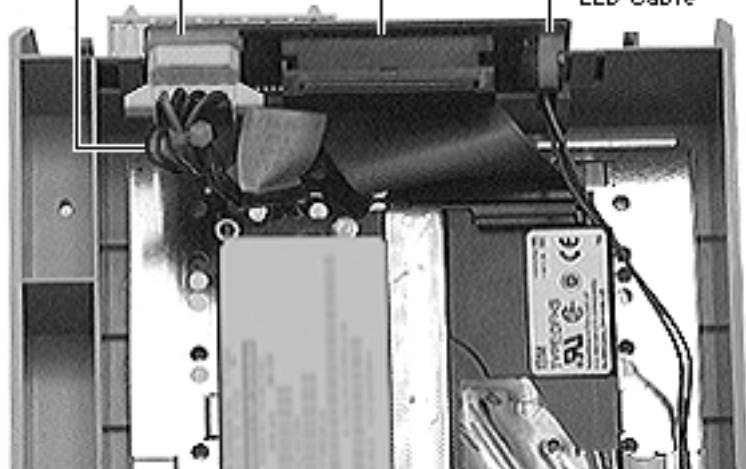

- 4 Remove the following:
- 50-pin or 68-pin SCSI cable
  - SCSI ID type 1 or type 4 cable
  - Power cable
  - Hard drive LED cable





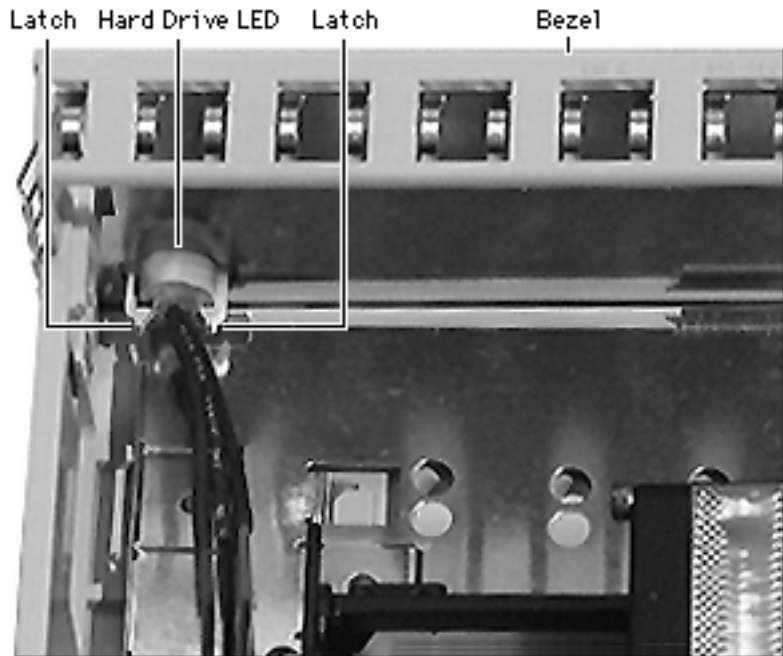

- 5 Release the two latches located on the inside of the blank bezel and remove the bezel.





- 6 Remove the four mounting screws and remove the hard drive from the drive carrier.

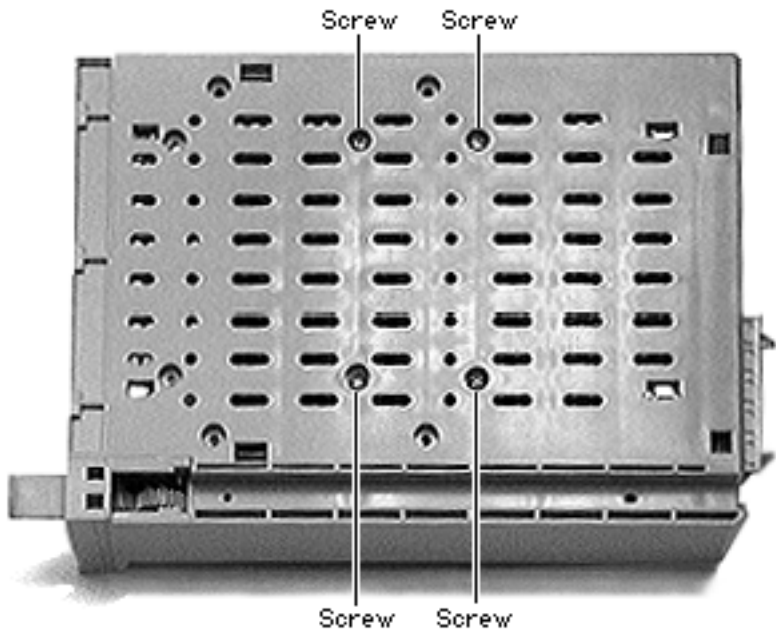



## Rail Guides

Before you begin,  
disconnect the power cord.

**Caution:** Review the ESD  
precautions in Bulletins/  
Safety.





- 1 With the front lock key in the upright (unlocked) position, slide the front door to the fully open position.
- 2 Remove the required device (CD-ROM drive, DAT tape drive, or hard drive) from the drive bay.

**Note:** You may need to remove an additional device below the rail guides to access the rail guides.



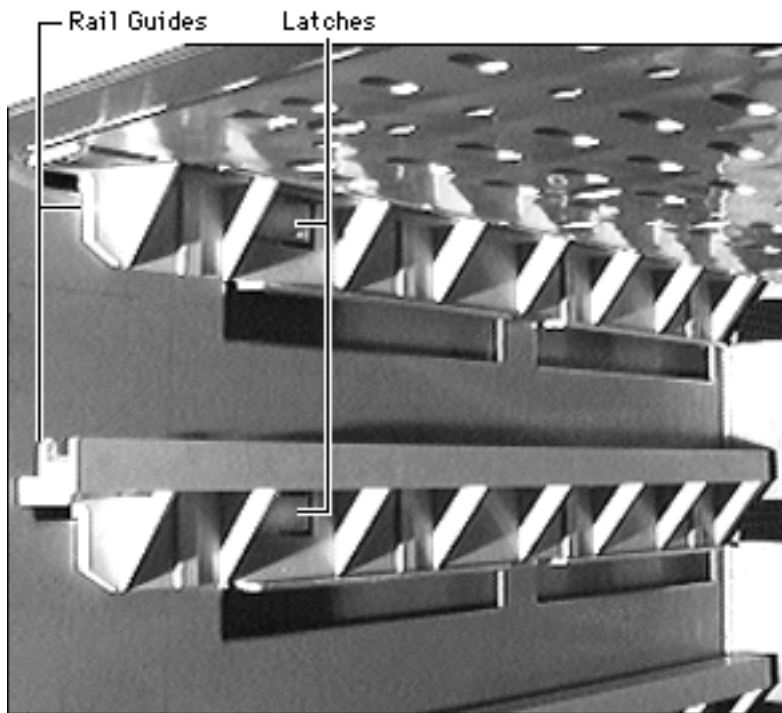

- 3 Release the latch on the rail guide and pull out the guide.



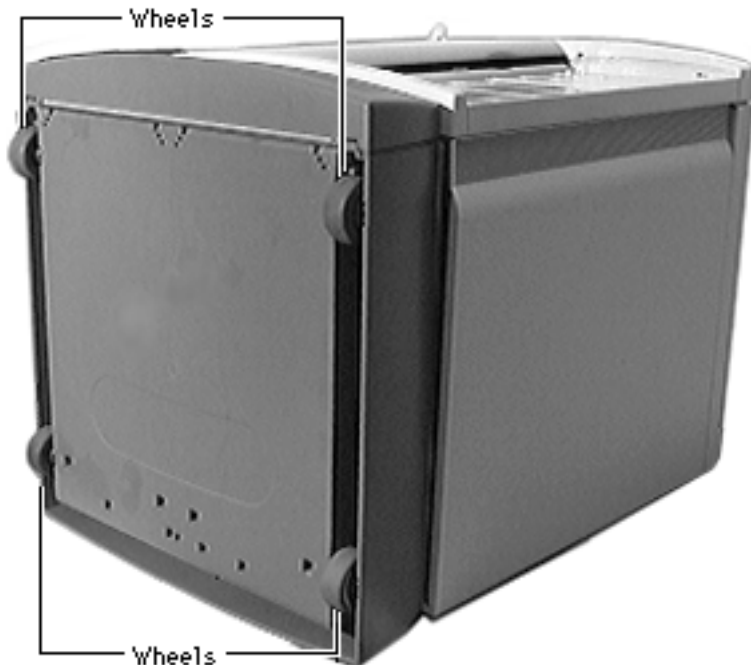

## Wheels

Before you begin,  
disconnect the power cord.

**Caution:** Review the ESD  
precautions in Bulletins/  
Safety.

**Caution:** When removing  
the front wheels, be sure the  
brake lever is in the upright  
(unlocked) position.

- 1 Place the server on its  
back.



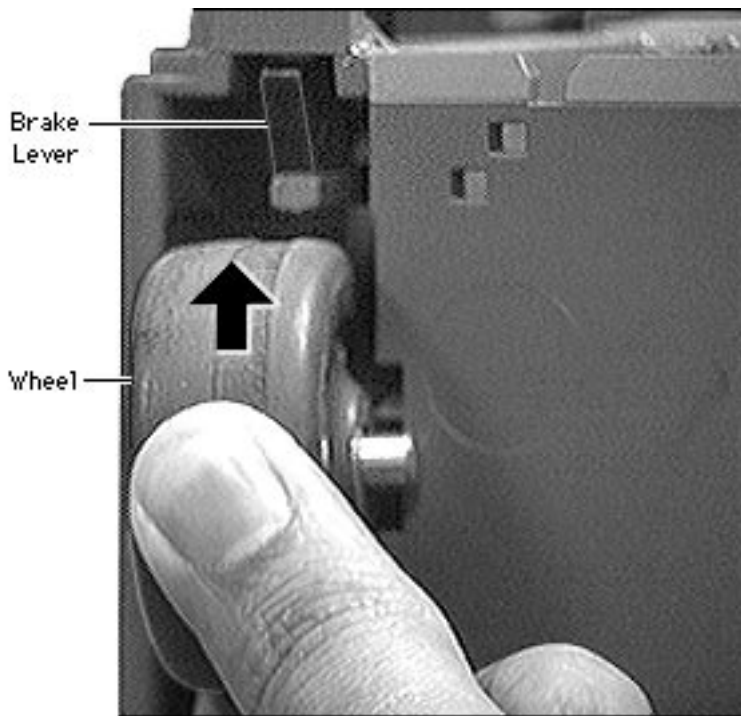

- 2 Place your finger beneath the wheel and push it up so that the wheel pops out.



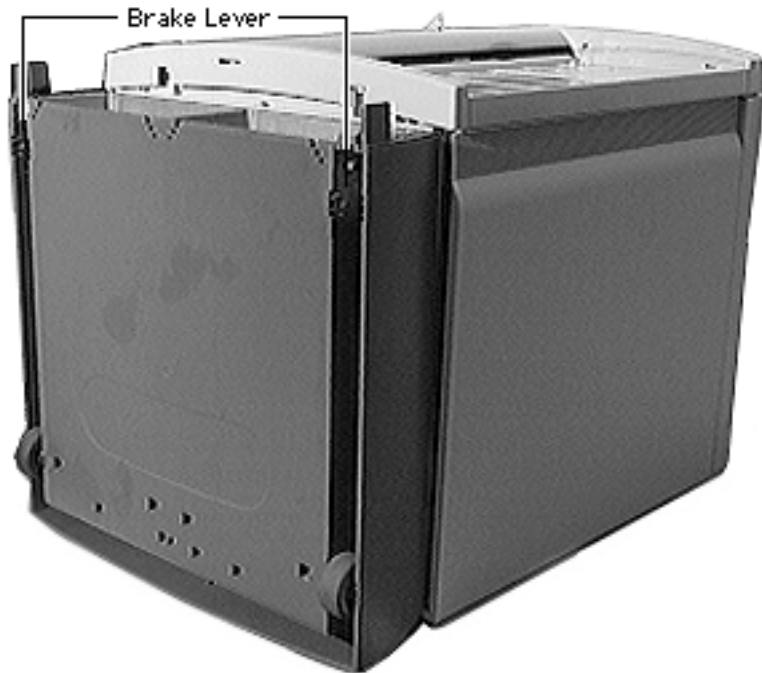

## Brake Lever

Before you begin, disconnect the power cord and remove the following:

- Base door
- Wheels (front only)

**Caution:** Review the ESD precautions in Bulletins/ Safety.

- 1 Place the server on its side.





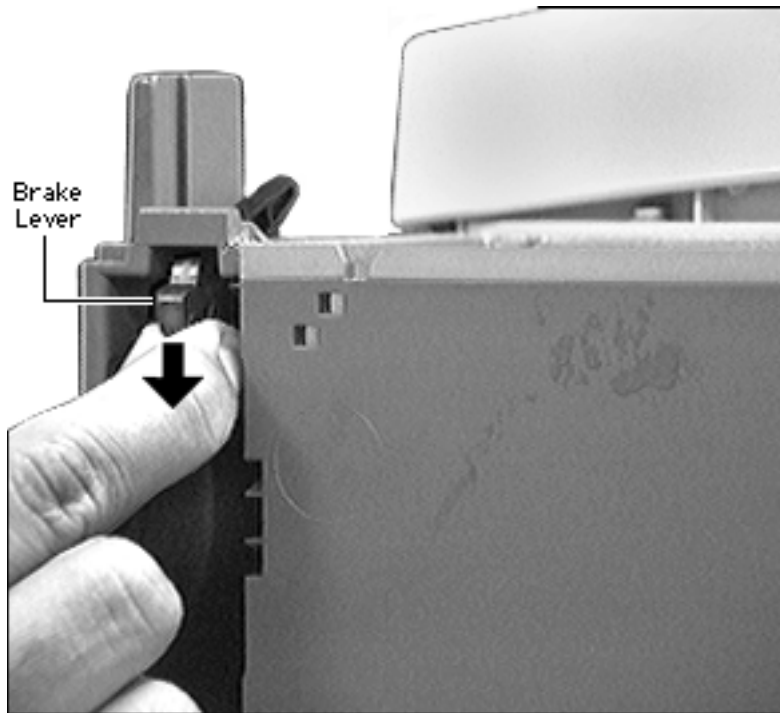

- 2 Push the brake lever down and pull it out.





## Upgrades

Network Server 500 and  
700 Series





## Third-Party Drives in Front Drive Bays

**Note:** Internal SCSI drives from Apple come installed in the drive carrier; third-party drives must be installed in the carrier before you can use them in the server. This procedure explains how to install third-party drives in the front bays of the server .



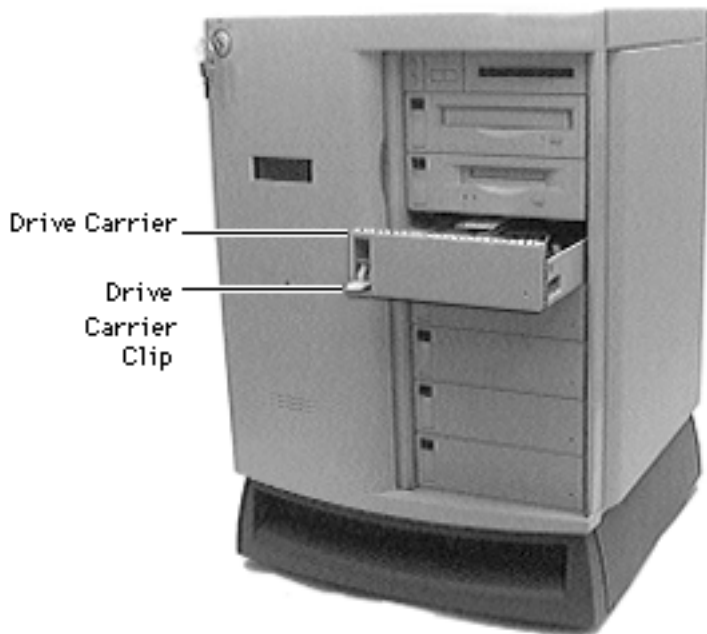

Before you begin, disconnect the power cord.

**Caution:** Review the ESD precautions in Bulletins/ Safety.

- 1 With the front lock key in the upright (unlocked) position, slide the front door to the fully open position.
- 2 Release the drive carrier clip and slide out the drive carrier.



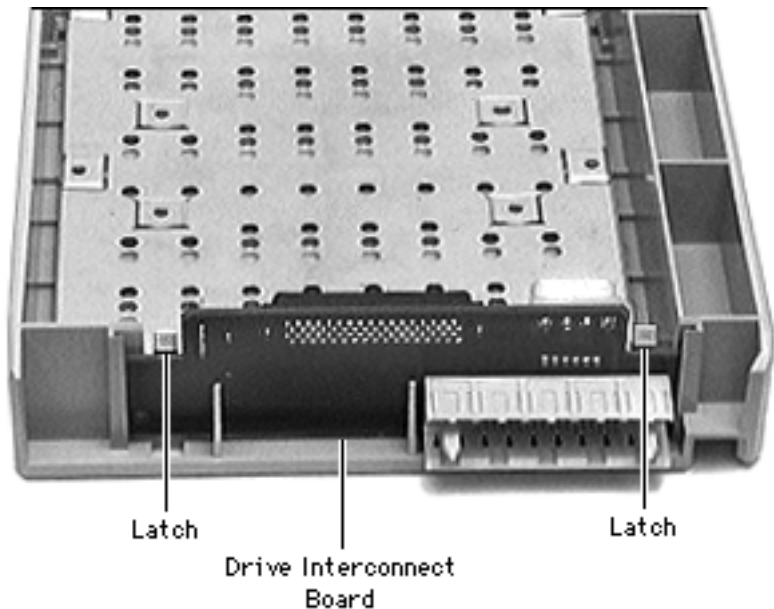

**Note:** Perform steps 3–6 only if there is an existing drive in the drive carrier.

- 3 Push out the latches holding the drive interconnect board and pull up the board.



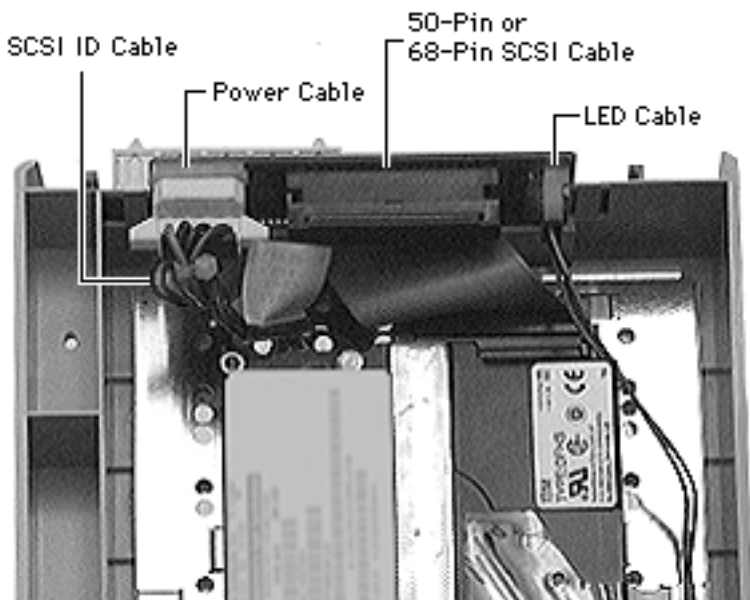

- 4 Remove the following:
- 50-pin or 68-pin SCSI ribbon cable
  - SCSI ID cable
  - Power cable
  - LED cable



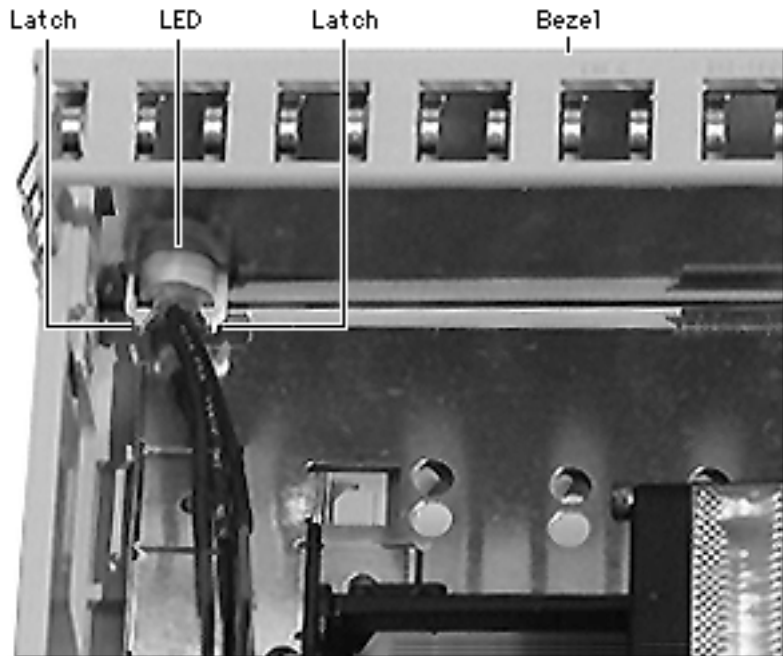

- 5 Release the two latches located on the inside of the blank bezel and remove the bezel.



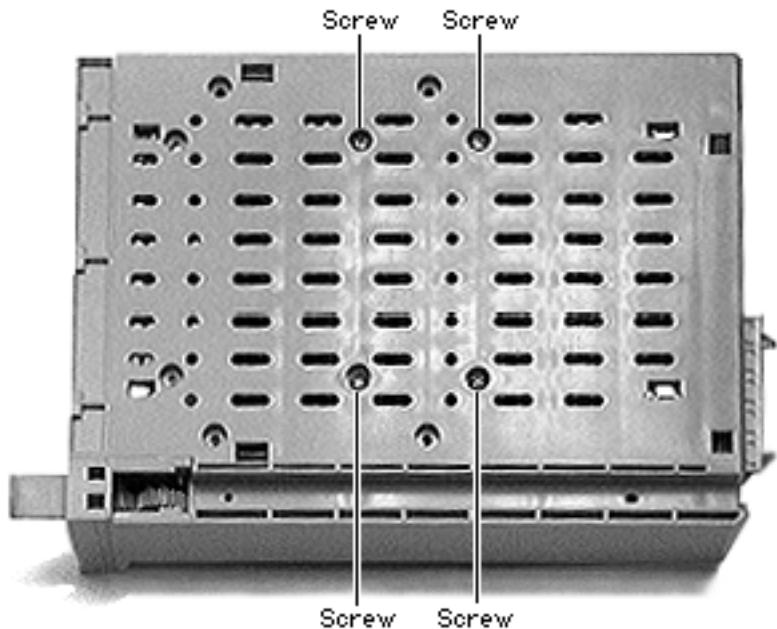

- 6 Remove the four mounting screws and remove the drive from the drive carrier.





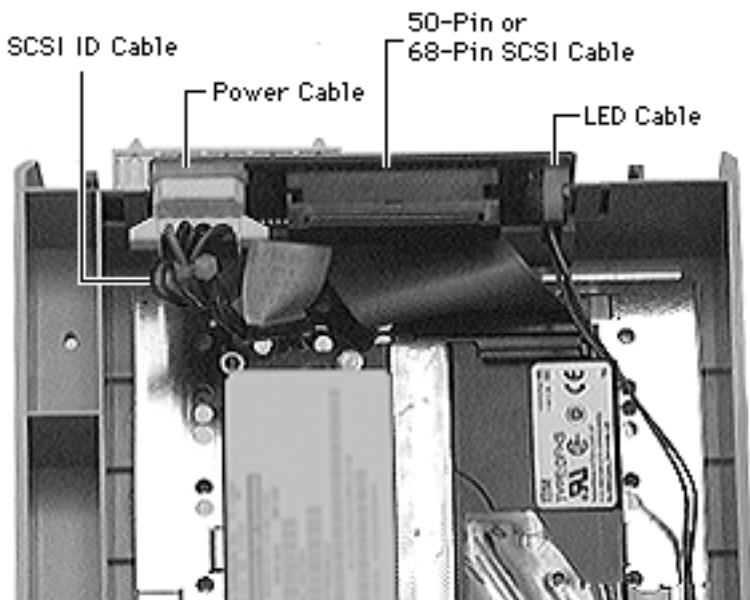

**Note:** Perform steps 7-12 to install the new third-party drive.

- 7 Attach the following to the third-party drive and the drive interconnect board:
- 50-pin or 68-pin SCSI ribbon cable
  - SCSI ID cable
  - Power cable
  - LED cable





- 8 Insert the drive interconnect board into the drive carrier.

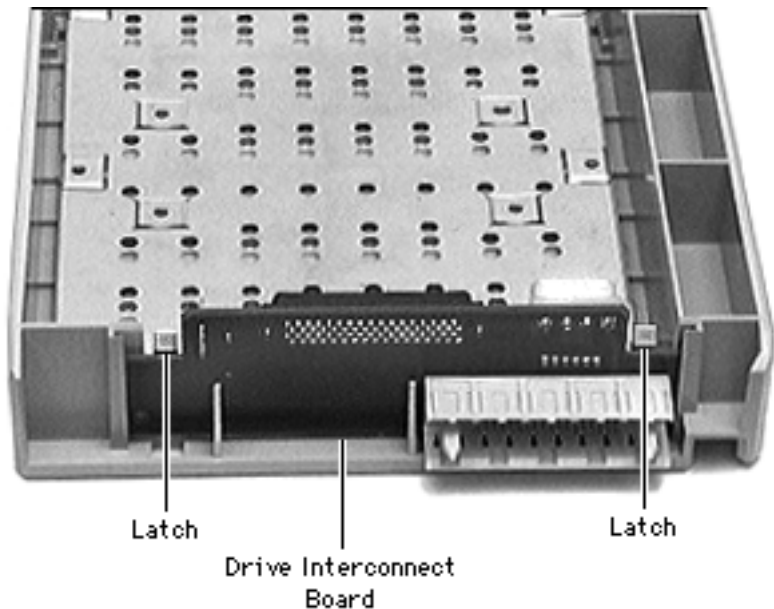

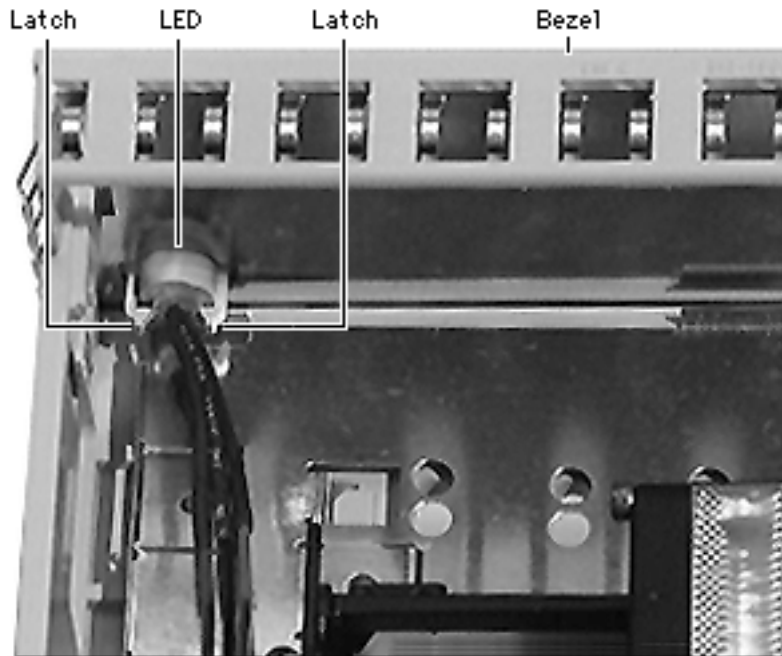

9 Install the bezel.

**Note:** If you are installing a third-party drive that requires a specific bezel (such as a CD-ROM drive, which requires a special slot to accommodate the disc), make sure you install the correct bezel.





10 Attach the drive to the drive carrier with the four mounting screws.

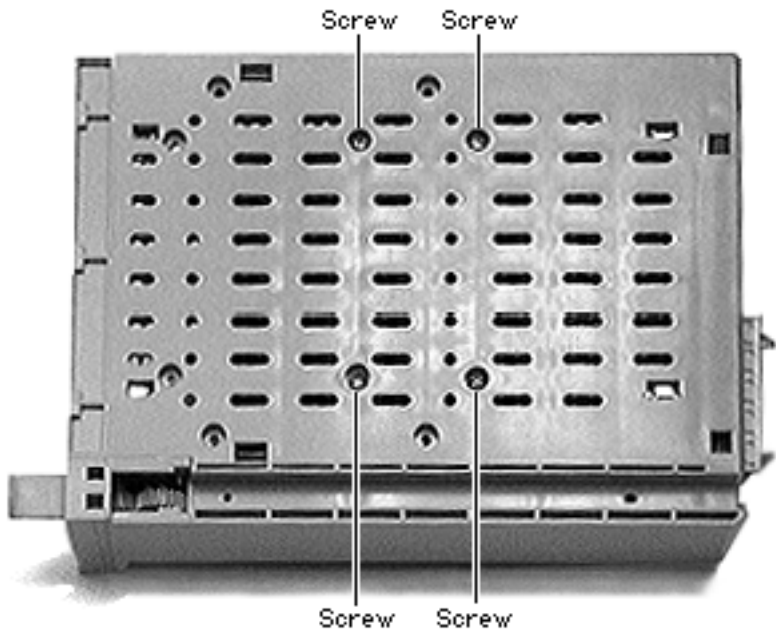

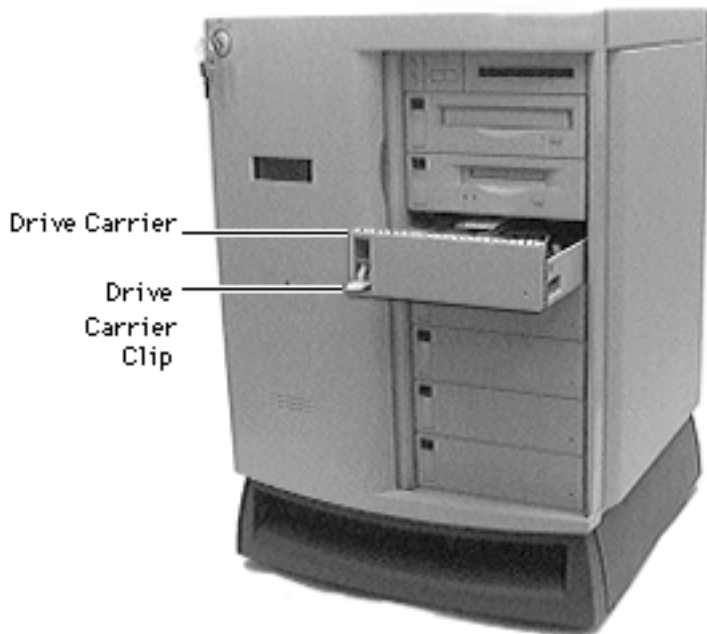

- 11 With the drive carrier clip fully released (down), slide the drive carrier into the drive bay until the clip returns to its upright (locked) position.
- 12 Slide the front door closed, and turn the front lock key to the right (locked) position.





## Rear Drives (NS 700 Series)

**Note:** This procedure explains how to install drives in the rear drives bracket.

Before you begin, disconnect the power cord.

**Caution:** Review the ESD precautions in Bulletins/ Safety.



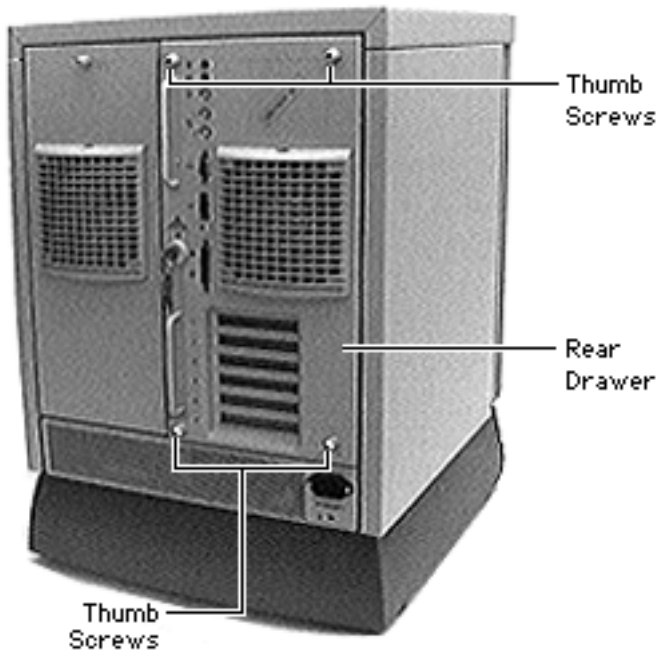

- 1 With the back of the computer facing you, turn the key in the rear drawer lock to the upright (unlocked) position.
- 2 Loosen the four thumb screws and slide the rear drawer out.



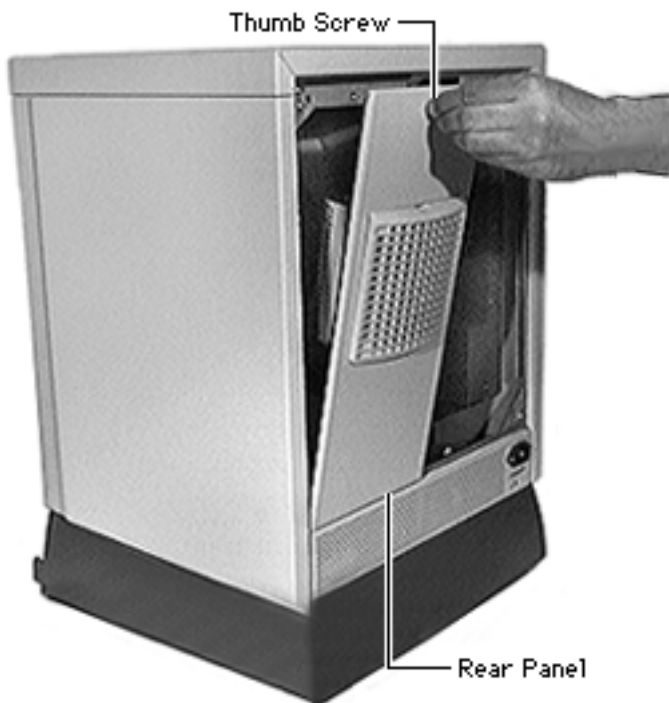

- 3 Loosen the thumb screw on the rear panel.





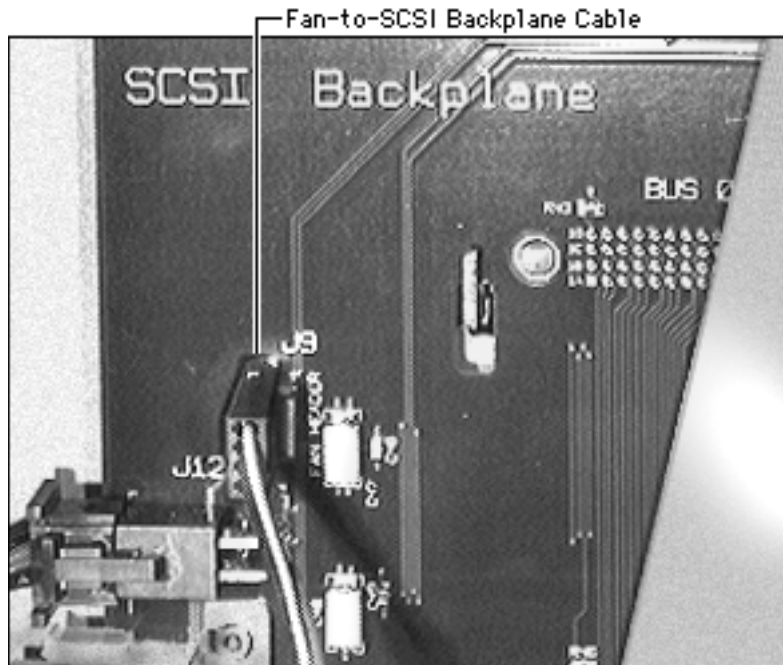

- 4 Disconnect the fan-to-SCSI-backplane cable and remove the rear panel.



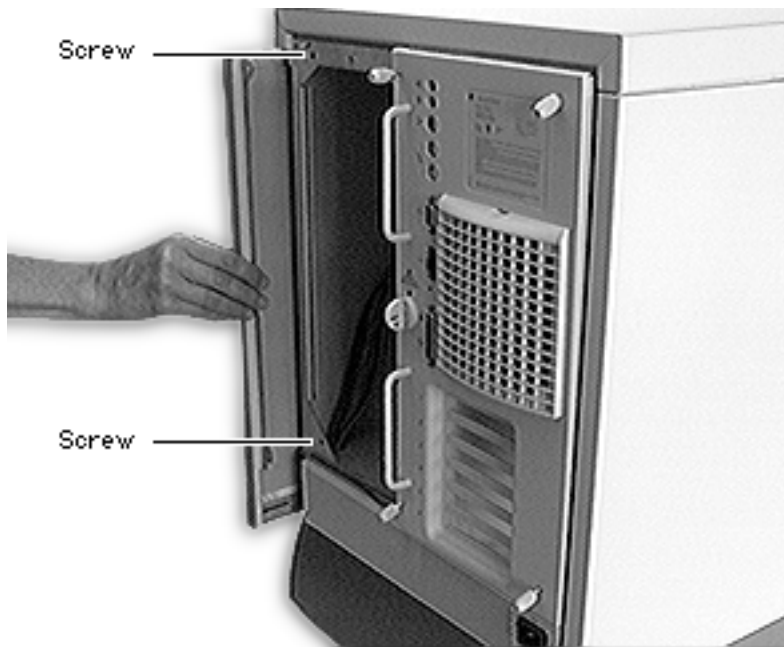

- 5 Remove the two screws from the rear edge of right side panel.
- 6 Slide the right side panel off the unit.



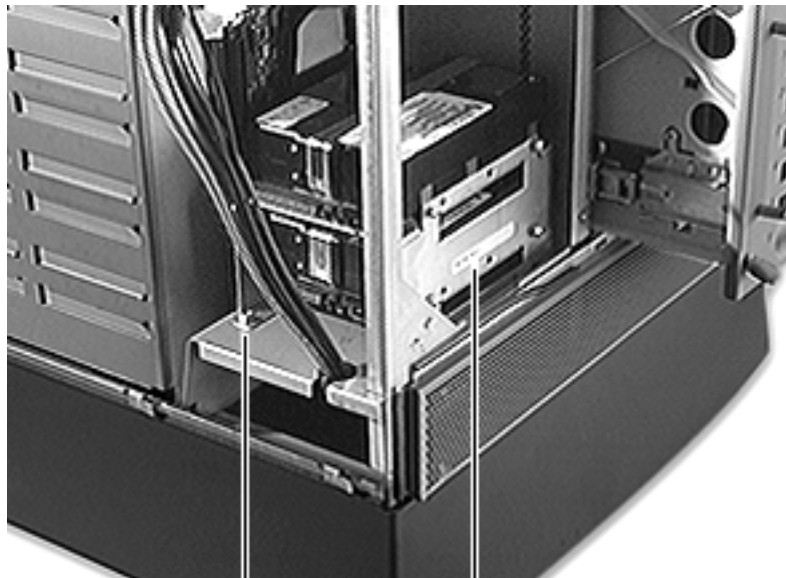

Screw

Bracket

- 7 **Note:** If there is an existing drive in the rear drives bracket, remove the bracket.

Remove the screw that attaches the rear drives bracket to the unit and slide the bracket out of the unit.





- 8 Attach the drive to the drive bracket with the four mounting screws.

**Note:** If you are installing two drives, attach the first drive inside the bracket and the second drive on top of the bracket.

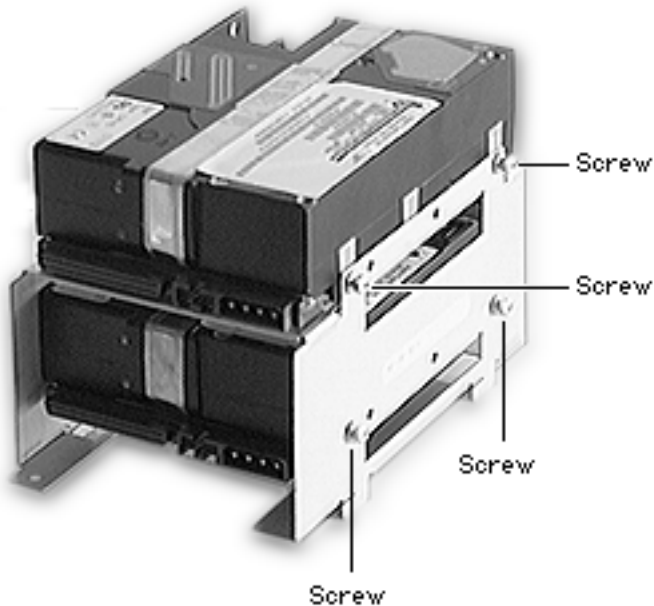

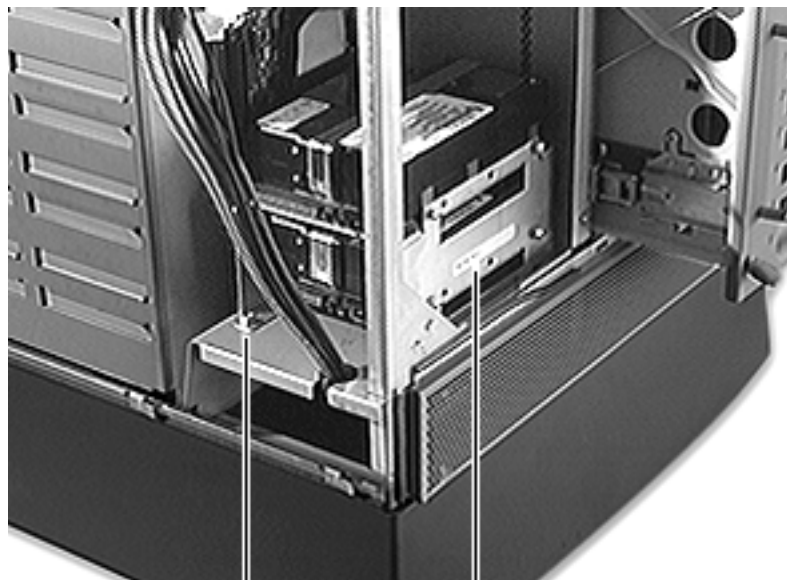

Screw

Bracket

Place the rear drives bracket in the server and attach it to the unit with the mounting screw.



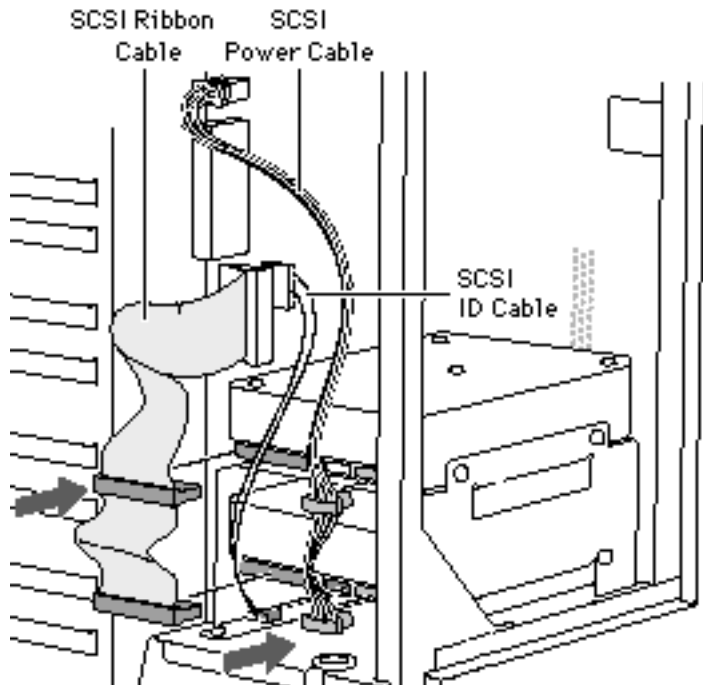

9 Attach the following:

- Rear drive power cable
- SCSI ribbon cable
- SCSI ID cable

**Note:** You must terminate the bottom drive in the bracket by attaching the SCSI ID cable and connecting the drive to the last connector on the ribbon cable. Or you can set termination by a jumper or switch on the drive. (Check the instructions that came with the drive.) If the bracket contains just one drive,





connect it to the last connector on the ribbon cable.

**Note:** To set the SCSI ID on third-party drives, you may have to change jumpers. Do not use the SCSI ID cable for third-party drives. For more information, contact your vendor.

- 10 Replace the right side panel and rear panel.
- 11 Close the rear drawer, tighten the thumb screws, and turn the key to the right (locked) position.





## PCI Card

**Note:** This procedure explains how to install a PCI card. If you are installing a RAID or FDDI PCI card, see the topics “RAID PCI Card” or “FDDI PCI Card.”

Before you begin, disconnect the power cord.

**Caution:** Review the ESD precautions in Bulletins/ Safety.

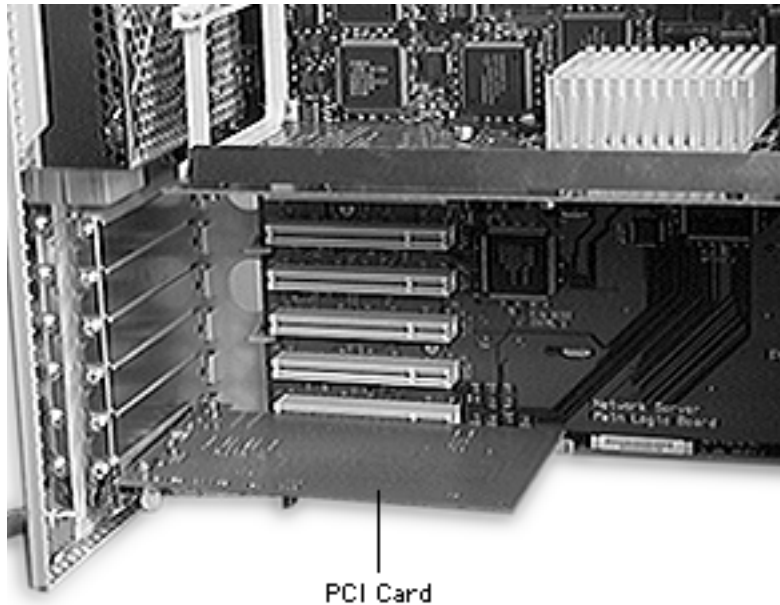



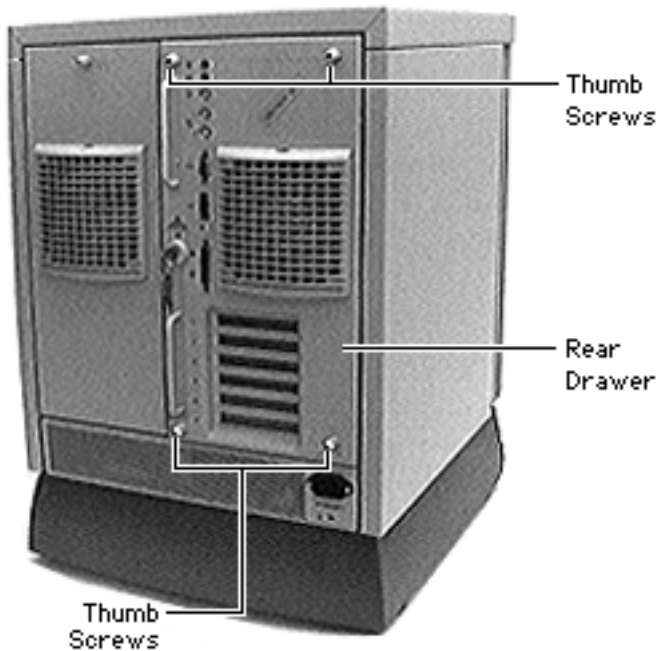

- 1 With the back of the computer facing you, turn the key in the rear drawer lock to the upright (unlocked) position.
- 2 Loosen the four thumb screws and slide the rear drawer out.





Screw

PCI Expansion Card Cover

- Caution:** In this step, be careful not to bend the drawer slides.

Using a Phillips screwdriver, unscrew the PCI expansion card cover and remove it.



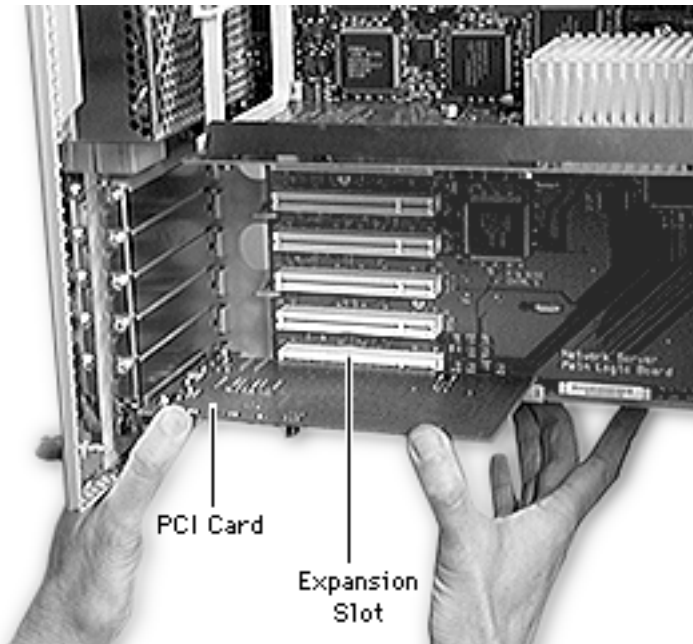

- 4 **Caution:** While inserting the card, be sure to support the drawer with one hand.

Align the card with the expansion slot and press in firmly until the connector is seated.



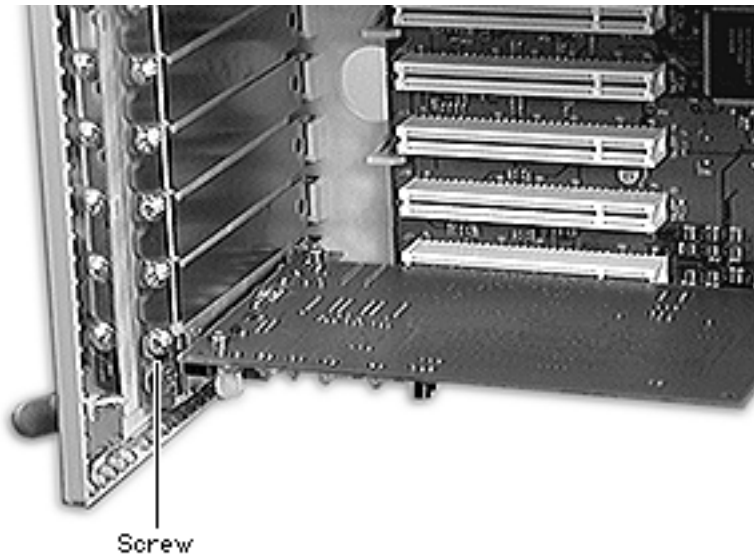

- 5 Replace the screw that you removed from the expansion card cover.
- 6 Close the rear drawer, tighten the thumb screws, and turn the key to the right (locked) position.





## RAID PCI Card

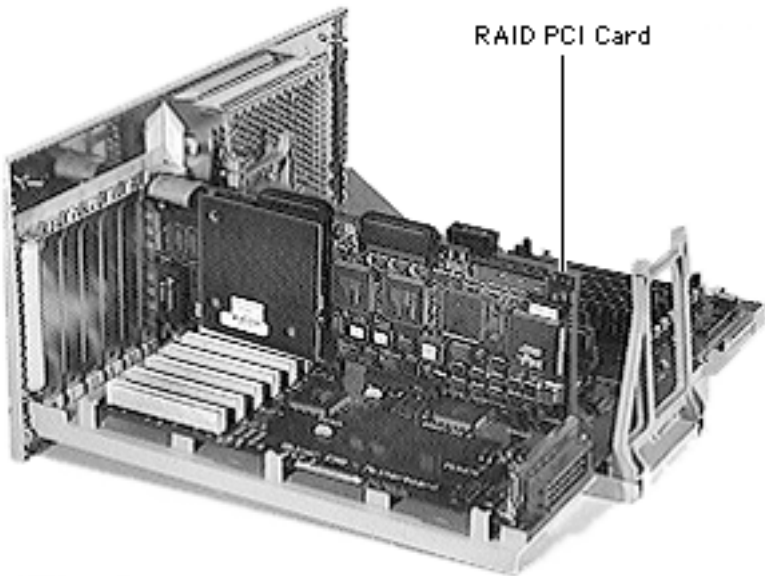

**Note:** This procedure explains how to install a RAID PCI card. The card may be installed in the first PCI slot for internal RAID support and in any PCI slot for external RAID support. Up to four RAID cards may be installed in one unit.

**Note:** The card includes a separate battery and SIMM.

Before you begin, disconnect the power cord and remove the rear drawer and





Screw

PCI Expansion Card Cover

processor card.

**Caution:** Review the ESD precautions in Bulletins/ Safety.

- 1 **Note:** In this step, be careful not to bend the drawer slides.

Using a Phillips screwdriver, unscrew the PCI expansion card cover and remove it.



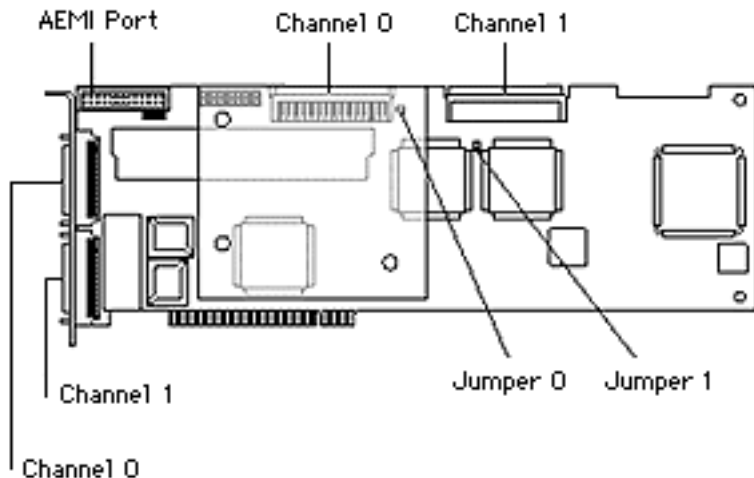

**Note:** As shipped from the factory, the RAID PCI card is fully prepared to use with Network Server internal hard drives. The card is also prepared to work with external arrays only. You may, however, need to adjust termination if you are using the card with both external arrays and internal drives.

The card layout and location of cable connectors and jumpers is shown at left.



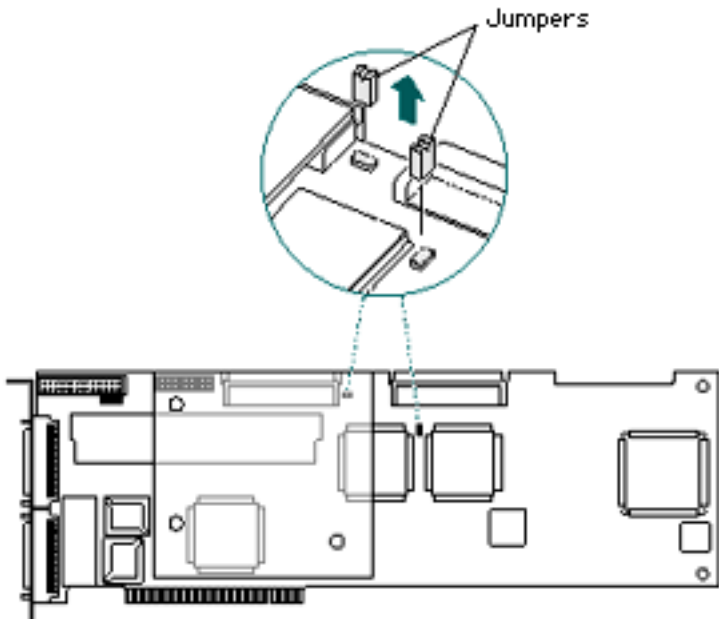

- 2 To set termination correctly for mixed internal/external arrays, remove the jumper that corresponds to each channel that has an external array connected to it. If both Channel 0 and Channel 1 are connected to external arrays, remove both jumpers. (Tip: To avoid losing the removed jumper, leave it attached to one pin.)

**Note:** You may also need to add a terminator to the





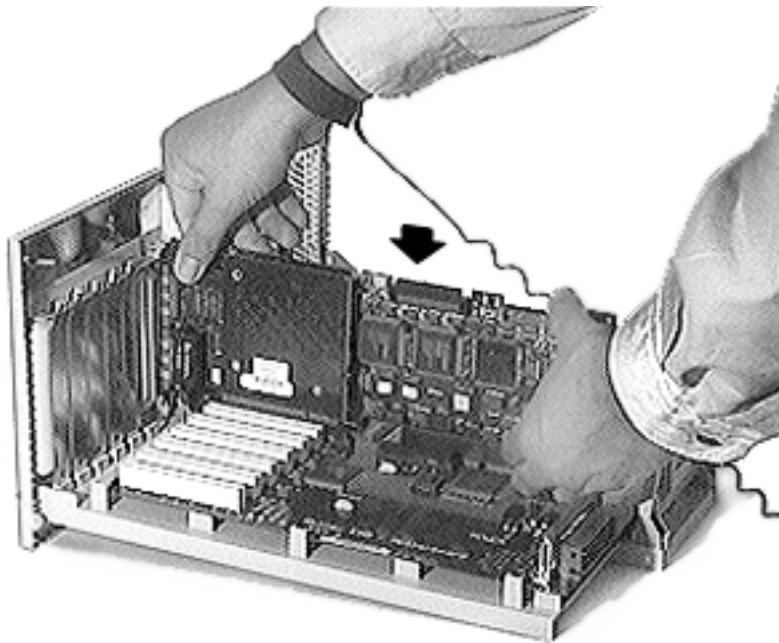

last device on each channel.

- 3 Caution:** While inserting the card, be sure to support the drawer with one hand.

Align the card with the expansion slot and press in firmly until the connector is seated.

**Note:** The external connector on the card may interfere with the PCI I/O panel, so you may have to apply some force on the panel while inserting the card.





- 4 Connect the control (AEMI) cable and the two SCSI cables to the logic board.

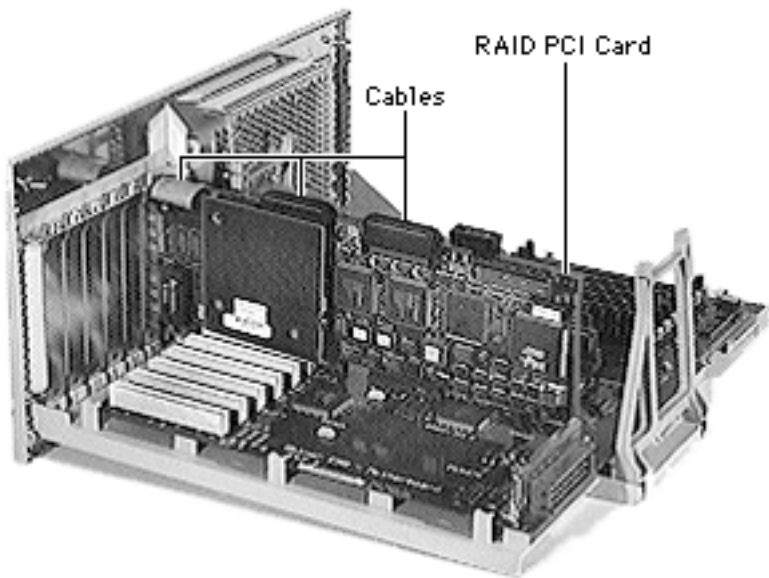

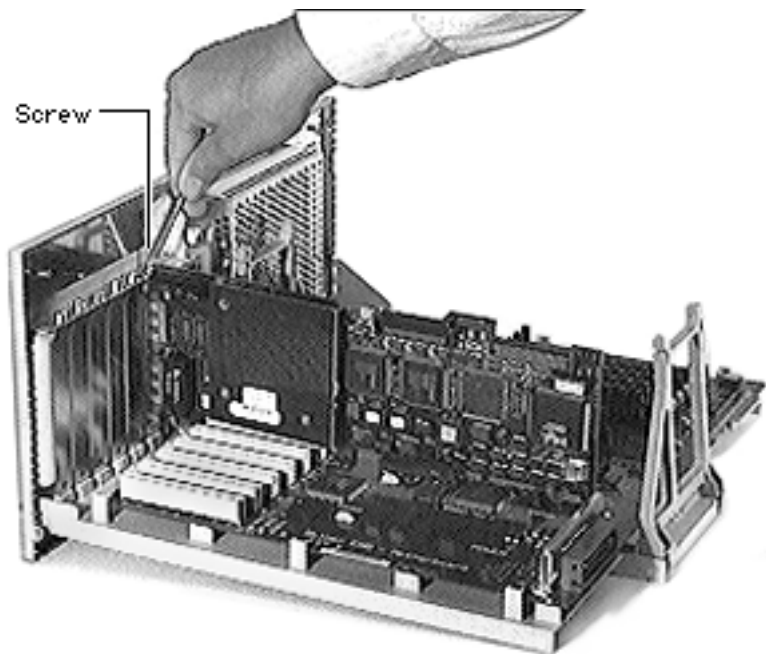

- 5 Attach the RAID card to the unit using the screw you removed from the expansion card cover.



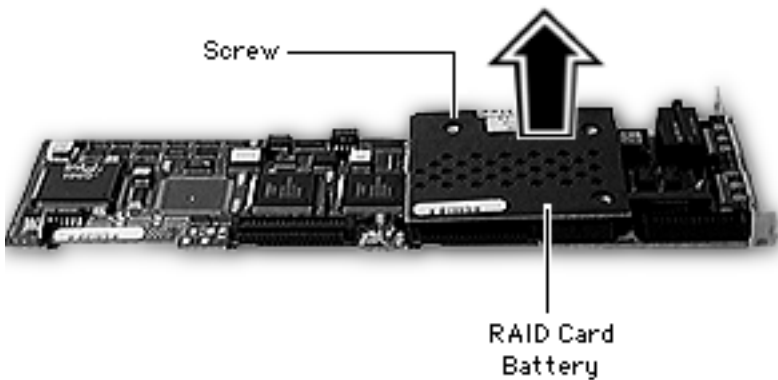

**Note:** If you are replacing an existing RAID card, you must remove the SIMM on the original card and transfer it to the replacement card.

- 6 Using a Phillips screwdriver, remove the battery mounting screw.
- 7 Disconnect the battery from the RAID card and remove the battery.



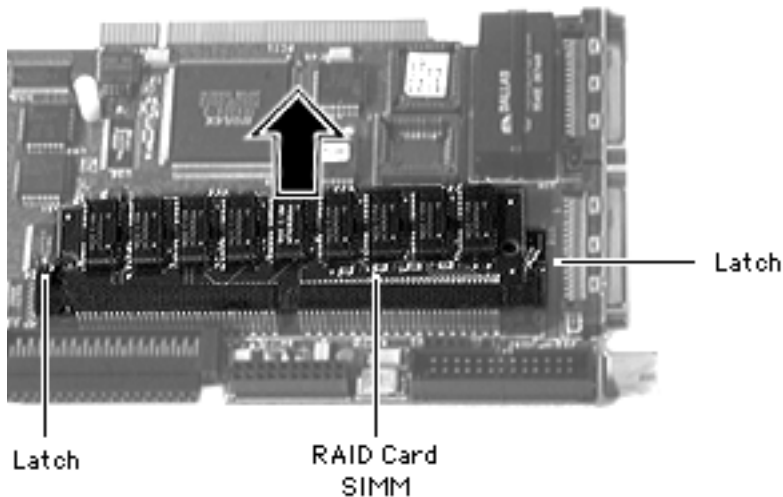

- 8 Release the two small metal latches on either side of the RAID SIMM.
- 9 Pull the SIMM up and out of the connector.
- 10 Install the SIMM on the replacement RAID card.
- 11 Reinstall the battery on the original RAID card and return it to Apple.





## Processor Card Upgrade

**Note:** This procedure explains how to install a processor card upgrade. Perform steps 1–3 if a processor card is already installed in the server.

Before you begin, disconnect the power cord.

**Caution:** Review the ESD precautions in Bulletins/ Safety.

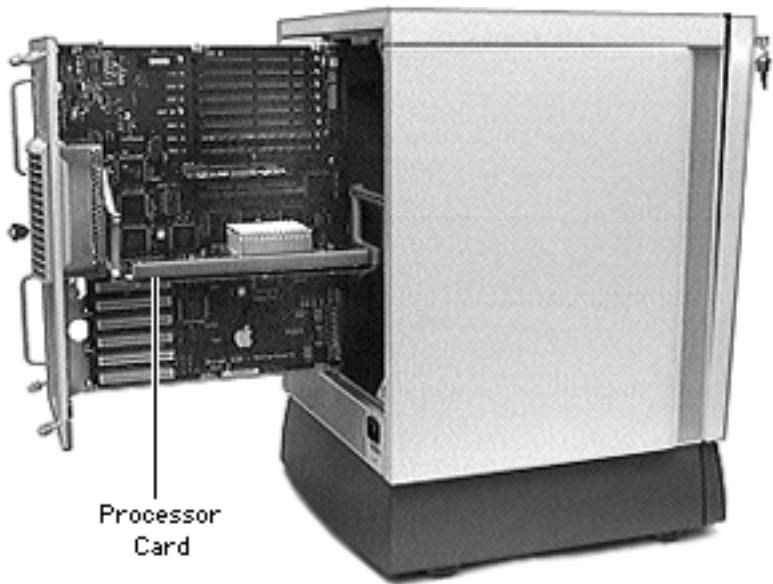

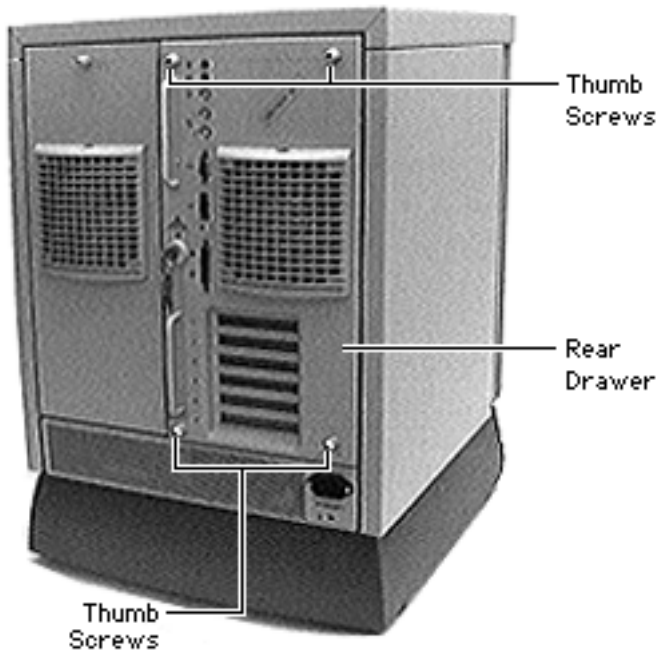

- 1 With the back of the computer facing you, turn the key in the rear drawer lock to the upright (unlocked) position.
- 2 Loosen the four thumb screws and slide the rear drawer out.



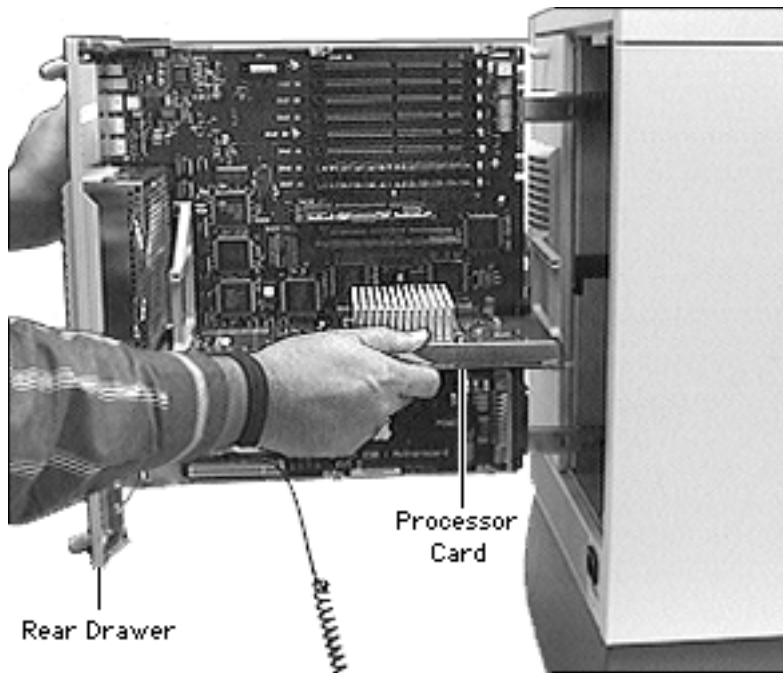

**Caution:** Hold the processor card by the edges, never by the heat sink.

**Caution:** Be sure to support the rear drawer with one hand while the other hand pulls the processor card out or puts it back in.

- 3 Holding the processor card by the edges, pull it out of the logic board connector.





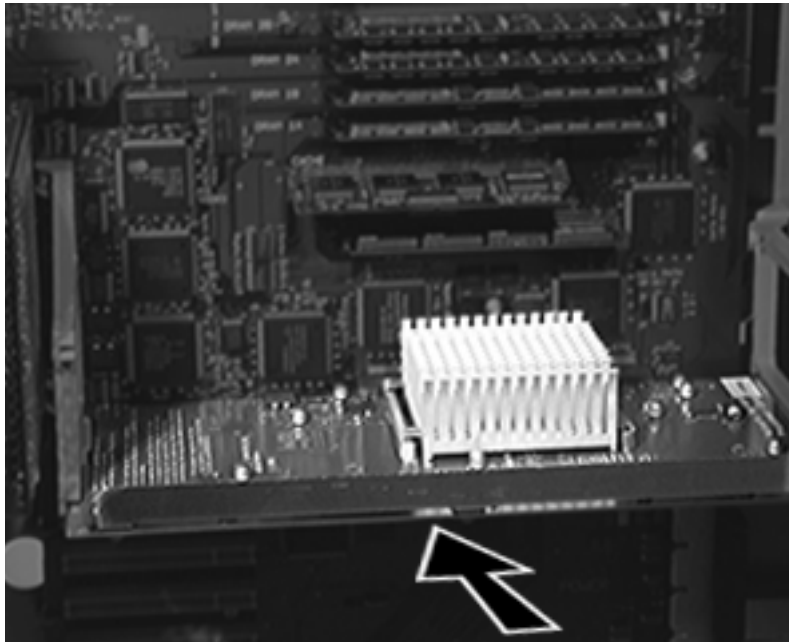

- 4 To install the upgraded processor card, position the bottom edges of the card in the processor card guides, and slide the card in until it touches the connector. Then press in on the card so that it is seated firmly.

**Caution:** Do not force the card or you may damage it.

- 5 Close the rear drawer, tighten the thumb screws, and turn the key to the right (locked) position.





## Exploded View

---

Network Server 500 and  
700 Series





# Exploded View

