

Apple

Imagewriter User's Manual

Part I: Reference



Customer Satisfaction

If you discover physical defects in the manuals distributed with an Apple product or in the media on which a software product is distributed, Apple will replace the documentation or media at no charge to you during the 90-day period after you purchased the product.

In addition, If Apple releases a corrective update to a software product during the 90-day period after you purchased the software, Apple will replace the applicable diskettes and documentation with the revised version at no charge to you during the six months after the date of purchase.

In some countries the replacement period may be different; check with your authorized Apple dealer. Return any item to be replaced with proof of purchase to Apple or an authorized Apple dealer.

Limitation on Warranties and Liability

Even though Apple has tested the software described in this manual and reviewed its contents, neither Apple nor its software suppliers make any warranty or representation, either express or implied, with respect to this manual or to the software described in this manual, their quality, performance, merchantability, or fitness for any particular purpose. As a result, this software and manual are sold "as is," and you the purchaser are assuming the entire risk as to their quality and performance. In no event will Apple or its software suppliers be liable for direct, indirect, incidental, or consequential damages resulting from any defect in the software or manual, even if they have been advised of the possibility of such damages. In particular, they shall have no liability for any programs or data stored in or used with Apple products, including the costs of recovering or reproducing these programs or data. Some states do not allow the exclusion or limitation of implied warranties or liability for incidental or consequential damages, so the above limitation or exclusion may not apply to you.

Copyright

This manual and the software (computer programs) described in it are copyrighted by Apple or by Apple's software suppliers, with all rights reserved. Under the copyright laws, this manual or the programs may not be copied, in whole or part, without the written consent of Apple, except in the normal use of the software or to make a backup copy. This exception does not allow copies to be made for others, whether or not sold, but all of the material purchased (with all backup copies) may be sold, given or loaned to another person. Under the law, copying includes translating into another language.

You may use the software on any computer owned by you but extra copies cannot be made for this purpose. For some products, a multi-use license may be purchased to allow the software to be used on more than one computer owned by the purchaser, including a shared-disk system. (Contact your authorized Apple dealer for information on multi-use licenses.)

Product Revisions

Apple cannot guarantee that you will receive notice of a revision to the software described in this manual, even if you have returned a registration card received with the product. You should periodically check with your authorized Apple Dealer.

© 1983 Apple Computer, Inc.
20525 Mariani Avenue
Cupertino, California 95014

Apple and the Apple logo are registered trademarks of Apple Computer, Inc.

Simultaneously published in the U.S.A. and Canada. All rights reserved.

Reorder Apple Product A9L0303

Warning

This equipment has been certified to comply with the limits for a Class B computing device, pursuant to Subpart J of Part 15 of FCC Rules. Only peripherals (computer input/output devices, terminals, printers, etc.) certified to comply with the Class B limits may be attached to this computer. Operation with non-certified peripherals is likely to result in interference to radio and TV reception.

SUPPORT #

1-800-323-7719

Apple

Imagewriter User's Manual

Part I: Reference

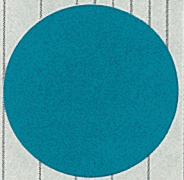

Radio and Television Interference

The equipment described in this manual generates and uses radio-frequency energy. If it is not installed and used properly, that is, in strict accordance with our instructions, it may cause interference with radio and television reception.

This equipment has been tested and complies with the limits for a Class B computing device in accordance with the specifications in Subpart J, Part 15, of FCC rules. These rules are designed to provide reasonable protection against such interference in a residential installation. However, there is no guarantee that the interference will not occur in a particular installation, especially if you use a “rabbit ear” television antenna. (A “rabbit ear” antenna is the telescoping-rod type usually contained on TV receivers.)

You can determine whether your computer is causing interference by turning it off. If the interference stops, it was probably caused by the computer or its peripheral devices. To further isolate the problem:

- Disconnect the peripheral devices and their input/output cables one at a time. If the interference stops, it is caused by either the peripheral device or its I/O cable. These devices usually require shielded I/O cables. For Apple peripheral devices, you can obtain the proper shielded cable from your dealer. For non-Apple peripheral devices, contact the manufacturer or dealer for assistance.

If your computer does cause interference to radio or television reception, you can try to correct the interference by using one or more of the following measures:

- Turn the TV or radio antenna until the interference stops.
- Move the computer to one side or the other of the TV or radio.
- Move the computer farther away from the TV or radio.
- Plug the computer into an outlet that is on a different circuit than the TV or radio. (That is, make certain the computer and the radio or television set are on circuits controlled by different circuit breakers or fuses.)
- Consider installing a rooftop television antenna with coaxial cable lead-in between the antenna and TV.

If necessary, you should consult your dealer or an experienced radio/television technician for additional suggestions. You may find helpful the following booklet, prepared by the Federal Communications Commission:

“How to Identify and Resolve Radio-TV Interference Problems”

This booklet is available from the U.S. Government Printing Office, Washington, DC 20402, stock number 004-000-00345-4.

Table of Contents

List of Figures and Tables *ix*

About This Manual *xi*

Getting to Know Your Printer **1**

- 1**
- 3 Unpacking
 - 5 First, a Few Names
 - 5 Exterior Features
 - 7 Inside the Machine
 - 9 Controls and Indicators
 - 10 How the Apple Imagewriter Works

Setting Up Your Printer **13**

- 2**
- 15 Loading the Paper
 - 16 Setting the Pin-Feeder Width
 - 18 Loading Pin-Feed Paper
 - 19 Loading Plain Paper
 - 20 Setting the Top of the Page
 - 21 Adjusting for Paper Thickness
 - 21 Installing and Removing the Ribbon
 - 23 Testing Your Printer
 - 24 Connecting Your Printer
 - 24 Creating a Work Space

Caring for Your Printer **25**

- 3**
- 27 Operating Environment
 - 27 Cleaning
 - 29 Lubrication
 - 30 Repacking

Controlling Your Printer

34	Changing the Standard Instructions
35	DIP Switch Settings
36	Control Codes
36	Control Characters
36	Control Sequences
37	Functions You Can Change
39	Baud Setting
39	Serial Interface Protocol
39	Character Pitch
41	Proportional Character Spacing
42	Character Repetition
42	Slashed and Unslashed Zeros
43	Foreign Characters
44	Backspacing
45	Underlining
45	Boldface Printing
46	Headline Type
46	Direction of Type Head Motion
46	Line Feed Function
47	Automatic Line Feed
48	Line Feed Pitch
49	Line Feed Direction
49	Multiple Line Feeding
49	Left Margin Setting
50	Page Length
50	Form Feeding
51	Top of Form Set Command
51	Paper Error Detection
51	Restoring Standard Instructions

Advanced Control Codes

55	The Input Buffer
55	End-of-Line Character
55	Canceling Text
56	Buffer Overflow Action
56	Data Byte Length
57	Horizontal Tabbing
57	Setting a Tab Line
58	Adding a Selected Tab
59	Using Horizontal Tabs
59	Clearing Horizontal Tabs

59	Vertical Tabbing
60	Setting Vertical Tabs
62	Using Vertical Tabs
64	Setting Page Length
64	Vertical Tab Reset and Default
65	Custom Characters
65	Creating Custom Characters
66	Loading Custom Characters
68	Printing Custom Characters
69	A Sample Custom Character
70	Printing Graphics
71	Column-Oriented Graphics
72	Dot Spacing
73	A Graphics Example
74	Line-Oriented Graphics
74	Exact Dot Placement
75	Creating a Format File

Appendixes

77

79	A	Troubleshooting
81	B	Command Summary
87	C	ASCII, Binary, and Hexadecimal Codes
91	D	Character Specifications
101	E	Printer Specifications
103	F	Interface Specifications
107	G	Firmware Modifications

Glossary

109

Index

115

Quick Reference Card

Figures and Tables

Chapter 1 Getting to Know Your Printer

- 4 Figure 1-1 Unpacking Your Printer
- 5 Figure 1-2 Removing the Carrier Cover
- 6 Figure 1-3 Front View
- 6 Figure 1-4 Setting the Release Lever
- 7 Figure 1-5 Rear View
- 7 Figure 1-6 The Printer Covers
- 8 Figure 1-7 Interior Parts
- 9 Figure 1-8 Control Cluster
- 11 Figure 1-9 Dot-Matrix M

Chapter 2 Setting Up Your Printer

- 16 Figure 2-1 Removing the Covers
- 16 Figure 2-2 Finding the Sprockets
- 17 Figure 2-3 Adjusting the Sprockets
- 18 Figure 2-4 Loading Pin-Feed Paper
- 19 Figure 2-5 Pin-Feed Paper Loaded
- 19 Figure 2-6 Loading Plain Paper
- 20 Figure 2-7 Plain Paper Loaded
- 21 Figure 2-8 Adjusting for Paper Thickness
- 21 Figure 2-9 Changing the Ribbon
- 22 Figure 2-10 The Ribbon Loaded
- 22 Figure 2-11 Removing the Ribbon

Chapter 3 Caring for Your Printer

- 28 Figure 3-1 Paper Error Detector
- 28 Figure 3-2 Type Head Lock Plates
- 29 Figure 3-3 Lubrication Ring

Chapter 4 Controlling Your Printer

- 35 Figure 4-1 DIP Switches
- 38 Table 4-1 Hexadecimal and Binary Equivalents
- 43 Table 4-2 Alternate Language Characters

Chapter 5 Advanced Control Codes

- 69** Figure 5-1 Designing a Custom Character
- 72** Figure 5-2 Effect of Data Byte for *k*

Appendix A Troubleshooting

- 79** Figure A-1 Fuse

Appendix D Character Specifications

- 92** Figure D-1 Fixed-width Characters
- 94** Figure D-2 Proportional American Characters
- 96** Figure D-3 Fixed-width Foreign Language Characters
- 98** Figure D-4 Proportional Foreign Language Characters

Appendix F Interface Specifications

- 103** Figure F-1 RS232C Connector Pin Assignment
- 104** Figure F-2 Circuit: SN 75189A or Equivalent
- 105** Figure F-3 Circuit: SN 75188 or Equivalent
- 105** Figure F-4 Threshold Voltage Level

About This Manual

This volume is the first one you should read when you open your Apple Imagewriter package. You get Part II of this manual in a separate volume, the *Apple Imagewriter User's Manual, Part II*, containing information specific to using the Apple Imagewriter with your particular Apple computer. You should read that when connecting your Imagewriter to your Apple computer.

This manual is arranged so you can find the information you need, quickly and easily. Here is an overview of what this manual contains.

- Chapter 1, *Getting to Know Your Printer*, explains how to unpack your printer and familiarizes you with its various parts and with how it works.
- Chapter 2, *Setting Up Your Printer*, describes how to load paper and ribbon in the printer, and how to give it a built-in performance test.
- Chapter 3, *Caring for Your Printer*, discusses how to make your printer work at its best.
- Chapter 4, *Controlling Your Printer*, tells you how to use control codes to modify the printer's operation for various printing formats.
- Chapter 5, *Advanced Control Codes*, explains more sophisticated control codes—an extension of the methods introduced in Chapter 4.
- Appendix A, *Troubleshooting*, contains helpful hints to assist you in overcoming any problems that might occur.
- Appendix B, *Command Summary*, is a handy reference list of printer commands.
- Appendix C, *ASCII, Binary, and Hexadecimal Codes*, lists code values for each character.
- Appendix D, *Character Specifications*, depicts each character as it is printed by the Apple Imagewriter.

- Appendix E, Printer Specifications, contains technical specifications for the Apple Imagewriter.
- Appendix F, Interface Specifications, contains technical information about the printer's serial interface.
- Appendix G, Firmware Modifications, contains information on certain control and tabbing codes that are referenced throughout this manual and are implemented on Apple Imagewriters with serial numbers 250001 and above.
- A glossary and index are also provided.

The following chart recommends chapters and appendixes for various types of readers. You may be a combination of types (for example, you may be a first-time user setting up your own system).

Chapters Reader	Appendixes									
	1	2	3	4	5	A	B&C	D	E&F	G
Person setting up the system	•	•	•			•			•	•
First-time user wanting to use already connected system with ready-made programs	•	•				•				
Experienced Apple computer user	•			•			•		•	
Programmer	•			•	•		•	•		•
Business person	•	•	•			•				

- Gray boxes contain incidental information you may find useful.
- Warning boxes indicate potential problems or disasters.
- Notes in the margins point to useful information contained elsewhere in the manual.



Warning

This product is equipped with a three-wire grounding type plug, a plug having a third (grounding) pin. This plug will only fit into a grounding-type AC outlet. This is a safety feature. If you are unable to insert the plug into the outlet, contact a licensed electrician to replace the outlet and, if necessary, install a grounding conductor. Do not defeat the purpose of the grounding-type plug.

Getting to Know Your Printer

-
- 3** Unpacking
 - 5** First, a Few Names
 - 5** Exterior Features
 - 7** Inside the Machine
 - 9** Controls and Indicators
 - 10** How the Apple Imagewriter Works

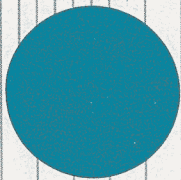
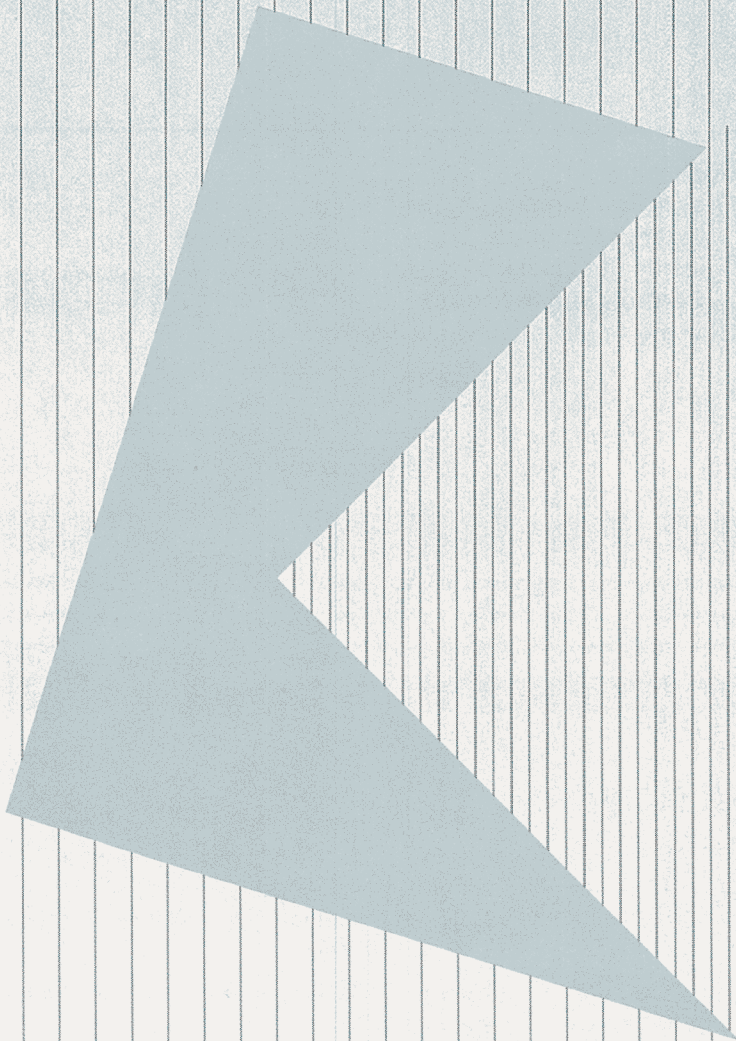

Getting to Know Your Printer

With your new printer you can create a paper copy of anything you can display on the video screen. You can do things with the paper copy that are impossible with a video screen image: send it through the mail, clip it to a report, post it on the wall, or file it with other written material.

But your Apple Imagewriter also lets you do more. It contains its own *microprocessor*, allowing it to work on its own with the data it receives from your Apple computer. It can store tabulating commands and fill out forms, printing both backwards and forwards while moving the paper both up and down. It can print foreign language *characters* from its built-in *fonts*, and even reproduce alphabets of special symbols you have designed. It can underline your text or print it in boldface, with a wide range of character and line spacing options. Finally, it can print drawings: graphs, pictures, and diagrams, for example. Teamed up with your Apple computer, the Apple Imagewriter provides you with a whole new kit of tools.

Unpacking

Your Apple Imagewriter and power cord are packed in a single carton. All cables, manuals, and other items specific to your particular Apple computer come in a separate, smaller accessory kit. Here's how to unpack the larger box:

1. Cut the tape seals on the top of the big carton, being careful not to cut too deeply into the box.
2. Open the top flaps of the carton. Remove the cardboard top plate, the typed sample sheet, the ribbon cassette, and the power cable.
3. Using both hands, draw the white polystyrene packing form upward and out of the box. Save it for later use. (You'll learn how to repack your printer in Chapter 3.)

Figure 1-1. Unpacking Your Printer

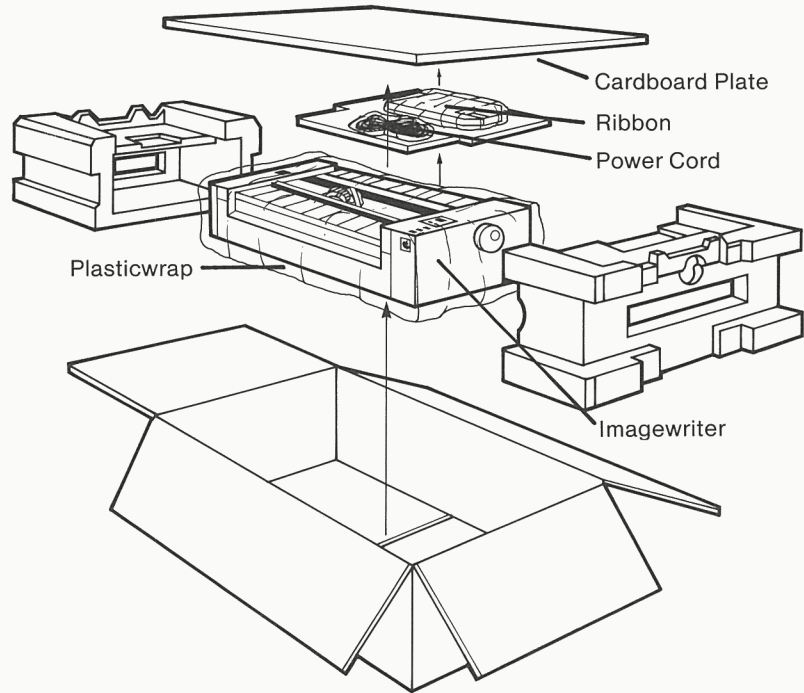

4. Reach under the bottom of the printer with both hands and lift it out. Place it near by. Set the carton aside for future use in transporting your printer or for reshipping.



Warning

Don't try to lift the printer by its knob or sides; this may damage the platen. Instead, reach completely underneath it.

5. Remove the plastic bag from the printer. Save it.
6. Remove all pieces of tape from the outside of the printer. (Each piece of tape is folded at one end to provide a handle for removing it.)
7. Remove the carrier cover from the printer: lift upward on its leading edge and pull it toward you. Peel off and discard the protective film that covers its clear plastic lid. Set the cover aside.
8. Remove and save the cardboard retainer that centers the type head inside the printer.

9. Replace the carrier cover: fit its rear edge into the edge of the rest of the printer's cover (near the *platen*) and bring the front downward over the printer's front panel. It should snap into place.

Figure 1-2. Removing the Carrier Cover

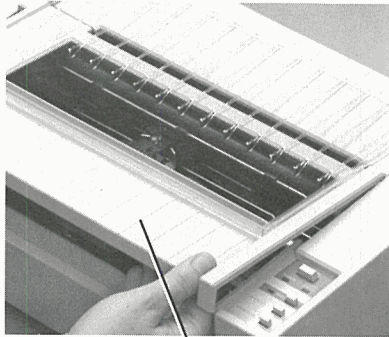

Carrier Cover

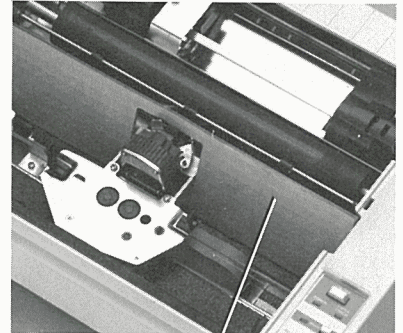

Cardboard Retainer

Warning

Do not attempt to plug in or operate the printer just yet. If you try to run the printer without installing ribbon and paper, you may damage its type head.

First, a Few Names

Before proceeding further, you should take a minute to learn the names of your Apple Imagewriter's parts and controls. With the printer unpacked and sitting on the table in front of you, compare it with the labeled pictures.

Exterior Features

The power switch is located in the control cluster on the right side of the printer, on top, and is marked ON/OFF. When it's time to turn the printer on, you will press this switch.

Warning

Leave the power switch off until you are ready to perform the built-in test described in Chapter 2, Setting Up Your Printer.

The platen knob and release lever are used only when paper is being loaded, as described in Chapter 2, Setting Up Your Printer. Don't touch them while the printer is printing.

Figure 1-3. Front View

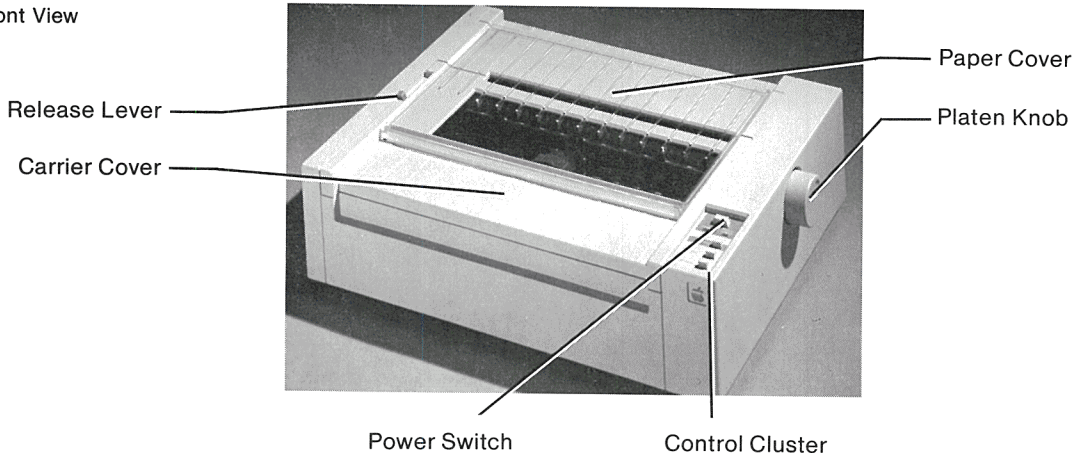



The release lever determines how paper is fed through the printer. The pin-feed setting, marked , is used for form paper with holes along the margins. The friction setting, marked , is used for ordinary paper without holes.

Figure 1-4. Setting the Release Lever



The control cluster is recessed on the top of the printer to the right. Its buttons and lights are discussed under Controls and Indicators, later in this chapter.

You will use the long *interface* connector cable to connect the printer to your Apple computer via the modem eliminator, and will also plug in the power cable to the printer power connector, as described in the *Apple Imagewriter User's Manual, Part II*.

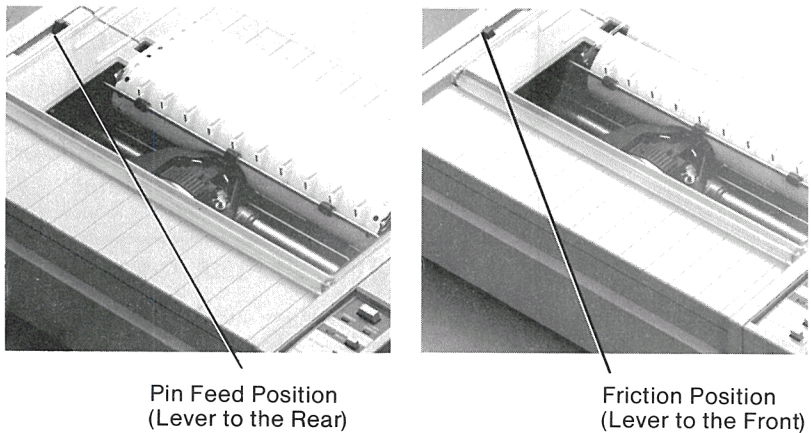
Figure 1-5. Rear View

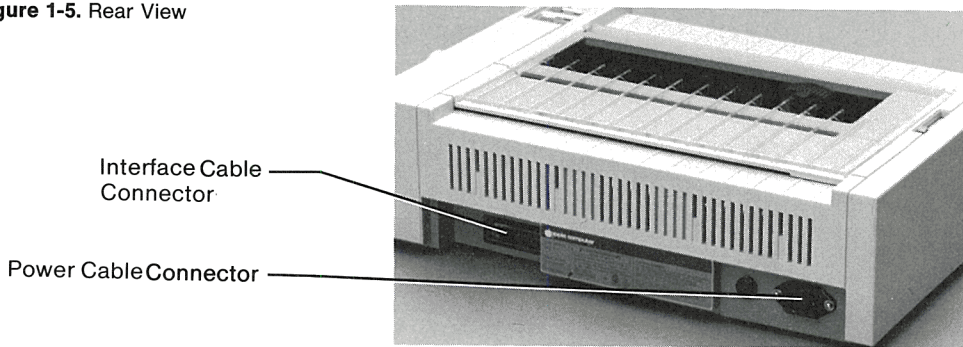

Inside the Machine

The only time you'll need to open your printer will be to replace paper and ribbon or to make certain adjustments. You should leave service of the working parts of your Apple Imagewriter to a qualified technician.

The carrier cover and the paper cover help prevent dirt and paper clips from getting inside the printer, and ensure that nothing interferes with the moving parts while they are working. The printer will not operate unless the carrier cover is completely shut.

Figure 1-6. The Printer Covers

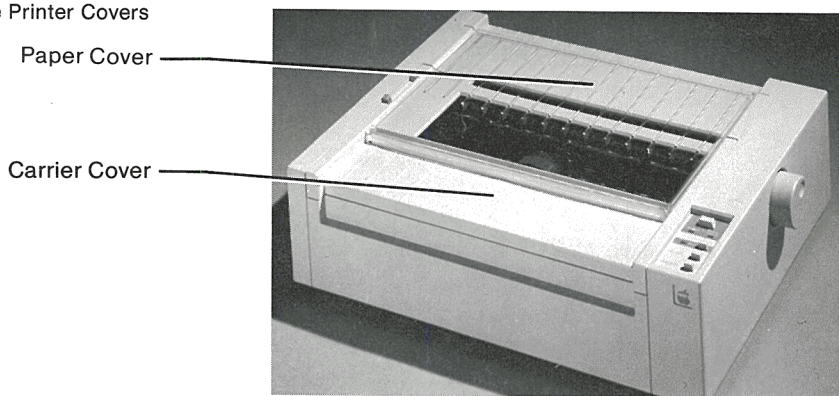

Warning

Before opening either cover, always be sure the POWER light is off.

First, a Few Names

Remove the covers now, following the directions below.

Remove the carrier cover, by lifting its leading edge and sliding the cover toward the front of the machine. The entire cover comes off. The clear plastic lid is hinged to allow access to the inside when changing ribbons or adjusting paper. It is normally kept closed.

Grasp the center of the paper cover and pull gently upward. It should come up quite easily.

Now refer to Figure 1-7 as you locate some of the interior parts.

Figure 1-7. Interior Parts

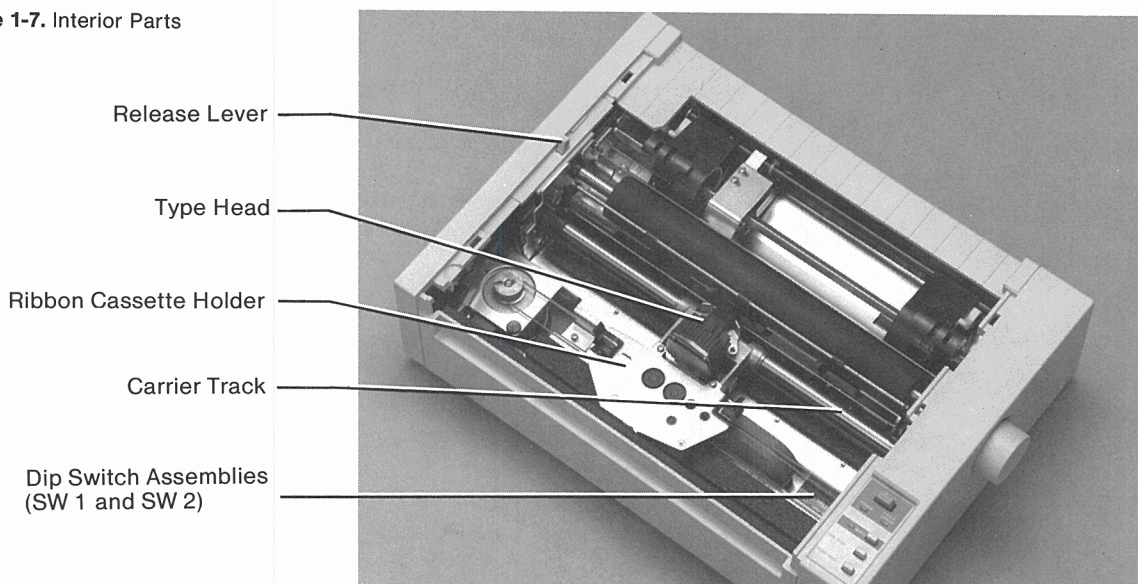

Chapter 2, *Setting Up Your Printer*, tells you how to change the ribbon. Removal and cleaning of the type head is covered in Chapter 3, *Caring for Your Printer*.

The ribbon is enclosed within a plastic ribbon cassette that allows easy ribbon changing without threading or handling spools. The type head sticks up through the ribbon cassette. It prints characters by the *dot matrix* method, explained later in this chapter.

Two *DIP switch* assemblies are located inside the machine, at the bottom, on the right side of the carrier track (the track the type head assembly travels in). These switches control a number of important preset functions, as discussed in Chapter 4, under *DIP Switch Settings*.



Warning

The two blue controls to the left of the DIP switch assemblies should be adjusted only by a service technician. They control the strength of the printer impression and the alignment of the type head.

Controls and Indicators

You can operate your new Apple Imagewriter entirely from your Apple computer, but for convenience a few buttons and lights are included on the printer itself.

Figure 1-8. Control Cluster

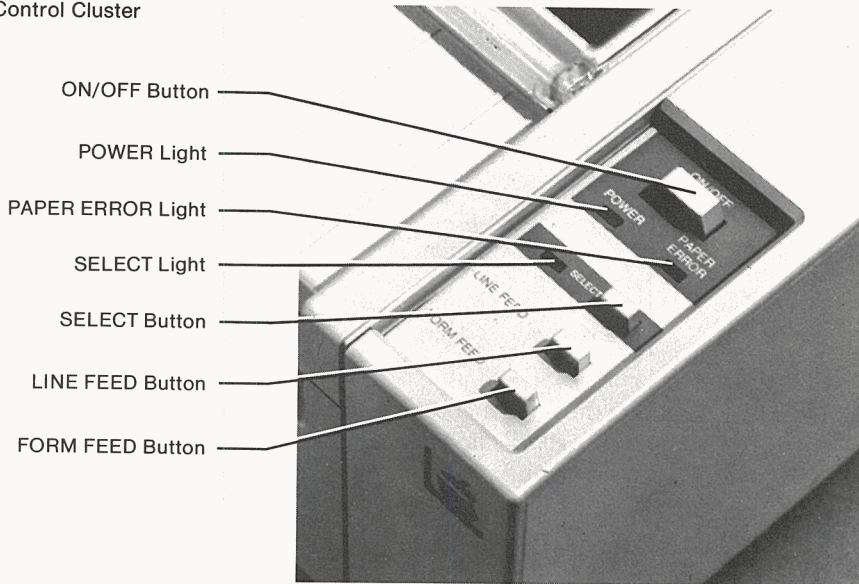

The green POWER light comes on whenever the printer is plugged in and the ON/OFF switch is on.

The button marked SELECT is the SELECT button. When the corresponding SELECT light is on, your printer can receive data from your Apple computer. When the SELECT light is off, you can control the printer with the switches in its control cluster, but it won't receive data from the computer.

All buttons in the control cluster work like toggle switches between two modes; each time you press the button, the printer changes to the other mode.

By The Way: If you open the carrier cover while the printer is printing, the printer will stop and the SELECT light will go out. To resume printing, close the cover tightly and press the SELECT button.

The button marked LINE FEED is the *line feed* button. Each time you press the LINE FEED button, the printer advances the paper one line. The LINE FEED button works only when the SELECT light is off. Holding down the LINE FEED button will cause the printer to feed paper continuously, after five individual line feeds, until you release the button.

The button marked FORM FEED is the *form feed* button. When you press the FORM FEED button, the printer feeds blank paper continuously until it reaches the top of the next page, where it stops. This is a handy way to bring completed work out of the printer so it can be torn off. The FORM FEED button works only when the SELECT light is off.

By The Way: You can stop the action of the printer at the end of any printed line by pressing the SELECT button. This deselects the printer, and while it is stopped, you can operate the LINE FEED and FORM FEED buttons; commands from the computer will be ignored. To resume printing from the place where you stopped, press the SELECT button.

When there is only about an inch of paper left in the printer, the PAPER ERROR light comes on and the printer stops printing. If you want to print the next line or so anyway (to finish a form that is nearly done), just press the SELECT button once for each additional line to be printed.



Warning

Do not press the SELECT button to make the Apple Imagewriter print when there is no paper under the type head. This will damage both the type head and the platen.

How the Apple Imagewriter Works

The Apple Imagewriter is a dot matrix printer. You may wonder how it prints its characters. A conventional typewriter has a different type bar or type ball section for each character it can strike. The Apple Imagewriter, on the other hand, prints every character with a single type head. It does this by generating each character as a pattern of dots chosen from an array 16 dots wide

Figure 1-9. Dot-Matrix M

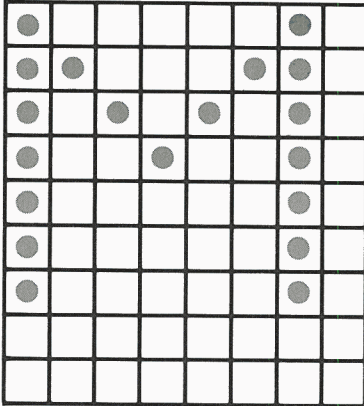

by 9 dots high. The printer's standard characters are 7 dots wide and 8 dots high; the space between characters is 1 dot wide. Keeping track of which dots to print and where to print them is the job of the microprocessor inside the Apple Imagewriter.

As shown in the figure, the capital letter *M* is made up of 19 dots. The type head contains only a single vertical column of 9 dot-strikers (called *wires*). As the column of wires moves along the paper, it strikes successive patterns to create each printed character. Thus, when your Apple Imagewriter prints a row of 80 characters, the wires may strike the paper as many as 10240 times (1 character = up to 16 dots wide x 8 dots high = 128 dots per character x 80 characters = 10240 dots per line).

The crackling sound you hear as the printer prints comes from the rapidity of its individual strikes. The type head can print characters while moving in either direction, by simply reversing the order of striking patterns.

You are now familiar with the main parts of your printer and with how it works. In the next chapter you'll prepare your printer for use.

Setting Up Your Printer

-
- 15** Loading the Paper
 - 16** Setting the Pin-Feeder Width
 - 18** Loading Pin-Feed Paper
 - 19** Loading Plain Paper
 - 20** Setting the Top of the Page
 - 21** Adjusting for Paper Thickness
 - 21** Installing and Removing the Ribbon
 - 23** Testing Your Printer
 - 24** Connecting Your Printer
 - 24** Creating a Work Space

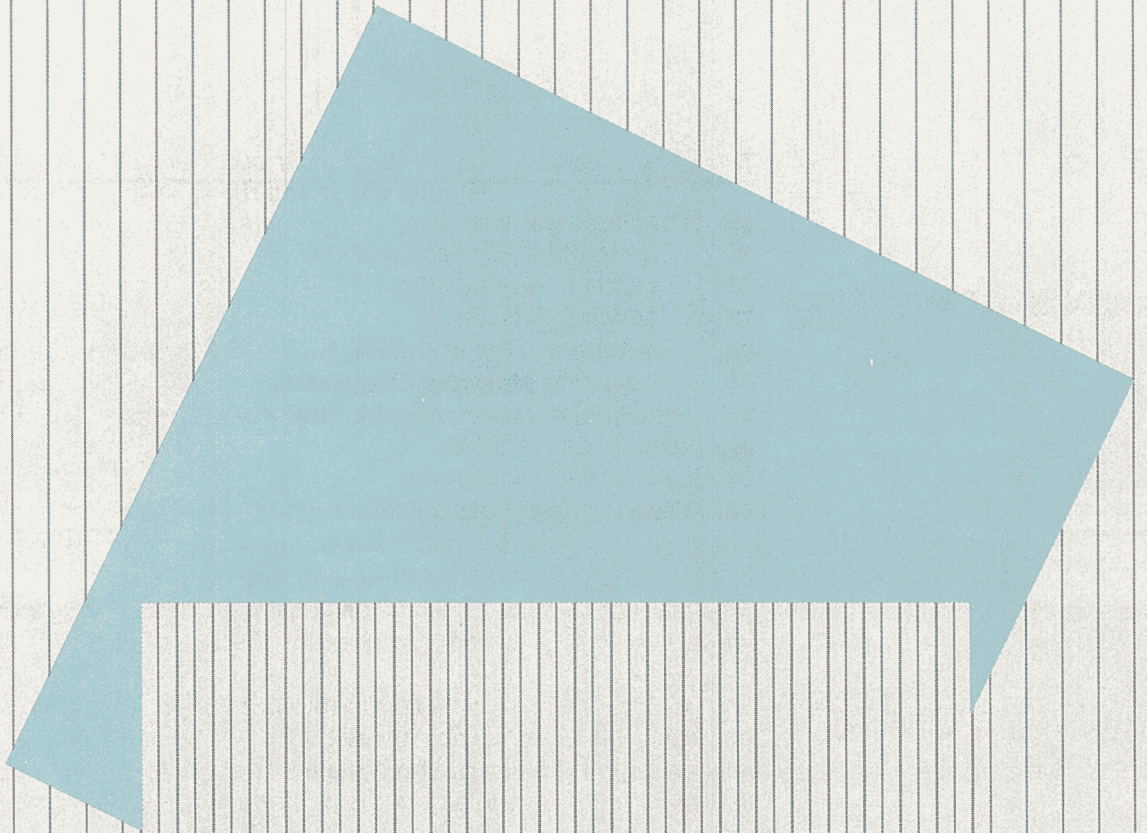

Setting Up Your Printer

This chapter shows you how to get your printer up and running. You'll learn about loading the paper and ribbon, running the printer through a built-in test, and connecting it to your computer.

Loading the Paper

You can put ordinary typing paper, business forms, and letterhead into your Apple Imagewriter. You may find it more convenient to use special *pin-feed paper* or *roll paper* made for computer-driven printers.

The Apple Imagewriter prints on ordinary bond paper, up to 24-pound weight. (Standard pin-feed computer paper usually comes in 15- and 20-pound weights.) Heavier paper may not feed properly; lighter paper, such as onionskin, may give a poor print image unless it is backed by a sheet of 15-pound bond.

You can also use multiple forms in your printer, provided their total thickness (including carbon sheets) does not exceed 0.28 millimeter (0.011 inch), or about the thickness of four sheets of 15-lb. bond. You'll have to adjust the printer when printing on more than one sheet (see Adjusting for Paper Thickness).

You can adjust your Apple Imagewriter to accept pin-feed or roll paper of from 3 to 10 inches in overall width. This includes standard 9-1/2-inch-wide pin-feed paper, which produces 8-1/2-by-11-inch finished pages after you tear off the perforation strips. You can also use several standard sizes of pin-feed label stock, for jobs such as printing mailing labels. If you like, you can position the paper so that the printer prints right up to the perforation line on either side (but not both sides at once).



Warning

Never put paper with staples or paper clips in your Apple Imagewriter.

For further information about multisheet forms, see Appendix E.

The next two sections describe how to load pin-feed paper into your Apple Imagewriter. If you plan to use roll paper or single sheets of paper without pin-feed holes, skip ahead to the section entitled Loading Plain Paper.

Setting the Pin-Feeder Width

The first time you use pin-feed paper in your Apple Imagewriter you will need to set the spacing of the *sprockets*. Here is how to do it:

1. Tear off a single sheet of the pin-feed paper you are going to use, to serve as a gauge.
2. Make sure the printer is off.

Figure 2-1. Removing the Covers

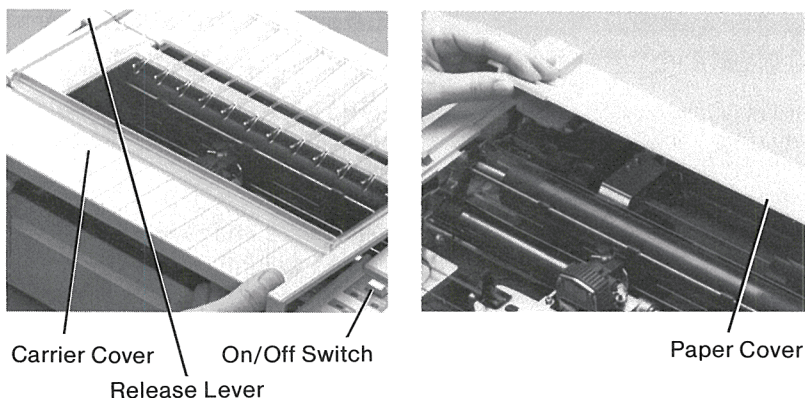

3. Remove both the carrier cover and the paper cover.
4. Set the release lever to the friction (forward) position.

Figure 2-2. Finding the Sprockets

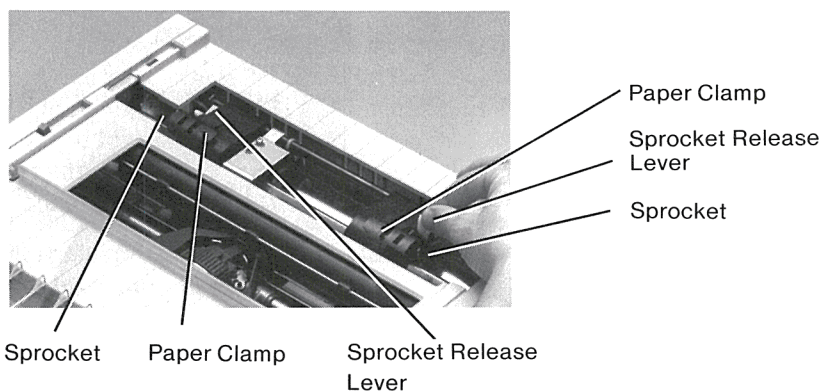

5. The sprockets are the two black plastic parts inside the machine at the rear. Lift up the two tabs that point toward the center, so that the hinged paper clamps over the two sprockets swing outward. Find the white sprocket release levers on the side of each sprocket. When the white levers are pushed toward the rear, the sprockets are free to slide along their square shaft. When the levers are forward, the sprockets are locked in place.
6. Push the white sprocket release levers to the rear (so that the sprockets are free to slide) and place the single sheet of pin-feed paper you tore off to serve as a gauge in step 1 over the sprockets. Position the sprockets so that the pins fit through the holes in the paper. Snap the paper clamps back into place.
7. Feed the forward end of the paper under the rubber platen and into the printer, as you would in a typewriter, by turning the platen knob. Lift the roller shaft in the front of the machine and guide the paper under it. Then set the release lever to the pin-feed (rear) position.

Figure 2-3. Adjusting the Sprockets

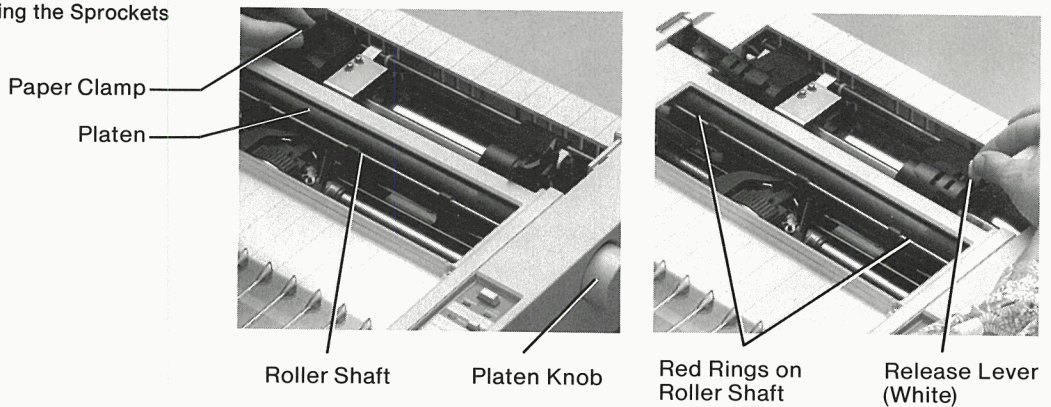

8. You can now move the paper sideways, carrying the two sprockets with it, until it is centered with respect to the printing area. The two red rings at each end of the roller shaft tell you where the margins of an eight-inch printed line occur. When the paper is in place, pull the release lever forward to the friction position to hold it in place.
9. Open the hinged cover on each sprocket and push the white lever forward. Make sure the sprocket pins fit easily in the holes in the paper, without pulling inward or outward.
10. Push the release lever back to the pin-feed position.

Loading Pin-Feed Paper

Follow these steps to load pin-feed paper into your Apple Imagewriter:

1. If the end of the paper you are going to use is not straight, tear it off at the nearest perforation.
2. Make sure the printer is off.
3. Remove both the carrier cover and the paper cover.
4. If necessary, set the pin-feeder width as described earlier.
5. Set the release lever to the friction (forward) position.
6. Grasp the roller shaft at both ends, and pull it forward.
7. Lift the paper clamps on the two black sprockets at the rear inside the machine, folding them outward to expose the sprockets.

Figure 2-4. Loading Pin-Feed Paper

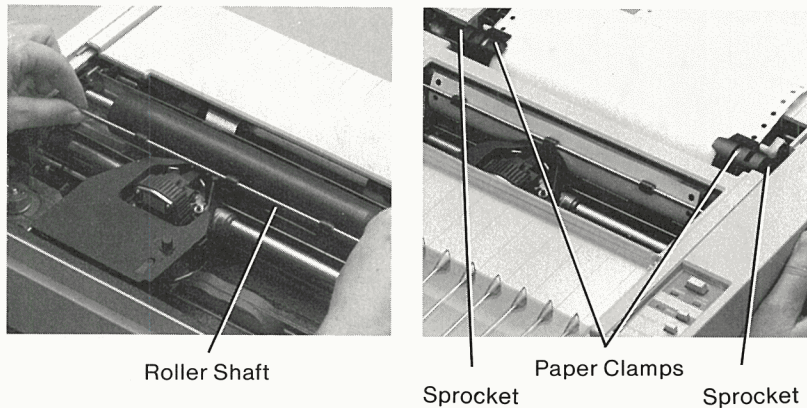

8. Place the paper over the sprockets so that the pins go through the paper holes. Snap the paper clamps back down to hold the paper in place.
9. Pull the pin-feed paper into the printer by turning the platen knob clockwise (top away from you).
10. When the end of the paper comes up the front of the platen, under the type head, snap the roller shaft shut on it.
11. Close the paper clamps on the sprockets.
12. Push the release lever back to the pin-feed position.

13. Replace the paper cover and the carrier cover.
14. Line up the first perforation with the top of the type head.

Figure 2-5. Pin-Feed Paper Loaded

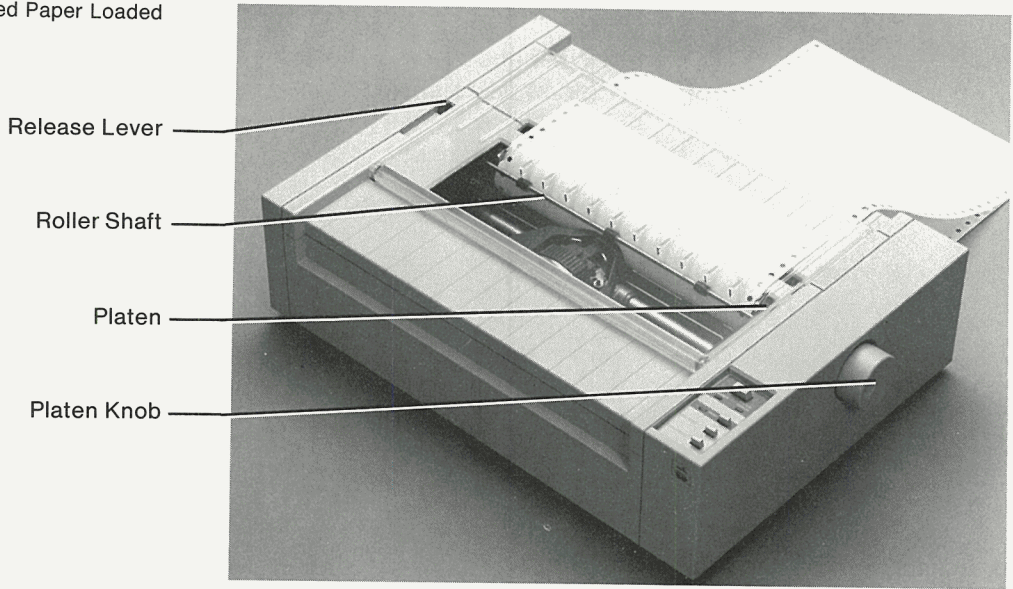

Loading Plain Paper

To load paper without pin-feed holes—either a single sheet or a roll—do the following:

1. Turn the power on and then off. This moves the type head as far left as it will go. Leave the power off.
2. Open the clear plastic lid on the top of the machine.
3. Set the release lever to the pin-feed (rear) position.
4. Grasp the roller shaft by both ends, and pull it forward.

Figure 2-6. Loading Plain Paper

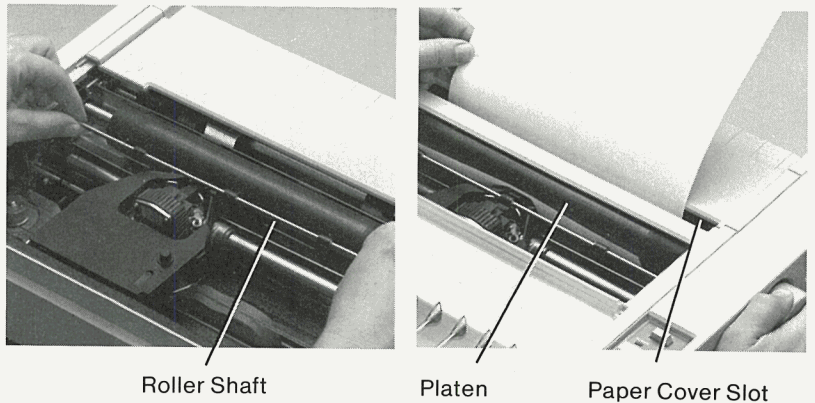

5. If you are using a roll of paper and the end of the paper is not straight, cut across it with scissors. Push the end of the paper down into the slot in the paper cover, feeding it around the platen as you would in a typewriter.
6. When the paper comes up in front of the platen, move it sideways to the location you want. The red rings on the roller shaft indicate the limits of the printer's line of type. Snap the roller shaft shut.
7. Set the release lever to the friction (forward) position.

Figure 2-7. Plain Paper Loaded

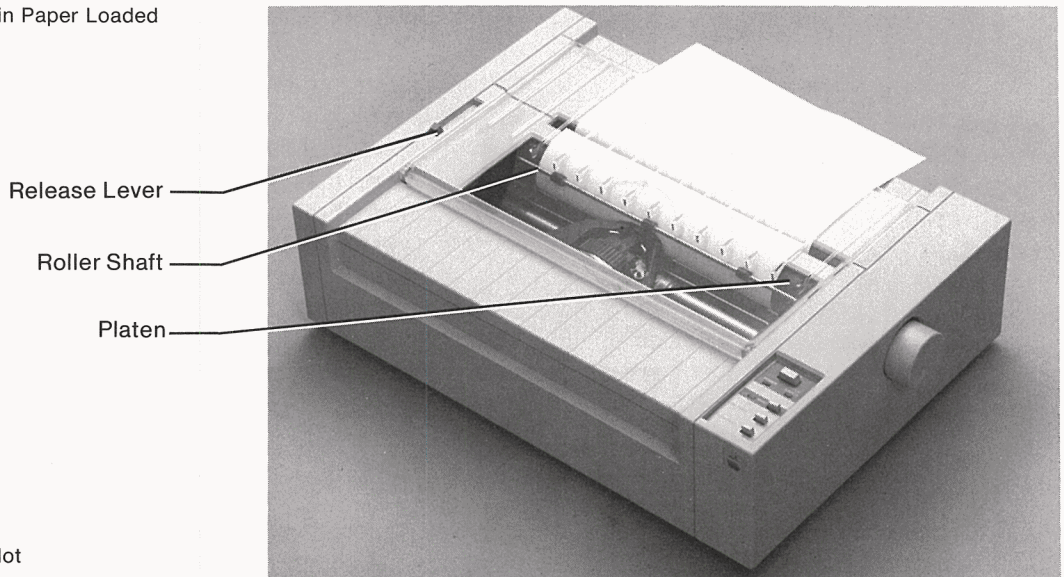

Setting the Top of the Page

When you press the FORM FEED button in the control cluster, the Apple Imagewriter feeds paper through to the top of the next page.

Pin-feed paper is perforated between pages, so pressing the FORM FEED button brings the paper to a handy place to tear it off.

By the Way: Your printer was set at the factory for a page length of 11 inches (66 lines). If you want to change the page length, see Chapter 4, Controlling Your Printer.

To position the top of form after you have loaded a new supply of pin-feed paper, make sure the power is off. Then simply turn the

platen knob to bring the paper to the desired position. (Usually the top of the page should be level with the top of the type head.) Unless you turn the platen knob again or send control sequences to the printer to change the settings (instead of moving paper up by means of the LINE FEED button), the FORM FEED button will feed paper to the top of the next page each time you press it.

Adjusting for Paper Thickness

Your Apple Imagewriter will make higher-quality copies and give you longer service if you take care to adjust it for the thickness of paper you are using.

Remove the carrier cover and look inside the printer. On the right side, near the platen knob, you will find a white plastic lever. When this lever is pushed all the way back (toward the platen), the printer is correctly set to print on a single thickness of ordinary paper. When the lever is pulled all the way forward (toward the control panel), the printer is set for a four-sheet multiple form. As you move the lever back and forth you can see a slight movement of the horizontal metal carrier bar on which the type head slides, compensating for the paper thickness. You can also feel that it clicks in four positions, corresponding to one to four sheets of ordinary paper.

Figure 2-8. Adjusting for Paper Thickness



Paper Thickness Lever
(Orange Lever Beneath Cover)

Installing and Removing the Ribbon

The ribbon cassette supplied with your printer is a special type, made specifically for this machine. You can get additional ribbons from your Apple dealer.

Changing ribbons is fast and easy. To install the ribbon that was packed with your printer, do the following:

1. Make sure the power is off.
2. Remove the carrier cover.
3. Take up slack in the ribbon by turning the knob on the cassette once or twice in the direction of the arrow.
4. Carefully slip the exposed portion of the ribbon between the black plastic ribbon guide and the thin metal ribbon guide plate (the part that nearly touches the paper). At the same time, guide the cassette downwards onto the ribbon deck. The two black plastic cassette supporters (the parts that stick up) fit into the notches on the sides of the cassette.

Figure 2-9. Changing the Ribbon

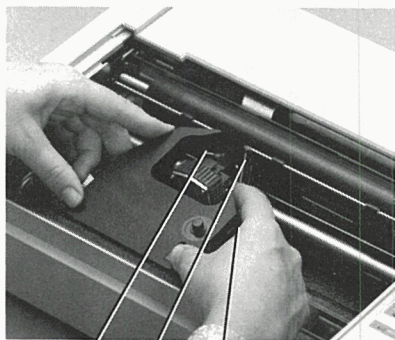

Cassette Support
Ribbon Guide Plate
Ribbon Guide

5. The cassette should easily snap in place with a single motion. If it refuses to go down completely, or if the ribbon is caught in the space between the ribbon guide and guide plate, turn the knob on the cassette slowly in the direction of the arrow as you seat it. When properly installed, the cassette should lie flat on the ribbon deck.

Figure 2-10. The Ribbon Loaded

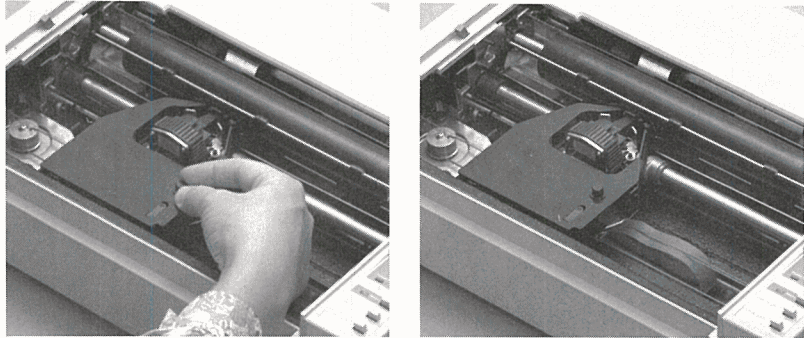

To remove a used ribbon cassette, turn off the power and remove the carrier cover. Gently spread the two black plastic cassette supporters and lift up the cassette.

Figure 2-11. Removing the Ribbon

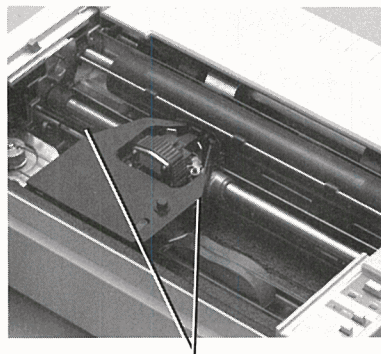

Cassette Supports



Warning

When pulling the cassette away, be careful not to get the ribbon caught between the ribbon guide and the guide plate.

Testing Your Printer

Inside your Apple Imagewriter is a microprocessor with a permanent program that can print a test alphabet on command. The printer does not need to be connected to a computer to run this program. It is a handy way to put the machine through its paces before connecting it to your system.

To run the built-in test, follow these steps:

1. If you have not already done so, load paper and ribbon into the printer.
2. Plug the printer into an electric power outlet and turn the printer on with the ON/OFF switch. The POWER light should come on.

Warning

All electrical connections to your computer and peripheral equipment **must be grounded!** The electrical ground prevents damage from a power surge to your computer or monitor or you. If your electrical outlet doesn't have a third hole (the round one), have a qualified electrician determine if the outlet box itself is grounded. If it is not, have the electrician install the correct wiring before using your computer and printer. If it is grounded, you can plug your computer into the outlet using an adapter available in any hardware store. This kind of adapter has a "pigtail," or metal tab, that can be secured with the screw that holds the cover plate to the outlet.

3. If the SELECT light also comes on, press the SELECT button once to turn it off.
4. Press the LINE FEED button a few times to make sure the paper feeds smoothly through the machine.
5. Turn the power off.
6. Press the FORM FEED button and continue holding it in while you turn the power back on. Then release the FORM FEED button. The Apple Imagewriter will print its complete set of characters repeatedly until you press the ON/OFF switch to turn the power off. It takes 96 lines to print the entire pattern.

Examine the print-out carefully. All the characters should be complete (no dots missing) and neatly aligned. The lines should appear equally black from end to end. Spacing between characters and between lines should be even. If this is not the case, check for correct ribbon insertion, paper loading, and thickness settings. If the problem persists, please contact your Apple dealer.

Connecting Your Printer

Now that you know your new printer works, it is time to connect it to your Apple computer. Details of the electrical hookup are different for every Apple computer. Turn to the *Apple Imagewriter User's Manual, Part II* for instructions on how to perform the hookup. After you have successfully connected the printer to your computer, return to this book and read the remainder of this chapter.

If you have difficulties making the connection, see Appendix A. If you have modified the circuits of your Apple computer, or if you are connecting your printer to another brand of equipment, refer to Appendix F for a technical description of the electronic interface requirements.

Creating a Work Space

Your Apple Imagewriter prefers to work in a clean, vibration-free environment, away from such hazards as chemical fumes and spilled coffee. Your printer is small and light, so you can place it on a shelf or on top of a file cabinet, where it will be out of the way; or you can put it on the back of a desk or table, where it will be easy to reach. The principal limitation on its location is the six-foot connecting cable.

If you will be using any kind of paper other than single sheets, you will need room for the paper supply that feeds into the back of the printer. A stack of pin-feed paper behind the printer will require a space of about 9 inches by 12 inches; roll paper will require less space. You can also place the printer at the back of a desk, shelf, or table, with the paper supply in a box on the floor underneath it.

So now your printer is all set up for operation. In the next chapter you'll learn how to maintain it in top condition.

Caring for Your Printer

27	Operating Environment
27	Cleaning
29	Lubrication
30	Repacking

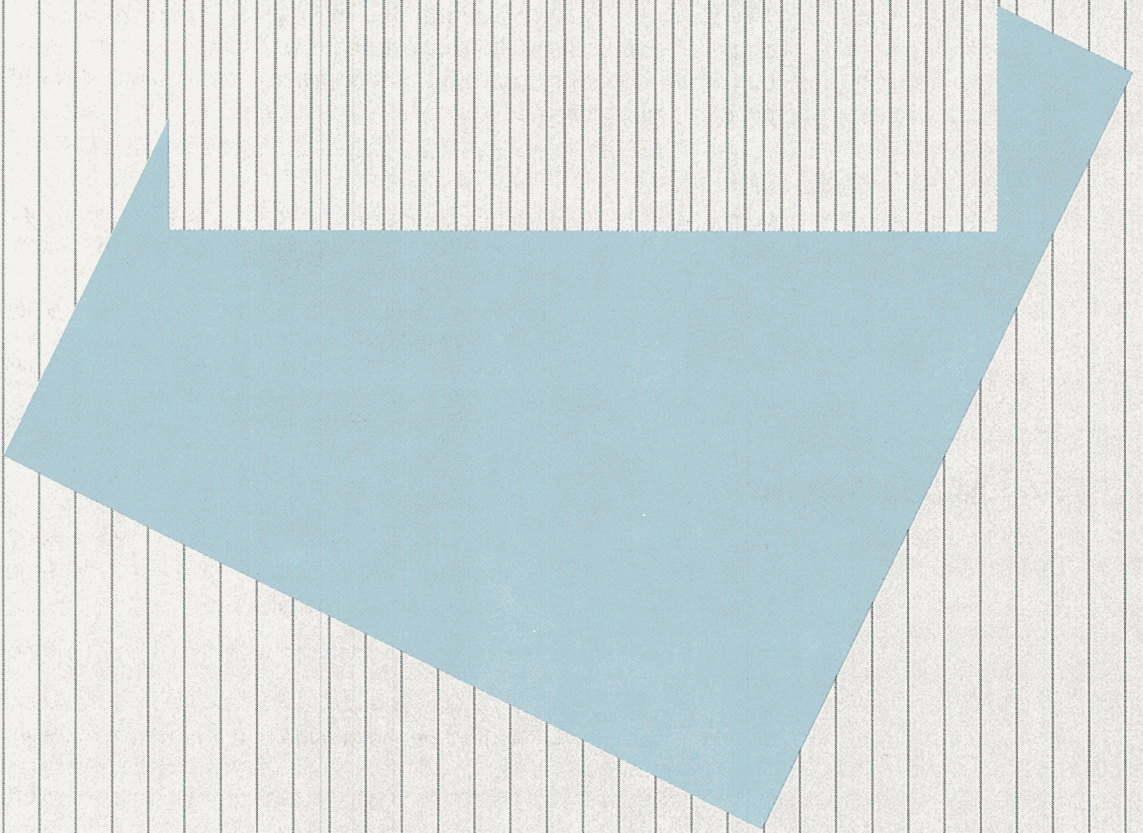
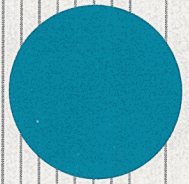

Caring for Your Printer

Think of your Apple Imagewriter as a high-quality typewriter with a built-in microprocessor. By taking care of it as you would any other fine machine, you will save yourself repair bills and always be assured of getting the results the printer was designed to deliver.

Operating Environment

The Apple Imagewriter is intended to be used in a reasonably clean indoor location. It will work reliably in temperatures from 41 to 104 degrees Fahrenheit (5 to 40 degrees Celsius) with 10 to 85 percent humidity.

Warning

When you're not using your printer you can store it at temperatures of -13 to +140 degrees Fahrenheit (-25 to +60 degrees Celsius) without damage, but never try to run it at these extremes.

The printer's covers protect it adequately from dust and foreign objects, but they afford little protection against liquids or vapors. Spilling any liquid inside, or allowing the printer to be exposed to chemical or solvent fumes (including steam from a coffee maker), can harm it.

Cleaning

To clean the outside of the printer, just wipe it with a soft damp cloth. To remove thumbprints, add a drop of liquid dish detergent to the cloth and wipe the surface of the printer.

Warning

Never use household cleansers, ammonia, powders, abrasives, or solvents such as cleaning fluid on the outside of the printer; they may damage the plastic.

Figure 3-1. Paper Error Detector

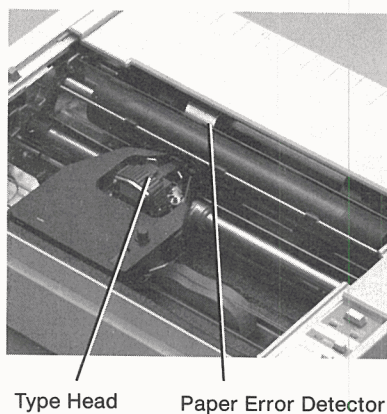

Inside your Apple Imagewriter, only the paper error detector and type head need routine cleaning. Clean them every few months—more often if you use the printer frequently. Here's how to do it:

1. Center the type head between the rollers on the roller shaft, by typing half a line of text and sending it to the printer.
2. Turn the power off before cleaning inside the printer.
3. Remove the carrier cover and paper cover. Find the paper error detector. Clear away any accumulation of paper dust and lint from the lever and hole, using a clean soft brush (such as a small paintbrush or eyebrow brush).
4. Remove the ribbon cassette.
5. Move the two lock plates on each side of the type head outward, away from the type head. If they don't move easily, pry them gently with a coin against the type head. Apply a little upward pressure on the roller shaft, to provide clearance for the type head, and lift the type head straight upward. Since it fits tightly over two guide pins and has an electrical plug on the bottom, it may require modest force to bring it free; but do not strain it or attempt to pry it with tools.

Figure 3-2. Type Head Lock Plates

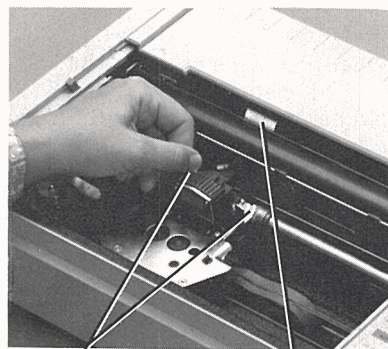

6. Using a clean soft brush, clear away all ribbon chips and paper dust from the type head.
7. Apply upward pressure on the roller shaft to provide clearance for the type head and replace the type head over the two guide pins. Lock it in place by pushing the two lock plates back toward each other.
8. Replace the ribbon cassette, carrier cover, and paper cover.

Lubrication

The lubrication ring is the only part of your Apple Imagewriter that needs regular oiling; all other parts of the mechanism are permanently lubricated.

With the power off, remove the carrier cover and look underneath the type head. You will see a white felt ring encircling the horizontal metal carrier shaft. This is the lubrication ring. As the type head moves back and forth, oil soaked into this felt ring rubs off on the shaft.

Figure 3-3. Lubrication Ring

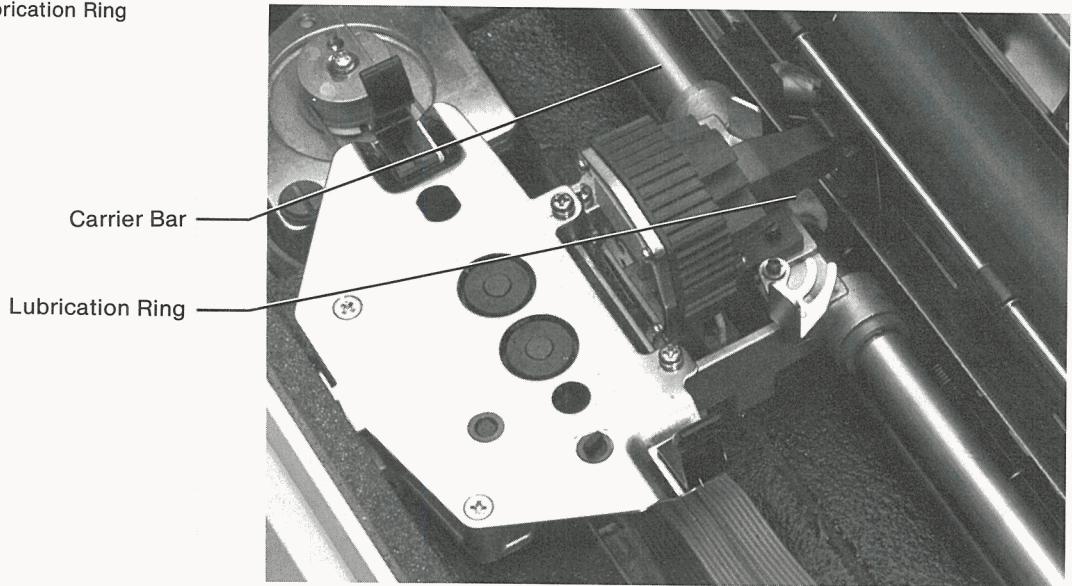

Once a year (or more often if the printer is used frequently), you should clean and lubricate the shaft, following these steps:

1. Remove the type head, following the instructions above.
2. Carefully wipe the shaft clean, using a cloth that will not leave lint behind.
3. Remove the ribbon cassette.
4. Put two or three drops of light machine oil, such as a sewing machine oil, on the top of the felt ring. Do not use electric motor oil or any lubrication that contains rust inhibitors. Be careful not to get oil on other parts of the mechanism.
5. Replace the type head, ribbon cassette, and carrier cover.
6. Finally, after you have everything in place, perform a few lines of the built-in test to spread the new oil over the shaft.

To perform the built-in test, turn the printer off. Then hold the FORM FEED button down and turn the printer back on. Release the FORM FEED button. To stop the test, press the ON/OFF switch again.

Repacking

If you should have to ship or store your printer in the future, the original shipping carton makes the best container. To repack the printer, follow these steps:

1. Before repacking your printer, position the type head in the center of its range, so the cardboard protector will fit over it. Don't attempt to do this manually! You must print a half-line of text to position the type head in the middle of the line.
2. Remove the power cable, connecting cables, and ribbon cassette. Pack them separately in envelopes or plastic bags.
3. Place the cardboard type head protector inside the printer over the type head.
4. Close all covers securely and tape them down.
5. Place the entire printer in its plastic bag.
6. Cradle the printer inside its original shipping carton, using the two molded polystyrene packing forms. Place the forms on each end of the printer, and gently lower the printer with forms into the carton. Place the ribbon and power cable alongside the printer. Reseal the carton with sturdy tape.
7. Store the connecting cables and manuals in the accessory kit.

That's all there is to keeping your printer humming happily along year after year. In the next chapter you'll learn how to customize its operation to meet your needs.

Controlling Your Printer

-
- 34 Changing the Standard Instructions
 - 35 DIP Switch Settings
 - 36 Control Codes
 - 36 Control Characters
 - 36 Control Sequences
 - 37 Functions You Can Change
 - 39 Baud Settings
 - 39 Serial Interface Protocol
 - 39 Character Pitch
 - 41 Proportional Character Spacing
 - 42 Character Repetition
 - 42 Slashed and Unslashed Zeros
 - 43 Foreign Characters
 - 44 Backspacing
 - 45 Underlining
 - 45 Boldface Printing
 - 46 Headline Type
 - 46 Direction of Type Head Motion
 - 46 Line Feed Function
 - 47 Automatic Line Feed
 - 48 Line Feed Pitch
 - 49 Line Feed Direction
 - 49 Multiple Line Feeding
 - 49 Left Margin Setting
 - 50 Page Length
 - 50 Form Feeding
 - 51 Top of Form Set Command
 - 51 Paper Error Detector
 - 51 Restoring Standard Instructions

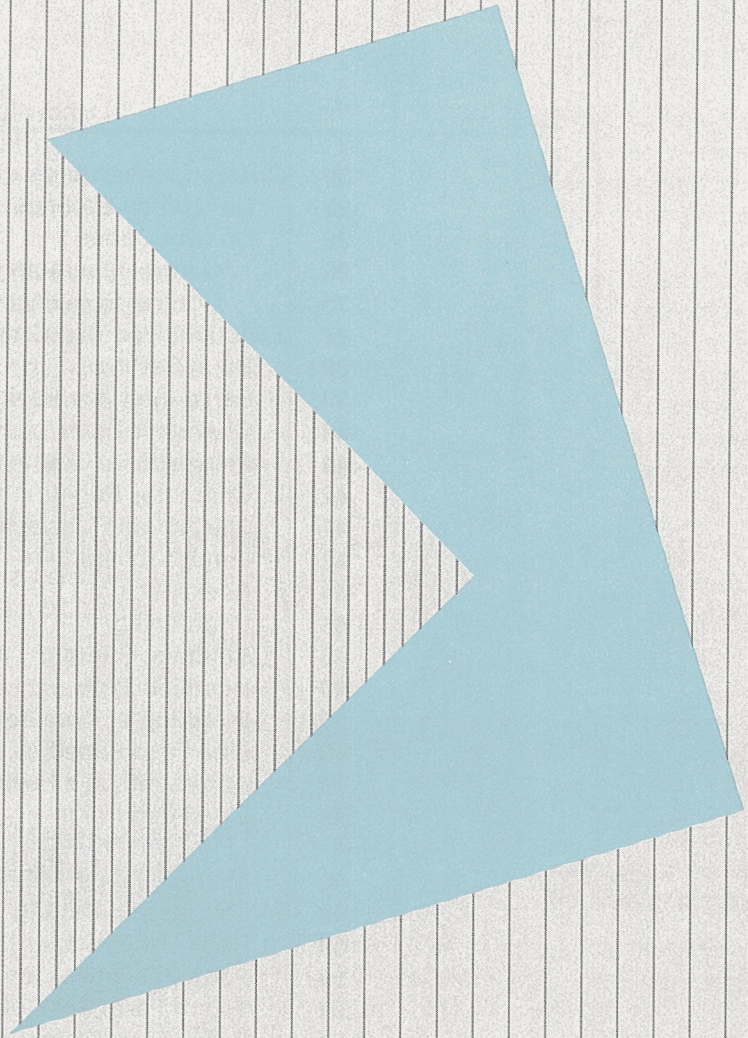

Controlling Your Printer

This chapter describes how to take advantage of some of the versatile capabilities of the Apple Imagewriter. With the technical information in this chapter, you can change the printing *format* of your printer to fit your personal requirements.

The dot matrix printing method gives you maximum flexibility to create written records in exactly the form you want. Besides letting you format ordinary text with a full range of tabbing controls and typographical options (such as boldface printing), the Apple Imagewriter lets you create alphabets of custom characters and even construct page-size *graphics* patterns by the placement of individual dots. Here's what your Apple Imagewriter can do for you:

- Print all the letters, numbers, and punctuation marks that you can type on your Apple computer keyboard or display on the video screen. In addition, it can print foreign language characters.
- Set the number of characters per inch (*character pitch*) to 9, 10, 12, 13.4, 15, or 17. Two additional options allow the character pitch to be determined by the width of each character. Pitches can be mixed within a line.
- Set the spacing between lines (*line feed pitch*) to increments of 1/144 inch, including the standard six or eight lines per inch. Line spacing can be changed within any line.
- Feed paper both up and down, permitting the generation of mathematical formulas and the placement of subscripts and superscripts.
- Set page length to any number of lines up to 72, to conform to standard page length, or allow the print-out to be continuous, without page breaks.
- Print zeros either unslashed (0) or slashed (Ø).

- Print in boldface. The printer does this by printing each character twice, with a small shift of position.
- Underline text.
- Print in double-width headline style.
- Change the location of the left-hand printed margin. The location of the right-hand margin is usually determined by the program you use in your Apple computer.
- Easily fill out complex forms by using a complete set of preprogrammed tab controls—including format specifications for an entire page.
- Print symbols or foreign language characters you design yourself. You can add up to 175 8-dot-by-8-dot characters, or 95 characters that are 8 dots high by 16 dots wide. You can mix these special symbols freely with the standard alphabets and print them with all the formatting features listed above.
- Print drawings, graphs, diagrams, and similar line graphics, by instructing your Apple Imagewriter to print individual dots in specific locations. The available resolution of 160 dots to the inch horizontally and 144 to the inch vertically produces sharp, unbroken lines. You can print graphics up to eight inches wide and any height.

You can accomplish all of this through the relatively simple programming techniques described in this chapter and the next.

Changing the Standard Instructions

Your printer gets its information on how to behave from three sources:

- its microprocessor, the “brain” of the printer
- DIP switches inside the printer case
- formatting commands from your computer

Each time you turn on the printer, the microprocessor is ready to follow a certain set of rules (called *standard instructions*) on how to print—unless you change the rules. Some of the standard instructions are stored within the microprocessor itself, while other instructions are determined by DIP switch settings. For example, the microprocessor automatically instructs the printer to print 6 lines per vertical inch; the way the DIP switches are set at the

factory causes the microprocessor to instruct the printer to print 66 lines per page, to print bidirectionally, and so on.

You can override these rules in two ways: by changing the DIP switch settings and by sending special *control codes* to your printer.

DIP Switch Settings

One way to change the rules is to change the DIP switch settings. Most DIP switch settings affect printer functions that you seldom need to change, such as page length. By setting the appropriate DIP switch in advance, you know that every time you turn the power on, the printer will make each page a certain length—say, 66 lines.

DIP stands for dual in-line package, which is a technical description of the physical form of these switches. When your printer's carrier cover is removed and the type head is at the far left, you can see the two DIP switch assemblies in the bottom of the machine at the right. They are covered with a flap of clear plastic.

There are two DIP switch assemblies: switch assembly 1 (SW 1) is toward the back of the machine and contains eight switches, numbered 1 through 8. Switch assembly 2 (SW 2) is toward the front and contains four switches, numbered 1 through 4. Individual switches are identified by the switch assembly name followed by the individual switch number—for example, switch 2-4 or SW 2-4 is switch number 4 on assembly 2.

Figure 4-1. DIP Switches

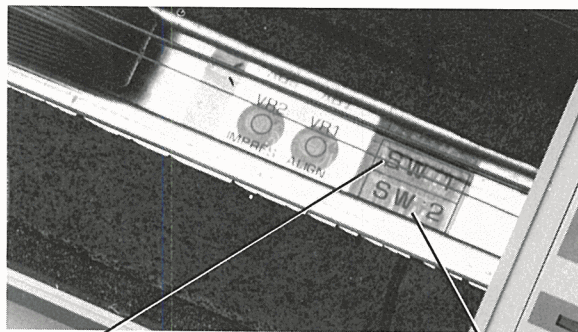

DIP Switch
Assembly 1
(SW 1)

DIP Switch
Assembly 2
(SW 2)

To change a DIP switch setting, turn the power off, curl back the plastic cover to the left, and press the small switch handle to the opposite position with a pointed tool. A DIP switch is said to be closed when its handle is toward the back of the printer. It is open when its handle is toward the front of the machine. Don't forget to turn the power back on when you are finished setting the switch.



Warning

Be sure to turn the power off before adjusting the switches. Don't use a pencil or pen to change a DIP switch setting; they can leave foreign matter behind, which eventually gets into the switch. A round toothpick works best.

Control Codes

The second and most common way to override the microprocessor rules, and the DIP switch settings as well, is to send special control codes from your computer. You'll want to use control codes for things such as printing boldface text, underlining, indenting, and so on. Each time your Apple Imagewriter receives a control code in the information your computer is sending, it pauses imperceptibly to interpret the code and follow its instructions; then it resumes printing.

There are two types of control codes: *control characters* and *control sequences*.

Control Characters

Some printer control codes consist of a single control character. A control character is a special character that is usually not displayed on your video screen and won't be printed as a character by your printer. A control character changes the nature of the character that follows it, like the way the SHIFT key makes lowercase letters into uppercase. For example, the L key produces the letter *L*, but sending a CONTROL-L tells the printer to stop printing on one page and space down to the top of the next page. To learn how to produce a control character with your particular Apple computer, refer to your *Apple Imagewriter User's Manual, Part II*.

Control Sequences

Most printer control codes consist of an ESCAPE character followed by a sequence of characters. An ESCAPE character is similar to a control character: it changes the nature of the

characters that follow it. For example, an ESCAPE ! tells your printer to begin boldface printing. To learn how to produce an ESCAPE character with your particular Apple computer, refer to your *Apple Imagewriter User's Manual, Part II*.

By the Way: If the first character after an ESCAPE character is not a legitimate control code identifier, both it and the ESCAPE character will be ignored by the printer.

Because many standard Apple programs also use the ESCAPE character for special purposes (for instance, to leave a word processor program), it is often not possible simply to type an ESCAPE into *text files*. Techniques for surmounting this difficulty are discussed in the *Apple Imagewriter User's Manual, Part II* for your computer.

Functions You Can Change

The remainder of this chapter lists and discusses printer functions you can change by resetting a DIP switch or sending a control code. Standard DIP switch settings are signified by all capitals: OPEN or CLOSED. Control codes are given in three forms:

- as one or more keyboard characters
- as a sequence of decimal values for the equivalent ASCII codes
- as a sequence of *hexadecimal* values for the equivalent ASCII codes

You don't need to understand what the decimal and hexadecimal numbers mean right now, but you may need to know about them later if you write your own programs or construct format files to send control codes to your printer.

For Experts Only: Those parts of the control codes that consist of letters, numbers, punctuation marks, and other printing characters are easy to send to your printer. However, nonprinting control characters such as ESCAPE and TAB sometimes require special programming techniques. The easiest way to send nonprinting control characters to the printer is to include them in a normal output statement (such as a BASIC PRINT statement or a Pascal WRITE statement).

This has the disadvantage that the characters you type are not visible in your program listing. Worse yet, their presence will be detected by the Apple Imagewriter if you use it to print a copy of your source code, and they will be interpreted as printer control codes during the print-out.

For a discussion of decimal and hexadecimal ASCII code equivalents, see Appendix C.

One technique to avoid this problem is to create such characters as ESCAPE and TAB by means of CHR or CHR\$ functions, although this requires longer program statements. The Pascal function CHR(nn) and the BASIC function CHR\$(nn) both return the ASCII character that corresponds to the decimal number nn. For example, if nn is 27, the function returns an ESCAPE character. Thus, the control code to begin underlining, ESCAPE X, can be sent to the printer by the following statements:

```
(Pascal)          WRITE (PRINTER, CHR(27), 'X')
(BASIC)          PRINT#1 CHR$(27);"X"
```

Your *Apple Imagewriter User's Manual, Part II* can tell you the best way to insert control characters in a file.

The procedures for creating graphics and custom characters with the Apple Imagewriter (discussed in Chapter 5, Advanced Control Codes) often require that you send the printer ASCII characters containing specific bit patterns. The methods just described are valuable here.

Hexadecimal and Binary Numbers: A *binary* number is a sequence of zeros or ones. Every letter, symbol, or command sent to your Apple computer from the keyboard is first converted into an eight-bit binary number. For example, capital X becomes 01011000; the ESCAPE character becomes 00011011. This listing of correspondences between characters and binary numbers is called ASCII.

But eight-bit binary numbers are lengthy and difficult for most humans to read and write; so they are usually changed into two-digit hexadecimal numbers that are easier to use. Hex numbers use the 10 ordinary (decimal) numerals to represent 0 through 9, plus the capital letters A through F to represent 10 through 15. Each hex digit represents four binary digits:

Table 4-1. Hexadecimal and Binary Equivalents

Hex	Binary	Hex	Binary	Hex	Binary	Hex	Binary
0	0000	4	0100	8	1000	C	1100
1	0001	5	0101	9	1001	D	1101
2	0010	6	0110	A	1010	E	1110
3	0011	7	0111	B	1011	F	1111

Thus to convert an eight-bit binary number into a two-digit hex number, simply replace the first four bits with the corresponding hex digit and the last four bits with the corresponding hex digit. Hexadecimal numbers are often designated by preceding the digits with a dollar sign (\$); for example,

\$1A = 00011010

Baud Settings

Your Apple Imagewriter can receive data at 300, 1200, 2400, and 9600 baud (bits per second). DIP switches 2-1 and 2-2 specify the baud setting in effect when you turn on the printer. Both switches normally are closed, and the baud setting is 9600. Refer to your *Apple Imagewriter User's Manual, Part II* and/or your *Serial Interface Card Manual* to see if you need to adjust the baud setting.

Switch 2-1	Switch 2-2	Baud Setting
Open	Open	300
Closed	Open	1200
Open	Closed	2400
CLOSED	CLOSED	9600

Serial Interface Protocol

Your printer can receive data in two different types of protocol: XON/XOFF or Data Terminal Ready. DIP switch 2-3 specifies the protocol type when you turn on the printer. Switch 2-3 normally is open and Data Terminal Ready is the data protocol.

Switch 2-3	Data Protocol Type
OPEN	Data Terminal Ready
Closed	XON/XOFF

Character Pitch

With the Apple Imagewriter you can print characters in eight different widths, from 9 per inch to 17 per inch. Two of these options print proportionally, with the width selected to suit each character (for instance, *m* wider than *l*). Here are the control codes for each of the eight options:

See Appendix F for further discussion of interface specifications.

If you would like to see how type looks in these different pitches, refer to Appendix D, Character Specifications.

Any of these character pitches can be printed in boldface or headline style.

Code	Decimal		Hex		Effect
ESCAPE n	27	110	\$1B	\$6E	Extended (9 characters per inch)
ESCAPE N	27	78	\$1B	\$4E	Pica (10 characters per inch)
ESCAPE E	27	69	\$1B	\$45	Elite (12 characters per inch)
ESCAPE p	27	112	\$1B	\$70	Pica proportional (144 dots per inch)
ESCAPE P	27	80	\$1B	\$50	Elite proportional (160 dots per inch)
ESCAPE e	27	101	\$1B	\$65	Semicondensed (13.4 characters per inch)
ESCAPE q	27	113	\$1B	\$71	Condensed (15 characters per inch)
ESCAPE Q	27	81	\$1B	\$51	Ultracondensed (17 characters per inch)

Each character pitch establishes a different rate of horizontal dot spacing, as shown below:

Pitch	Approximate Dots per Inch	Approximate Dots per 8" Line
Extended (9 characters per inch)	72	576
Pica (10 characters per inch)	80	640
Elite (12 characters per inch)	96	768
Pica proportional	144	1152
Elite proportional	160	1280
Semicondensed (13.4 characters per inch)	107	856
Condensed (15 characters per inch)	120	960
Ultracondensed (17 characters per inch)	136	1088

The settings of DIP switches SW 1-6 and SW 1-7 specify the character pitch in effect when you turn on the printer. Switch SW 1-6 normally is closed, and switch SW 1-7 open, so that the character pitch selected is elite. Recall that control codes override DIP switch settings.

Switch 1-6	Switch 1-7	Character Pitch
Open	Open	Pica
CLOSED	OPEN	Elite
Open	Closed	Ultracondensed
Closed	Closed	Elite proportional

Proportional Character Spacing

When your Apple Imagewriter is printing in a proportional pitch (selected by the ESCAPE P or ESCAPE p control codes), you can also specify how much space will be left between characters. One dot-width between characters is standard. With the following ESCAPE codes you can set spacing between characters from zero to nine dots in both proportional pitches. In elite proportional, you can add one to six dots of space between selected characters.

Note: Before using the following ESCAPE codes, refer to Appendix G for firmware modifications applicable to your Apple Imagewriter.

Code	Decimal	Hex	Effect
ESCAPE s n	27 115 n	\$1B \$73 \$n	Sets spacing between all characters in proportional modes (n = 0 to 9)
ESCAPE n	27 n	\$1B \$n	Adds n dots of space between selected characters (n = 1 to 6) Available in elite proportional only

Remember: These control codes work only in proportional character pitches (elite proportional and pica proportional). If you wish to use them with any other character pitch, you'll have to precede each character-spacing control code with an ESCAPE P code and follow it with the appropriate control code to return to the pitch you are using.

Character-spacing control codes are used primarily in programs that print justified text (text with both left and right margins straight, like text in a newspaper) by distributing the extra space in each line among the text characters.

Character Repetition

You can send a single control code to the Apple Imagewriter that will cause it to print the same character up to 999 times. The control code is six characters long:

Code	Decimal	Hex	Effect
ESCAPE R nnn c	27 82 nnn c	\$1B \$52 nnn c	Prints nnn repetitions of character c

For example, the following control code will cause 24 asterisks to be printed one after another:

ESCAPE R024*

The number nnn in this control code must always be three digits long; however, *leading zeros* may be replaced by spaces.

Slashed and Unslashed Zeros

Some people prefer to print the numeral zero with a slash through it (0) to distinguish it from the capital letter O. The Apple Imagewriter can print zeros either way, but normally prints them unslashed.

You can use the following control codes to change the way that zeros are printed:

Code	Decimal	Hex	Effect
ESCAPE Z	27 90	\$1B \$5A	Prints unslashed zeros
CONTROL-A CONTROL-@	1 0	\$01 \$00	
ESCAPE D	27 68	\$1B \$44	Prints slashed zeros
CONTROL-A CONTROL-@	1 0	\$01 \$00	

Foreign Characters

Your Apple Imagewriter has seven different language fonts to aid in printing text in German, French, Italian, Swedish, Spanish, and British English, as well as American English. You can choose any one of these character groups to substitute for these ten American symbols:

@ [\] ' { | } ~

The table below illustrates the characters in each foreign language font.

Table 4-2. Alternate Language Characters

Language	Alternate Characters									
American	#	@	[\]	'	{		}	~
British	£	£	©	£	£	£	£	£	£	£
German	#	£	§	£	£	£	£	£	£	£
French	£	£	£	£	£	£	£	£	£	£
Swedish	#	£	£	£	£	£	£	£	£	£
Italian	£	£	£	£	£	£	£	£	£	£
Spanish	£	£	£	£	£	£	£	£	£	£

In this table, the top line shows the American characters. The other lines give the alternate character groups that can be substituted for these characters by using the appropriate control codes. DIP switches SW 1-1, SW 1-2, and SW 1-3 specify the standard character group. The table below shows what control codes and combinations of positions of the three DIP switches provide the alternate character groups available. Note that there are two different sets of DIP switch settings and two different control codes that produce American symbols; you can use either one as the effects of both are the same.

Language Font	Code	DIP Switches		
		1-1	1-2	1-3
American	ESC Z CNTRL-G CNTRL-@	OPEN	OPEN	OPEN
British	ESC Z CNTRL-D CNTRL-@ ESC D CNTRL-C CNTRL-@	Closed	Closed	Open
German	ESC Z CNTRL-C CNTRL-@ ESC D CNTRL-D CNTRL-@	Open	Open	Closed
French	ESC Z CNTRL-A CNTRL-@ ESC D CNTRL-F CNTRL-@	Open	Closed	Closed
Swedish	ESC Z CNTRL-B CNTRL-@ ESC D CNTRL-E CNTRL-@	Closed	Open	Closed
Italian	ESC Z CNTRL-F CNTRL-@ ESC D CNTRL-A CNTRL-@	Closed	Open	Open
Spanish	ESC D CNTRL-G CNTRL-@	Closed	Closed	Closed
American	ESC Z CNTRL-E CNTRL-@ ESC D CNTRL-B CNTRL-@	Open	Closed	Open

You should set DIP switches SW 1-1, SW 1-2, and SW 1-3 to the character group you will normally use; this will cause that group to be chosen every time you turn on your Apple Imagewriter. When you wish to switch to another group while printing text, you can use the control codes to do so. For example, the following sequence will print a British pound sign even though your American character group has been selected by DIP switch settings:

```
ESC Z CNTRL-D CNTRL-@ ESC D CNTRL-C CNTRL-@ # ESC Z CNTRL-G CNTRL-@
```

You can choose only one complete alternate group at a time—only one line from the previous table. Once you have chosen an alternate group, the ten special symbols will always print the alternate characters of that group until you choose a different font.

Backspacing

You can print any two characters on top of one another by sending the printer a backspace control code between them:

Code	Decimal	Hex	Effect
CONTROL-H c	8 c	\$08 c	Backspaces one character and prints the character c

This is handy for printing certain symbols, such as the plus-or-minus sign or the cents sign (c with a vertical bar through it). You

Switches from American to British
Prints British pound sign
Switches back from British to American
If you would like to see exactly how the foreign language characters are printed in both fixed-width and proportional fonts, refer to Appendix D, Character Specifications.

can use only one CONTROL-H at a time. If you wish to backspace repeatedly (for example, to print a line with slashes through every character) you must follow each character with CONTROL-H plus the overprinted symbol.

By the Way: Many *editor* programs have their own responses to CONTROL-H, which may prevent you from entering it directly into a text file. For more information on entering such “illegal” commands, see your *Apple Imagewriter User’s Manual, Part II*.

Underlining

The Apple Imagewriter recognizes a pair of control codes to start and end underlining:

Code	Decimal	Hex	Effect
ESCAPE X	27 88	\$1B \$58	Starts underlining text
ESCAPE Y	27 89	\$1B \$59	Stops underlining text

Your printer underlines characters by printing the bottom dot in the type head. Thus underlining does not require double striking of characters, nor does it affect printing speed. When an ESCAPE X control code is in force, all text is underlined, including spaces and punctuation. You can underline with boldface printing (see below), and with all character pitches, including headlines (see *Headline Type*).

Boldface Printing

The Apple Imagewriter creates boldface characters by printing the character twice with a small shift of position. There are two control codes for this function, one to start boldface printing and the other to end it.

Code	Decimal	Hex	Effect
ESCAPE !	27 33	\$1B \$21	Starts boldface printing
ESCAPE “	27 34	\$1B \$22	Ends boldface printing

Boldface printing will darken all characters in all character pitches, including headlines. If you use it with underlining, it will increase the darkness of the underline as well as of the character. The printer runs at a slower speed during boldface printing.

Headline Type

Your printer can print double-width boldface characters, which make excellent headlines. To start or end double-width printing, use the following control codes:

Code	Decimal	Hex	Effect
CONTROL-N	14	\$0E	Begins headline mode
CONTROL-O	15	\$0F	Returns to normal mode

You can print headlines in conjunction with all of the character pitch options listed previously; the dot spacing remains the same, but you get half as many characters per inch. Thus you can select from eight giant typefaces, ranging from 4.5 characters per inch (extended) to 8.5 characters per inch (ultracondensed).

Direction of Type Head Motion

You can print lines either solely from left to right (like a typewriter), or back and forth. Since printing in both directions is slightly faster, you will usually want to use bidirectional printing. When printing certain patterns with graphics control codes, however, you may prefer one-direction printing because it improves the quality. You will also want to use one-direction printing for reports containing columns, when close alignment of the columns is important.

To control the printing direction, use the following control codes:

Code	Decimal	Hex	Effect
ESCAPE >	27 62	\$1B \$3E	Left-to-right printing only
ESCAPE <	27 60	\$1B \$3C	Bidirectional printing

Each of these control codes remains in force until canceled by the other.

Line Feed Function

In the standard mode any line feed causes the printer to execute a carriage return, and then print the next line of characters starting at the left margin:

_____ (LF)

If you enable the optional line feed function, a line feed does not cause the printer to execute a carriage return; the next line of type starts directly below where the previous line left off:

_____ (LF)

The codes for enabling and disabling the line feed function are as follows:

Note: Before using the line feed function control codes, refer to Appendix G for firmware modifications applicable to your Apple Imagewriter.

Code	Decimal	Hex	Effect
ESCAPE I 1	27 108 49	\$1B \$6C \$31	Enables optional line feed function
ESCAPE I 0	27 108 48	\$1B \$6C \$30	Disables optional line feed function

Automatic Line Feed

Many standard programs that create text files automatically add a line feed after every carriage return that they send. Others offer this feature as an option.

If the program that prepares text for your printer sends only a carriage return character to start a new line, you can cause the printer to add the line feed by itself. If SW 1-8 is closed, a line feed will be added after every carriage return. If SW 1-8 is open, no line feed will be added.

If the program already adds a line feed, you can add an automatic line feed to produce double-spaced printing.

You can also use the following control codes to control automatic line feeds:

Code	Decimal	Hex	Effect
ESCAPE D {@} CONTROL-@	27 68 128 0	\$1B \$44 \$80 \$00	Adds automatic line feed
ESCAPE Z {@} CONTROL-@	27 90 128 0	\$1B \$5A \$80 \$00	No line feed added

Note: The {@} in these two codes stands for a *high ASCII* CONTROL-@ (decimal 128, hex \$80). DIP SW1-5 must be open in order for it to be recognized as a high ASCII character (see Data Byte Length, in Chapter 5).

Line Feed Pitch

When the printer is turned on, it selects by default a vertical line spacing of six lines to the inch. At any time you can change this to eight lines per inch with a single control code:

Code	Decimal	Hex	Effect
ESCAPE A	27 65	\$1B \$41	6 lines per inch
ESCAPE B	27 66	\$1B \$42	8 lines per inch

In addition to these two pitches, you can select any line spacing, in increments of 1/144 of an inch, from 1/144 up to 99/144 of an inch:

Code	Decimal	Hex	Effect
ESCAPE T nn	27 84 nn	\$1B \$54 nn	Distance between lines to be nn/144 inch (nn = 01 to 99)

These three codes affect subsequent end-of-line actions; they do not affect the placement of the line in which they are included. They remain in effect until you set a new line feed pitch, or until you turn the power off.

The vertical distance between dots is approximately 1/72 of an inch, so this control code permits line feeding to be as little as one-half of a dot dimension. Although the control code ESCAPE T00 is ignored, the control code ESCAPE T01 can be used to feed the paper an imperceptible amount. This is handy if you want to overprint one line of text with another.

The control code ESCAPE T18 establishes a line feed pitch of eight to the inch (144 divided by 18 is 8), and ESCAPE T24, one of six to the inch (144 divided by 24 is 6). If you wish to print graphics, change the control code to ESCAPE T16, which enables you to place one vertical line of dots directly beneath another and thereby draw a continuous vertical line.

By the Way: If you change the line feed pitch, it will change the number of inches of paper fed by each press of the FORM FEED button. Thus you must also adjust the number of lines per page (see Page Length, below) if you still want form feed to advance the paper to the top of the next page.

Line Feed Direction

Paper can feed backward or forward through the printer, in response to these control codes:

Code	Decimal	Hex	Effect
ESCAPE f	27 102	\$1B \$66	Forward (normal) line feeding
ESCAPE r	27 114	\$1B \$72	Reverse line feeding

The printer will continue to feed in the direction last selected until it receives the opposite control code. Every time you turn the power on, forward line feeding is automatically selected.

Multiple Line Feeding

You can issue a single control code to make your Apple Imagewriter feed as many as 15 blank lines at once. This control code will work in both forward and reverse line feed directions, and with any line feed pitch:

Code	Decimal	Hex	Effect
CONTROL-__ n	31 n	31 n	Feeds n lines of blank paper (n = 1,2,3,4,5,6,7,8,9,:[10],[11], <[12],[13],>[14],[15])

Note that CONTROL-__ is CONTROL-underline, and that for 10 to 15 lines, you use symbols rather than numbers for n in the control code.

Left Margin Setting

When you turn the power on, your Apple Imagewriter starts each line of print as far left as the type head can travel. This is called position 0 (not 1), and corresponds physically to the red ring engraved at the left end of the roller shaft. However, you can change the left print margin at any time by sending the printer this five-character control code:

Code	Decimal	Hex	Effect
ESCAPE L nnn	27 56 nnn	\$1B \$4C nnn	Sets left margin to position nnn

For example, the following control code advances the left margin to the 36th character position:

ESCAPE L035

Similarly, the control code ESCAPE L000 moves the left margin back to the far left end. The left margin remains at the selected setting until another ESCAPE L control code is sent to the printer, or until the power is turned off.

Although the number nnn must always contain three digits, you can replace leading zeros with spaces if desired.

Note that the position of the margin, which is measured by counting characters, depends on the character pitch in force at the time the margin control code is sent. If you subsequently change the character pitch, the margin will not move to accommodate the change.

By the Way: If elite proportional pitch is in force, the margin will be measured at 10 character positions to the inch; with pica proportional it will be measured at 9 to the inch.

Page Length

The FORM FEED button in the Apple Imagewriter control cluster advances the paper to the top of the next page. The distance advanced can be either 66 or 72 lines. If SW 1-4 is open, there are 66 lines per page. If SW 1-4 is closed, there are 72 lines per page.

Note that the distance the paper advances is based on the number of printed lines; if you change the line feed pitch, the page length changes accordingly. Thus, a page of 66 lines turns out to be 11 inches long only if the line feed pitch is set to 6 lines per inch.

You can decrease the number of lines per page, set by DIP switch SW 1-4, by sending the printer a vertical tabbing control code. This is explained under Vertical Tabbing in Chapter 5.

Form Feeding

You can send a control code to your Apple Imagewriter that has the same effect as pressing the FORM FEED button in the control cluster:

Code	Decimal	Hex	Effect
CONTROL-L	12	\$0C	Feeds paper to next top of form

If DIP switch SW 1-7 is closed, this code also signals an end-of-line, causing the printer to print all text in the buffer (see Chapter 5).

Top of Form Set Command

You can electronically set the top of form (TOF) at any point on the page by sending the following control code:

Note: Before using the TOF set control code, refer to Appendix G for firmware modifications applicable to your Apple Imagewriter.

Code	Decimal	Hex	Effect
ESCAPE v	27 118	\$1B \$76	Sets TOF to current position

Paper Error Detector

The paper error detector monitors the amount of paper remaining in the printer. When less than one inch remains, the PAPER ERROR light lights, and the printer is deselected. You can use these control codes to nullify the paper error detector if you wish:

Code	Decimal	Hex	Effect
ESCAPE O	27 79	\$1B \$4F	Paper error detector off
ESCAPE o	27 111	\$1B \$6F	Paper error detector on

Restoring Standard Instructions

You can restore the printer to its standard instructions at any time, by using the ESCAPE c control code:

Code	Decimal	Hex	Effect
ESCAPE c	27 99	\$1B \$63	Restores standard instructions (Software Reset)

When you issue an ESCAPE c control code, the printer prints all data entered prior to the ESCAPE c, restores all operating instructions (except for vertical tab settings) to the power-on state specified by the DIP switches and microprocessor, and is left selected.

Now you know how to control many of the basic functions of your Apple Imagewriter. In the next chapter you will learn how to perform more advanced operations.

Advanced Control Codes

55	The Input Buffer
55	End-of-Line Character
55	Canceling Text
56	Buffer Overflow Action
56	Data Byte Length
57	Horizontal Tabbing
57	Setting a Tab Line
58	Adding a Selected Tab
59	Using Horizontal Tabs
59	Clearing Horizontal Tabs
59	Vertical Tabbing
60	Setting Vertical Tabs
62	Using Vertical Tabs
64	Setting Page Length
64	Vertical Tab Reset and Default
65	Custom Characters
65	Creating Custom Characters
66	Loading Custom Characters
68	Printing Custom Characters
69	A Sample Custom Character
70	Printing Graphics
71	Column-Oriented Graphics
72	Dot Spacing
73	A Graphics Example
74	Line-Oriented Graphics
74	Exact Dot Placement
75	Creating a Format File

THE UNIVERSITY OF CHICAGO

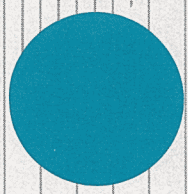
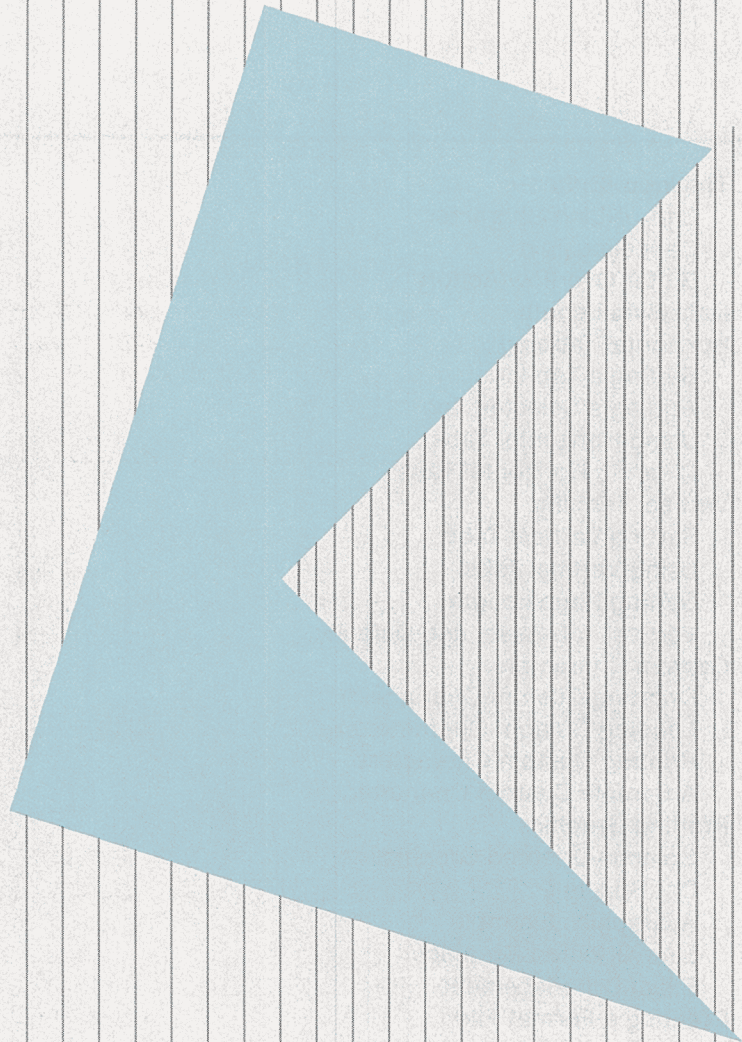

Advanced Control Codes

Once you have become familiar with the control codes described in the preceding chapter, read this chapter to learn how to use even more sophisticated control codes.

The Input Buffer

The text sent to your printer is stored in a *buffer* and isn't printed until the buffer is full, or until the printer receives an *end-of-line character*. The buffer can accept a maximum of about 3000 characters.

End-of-Line Character

The end-of-line character is normally a carriage return (CR). However, if you like, you can specify that carriage return, line feed (LF), vertical tab (VT), and form feed (FF) all be recognized as end-of-line characters. Use the following control codes to change the end-of-line character:

Code	Decimal	Hex	Effect
ESCAPE Z@ CONTROL-@	27 90 64 0	\$1B \$5A \$40 \$00	CR only
ESCAPE D@ CONTROL-@	27 68 64 0	\$1B \$44 \$40 \$00	CR, LF, VT, FF

Canceling Text

If you have text in the printer's input buffer—in other words, text that has been sent to your Apple Imagewriter but not yet printed—you can erase it from the buffer with the following control code:

Code	Decimal	Hex	Effect
CONTROL-X	24	\$18	Cancels all unprinted text

CONTROL-X does not cancel control codes; it cancels only ordinary text.

Buffer Overflow Action

When the buffer becomes full, it automatically prints its contents. At this time the printer may or may not feed a line of paper. Normally the printer does feed a line of paper when the buffer is full, but you can use the following control codes to change the buffer overflow action:

Code	Decimal	Hex	Effect
ESCAPE Z_ CONTROL-@	27 90 32 0	\$1B \$5A \$20 \$00	No line feed added
ESCAPE D_ CONTROL-@	27 68 32 0	\$1B \$44 \$20 \$00	Line feed added

Note: The underline (__) in ESCAPE Z__ above is used to indicate a space character (ASCII character 32).

Data Byte Length

Your Apple computer sends text to the printer in eight-bit data bytes. Normal ASCII characters use only the lower seven bits, so usually the highest value bit is ignored. Thus, it usually does not matter whether or not your Apple Imagewriter processes the eighth (highest value) bit of data it receives.

However, certain control codes require characters in which the eighth bit is set. For this reason, a control code is provided to allow you to choose whether or not to recognize the eighth bit. If SW 1-5 is open, the eighth bit is recognized. If SW 1-5 is closed, the eighth bit is ignored.

For most uses of your Apple Imagewriter, SW 1-5 should be kept closed, so that the printer will accept text even when the eighth bit is set. However, if you create graphics or custom characters to be printed by your Apple Imagewriter, you may need to open SW 1-5, as explained in *Creating Custom Characters*.

You can also use the following control codes to change the data byte length:

Code	Decimal	Hex	Effect
ESCAPE D CONTROL-@ 2	27 68 00 50	\$1B \$44 \$00 \$32	Ignores eighth bit
ESCAPE Z CONTROL-@ 2	27 90 00 50	\$1B \$5A \$00 \$32	Recognizes eighth bit

Horizontal Tabbing

You can set up to 32 horizontal tab positions for your Apple Imagewriter. Each tab character (TAB or CONTROL-I) sent to the printer advances the type head to the next tab position. The printer ignores tab characters if no tab positions have been set or if the type head is at or beyond the last tab position. Control codes can be used to clear tab positions individually or all at once. Turning off the printer also clears all tab positions.

Here are the codes you use:

Note: Before using ESCAPE u, refer to Appendix G for firmware modifications applicable to your Apple Imagewriter.

Code	Decimal	Hex	Effect
ESCAPE (a,b,—n.	27 40 a,b,—n.	\$1B \$28 a,b,—n.	Sets horizontal tab line (a,b,etc. = three-digit numerals)
ESCAPE u	27 117	\$1B \$75	Sets selected tab
CONTROL-I	9	\$09	Moves type head to next tab
ESCAPE) a,b,—n.	27 41 a,b,—n.	\$1B \$29 a,b,—n.	Clears selected tabs (a,b,etc. = three-digit numerals)
ESCAPE Ø	27 48	\$1B \$30	Clears all tabs

Setting a Tab Line

To set a line of horizontal tab positions, you send an ESCAPE character, a left parenthesis, and a sequence of three-digit ASCII numerals (normal keyboard characters). You send the numerals to the printer in ascending numerical order, separate them by

commas, and end them with a period. The numbers specify the character positions, starting from the left margin, where tabs will be set. The left margin is position 1. For example,

```
ESCAPE(005,023,067.
```

sets tabs at character positions 5, 23, and 67. You can replace leading zeros with spaces.

The character pitch determines the maximum horizontal tab setting:

Character Pitch	Maximum Horizontal Tab Setting
Extended	72
Pica	80
Elite	96
Pica proportional	72
Elite proportional	80
Semicondensed	107
Condensed	120
Ultracondensed	136

Tab positions are based on the character pitch in force at the time you enter the horizontal tab line. If you later change the character pitch, the tabs will remain in the same absolute locations and will no longer correspond to actual character positions. If tabs are set while proportional pitch is in force, they will be based on a pitch of 10 characters per inch.

You specify tab positions relative to the current position of the left margin. If you change the left margin after setting the tabs, the tab positions will not change to correspond to the new margin.

Remember: When you combine margin settings with tab settings, the margin positions start with 0, while the tab positions start with 1. Thus, for example, a margin setting of 5 will start each line at the same place as a tab setting of 6.

Adding a Selected Tab

In addition to the original tab setup you can add a selected tab by sending a control code. Only one tab can be added at a time. The original tab settings are maintained and the new one added.

Note: Before using the Selected Tab command, refer to Appendix G for firmware modifications applicable to your Apple Imagewriter.

Code	Decimal	Hex	Effect
ESCAPE u	27 117	\$1B \$75	Sets horizontal tab in addition to those already set (only one additional tab can be set at a time)

Using Horizontal Tabs

To move the type head to the next tab position, send a CONTROL-I. This character is sometimes called the ASCII HT command. A string of several CONTROL-I characters will cause the type head to jump over tabs to the position desired, as with a typewriter.

Many text editor programs have their own horizontal tabbing facilities, which use a TAB character or CONTROL-I. If you are using one of these programs, you will not be able to enter CONTROL-I directly into your file. See your *Apple Imagewriter User's Manual, Part II* for further information on entering such "illegal" characters.

Clearing Horizontal Tabs

Although you must initially set horizontal tabs one entire line at a time, you can clear them individually. The clearing command is identical to the setting command, except that a right parenthesis, instead of a left parenthesis, follows the ESCAPE character. An ESCAPE character followed by a zero clears all tabs. If you attempt to clear a tab that is not set, you won't affect the rest of the command; but bad syntax will cause the whole command to be ignored.

Vertical Tabbing

The Apple Imagewriter's microprocessor contains a memory called an *Electronic Vertical Form Unit* (or EVFU) that keeps track of up to 96 vertical tab positions on a page. To set vertical tabs, you send the printer control codes that specify the top and bottom of the page, and control codes that specify whether to set tab stops or not for each line in between. You can set tabs on each line for up to five different pages.

After you set the vertical tabs, you refer to the tab positions by sending vertical tab control codes to the printer. As usual, a form feed control code causes an advance to the next top of form. This powerful facility allows you to create up to five separate vertical tabbing patterns simultaneously, thus permitting up to five separate forms to be run without your having to reset the tabs for each form.

Setting Vertical Tabs

To set a structure of vertical tabs, send a top of form (TOF) control code, control codes for vertical tab positions, a bottom of form (BOF) control code, and a control code for the next TOF. The distance between the two TOF settings corresponds to the page length. The TOF is not necessarily the physical top of the paper. The following table shows the three control codes for setting the TOF and BOF:

Code	Decimal	Hexadecimal	Effect
CONTROL-] A@	29 65 64	\$1D \$41 \$40	Sets top of form (TOF)
C@	67 64	\$43 \$40	Sets bottom of form (BOF)
A@ CONTROL-	65 64 30	\$41 \$40 \$1E	Sets TOF—next form

Between the first two control codes, you enter up to 95 two-character codes to specify either a tab stop or no stop for each line between the TOF and BOF. Tab stops for the first page are labeled B, for the second C, for the third D, for the fourth E, and for the fifth F. Any line can have tab stops for any combination of the five pages. The following table lists all the possible codes:

Code	Decimal	Hex	Effect
@@	64 64	\$40 \$40	Sets no tabs
B@	66 64	\$42 \$40	Sets tab B
D@	68 64	\$44 \$40	Sets tab C
H@	72 64	\$48 \$40	Sets tab D
P@	80 64	\$50 \$40	Sets tab E
'@	96 64	\$60 \$40	Sets tab F
F@	70 64	\$46 \$40	Sets tabs B, C
J@	74 64	\$4A \$40	Sets tabs B, D
R@	82 64	\$52 \$40	Sets tabs B, E

Code	Decimal	Hex	Effect
b@	98 64	\$62 \$40	Sets tabs B, F
L@	76 64	\$4C \$40	Sets tabs C, D
T@	84 64	\$54 \$40	Sets tabs C, E
d@	100 64	\$64 \$40	Sets tabs C, F
X@	88 64	\$58 \$40	Sets tabs D, E
h@	104 64	\$68 \$40	Sets tabs D, F
p@	112 64	\$70 \$40	Sets tabs E, F
N@	78 64	\$4E \$40	Sets tabs B, C, D
V@	86 64	\$56 \$40	Sets tabs B, C, E
f@	102 64	\$66 \$40	Sets tabs B, C, F
Z@	90 64	\$5A \$40	Sets tabs B, D, E
j@	106 64	\$6A \$40	Sets tabs B, D, F
r@	114 64	\$72 \$40	Sets tabs B, E, F
\@	92 64	\$5C \$40	Sets tabs C, D, E
l@	108 64	\$6C \$40	Sets tabs C, D, F
t@	116 64	\$74 \$40	Sets tabs C, E, F
x@	120 64	\$78 \$40	Sets tabs D, E, F
^	94 64	\$5E \$40	Sets tabs B, C, D, E
n@	110 64	\$6E \$40	Sets tabs B, C, D, F
v@	118 64	\$76 \$40	Sets tabs B, C, E, F
z@	122 64	\$7A \$40	Sets tabs B, D, E, F
@	124 64	\$7C \$40	Sets tabs C, D, E, F
~@	126 64	\$7E \$40	Sets tabs B, C, D, E, F

Between the BOF control code and the TOF control code for the next page, you must enter enough two-character “no tab” codes (@@) to fill out the remaining page length. For example, suppose you are printing a 36-line form on fanfold paper with pages 66 lines

long. You send control codes to form a vertical tab structure such as the following:

```

Line 1: Starting TOF code
Line 2: }
_____ }      34 tab-setting or "no tab" codes
Line 35: }
Line 36: BOF code
Line 37: }
_____ }      30 "no tab" codes
Line 66: }
Line 67: Next TOF code

```

You send the 136 characters required to create this structure to the printer in an uninterrupted stream, without spaces or carriage returns (although you can end the whole sequence with a carriage return). For this reason, setting them up in a format file (see *Creating a Format File*) or generating them by executing a program is safer than trying to enter them directly from the keyboard.

Using Vertical Tabs

Once you have sent a vertical tab structure to your Apple Imagewriter, you can use it as long as you don't turn the power off. To use the tab positions you have set, send the following control codes to the printer:

Code	Decimal	Hex	Effect
CONTROL-__ B	1 66	\$1F \$42	Drops to next line with tab B
CONTROL-__ C	31 67	\$1F \$43	Drops to next line with tab C
CONTROL-__ D	31 68	\$1F \$44	Drops to next line with tab D
CONTROL-__ E	31 69	\$1F \$45	Drops to next line with tab E
CONTROL-__ F	31 70	\$1F \$46	Drops to next line with tab F
CONTROL-__ A	31 65	\$1F \$41	Drops to next BOF or TOF
CONTROL-L	12	\$0C	Drops to next TOF

Note that CONTROL-__ is CONTROL-underline.

Here is an example that illustrates the use of vertical tabs. Suppose you have a form 12 lines long with 10 lines of text. Let's say you wish to set the following tabs:

Line 1: TOF
Line 2: No tabs
Line 3: Tab B
Line 4: Tab C
Line 5: No tabs
Line 6: Tabs B and D
Line 7: Tabs C and D
Line 8: No tabs
Line 9: Tab E
Line 10: BOF
Line 11:
Line 12:
Line 13: TOF, next form

To send these vertical tab positions to your Apple Imagewriter, you use the following control codes:

```
CONTROL-J A@ @@ B@ D@ @@ J@ L@ @@ P@ C@ @@ @@ A@ CONTROL-
```

(The spaces in the previous line have been inserted for clarity; you shouldn't put spaces in the actual control code.)

Then, if you send a CONTROL-__ followed by a tab letter, the paper advances to the next line for which that tab has been set. From line 1, for instance, the control code CONTROL-__ C causes an advance to line 4; two CONTROL-__ B control codes in succession cause an advance to line 6; and so on. A CONTROL-__ A control code advances paper to the next BOF or TOF, whichever comes first. A CONTROL-L advances paper to the next form feed.

By the Way: If you reverse the line feed direction (see Chapter 4, Controlling Your Printer) the vertical tab structure will still function, but it will be inverted with respect to the paper. For instance, a tab B on the first line will be the second tab position from the right on the last line.

When using vertical tabbing control codes, you will find it helpful to remember these tips.

Vertical tabbing works by counting lines. This means that the distance in inches between tab positions depends on the line feed pitch. If you change the pitch after the tabs have been set, the whole format expands or contracts accordingly. Since you can select any pitch from 1/144 to 99/144 of an inch in increments of 1/144 of an inch, you can tailor your printing to virtually any

physical page format. If necessary, you can change line feed pitches within a form to place the printing exactly where you want it.

The maximum number of lines for which you can store vertical tab information is either 66 or 72, depending on the setting of DIP switch 1-4. If you attempt to set more lines than this, the extra commands will be ignored.

Be careful how you set the TOF and BOF. If you don't set them correctly, your vertical tabs will not work.

An illegal tab command (such as an attempt to go to a tab not present in the rest of the structure) advances the paper to the BOF line. You cannot go from a tab position within one form to a tab position within the next; you must go to the next TOF first.

Setting Page Length

Even if you do not use the vertical tab commands, you may wish to use the vertical tab control codes to set the maximum length of each printed page (maximum length = 96 lines). Text fills the page until it reaches the line identified as the BOF. After the BOF line is completed, the printer advances paper to the next TOF line before printing any more.

For example, suppose you wish to print out a file of continuous text in the form of 60-line pages printed on fanfold paper that is 66 lines long. You enter the following vertical tab control codes:

```
CONTROL-J A@ <58 @@ codes> C@ <6 @@ codes> A@ CONTROL-
```

(The spaces in the previous line have been inserted for clarity; you shouldn't put spaces in the actual control code.)

As you load paper into the printer, set the top of the page to three lines below the perforations between pages. Your text will be printed in 60-line blocks, each block centered vertically on the 66-line page.

Vertical Tab Reset and Default

When you turn your Apple Imagewriter on, the print length (TOF to BOF) and page length (TOF to TOF) are both either 66 or 72 lines,

depending on the setting of DIP switch SW 1-4. Each page contains a B tab every six lines, and no others.

Note: Before using the electronic reset, refer to Appendix G for firmware modifications applicable to your Apple Imagewriter.

The default condition can also be electronically reset by sending the following control characters. These characters set the vertical tabs to power-on status and reset TOF to the current position on the page.

Code	Decimal	Hex	Effect
GS O	29 48	\$1D \$30	Sets vertical tabbing to power-on status, and sets TOF to current position

Custom Characters

Tired of using ordinary letters and numbers? The Apple Imagewriter lets you design your own alphabet! It contains a special memory that is capable of holding up to 175 custom-designed characters. Control codes allow you to switch the entire Apple character set from normal characters to new ones you have designed, and back again. You can easily mix custom symbols with ordinary text. Your custom-designed characters act just like the others: they expand and contract with changes in character pitch; you can underline them, print them in boldface, and expand them into headlines.

To use this capability, you need to understand how to create new characters, how to load them into your Apple Imagewriter's memory, and how to fetch them from memory and print them. We will discuss each of these phases separately, and then illustrate them with a specific example.

Creating Custom Characters

As explained in Chapter 1, the dot-matrix type head contains a vertical array of nine dot-strikers (called wires), spaced 1/72 of an inch apart. Normal characters are printed by striking up to seven patterns in a row, with the eighth pattern left blank to separate the characters. The fixed-width alphabets (pica, extended, condensed, and so on) print all characters eight dots wide; the proportional alphabets vary the number of dots per character to fit the width of each letter or symbol. The difference between one character pitch

and another is not in the number of dots per character, but in their horizontal spacing. Thus an ultracondensed *A* is printed with the same dot pattern as a pica *A*, but with 136 dots to the horizontal inch instead of 80.

Custom characters are able to go beyond normal character limits, for they can be up to 16 dots wide. The width is defined for each individual character, and is either proportional or fixed. A custom character can be assigned to any keyboard position that normally prints something, including uppercase and lowercase characters.

The dot-striking wires in the type head are numbered from 1 at the top to 9 at the bottom. When designing a custom character you can use either the top eight wires (1 through 8) or the bottom eight wires (2 through 9). The normal alphabet uses wires 1 through 7 for capital letters and 3 through 7 for lowercase, with 8 and 9 being reserved for descenders, such as the tails on lowercase *y*, *g*, and *p*. Wire 9 is used for underlining as well. Thus the base line for normal printing is wire 7.

If you design each new custom character on square-ruled paper first, you can check its proportions and its vertical placement with respect to other characters. This also makes it easy to translate the dot pattern into a series of data bytes you send to your Apple Imagewriter. Each vertical column of dots translates into a binary number in which each bit set to 1 (for on) corresponds to a dot. The *least significant bit* (the last digit) of this number corresponds to the top of the character (wire 1 or 2, depending on whether the upper or lower eight wires are being used), and the *most significant bit* (the first digit) to the bottom. Specify spacing included with the character with one or more binary zero numbers (ASCII nulls). The example at the end of this section shows how to calculate these numbers when creating a new symbol.

Loading Custom Characters

As soon as you have designed a new custom character, you can load it into your Apple Imagewriter's memory. Following are the codes you use:

Code	Decimal	Hex	Effect
ESCAPE -	27 45	\$1B \$2D	Maximum width is 8 dots
ESCAPE +	27 43	\$1B \$2B	Maximum width is 16 dots
ESCAPE I	27 73	\$1B \$49	Starts loading new character(s)
CONTROL-D	4	\$04	Ends new character(s) loading
A.....P	65...80	\$41...\$50	Width code when using top 8 wires (A = 1 ... P = 16)
a.....p	97..112	\$61...\$70	Width code when using bottom 8 wires (a = 1 ... p = 16)

To load one or more new custom characters into memory, follow these steps:

1. Select a maximum width of 8 or 16 dots by sending the printer either ESCAPE - or ESCAPE +. If you choose a maximum width of 16 dots, the memory can hold fewer characters than if you choose a maximum width of 8. The maximum width selection remains until it is canceled by the other control code or until you turn off the power.
2. Send the printer an ESCAPE I to tell it you are starting a group of new character specifications.
3. For each new character, send the following information to the printer:
 - a. The regular character that is to be assigned a new symbol. This can be any uppercase or lowercase letter, any numeral, or any punctuation mark, including spaces. It may not be RETURN, ESCAPE, TAB, or any other nonprinting character. (If you select a maximum width of eight dots in step 1 above, you can also use 80 of the printing characters again with ASCII bit 8 set, for a total of 175 custom characters. See the explanation of the ESCAPE control code in Printing Custom Characters.)
 - b. A width code from the preceding table. If the new character is seven dots wide (including spacing) and you want it printed using wires 1 through 8, send G; if it is 13 dots wide and uses wires 2 through 9, send m; and so on.
 - c. As many eight-bit binary numbers (in the form of ASCII characters) as were specified by the width code just sent. Each binary number specifies a one-column dot pattern, from the left to the right. Bit 0 of each number corresponds to the top wire, and bit 7 corresponds to the bottom.

For a table of ASCII characters corresponding to binary numbers, see Appendix C.

4. After repeating step 3 for each custom character, send the printer a CONTROL-D character to signal that the loading sequence is complete.



Warning

Be careful when sending this sequence to the printer. If you get out of step by one character, the whole result can become garbled.

Printing Custom Characters

Once their specifications are stored in your Apple Imagewriter's memory, you can fetch and print custom characters at any time. The following codes switch the entire keyboard of printing characters from one font to another:

Code	Decimal	Hex	Effect
ESCAPE ' (grave)	27 39	\$1B \$27	Switches to custom character font
ESCAPE * (asterisk)	27 42	\$1B \$2A	Switches to custom character font (high ASCII values)
ESCAPE \$ (dollar)	27 36	\$1B \$24	Switches back to normal font

Whenever one of these control codes appears in text being printed, the printer changes fonts and continues to print with that font until it receives one of the other codes (or until you turn the power off, at which time it reverts to the normal font). Most of the time you will probably want to fetch a single custom symbol. To do this you send the printer ESCAPE ' (or ESCAPE *), the keyboard character to which the custom symbol was assigned, and ESCAPE \$.

ESCAPE ' (ESCAPE accent grave) and ESCAPE * (ESCAPE asterisk) have the following different characteristics:

- ESCAPE ' fetches custom characters in both 8-dot-maximum and 16-dot-maximum storage modes assigned to ordinary keyboard characters (including space)—ASCII characters with decimal values 32 through 126 (see Appendix C).
- ESCAPE ' also fetches custom characters assigned to ASCII characters with decimal values 160 through 191. These characters can't be more than eight dots wide and must have been stored in the eight-dot-maximum mode. When you use ESCAPE ' for this purpose, make sure that DIP switch SW 1-5 is open or an ESCAPE Z CONTROL-@ 2 control code is in force (see Data Byte Length earlier in this chapter).

- ESCAPE * fetches custom characters assigned to ASCII characters with decimal values 160 through 239. In effect, it reassigns them to characters 128 lower—in other words, ASCII 32 through 111 (all of the normal keyboard characters except the punctuation marks {, |, }, and , and lowercase letters above o). For this control code to be effective, make sure that DIP switch SW 1-5 is closed or an ESCAPE D CONTROL-@ 2 control code is in force (see Data Byte Length, earlier in this chapter).

Since the ESCAPE ' control code permits you to change to a font containing up to 95 custom characters of any width (regardless of the position of DIP switch SW 1-5) and fetch them with ordinary keyboard characters, you will probably never need to use the ESCAPE * control code. However, it is available if you ever need to store and use as many as 175 custom characters up to eight dots wide.

A Sample Custom Character

Suppose you are using your Apple Imagewriter to print technical specifications in which the plus-or-minus sign (\pm) is used extensively. You could print this symbol by printing plus-backspace-underline (+/_), but the result would look awkward. A better solution is to use a custom character.

The first step is to design the new symbol on square-ruled paper, numbering the columns. It should look like this:

Figure 5-1. Designing a Custom Character

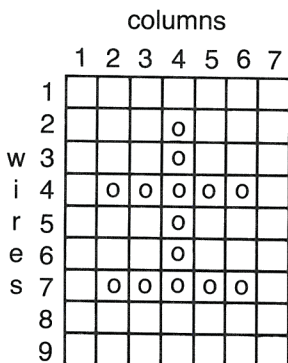

The next step is to translate the columns into binary numbers, and then into ASCII characters. The new symbol uses wires 1 through 8, so the least significant (or last) digit of each binary number corresponds to wire 1 and the most significant to wire 8. Looking at the layout on squared paper, it is easy to see that the first number consists entirely of zeros, the next has a 1 for the second and fifth digits (wires 7 and 4); and so on. By referring to Appendix C you can find out what ASCII characters correspond to these numbers. The following table shows the result:

Column	Binary	ASCII
1	00000000	NUL (CONTROL-@)
2	01001000	H
3	01001000	H
4	01111110	~
5	01001000	H
6	01001000	H
7	00000000	NUL (CONTROL-@)

Since the new symbol is only seven dots wide, you can enter it in the eight-dot maximum storage mode. Let's assume that you want to fetch it from the custom character font by using the & character. The resulting loading sequence is:

```
ESCAPE - ESCAPE I & G CONTROL-@ H H H H CONTROL-@ CONTROL-D
```

Of course the spaces shown above are omitted from the actual sequence sent to the printer. The character *G* is the width code. It indicates that the top eight wires print the symbol and that it is seven dots wide (*G* is the seventh letter of the alphabet).

After you load the new character by means of the sequence above, you can print the character at any time by sending to the printer this sequence:

```
ESCAPE ' & ESCAPE $
```

These five characters change the printer's type style to the custom font, print the symbol assigned to the & key, and change it back to the normal font.

By the Way: Whenever you turn the power off, the entire memory of custom characters is lost. It is therefore a good idea to put your loading sequences into a format file, which you can send to the printer every time you turn the power on. (See Creating a Format File.)

Printing Graphics

You can make your Apple Imagewriter print a completely black page, consisting of 23,040 dots per square inch. While this is probably not something you want to do, it illustrates the printer's capability to create any graphics pattern up to eight inches wide and any length.

There are three primary ways to create graphics patterns with the Apple Imagewriter:

- by printing a line of many different vertical dot patterns, each up to eight dots high
- by repeating a single vertical dot pattern all the way across a line
- by the exact placement of single dots or small groups of dots at one or more positions along a line

In all cases, printed graphics are produced one line at a time. Each line can be up to 8 dots high and 1,280 dots long.

Column-Oriented Graphics

The Apple Imagewriter can print horizontal lines with dots in any pattern you desire. Each vertical column of up to eight dots is defined by a separate ASCII character, so a single line may require up to 1,280 characters (bytes) for its definition. After it prints each line, the printer is ready to receive a new line.

Each control code defining one horizontal line of dot graphics starts with one of the following six-character prefixes:

Code	Decimal	Hex	Effect
ESCAPE G nnnn	27 71 nnnn	\$1B \$47 nnnn	Prints line corresponding to the following nnnn data bytes
ESCAPE S nnnn	27 83 nnnn	\$1B \$53 nnnn	Same as ESCAPE G
ESCAPE g nnn	27 103 nnn	\$1B \$67 nnn	Prints line corresponding to the following nnn x 8 data bytes

The decimal number nnnn after the ESCAPE G consists of four ordinary keyboard numerals; it specifies the number of data bytes (up to 9999) that follow. This six-character prefix plus the data bytes themselves constitute the complete control code, which may thus run up to 10,005 characters.

ESCAPE S and ESCAPE G are identical and may be used interchangeably.

The decimal number nnn after the ESCAPE g consists of three keyboard numerals; it specifies the number of data bytes divided by eight (up to 999) that follow. ESCAPE g operates somewhat faster than ESCAPE G and ESCAPE S, but otherwise is the same; for example, ESCAPE g 010 and ESCAPE G 0080 are equivalent.

Remember: In this and other control codes, you can replace leading zeros with spaces.

Each of the data bytes defines a vertical column of eight dots printed by the type head. A dot is printed for each bit set to 1 in the data byte. Bit 7 causes the dot at the bottom of the column to be printed and bit 0 causes the dot at the top to be printed. For

example, the data byte for ASCII character *k* (decimal 107, hex \$6B, binary 01101011) causes a column of dots to be printed, as shown in the following figure:

Figure 5-2. Effect of Data Byte for *k*

```
0 ●
1 ●
B 2
i 3 ●
t 4
s 5 ●
6 ●
7
```

The columns print from left to right, starting at the left margin of the page.

See your *Apple Imagewriter User's Manual, Part II* for information on how to send nonprinting characters.

Data bytes are frequently nonprinting characters. Most graphics patterns, however, are generated by programs written for the specific purpose, in which case the data bytes are specified by Pascal CHR or BASIC CHR\$ functions. (See A Graphics Example.)

Remember: CHR functions require base-10 numbers as arguments. If you design the bytes in binary or hexadecimal, you must convert to decimal before using CHR functions.

Dot Spacing

A table under Character Pitch in Chapter 4, *Controlling Your Printer*, shows the maximum number of dots per line for each of the eight character pitches.

The vertical spacing of the striker wires in the type head is approximately 1/72 of an inch. The horizontal character pitch that produces 72 dots per inch is extended, or nine characters per inch. So if you select a vertical line feed pitch of 16/144 of an inch, the result is a uniform matrix of dot positions—72 per inch in each direction, with a total density of 5,184 dots per square inch. The dot size is such that horizontal and vertical lines appear connected for this matrix. To produce nine characters per inch horizontally and a line feed pitch of 16/144 of an inch use

ESCAPE n ESCAPE T16

Although you can select finer-scale horizontal dot spacing, it takes longer to print.

A Graphics Example

Suppose you are using your Apple Imagewriter to print custom business forms in which you want to crosshatch certain areas. The following Pascal procedure, when included in the program that generates the form, does this. It takes three previously declared integer variables passed to it from the main program:

- LEFTEDGE: the character position of the left edge of the crosshatched block
- WIDTH: the width, in ninths of an inch, of the block
- HEIGHT: the height, in ninths of an inch, of the block

This procedure assumes that the printer has been opened with a REWRITE procedure and assigned the text file identifier PRINTER.

```
PROCEDURE HATCH;
VAR N, M : INTEGER;
BEGIN
  {Set left margin}
  WRITE (PRINTER, CHR(27), 'L', LEFTEDGE:3);
  {Set character and line pitch for 72 per inch}
  WRITE (PRINTER, CHR(27), 'n', CHR(27), 'T16');
  FOR N := 1 TO HEIGHT DO
    BEGIN
      {Set Graphics Mode and width}
      WRITE (PRINTER, CHR(27), 'G', (WIDTH DIV 8):4);
      FOR M := 1 TO WIDTH DO
        BEGIN
          {8 bytes to produce diamond pattern}
          WRITE (PRINTER, CHR(24), CHR(36), CHR(66), CHR(129));
          WRITE (PRINTER, CHR(129), CHR(66), CHR(36), CHR(24));
        END;
      {Type each line when complete}
      WRITELN (PRINTER);
    END;
  {Restore previous margin and (pica) character and line pitch}
  WRITE (PRINTER, CHR(27), 'L000', CHR(27), 'N', CHR(27), 'A')
END;
```

You can modify the last line to suit any other character and line pitch in use outside the procedure.

Line-Oriented Graphics

You can send control codes to your Apple Imagewriter that cause it to repeat a single vertical dot pattern up to 9999 times horizontally. The result is a set of horizontal lines whose thickness and spacing (within the 1/10-inch height of the type head) are determined by a binary number. The control code must use the following prefix:

Code	Decimal	Hex	Effect
ESCAPE V nnnn c	27 86 nnnn c	\$1B \$56 nnnn c	Types nnnn repetitions of the dot column specified by c

The character *c* is the ASCII equivalent of an eight-bit binary number specifying where dots appear in the column. Bit 0 is at the top of the column and bit 7 is at the bottom, with a 1 wherever a dot is to be printed.

This control code is useful for generating the horizontal rules used in tables and forms. The length of the rule is controlled precisely by the number nnnn of horizontal dots (for a table of the number of dots per inch printed by various character pitches, see Chapter 4, *Controlling Your Printer*). The number nnnn must always have four digits; however, you can replace leading zeros with spaces. For example, to produce three hairline rules, use the character *l*, because its digital ASCII representation is 01001001.

Here are some handy values for the specifying character *c*:

One hairline rule:	@
Two hairline rules:	H
Three hairline rules:	l
One heavy rule:	0
Two heavy rules:	f
One extra-heavy rule:	8

Exact Dot Placement

For a table of the number of dots per inch for each character pitch, see Chapter 4, *Controlling Your Printer*.

For the greatest flexibility and accuracy in creating graphics with your Apple Imagewriter, use the following dot placement control code:

Code	Decimal	Hex	Effect
ESCAPE F nnnn	27 70 nnnn	\$1B \$46 nnnn	Places succeeding printing nnnn dot positions from left margin

The number nnnn consists of four ASCII numerals, but you can replace leading zeros with spaces. The resulting placement depends on the character pitch you have in force at the time you send this control code.

By the Way: Dot positions are counted from the left margin as set by the ESCAPE L control code (see Chapter 4, Controlling Your Printer).

Follow each ESCAPE F control code with at least one printing control code. This may consist of an ordinary character (in which case that character is printed at the location specified), a dot column control code such as ESCAPE G or ESCAPE V, or another ESCAPE F control code. (See Line-Oriented Graphics to learn more about ESCAPE V and Column-Oriented Graphics to learn more about ESCAPE G.)

By the Way: In order for multiple ESCAPE F control codes to be executed correctly, send them to the printer in ascending numerical order (from left to right).

Creating a Format File

The printer's memory is lost every time the power is turned off. You can retain control codes for later use by setting up a format file. A format file contains control codes—outside of the memory—that prepare the printer for a specific job. You can send a format file to the Apple Imagewriter by itself, prior to running a job, or incorporate it in another text file to instruct the printer on how to format a particular section.

Many format files are quite short (only specifying character pitch, line feed pitch, and left margin setting, for example). Others that control the more sophisticated functions of the Apple Imagewriter—form tabulating commands, custom character specifications, and dot-by-dot graphics—may be very long.

Here is an example of a format file to set the character pitch at pica, the type head direction at bidirectional, the line feed pitch at six lines per inch, line feeding at forward, horizontal tab marks every five spaces (5-50), the left margin at the 11th character position, and the TOF at the current position:

```
ESC N ESC < ESC A ESC f ESC (005,010,015,020,025,030,035,040,045,050  
ESC L 010 ESC v
```

Appendixes

-
- 79** A Troubleshooting
 - 81** B Command Summary
 - 87** C ASCII, Binary, and Hexadecimal Codes
 - 91** D Character Specifications
 - 101** E Printer Specifications
 - 103** F Interface Specifications
 - 107** G Firmware Modifications

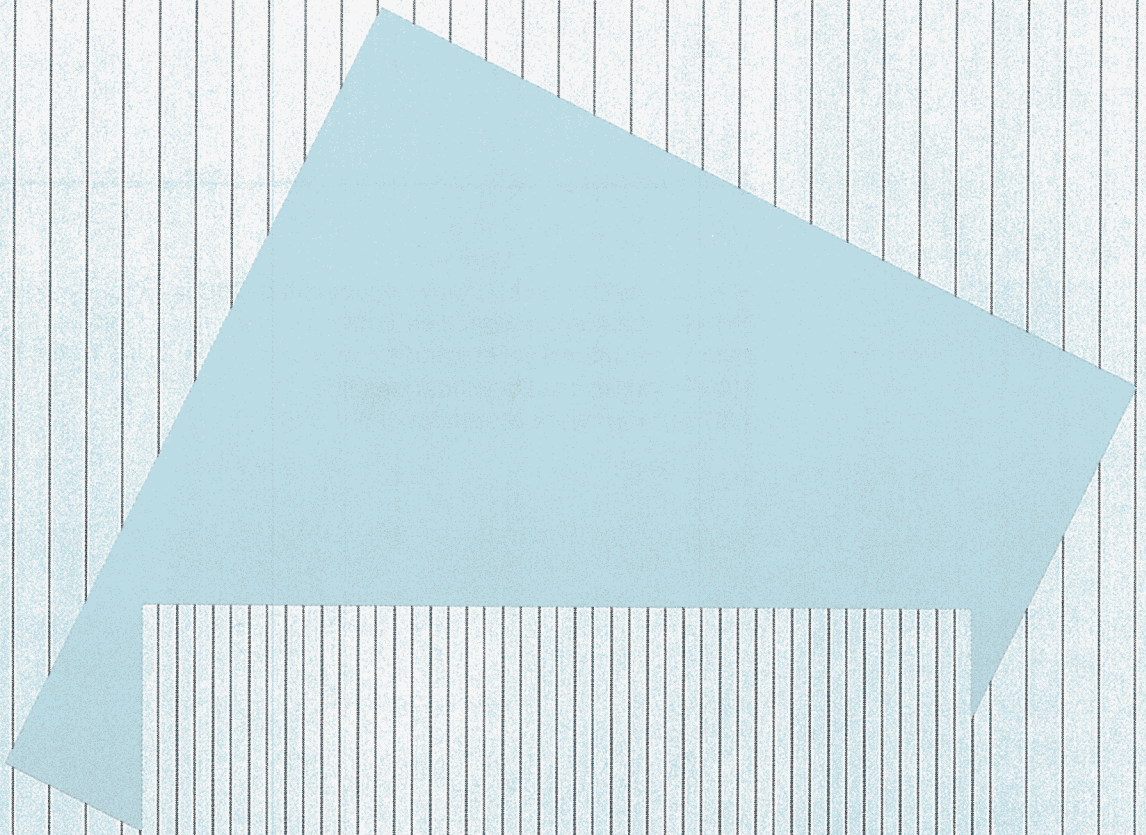

Troubleshooting

After you've checked out and installed your Apple Imagewriter, what happens if your printer doesn't run? You may have one of these common problems.

- **Is the cover open?** The Apple Imagewriter has an interlock switch that prevents it from running unless the protective carrier cover is completely closed and latched. If the printer stops printing because the cover is open, you can restart it by replacing the cover and pressing the SELECT button.
- **Are you out of paper?** When there is less than one inch of paper left, the paper error detector underneath the platen halts the printer and turns on the PAPER ERROR light. If you want to print one or two more lines anyway, you can override this switch by pressing the SELECT button. But if you are using pin-feed paper, bear in mind that by this time it will have ceased to feed properly.



Warning

Do not print without paper under the type head. You'll damage both the platen and the printing wires.

Figure A-1. Fuse

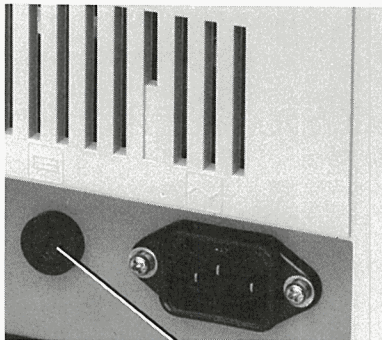

Fuse

- **Is the fuse blown?** It's easy to overlook the small cartridge fuse mounted next to the power cord on the back of the printer. If the printer won't work and the power light does not come on, unplug the power cord and remove the fuse by unscrewing the plastic cap in a counterclockwise direction. Check whether the metal wire inside is broken or not. If it is, replace it with a 2-ampere type 3AG fuse, obtainable at most electronic supply or auto parts stores. If the fuse blows again when you turn power back on, consult your Apple dealer.
- **Is an interface connection loose?** Sometimes the hookup between the printer and the Apple computer works loose. If you

suspect this problem, first turn off the power and then open the cover of your computer. Unplug and reconnect the interface board and cable. Look for any evidence of dirt or thumbprints on the connecting strip that projects from the bottom of the card. Make sure the flat cable has not become damaged or pinched.

- **Is your system incorrectly configured?** If your computer requires some sort of system reconfiguration before the computer and printer can communicate, make sure you have configured your system properly. In addition, verify that the computer is attempting to communicate with the printer via the same slot in which the interface card is installed.
- **Is the program at fault?** Sometimes software problems seem the same as hardware problems. The printer may fail to produce clean copy not because there is something wrong with its mechanism, but because the commands it receives from the computer are incomplete or confusing. A quick way to check this is to run the built-in test. This test exercises most of the mechanical functions of the printer, as well as its internal microprocessor. If the test runs properly, you can be fairly certain that any format problems—garbled or missing text, overprinted lines—lie in the program, or possibly in the interface. Try using a program that you know works, to check out the system as a whole.

The built-in test is described in Chapter 2, Setting Up Your Printer.

Command Summary

This appendix is a complete collection of all Apple Imagewriter control codes and DIP switch settings.

Note: Before using the following control codes, refer to Appendix G for firmware modifications applicable to your Apple Imagewriter.

Printer Standard Instructions

The following are the standard instructions, or default settings, for various functions of the Apple Imagewriter:

Function	Standard Instructions
Character pitch	Elite
Proportional character spacing	1 dot width
Underlining	No underlining
Boldface printing	No boldface
Headline type	No headlines
Direction of type head motion	Bidirectional
Line feed pitch	6 lines per inch
Optional line feed function	Disabled
Line feed direction	Forward
Left margin	Character position 0
Horizontal tabs	Cleared
Vertical tabs	B tab every 6 lines

DIP Switch Settings

The standard setting for each switch is depicted in capitals.

Switch Setting	Effect	Equivalent Code	
1-1		See Foreign Characters in Chapter 4	
1-2	Selects alternate characters		
1-3			
1-4	Closed	Page length 72 lines	
1-4	OPEN	Page length 66 lines	
1-5	Closed	Ignores eighth data bit	ESCAPE D CONTROL-@ 2
1-5	OPEN	Recognizes eighth data bit	ESCAPE Z CONTROL-@ 2

Switch Setting	Effect	Equivalent Code
1-6 1-7	Selects character pitch	See Character Pitch in Chapter 4
1-8 Closed	Adds LF after every CR	ESCAPE D { <i>@</i> }
1-8 OPEN	No LF after CR	CONTROL- <i>@</i> ESCAPE Z { <i>@</i> }
2-1 2-2	Selects baud setting	See Baud Setting in Chapter 4
2-3 Closed	XON/XOFF data protocol	
2-3 OPEN	Data Terminal Ready protocol	

General Control Codes

Code	Decimal	Hex	Effect
ESCAPE n	27 110	\$1B \$6E	Extended (9 characters per inch)
ESCAPE N	27 78	\$1B \$4E	Pica (10 characters per inch)
ESCAPE E	27 69	\$1B \$45	Elite (12 characters per inch)
ESCAPE p	27 112	\$1B \$70	Pica proportional
ESCAPE P	27 80	\$1B \$50	Elite proportional
ESCAPE e	27 101	\$1B \$65	Semicondensed (13.4 characters per inch)
ESCAPE q	27 113	\$1B \$71	Condensed (15 characters per inch)
ESCAPE Q	27 81	\$1B \$51	Ultracondensed (17 characters per inch)
ESCAPE _ n	27 n	\$1B \$n	Sets n dots between proportional characters (n = 1 to 6)
ESCAPE s _ n	27 115 n	\$1B 73 n	Sets spacing between all characters in proportional mode to n dots (n = 0 to 9)
ESCAPE R nnn c	27 82 nnn c	\$1B \$52 nnn c	Prints nnn repetitions of character c
CONTROL-H c	8 c	\$08 c	Backspaces one character and prints the character c
ESCAPE X	27 88	\$1B \$58	Starts underlining text
ESCAPE Y	27 89	\$1B \$59	Stops underlining text
ESCAPE !	27 33	\$1B \$21	Starts boldface printing

Code	Decimal	Hex	Effect
ESCAPE "	27 34	\$1B \$22	Ends boldface printing
CONTROL-N	14	\$0E	Begins headline mode
CONTROL-O	15	\$0F	Ends headline mode
ESCAPE >	27 62	\$1B \$3E	Left-to-right printing only
ESCAPE <	27 60	\$1B \$3C	Bidirectional printing
ESCAPE A	27 65	\$1B \$41	6 lines per inch
ESCAPE B	27 66	\$1B \$42	8 lines per inch
ESCAPE I 1	27 108 49	\$1B \$6C \$31	Enables optional line feed function
ESCAPE I 0	27 108 48	\$1B \$6C \$30	Disables optional line feed function
ESCAPE T nn	27 84 nn	\$1B \$54 nn	Distance between lines to be nn/144 inch (nn = 01 to 99)
ESCAPE f	27 102	\$1B \$66	Forward (normal) line feeding
ESCAPE r	27 114	\$1B \$72	Reverse line feeding
CONTROL-__ n	31 n	\$1F n	Feeds n lines of blank paper (n=1,2,3,4,5,6,7,8,9,;,:,<,<=>,?)
ESCAPE L nnn	27 76 nnn	\$1B \$4C nnn	Sets left margin to position nnn
CONTROL-L	12	\$0C	Feeds paper to next top of form
ESCAPE v	27 118	\$1B \$76	Sets TOF to current position
ESCAPE O	27 79	\$1B \$4F	Paper error detector off
ESCAPE o	27 111	\$1B \$6F	Paper error detector on
ESCAPE Z @CONTROL-@	27 90 64 0	\$1B \$5A \$40 \$0	End-of-line at CR only
ESCAPE D @CONTROL-@	27 68 64 0	\$1B \$44 \$40 \$0	End-of-line at CR, VT, FF, HT, CONTROL-__
CONTROL-X	24	\$18	Cancels all unprinted text
ESCAPE Z	27 90	\$1B \$5A	No line feed at buffer
__CONTROL-@	32 0	\$20 \$0	overflow (__ = space character)
ESCAPE D	27 68	\$1B \$44	Line feed added at buffer
__CONTROL-@	32 0	\$20 \$0	overflow (__ = space character)
ESCAPE D CONTROL-@	27 68 0 50	\$1B \$44 \$00 \$32	Ignores eighth bit of data byte
ESCAPE Z CONTROL-@	27 90 0 50	\$1B \$5A \$00 \$32	Recognizes eighth bit of data byte
ESCAPE c	27 99	\$1B \$63	Restores standard instructions (Software Reset)

Tabbing Control Codes

Code	Decimal	Hex	Effect
ESCAPE (a,b,——n.	27 40 a,b,——n.	\$1B \$28 a,b,——n.	Sets horizontal tab line
ESCAPE u	27 117	\$1B \$75	Sets horizontal tab in addition to those tabs already set (only one additional tab can be set in any one operation)
ESCAPE) a,b,——n.	27 41 a,b,——n.	\$1B \$29 a,b,——n.	Clears selected horizontal tabs
ESCAPE 0	27 48	\$1B \$30	Clears all tabs
CONTROL-I	9	\$09	Goes to next tab
CONTROL-] A@	29 65 64	\$1D \$41 \$40	Sets starting top of form (TOF)
C@	67 64	\$43 \$40	Sets bottom of form (BOF)
A@ CONTROL-^	65 64 30	\$41 \$40 \$1E	Sets TOF of next form
CONTROL-__ B	31 66	\$1F \$42	Drops to next tab B
CONTROL-__ C	31 67	\$1F \$43	Drops to next tab C
CONTROL-__ D	31 68	\$1F \$44	Drops to next tab D
CONTROL-__ E	31 69	\$1F \$45	Drops to next tab E
CONTROL-__ F	31 70	\$1F \$46	Drops to next tab F
CONTROL-__ A	31 65	\$1F \$41	Drops to next BOF or TOF
CONTROL-L	12	\$0C	Drops to next TOF
GS 0	29 48	\$1D \$30	Sets vertical tabbing to power-on status, and sets TOF to current paper position

Custom Character Control Codes

Code	Decimal	Hex	Effect
ESCAPE -	27 45	\$1B \$2D	Maximum width will be 8 dots
ESCAPE +	27 43	\$1B \$2B	Maximum width will be 16 dots
ESCAPE I	27 73	\$1B \$49	Starts loading new character(s)
CONTROL-D	4	\$04	Ends new character(s) loading
A.....P	65...80	\$41...\$50	Width code when using top 8 wires (A = 1 ... P = 16)
a.....p	97..112	\$61...\$70	Width code when using bottom 8 wires (a = 1 ... p = 16)
ESCAPE '	27 39	\$1B \$27	Switches to custom character font
ESCAPE *	27 42	\$1B \$2A	Switches to custom character font (high ASCII values)
ESCAPE \$	27 36	\$1B \$24	Switches back to normal font

Graphics Control Codes

Code	Decimal	Hex	Effect
ESCAPE G nnnn	27 71 nnnn	\$1B \$47 nnnn	Prints graphics columns corresponding to the following nnnn data bytes
ESCAPE S nnnn	27 83 nnnn	\$1B \$53 nnnn	Same as ESCAPE G
ESCAPE g nnn	27 103 nnn	\$1B \$67 nnn	Prints line corresponding to the following nnn x 8 data bytes
ESCAPE V nnnn c	27 86 nnnn c	\$1B \$56 nnnn c	Prints nnnn repetitions of the dot column specified by c
ESCAPE F nnnn	27 70 nnnn	\$1B \$46 nnnn	Places succeeding printing nnnn dot positions from left margin

ASCII, Binary, and Hexadecimal Codes

There are 256 possible eight-bit binary numbers, from 00000000 to 11111111. Of these, the first 128 (from 00000000 to 01111111) have been assigned to characters and commands used in data processing and communication. Their standard assignment forms the ASCII character set. (ASCII stands for the American Standard Code for Information Interchange.)

The remaining 128, which differ from the first 128 only because their most significant binary digit (first digit) is 1 instead of 0, are not officially assigned. Nevertheless, they are often called high ASCII characters.

The following chart lists the 128 standard ASCII character assignments. For each character it gives the binary, decimal, and hexadecimal equivalents for both standard and high versions. Note that the first 27 codes are control characters set by pressing the CONTROL key simultaneously with the desired character key.

ASCII	Low ASCII			High ASCII		
	Dec	Hex	76543210	Dec	Hex	76543210
CONTROL-@ NUL	0	00	00000000	128	80	10000000
CONTROL-A SOH	1	01	00000001	129	81	10000001
CONTROL-B STX	2	02	00000010	130	82	10000010
CONTROL-C ETX	3	03	00000011	131	83	10000011
CONTROL-D EOT	4	04	00000100	132	84	10000100
CONTROL-E ENQ	5	05	00000101	133	85	10000101
CONTROL-F ACK	6	06	00000110	134	86	10000110
CONTROL-G BEL	7	07	00000111	135	87	10000111
CONTROL-H BS	8	08	00001000	136	88	10001000
CONTROL-I HT	9	09	00001001	137	89	10001001
CONTROL-J LF	10	0A	00001010	138	8A	10001010
CONTROL-K VT	11	0B	00001011	139	8B	10001011
CONTROL-L FF	12	0C	00001100	140	8C	10001100
CONTROL-M CR	13	0D	00001101	141	8D	10001101
CONTROL-N SO	14	0E	00001110	142	8E	10001110
CONTROL-O SI	15	0F	00001111	143	8F	10001111
CONTROL-P DLE	16	10	00010000	144	90	10010000
CONTROL-Q DC1	17	11	00010001	145	91	10010001

ASCII	Low ASCII			High ASCII			
	Dec	Hex	76543210	Dec	Hex	76543210	
CONTROL-R	DC2	18	12	00010010	146	92	10010010
CONTROL-S	DC3	19	13	00010011	147	93	10010011
CONTROL-T	DC4	20	14	00010100	148	94	10010100
CONTROL-U	NAK	21	15	00010101	149	95	10010101
CONTROL-V	SYN	22	16	00010110	150	96	10010110
CONTROL-W	ETB	23	17	00010111	151	97	10010111
CONTROL-X	CAN	24	18	00011000	152	98	10011000
CONTROL-Y	EM	25	19	00011001	153	99	10011001
CONTROL-Z	SUB	26	1A	00011010	154	9A	10011010
	ESC	27	1B	00011011	155	9B	10011011
	FS	28	1C	00011100	156	9C	10011100
	GS	29	1D	00011101	157	9D	10011101
	RS	30	1E	00011110	158	9E	10011110
	US	31	1F	00011111	159	9F	10011111
	SP	32	20	00100000	160	A0	10100000
	!	33	21	00100001	161	A1	10100001
	"	34	22	00100010	162	A2	10100010
	#	35	23	00100011	163	A3	10100011
	\$	36	24	00100100	164	A4	10100100
	%	37	25	00100101	165	A5	10100101
	&	38	26	00100110	166	A6	10100110
	'	39	27	00100111	167	A7	10100111
	(40	28	00101000	168	A8	10101000
)	41	29	00101001	169	A9	10101001
	*	42	2A	00101010	170	AA	10101010
	+	43	2B	00101011	171	AB	10101011
	,	44	2C	00101100	172	AC	10101100
	-	45	2D	00101101	173	AD	10101101
	.	46	2E	00101110	174	AE	10101110
	/	47	2F	00101111	175	AF	10101111
	0	48	30	00110000	176	B0	10110000
	1	49	31	00110001	177	B1	10110001
	2	50	32	00110010	178	B2	10110010
	3	51	33	00110011	179	B3	10110011
	4	52	34	00110100	180	B4	10110100
	5	53	35	00110101	181	B5	10110101
	6	54	36	00110110	182	B6	10110110
	7	55	37	00110111	183	B7	10110111
	8	56	38	00111000	184	B8	10111000
	9	57	39	00111001	185	B9	10111001
	:	58	3A	00111010	186	BA	10111010
	;	59	3B	00111011	187	BB	10111011
	<	60	3C	00111100	188	BC	10111100
	=	61	3D	00111101	189	BD	10111101
	>	62	3E	00111110	190	BE	10111110
	?	63	3F	00111111	191	BF	10111111
	@	64	40	01000000	192	C0	11000000
	A	65	41	01000001	193	C1	11000001
	B	66	42	01000010	194	C2	11000010
	C	67	43	01000011	195	C3	11000011
	D	68	44	01000100	196	C4	11000100
	E	69	45	01000101	197	C5	11000101
	F	70	46	01000110	198	C6	11000110
	G	71	47	01000111	199	C7	11000111
	H	72	48	01001000	200	C8	11001000
	I	73	49	01001001	201	C9	11001001

ASCII	Low ASCII			High ASCII		
	Dec	Hex	76543210	Dec	Hex	76543210
J	74	4A	01001010	202	CA	11001010
K	75	4B	01001011	203	CB	11001011
L	76	4C	01001100	204	CC	11001100
M	77	4D	01001101	205	CD	11001101
N	78	4E	01001110	206	CE	11001110
O	79	4F	01001111	207	CF	11001111
P	80	50	01010000	208	D0	11010000
Q	81	51	01010001	209	D1	11010001
R	82	52	01010010	210	D2	11010010
S	83	53	01010011	211	D3	11010011
T	84	54	01010100	212	D4	11010100
U	85	55	01010101	213	D5	11010101
V	86	56	01010110	214	D6	11010110
W	87	57	01010111	215	D7	11010111
X	88	58	01011000	216	D8	11011000
Y	89	59	01011001	217	D9	11011001
Z	90	5A	01011010	218	DA	11011010
[91	5B	01011011	219	DB	11011011
\	92	5C	01011100	220	DC	11011100
]	93	5D	01011101	221	DD	11011101
^	94	5E	01011110	222	DE	11011110
_	95	5F	01011111	223	DF	11011111
	96	60	01100000	224	E0	11100000
a	97	61	01100001	225	E1	11100001
b	98	62	01100010	226	E2	11100010
c	99	63	01100011	227	E3	11100011
d	100	64	01100100	228	E4	11100100
e	101	65	01100101	229	E5	11100101
f	102	66	01100110	230	E6	11100110
g	103	67	01100111	231	E7	11100111
h	104	68	01101000	232	E8	11101000
i	105	69	01101001	233	E9	11101001
j	106	6A	01101010	234	EA	11101010
k	107	6B	01101011	235	EB	11101011
l	108	6C	01101100	236	EC	11101100
m	109	6D	01101101	237	ED	11101101
n	110	6E	01101110	238	EE	11101110
o	111	6F	01101111	239	EF	11101111
p	112	70	01110000	240	F0	11110000
q	113	71	01110001	241	F1	11110001
r	114	72	01110010	242	F2	11110010
s	115	73	01110011	243	F3	11110011
t	116	74	01110100	244	F4	11110100
u	117	75	01110101	245	F5	11110101
v	118	76	01110110	246	F6	11110110
w	119	77	01110111	247	F7	11110111
x	120	78	01111000	248	F8	11111000
y	121	79	01111001	249	F9	11111001
z	122	7A	01111010	250	FA	11111010
{	123	7B	01111011	251	FB	11111011
	124	7C	01111100	252	FC	11111100
}	125	7D	01111101	253	FD	11111101
~	126	7E	01111110	254	FE	11111110
DEL	127	7F	01111111	255	FF	11111111

Character Specifications

This appendix depicts the printer's stored dot-matrix patterns for all characters in both fixed-width and proportional printing modes.

Fixed-Width Characters

Table D-1. Fixed-Width Characters

All fixed-width characters are created by eight vertical columns, each of which is nine dots tall. The right-most column never contains dots, and the bottom two dots in each column are used only by lowercase characters with descenders, commas, and semicolons. The decimal and hexadecimal codes for each character appear at its upper left.

32/\$20 	33/\$21 	34/\$22 	35/\$23 See Table, D-3	36/\$24 	37/\$25 	38/\$26 	39/\$27
48/\$30 	49/\$31 	50/\$32 	51/\$33 	52/\$34 	53/\$35 	54/\$36 	55/\$37
64/\$40 See Table, D-3	65/\$41 	66/\$42 	67/\$43 	68/\$44 	69/\$45 	70/\$46 	71/\$47
80/\$50 	81/\$51 	82/\$52 	83/\$53 	84/\$54 	85/\$55 	86/\$56 	87/\$57
96/\$60 See Table, D-3	97/\$61 	98/\$62 	99/\$63 	100/\$64 	101/\$65 	102/\$66 	103/\$67
112/\$70 	113/\$71 	114/\$72 	115/\$73 	116/\$74 	117/\$75 	118/\$76 	119/\$77

40/\$28

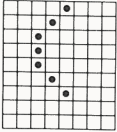

41/\$29

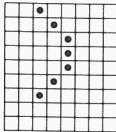

42/\$2A

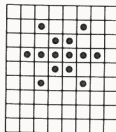

43/\$2B

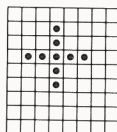

44/\$2C

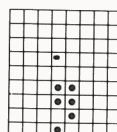

45/\$2D

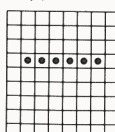

46/\$2E

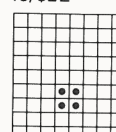

47/\$2F

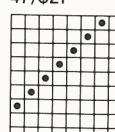

56/\$38

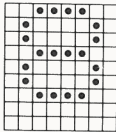

57/\$39

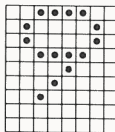

58/\$3A

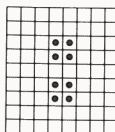

59/\$3B

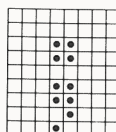

60/\$3C

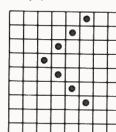

61/\$3D

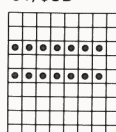

62/\$3E

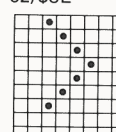

63/\$3F

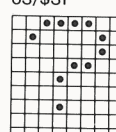

72/\$48

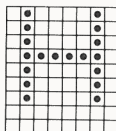

73/\$49

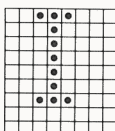

74/\$4A

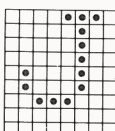

75/\$4B

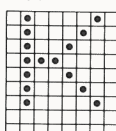

76/\$4C

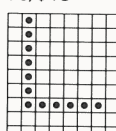

77/\$4D

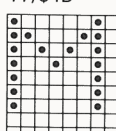

78/\$4E

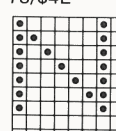

79/\$4F

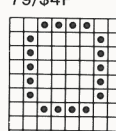

88/\$58

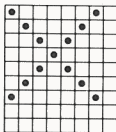

89/\$59

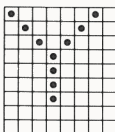

90/\$5A

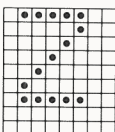

91/\$5B

See Table, D-3

92/\$5C

See Table, D-4

93/\$5D

See Table, D-3

94/\$5E

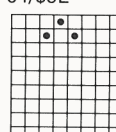

95/\$5F

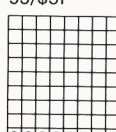

104/\$68

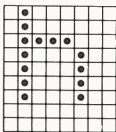

105/\$69

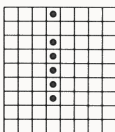

106/\$6A

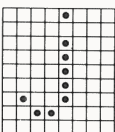

107/\$6B

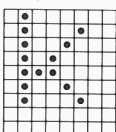

108/\$6C

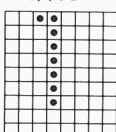

109/\$6D

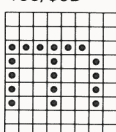

110/\$6E

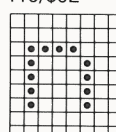

111/\$6F

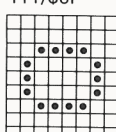

120/\$78

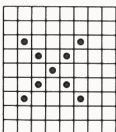

121/\$79

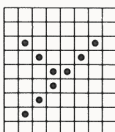

122/\$7A

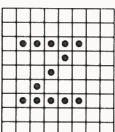

123/\$7B

See Table, D-3

124/\$7C

See Table, D-3

125/\$7D

See Table, D-3

126/\$7E

See Table, D-3



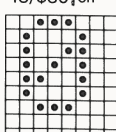







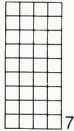

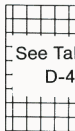

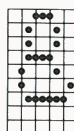

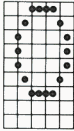
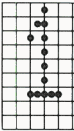
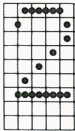

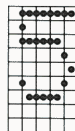

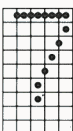
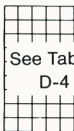
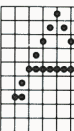
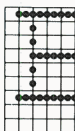
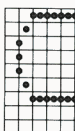
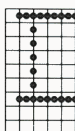



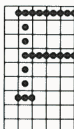

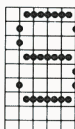
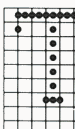
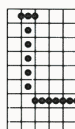
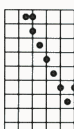
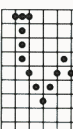
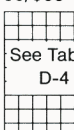
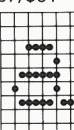
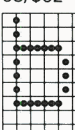
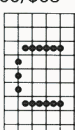
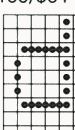
48/\$30^{slash}ion

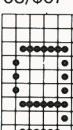

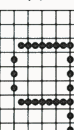
Proportional American Characters

Table D-2. Proportional American Characters

Widths of proportional characters vary. In the following chart, the width of each character appears at its lower right. The decimal and hexadecimal code for each character appear at its upper left.

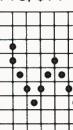
32/\$20  7	33/\$21  7	34/\$22  10	35/\$23 See Table, D-4  10	36/\$24  12	37/\$25  16	38/\$26  13	39/\$27  7
48/\$30  12	49/\$31  12	50/\$32  12	51/\$33  12	52/\$34  12	53/\$35  12	54/\$36  12	55/\$37  12
64/\$40 See Table, D-4  16	65/\$41  16	66/\$42  15	67/\$43  14	68/\$44  15	69/\$45  15	70/\$46  15	71/\$47  14
80/\$50  13	81/\$51  16	82/\$52  15	83/\$53  12	84/\$54  14	85/\$55  15	86/\$56  16	87/\$57  17
96/\$60 See Table, D-4  16	97/\$61  12	98/\$62  12	99/\$63  10	100/\$64  12	101/\$65  12	102/\$66  10	103/\$67  12
112/\$70  12	113/\$71  12	114/\$72  10	115/\$73  12	116/\$74  10	117/\$75  12	118/\$76  12	119/\$77  16

40/\$28

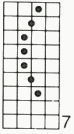

7

41/\$29

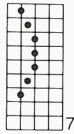

7

42/\$2A



12

43/\$2B

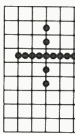

12

44/\$2C



7

45/\$2D



12

46/\$2E

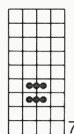

7

47/\$2F



12

56/\$38

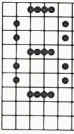

12

57/\$39

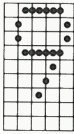

12

58/\$3A

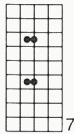

7

59/\$3B

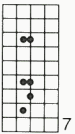

7

60/\$3C

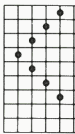

12

61/\$3D



12

62/\$3E

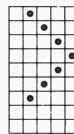

12

63/\$3F



12

72/\$48

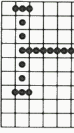

15

73/\$49

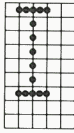

9

74/\$4A



13

75/\$4B

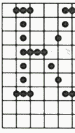

12

76/\$4C

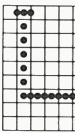

13

77/\$4D



17

78/\$4E

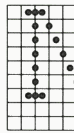

16

79/\$4F

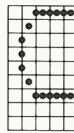

15

88/\$58

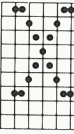

11

89/\$59

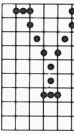

14

90/\$5A

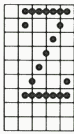

11

91/\$5B



See Table,
D-4

92/\$5C

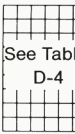

See Table,
D-4

93/\$5D

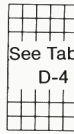

See Table,
D-4

94/\$5E



12

95/\$5F



17

104/\$68

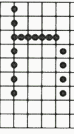

12

105/\$69



8

106/\$6A



7

107/\$6B

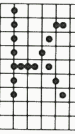

10

108/\$6C



8

109/\$6D



16

110/\$6E

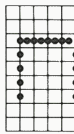

12

111/\$6F

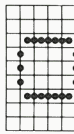

12

120/\$78

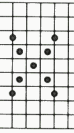

12

121/\$79

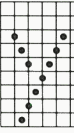

12

122/\$7A

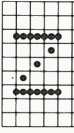

10

123/\$7B



See Table,
D-4

124/\$7C



See Table,
D-4

125/\$7D

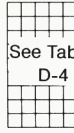

See Table,
D-4

126/\$7E

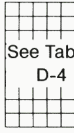

See Table,
D-4

48/\$30 slash on



12

Fixed-Width Foreign Language Characters

Table D-3. Fixed-Width Foreign Language Characters

All fixed-width foreign language characters are created by eight vertical columns of dots, each of which is nine dots high. The rightmost column never contains dots. The decimal and hexadecimal code for each character appears in the table heading.

ASCII CODE					
LANGUAGE	35/\$23	64/\$40	91/\$5B	92/\$5B	93/\$5D
ENGLISH (USA)					
ITALIAN					
ENGLISH (UK)					
GERMAN					
SWEDISH					
FRENCH					
SPANISH					

96/\$60

123/\$7B

124/\$7C

125/\$7D

126/\$7E

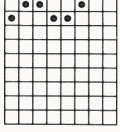
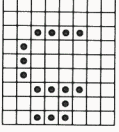
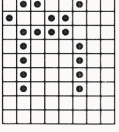
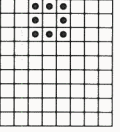
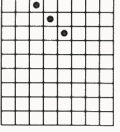
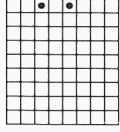
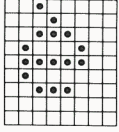
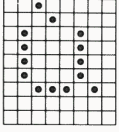
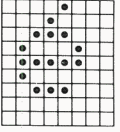
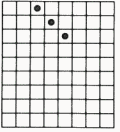
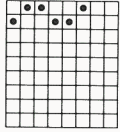
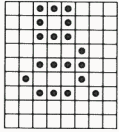
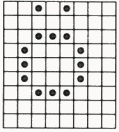
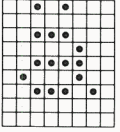
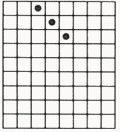
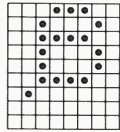
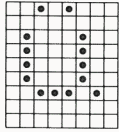
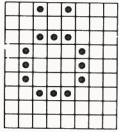
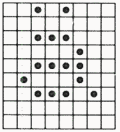
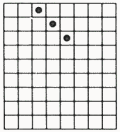
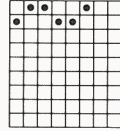
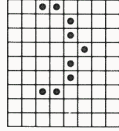
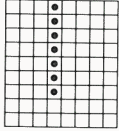
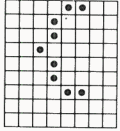
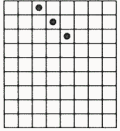
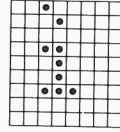
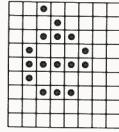
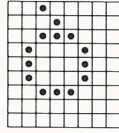
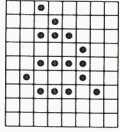
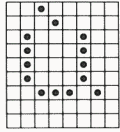
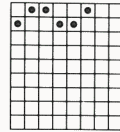
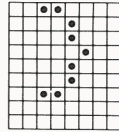
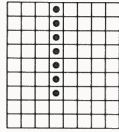
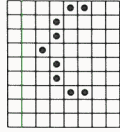
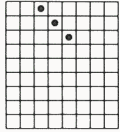

Proportional Foreign Language Characters

Table D-4. Proportional Foreign Language Characters

Widths of proportional foreign language characters vary. In the following chart, the width of the character appears at its lower right. The decimal and hexadecimal code for each character appears in the table heading.

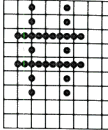
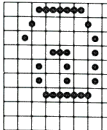
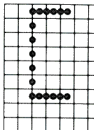
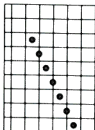
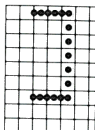
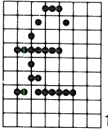
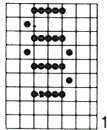
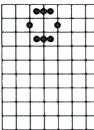
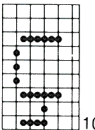
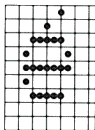
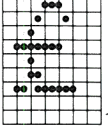
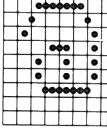
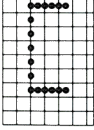
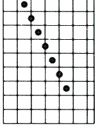
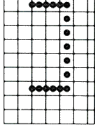
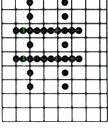
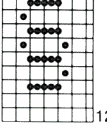
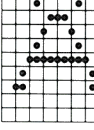
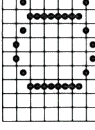
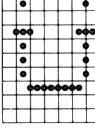
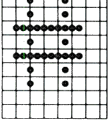
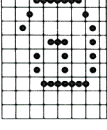
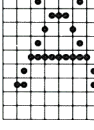
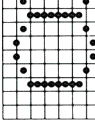
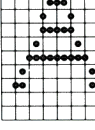
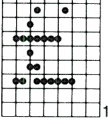
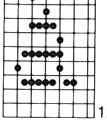
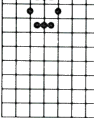
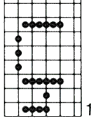
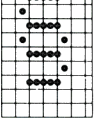
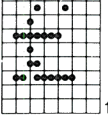
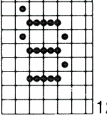
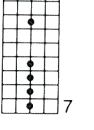
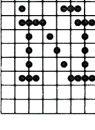
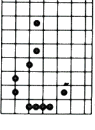
ASCII CODE (Dec. Hex.)	35/\$23	64/\$40	91/\$5B	92/\$5C	93/\$5D
LANGUAGE					
ENGLISH (USA)	 14	 14	 12	 12	 12
ITALIAN	 13	 12	 13	 10	 12
ENGLISH (UK)	 13	 14	 12	 12	 12
GERMAN	 14	 12	 16	 15	 15
SWEDISH	 14	 14	 16	 15	 16
FRENCH	 13	 12	 13	 10	 12
SPANISH	 13	 12	 7	 16	 12

96/\$60

123/\$7B

124/\$7C

125/\$7D

126/\$7E

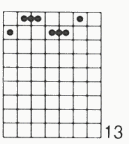
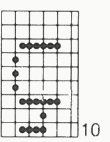
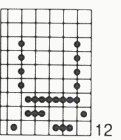
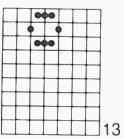
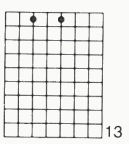
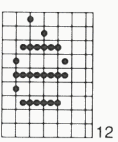
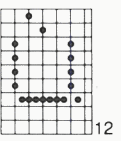
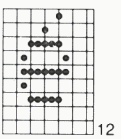
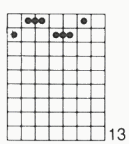
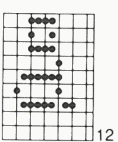
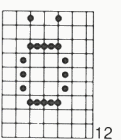
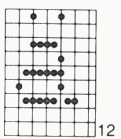
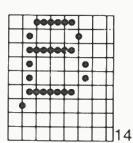
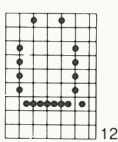
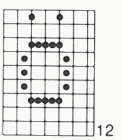
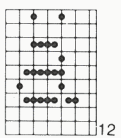
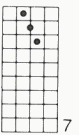
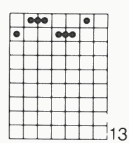
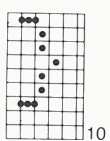
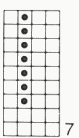
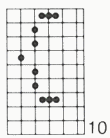
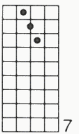
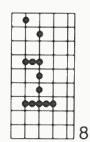
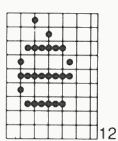
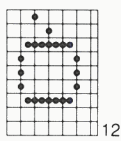
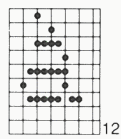
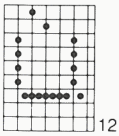
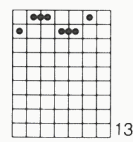
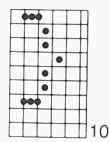
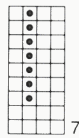
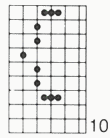
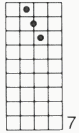

Printer Specifications

Print Method:	Dot matrix, logic seek (line by line)		
Printing Speed:	At 10 characters per inch: 120 characters per second 72 lines per minute		
Character Format:	Standard characters: Up to 7 dots wide by 8 dots high Custom (down-loaded) characters: Up to 16 dots wide by 8 dots high		
Standard Characters:	96 ASCII (alphanumeric and symbols) 25 European language characters		
Vertical Dot Spacing:	1/72 of an inch		
Line Length:	8 inches maximum		
Horizontal Pitches:	Characters per Inch	Characters per Line	Dots per inch (Approx.)
	17	136	136
	15	120	120
	13.4	107	107
	12	96	96
	10	80	80
	9	72	72
	8.5	68	136
	7.5	60	120
	6.7	53.5	107
	6	48	96
	5	40	80
	4.5	36	72
	variable	variable	160
	variable	variable	144
Paper Feed Direction:	Forward and reverse		
Line Spacing:	1/144 to 99/144 of an inch, selectable in increments of 1/144 of an inch		
Line Feed Method:	Stepper motor drive		
Line Feed Speed:	Maximum 10 per second at 6 lines per inch		

Paper Width:	3 to 10 inches		
Paper Thickness:	0.05 - 0.28 millimeter (0.002 - 0.011 inch) Original + 3 copies maximum		
Paper Feed Method:	Selectable, friction or sprocket/pin feed		
Paper Types:	Single sheets Roll paper Fanfold sprocketed paper (hole centers 4.0 - 9.5 inches)		
Paper Entry:	Top rear of printer		
Ribbon:	Cassette containing inked fabric ribbon (black recommended), 13 millimeters wide by 13,000 millimeters long, automatically reversing		
Power Options:	115 volts AC \pm 10%, 60 hertz 100 volts AC \pm 10%, 50/60 hertz 220 volts AC \pm 10%, 50 hertz 240 volts AC \pm 10%, 50 hertz		
Power Consumption:	Operating: 180 watts maximum Standby: 16 watts maximum		
Data Interface:	8-bit serial (see Appendix F)		
Weight:	8.5 kilograms (18.75 pounds)		
Dimensions:	Width	Depth	Height
	398	285	125 millimeters
	15.7	11.3	5.3 inches
Ambient Temperature:			
Operating	5 to 40 degrees Celsius (41 to 104 degrees Fahrenheit)		
Storage	-25 to +60 degrees Celsius (-13 to +140 degrees Fahrenheit)		
Maximum Humidity:			
Operating	85% relative humidity, noncondensing		
Storage	90% relative humidity, noncondensing		

Interface Specifications

Data Input Form:	7-bit or 8-bit serial: 1 start bit, data bits (7 or 8), and 1 stop bit (no parity bit)
Data Input Codes:	Characters: ASCII, 8- or 7-bit Graphics: 8-bit binary
Transmission Speed:	300, 1200, 2400, or 9600 baud
Input Buffer Size:	1K bytes
Printer Connector:	DB-25 male, or equivalent
Mating Connector:	DB-25S female, or equivalent

Figure F-1. RS232C Connector Pin Assignment

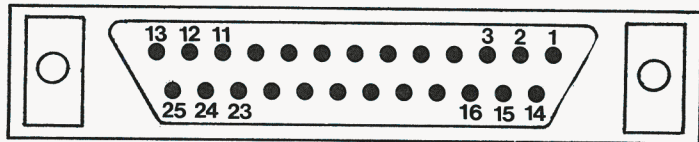

Pin No	Symbol	Description	Direction
1	FG	Frame Ground	
2	SD	Send Data	Output
3	RD	Receive Data	Input
4	RTS	Request to Send	Output
7	SG	Signal Ground	
14	FAULT	Fault	Output
20	DTR	Data Terminal Ready	Output

Signal Descriptions

Frame Ground: Grounding line for circuit protection.

Send Data: Serial dot transmission line to the computer from the printer. False when no data are being sent; true when data are being sent.

Receive Data: Serial data transmission line to the printer from the computer. False when no data are being sent; true when data are being sent.

Request to Send: Output signal from the printer; true when the printer is turned on.

$\overline{\text{Fault}}$: Output signal from the printer. False when the printer is deselected; true when selected.

Data Terminal Ready: Output signal from the printer. True when the printer is on and able to receive data; false when unable to receive data.

Input Circuit Configuration

RD signal: Maximum +15V, minimum +5V.

Figure F-2. Circuit: SN 75189A, or Equivalent

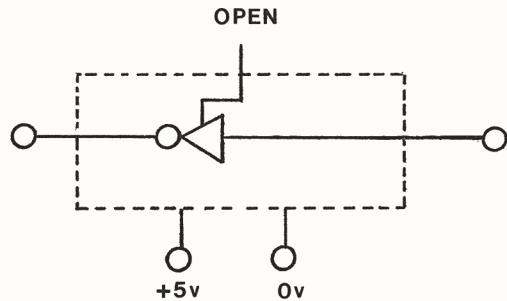

Output Circuit Configuration

SD, RTS, DTR, and FAULT signals: Nominal +7V

Figure F-3. Circuit: SN 75188, or Equivalent

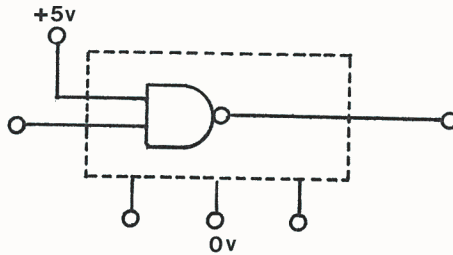
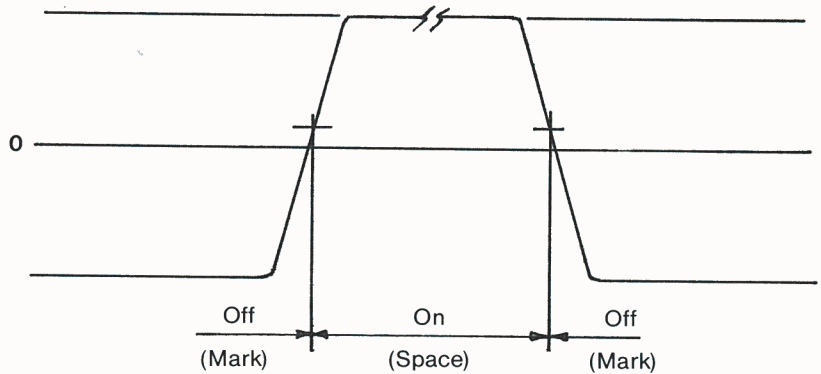

Figure F-4. Threshold Voltage Level



Protocol

The printer is capable of two types of data protocol: XON/XOFF or Data Transfer Ready (DTR). The DTR protocol uses the DTR signal to indicate the printer state. The XON/XOFF protocol uses the serial ASCII codes for XON and XOFF.

Data Transfer Ready Protocol

Whenever the capacity of the input buffer becomes less than 30 characters, the printer sends a busy signal by setting the DTR line false. The computer must stop transmission within the next 27 characters; if it does not, the printer will ignore the excess data. The DTR line is also set false when the printer is deselected, and when it receives a DC3 character. The DTR line is true whenever there is room for at least 100 characters in the input buffer, when the printer is turned on, selected, and has received a DC1 character.

XON/XOFF Protocol

Whenever the capacity of the input buffer becomes less than 266 characters, the printer sends an XOFF character. The computer must stop transmission when it receives the XOFF character; if it does not, the printer will ignore the excess data. An XOFF character is also sent when the printer is deselected, and when it receives a DC3 character (unless an XOFF character has been sent because the buffer is full). The printer sends an XON character whenever there is room for at least 337 characters in the input buffer, when the printer is turned on, and when the printer is selected (only if an XOFF character has been sent).

Firmware Modifications

This appendix lists firmware modifications that are referenced throughout this manual and are implemented on Apple Imagewriters with serial numbers 216001 and above.

Note: Before attempting to use any of the following control codes, you should check the serial number of your Imagewriter to see if the code is available for use.

General Control Code Modifications

Code	Decimal	Hex	Effect
ESCAPE _n	27 n	\$1B \$n	Sets n dots between proportional characters (n = 1 to 6)
ESCAPE s_n	27 115 n	\$1B 73 n	Sets spacing between all characters in proportional mode to n dots (n = 0 to 9)
ESCAPE 1	27 108 49	\$1B \$6C \$31	Enables optional line feed function
ESCAPE 0	27 108 48	\$1B \$6C \$30	Disables optional line feed function
ESCAPE v	27 118	\$1B \$76	Sets TOF to current position

Tabbing Control Code Modifications

Code	Decimal	Hex	Effect
ESCAPE u	27 117	\$1B \$75	Sets horizontal tab in addition to those tabs already set (only one additional tab can be set in any one operation)
GS 0	29 48	\$1D \$30	Sets vertical tabbing to power-on status and TOF to current paper position

Glossary

ASCII: Acronym for American Standard Code for Information Interchange, the information code that is sent to the Apple Imagewriter. It assigns a unique binary number to each character. See Appendix C.

binary: The number system used by most digital computers. Every binary number consists of a string of zeros and ones; the farthest right (least significant) digit has a value of 1, the next a value of 2, then 4, 8, 16, and so on.

bit: A single binary digit, consisting of either a zero or a one.

boot disk: A disk containing the programs and data that the Apple Computer needs to get started when power is turned on.

buffer: A memory area that holds information until it can be processed. The Apple Imagewriter has an input buffer, which stores excess incoming text until the mechanism has time to print it.

byte: A binary number of fixed length. In the Apple Imagewriter, bytes are eight bits long. Every character processed by the printer can be expressed as one byte, using the ASCII code.

character: Any letter, number, punctuation mark, or control code that can be acted upon by the printer. There are 256 possible characters, corresponding to the range of eight-bit binary numbers.

character pitch: The number of characters per inch printed along a horizontal line.

character set: The entire set of characters that can be printed by a device such as the Apple Imagewriter.

clear: To erase information or commands from memory, as when the Apple Imagewriter clears its horizontal tab stops.

command structure: The nature and interrelations of all the possible instructions that can be sent to a device such as a computer or printer. The Apple Imagewriter's command structure is summarized in Appendix B.

compile: To convert a program (source file) written by a human being into a file of commands that the computer can follow to make the program work.

control character: A nonprinting ASCII character that allows you to perform special functions with the Apple Imagewriter.

control code: One or more characters whose function is to change the way the printer acts (as opposed to text, which is simply printed).

control sequence: An ESCAPE character followed by a sequence of characters whose function is to change the nature of the characters that follow.

device: A piece of equipment connected to a computer. The Apple Imagewriter is a device, along with the video monitor, disk drives, and so on.

DIP switch: A small switch that affects a printer function and can be operated manually. There are 12 DIP switches located inside the case of the Apple Imagewriter. DIP stands for dual in-line package.

disk drive: A device that records and reads computer disks, somewhat like a phonograph.

dot matrix: The method by which the Apple Imagewriter prints. Each character is formed by a pattern of dots, each of which is located at one of the intersections of a fixed grid.

editor: A program that helps the user create and change text files by providing commands to insert and delete text, and perform other functions.

Electronic Vertical Form Unit (EVFU): A section of memory in the Apple Imagewriter that holds vertical tab commands for an entire page.

end-of-line character: Any character that tells the printer that the preceding text constitutes a full line and may now be printed.

ESCAPE character: An ASCII character that allows you to perform special functions with the Apple Imagewriter.

escape code: A sequence of characters, beginning with ESCAPE, that constitutes a complete command to the printer.

execute: To perform the actions specified by a program command or sequence of commands.

fanfold paper: Special paper supplied for computer printers such as the Apple Imagewriter. One continuous sheet, perforated and folded like the letter Z so that it lies in a stack.

file: In a computer, any named, ordered collection of data. Apple computer files are normally stored on disks. Text files are files of text, while data files are files of data and code files are files of code (usually the programs that make it easier for you to use the computer).

font: A complete set of type in one size and style of characters.

format: The general shape and appearance of the printer's output, including page size, character width and spacing, line spacing, and other factors.

function: In a programming language, an instruction that converts data from one form to another. The CHR or CHR\$ function, for example, converts an ASCII code number into its corresponding character.

graphics: Designs and pictures as opposed to written text, when referring to the capabilities of a device such as a printer.

hardware: In computer technology, the physical machinery; opposed to software, the program instructions.

hex, hexadecimal: The base-16 number system. (Ordinary decimal numbers are base-10.) Hexadecimal numerals consist of 0, the numerals 1-9, and the capital letters A-F. See Appendix C.

high ASCII characters: The set of ASCII characters with decimal equivalents from 128 to 255. Called *high* ASCII because their high bit (first binary digit) is set to 1 (for on) rather than 0 (for off).

Integer BASIC: The simplest version of the BASIC programming language that can be used with Apple computers. BASIC stands for Beginners All-Purpose Symbolic Instruction Code.

interface: In computer hardware, the equipment that accepts electrical signals from one part of a system and renders them into a form that can be used by another part.

interlock: In a machine such as a printer, a safety device that prevents operation under certain conditions, such as when the cover is open.

leading zero: A zero occurring at the beginning of a number, deleted by most computing programs.

line feed: An ASCII character (hex code 0A) that instructs a device such as a printer to feed one line of paper. Also refers to a vertical motion of the platen, moving the paper up one print line.

line feed pitch: The number of lines printed per vertical inch.

memory: Any part of a computer system that stores data.

microprocessor: A small circuit component (about the size of a postage stamp) that performs a complete set of basic computing functions.

operating system: The most fundamental program in a computer, which organizes the actions of the various parts of the computer and allows it to use other programs.

overflow: The condition that exists when an attempt is made to put more data into a memory than it can hold.

override: To modify or cancel a longstanding instruction with a temporary one.

Pascal: A higher-level programming language with statements that resemble English sentences. Named after the philosopher and mathematician Blaise Pascal.

pin-feed paper: Multisheet paper that has sprocket holes along both edges, for printers such as the Apple Imagewriter. Each page is separated from the next by perforations (just like paper towels). The paper is folded at the perforations to make a stack that feeds continuously into the printer.

platen: The rubber roller in a printer, which provides a backing for the printing action.

procedure: In the Pascal programming language, a set of instructions that work as a unit; equivalent to the subprogram in BASIC.

roll paper: Paper that comes in one complete, continuous roll (like a roll of wrapping paper).

SEL, select: A command to a device such as a printer to place it into a condition to receive data.

6502 Language: The programming language actually used by the components of Apple computers; also called machine code.

software: In general, programs and program instructions; as opposed to hardware, the machinery that runs software.

sprocket: In the Apple Imagewriter, either of the toothed wheels at the back that engage pin-feed paper and pull it through the machine.

stack: In a computer, a memory that is used for temporary storage of operating data during operation of a program.

standard instruction: An instruction automatically present when no superseding instruction has been received. The Apple Imagewriter assumes a set of standard instructions every time power is turned on. These are listed in Appendix B.

TAB: An ASCII character that commands a device such as a printer to start printing at a preset location (called a tab stop). There are two such characters: horizontal tab (hex 09) and vertical tab (hex 0B). Corresponds to tab on a typewriter.

TOF, top of form: The very top of a page of text.

type head: In the Apple Imagewriter, the part that moves horizontally along the platen and performs the actual printing.

wires: In the Apple Imagewriter, the nine strikers in the type head, each of which prints one dot.

Index

A

A.....P 67, 85
 a.....p 67, 85
 alternate character groups 44
 alternate language characters 43
 American characters 43-44, 94
 fixed width 92
 proportional 94
 A@ CONTROL-^ 84
 ASCII characters 37, 56, 69,
 87-90
 high 87
 ASCII codes 37
 ASCII HT command 59

B

backspacing 44-45
 baud setting 39
 bidirectional printing 46
 binary numbers 38, 66, 67, 69,
 87-90
 bit
 least significant 66
 most significant 66
 BOF See bottom of form
 boldface 34, 36, 39, 45, 81
 bond paper 15
 bottom of form (BOF) 60, 62, 64
 British characters 43-44
 British pound sign 44
 buffer 51
 input 53-55
 overflow 42, 56-57
 built-in test 5, 23, 29, 80
 byte length 56-57

C

cable, connecting 24
 cable, power 3
 cancelling text
 carriage return (CR) 48, 49, 53

carrier bar 21
 carrier cover
 troubleshooting 79
 while printing 10
 while setting up printer 7
 while unpacking 4, 5
 carrier shaft 29
 carrier track 8
 cassette supporters 21, 22
 cents sign 44
 character(s)
 alternate language 43
 ASCII 37, 56, 69, 87-90
 custom 33
 format 101
 groups, alternate 44
 per inch 31
 pitch 31, 39-41, 58, 72, 75, 81
 repetition 42
 standard 11, 44
 width 33, 65, 67
 CHR function 38, 73
 CHR\$ function 38, 72
 clamps, paper 17
 cleaning 27-28
 column-oriented graphics 71-73
 condensed characters 40, 58
 configuration 80
 connecting cable 24
 connecting your printer 24
 control characters 36, 38
 nonprinting 37
 control cluster 9
 control code(s) 35, 36, 37
 and justified text 41
 and DIP switch settings 41
 character spacing 41
 control sequences 36-37
 CONTROL-] A@ 60, 84
 CONTROL-__A 62, 84
 CONTROL-__B 62, 84
 CONTROL-__C 62, 84

CONTROL-__D 62, 84
CONTROL-__E 62, 84
CONTROL-__F 62, 84
CONTROL-__n 49, 83
CONTROL-D 67, 68, 85
CONTROL-H 44, 45, 82
CONTROL-I 57, 59, 84
CONTROL-L 36, 50, 62, 83, 84
CONTROL-N 46, 83
CONTROL-O 46, 83
CONTROL-X 55, 83
cover interlock switch 79
CR See carriage return
custom character(s) 65-70

D

data byte length 56-57
data byte(s) 56, 71, 72
data terminal ready 39
data transfer ready protocol 106
decimal numbers 37
descenders 66
deselect 10
DIP switch 1 35
DIP switch 2 35
DIP switch assemblies 8, 35
DIP switch(es) 34, 35, 37
 settings 35-36, 40, 81
dot matrix method 8
dot placement 74-75
dot spacing 48, 72
dot(s) 10
dots per inch 65
double-spaced printing 47
double-width printing 46

E

eighth bit 56
electrical ground 23
Electronic Vertical Form Unit
 (EVFU) 59
elite characters 40, 58
elite proportional characters 40,
 41, 50, 58
end-of-line 48, 51, 55
ESCAPE character 36
ESCAPE ! 45, 82
ESCAPE " 45, 83
ESCAPE \$ 68, 85
ESCAPE ' 68, 85
ESCAPE (57, 84
ESCAPE) 57, 84
ESCAPE + 67, 85
ESCAPE - 67, 85
ESCAPE __n 82, 107

ESCAPE 0 57, 84
ESCAPE 1 0 83, 107
ESCAPE 1 1 83, 107
ESCAPE < 46, 83
ESCAPE > 46, 83
ESCAPE * 68, 85
ESCAPE A 48, 83
ESCAPE B 48, 83
ESCAPE c 51, 83
ESCAPE D |@| CONTROL-@ 47
ESCAPE D CONTROL-A
 CONTROL @ 42
ESCAPE D CONTROL-@ 2 57, 83
ESCAPE D __CONTROL-@ 56, 83
ESCAPE D@ CONTROL-@ 55, 83
ESCAPE E (elite) 40, 82
ESCAPE e (semicondensed) 40,
 82
ESCAPE F 75, 85
ESCAPE f 49, 83
ESCAPE G 71, 75, 85
ESCAPE g 71, 85
ESCAPE I 67, 85
ESCAPE L 49, 75
ESCAPE N 40, 82
ESCAPE n 40, 82
ESCAPE O 51, 84
ESCAPE o 5, 83
ESCAPE P (elite proportional) 40,
 82
ESCAPE p (pica proportional) 40,
 82
ESCAPE Q (ultracondensed) 40,
 82
ESCAPE q (condensed) 40, 82
ESCAPE R 42, 82
ESCAPE r 49, 83
ESCAPE S 71, 85
ESCAPE s 41, 107
ESCAPE s n 41, 82, 107
ESCAPE T 48, 83
ESCAPE u 57, 59, 84, 108
ESCAPE V 74, 85
ESCAPE v 51, 83, 107
ESCAPE X 38, 45, 82
ESCAPE Y 45, 82
ESCAPE Z |@| CONTROL-@ 47
ESCAPE Z CONTROL-A
 CONTROL-@ 42
ESCAPE Z CONTROL-@ 2 57, 83
ESCAPE Z@ CONTROL-@ 55, 83
ESCAPE Z__CONTROL-@ 56, 83
EVFU (Electronic Vertical Form
 Unit) 59
extended characters 40, 58

F

fixed width character(s) 65,
92-93, 96-97
font(s) 69
foreign characters 34, 43-44,
96-99
 fixed width 96-97
 proportional 98-99
form feed 55, 59
FORM FEED button 10, 20, 50
format file 62, 71, 75
French characters 43-44
friction setting 6, 19
fuse replacement 79

G

German characters 43-44
graphics
 control codes 71-74
 line-oriented 74-75
GS O 84, 108
guide pins 28

H

hairline rules 74
headline(s) 34, 39, 81
hexadecimal numbers 37-38,
87-89
high ASCII characters 87-89
horizontal dot spacing 40
horizontal rules 74
horizontal tab setting,
 maximum 58
horizontal tabbing 57-58
horizontal tabs 59, 81
humidity range 27

I

input buffer 53-55
instructions, standard 34, 51, 81
interface card 80
interface connection 79
interface connector cable 7, 79
interlock switch 79
Italian characters 43-44

J

K

L

leading zeros 42
least significant bit 66
least significant digit 69
left margin setting 49, 58, 81
line spacing 33, 48
line feed 42, 46-49
 automatic 47
 button 10, 21
 direction 49, 63, 81
 pitch 33, 48, 50, 63, 81
 optional 46, 81
line feeding
 multiple 49
line-oriented graphics 74
lines per inch 33, 48
lines per page 33, 48
loading paper 15-21
 pin-feed 18
 plain paper 19
lock plates 28
lubrication 29
lubrication ring 29

M

margin setting(s)
 left 34
 right 34
microprocessor 3, 11, 23, 34, 36,
80
most significant bit 66
most significant digit 69
multiple form paper 15, 21
multiple line feeding 49
multiple sheet (pin-feed)
 paper 16-21

N

numbers
 binary 38, 66, 67, 69, 87-90
 hexadecimal 37-38, 87-89

O

oiling 29
one-direction printing 46
ON/OFF switch 6, 9
overflow, buffer 42, 56

P

page length 20, 33, 35, 50, 64
paper
 bond 15
 clamps 17
 cover 7-8
 loading 15-21
 multiple form 15, 21
 pinfeed 15, 16-21, 20
 plain 16-21
 roll 15
 thickness 15, 21
 width 16
paper error detector 27, 51, 79
PAPER ERROR light 10, 51, 79
paper thickness lever 21
pica characters 40, 58
pica proportional characters 40, 41, 50, 58
pin-feed paper 16-21
 loading 16-21
pin-feed setting 6, 18-19
pin-feeder width 16-17
pitch
 character 33, 39-41, 58, 65, 72, 75, 81
 line feed 33, 63, 81
 proportional 50, 58
plain paper 16-21
platen 4, 10, 17, 79
 knob 6, 17, 21
plus-or-minus sign 69
power cable 3
power switch 6
print method 101
printer, connecting 24
printer, testing 23
printing
 bidirectional 46
 double-spaced 47
 double-width 46
 one-directional 46
printing format 33
printing speed 101

proportional characters 41, 81
proportional pitch 40, 58
 elite 58
 pica 58
protocol 105
 data transfer ready 106
 serial interface 39
 XON/XOFF 106

Q

R

red rings 17, 49
release lever 6, 16, 17
repacking 30
ribbon 8, 21-22
 cassette 8, 21-22
 deck 21
ribbon guide plate 21-22
right margin setting 34
ring, lubrication 29
roll paper 15
roller shaft 17, 18, 49

S

SEL See select
SELECT button (SEL) 9, 10, 79
SELECT light 29
selected tab 58
semicondensed characters 40, 58
serial interface protocol 39
setting
 friction 6, 19
 pin-feed 6, 18-19
 top of page 20-21
shaft, roller 17, 18, 49
slashed zeros 33, 42
software 80
spacing, line 33, 48
Spanish characters 43-44
sprocket release levers 6, 16, 17
sprockets 6, 18
standard instructions 34, 51, 81
strikers 11
subscripts 33
superscripts 33
supporters, cassette 21, 22
SW-1 35
SW-2 35
SW1-1 44, 81

- SW1-2 44, 81
- SW1-3 44, 81
- SW1-4 50, 64, 81
- SW1-5 56, 69
- SW1-6 41, 42, 81
- SW1-7 41, 51, 81
- SW1-8 47, 81
- SW2-1 39
- SW2-2 39, 81
- SW2-3 39, 81
- Swedish characters 43-44
- switch, power 6
- symbols 34

T

- TAB 38
- tab line 57-58
- tab position(s) 57
- tabbing control codes 57-64
- tabbing, horizontal 57-58
- tabbing, vertical 59-64
- temperature range (operating) 27
- test, built-in 5, 23, 27, 29, 80
- testing your printer 23
- text files 37
- TOF See top of form
- top of form (TOF) 51, 60, 61, 64
- top of the page 20-21
- track, carrier 8
- troubleshooting 79-80
- typehead 11
 - cleaning 27
 - lock plates 28
 - motion 10, 46, 81

U

- ultracondensed characters 40
- underlining 34, 45, 81
- unslashed zeros 33, 42

V

- vertical tab
 - default 64
 - reset 64
 - setting(s) 59-62
- vertical tabs (VT) 55, 62-64, 81

W

- width
 - character 34, 65-66
 - paper 16
 - pin-feeder 16-17
- wires 11, 65, 67, 69, 72
- workspace 24

X

- XON/XOFF protocol 39, 106

Y

Z

- zeros
 - leading 42
 - slashed 33, 42
 - unslashed 33, 42

Apple Imagewriter Character Set

ASCII	Dec	Hex	ASCII	Dec	Hex	ASCII	Dec	Hex	ASCII	Dec	Hex
NUL	00	\$0 0	SP	32	\$20	Ⓐ*	64	\$40	Ⓣ*	96	60
SOH	01	\$0 1	!	33	\$21	A	65	\$41	a	97	61
STX	02	\$0 2	..	34	\$22	B	66	\$42	b	98	62
ETX	03	\$0 3	Ⓣ*	35	\$23	C	67	\$43	c	99	63
EOT	04	\$0 4	Ⓢ*	36	\$24	D	68	\$44	d	100	64
ENQ	05	\$0 5	%	37	\$25	E	69	\$45	e	101	65
ACK	06	\$0 6	&	38	\$26	F	70	\$46	f	102	66
BEL	07	\$0 7	'	39	\$27	G	71	\$47	g	103	67
BS	08	\$0 8	{	40	\$28	H	72	\$48	h	104	68
HT	09	\$0 9	}	41	\$29	I	73	\$49	i	105	69
LF	10	\$0 A	*	42	\$2A	J	74	\$4A	j	106	6A
VT	11	\$0 B	+	43	\$2B	K	75	\$4B	k	107	6B
FF	12	\$0 C	,	44	\$2C	L	76	\$4C	l	108	6C
CR	13	\$0 D	-	45	\$2D	M	77	\$4D	m	109	6D
SO	14	\$0 E	.	46	\$2E	N	78	\$4E	n	110	6E
SI	15	\$0 F	/	47	\$2F	O	79	\$4F	o	111	6F
DLE	16	\$10	0	48	\$30	P	80	\$50	p	112	70
DC1	17	\$11	1	49	\$31	Q	81	\$51	q	113	71
DC2	18	\$12	2	50	\$32	R	82	\$52	r	114	72
DC3	19	\$13	3	51	\$33	S	83	\$53	s	115	73
DC4	20	\$14	4	52	\$34	T	84	\$54	t	116	74
NAK	21	\$15	5	53	\$35	U	85	\$55	u	117	75
SYN	22	\$16	6	54	\$36	V	86	\$56	v	118	76
ETB	23	\$17	7	55	\$37	W	87	\$57	w	119	77
CAN	24	\$18	8	56	\$38	X	88*	\$58	x	120	78
EM	25	\$19	9	57	\$39	Y	89	\$59	y	121	79
SUB	26	\$1A	:	58	\$3A	Z	90	\$5A	z	122	7A
ESC	27	\$1B	;	59	\$3B	Ⓢ*	91	\$5B	Ⓣ*	123	7B
FS	28	\$1C	<	60	\$3C	Ⓢ*	92	\$5C	Ⓣ*	124	7C
GS	29	\$1D	=	61	\$3D	Ⓢ*	93	\$5D	Ⓣ*	125	7D
RS	30	\$1E	>	62	\$3E	Ⓢ*	94	\$5E	Ⓣ*	126	7E
US	31	\$1F	?	63	\$3F	-	95	\$5F	DEL	127	7F

Note: The reference symbolⓈ* refers to the Apple Imagewriter Extended Character Set (For Foreign Languages) table below.

Apple Imagewriter Extended Character Set (For Foreign Languages)

Reference Number	0	1	2	3	4	5	6	7	8	9	10	11
Hexadecimal	\$23	\$24	\$40	\$5B	\$5C	\$5D	\$5E	\$60	\$7B	\$7C	\$7D	\$7E
American	#	#	Ⓢ	Ⓢ	/	Ⓢ	Ⓢ	Ⓢ	Ⓢ	Ⓢ	Ⓢ	Ⓢ
British	#	#	Ⓢ	Ⓢ	/	Ⓢ	Ⓢ	Ⓢ	Ⓢ	Ⓢ	Ⓢ	Ⓢ
German	#	#	Ⓢ	Ⓢ	/	Ⓢ	Ⓢ	Ⓢ	Ⓢ	Ⓢ	Ⓢ	Ⓢ
French	#	#	Ⓢ	Ⓢ	/	Ⓢ	Ⓢ	Ⓢ	Ⓢ	Ⓢ	Ⓢ	Ⓢ
Swedish	#	#	Ⓢ	Ⓢ	/	Ⓢ	Ⓢ	Ⓢ	Ⓢ	Ⓢ	Ⓢ	Ⓢ
Italian	#	#	Ⓢ	Ⓢ	/	Ⓢ	Ⓢ	Ⓢ	Ⓢ	Ⓢ	Ⓢ	Ⓢ
Spanish	#	#	Ⓢ	Ⓢ	/	Ⓢ	Ⓢ	Ⓢ	Ⓢ	Ⓢ	Ⓢ	Ⓢ

DIP Switch Settings

Note: The standard setting for each switch is depicted in capitals.

Switch Setting	Effect	Equivalent Code
1-1		See Foreign Characters in Chapter 4
1-2	Selects alternate characters	
1-3		
1-4	Closed	Page length 72 lines
1-4	OPEN	Page length 66 lines
1-5	Closed	Ignores eighth data bit
1-5	OPEN	Recognizes eighth data bit
1-6		Selects character pitch
1-7		See Character Pitch in Chapter 4
1-8	Closed	Adds LF after every CR
1-8	OPEN	No LF after CR
2-1		Selects baud setting
2-2		See Baud Setting in Chapter 4
2-3	Closed	XON/XOFF data protocol
2-3	OPEN	Data Terminal Ready protocol

General Control Codes

Code	Decimal	Hex	Effect
ESCAPE n	27 110	\$1B \$6E	Extended (9 characters per inch)
ESCAPE N	27 78	\$1B \$4E	Pica (10 characters per inch)
ESCAPE E	27 69	\$1B \$45	Elite (12 characters per inch)
ESCAPE p	27 112	\$1B \$70	Pica proportional
ESCAPE P	27 80	\$1B \$50	Elite proportional
ESCAPE e	27 101	\$1B \$65	Semicondensed (13.4 characters per inch)
ESCAPE q	27 113	\$1B \$71	Condensed (15 characters per inch)
ESCAPE Q	27 81	\$1B \$51	Ultracondensed (17 characters per inch)
ESCAPE _ n	27 n	\$1B \$n	Sets n dots between proportional characters (n = 1 to 6)
ESCAPE s _ n	27 115 n	\$1B 73 n	Sets spacing between all characters in proportional mode to n dots (n = 0 to 9)
ESCAPE R nnn c	27 82 nnn c	\$1B \$52 nnn c	Prints nnn repetitions of character c

Code	Decimal	Hex	Effect
CONTROL-H c	8 c	\$0 8 c	Backspaces one character and prints the character c
ESCAPE X	27 88	\$1B \$58	Starts underlining text
ESCAPE Y	27 89	\$1B \$59	Stops underlining text
ESCAPE !	27 33	\$1B \$21	Starts boldface printing
ESCAPE "	27 34	\$1B \$22	Ends boldface printing
CONTROL-N	14	\$0 E	Begins headline mode
CONTROL-O	15	\$0 F	Ends headline mode
ESCAPE >	27 62	\$1B \$3E	Left-to-right printing only
ESCAPE <	27 60	\$1B \$3C	Bidirectional printing
ESCAPE A	27 65	\$1B \$41	6 lines per inch
ESCAPE B	27 66	\$1B \$42	8 lines per inch
ESCAPE I 1	27 108 49	\$1B \$6C \$31	Enables optional line feed function
ESCAPE I 0	27 108 48	\$1B \$6C \$30	Disables optional line feed function
ESCAPE T nn	27 84 nn	\$1B \$54 nn	Distance between lines to be nn/144 inch (nn = 01 to 99)
ESCAPE f	27 102	\$1B \$66	Forward (normal) line feeding
ESCAPE r	27 114	\$1B \$72	Reverse line feeding
CONTROL-_ n	31 n	\$1F n	Feeds n lines of blank paper (n = 1,2,3,4,5,6,7,8,9,;,:,<,>,?)
ESCAPE L nnn	27 76 nnn	\$1B \$4C nnn	Sets left margin to position nnn
CONTROL-L	12	\$0 C	Feeds paper to next top of form
ESCAPE v	27 118	\$1B \$76	Sets TOF to current position
ESCAPE O	27 79	\$1B \$4F	Paper error detector off
ESCAPE o	27 111	\$1B \$6F	Paper error detector on
ESCAPE Z	27 90	\$1B \$5A	End-of-line at CR only
@CONTROL-@	64 0	\$40 \$0	
ESCAPE D	27 68	\$1B \$44	End-of-line at CR, VT, FF, HT, CONTROL-_
@CONTROL-@	64 0	\$40 \$0	
CONTROL-X	24	\$18	Cancels all unprinted text
ESCAPE Z	27 90	\$1B \$5A	No line feed at buffer
CONTROL-@	32 0	\$20 \$0	overflow (= space character)
ESCAPE D	27 68	\$1B \$44	Line feed added at buffer

Custom Character Control Codes

Code	Decimal	Hex	Effect
__CONTROL-@	32 0	\$20 \$0	overflow (__ = space character)
ESCAPE D	27 68	\$1B \$44	Ignores eighth bit of data byte
CONTROL-@	0 50	\$00 \$20	
ESCAPE Z	27 90	\$1B \$5A	Recognizes eighth bit of data byte
CONTROL-@	0 50	\$00 \$20	
ESCAPE c	27 99	\$1B \$63	Restores standard instructions (Software Reset)

Tabbing Control Codes

Code	Decimal	Hex	Effect
ESCAPE (a,b,---n.	27 40 a,b,---n.	\$1B \$28 a,b,---n.	Sets horizontal tab line
ESCAPE u	27 117	\$1B \$75	Sets horizontal tab in addition to those tabs already set (only one additional tab can be set in any one operation)
ESCAPE) a,b,---n.	27 41 a,b,---n.	\$1B \$29 a,b,---n.	Clears selected horizontal tabs
ESCAPE 0	27 48	\$1B \$30	Clears all tabs
CONTROL-I	9	\$0 9	Goes to next tab
CONTROL-J A@	29 65 64	\$1D \$41 \$40	Sets starting top of form (TOF)
C@	67 64	\$43 \$40	Sets bottom of form (BOF)
A@ CONTROL-	65 64 30	\$41 \$40 \$1E	Sets TOF of next form
CONTROL-__ B	31 66	\$1F \$42	Drops to next tab B
CONTROL-__ C	31 67	\$1F \$43	Drops to next tab C
CONTROL-__ D	31 68	\$1F \$44	Drops to next tab D
CONTROL-__ E	31 69	\$1F \$45	Drops to next tab E
CONTROL-__ F	31 70	\$1F \$46	Drops to next tab F
CONTROL-__ A	31 65	\$1F \$41	Drops to next BOF or TOF
CONTROL-L	12	\$0 C	Drops to next TOF
GS 0	29 48	\$1D \$30	Sets vertical tabbing to power-on status, and sets TOF to current paper position

Code	Decimal	Hex	Effect
ESCAPE -	27 45	\$1B \$2D	Maximum width will be 8 dots
ESCAPE +	27 43	\$1B \$2B	Maximum width will be 16 dots
ESCAPE I	27 73	\$1B \$49	Starts loading new character(s)
CONTROL-D	4	\$0 4	Ends new character(s) loading
A.....P	65...80	\$41...\$50	Width code when using top 8 wires (A = 1 ... P = 16)
a.....p	97..112	\$61...\$70	Width code when using bottom 8 wires (a = 1 ... p = 16)
ESCAPE ' .	27 39	\$1B \$27	Switches to custom character font
ESCAPE * .	27 42	\$1B \$2A	Switches to custom character font (high ASCII values)
ESCAPE \$	27 36	\$1B \$24	Switches back to normal font

Graphics Control Codes

Code	Decimal	Hex	Effect
ESCAPE G nnnn	27 71 nnnn	\$1B \$47 nnnn	Prints graphics columns corresponding to the following nnnn data bytes
ESCAPE S nnnn	27 83 nnnn	\$1B \$53 nnnn	Same as ESCAPE G
ESCAPE g nnn	27 103 nnn	\$1B \$67 nnn	Prints line corresponding to the following nnn x 8 data bytes
ESCAPE V nnnn c	27 86 nnnn c	\$1B \$56 nnnn c	Prints nnnn repetitions of the dot column specified by c
ESCAPE F nnnn	27 70 nnnn	\$1B \$46 nnnn	Places succeeding printing nnnn dot positions from left margin



Tuck end flap
inside back cover
when using manual.



20525 Mariani Avenue
Cupertino, California 95014
(408) 996-1010
TLX 171-576