

Bell System Vehicle Graphics Manual



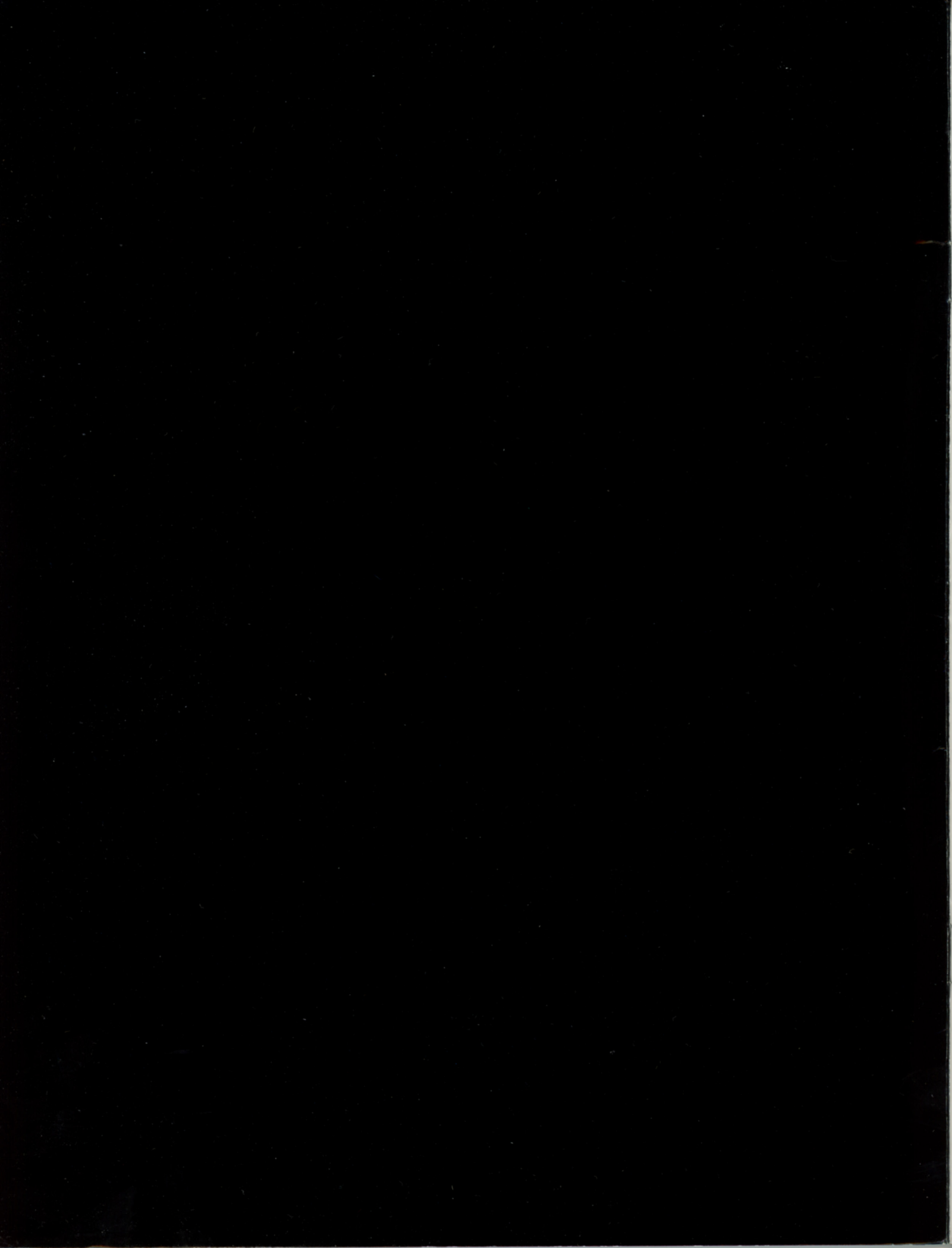

Table of Contents

Introduction	2
---------------------	---

Basic Components	
Paint Colors and Specifications	4
Symbol	5
Symbol/Logotype Arrangements	6
Stripes	7
Marking and De-Marking Techniques	8

Van Trucks	10
Ford—1969 through present	11-14
Ford—1967 and earlier	15-18
Dodge—1971	19-22
Dodge—1970 and earlier	23-26
Chevrolet and GMC—1971	27-30
Chevrolet and GMC—1970 and earlier	31-34

Sedans and Station Wagons	36-37
Suburban Carryall and Panel	38

Trucks with Fixed Bodies	40
Ford	41-42
Chevrolet and GMC	43
Dodge	44
International Harvester	45
Short and Heavy Duty Conventional Cabs	46
Tilt Cabs	48

Tractors and Trailers	
Trailers	50-51
Semi-Tractors	52

Miscellaneous Special Equipment	
Blazer/Bronco/Jeep/Scout	54
Walk-in Vans	55
Splicer Carts	56
Miscellaneous Equipment	57

Legal Load and Weight Numbers	58
Posters and Other Advertising	58
Company Logotype Sizes	59

Introduction

Nowhere will the new Bell System corporate identification program be more in evidence than on our vehicles. Our vehicle fleet is the largest private fleet in the country. Properly marked, each vehicle is a billboard that signals—Bell Company at work. With the higher visibility of the new graphic design, our work trucks will be seen by millions of people each day, and the full extent of our service effort will become better understood.

Not only is our fleet large, it is varied. While the van is our major work vehicle, we operate passenger cars and trucks of every make and description. Marking these many different types of vehicles requires some variations in the application of the new Bell System graphics. But basically our new vehicles will be a bright two-tone design. Vans will be white on top, highly visible, clean and crisp looking. Blue and yellow-ochre stripes band the middle. The bottom is grey-green, on the light side but dark enough to obscure heavy dirt, grime and other road elements. Heavy duty trucks will have all white cabs and grey-green work bodies. The stripes and symbol/logotype unit will be placed on the door.

The purpose of this manual is to provide you with guidelines for painting and marking all operative vehicles in your fleet. Instructions here include current vehicles, trailers and special bodies ordered locally.

In all the demonstrations in this manual, references are made to one, two and three-line logotypes and to logotype sizes coded as A, B, C, etc. For the actual size and line configuration of your company's logotype for each application on each vehicle, refer to the chart on page 59.

Any questions raised, or perhaps not answered by this manual, should be directed to the Plant Operations Manager—Motor Vehicles, AT&T.

Paint Colors and Specifications

Several manufacturers have formulated the special Bell System vehicle colors. They are DuPont, Ditzler, Sherwin-Williams and American Lacquer Solvents. Note: Only the approved colors should be used. Observational Standards for visual matching can be obtained from Western Electric. The representations of the colors on this page must *not* be used for matching. The colors are available in either regular enamel or acrylic enamel. They may be ordered directly from the manufacturers, using the following numbers:

Bell White — DuPont: 7372; Ditzler: 8835; Sherwin-Williams: F10W3177; American Lacquer: 118-933.

Bell Grey-Green — DuPont: 7373; Ditzler: 44210; Sherwin-Williams: F10G3176; American Lacquer: 118-934.

Bell Blue — DuPont: 7374; Ditzler: 14011; Sherwin-Williams: J53570; not available from American Lacquer.

Bell Ochre — DuPont: 7375; Ditzler: 81803; Sherwin-Williams: J53571; not available from American Lacquer.

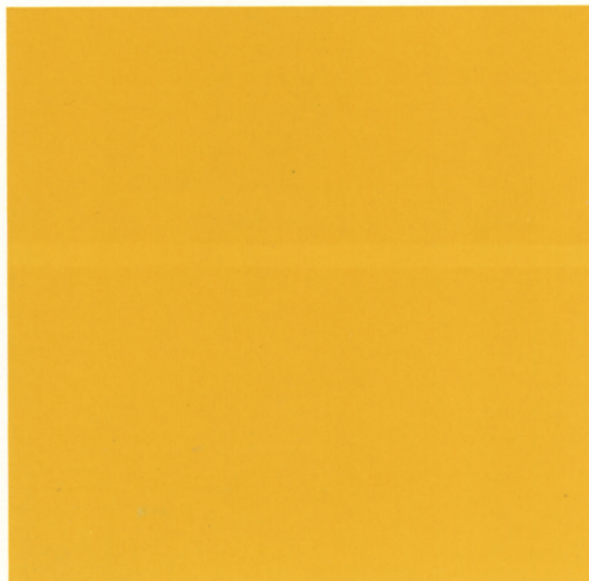
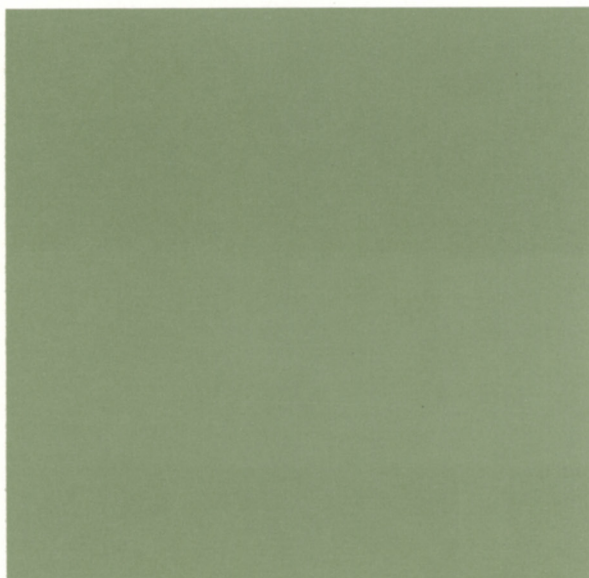
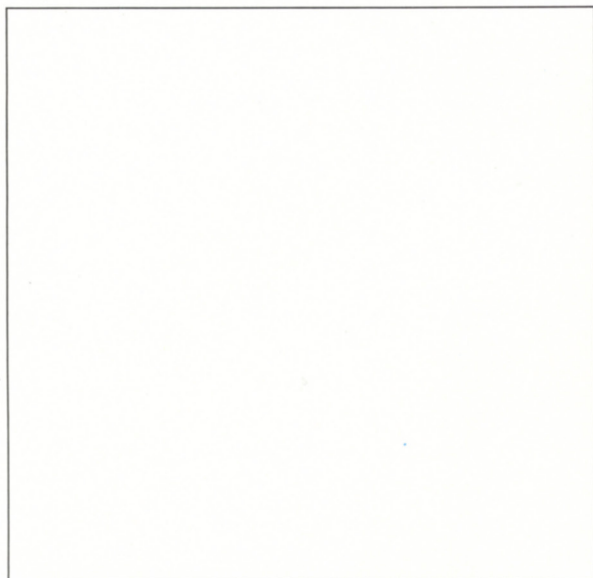

Symbols

The bell symbols that have been produced for vehicle identification are made of blue, pressure-sensitive material. The correct sizes for application on specific vehicles are indicated in the specification drawings under each vehicle type. The symbols are available from Western Electric in the following diameters:

3" 4½" 7" 10" 15½" 21½" 24" 34"

The symbols are die-cut, placed on backing paper and covered with a translucent application tape. The application tape is imprinted with lines for proper positioning and alignment with company logotypes.











Symbol/Logotype Arrangements

Because of the variations in body configurations of different vehicles, and in particular those areas which may be used for identification, symbol/logotype arrangements have been designed especially for Bell System vehicles.

Company logotypes are supplied in a black, pressure-sensitive material. They are on a backing sheet covered with application tape. As with the bell symbols, the application tape is imprinted with lines for proper aligning and positioning. When using a flush-left symbol/logotype arrangement—such as shown below in illustrations B, C, E, F, H and J—the alignment mark $4\frac{1}{2}$ " from the left edge of the logotype is lined up

with the center-line on the bell symbol. Where no alignment mark appears on the logotype application tape, align the left edge of the logotype mechanically with the left outside edge of the bell symbol.

Each company logotype has been specifically tailored for use in the vehicles program. Letter spacing and multiple-line arrangements have been added where required. The letter spacing, word spacing, line spacing and line arrangements may not be altered in any way. Sizes of the letters have been determined for each System company, for each vehicle. These sizes are detailed in Plant Letter 2378-4, Topical Index 2F4. They are shown in this manual on page 59.

<p>A</p> 	<p>B</p> <p>Ohio Bell</p> 	<p>C</p>  <p>Ohio Bell</p>
<p>D</p> 	<p>E</p> <p>Pacific Telephone</p> 	<p>F</p>  <p>Pacific Telephone</p>
<p>G</p> 	<p>H</p> <p>Southern New England Telephone</p> 	<p>J</p>  <p>Southern New England Telephone</p>

Stripes

The stripes for use on vehicles are also made of pressure-sensitive material. They are supplied in sets for each manufacturer's van model in specific widths, with die-cut sections for curved areas and to fit around door handles, hinges, etc. For ordering information see Plant Letter 2378-5, Topical Index 2F4.

Striping is also available in 50-foot rolls for use on truck cabs, passenger cars, station wagons, pickup trucks and numerous other vehicle types for which die-cut sets are unnecessary. Only one size is available: 2 $\frac{3}{4}$ " blue, 1 $\frac{3}{8}$ " space, 2 $\frac{5}{8}$ " ochre. These are prespaced on application tape.

In the diagrams below, you will notice that the blue stripe is slightly wider than the ochre. The adjustment has been made because the blue color tends to visually contract; its slightly larger size makes it *appear* equal to the ochre.

In a horizontal context, the blue stripe *always appears on top*. When the stripes are applied longitudinally, such as on sedans, the blue is always on the *passenger* side.

In instances where stripes are to be painted, the paints described on page 4 must be used. However, the specifications for stripe size and placement, as detailed for the individual vehicle type, must be followed exactly.

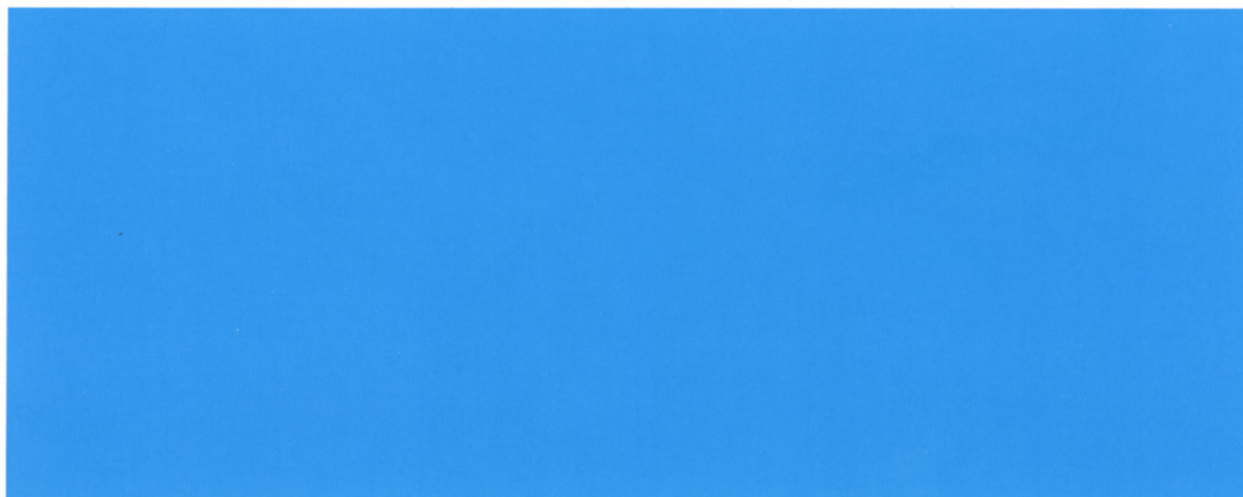

Marking and De-Marking Techniques

Detailed instructions for the application of all marking materials can be found in Bell System Practices, Section #720-030-010, Issue 2. Any special problems or questions should be directed to the Plant Operations Manager—Motor Vehicles, AT&T.

The pictures below are examples of the application instructions. It is extremely important that these instructions be followed faithfully. Properly applied, the materials are both handsome and highly permanent; improperly applied, they will not adhere well and may break, chip or come off entirely.

It is equally important that careful attention be given to placement and alignment specifications. The detailed

placement specifications in this manual, combined with the lines imprinted on the application tapes of the symbols and logotypes, provide the means for applying all materials accurately, consistently and neatly.

When Bell System vehicles are traded-in or sold, it is extremely important that all bell symbols and logotypes be completely removed. Stripes may be removed or obliterated.

Any one of the following three methods should be used: (1) Sand down to bare metal with a sanding machine. (2) Soften identification material with a heat-gun and scrape off with a putty knife. (3) Cold paint stripper will also soften identification material which can then be scraped off with a putty knife.

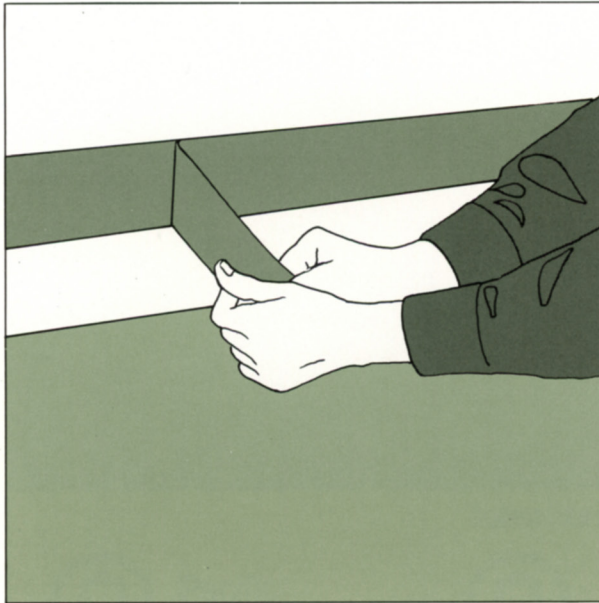

Van Trucks

There are more van trucks in the Bell System fleet than any other vehicle. Their size and shape make them "rolling billboards." This high visibility makes the van very important in the Bell System corporate identification program. So, to mark each model most effectively — as well as to retain the visual relationship among all models — specific designs have been developed for vans of each manufacturer. Consequently, it is important that these specifications be followed precisely — regardless of what may appear to be *similar* dimensions from model to model.

You will notice in all van drawings there is a broken line running through the ochre stripe. This indicates the butting of white and grey-green paints. Since these two painted colors are always separated by the ochre stripe, the precise point of butting is not critical. However, it is important that the juncture occur *well within the width of the ochre stripe*. Do not attempt to align the paint juncture with either edge of the stripe.

On all vans, the wheels, wheel covers and bumpers are to be painted grey-green. Ladder racks and other permanently attached equipment on the top are to be painted white. Vehicle number placement is shown and specified on each vehicle. Other numbers, such as gross weight, maximum load, etc., are required by some states. Specifications for size, style and placement of these appear on page 58.

For the appropriate size and line configuration of your company's logotypes for this vehicle type, refer to the chart on page 59.

Ford—1969 through present

A—Left side, enclosed, with one-line logotype

B—Left side, enclosed, with two-line logotype

All logotypes are horizontally centered on the bell symbol. Application tapes for both the symbol and logotypes provide centerlines for this alignment. The length of logotype varies from company to company. However, the dimensions given from logotype to the bell symbol, and from logotype to rear coach seam *do not change*, regardless of the length of your company's logotype.

C—Left side, windowed version, with one-line logotype

The dimension given from symbol to logotype *does not change*, regardless of the length of your company's logotype. For locating multiple-line logotypes, align the horizontal centerline on the logotype application sheet with the horizontal centerline of the bell symbol. Note: Symbol and logotype for windowed left side are identical in size to those provided for right sides.

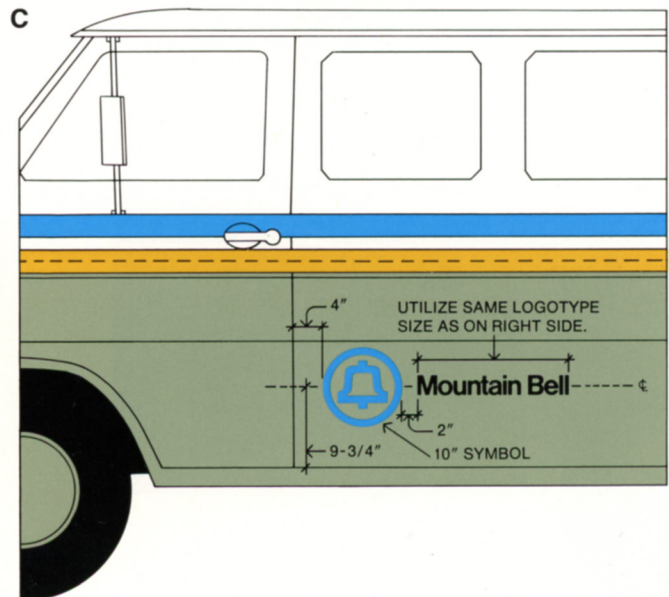
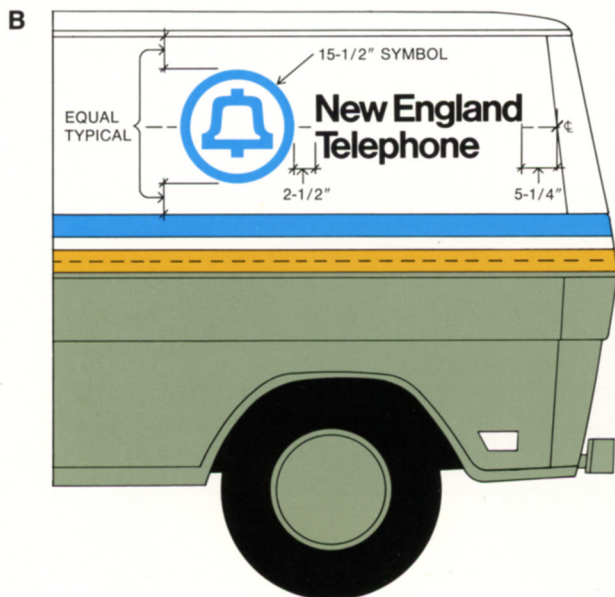
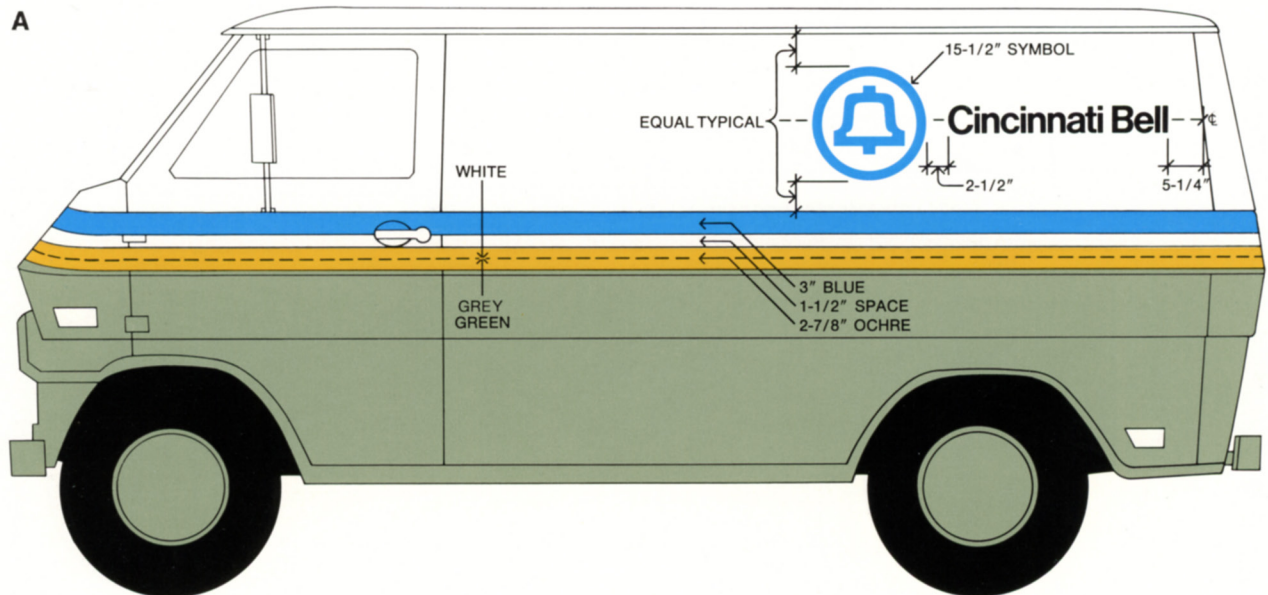

Ford — 1969 through present

- A — Right side with one-line logotype
- B — Right side with two-line logotype
- C — Right side with three-line logotype

The location of the bell symbol is identical for all companies. Also, the distance from the logotype to the door seam is identical for all companies.

All logotypes, regardless of their number of lines, are centered horizontally on the symbol; align the horizontal centerline on the logotype application sheet with the centerline of the bell symbol.

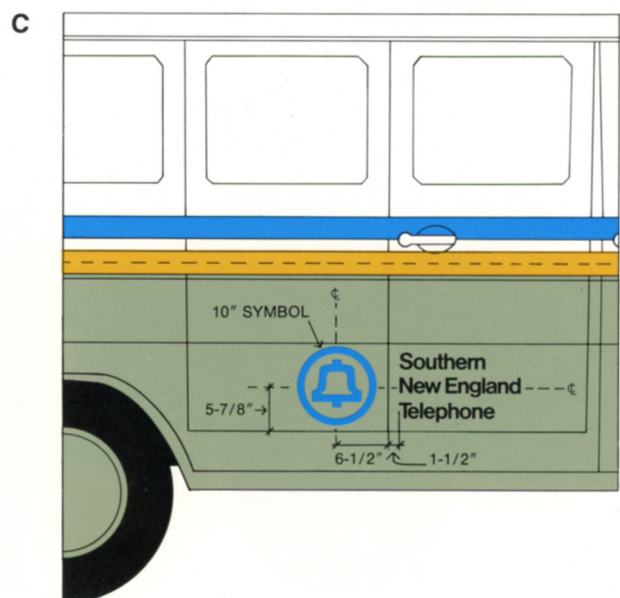
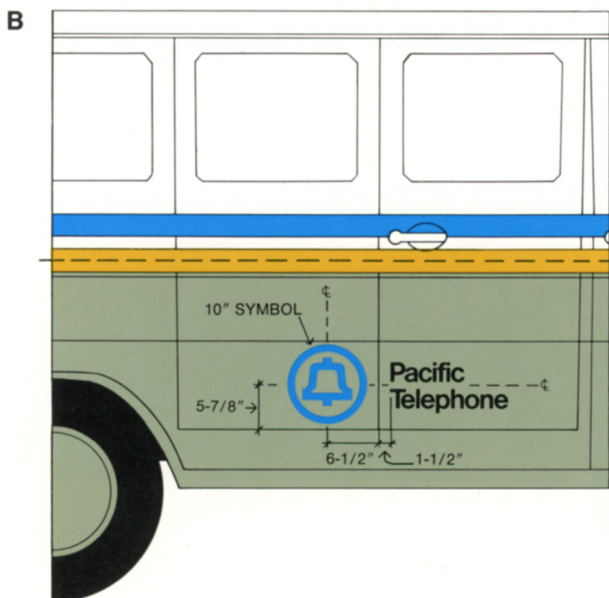
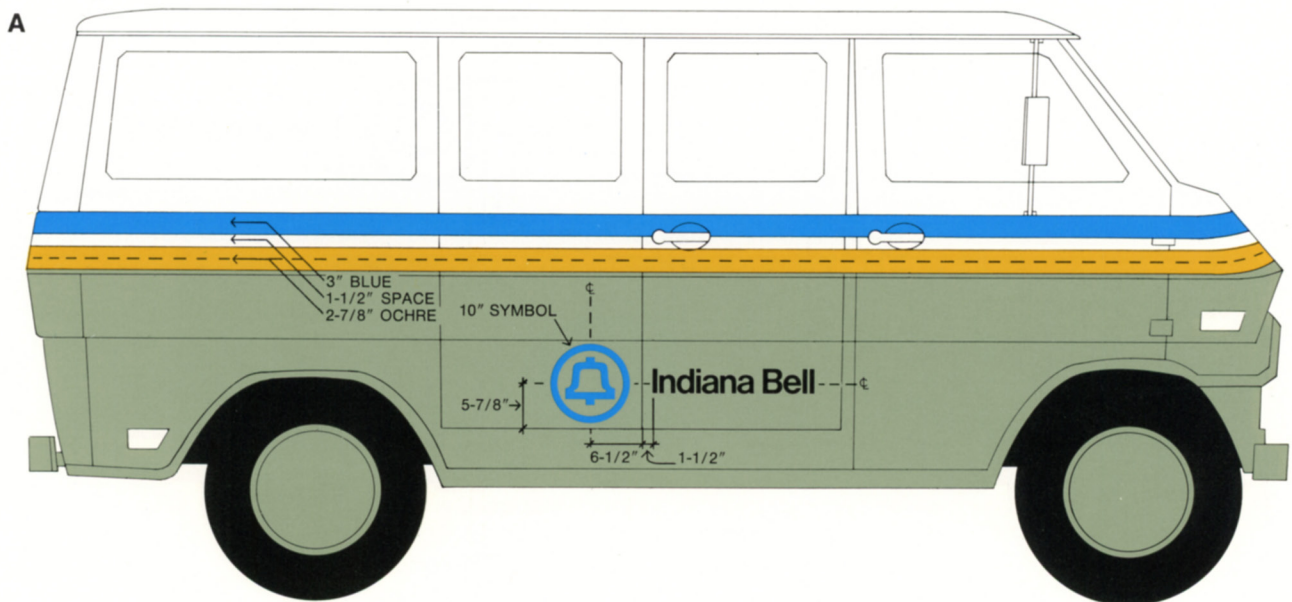

Ford — 1969 through present

A—Top with bell symbol

The use of the bell symbol on the roof, as indicated, is optional in instances where dome lights or other equipment are not required. In urban areas where the bell symbol on the roof is more likely to be seen from buildings, this strong secondary identification will be of value.

B—Front with stripes only. No further identification.

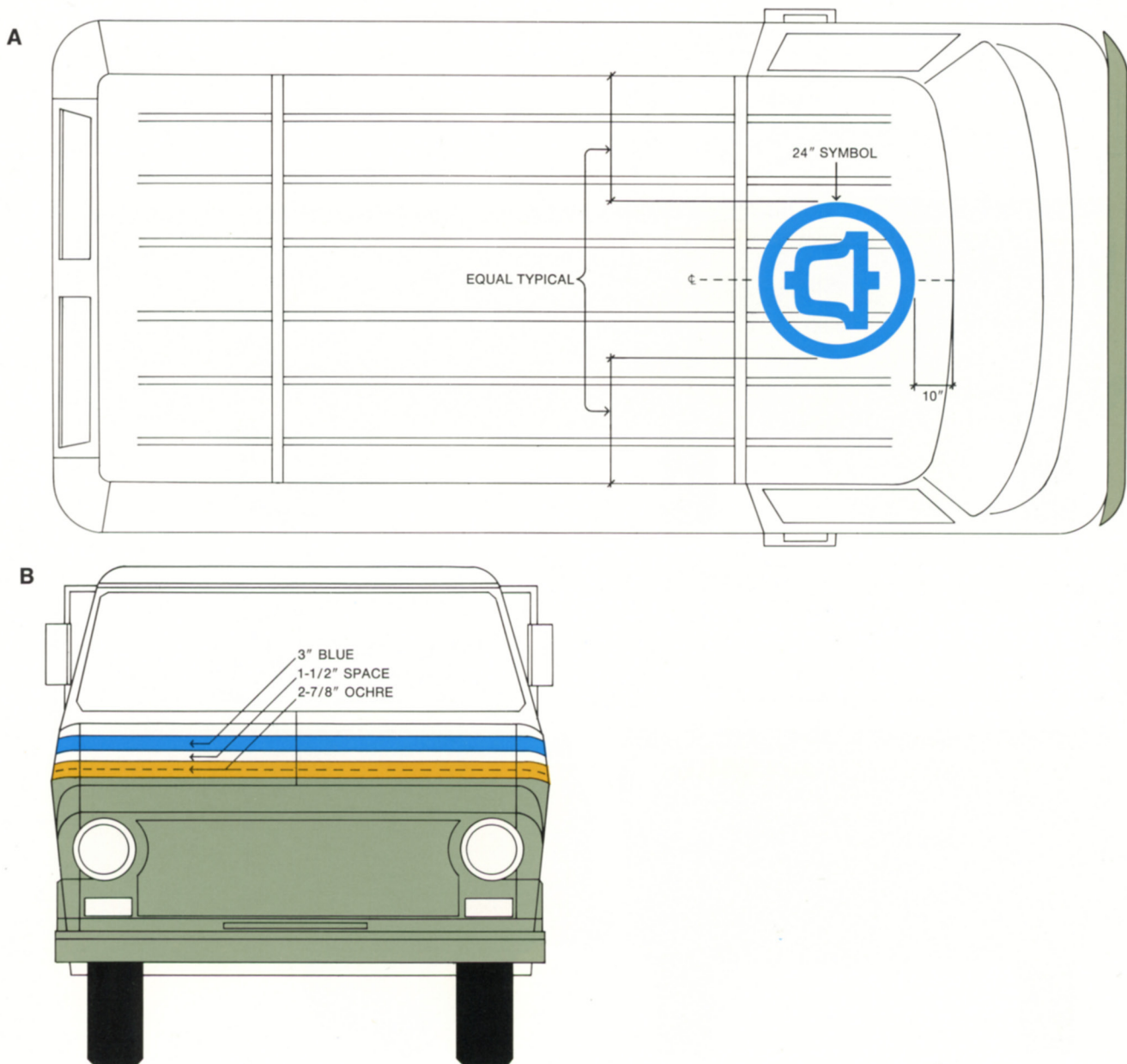

Ford—1969 through present

A—Rear with one-line logotype

B—Rear with two-line logotype

C—Rear with three-line logotype

You will note that the *horizontal* locating dimension for the bell symbol in B and C is greater than A. This adjustment has been made to allow logotypes of more than one line to avoid the door lock. The *vertical* location of the bell symbol is identical for all companies.

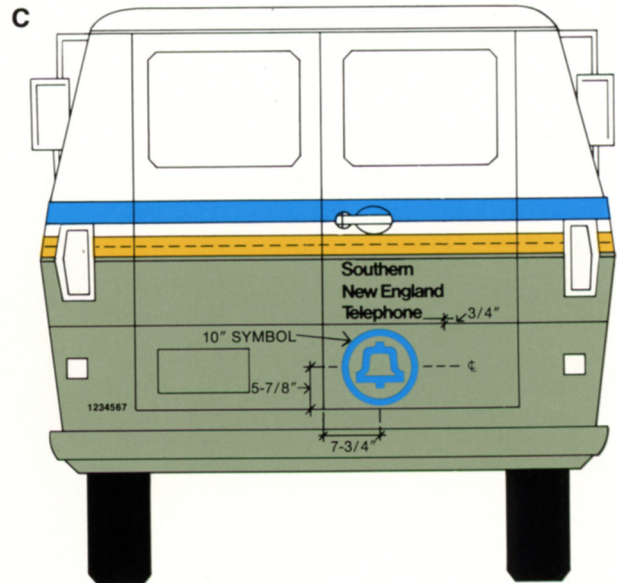
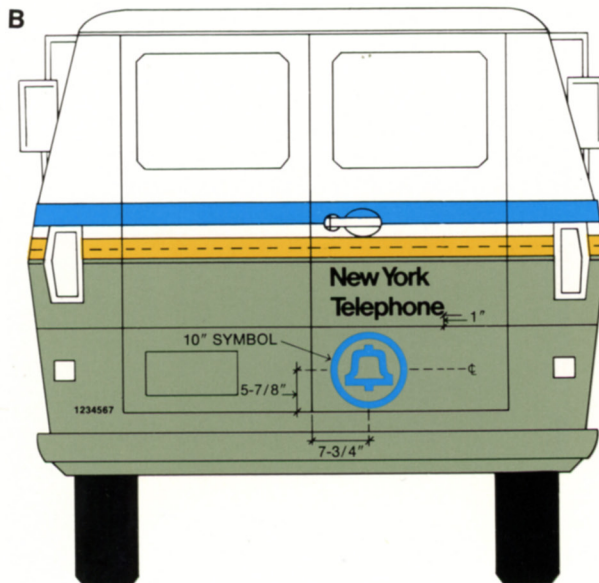
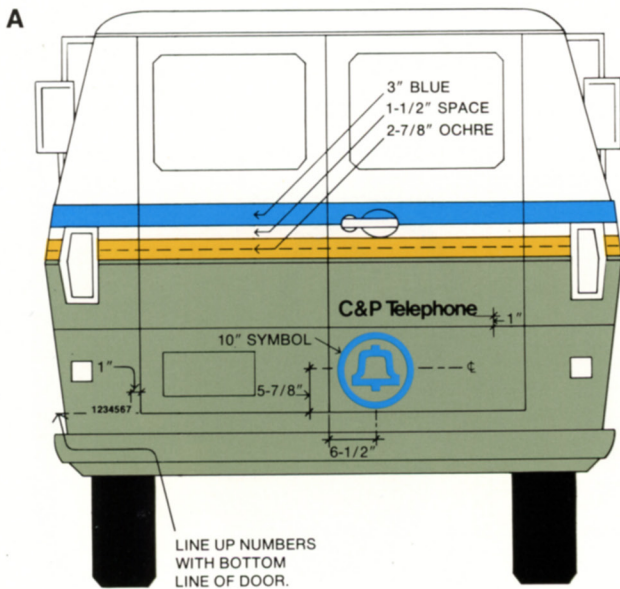

Guidelines for painting and marking:
124" wheelbase and 138" wheelbase Ford Vans —
with hinged doors, sliding doors, enclosed sides or
windowed sides.

Important: Insert into Vehicle Graphics Manual, follow-
ing page 14.

A—Left side, enclosed, with one-line logotype

B—Left side, enclosed, with two-line logotype

All logotypes are horizontally centered on the bell symbol. Application tapes for both the symbol and logotypes provide centerlines for this alignment. The length of logotype varies from company to company. However, the dimensions given from logotype to the bell symbol, and from logotype to rear coach joint *do not change*, regardless of the length of your company's logotype.

C—Left side, windowed version, with one-line logotype

The dimension given from symbol to logotype *does not change*, regardless of the length of the company logotype. For locating multiple-line logotypes, align the horizontal centerline on the logotype application sheet with the horizontal centerline of the bell symbol. Note: Symbol and logotype for windowed left side are identical in size to those provided for windowed right sides.

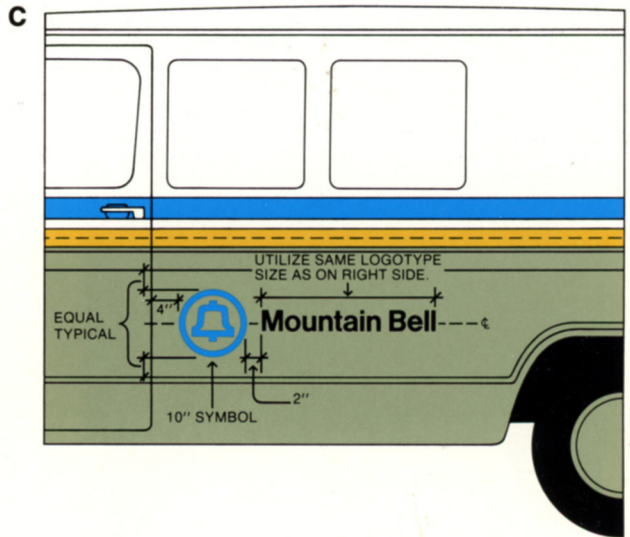
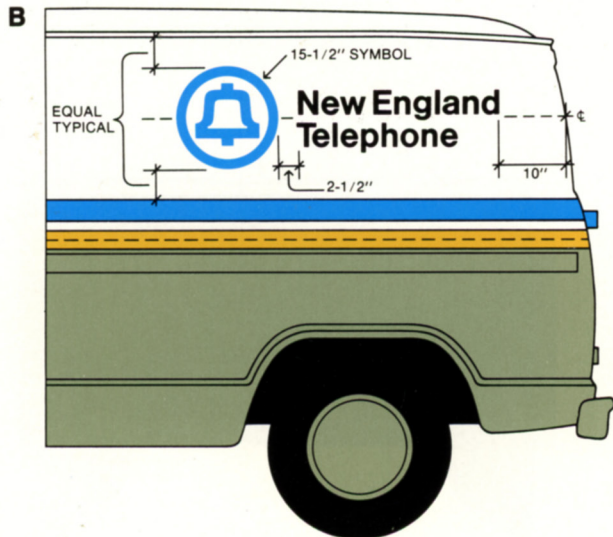
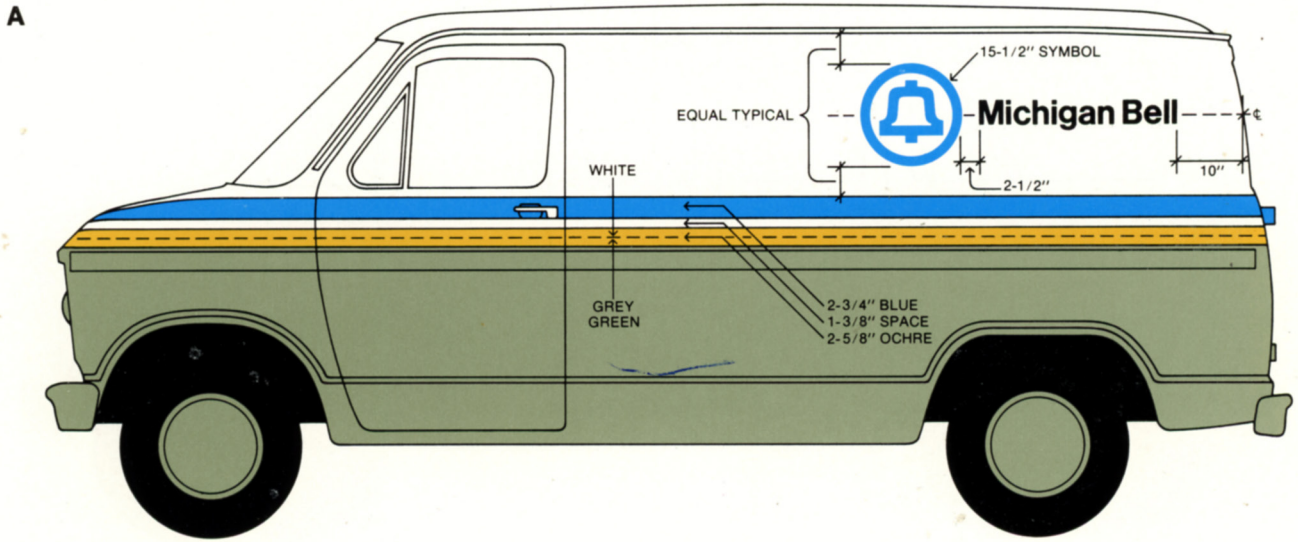

1975 Ford Van – with Hinged Doors

A – Right side with one-line logotype

B – Right side with two-line logotype

C – Right side with three-line logotype

The location of the bell symbol is identical for all companies. Also, the distance from the logotype to the door edge is identical for all companies.

All logotypes, regardless of their number of lines, are centered horizontally on the symbol; align the horizontal centerline on the logotype application sheet with the centerline of the bell symbol.

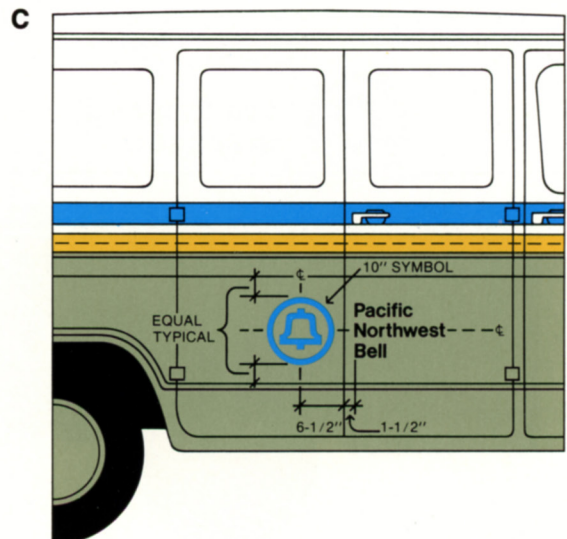
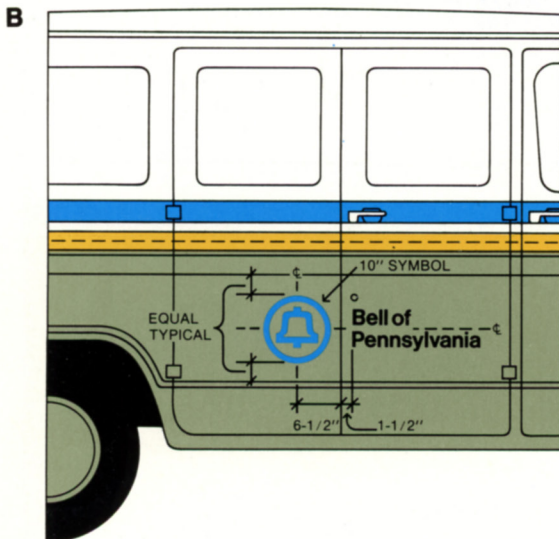
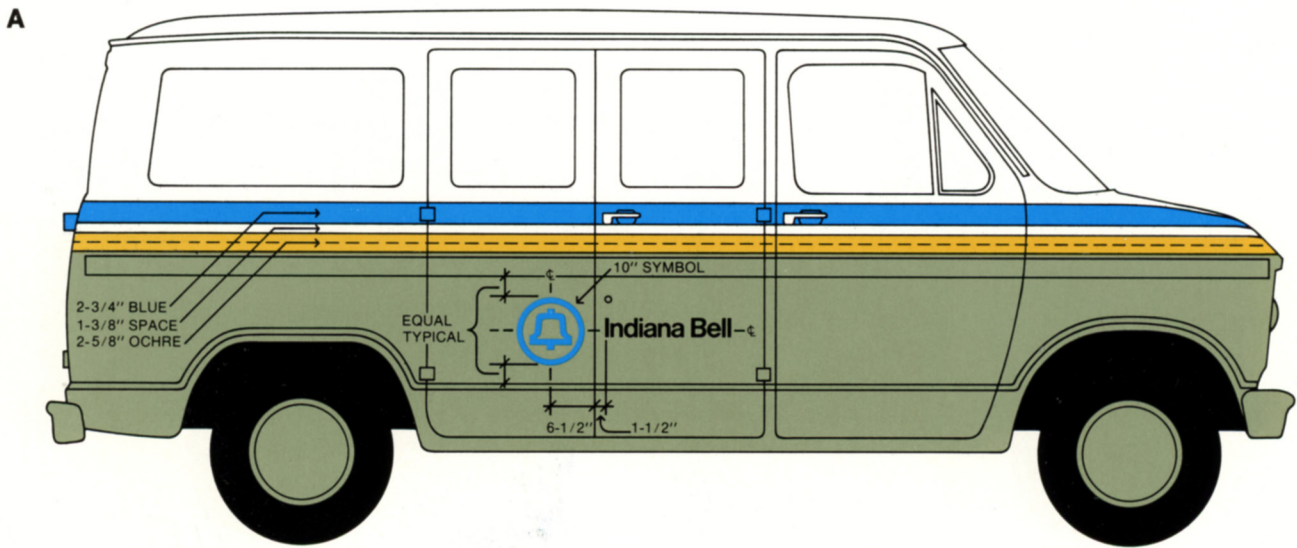

1975 Ford Van – with Sliding Door

A – Right side with one-line logotype

B – Right side with two-line logotype

C – Right side with three-line logotype

The location of the bell symbol is identical for all companies.

All logotypes, regardless of number of lines, are centered horizontally on the bell symbol; align the horizontal centerline on the logotype application sheet with the horizontal centerline of the bell symbol.

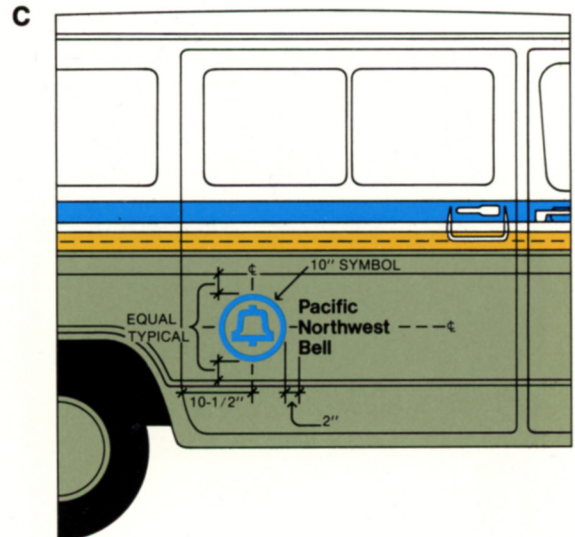
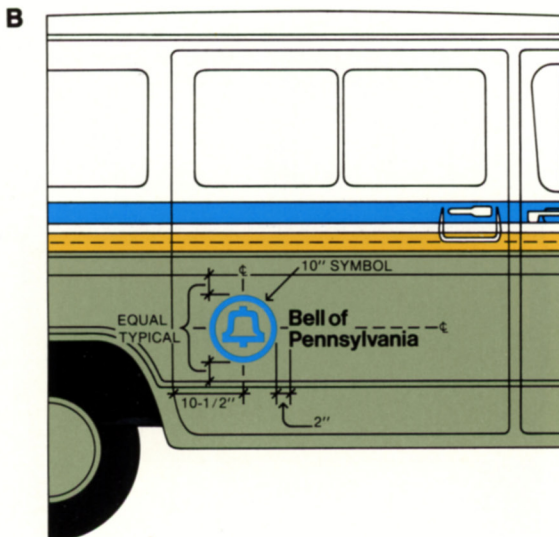
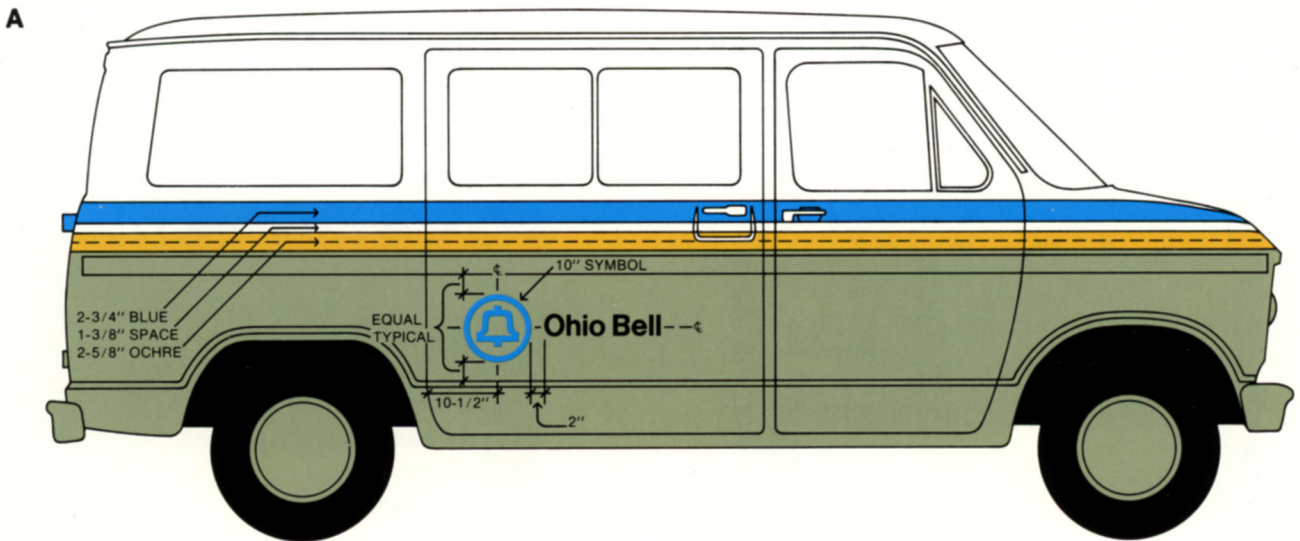

1975 Ford Van

- A—Front with partial stripes—no further identification
- B—Rear with one-line logotype
- C—Rear with two-line logotype
- D—Rear with three-line logotype

The location of the bell symbol is identical for all companies. The distance from the logotype to the door edge is identical for all companies. All logotypes are centered horizontally on the bell symbol; align the horizontal centerline on the logotype application sheet with the horizontal centerline of the bell symbol. The Ford logotype on the rear door has been removed to accommodate the Bell System logotype. Specify removal of the Ford logotype when ordering the Van from the dealer.

Important: Regarding three-line logotypes to be applied to rear surfaces of the 1975 Ford Econoline Van, the capital letter height has been increased from 1-3/4" (as indicated on the chart on page 59 of your Bell System Vehicle Graphics Manual) to 2". Follow specifications as shown on the chart for all other logotypes. Any questions raised, or not answered by this supplement, should be directed to: Manager—Motor Vehicles, Customer Services, AT&T.

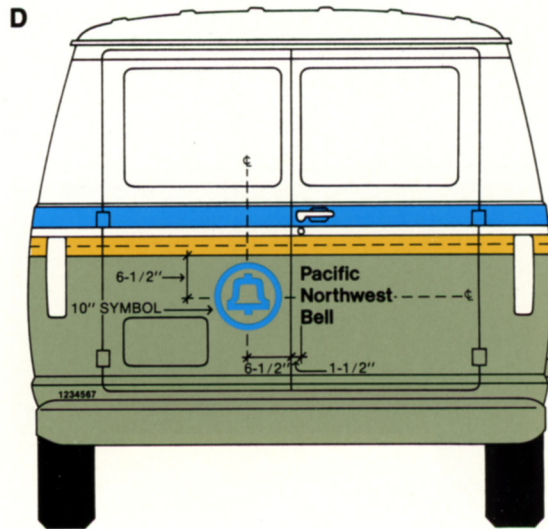
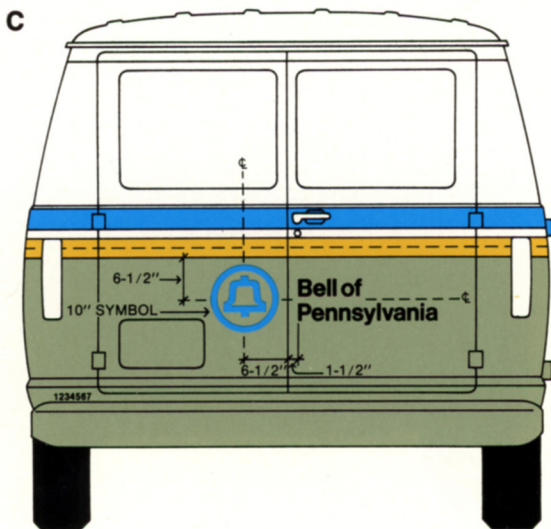
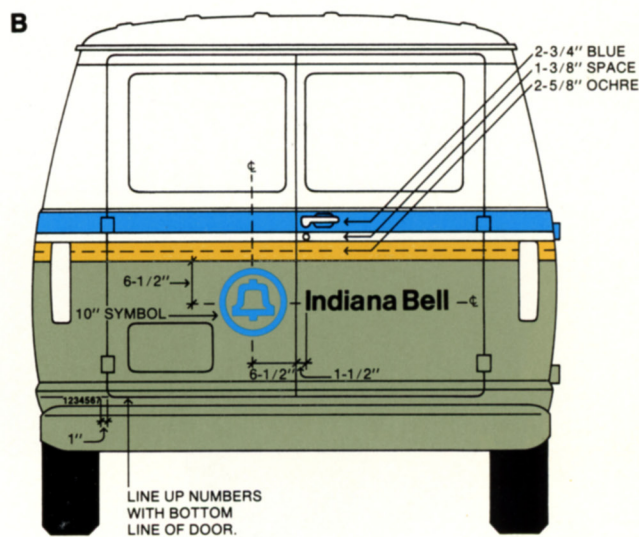
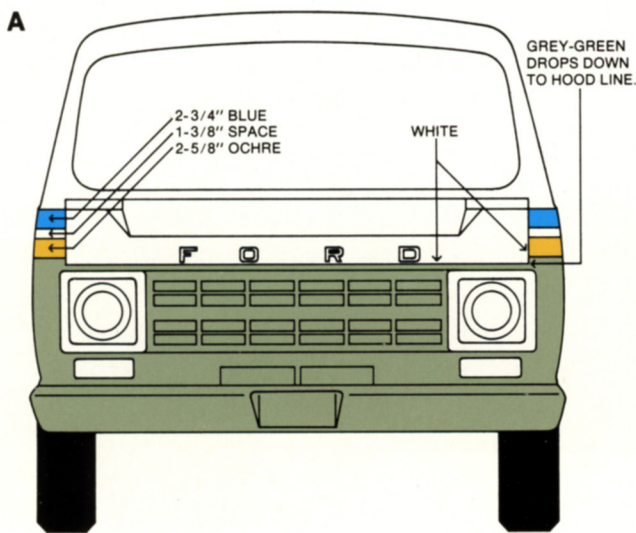

Ford—1967 and earlier

A—Left side, enclosed, with one-line logotype

B—Left side, enclosed, with two-line logotype

The length of the logotype varies from company to company. However, the dimensions given from the logotype to the bell symbol, and from the logotype to the rear coach seam *do not change*, regardless of the length of a company's logotype. For supervans, the dimension from the logotype to the rear coach seam becomes 2" for all companies.

C—Left side, windowed version, with one-line logotype

The dimension given from symbol to logotype *does not change*, regardless of the length of your company's logotype. For locating multiple-line logotypes, align the horizontal centerline on the logotype application sheet with the horizontal centerline of the bell symbol. Note: Symbols and logotypes for windowed left side are identical in size to those provided for right sides.

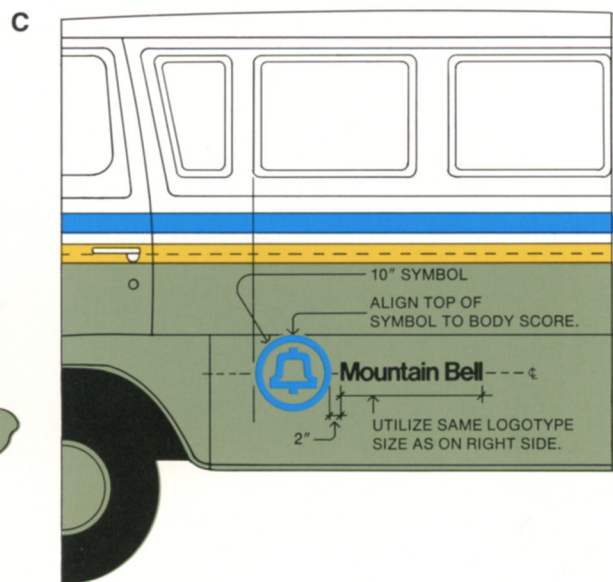
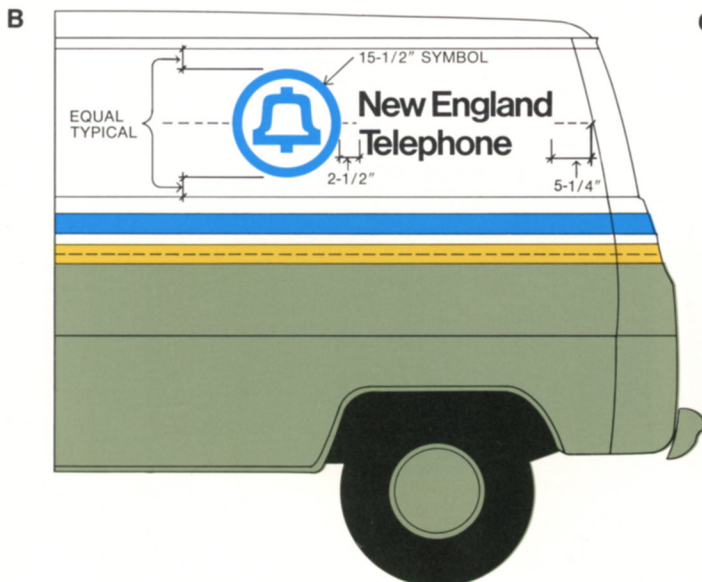
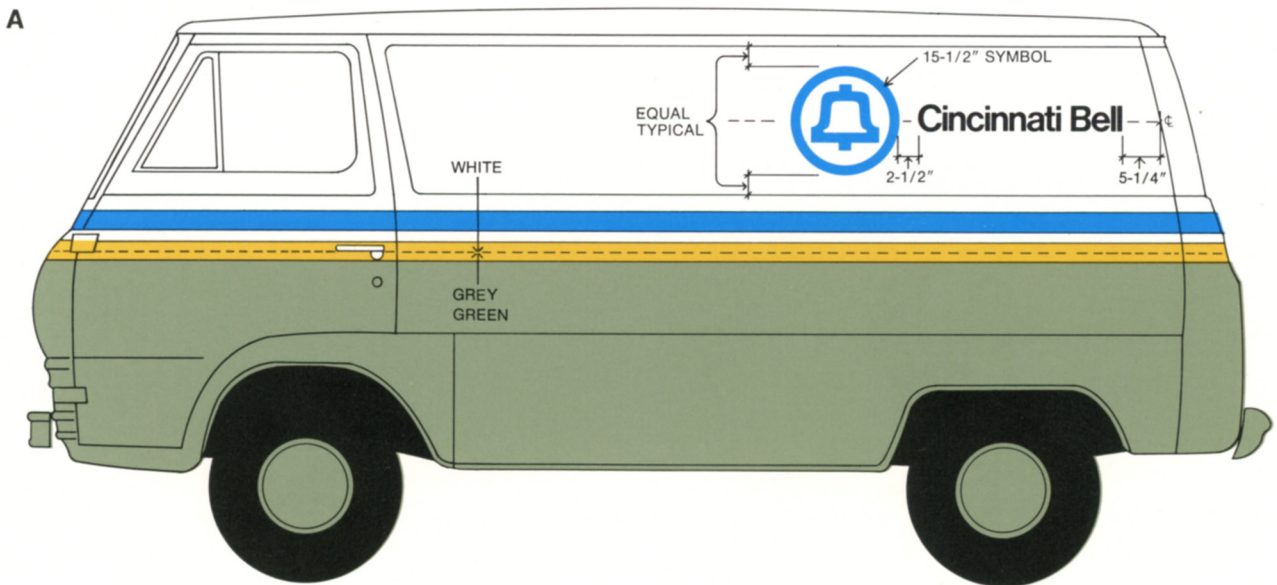

Ford—1967 and earlier

- A—Right side with one-line logotype
- B—Right side with two-line logotype
- C—Right side with three-line logotype

The location of the bell symbol is identical for all companies. Also, the distance from the logotype to the door seam is identical for all companies.

All logotypes, regardless of number of lines, are centered horizontally on the bell symbol; align the horizontal centerline on the logotype application sheet with the horizontal centerline of the bell symbol.

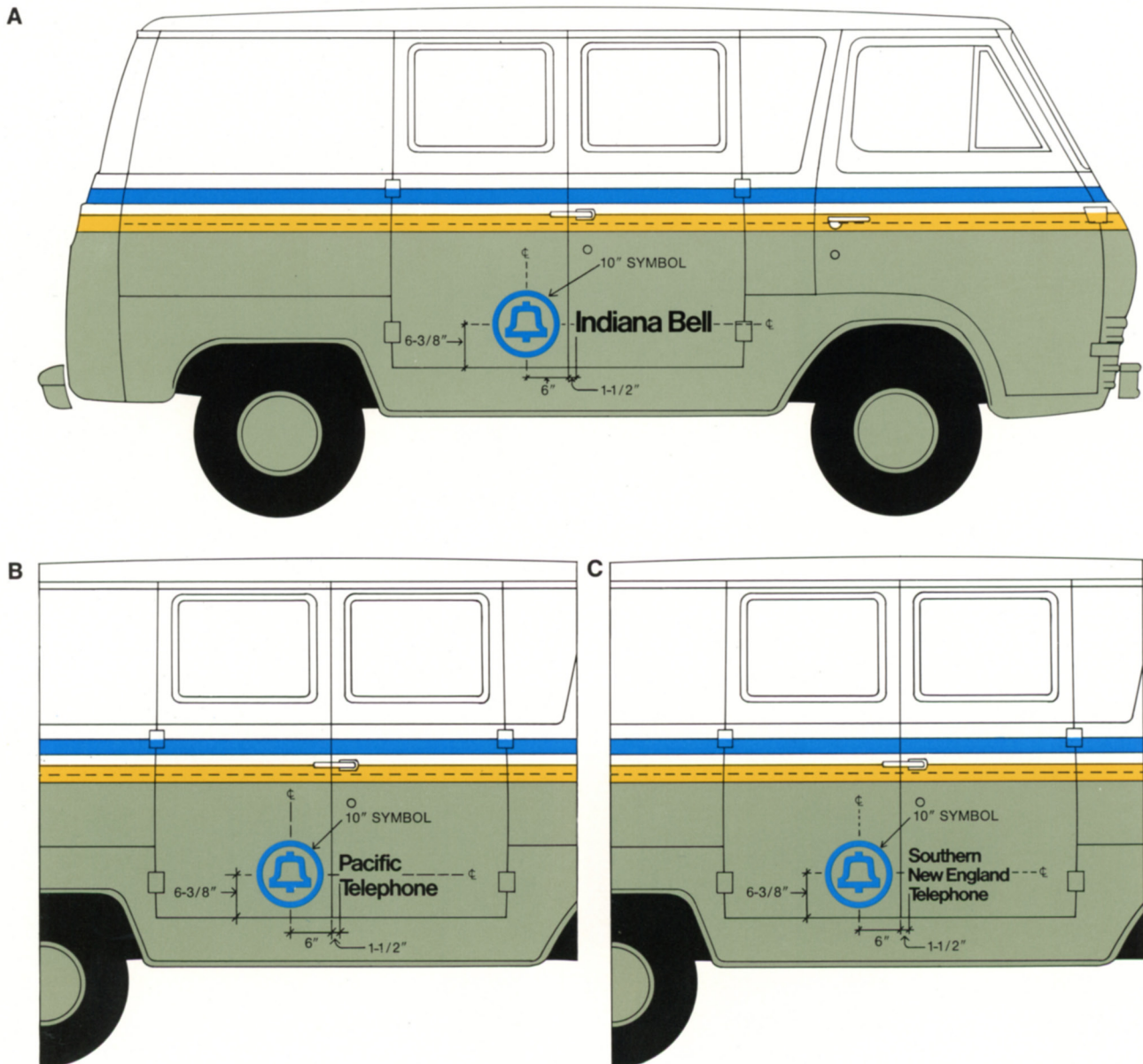

Ford—1967 and earlier

A—Top with bell symbol

The use of the bell symbol on the roof, as indicated, is optional in instances where dome lights or other equipment are not required. In urban areas where the bell symbol on the roof is more likely to be seen from buildings, this strong secondary identification will be of value.

B—Front with stripes only. No further identification.

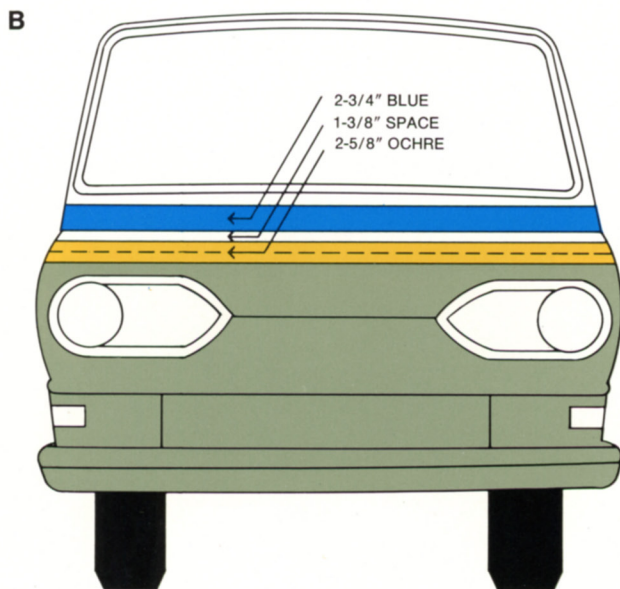
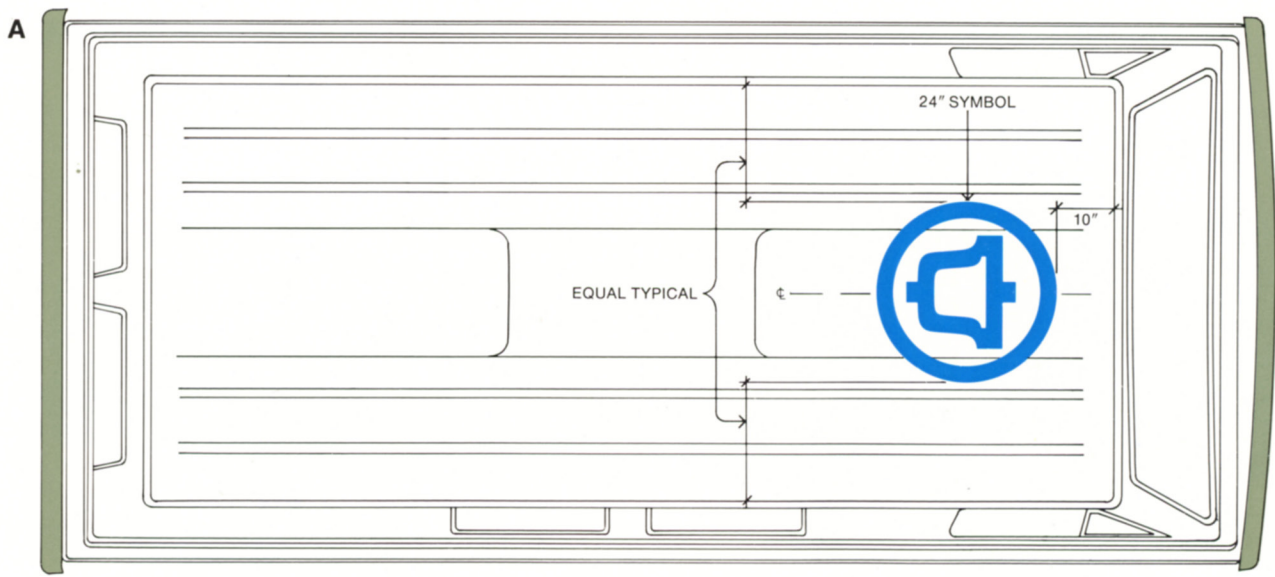

Ford—1967 and earlier

- A—Rear with one-line logotype
- B—Rear with two-line logotype
- C—Rear with three-line logotype

You will note that the *horizontal* locating dimension for the bell symbol in B and C is greater than A. This adjustment has been made to allow logotypes of more than one line to avoid the door lock. The *vertical* location of the bell symbol is identical for all companies.

In these flush-left symbol/logotype arrangements, the logotype is aligned with the symbol circle in the manner described on page 6.

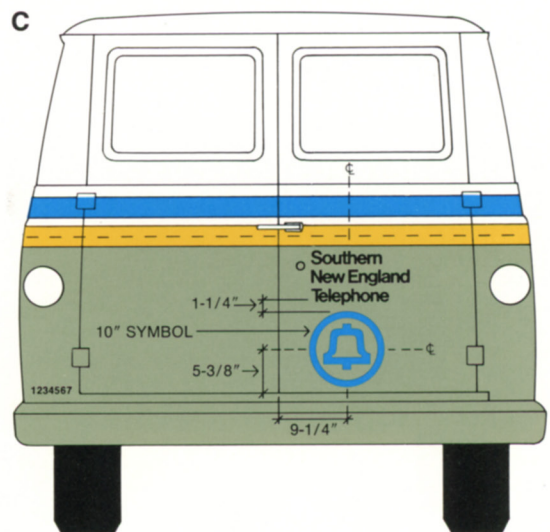
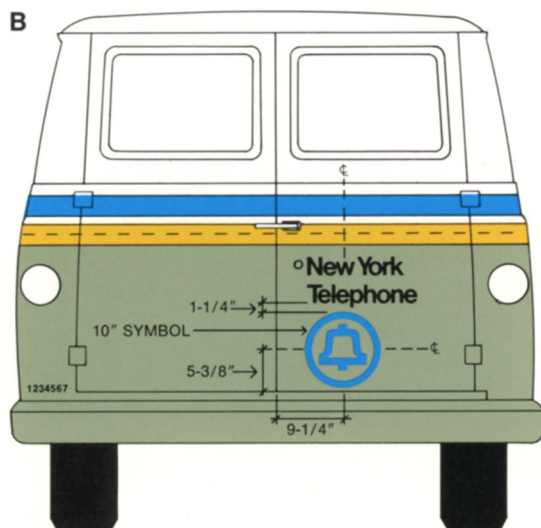
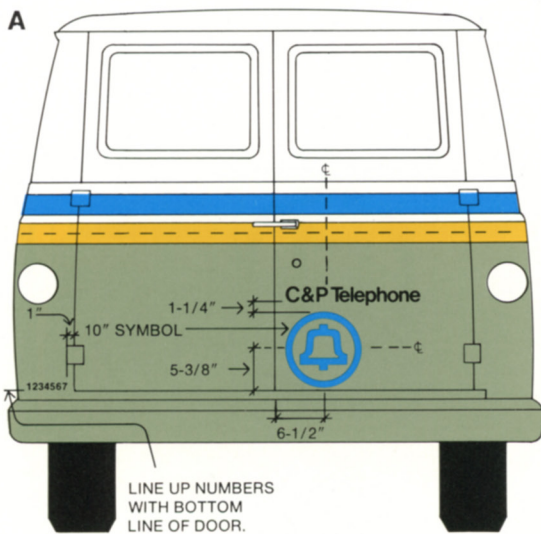

Dodge—1971

A—Left side, enclosed, with one-line logotype

B—Left side, enclosed, with two-line logotype

All logotypes are horizontally centered on the bell symbol. Application tapes for both the symbol and logotypes provide centerlines for this alignment. The length of logotype varies from company to company. However, the dimensions given from logotype to the bell symbol, and from logotype to rear coach seam do *not change*, regardless of the length of your company's logotype.

C—Left side, windowed version, with one-line logotype

The dimension given from symbol to logotype *does not change*, regardless of the length of your company's logotype. For locating multiple-line logotypes, align the horizontal centerline on the logotype application sheet with the horizontal centerline of the bell symbol. Note: Symbol and logotype for windowed left side are identical in size to those provided for right sides.

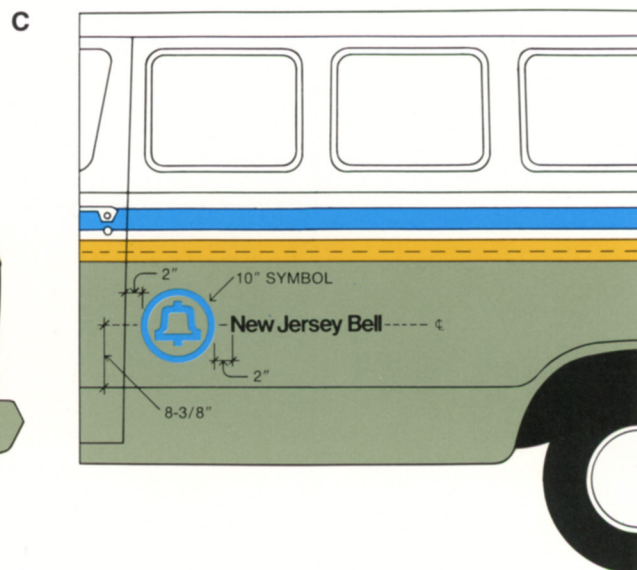
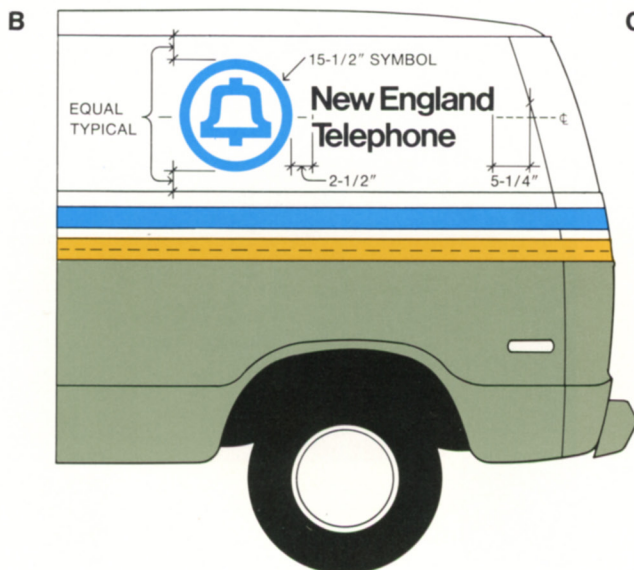
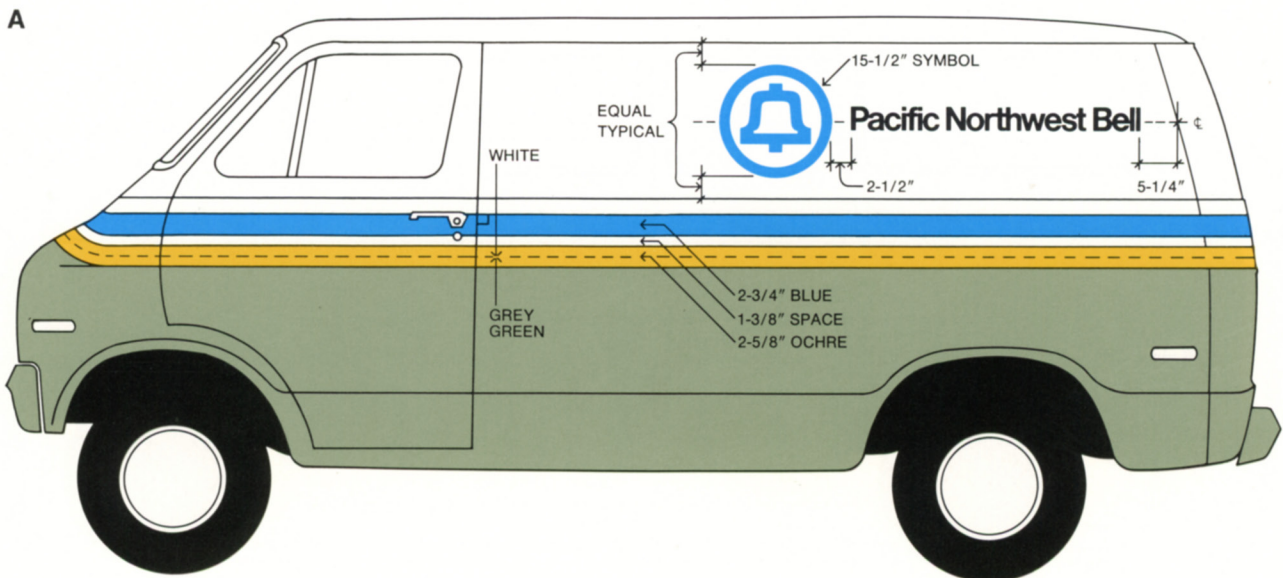

Dodge—1971

- A—Right side with one-line logotype
- B—Right side with two-line logotype
- C—Right side with three-line logotype

The location of the bell symbol is identical for all companies. Also, the distance from the logotype to the door seam is identical for all companies.

All logotypes, regardless of their number of lines, are centered horizontally on the symbol; align the horizontal centerline of the logotype on the logotype application sheet with the centerline of the bell symbol.

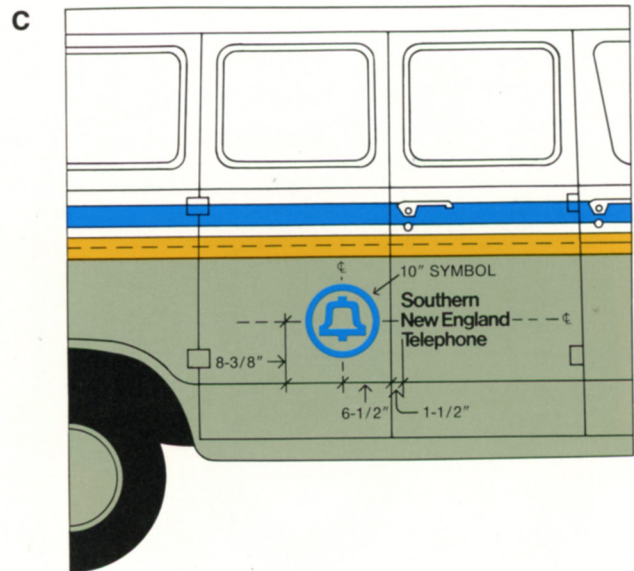
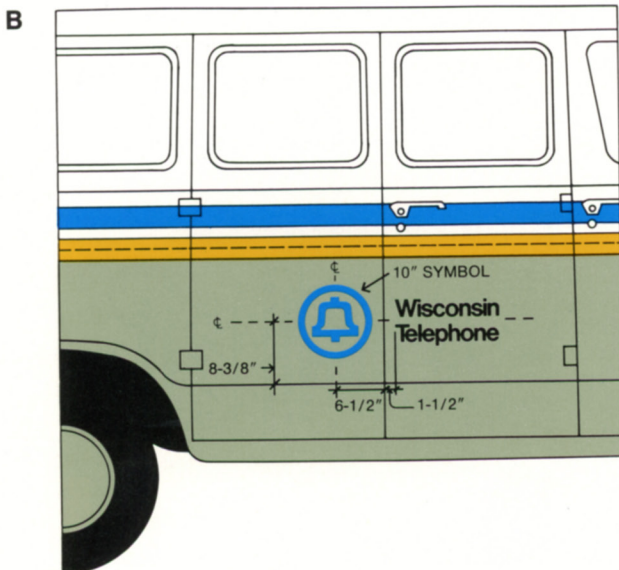
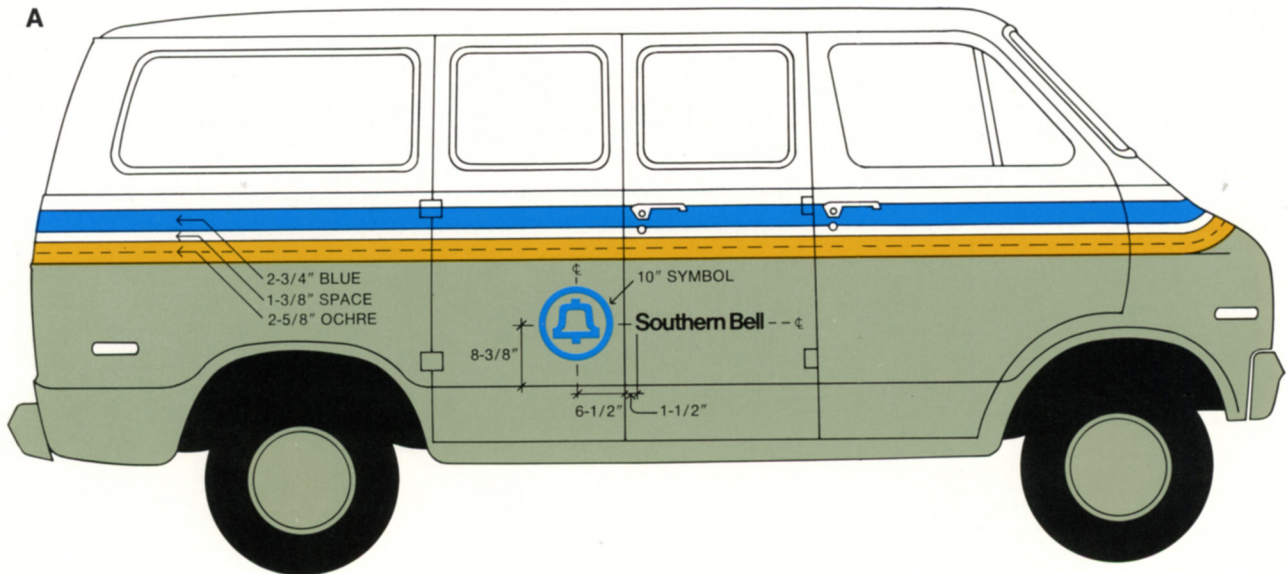

Dodge—1971

A—Top

Due to the heavy corrugations on the roof of this vehicle, it is not recommended that bell symbols be applied.

B—Front with stripes only. No further identification.

A

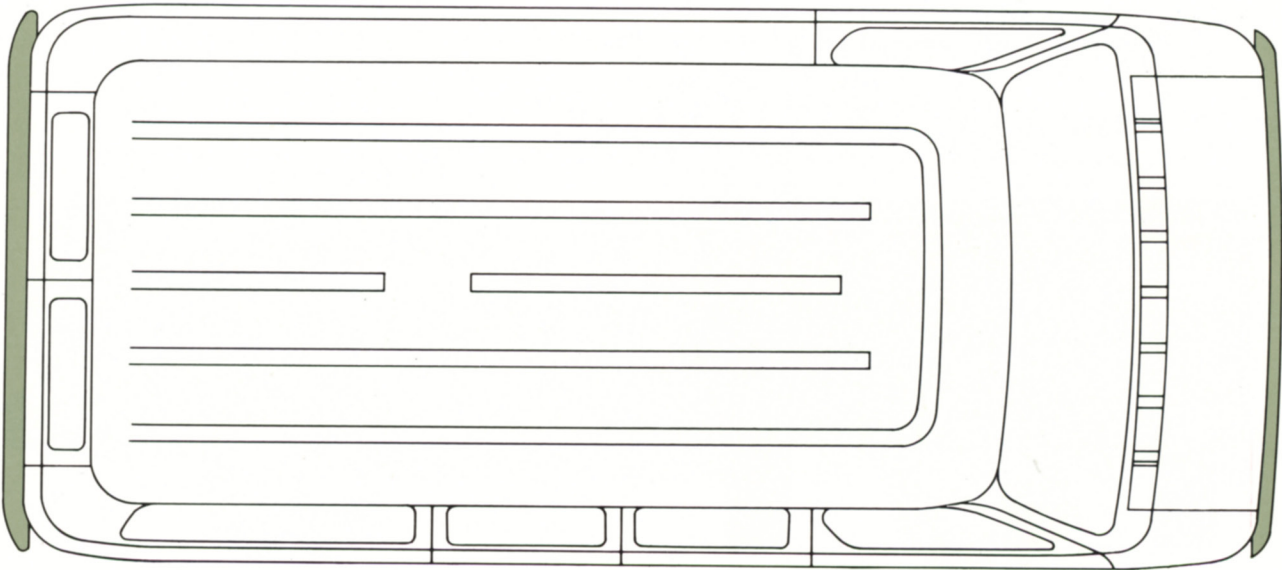

B

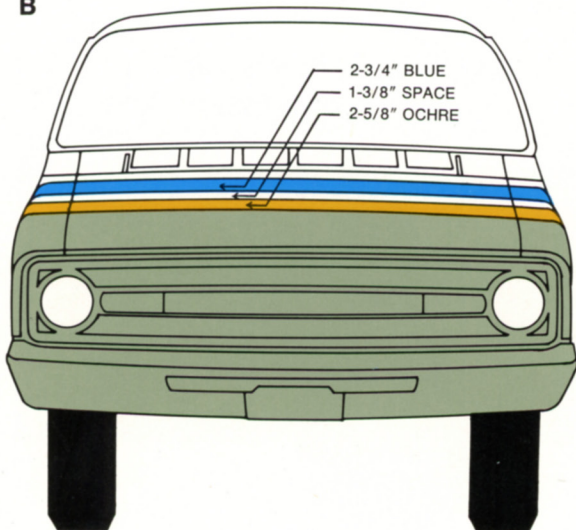

Dodge—1971

A—Rear with one-line logotype

B—Rear with two-line logotype

The dimensions given for locating Symbol / logotype units are identical for all companies, regardless of the number of lines the logotype contains.

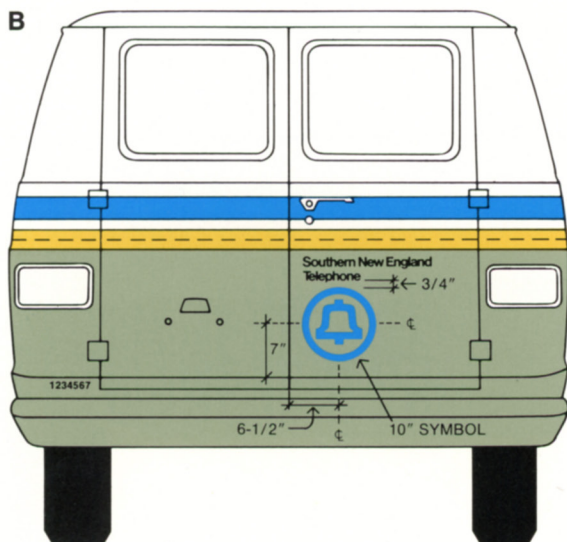
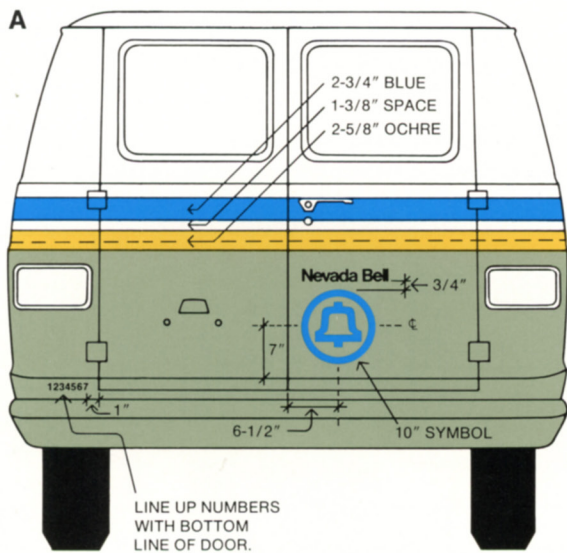

Dodge – 1970 and earlier

A—Left side, enclosed, with one-line logotype

B—Left side, enclosed, with two-line logotype

All logotypes are centered horizontally on the bell symbol. Application sheets for both the symbol and logotypes provide centerlines for this alignment.

The length of the logotype varies from company to company. However, the dimensions given from logotype to the bell symbol, and from logotype to the rear coach seam *do not change* regardless of the length of your company's logotype.

C—Left side, windowed version, with one-line logotype.

The dimension given from symbol to logotype *does not change*, regardless of the length of your company's logotype.

For locating multiple-line logotypes, align the horizontal centerline on the logotype application sheet with the horizontal centerline of the bell symbol. Note: Symbol and logotype for windowed left side are identical in size to those provided for right sides.

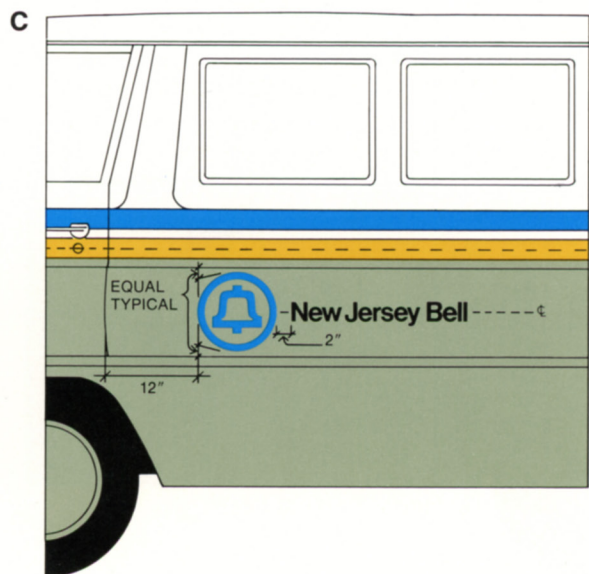
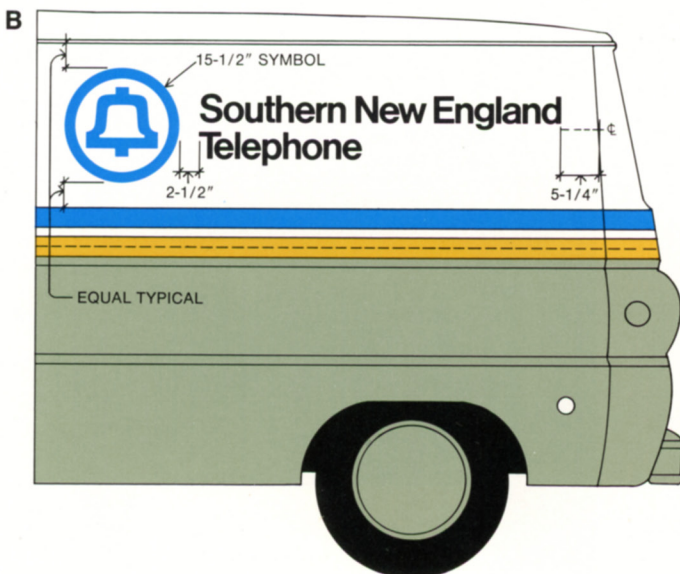
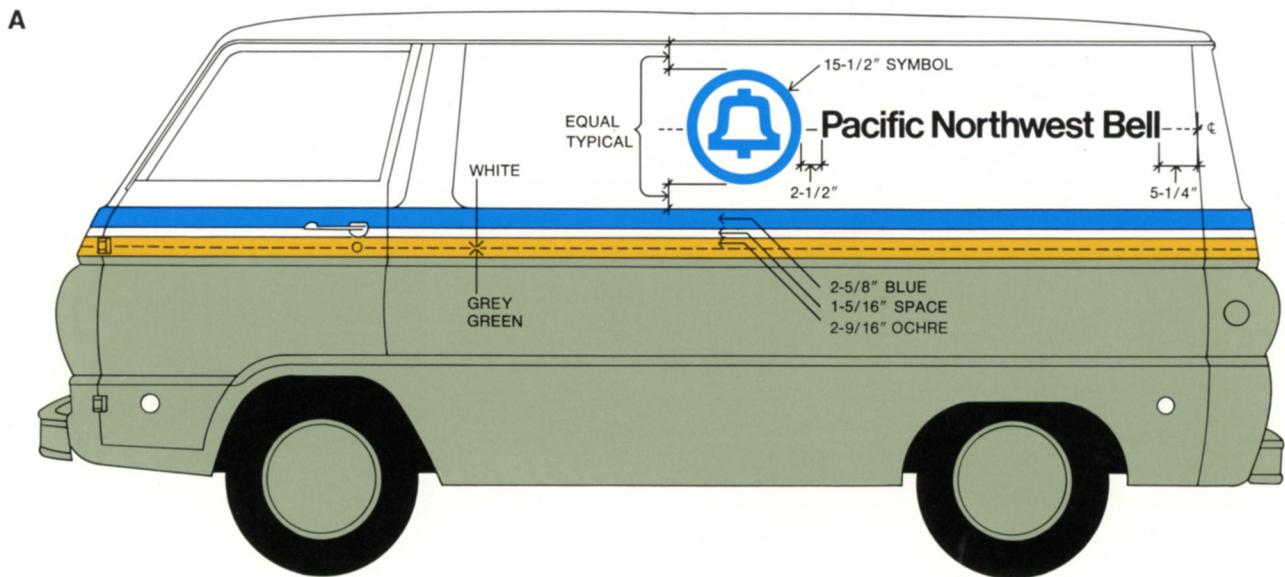

Dodge — 1970 and earlier

- A—Right side with one-line logotype
- B—Right side with two-line logotype
- C—Right side with three-line logotype

The location of the bell symbol is identical for all companies. Also, the distance from the logotype to the door seam is identical for all companies.

All logotypes, regardless of their number of lines, are centered horizontally on the symbol; align the horizontal centerline on the logotype application sheet with the centerline of the bell symbol.

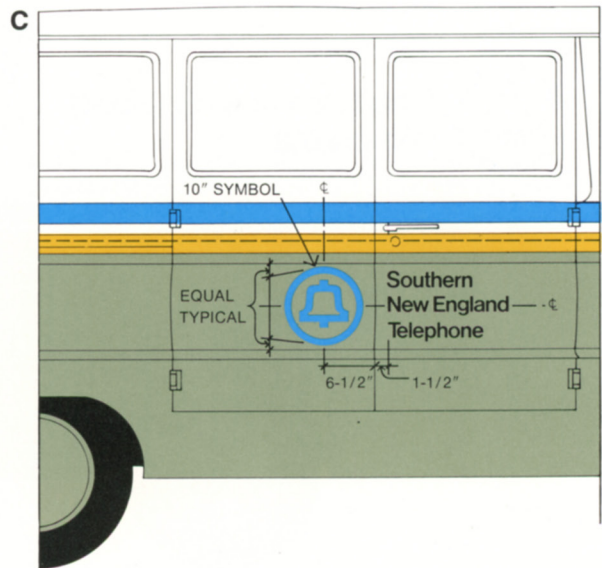
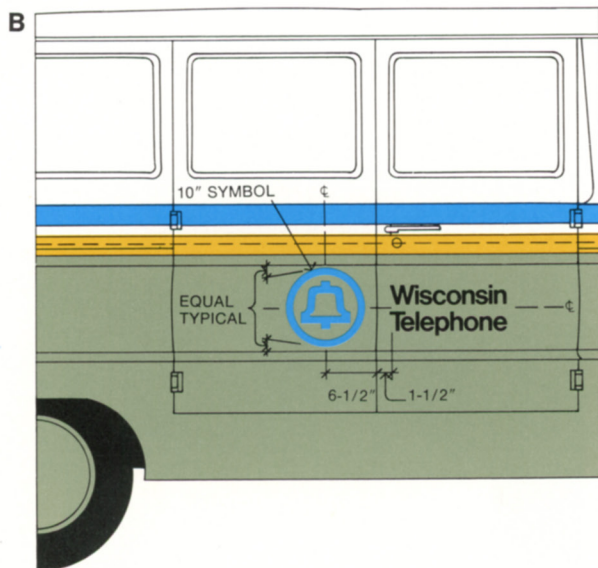
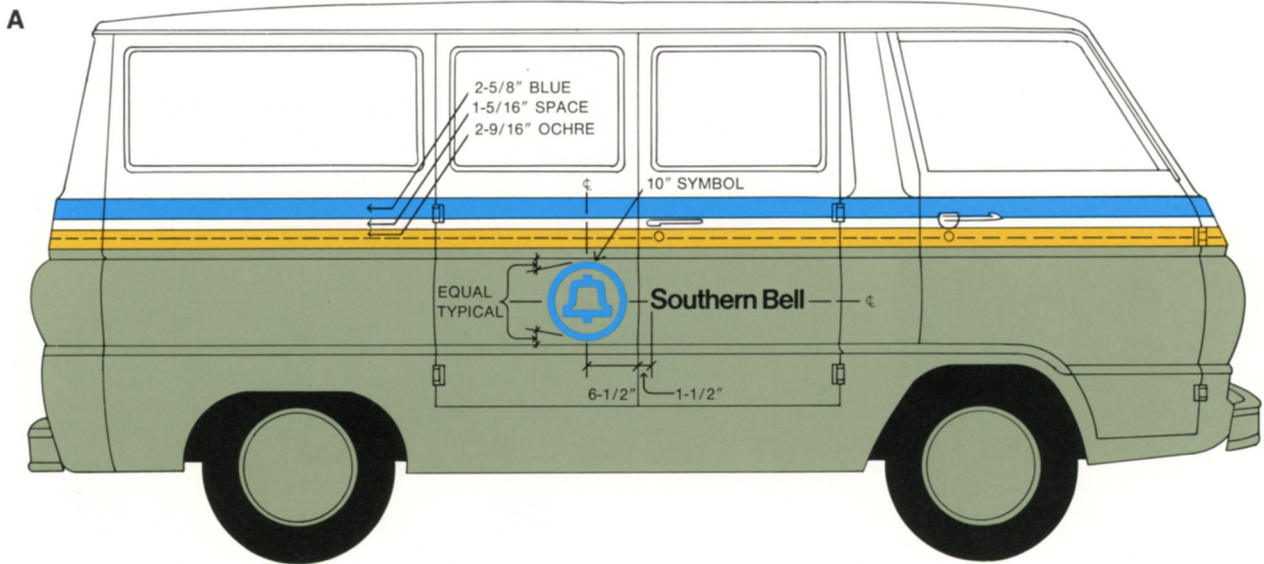

Dodge — 1970 and earlier

A—Top with bell symbol

The use of the bell symbol on the roof, as indicated, is optional in instances where dome lights or other equipment are not required. In urban areas where the bell symbol on the roof is more likely to be seen from buildings, this strong secondary identification will be of value.

B—Front with stripes only. No further identification.

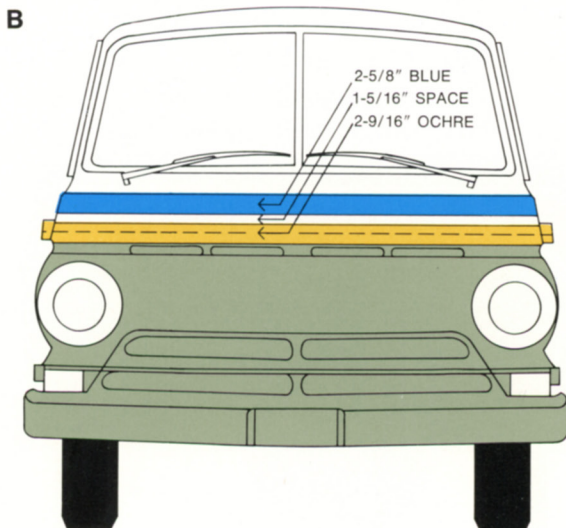
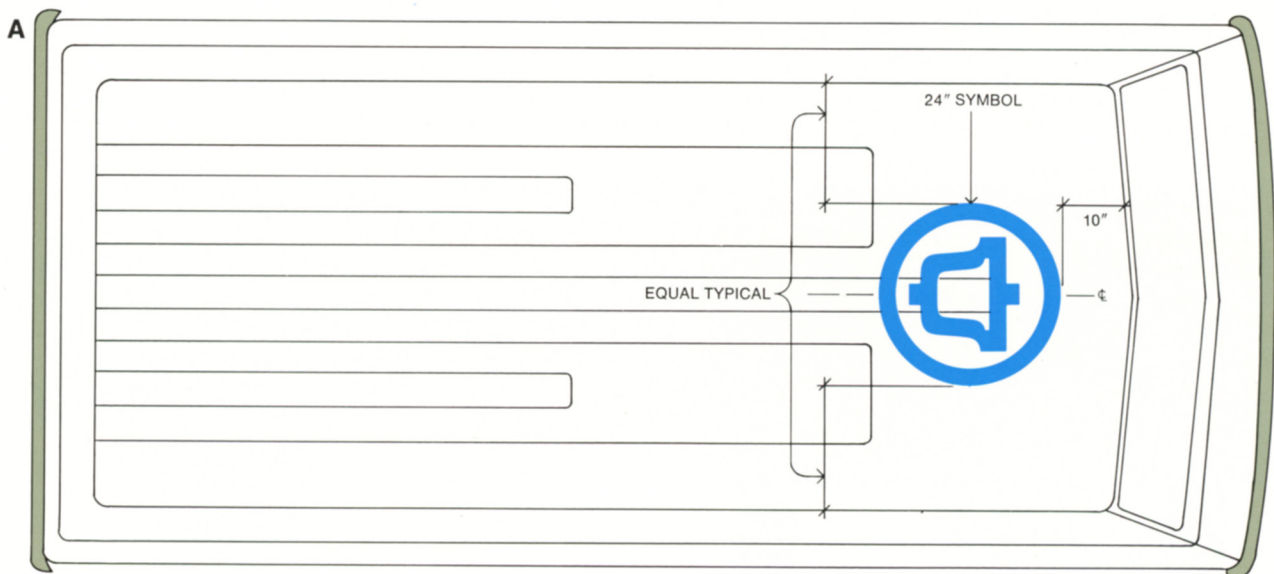

Dodge – 1970 and earlier

A—Rear with one-line logotype

B—Rear with two-line logotype

C—Rear with three-line logotype

The location of the bell symbol is identical for all companies. The distance from the logotype to the door seam is identical for all companies. All logotypes are centered horizontally on the bell symbol; align the horizontal centerline on the logotype application sheet with the horizontal centerline of the bell symbol.

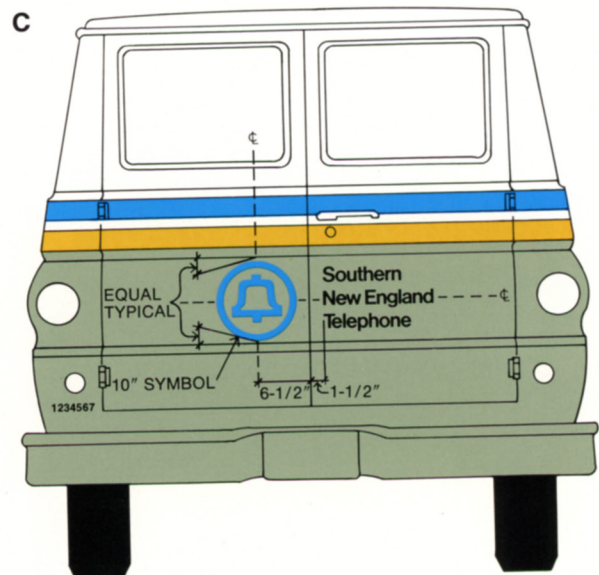
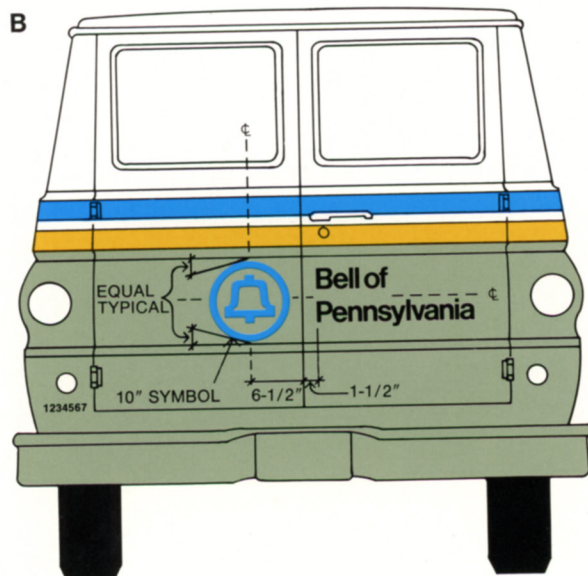
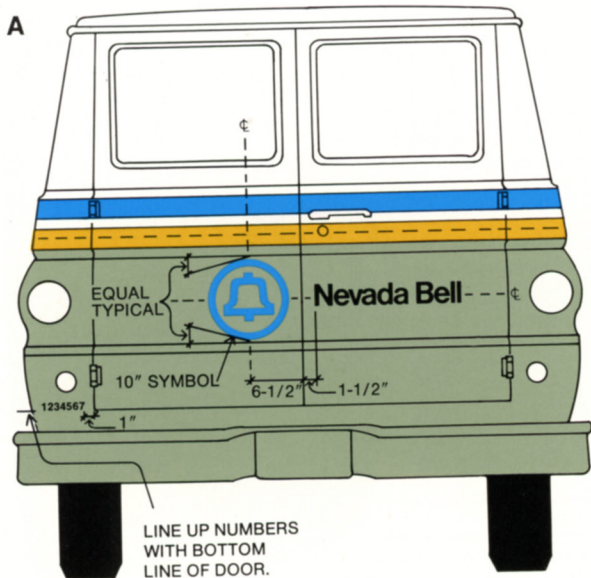

Chevy and GMC — 1971

- A—Left side, enclosed, with one-line logotype
- B—Left side, enclosed, with two-line logotype

The length of the logotype varies from company to company. However, the dimensions given from the logotype to the bell symbol, and from the logotype to the rear edge of the vehicle *do not change*, regardless of the length of a company's logotype.

Note: Due to the radius of the rear edge of this vehicle, this measuring point must be optically determined. *It should be the edge of the vehicle when viewed in profile, as shown in drawings A and B.* The point from which the dimension is taken is determined by the longest line of the logotype, as indicated in drawings A and B.

C—Left side, windowed version, with two-line logotype
 The location of the bell symbol is identical for all companies. The dimension given from the symbol to the logotype is also identical for all companies. All logotypes, regardless of the number of lines they contain, are centered horizontally on the bell symbol through use of the centerlines provide on application sheets.

Note: Symbols and logotypes for windowed left sides are identical in size to those provided for right sides.

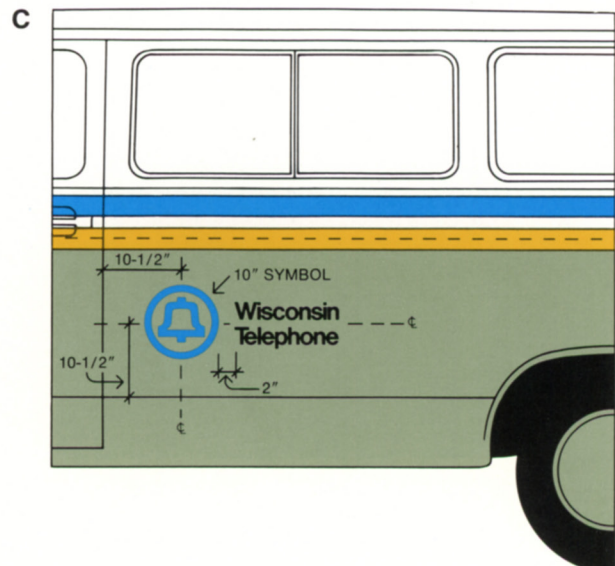
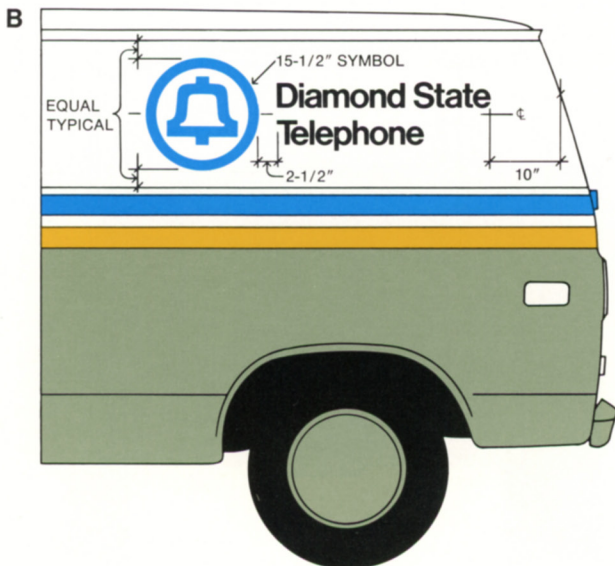
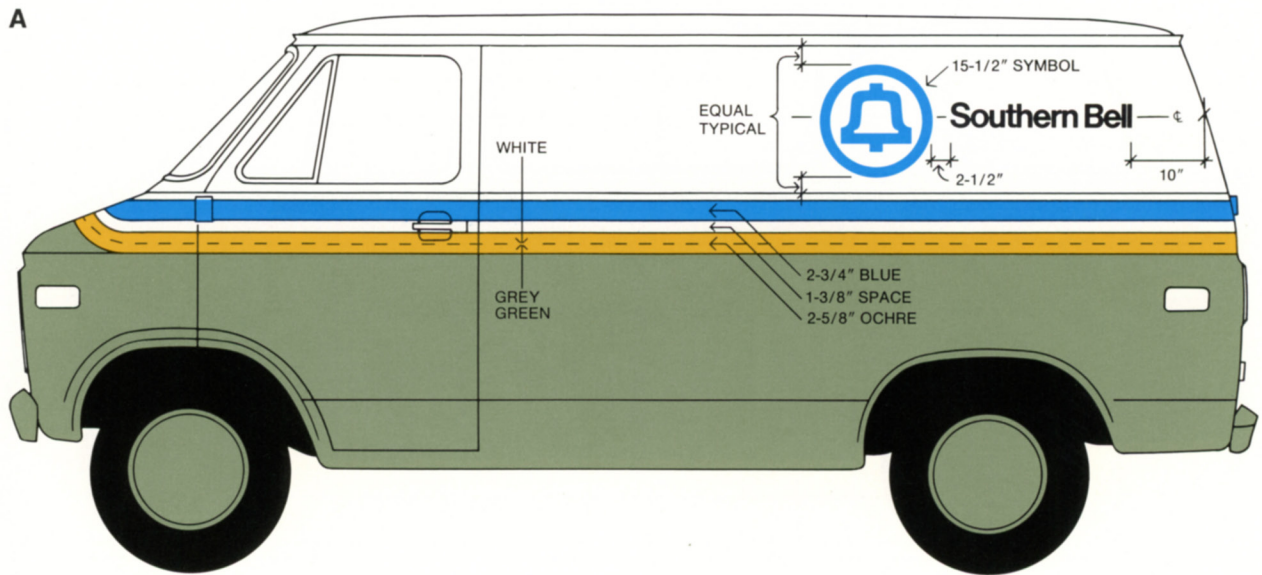

Chevrolet and GMC—1971

- A—Right side with one-line logotype
- B—Right side with two-line logotype
- C—Right side with three-line logotype

The location of the bell symbol is identical for all companies.

All logotypes, regardless of number of lines, are centered horizontally on the bell symbol; align the horizontal centerline on the logotype application sheet with the horizontal centerline of the bell symbol.

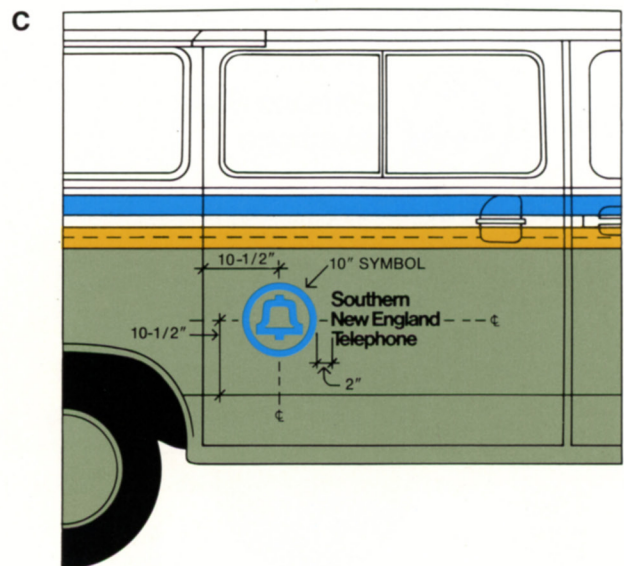
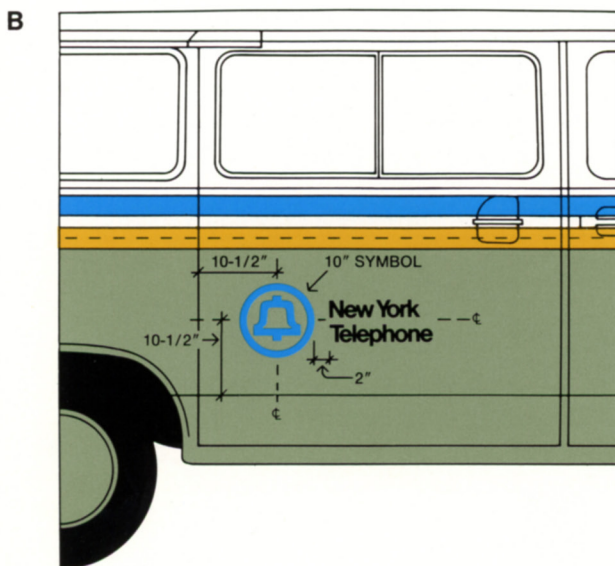
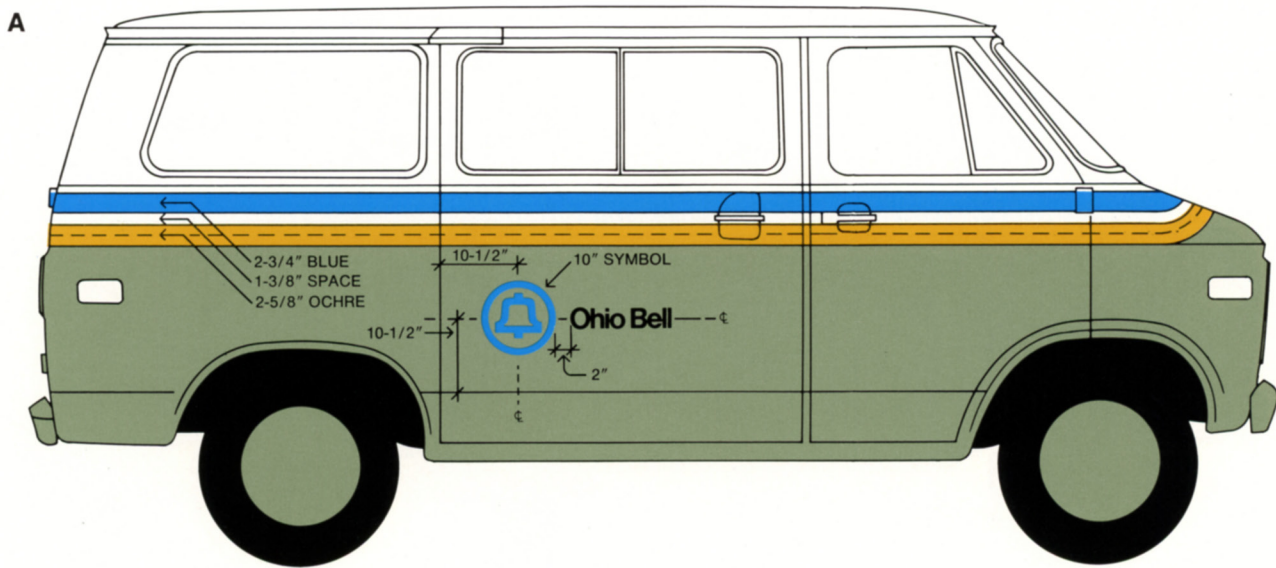

Chevrolet and GMC—1971

A—Top

Due to the heavy corrugations on the roof of this vehicle, it is not recommended that bell symbols be applied.

B—Front with stripes only. No further identification.

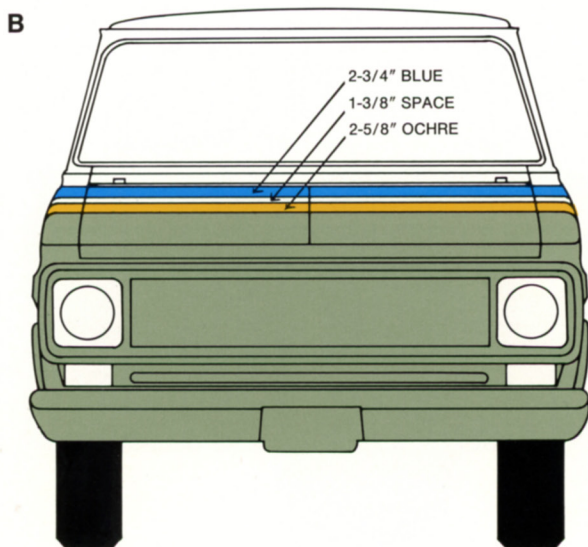
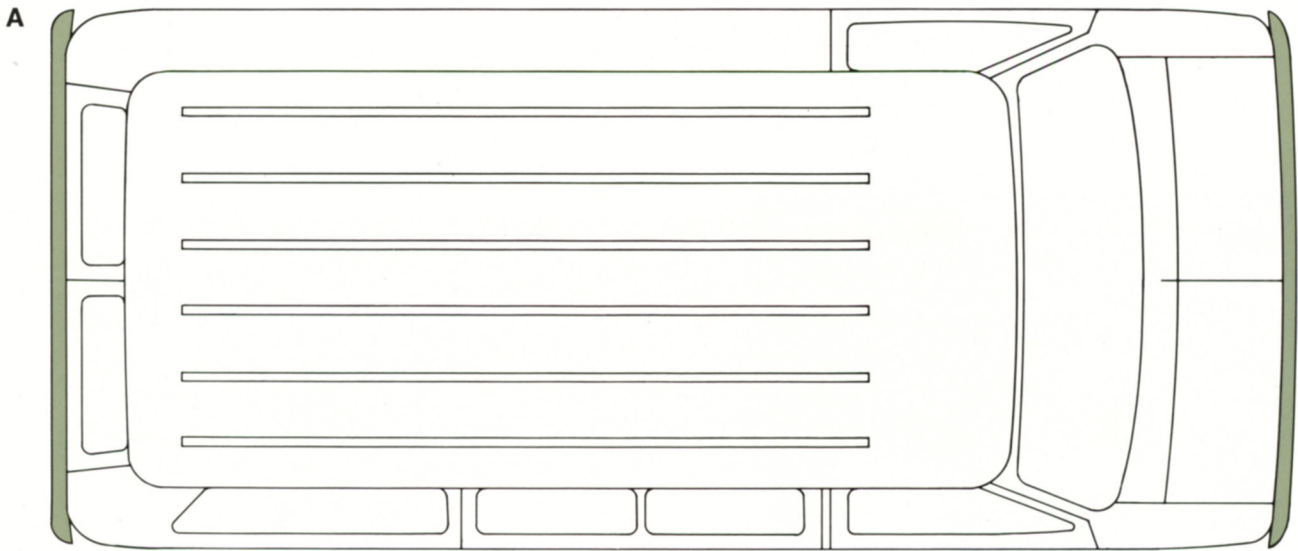

Chevrolet and GMC – 1971

A—Rear with one-line logotype

B—Rear with two-line logotype

C—Rear with three-line logotype

You will note that the dimensions for locating both the symbol and logotype vary according to the number of lines a logotype contains. However, all one-line logotypes are identical in location, as are all two-line logotypes and all three-line logotypes.

In these flush-left symbol/logotype arrangements, the logotype is aligned with the symbol circle in the manner described on page 6.

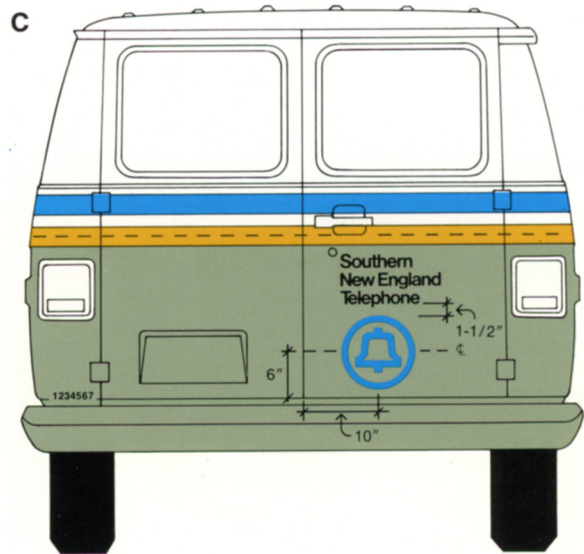
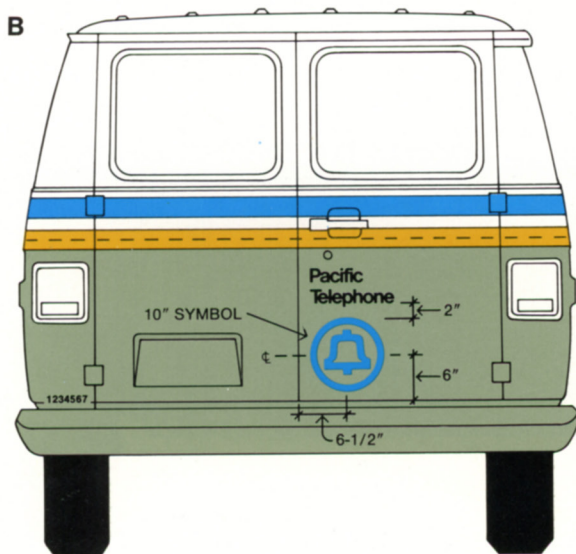
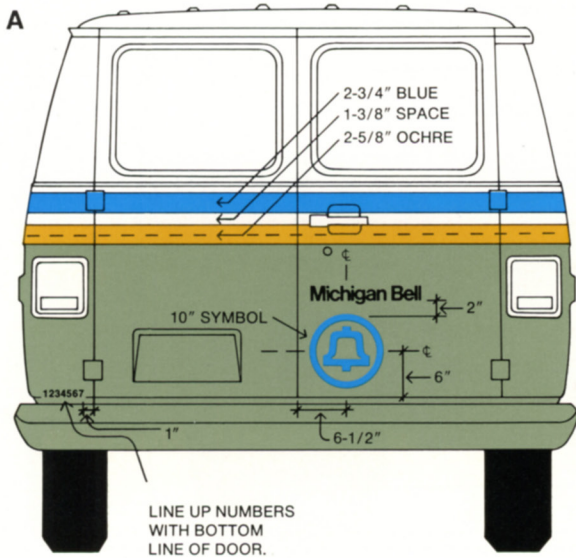

Chevrolet and GMC – 1970 and earlier

A—Left side, enclosed, with one-line logotype

B—Left side, enclosed, with two-line logotype

The length of the logotype varies from company to company. However, the dimensions given from the logotype to the bell symbol, and from the logotype to the rear edge of the vehicle *do not change*, regardless of the length of a company's logotype.

Note: Due to the radius of the rear edge of this vehicle, this measuring point must be optically determined. *It should be the edge of the vehicle when viewed in profile, as shown in drawings A and B.* The point from which the dimension is taken is determined by the longest line of the logotype, as indicated in drawings A and B.

C—Left side, windowed version, with two-line logotype

The location of the bell symbol is identical for all companies. The dimension given from the symbol to the logotype is also identical for all companies. All logotypes, regardless of the number of lines they contain, are centered horizontally on the bell symbol through use of the centerlines provide on application sheets.

Note: Symbols and logotypes for windowed left sides are identical in size to those provided for right sides.

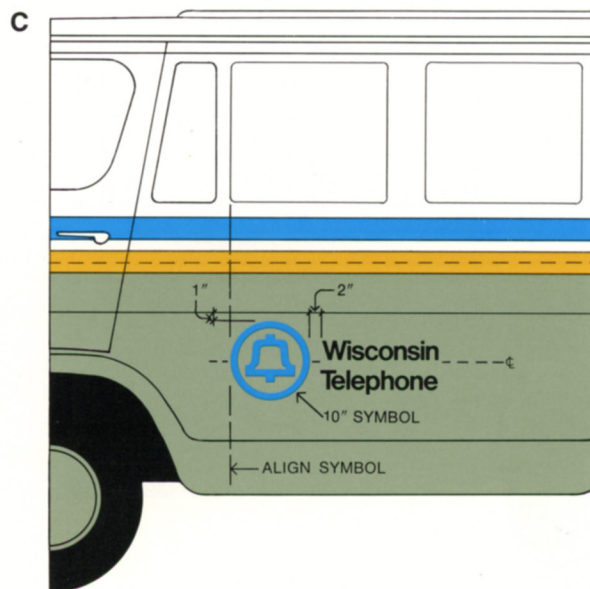
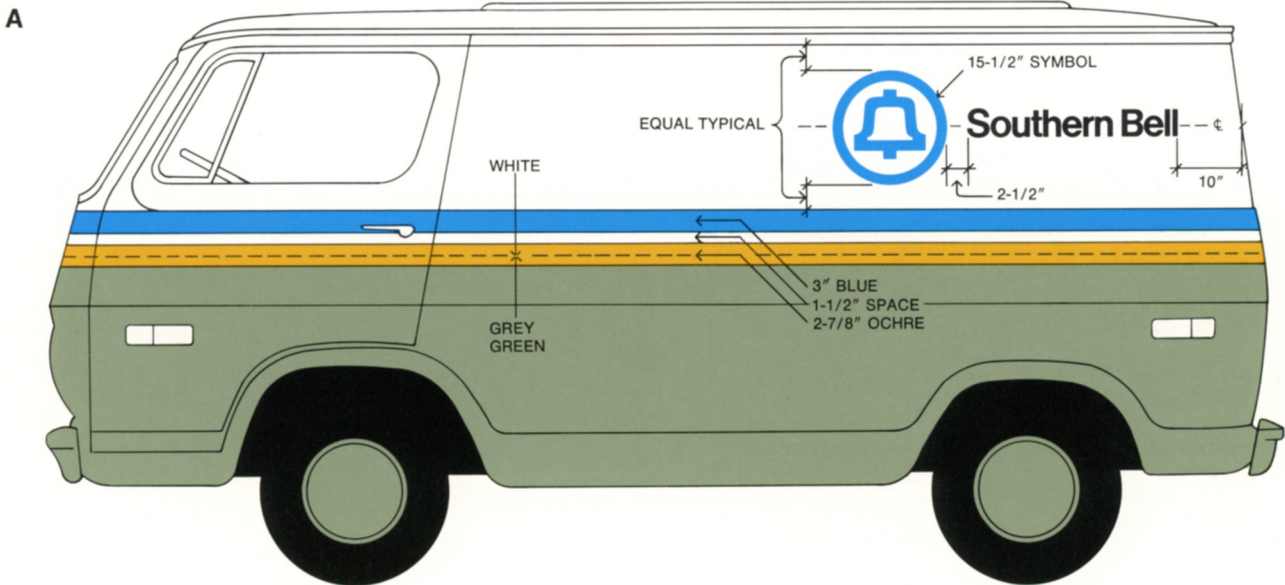

Chevrolet and GMC — 1970 and earlier

- A — Right side with one-line logotype
- B — Right side with two-line logotype
- C — Right side with three-line logotype

The location of the bell symbol is identical for all companies. Also, the distance from the logotype to the door seam is identical for all companies.

All logotypes, regardless of number of lines, are centered horizontally on the bell symbol; align the horizontal centerline on the logotype application sheet with the horizontal centerline of the bell symbol.

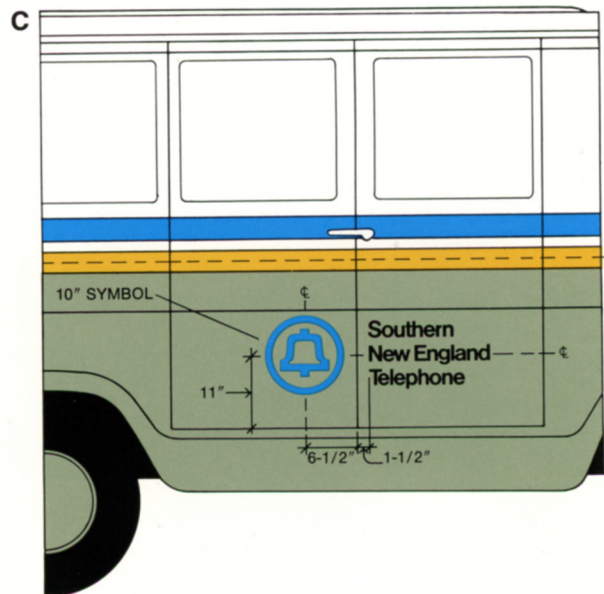
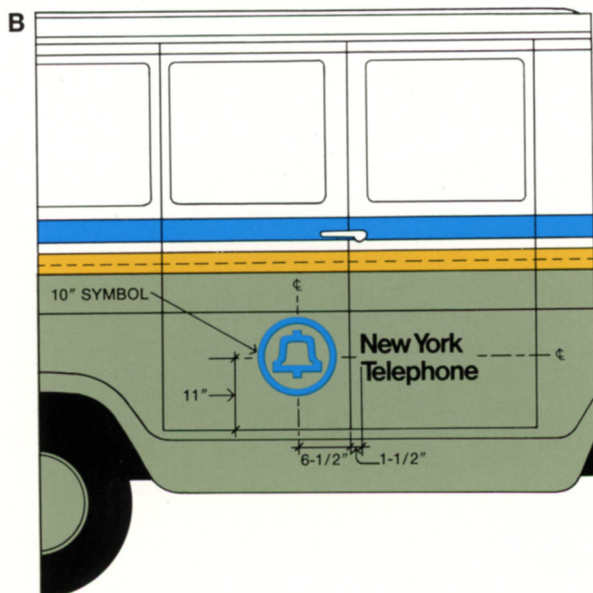
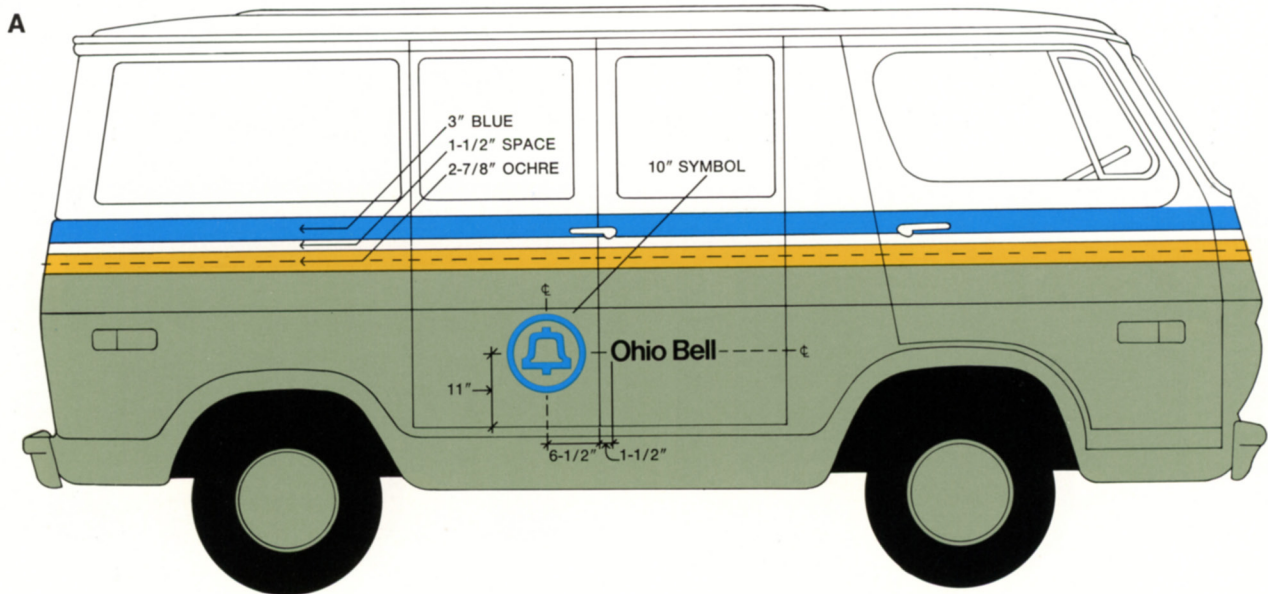

Chevrolet and GMC – 1970 and earlier

A—Top with bell symbol

The use of the bell symbol on the roof, as indicated, is optional in instances where dome lights or other equipment are not required. In urban areas where the bell symbol on the roof is more likely to be seen from buildings, this strong secondary identification will be of value.

B—Front with stripes only. No further identification.

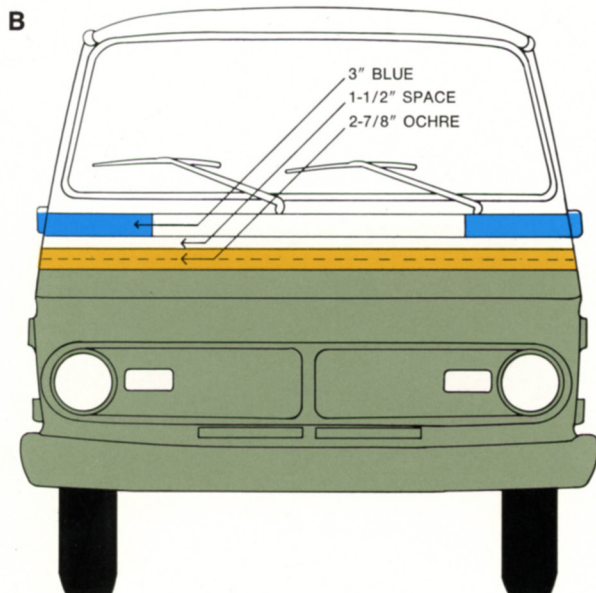
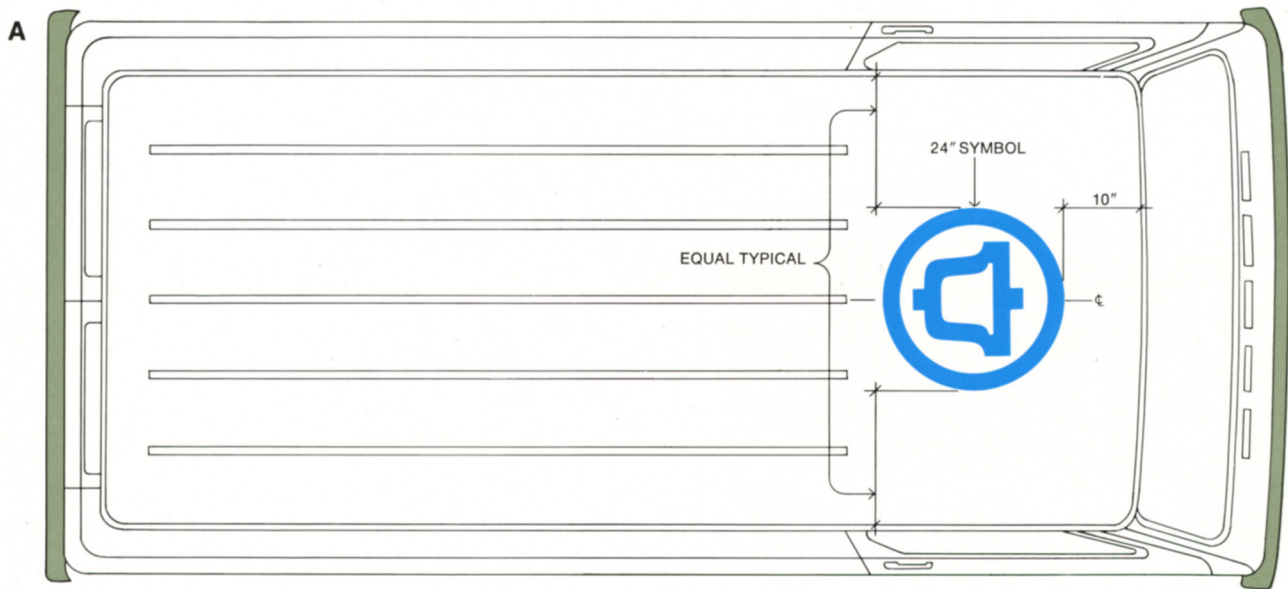

Chevrolet and GMC – 1970 and earlier

- A—Rear with one-line logotype
- B—Rear with two-line logotype
- C—Rear with three-line logotype

You will note that the dimensions for locating both the symbol and logotype vary according to the number of lines a logotype contains. However, all one-line logotypes are identical in location, as are all two-line logotypes and all three-line logotypes.

In these flush-left symbol/logotype arrangements, the logotype is aligned with the symbol circle in the manner described on page 6.

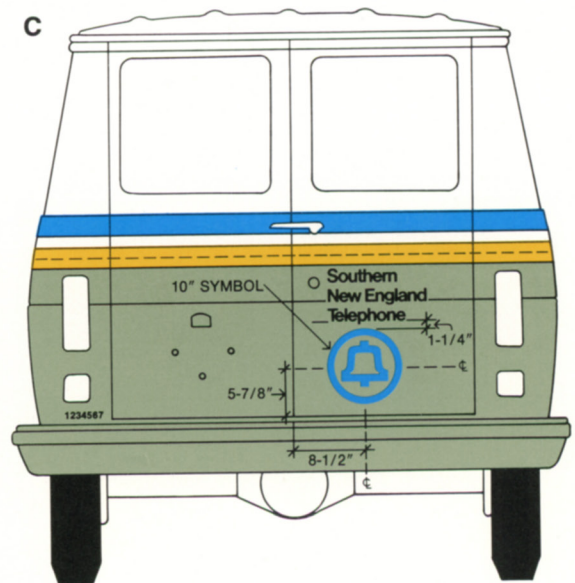
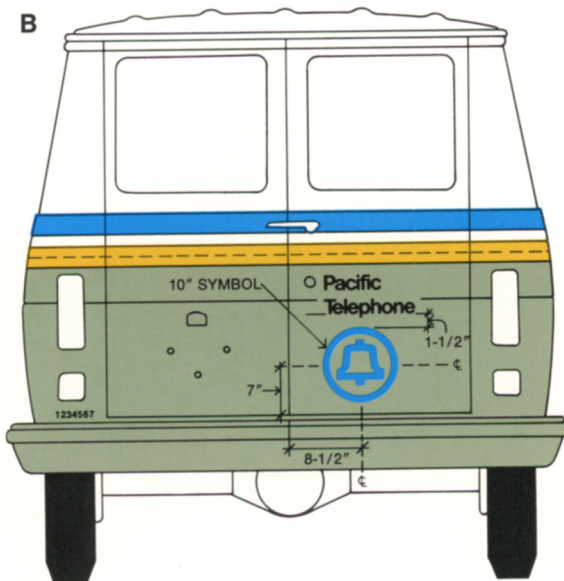
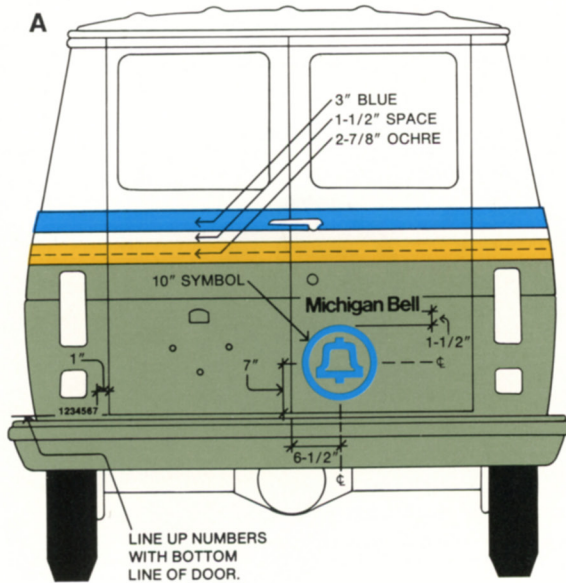

Sedans and Station Wagons

A—Typical sedan and station wagon, front

B—Typical sedan, rear

Sedans and station wagons are painted Bell White, including the wheels. The stripes are aligned longitudinally along the centerline of the hoods and rear deck lids of all sedans. (Station wagons do not have stripes on the rear.) When the rear panel from window to deck lid is more than 3", continue the stripes to the rear window molding. When the rear panel is less than 3", terminate the stripes at the forward edge of the deck lid.

Stripe material must be wrapped around the ends of the body panels indicated and pressed firmly to the underside of panel (see Bell Systems Practices Sec-

tion #720-030-010, Issue 2, for detailed application techniques). In cases where the body panel is finished with trim, as is frequently the case with the front edges of hoods, the stripes must be cut to abut the trim. Manufacturer's names or symbols should be removed and replaced on top of the stripes.

C—Typical sedan, left side

The symbol/logotype unit is optically centered, both vertically and horizontally, on the driver's door.

Should body contour or trim interfere with the placement, adjust the vertical placement only, in order to clear the contour or trim.

The dimension between symbol and logotype is identical for all companies. Logotypes are always centered horizontally on the bell symbol, using the centerlines provided on application sheets.

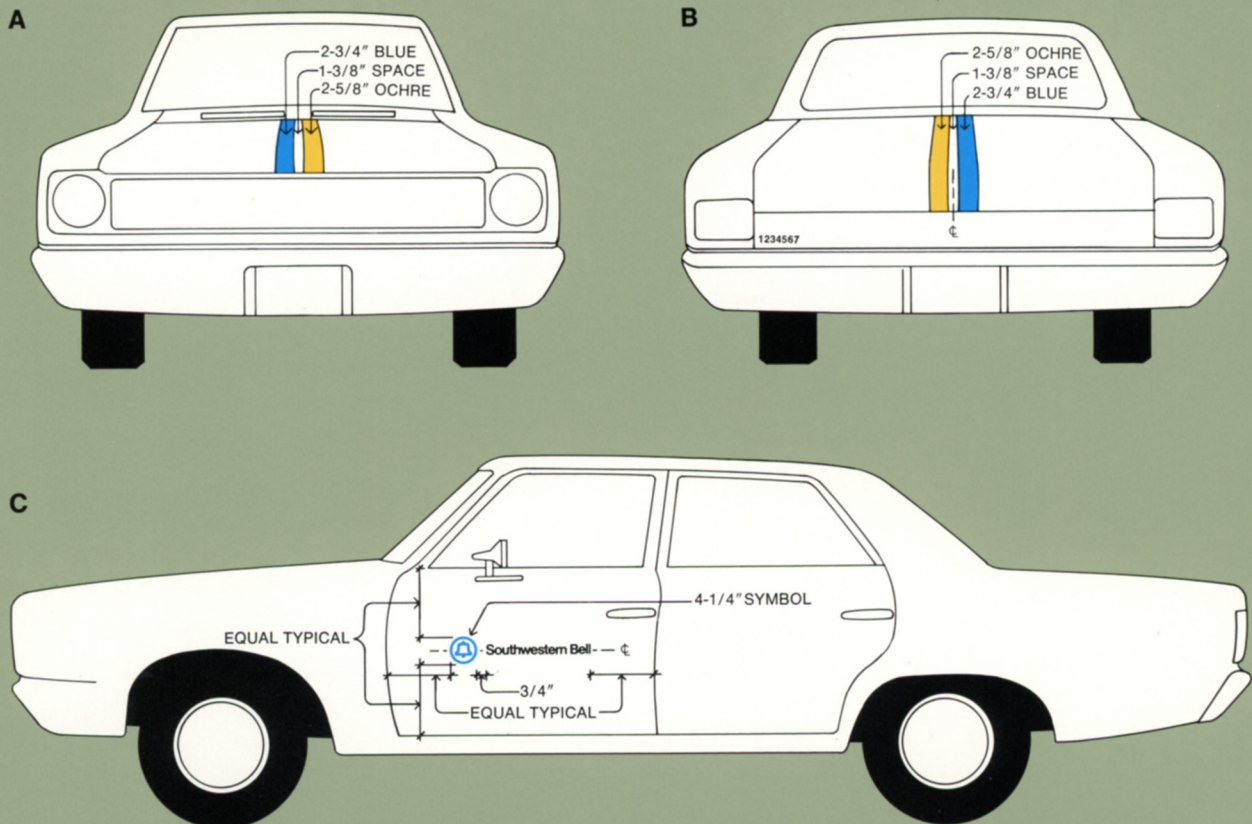

A—Typical sedan, right side

Symbol/logotype units are placed on passenger doors in precisely the same manner as on driver's doors, as described on the facing page.

B—Typical station wagon, left side

Station wagon doors are identical to sedan doors. Both left and right doors are to be identified in the manner of the sedan doors as described above.

Note: The bell symbol is *always* on the left side of the logotype.

For the appropriate size and line configuration of your company's logotypes for this vehicle type, refer to the chart on page 59.

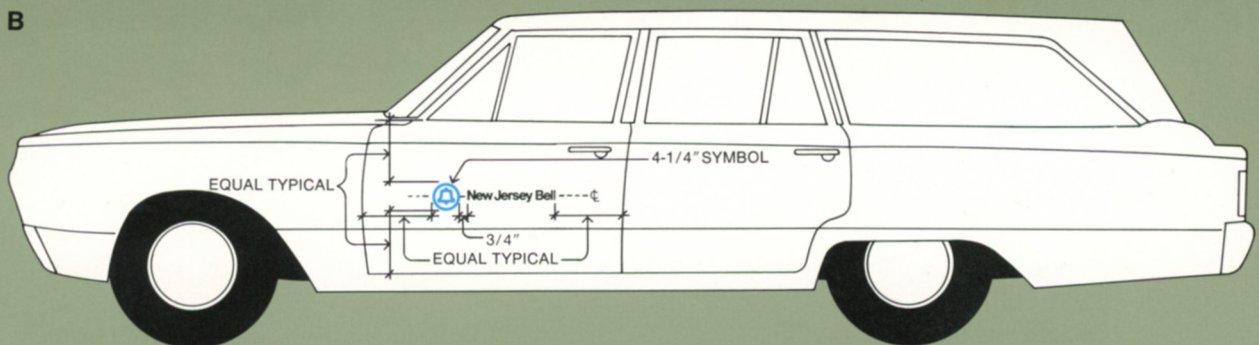
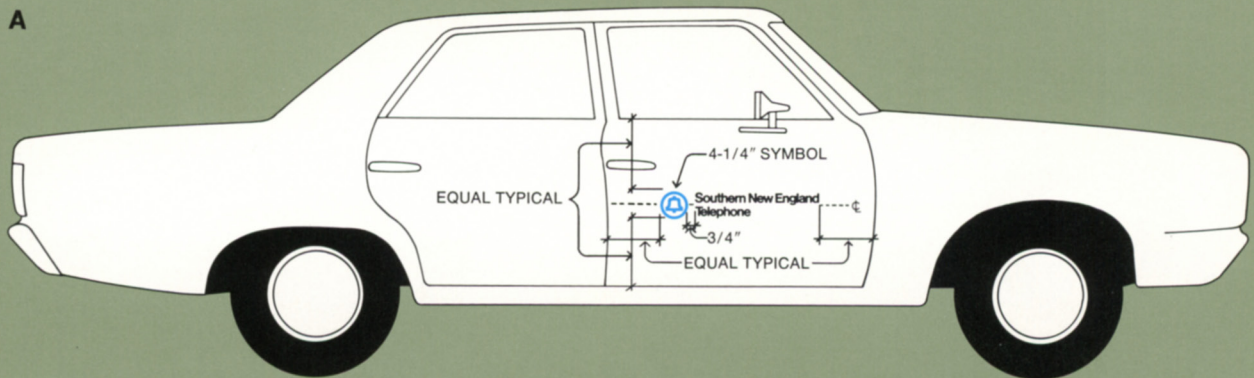

Suburban Carryall and Panel

Color: Bell White including wheels.

A—Left side, with one-line logotype.

Symbol/logotype units are located as described for sedans and station wagons. This is true for both left and right doors, and for all companies.

B—Front

Stripes are located along the longitudinal centerline of the hood, wrapped under both leading and trailing edges as described for sedans.

C—Rear with one door

D—Rear with two doors

The symbol placement is identical for all companies. Also, the dimension between the symbol and logotype is identical for all companies. All logotypes are centered horizontally on the symbol, using the horizontal centerlines provided on application sheets.

For the appropriate size and line configuration of your company's logotypes for this vehicle type, refer to the chart on page 59.

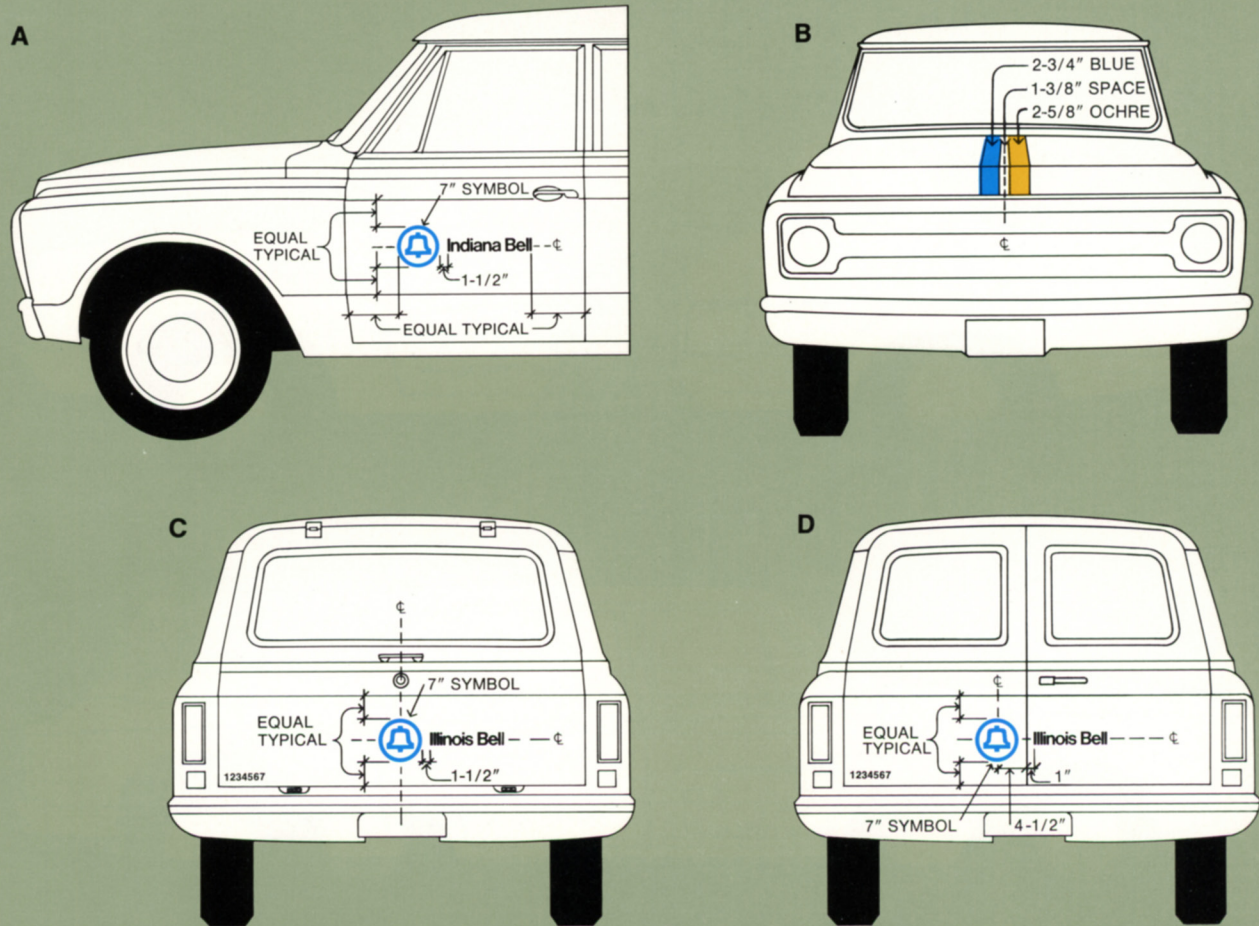

Trucks with Fixed Bodies

The specifications in this section apply to all truck cabs to which bodies are permanently attached. The cab specifications do not change, regardless of the type of body affixed. This principle is illustrated below.

Pictured are three body variations behind one cab type.

(A) a pickup, (B) a work truck, (C) an aerial lift truck. In each case, the cab is white with the symbol, logo-type and stripes on the doors unaffected by the body type.

Bodies and rear bumpers are always grey-green, except for aerial or other mobile equipment, which is white (Drawing C).

An exception to this body color designation is supply truck bodies. Due to their large size and visibility, these are treated in the manner of trailers, described on pages 50 and 51.

Wheels, wheel covers and front bumpers are to be white.

The "Conventional Cabs" designation covers a variety of sizes of vehicles, from pickups through medium-sized trucks. This generalization is possible because each manufacturer's cab style is consistent through this size range. This cab type is most commonly affixed permanently to bodies.

However, other cab types are also used in this manner; heavier trucks with shorter hoods and tilt cabs are also frequently attached to bodies. Because of the differences in door configurations, these vehicles require different specifications. They are described on pages 46, 47 and 48.

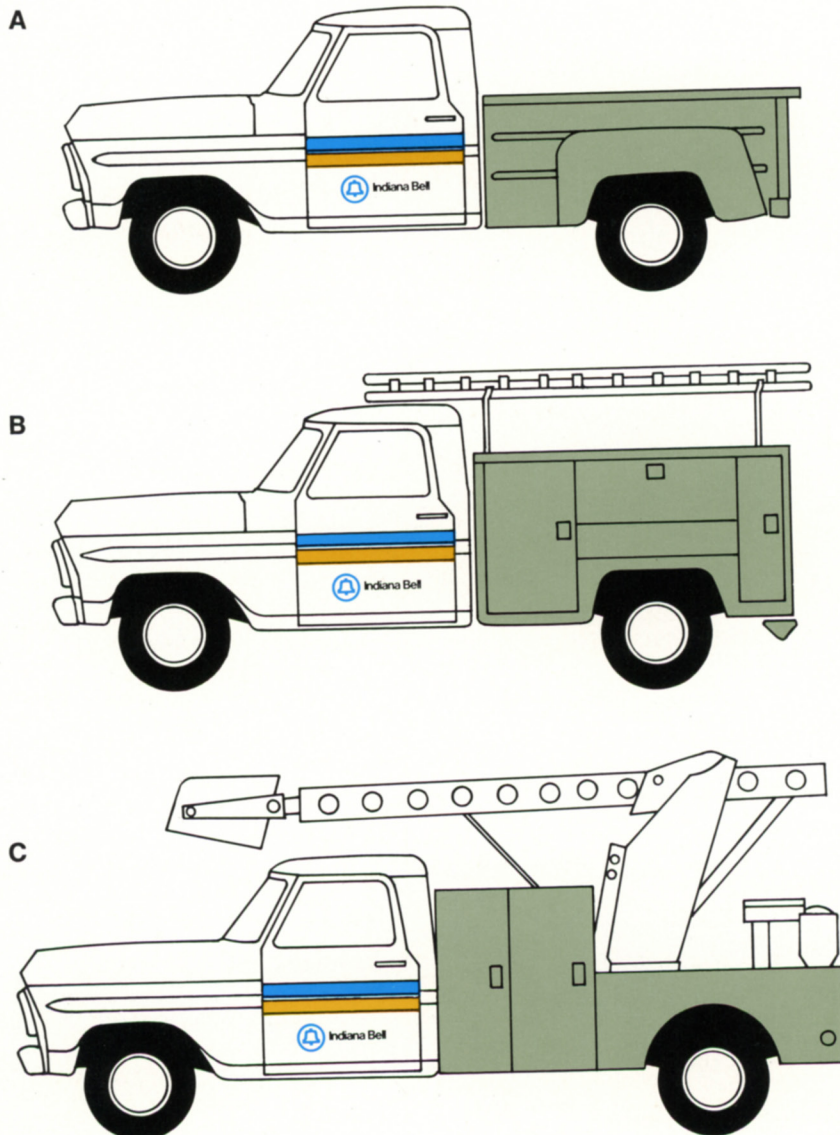

Ford

A—1970 model, left side, with one-line logotype

B—1970 model, right side, with one-line logotype

The symbol/logotype unit is centered horizontally in the area designated.

The dimension given from symbol to logotype does not change, regardless of the size or length of your company's logotype. All logotypes are centered horizontally on the bell symbol, using the centerlines provided on application tapes.

All bell symbols are 7" diameter. All logotypes are size "E," which is 2" cap height, with the exceptions of Ohio Bell (size "C," 2¾" cap height), New Jersey Bell (size "B," 2⅞" cap height), and Southern New England Telephone (size "F," 1¾" cap height).

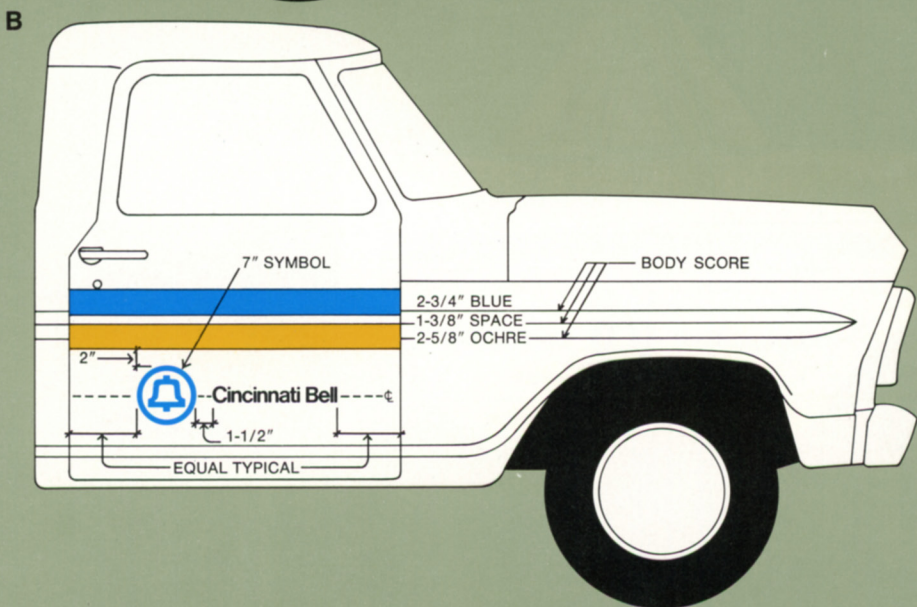
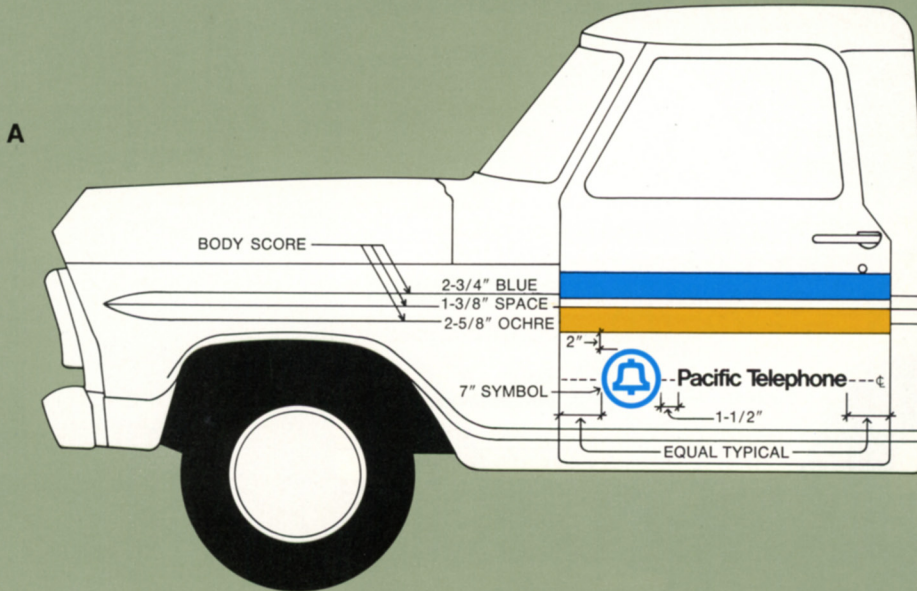

Ford

A—1970 model

B—Last previous model

(Right side is identical to left. Bell symbol always appears on the left of the logotype.)

The symbol/logotype unit is centered horizontally in the area designated.

The dimension given from symbol to logotype does not change, regardless of the size or length of your company's logotype. All logotypes are centered horizontally on the bell symbol, using the centerlines provided on application tapes.

All bell symbols are 7" diameter. All logotypes are size "E," which is 2" cap height, with the exceptions of Ohio Bell (size "C," 2³/₄" cap height), New Jersey Bell (size "B," 2⁷/₈" cap height), and Southern New England Telephone (size "F," 1³/₄" cap height).

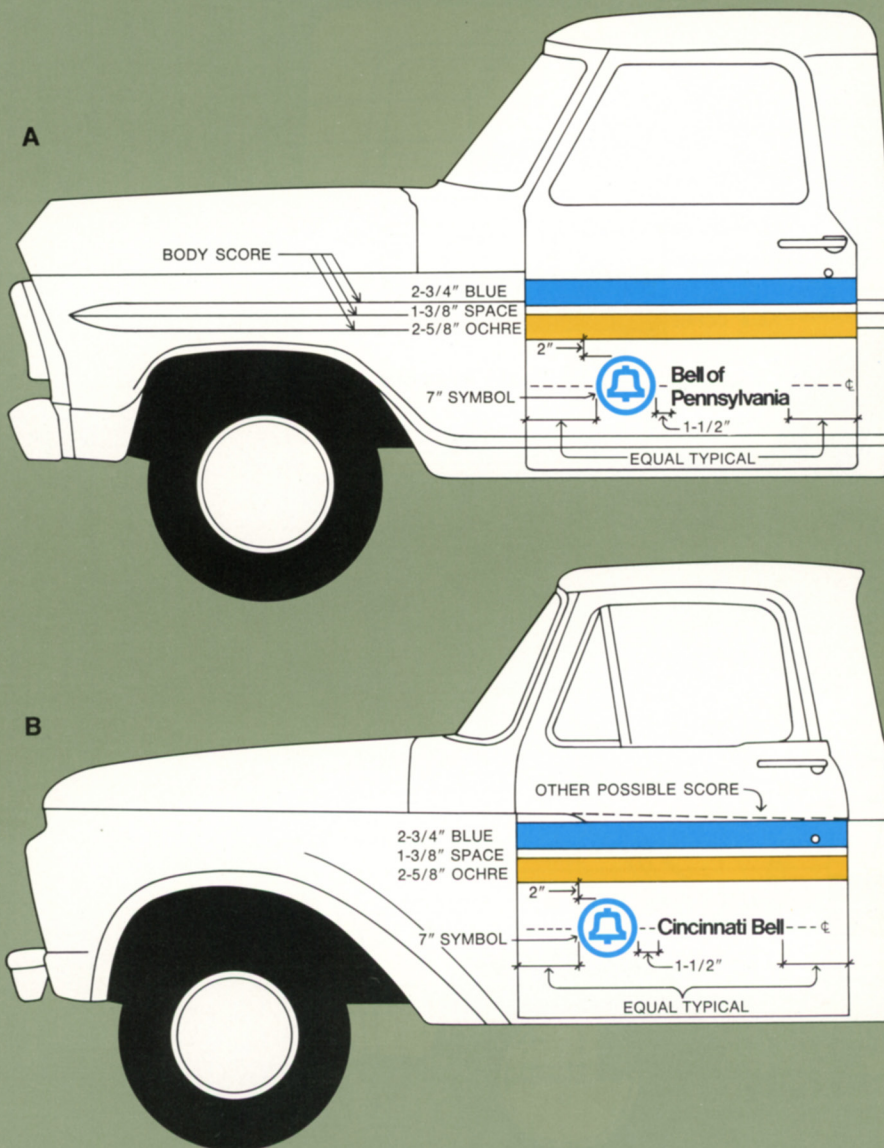

Chevrolet and GMC

A—1970 model

B—Last previous model

(Right side is identical to left. Bell symbol always appears on the left of the logotype.)

The symbol/logotype unit is centered horizontally in the area designated.

The dimension given from symbol to logotype does not change, regardless of the size or length of your company's logotype. All logotypes are centered horizontally on the bell symbol, using the centerlines provided on application tapes.

All bell symbols are 7" diameter. All logotypes are size "E," which is 2" cap height, with the exceptions of Ohio Bell (size "C," 2³/₄" cap height), New Jersey Bell (size "B," 2⁷/₈" cap height), and Southern New England Telephone (size "F," 1³/₄" cap height).

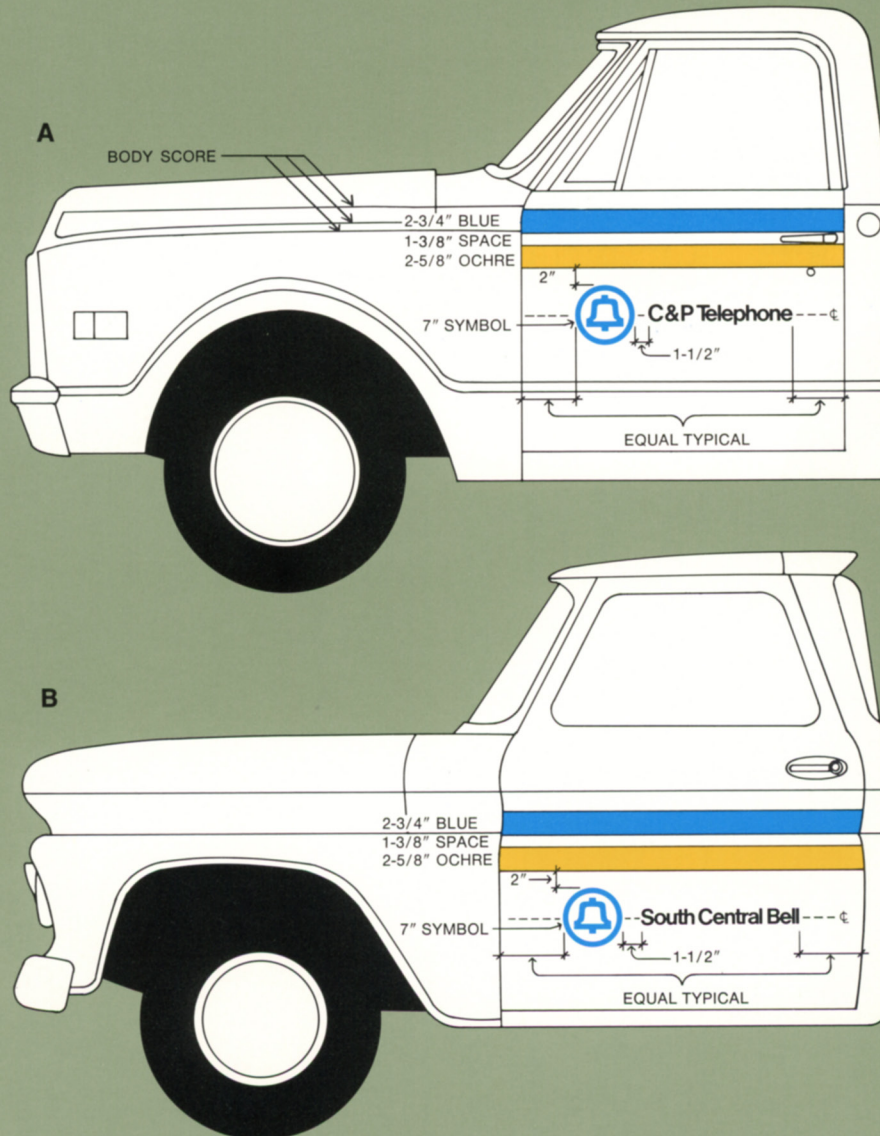

Dodge

1970 model; left

(Right side is identical to left. Bell symbol always appears on the left of the logotype.)

The symbol/logotype unit is centered horizontally in the area designated.

The dimension given from symbol to logotype does not change, regardless of the size or length of your company's logotype. All logotypes are centered horizontally on the bell symbol, using the centerlines provided on application tapes.

All bell symbols are 7" diameter. All logotypes are size "E," which is 2" cap height, with the exceptions of Ohio Bell (size "C," 2 $\frac{3}{4}$ " cap height), New Jersey Bell (size "B," 2 $\frac{7}{8}$ " cap height), and Southern New England Telephone (size "F," 1 $\frac{3}{4}$ " cap height).

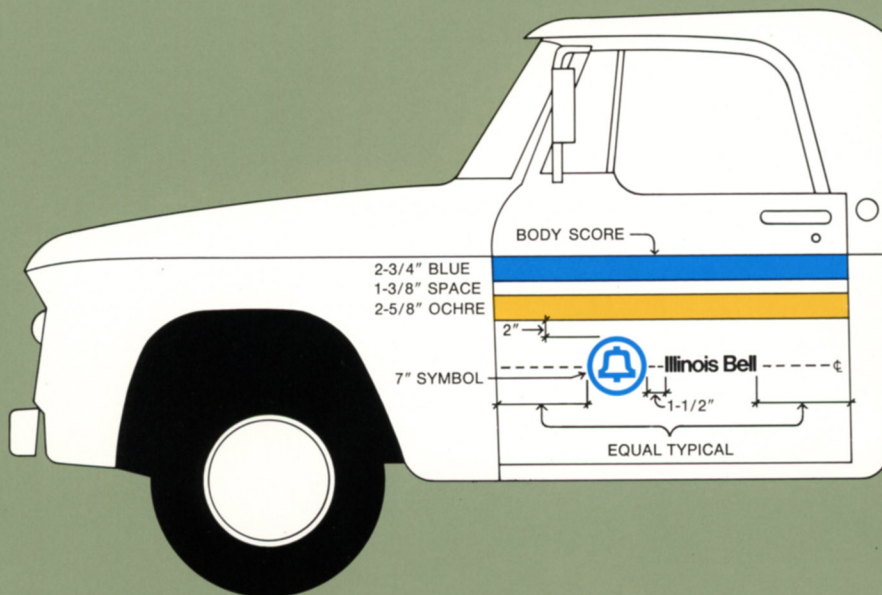

Bell System Vehicle Graphics Manual Supplement Number 1

1973 Models—Truck Cabs with Fixed Bodies

Guidelines for painting and marking:

1973 Ford Cab

1973 Chevrolet Cab

1973 Dodge Cab

Important: Please insert this supplement into your copy of the Vehicle Graphics Manual immediately following page 44.

1973 Ford Cab

A—1973 model, left side, with one-line logotype

B—1973 model, right side, with one-line logotype

The symbol/logotype unit is centered horizontally in the area designated.

The dimension given from symbol to logotype does not change regardless of the size or length of your company's logotype. All logotypes are centered horizontally on the bell symbol, using the centerlines provided on application tapes.

All bell symbols are 7" in diameter. All logotypes are size "E," which is 2" cap height, with the exceptions of Ohio Bell (size "C," 2 3/4" cap height), New Jersey Bell (size "B," 2 7/8" cap height), and Southern New England Telephone (size "F," 1 3/4" cap height).

A

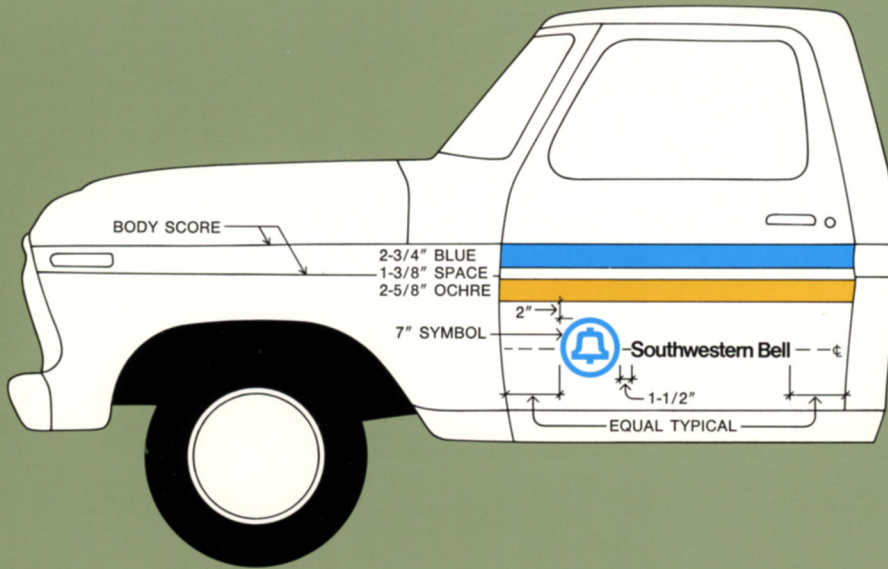

B

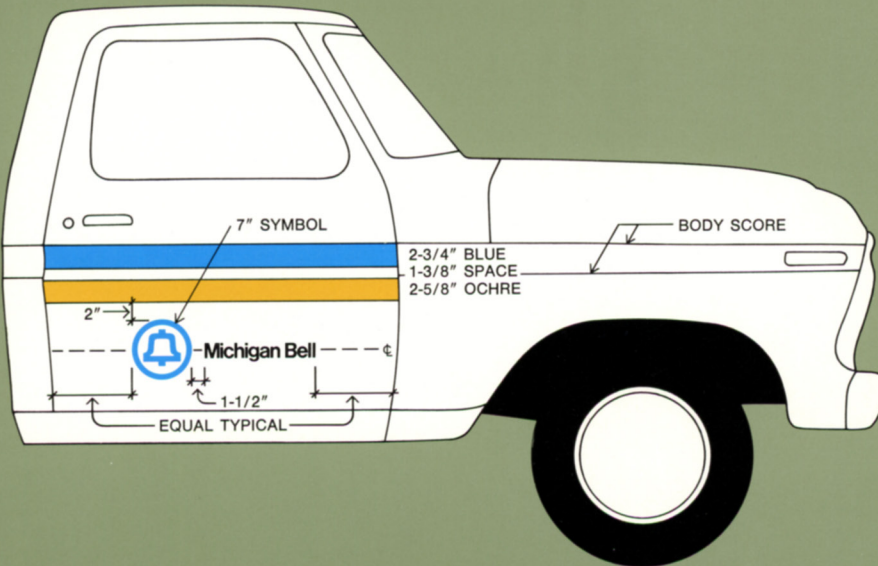

1973 Chevrolet Cab

1973 model; left side

(Right side is identical to left. Bell symbol always appears on the left of the logotype.)

The symbol/logotype unit is centered horizontally in the area designated.

The dimension given from symbol to logotype does not change regardless of the size or length of your company's logotype. All logotypes are centered horizontally on the bell symbol, using the centerlines provided on application tapes.

All bell symbols are 7" diameter. All logotypes are size "E," which is 2" cap height, with the exceptions of Ohio Bell (size "C," 2³/₄" cap height), New Jersey Bell (size "B," 2⁷/₈" cap height), and Southern New England Telephone (size "F," 1³/₄" cap height).

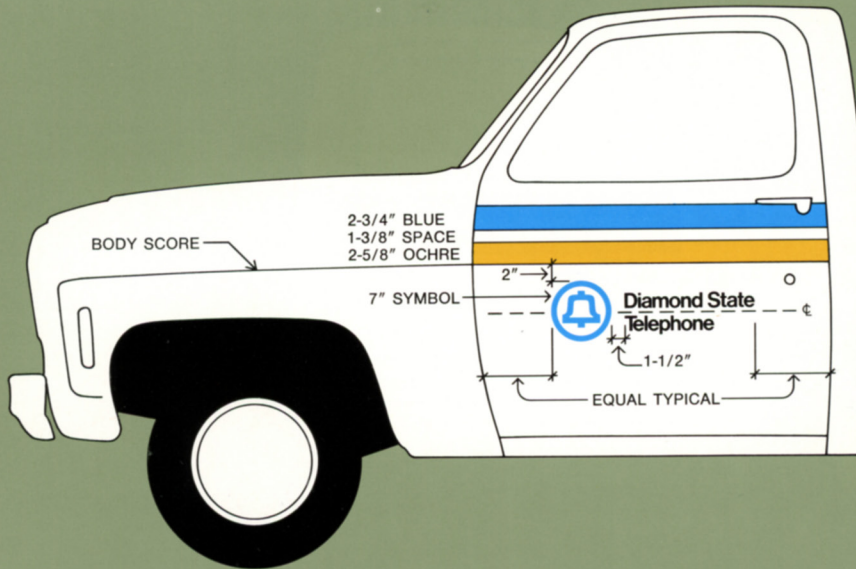

1973 Dodge Cab

1973 model; left side

(Right side is identical to left. Bell symbol always appears on the left of the logotype.)

The symbol/logotype unit is centered horizontally in the area designated.

The dimension given from symbol to logotype does not change, regardless of the size or length of your company's logotype. All logotypes are centered horizontally on the bell symbol, using the centerlines provided on application tapes.

All bell symbols are 7" diameter. All logotypes are size "E," which is 2" cap height, with the exceptions of Ohio Bell (size "C," 2³/₄" cap height), New Jersey Bell (size "B," 2⁷/₈" cap height), and Southern New England Telephone (size "F," 1³/₄" cap height).

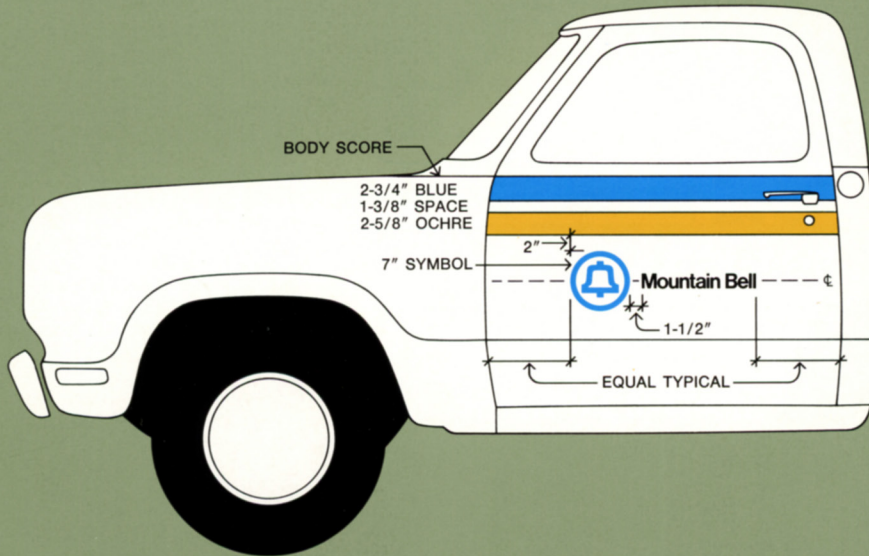

International Harvester

A—1970 model

B—Last previous model

(Right side is identical to left. Bell symbol always appears on the left of the logotype.)

The symbol/logotype unit is centered horizontally in the area designated.

The dimension given from symbol to logotype does not change, regardless of the size or length of your company's logotype. All logotypes are centered horizontally on the bell symbol, using the centerlines provided on application tapes.

All bell symbols are 7" diameter. All logotypes are size "E," which is 2" cap height, with the exceptions of Ohio Bell (size "C," 2³/₄" cap height), New Jersey Bell (size "B," 2⁷/₈" cap height), and Southern New England Telephone (size "F," 1³/₄" cap height).

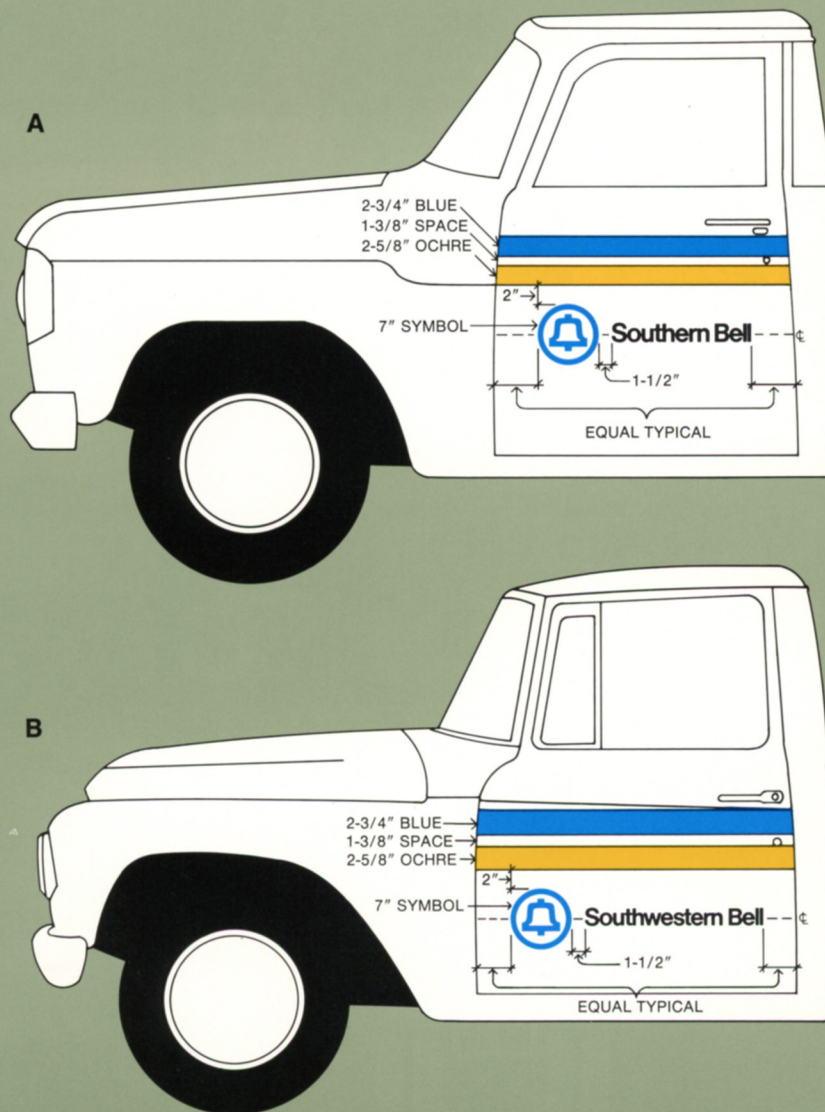

Short and Heavy Duty Conventional Cabs

The drawings below are a typical short-nosed, heavy duty cab. While there is a broad range of body configurations in this vehicle category, the specifications below are applicable in most situations. Exceptions are described on the facing page.

Symbol and logotypes are the same sizes used for conventional cabs, and are described on page 41.

The symbol/logotype unit is optically centered, both horizontally and vertically, in the white space beneath the stripes on the door.

The distance between the symbol and logotype is identical for all companies, regardless of the size and number of lines of the logotype.

The bell symbol always appears to the left of the logotype.

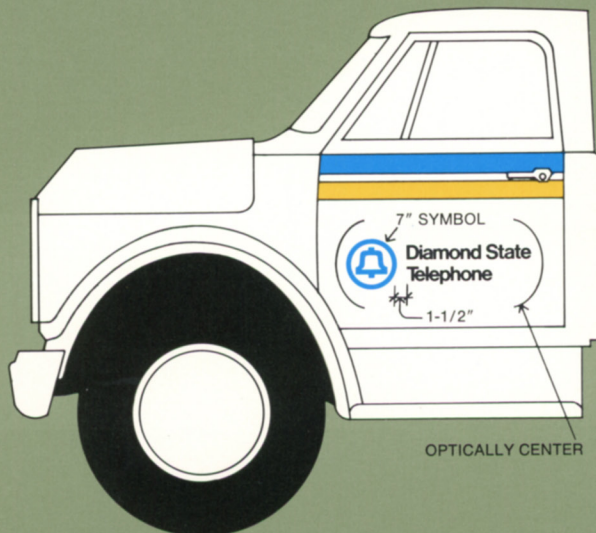
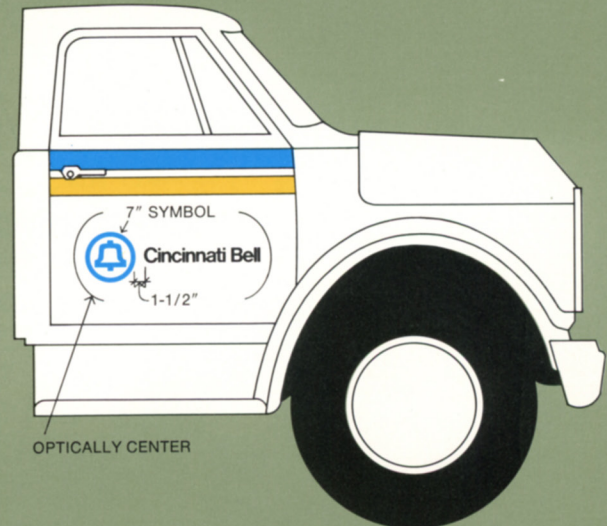
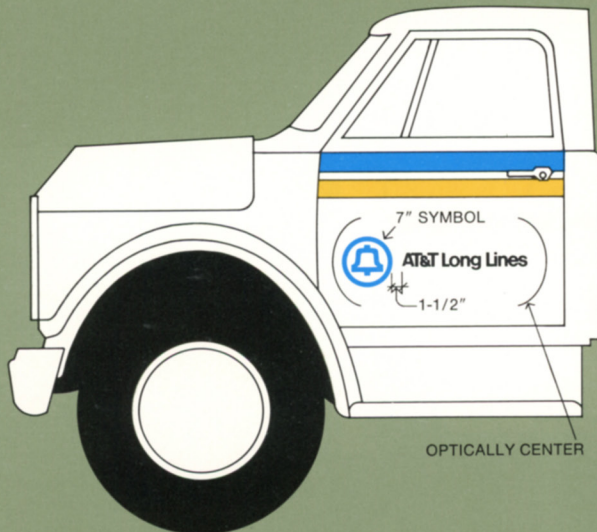

There are two kinds of door configurations which are exceptions to the specifications described on the preceding page.

Drawing A shows a typical door shape which prevents the placing of the symbol to the left of the logotype in the sizes required. In these cases, the symbol falls beneath the logotype, flush left. The space between the symbol and logotype remains constant for all companies. Be sure to align the logotype with the symbol circle as described on page 6.

Drawing B shows a typical body molding which makes the application of stripes impractical. The stripes may be deleted in such cases, and the symbol/logotype unit optically centered on the door.

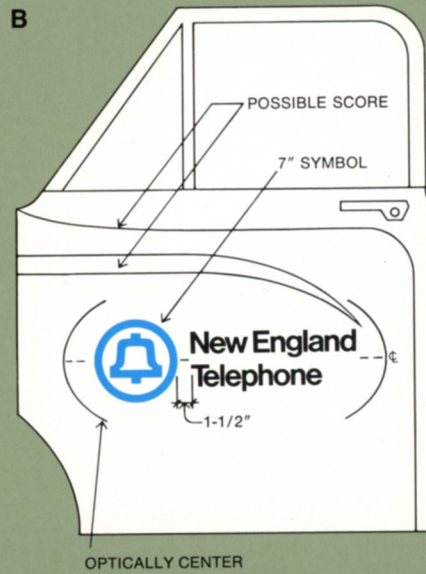
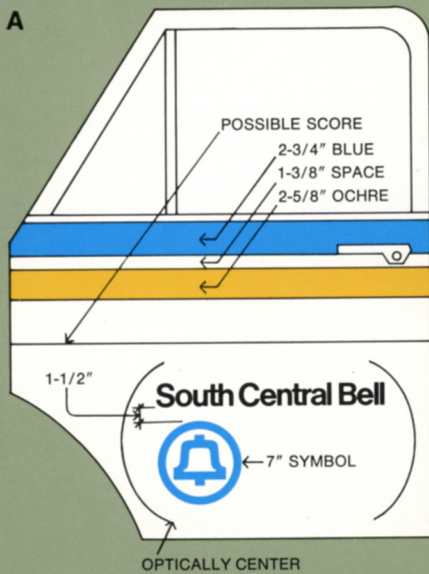

Tilt Cabs

Below is a typical tilt cab. Due to the door shape in this type of vehicle, the symbol must appear below the logotype. Symbol and logotype sizes are the same as those specified for conventional cabs (page 41). The space between the symbol and logotype is identical for all companies.

Note that on right-side doors (Drawings B and D), the symbol is aligned with the *right* end of the logotype. For companies with one-line logotypes (Drawing B), the right end of the logotype is simply aligned with the outside edge of the symbol circle.

For companies with multiple-line logotypes, the lines must be cut apart and re-aligned flush right (Drawing D). Care must be taken to maintain the space between the lines exactly as it is on the application tape.

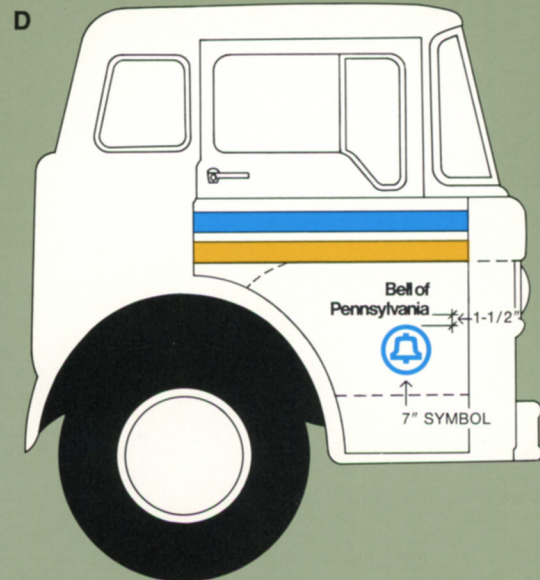
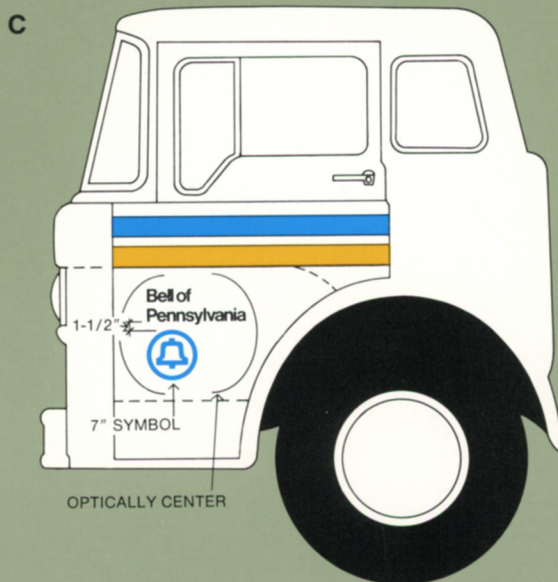
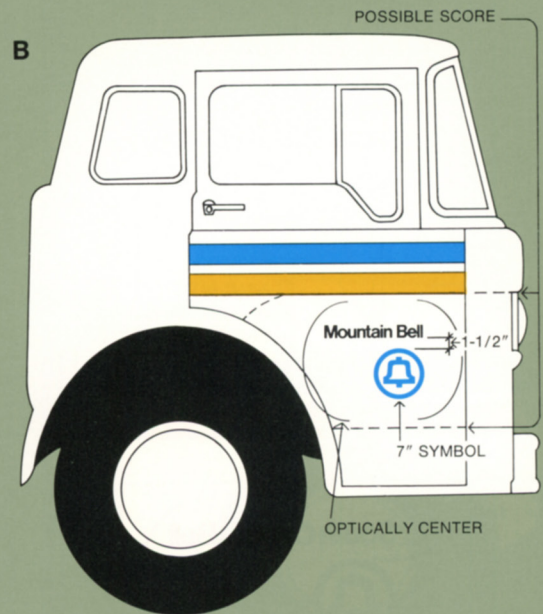
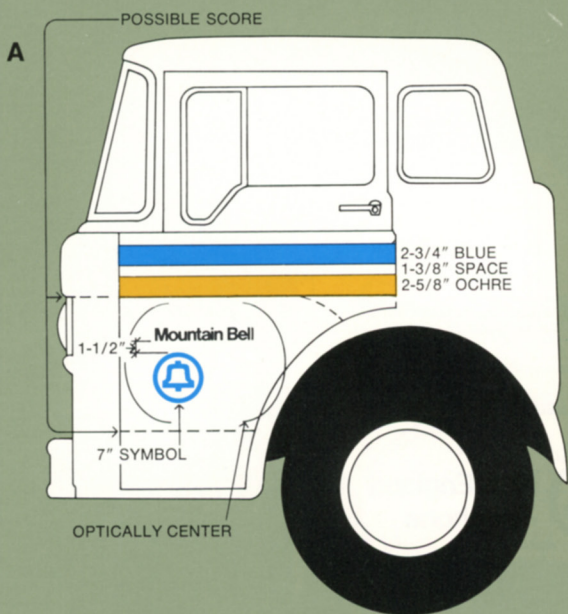

Trailers

All companies use 34" symbols and logotypes with 7³/₄" cap heights on trailer sides. When the trailer is shorter than 1¹/₂ times its height (Drawing B), the logo-type should be eliminated and the symbol only used. In these instances, place the symbol on the rear third of the trailer side, as illustrated. This is true regardless of surface type of the trailer.

Where the surface of the trailer permits, stripes may be pressure-sensitive material in the dimensions given.

However, in cases where heavy ribbing, fluting or numerous rivets interrupt the surface, stripes may be painted to the dimensions given, using the blue and ochre paints described on page 4.

Supply Vans (Drawing C), are treated in the same manner as trailers, following the guidelines stated above. Specifications for supply van cabs are on page 52.

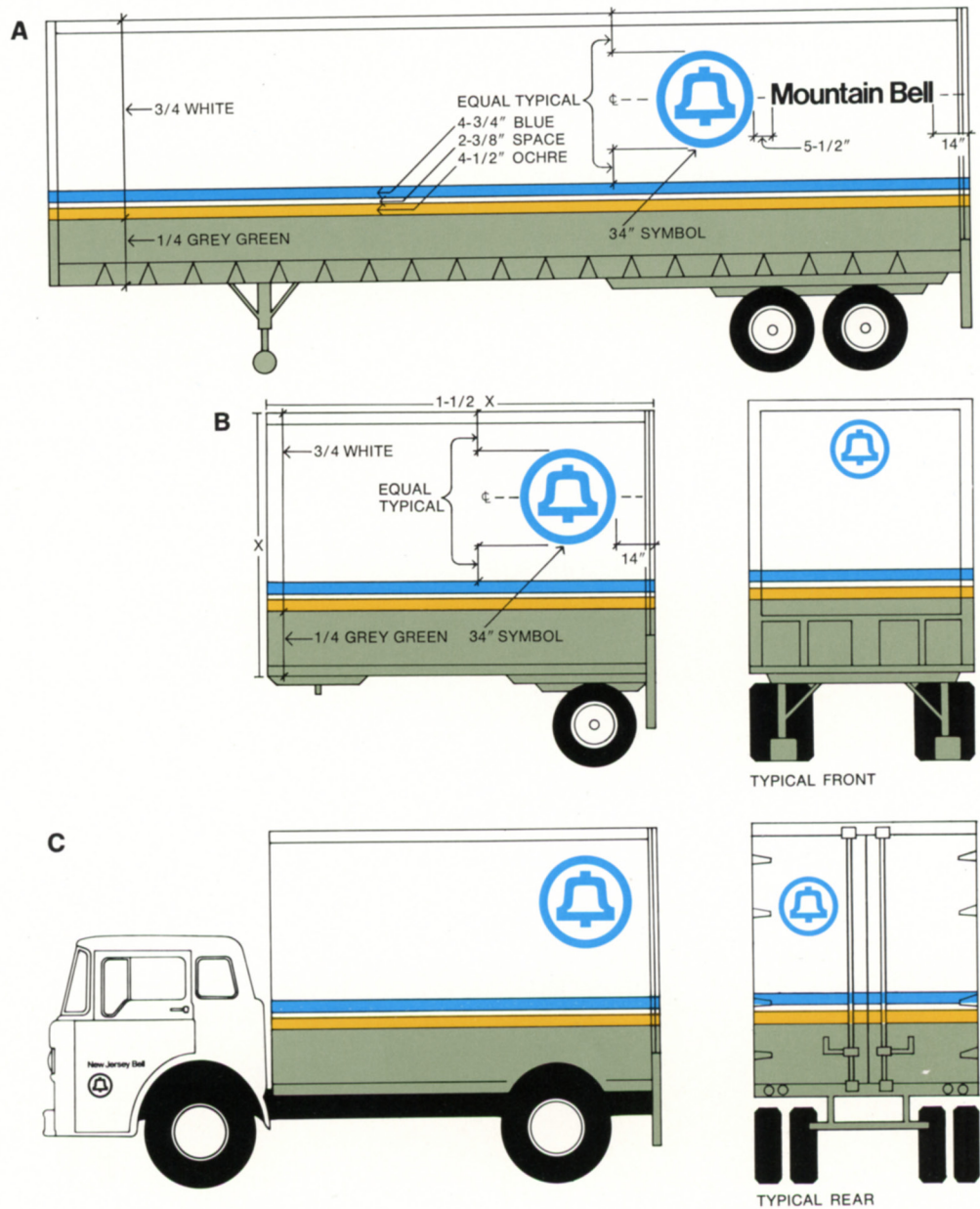

While trailers with flat surfaces, or trailers which have been previously painted, are painted white and grey-green as specified on the previous page, aluminum sided trailers may be left unpainted as shown below; most finishes of this type require less maintenance than painted surfaces. Where practical, stripes of pressure-sensitive material may be used. Or, stripes may be painted, using the blue and ochre paints specified on page 4.

Drawings A and B show typical ribbed and fluted surfaces. These convolutions make the direct application of symbols and logotypes impractical. In these instances, panels must be made to accommodate the symbols and logotypes. *The panels must be flat, and of a material matching the surface to which they are*

applied. There should never be less than 5" of space between a symbol or logotype and the edge of the panel. Painted trailers with ribs, etc., receive white panels. Unpainted trailers with ribs, etc., receive panels of a matching unpainted material.

Drawings C and E show the manner of applying 21½" symbols to trailer fronts, or rears with single doors. Panels where necessary, are of material matching the trailer surface, as described above.

Drawings D and F show the manner of applying 21½" symbols to trailer rears.

Hydraulic lift gates, where present, should be painted Bell Grey-green, with no stripes.

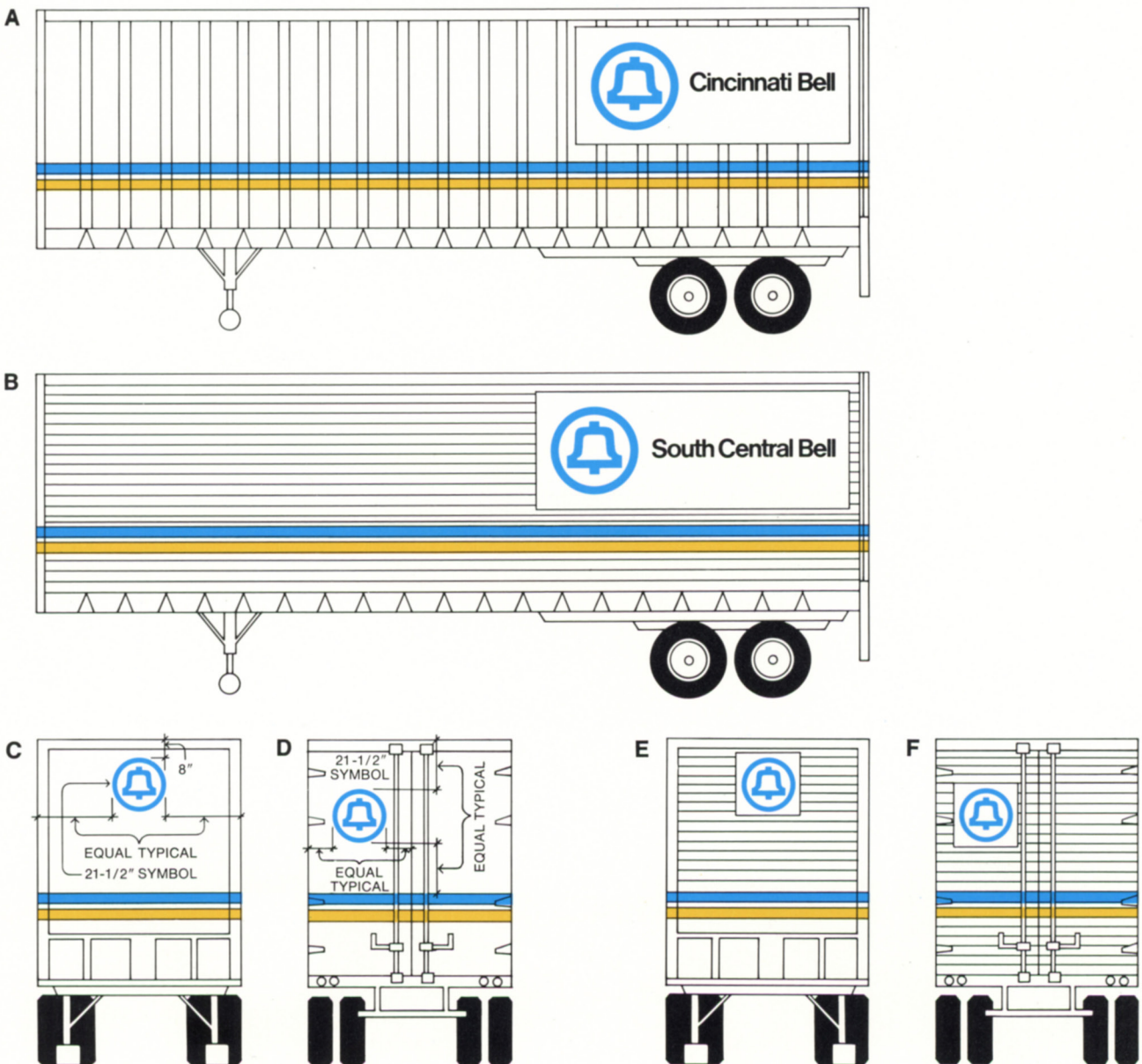

Semi – tractors

There are no stripes on semi-tractors, or on cabs to which supply van bodies are affixed. Since a single semi-tractor may pull several different trailers, stripes have been eliminated to avoid conflicting with the larger stripes which appear on different trailers.

The cabs are painted Bell White. Steps and step tanks are painted chassis black.

All symbol/logotype units are optically centered on the door surface. The dimensions between the symbol and the logotype is the same for all companies and for all door configurations.

Shown below are the three basic semi-tractor styles.

However, for the purpose of applying symbol/logotype units, we are concerned only with door configurations. The principles shown below are applicable to more than one vehicle. For instance, a particular conventional semi-tractor may have a door configuration which would prevent the application of the symbol/logotype unit as shown in Drawing B. In such a case, the application shown in either Drawing A or Drawing C may be substituted.

For the proper handling of right side doors with the symbol/logotype unit shown in Drawing A, refer to page 48, paragraph 2.

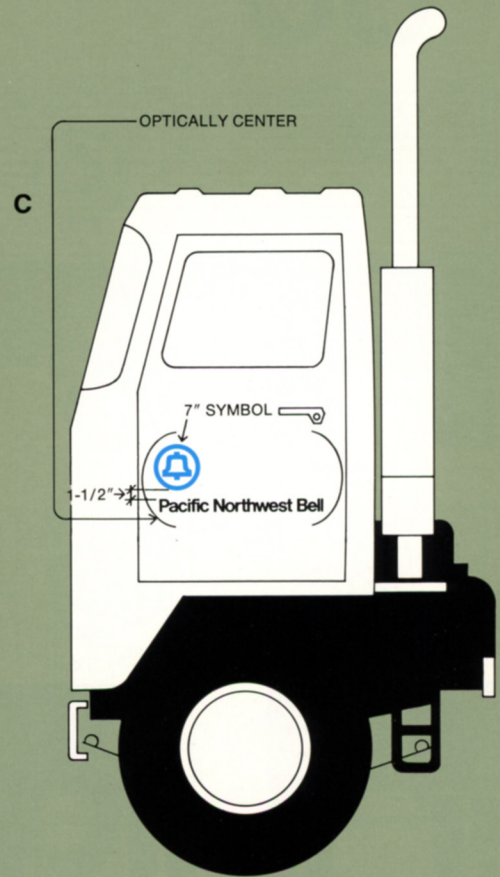
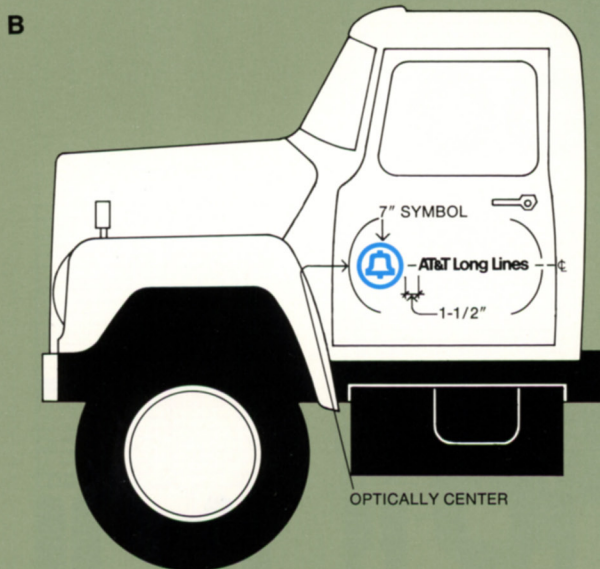
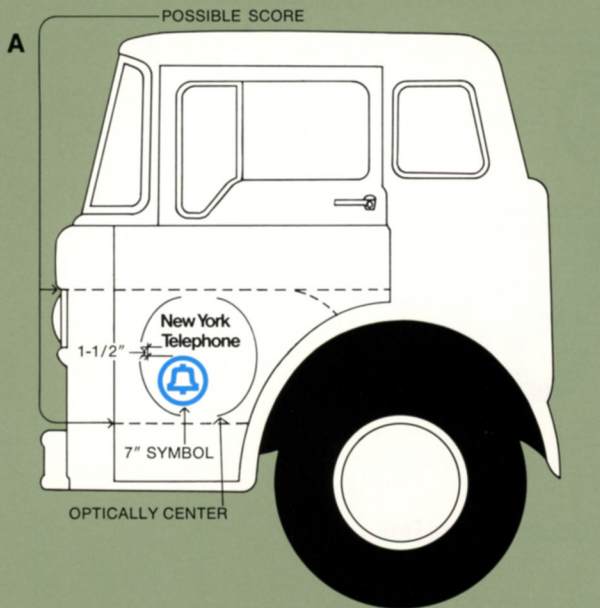

Blazer / Bronco / Jeep / Scout

Color: Bell White.

A—Typical vehicle, front

Stripes are located along the longitudinal centerline of the hood, wrapped under both leading and trailing edges.

B—Typical vehicle, side

All symbol/logotype units are optically centered on the door. The dimension given for the distance between the symbol and logotype is the same for all companies. All logotypes are centered horizontally on the symbol, using the horizontal center lines provided on application tapes.

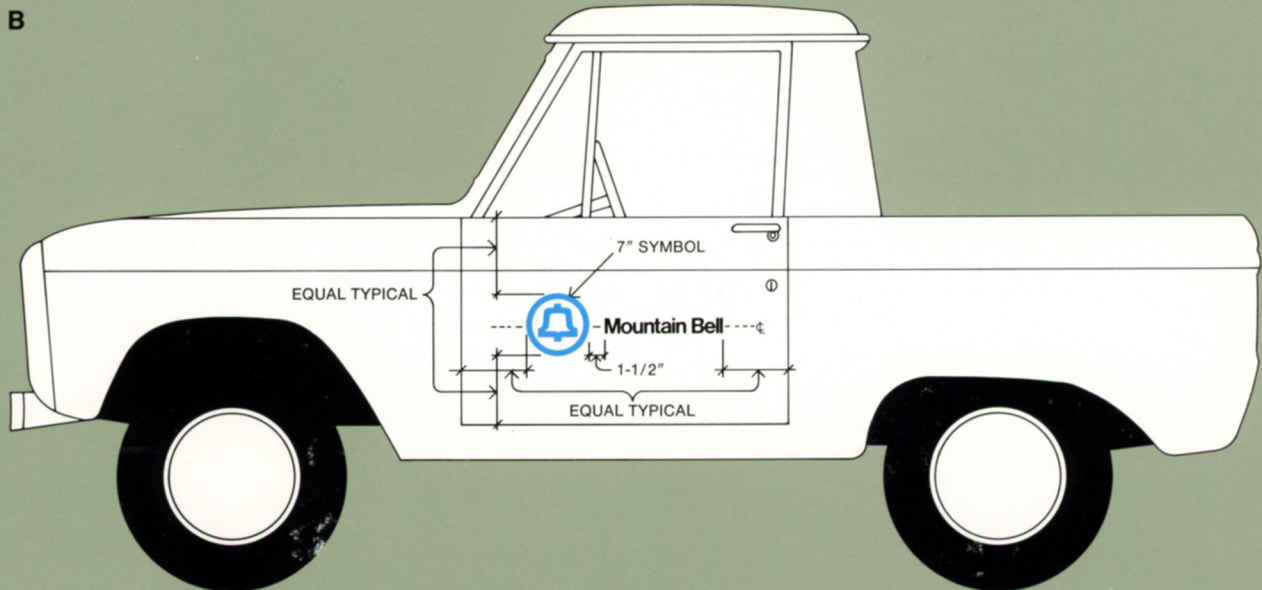
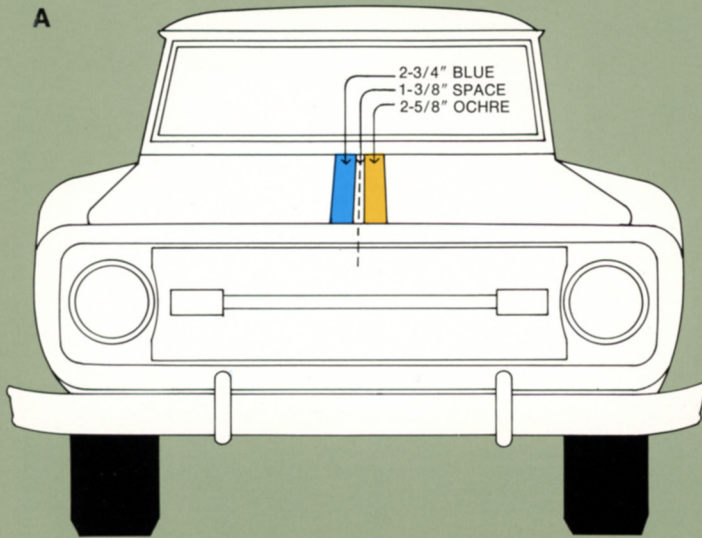

Walk-in Vans

A—Typical vehicle, left side

Stripes are applied from the rear of a door opening around the rear of the vehicle.

All symbols are 15½". All logotypes are centered horizontally on the symbol, using the horizontal centerlines provided on application tapes.

The length of the logotype varies from company to company. However, the dimensions given from logotype to the bell symbol, and from the logotype to the rear of the vehicle *do not change*, regardless of the length of your company's logotype.

B—Typical vehicle, rear

The size and location of the bell symbol is the same for all companies. The dimensions given from the door seam to the logotype is the same for all companies. All logotypes are centered horizontally on the symbol, using the horizontal centerlines provided on application tapes.

For the appropriate size and line configuration of your company's logotypes for this vehicle type, refer to the chart on page 59.

Note: When windows occur in lower rear door panels, a 10" symbol *only* should be placed on the left rear body panel beneath the stripes, optically centered in the area.

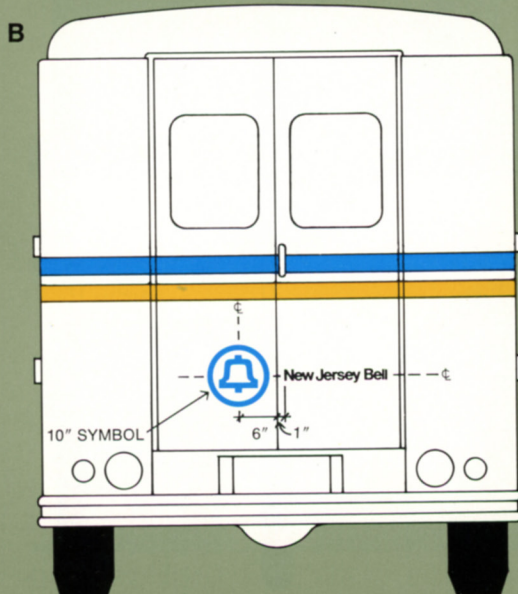
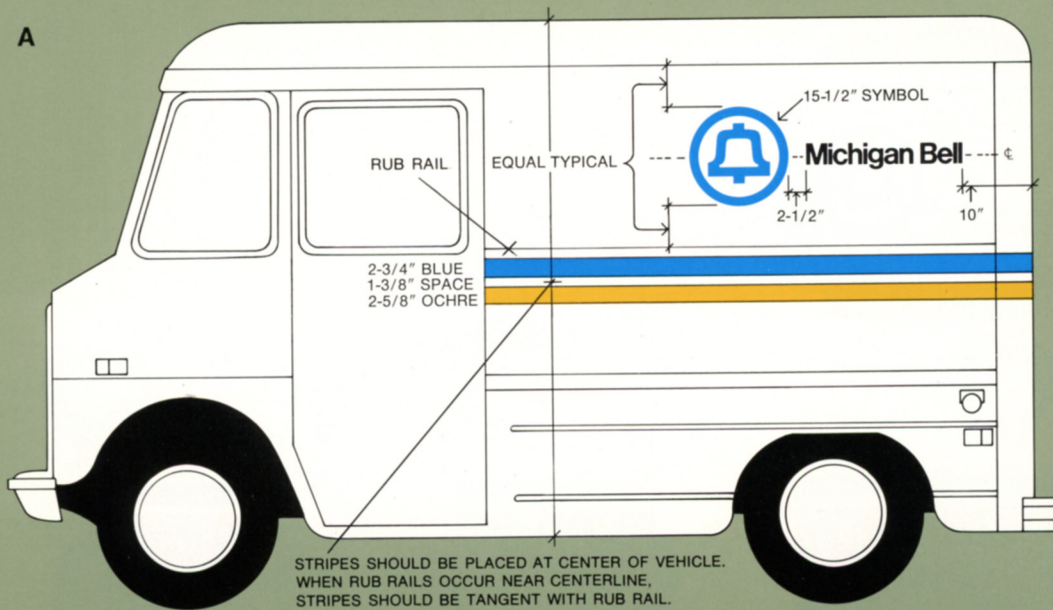

Splicer Carts

Because they are frequently used in high traffic areas, splicer carts are an important "vehicle."

A—Top

The bottom of the bell symbol faces the hinged side of the lid so that the symbol will be upright when the lid is open.

B—Left side

For carts with visible hinges, the blue stripe aligns with the bottom edge of the hinge when the lid is closed.

Note: The dotted line through the ochre stripe indicates the juncture of white and grey-green paints. It is important that this paint juncture occur well within

the ochre stripe. Do not attempt to align the stripes along the paint juncture.

The symbol is placed as indicated for all companies.

C—Front with one-line logotype

D—Front with two-line logotype

The dimension from the symbol to the logotype is identical for all companies. The logotype is centered in the available space, with the symbol flush left beneath it.

E—Right side

F—Rear

Stripes do not appear on this surface.

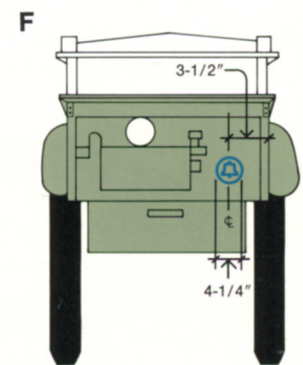
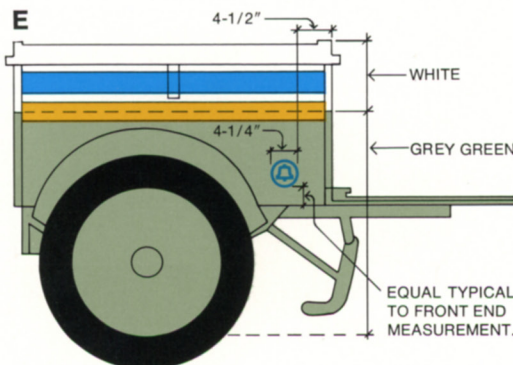
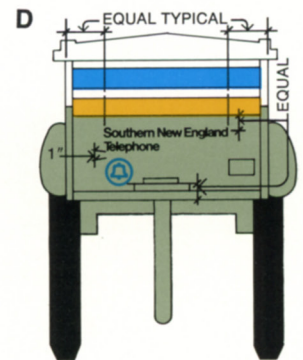
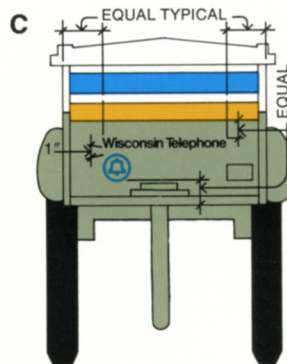
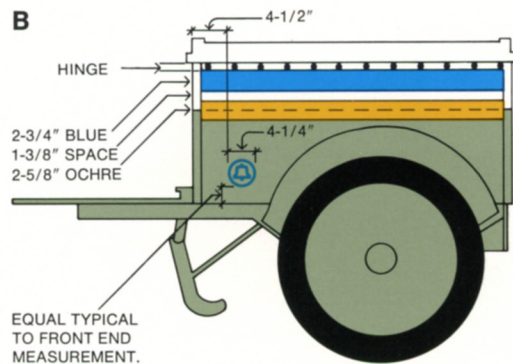
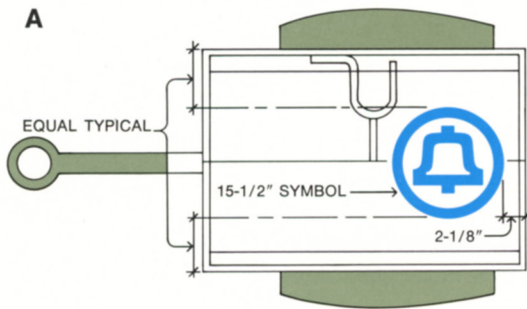

Miscellaneous Special Equipment

There are many vehicles, less generally used than those described in the preceding pages, whose quantity and variety makes it impractical to specify them individually. Therefore, the following general specifications are recommended.

Self-propelled vehicles, such as scooters and forklifts (Drawings A and B) should be painted Bell White. Where sufficient space is available without crowding (Drawing A is typical), symbol/logotype units should be applied, using the stock sizes available. Where space does not permit, the symbol alone may be used (Drawing B).

Towed vehicles not previously specified should be painted Bell Grey-green. As described above, symbols should be used when space is limited. (Drawing C.)

In some instances, such as pole trailers, cable reel trailers and flat-bed trailers (Drawing D), the application of any identification is impractical. Do not apply symbols or logotypes in instances where they will accomplish little or nothing in the way of identification.

Note: Vehicles used exclusively in snow are not required to be painted the new colors. Companies using vehicles of this type should continue to order them in colors which offer high contrast to snow.

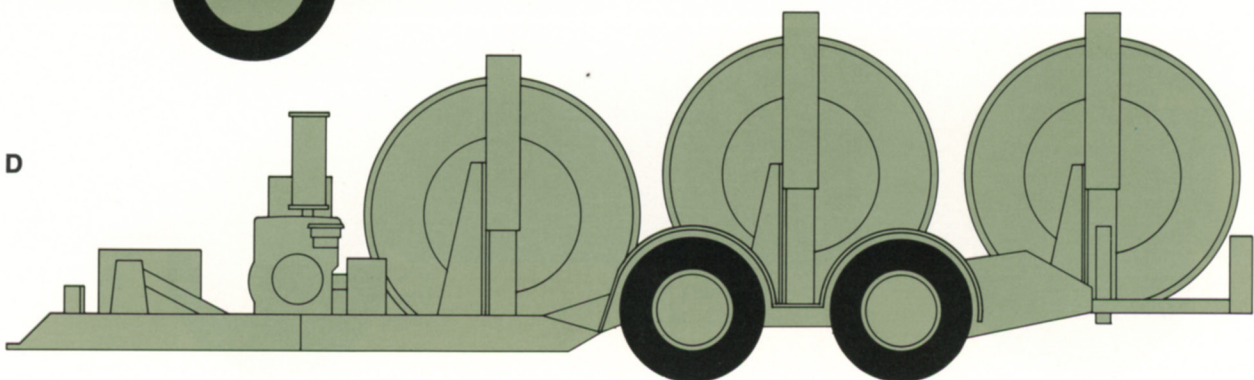
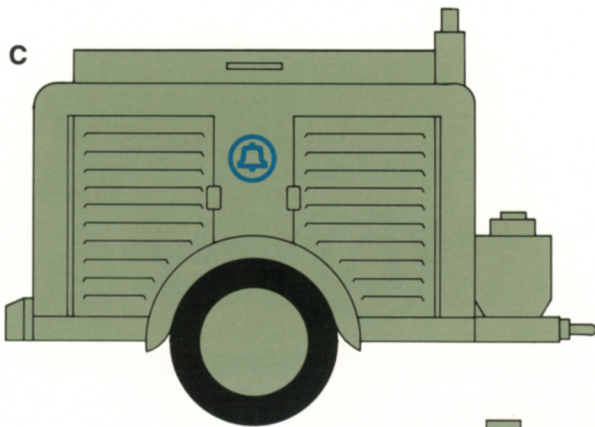
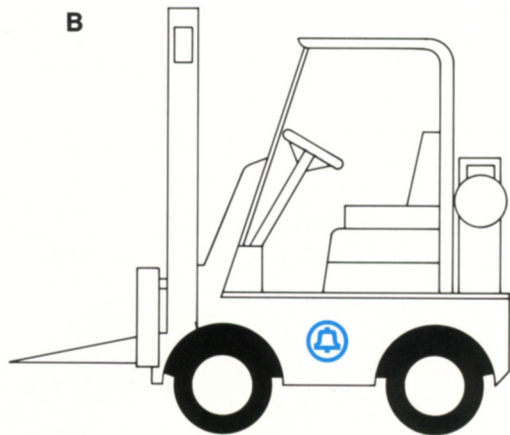
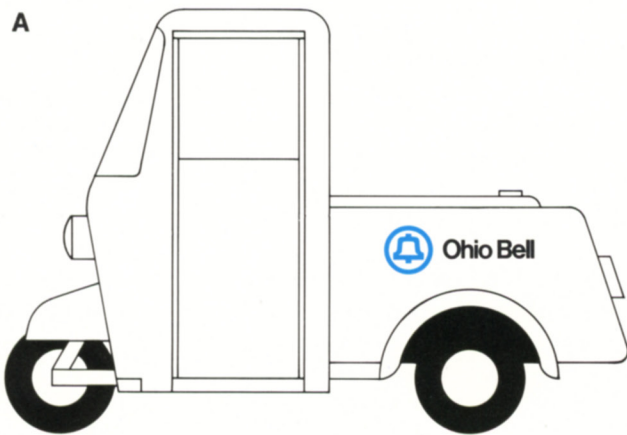

Legal Load and Weight Numbers

Many states require that certain vehicles carry information regarding maximum load, gross weight, place of garaging, etc. While actual specifications vary from state to state, this information is required to be in lettering up to 3 inches in height. For this purpose, pressure-sensitive black letters and numbers are available in 2 and 3 inch sizes, in the typeface Univers 59 as shown below.

While this information must be displayed legibly, it is important that it be placed in a position so as not to detract from the company identification. The information must be grouped compactly and in a rectangular form. Examples A and B below demonstrate good placement of required information.

Some Bell System companies award safe driving citations and other achievement badges. These also

should be placed on vehicles so that they do not detract from nor interfere with identification.

Posters and other advertising

Many system companies have been using advertising posters on their vehicles. With the introduction of our new corporate graphics, this policy has been changed.

The new Bell System vehicles are a bright, two-tone design with strong identification for the System company. So, it is important that these graphics are not obscured, cluttered or complicated by advertising posters that are a secondary form of communication.

Therefore, *no advertising of any kind* may appear on Bell System vehicles. This also applies to Yellow Pages decals and posters.

A



B



Company Logotype Sizes

	AT&T Long Lines	Bell Laboratories	Bell of Pennsylvania	Cincinnati Bell	C&P Telephone	Diamond State Telephone	Illinois Bell	Indiana Bell	Michigan Bell	Mountain Bell	Nevada Bell	New England Telephone	New Jersey Bell	New York Telephone	Northwestern Bell	Ohio Bell	Pacific Northwest Bell	Pacific Telephone	South Central Bell	Southern Bell	Southern New England Telephone	Southwestern Bell	Western Electric	Wisconsin Telephone
Van Trucks																								
Ford																								
Left Side Enclosed	A 1	A 1	A 1	A 1	A 1	A 2	A 1	A 1	A 1	A 1	A 1	A 2	A 1	A 1	A 1	A 1	A 1	A 1	A 1	A 1	A 2	A 1	A 1	A 1
Left Side w/Windows	D 1	E 1	D 2	D 1	E 1	D 2	B 1	B 1	B 1	D 1	C 1	D 2	D 1	D 2	E 1	C 1	E 3	D 2	E 1	D 1	E 3	E 1	E 1	D 2
Right Side	D 1	E 1	D 2	D 1	E 1	D 2	B 1	B 1	B 1	D 1	C 1	D 2	D 1	D 2	E 1	C 1	E 3	D 2	E 1	D 1	E 3	E 1	E 1	D 2
Rear	D 1	E 1	D 2	D 1	E 1	D 2	B 1	B 1	B 1	E 1	C 1	D 2	D 1	D 2	E 1	C 1	F 3	D 2	E 1	D 1	F 3	E 1	E 1	D 2
Chevrolet & GMC																								
Left Side Enclosed	A 1	A 1	A 1	A 1	A 1	A 2	A 1	A 1	A 1	A 1	A 1	A 2	A 1	A 1	A 1	A 1	A 1	A 1	A 1	A 1	A 2	A 1	A 1	A 1
Left Side w/Windows	D 1	E 1	D 2	D 1	E 1	D 2	B 1	B 1	B 1	D 1	D 1	D 2	D 1	D 2	E 1	C 1	E 3	D 2	E 1	D 1	E 3	E 1	E 1	D 2
Right Side	D 1	E 1	D 2	D 1	E 1	D 2	B 1	B 1	B 1	D 1	D 1	D 2	D 1	D 2	E 1	C 1	E 3	D 2	E 1	D 1	E 3	E 1	E 1	D 2
Rear	E 1	E 1	E 2	D 1	E 1	E 2	E 1	E 1	E 1	E 1	E 1	E 2	E 1	E 2	E 1	E 1	F 3	E 2	E 1	E 1	F 3	E 1	E 1	E 2
Dodge																								
Left Side Enclosed	A 1	A 1	A 1	A 1	A 1	A 2	A 1	A 1	A 1	A 1	A 1	A 2	A 1	A 1	A 1	A 1	A 1	A 1	A 1	A 1	A 2	A 1	A 1	A 1
Left Side w/Windows	D 1	E 1	D 2	D 1	E 1	D 2	B 1	B 1	B 1	D 1	C 1	D 2	D 1	D 2	E 1	C 1	E 3	D 2	E 1	D 1	E 3	E 1	E 1	D 2
Right Side	D 1	E 1	D 2	D 1	E 1	D 2	B 1	B 1	B 1	D 1	C 1	D 2	D 1	D 2	E 1	C 1	E 3	D 2	E 1	D 1	E 3	E 1	E 1	D 2
Rear	D 1	E 1	D 2	D 1	E 1	E 2	B 1	B 1	B 1	D 1	C 1	D 2	D 1	D 2	E 1	C 1	E 3	D 1	E 1	D 1	E 3	E 1	E 1	D 2
Rear 71 Model	G 1	G 1	G 1	G 1	G 1	H 2	G 1	G 1	G 1	G 1	G 1	H 2	G 1	G 1	G 1	G 1	G 1	G 1	G 1	G 1	H 2	G 1	G 1	G 1
Sedans & Station Wagons																								
Left & Right Sides	G 1	G 1	G 1	G 1	G 1	H 2	G 1	G 1	G 1	G 1	G 1	H 2	G 1	G 1	G 1	G 1	G 1	G 1	G 1	G 1	H 2	G 1	G 1	G 1
Chevrolet Carryall																								
Left Side Right Side & Rear	E 1	E 1	E 2	E 1	E 1	E 2	E 1	E 1	E 1	E 1	E 1	E 2	B 1	E 2	E 1	C 1	E 1	E 1	E 1	E 1	F 2	E 1	E 1	E 2
Conventional Cabs, Tilt Cabs, Short & Heavy Duty Cabs																								
Left & Right Sides	E 1	E 1	E 2	E 1	E 1	E 2	E 1	E 1	E 1	E 1	E 1	E 2	B 1	E 2	E 1	C 1	E 1	E 1	E 1	E 1	F 2	E 1	E 1	E 2
Semi Tractor Cabs																								
Left & Right Sides	E 1	E 1	E 2	E 1	E 1	E 2	E 1	E 1	E 1	E 1	E 1	E 2	B 1	E 2	E 1	C 1	E 1	E 1	E 1	E 1	F 2	E 1	E 1	E 2
Trailers & Supply Vans																								
Left & Right Sides	J 1	J 1	J 1	J 1	J 1	J 2	J 1	J 1	J 1	J 1	J 1	J 2	J 1	J 1	J 1	J 1	J 1	J 1	J 1	J 1	J 2	J 1	J 1	J 1
Bronco/Blazer/Scout																								
Left & Right Sides	E 1	E 1	E 2	E 1	E 1	E 2	E 1	E 1	E 1	E 1	E 1	E 2	B 1	E 2	E 1	C 1	E 1	E 1	E 1	E 1	F 2	E 1	E 1	E 2
Walk in Vans																								
Left & Right Sides	A 1	A 1	A 1	A 1	A 1	A 2	A 1	A 1	A 1	A 1	A 1	A 2	A 1	A 1	A 1	A 1	A 1	A 1	A 1	A 1	A 2	A 1	A 1	A 1
Rear	G 1	G 1	E 2	G 1	G 1	H 2	G 1	G 1	G 1	G 1	G 1	H 2	G 1	G 1	G 1	G 1	E 3	G 1	G 1	G 1	E 3	G 1	G 1	G 1
Splicer Cart																								
Front	G 1	G 1	G 1	G 1	G 1	H 2	G 1	G 1	G 1	G 1	G 1	H 2	G 1	G 1	G 1	G 1	G 1	G 1	G 1	G 1	H 2	G 1	G 1	G 1

Logotype Letter Code:

A - 3 1/4" Cap Height
 B - 2 7/8" Cap Height
 C - 2 3/4" Cap Height

D - 2 3/8" Cap Height
 E - 2" Cap Height
 F - 1 3/4" Cap Height

G - 1 5/8" Cap Height
 H - 1 3/8" Cap Height
 J - 7/4" Cap Height

Note: In the chart, the figure following the Logotype Letter Code refers to the number of lines in which your company's logotype is arranged for the vehicle indicated.

Most vehicles now coming from the manufacturers are pre-marked at the factory. However, many older models will be repainted and marked by System companies. We trust that this manual will facilitate that big and very important job.

While the vehicle drawings used as demonstrations in this manual should be adequate for most remarking and repainting situations, drawings in larger scale are available should the need arise. In the case of vans, drawings of each manufacturer's model with your company's markings can be obtained from: Plant Operations Manager — Motor Vehicles, AT&T.



